



# Tsunami MP.11 Antenna Installation Guide Version 2.5



## **Copyright**

© 2003, 2004, 2005 Proxim Wireless Corporation, San Jose, CA. All rights reserved. Covered by one or more of the following U.S. patents: 5,231,634; 5,875,179; 6,006,090; 5,809,060; 6,075,812; 5,077,753. This manual and the software described herein are copyrighted with all rights reserved. No part of this publication may be reproduced, transmitted, transcribed, stored in a retrieval system, or translated into any language in any form by any means without the written permission of Proxim Wireless Corporation.

## **Trademarks**

Tsunami, Proxim, and the Proxim logo are trademarks of Proxim Wireless Corporation. All other trademarks mentioned herein are the property of their respective owners.

# Contents

<b>ABOUT THIS BOOK .....</b>	<b>4</b>
Who Should Use This Guide .....	4
Finding Additional Information.....	5
About the Tsunami MP.11 Product Family.....	6
Safety Precautions .....	7
<b>CHAPTER 1. PREPARING FOR INSTALLATION.....</b>	<b>8</b>
Installation Process Overview .....	8
Site Prerequisites .....	9
Indoor Link Installation .....	9
Tsunami MP.11a Model 5054 Hardware .....	9
Model 5054 Cable Setup for an Outdoor Antenna .....	10
Model 2454-R and Model 5054-R Hardware.....	11
Models 2454-R and 5054-R Cable Setup for the Outdoor Antenna.....	11
Outdoor Hardware Placement .....	12
Cable System.....	13
Surge Arrestor Placement .....	13
Antenna Cable Route .....	13
Outdoor Link Installation.....	14
Placing the Antenna.....	14
Mounting the Antenna.....	17
Connecting the Antenna Cable.....	18
Sealing the Cable Connectors .....	18
Grounding the Antenna.....	19
Aligning the Antenna.....	19
Before Climbing the Roof.....	22
<b>CHAPTER 2. DETERMINING RANGE AND CLEARANCE.....</b>	<b>23</b>
Determining the Outdoor Range .....	23
Maximum Range.....	24
Clearance Factor .....	24
Distance Assumptions and Expectations .....	26
Model 5054 .....	26
Model 5054-R .....	27
Model 2454-R .....	27
Calculations .....	28
Calculating Received Signal Level and Link Budget .....	28
<b>CHAPTER 3. ANTENNA CABLING SYSTEM .....</b>	<b>32</b>
Introduction.....	32
Cable Components.....	32
Selecting the Correct Connector Type.....	33
Surge Arrestor .....	34
Installation.....	<b>Error! Bookmark not defined.</b>
<b>SUPPORT AND WARRANTY.....</b>	<b>36</b>
Warranty and Repair .....	37

---

## About This Book

This *Antenna Installation Guide* explains how to install and set up an outdoor antenna with the 5054, 5054-R, and 2454-R hardware. This guide does not explain how to erect antenna masts, nor how to install a safety grounding system. These prerequisites must be in place before installing the directional antenna.

See *Tsunami MP.11 Recommended 5 GHz and 2.4 GHz Antennas* for a list of and specifications for antennas you can use with the 5054, 5054-R, and 2454-R.

## WHO SHOULD USE THIS GUIDE

The installation of outdoor wireless links requires technical expertise. At the very least, you should be able to:

- Install and configure the network components, such as the radio hardware.
- Understand, or have a working knowledge of, installation procedures for network operating systems using Microsoft Windows.
- Mount the outdoor antenna and surge arrestor. Antenna installation must be provided by professional installers.

---

### **WARNING!**

*The outdoor antennas to be used with these products are intended for mounting on an antenna tower, on a roof, or on the side of a building. Installation is not to be attempted by someone not trained or experienced in this type of work. The antenna must be installed by a suitably trained professional installation technician or by a qualified antenna installation service. The site prerequisites must be checked by a person familiar with the national electrical code and with other regulations governing this type of installation.*

---

As radio regulations differ between the various worldwide countries, it may be that not all of the outdoor solutions described in this manual are allowed in the country in which you plan to install this equipment.

Local radio regulations or legislation may impose restrictions on the use of specific combinations of:

- Low-loss antenna cables and outdoor antennas
- Radio channels selected at the radios that are connected to specific outdoor antennas

---

**Note:** A basic rule for selecting a combination of cables and antennas is that no combination is allowed unless explicitly approved in this *Antenna Installation Guide*. Therefore, always use *Tsunami MP.11 Recommended Antennas* in combination with “Chapter 2. Determining Range and Clearance” to select the correct type of antenna equipment and to inform your antenna installer and LAN administrator about the impact of regulatory constraints on their job or activities.

---

---

**CAUTION** *At all times, it is the customer’s responsibility to ensure that an outdoor antenna installation complies with local radio regulations.<sup>1</sup> The customer must verify that:*

- *The antenna installer is aware of these regulations*
- *The correct cable type and surge arrestor have been used, according to the instructions described in this document*

***Proxim Wireless Corporation and its resellers or distributors are not liable for any damage or violation of government regulations that may arise from failing to comply with these guidelines.***

---

---

<sup>1</sup>In case you are not certain about the regulations that apply in your country, consult your local Proxim Wireless Corporation Sales Office.

## FINDING ADDITIONAL INFORMATION

### Installing Hardware

Antennas typically are used in combination with Tsunami MP.11 systems. The hardware installation of these devices is described in the Installation and Management manual included with each product.

### Configuration and Management

Configuration and management of outdoor wireless links is accomplished with management tools that come with the systems. Some examples of management tools are:

- Web-based (HTTP) management
- Telnet
- Wireless network manager

### Hardware Specifications

Hardware and radio frequency specifications for the unit are described in the documentation that comes with the product. Hardware specifications for the outdoor antennas, the cabling system, and the surge arrester are listed in *Tsunami MP.11 Recommended 5 GHz and 2.4 GHz Antennas*

### Additional Files on Your Software CD

All software CDs that come with your Proxim products include a **Release Notes** file in the **Doc** subdirectory. This file contains information about the software version and drivers. You are advised to print and read the **Release Notes** file prior to installing your Proxim products, as it may contain information that was not available when this document was printed.

### Other Sources of Information

You can download all Tsunami MP.11 documentation from the Proxim Support website:

<http://support.proxim.com> . Visit the website regularly for the latest available information, documentation, software updates, and other Proxim news.

## ABOUT THE TSUNAMI MP.11 PRODUCT FAMILY

The Tsunami MP.11 models let you set up a wireless system based upon two basic topologies:

- A point-to-point link, which lets you set up a connection between two locations as an alternative to:
  - Leased lines in building-to-building connections
  - Wired Ethernet backbones between wireless access points in difficult-to-wire environments

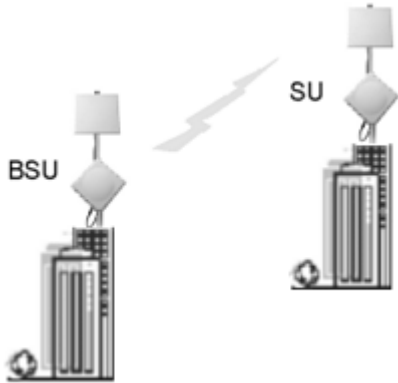

- A single point-to-multipoint network, which lets you connect more than two buildings. You can set up a single point-to-multipoint network with a single Base Station Unit and multiple Subscriber Units.

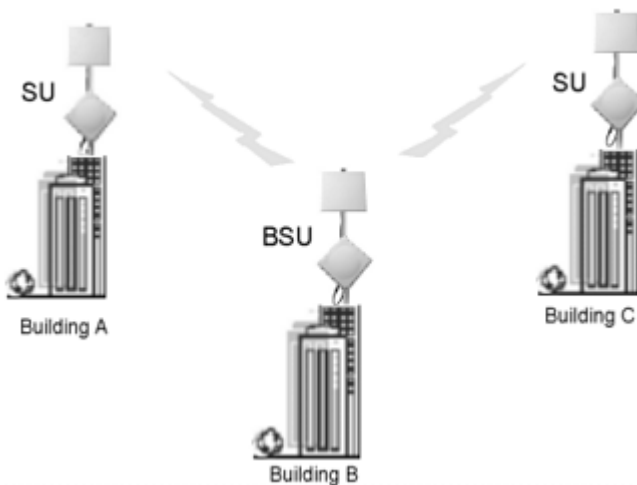

A link between two locations always consists of a Base Station Unit (BSU) and a Subscriber Unit (SU). A BSU can, depending upon its configuration, connect to one or more SUs; an SU, however, can connect to only one BSU.

---

**Note:** Depending upon local radio regulations and legislation, the outdoor antenna solutions described in this document may not be available in all parts of the world.

---

## SAFETY PRECAUTIONS

Read this section carefully before beginning the installation. All of the following requirements should be satisfied prior to starting installation of your outdoor antennas.

---

### **DANGER!**

*The outdoor antennas to be used with this product are intended for mounting on a roof or on the side of a building. Any person not trained or experienced in this type of work should not attempt this installation. A suitably trained professional installation technician must install the antenna. The site prerequisites must be checked by a person familiar with the National Electrical Code, and with other regulations governing this type of installation.*

*Outdoor antennas and antenna cables are electrical conductors. Transients or electrostatic discharges that may occur at the antenna (such as a lightning strike during thunderstorms) may damage your electronic equipment and cause personal injury or death to persons touching the exposed metal connectors of the antenna cable.*

*When installing, disconnecting or replacing one of the cabling components, you must ensure at all times that each exposed metal connectors of the antenna cabling system are grounded locally during the work.*

*Do not install this antenna where there is any possibility of contact with high-voltage arc-over from power cables or service drops to buildings. The antenna, supporting mast, or tower must not be close to any power lines during installation or removal, or in the event part of the system should accidentally fail. Apply a **Danger** label to a plainly visible area of the antenna support structure.*

*Do not climb rooftops in wet or windy conditions, during a thunderstorm, or when the area at which the equipment is to be installed is covered with ice or snow.*

*Do not touch antennas, surge arrestors, or antenna cables during a thunderstorm.*

*The antenna installation location must be at a safe distance from power lines or telephone lines. The safe distance should be at least twice the height of the antenna mast plus the height of the antenna.*

*Antennas shall be mounted in such a manner as to minimize the potential for human contact during normal operation. To avoid the possibility of exceeding the FCC radio frequency exposure limits, human proximity to the antenna shall not be less than 20 cm (8 inches) during normal operation.*

*The low-loss antenna cable that is to connect the antenna with the surge arrestor, or with the Ethernet cable that is to connect to the surge arrestor, must be at least 1 m (3 ft) away from any high voltage or high current cable.*

*Check whether the antenna mast and its guy wires or wall bracket are positioned correctly and secured properly to the roof or walls.*

*Check whether the grounding system for the antenna mast, the MP.11a and 5054-R hardware, and the surge arrestor have been installed. The grounding system must comply with the requirements as described in "Grounding the Antenna."*

*Always consult a qualified electrician if you are in doubt as to whether the antenna mast, the surge arrestor, and the hardware are properly grounded.*

*The antenna cable between the antenna and the surge arrestor must be grounded at all times. If the cable is disconnected at one end for some reason (for example, to replace the surge arrestor), you must ensure that the exposed metal connector of the cable is grounded locally during the work.*

---

---

## Chapter 1. Preparing for Installation

Plan the day for your outdoor antenna installation carefully. Do not install the antenna in wet or windy conditions, during a thunderstorm, or when the area in which the equipment is to be installed is covered with ice or snow.

The grounding system for the antenna mast, radio hardware, and surge arrestor should be installed before the cable from the antenna is connected to the surge arrestor. This protects your system against lightning strikes during installation.

Familiarize yourself with the antenna and the antenna-specific mounting instructions prior to climbing any roof or ladder. By installing and testing all equipment before beginning the actual rooftop installation, you can determine whether all required equipment and items are available and functioning properly.

To verify the equipment prior to installation, you may first need to follow the guidelines as described in the documentation that comes with the radio unit.

### INSTALLATION PROCESS OVERVIEW

The installation process can be summarized in the following steps:

1. Verify that the support structure for the antenna has been connected to the grounding system. If this is not the case, you should do so now.
2. Connect the exposed metal connectors of the low-loss antenna cable to the grounding system.
3. Mount the antenna to the support structure, following the guidelines as described for your antenna.

When mounting multiple antennas on a single mast, use the following methods to minimize the influence of cross-talk interference between the antennas:

- Place your antennas as far apart as possible.
- Alternate the mounting of directional antennas for vertical and horizontal polarization.

Consult the mounting instructions for your antenna as described in *Tsunami MP.11 Recommended Antennas* for options and instructions for mounting the antennas for different polarization.

4. Connect the antenna cable to the antenna.
5. Route the antenna cable to the surge arrestor that has been installed near the ingress point.
6. Connect the antenna / Ethernet cable to the surge arrestor.
7. Attach the surge arrestor to the N-type female bulkhead connector.
8. Run the Link Test diagnostics of the management tools that come with the radio unit to aim the antenna and verify optimal placement.

---

**Note:** You can use the unit's Antenna Alignment Display utility. See "Aligning the Antenna." on page 19

---

9. Once the antenna is correctly positioned, and you have verified the installation works properly, secure all cables and use weatherproofing tape to seal all outdoor connectors.

---

**Note:** When you must remove or relocate the antenna, follow the Safety Precautions at the beginning of this chapter and follow the steps listed above in exactly the reverse order.

---



## SITE PREREQUISITES

Review all requirements outlined in this chapter before starting the installation procedure. Prior to climbing on the roof or any other area where you intend to install the outdoor antenna, you are advised to:

- Verify that you have arranged all safety measures for outdoor installation or rooftop installation
- Verify that you have all equipment and tools required to install the outdoor antennas and 5054-R unit
- Install and verify proper operation of the equipment

## INDOOR LINK INSTALLATION

The following items are required on each end of the wireless link:

- For 5054 (MP.11a) units, a Base Station or a Base Station and Subscriber Unit
- A low-loss antenna cable to connect the indoor installation to the surge arrestor (optional)
- A surge arrestor to protect your sensitive equipment from static discharge and transients
- A low-loss antenna cable to connect the surge arrestor to the outdoor antenna (if surge arrestor in antenna cable is used)
- Female-female converter connector (optional – for 5054 only)
- Outdoor antennas (one at each end)
- A grounding system, as described in “Grounding System” on page 19

### Tsunami MP.11a Model 5054 Hardware

The following three types of hardware devices are used for setting up a wireless link with the 5054:

- Tsunami MP.11 5054 Base Station Unit (BSU)
- Tsunami MP.11 5054 Subscriber Unit (SU)
- Tsunami MP.11 5054 Residential Subscriber Unit (RSU)

For these indoor radios, the antenna cable is connected to the connector pigtail extending from the radio.



## Model 5054 Cable Setup for an Outdoor Antenna

The following figure shows an overview of the cable setup for the outdoor antenna. When the 5054 is not mounted close to where the antenna cable enters the building (where the surge arrester must be mounted), an additional cable between the 5054 and the surge arrester is required, plus a female-female converter connector. If the 5054 is mounted close to the surge arrester, the 5054 can be connected directly to the surge arrester.

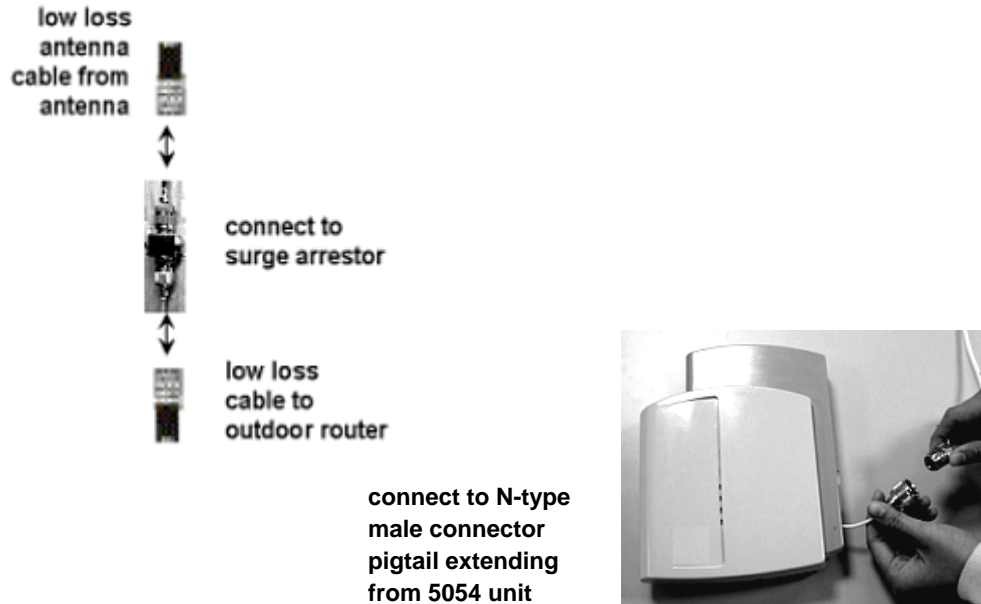

Figure 1. Cable Setup for 5054 Antenna Installation

---

**Note:** The exception to the rule is the indoor 5054 RSU when the window antenna is installed in an indoor location. This installation does not require the use of a surge arrester. The antenna can be connected directly to the 5054.

---



---

**CAUTION!** *The 5054 hardware, the surge arrester, and the antenna must be connected to the same grounding system.*

---

## Model 2454-R and Model 5054-R Hardware

The following types of hardware devices are used for setting up a wireless link:

- Base Station Unit (BSU)
- Subscriber Unit (SU)

There are two models of the 5054-R and 2454-R Subscriber Unit—one with an integrated antenna, another similar in appearance to the Base Station Unit, also with an external antenna connection, as shown in the following illustration.

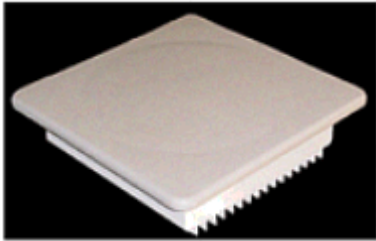

SU with Integrated Antenna



BSU / SU with External  
Antenna Connection

## Models 2454-R and 5054-R Cable Setup for the Outdoor Antenna

The following is an overview of the cable setup for the outdoor antenna. If the radio is mounted close to the surge arrester, it can be connected directly to the surge arrester.

**Ethernet cable** CONNECTS TO **Surge Arrester** CONNECTS TO **Ethernet Cable at ingress point**  
CONNECTS TO **5054-R/2454-R external connector**.

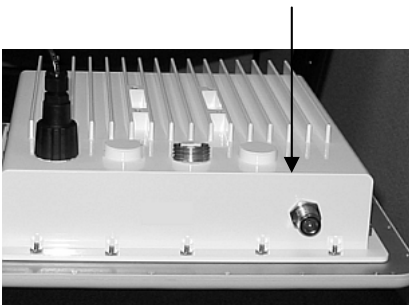

The electronics (power supply and radio) are designed for indoor mounting and operation. The ideal location must satisfy the following requirements:

- The location provides a connection to a grounding type AC wall outlet (100-240 VAC), using the standard power cord supplied with the unit. (Alternative power can be provided through Power over Ethernet.)
- The ground of the AC wall outlet must be connected to the same grounding system as the surge arrester and antenna mast (see “Grounding System” on page 19).
- The location must allow for easy disconnection of the radio hardware from the AC wall outlet.
- The location provides a connection to the network backbone (an Ethernet LAN cable that is connected to a hub, bridge, or directly into a patch panel)
- The location is as close as possible to the point at which the antenna cable is to enter the building (see “Placement of the Surge Arrester” on page 13).
- The ideal location has a temperature of 0–55° C and a maximum relative humidity (non-condensing) of 95%.

---

**CAUTION!** *The radio hardware, the surge arrester, and the antenna mast must be connected to the same grounding system.*

---

## Outdoor Hardware Placement

The 2454-R and the 5054-R are designed for outdoor mounting and operation.

To make optimal use of the units, you must find a suitable location for the hardware. The radio range largely depends upon the position of the antenna. Proxim recommends you do a site survey, observing the following requirements, before mounting the hardware.

- The location must allow easy disconnection of the unit from the power outlet if necessary.
- The radio units must not be covered, and air must be able to flow freely around it.
- The radio units must be kept away from vibration and excessive heat, and must be kept free from dust buildup.
- The installation must conform to local regulations at all times.
- The location provides a connection to the network backbone (an Ethernet LAN cable that is connected to a hub, bridge, or directly into a patch panel).
- The location is as close as possible to the point at which the antenna cable or Ethernet cable is to enter the building (see “Placement of the Surge Arrester(s)” on page 13).

---

**CAUTION!** *The radio hardware, the surge arrestors, and the antenna mast must be connected to the same grounding system.*

---

## Cable System

Prior to mounting the radio unit, you are advised to carefully calculate:

- The distance between the intended location of your unit and the location of the antenna mast
- The height of the antenna on the mast

If the low-loss antenna cable for the unit is not long enough to cover this distance, you either can select another cable length from the Proxim Systems low-loss cable offering, or select another location that satisfies the requirements previously listed to mount your unit. The radio unit can be placed anywhere, as long as Ethernet cable length allows.

Because the length of the antenna cable can affect the actual range of your outdoor antenna installation, Proxim recommends selecting another location or using the 5054-R model.

---

**WARNING! You must not change the length of the low-loss antenna cable used with the 5054 to a length shorter than allowed by the radio's certifications. Shortening the cable voids the Proxim Wireless Corporation warranty and can conflict with radio certifications or approvals.**

---

Installing the radio unit is described in the *Installation and Management* manual as well as the *Quick Install Guide*, which come on the product CD.

## Surge Arrestor Placement

The surge arrestor is an indispensable part of your outdoor antenna installation. It protects your sensitive electronic equipment from transients or electro-static discharges at the antenna.

For optimal protection, the surge arrestor must be installed at a location that satisfies the following requirements. A location:

- As close to the location at which the Ethernet cable will enter the building
- That allows for easy disconnection of the surge arrestor from the cable connected to the unit.

## Antenna Cable Route

The antenna cable must be connected from the antenna through the surge arrestor to the antenna connector of the unit.

To plan the route of the antenna cable for an indoor unit (5054), consider the following :

- Does the cable route require drilling through a wall or ceiling?
- Do you have a building plan of the desired location showing other cabling routes such as electricity, telephone or networking?
- Does the type of building materials require special drilling tools?

The cable should not be installed into tight positions, as bending or applying excessive force to the connectors can damage the antenna cable. Always allow the cable to bend naturally around corners. The recommended bend radius is at least 100 mm (4 in) or more for the low-loss cable of 10 mm (0.4 in) and 15 mm (0.6 in) diameter.

---

**CAUTION!**

- **The cable must be secured along the complete distance between attachment points. No part of the antenna cable should be allowed to hang free. This is particularly important for outdoor cable parts.**
  - **The antenna cable and cable connectors are not designed to withstand excessive force:**
    - **Do not use the connectors as 'cable grips' to pull cable through raceways or conduits.**
    - **Do not use the cable connector to support the weight of the cable during or after installation.**
    - **Do not use any tool to tighten the connectors.**
  - **Always seal the connectors using weatherproofing tape.**
  - **Avoid any water or moisture entering the cable as that impacts the performance of the wireless link.**
  - **Prior to sealing the outdoor connectors and permanently securing the cable to the wall with cable ties and wall hooks, verify whether the installation and all components functions properly.**
- 

## OUTDOOR LINK INSTALLATION

The outdoor installation of the link (point-to-point or point-to-multipoint) requires the following:

- An antenna or unit with an integrated antenna
- A low-loss antenna cable (available in four lengths)(not for unit with integrated antenna)
- Antenna mast or wall bracket for the antenna / unit
- A grounding system that meets the requirements described in "Grounding the Antenna" on page 19
- Waterproofing of all connections

---

**Note:** All outdoor cable connectors must be sealed with weatherproofing stretch tape to make the connectors permanently waterproof. See "Sealing the Cable Connectors" on page 18.

---

---

**DANGER!** *For your own safety, the antenna mast and the grounding system should be installed only by experienced installation professionals who are familiar with local building and safety codes and with the National Electrical Codes (NEC). Read carefully the instructions described in "Grounding the Antenna" and verify that your installation complies with the appropriate regulations and codes before installing the antenna.*

---

## Placing the Antenna

To achieve maximum performance of your wireless outdoor link, the outdoor antenna must have clear line-of-sight to the antenna of the other unit. Although the radio signal can work well without line-of-sight in urban environments in which the signal is transported by reflection rather than being direct, the best results are achieved in line-of-sight conditions.

Line-of-sight can be defined as:

- No obstacles in the direct path between the antennas (antenna beam)
- No obstacles within a defined zone around the antenna beam

You should be aware that the shape of an antenna beam is not straight and narrow like a laser beam. The antenna beam, also known as Fresnel<sup>2</sup> Zone, is rather bulged in the middle, such as, for example, a rugby ball.

---

<sup>2</sup>Pronounced as 'Fray-Nell'

The definition of the 1<sup>st</sup> Fresnel zone is an imaginary boundary line offset along the direct signal path. This boundary is defined as the point where if a signal were reflected between the two antennas, it would travel a distance exactly one-half wavelength longer than the direct-path signal. Each succeeding Fresnel zone boundary adds an additional half-wavelength to the reflected path distance between the antennas.

Signals reflected from any even-numbered Fresnel zone result in signal cancellation; those from odd-numbered Fresnel zones add to the direct path signal.

The exact shape and width of the Fresnel Zone is determined by the path length and frequency of the radio signal. The width as distance from the direct antenna beam is approximately 6 m (21 ft) in the middle of the wireless link for a distance of 6.5 Km (4 mi) and a frequency of 5.8 GHz. This width also is the required clearance of the antenna beam from obstacles in its path, to avoid loss of radio signal.

When any significant part of this zone is obstructed, a portion of the radio energy is lost, resulting in reduced performance. Reduced performance also can occur when obstacles close to the antenna beam cause signal reflections or noise that interfere with the radio signal.

The following figure shows some typical examples of obstacles you must avoid for the directional antenna to operate effectively:

- a. Neighboring buildings
- b. Trees or other obstructions
- c. Power lines

For optimal performance, you must ensure that the type and placement of the antennas leave sufficient clearance of the Fresnel Zone at the maximum width of the bulge, which is typically at the mid-point between the antennas.

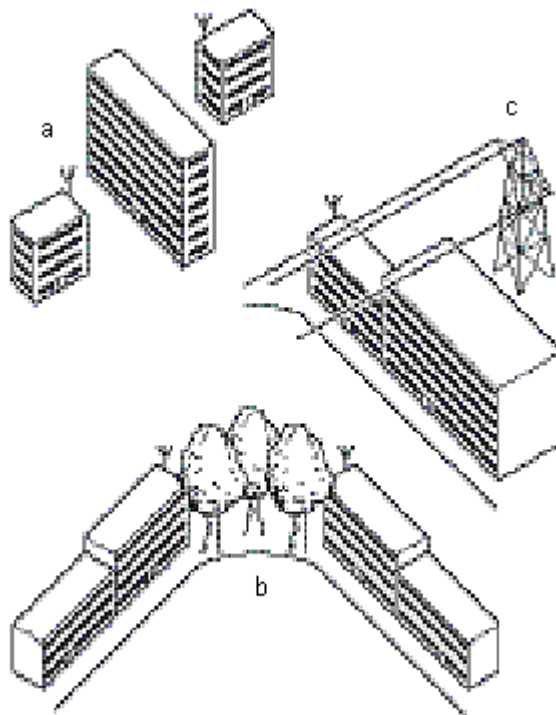

Figure 2. Potential Obstacles for a Directional Antenna

To minimize the influence of obstacles, signal interference, or reflections, note the following guidelines:

- Mount the antenna as high as possible above the *ground* to allow maximum clearance:
  - In open areas, *ground* is the actual surface of the earth.
  - In dense urban areas, *ground* is to be interpreted as the height of the highest obstacle in the signal path between the two antenna sites.
- Avoid trees in the signal path to avoid signal absorption due to seasonal changes (leaves or ice).
- Install the antenna at least 2 m (6 ft) away from all other antennas.

Other situations, in which reflections of the radio signal may cause interference, are environments in which large reflecting surfaces exist in parallel or partly perpendicular to the antenna beam.

Environments with large reflective surfaces include:

- Mirror-glass buildings
- Crowded parking lots
- Water surface or moist earth and moist vegetation
- Above ground power and telephone lines

---

**Note:** The use of reflective surfaces can be used to improve a link, especially if the direct line-of-sight is impaired or absent.

---

Weather conditions such as rain or snow usually do not have much impact on the performance of your Proxim product, provided you have sealed all cable connectors with weatherproofing tape.

Seasonal influence on signal propagation can occur in the following situations:

- A marginal communications quality in late fall (with no leaves on the trees in the signal path) might fail in the summer
- In winter, a wireless link can fail when the antenna is exposed to ice buildup or when the antenna elements are covered with snow

Radio paths over water or extremely flat ground may require optimization of antenna height at one end. This is due to in-phase or out-of-phase reflections. Adjustment of antenna height by 1 to 3 meters may move the signal from a null to a peak.

Long distance links may be obstructed by earth curvature, so the antenna height requirements must not only take the height of obstructions and Fresnel Zone into account, but also earth bulge. The earth bulge is approximately 5 m (16.4 ft) at a link distance of 16 Km (10 mi).

In these cases, consult your supplier to take appropriate steps to maintain or optimize wireless link performance.



## Mounting the Antenna

---

***As the mounting procedures for the various antennas differ from one another, consult the documentation you received from the manufacturer for mounting procedures.***

---

Proxim Wireless Corporation offers multiple antennas to set up a wireless link (as well as a unit with an integrated antenna).

When mounting multiple antennas on a single mast, use the following methods to minimize the influence of cross-talk interference between the antennas:

- Place your antennas as far apart as possible
- Alternate the mounting of directional antennas for vertical and horizontal polarization

There are two frequently used methods to erect an antenna mast:

### **Tripod Mount**

The tripod mount is used primarily on peaked and flat roofs. The antenna mast must be secured to the roof using three or four guy wires equally spaced around the mast. When the height of the antenna mast is more than 3 meters (10 ft), you should use at least three guy wires for each 3-meter (10-foot) section of the mast.

### **Wall (Side) Mount**

A wall (side) mount allows for mounting an antenna (mast) on the side of a building or on the side of an elevator penthouse. This provides a convenient mounting location when the roof overhang is not excessive or when the location is high enough to provide a clear line-of-sight.

In most situations mounting an antenna directly to the wall does not let you align the antenna properly with the corresponding antenna at the opposite end of your wireless link. As poor alignment typically results in poor performance, Proxim recommends always mounting the antennas to a mast.

## *Antenna Mast Requirements*

To accommodate the antennas, the antenna mast must satisfy the following requirements:

- The construction of the mast must consist of sturdy, weatherproof, and non-corrosive material (for example, galvanized or stainless steel construction pipe).
- Typical diameter of the mast should be between 35 mm (1.4 in) and 41 mm (1.6 in) (up to 4 in for 5054-R). Depending upon the type of antenna you intend to install, other diameters also may be possible.
- The height of the antenna mast must be sufficient to allow the antenna to be installed at least 1.5 m (5 ft) above the peak of the roof. If the roof is of metal, the height of the antenna should be at least 3 m (10 ft) above the roof.
- The mast or wall bracket must be free from any substance that may prevent a good electrical connection with the antenna (for example, paint).

## Connecting the Antenna Cable

Once the antenna is properly installed, you can connect the antenna to the unit by way of the surge arrester:

1. Connect the antenna cable to the antenna.
2. Secure the antenna cable to the mast so that the cable connectors do not support the full weight of the cable.
3. Connect the opposite end of the antenna cable to the surge arrester (see "Surge Arrester Installation" **Error! Bookmark not defined.**).

---

**CAUTION!** *To avoid damage to the antenna cable and connectors, refrain from using tools to tighten the cable connectors.*

---

4. Prior to securing the cable along its complete length, run the Link Test diagnostics of the management tools that come with the unit to analyze wireless performance and optimal placement of the outdoor antenna. Use of this tool is described in the documentation that comes with the radio unit and also can be downloaded from the Proxim support website at <http://support.proxim.com> .
5. If required, adjust the direction of the antenna.
6. Once the installation has been fully tested, tighten the nuts of the antenna to lock the antenna into its position.

---

**CAUTION!** *Avoid over-tightening of the connector, and nuts and screws used to mount the antenna, to prevent damage to your antenna and radio hardware.*

---

7. Secure the cable along its complete length with cable ties or electrical tape to relieve strain on the antenna connector properly. No part of any cable should be allowed to hang free. This is especially important for those parts that are routed outside the building.
8. Proceed as described in the next section to weatherproof all outdoor connectors.

## Sealing the Cable Connectors

Most problems associated with wireless outdoor installations are related to degrading performance due to corrosion of the antenna cable and cable connectors. To avoid this type of problem, you must always seal the cable connectors that are located outdoors using weatherproofing tape.

You are advised to seal the connectors only after you have verified optimal alignment of the antennas using the Link Test as described in the documentation that comes with the radio unit. Doing so lets you adjust antenna placement and cable routing without removing the tape.

To weatherproof the connectors:

1. Prepare the cable and connectors so that they are dry and free from dust, dirt and grease.
2. Attach the tip of the weatherproofing tape to the cable just above the connector. Holding the tape in its position, now stretch the tape and wind it half-overlapped around the cable and connectors to form a void-free joint. The degree of stretch may vary in different sections of the joint, as long as the overlaps accomplish a void-free application.

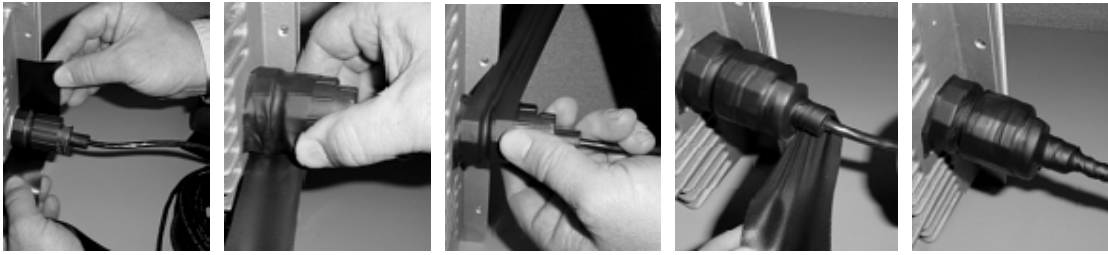

3. To protect the weatherproofing stretch tape from the effects of Ultra-Violet (UV) radiation (for example, from direct sunlight), you should protect the joint with two half-overlapped layers of any vinyl plastic electrical tape. Alternatively, you can apply silicone sealer to protect the weatherproofing tape from sunlight, rain and other weather conditions.

## Grounding the Antenna

Direct grounding of the antenna mast, radio hardware and surge arrestor is extremely important.

---

**Note:** A safety grounding system is necessary to protect your radio hardware from lightning strikes and the build-up of static electricity.

---

### **WARNING!**

***The antenna mast, radio hardware, and surge arrestor must be connected to the same ground, using an equi-potential bonding conductor.***

***A good electrical connection should be made to one or more ground rods, using at least a 10AWG ground wire and non-corrosive hardware.***

***The grounding system must comply with the National Electrical Code and safety standards that apply in your country. Always check with a qualified electrician if you are in doubt whether your radio hardware installation is properly grounded.***

---

## Aligning the Antenna

For optimal performance of your wireless link, make sure the antennas are properly aligned (facing one another *eye-to-eye*). Antenna alignment is a process to physically align the antennas of both units to have the best possible radio link established between them. The antenna alignment process usually is performed during installation and after major repairs.

To align the antennas:

- Use a pair of binoculars or a map of the area and a compass to point the antennas to one another.
- Use the **Antenna Alignment Display** feature (AAD) to display a measurement of signal quality at the CLI and serial ports.
- You also can use the **Link Test** option of the management tools that come with the MP.11a and the 5054-R to analyze the radio link quality.

## Antenna Alignment Display Feature

Antenna alignment is a process to physically align the antennas of both units to have the best possible radio link established between them. The antenna alignment process usually is performed during installation and after major repairs.

The 2454-R and 5054-R have an audible antenna alignment tool that can be activated by plugging in the supplied serial dongle (supplied with every Base Station) or by issuing the CLI command for antenna alignment. The CLI command causes both audible and numerical feedback as the CLI shows the running SNR values twice a second. The model 5054 has the SNR value output on the CLI but not the audible output (see “Antenna Alignment Commands” on page 21).

The output from the beeper for antenna alignment consists of short beeps with a variable interval. The interval changes with the SNR level to assist in correctly aligning the antenna. An increase in signal level is indicated by a shorter interval between beeps; a reduction in signal level results in beeps further apart.

To allow for precise antenna alignment, small changes in SNR result in large changes in the beep period. The alignment process averages the SNR, which is represented by an average length beep. When a higher SNR is received, the beep period is made shorter, dependent upon the difference to the average. A lower SNR results in a longer period between beeps.

The first five steps are represented by a large change and all following steps are a small change. This acts as if a magnifying glass is centered around the average SNR and the values next to the average are significantly different.

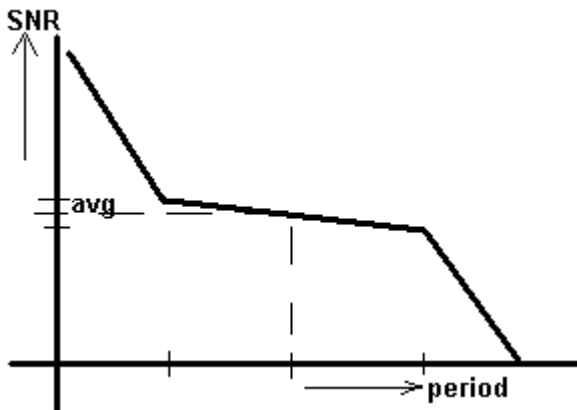

When the antenna is aimed, the beep can easily be heard if the SNR is rising (shorter period, higher frequency) or falling (longer period). When the position of the antenna has been changed, the SNR averaging settles at the new value and the beeping returns to the average length so the antenna can again be aimed towards rising SNR.

Aiming is complete if moving in any direction results in a falling SNR value, which can be heard as longer periods between beeps.

---

### Notes:

- Antenna alignment for the Base Station is useful only for a point-to-point link.
  - The range of the average SNR is limited to values from 0 to 48. Anything over 48 is capped at 48.
  - AAD is automatically disabled 30 minutes after it is enabled to remove the load of extra messages on the wireless interface. The default telnet timeout is 900 seconds (15 minutes). If AAD must run for the entire 30 minutes, change the default telnet timeout value greater than 30 minutes (greater than 1800 seconds). This restriction is for telnet connections only and not for the serial interface. The serial interface never times out.
-

## Antenna Alignment Commands

### set aad enable local

Enables display of the local SNR. Local SNR is the SNR measured by the receiver at the near end.

### set aad enable remote

Enables display of the remote SNR. Remote SNR is the SNR as measured by the receiver at the far end.

### set aad enable average

Enables display of the average SNR. The average SNR is the average of the local and remote SNR.

### set aad disable

Disables Antenna Alignment Display (Ctrl-C also disables AAD).

## Link Test

You also can use the **Link Test** option of the management tools that come with the radio unit to analyze the radio link quality. The Link Test option lets you display the radio signal strength in relation to the noise in the signal path. If required, you can interactively optimize the antenna alignment with the Link Test, by making small modifications in the antenna orientation.

The Link Test provides SNR, Signal, and Noise information.

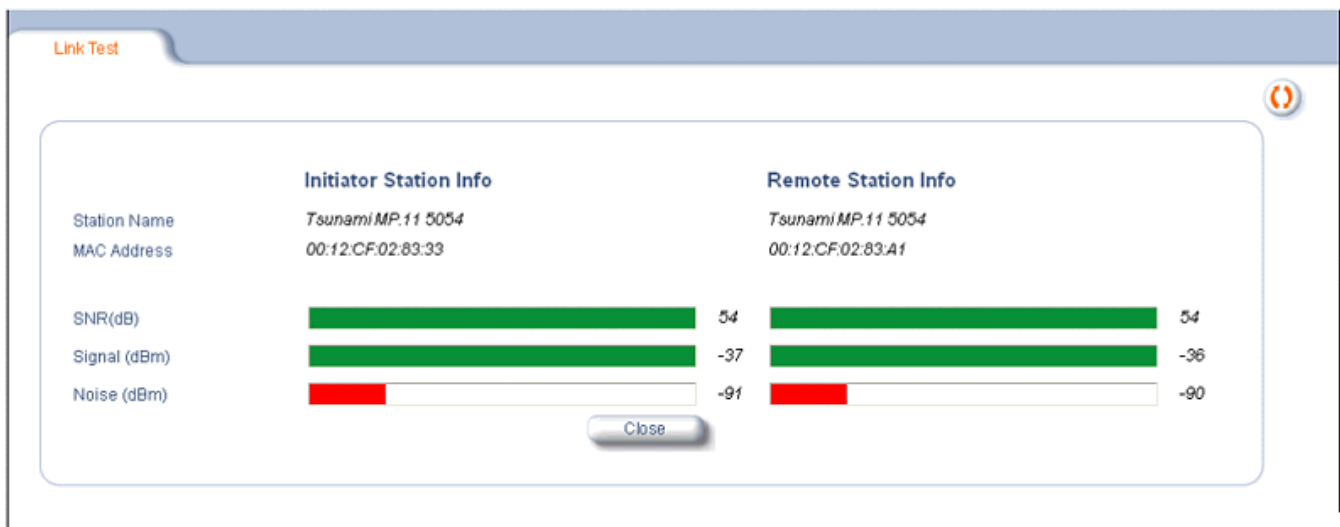

Link Test stops when you close the **Link Test** page.

Alternatively, consult a professional Antenna Installation Service to optimize the antenna alignment.

## Antenna Polarization

Outdoor antennas are standard-mounted for vertical polarization.

In some cases, you might consider mounting the antenna for horizontal polarization; for example, to minimize the influence of cross-talk between antennas when:

- You plan to mount multiple directional antennas to the same mast.
- Your wireless link receives interference from a vertically polarized neighboring installation.

**Note:** For optimal wireless link performance, you must always verify that the antenna polarization on both ends of the wireless link is the same.

## Antenna Cable Routing

The antenna cable must be routed and fixed in such a way that installation technicians have a clear passage area.

All connectors that are located outdoors must have a weatherproof seal. You are advised to seal connectors only after you have completed the final radio test.

## BEFORE CLIMBING THE ROOF...

Before you start the installation, check whether you have all the required components to set up an outdoor wireless link.

For each side of a wireless outdoor wireless link you need:

- One or two low-loss antenna cables or a unit with an integrated antenna
- A female-female converter N-connector in case you want to use two antenna cables
- Tools and material to mount the antenna
- Tape or wraps to attach the antenna cable, for example to the mast
- Ethernet cable with waterproof cap for 5054-R
- Grounding material such as cable and Faston connector for 5054 or ground-lug plus screw, for 5054-R

If an item is missing or damaged during shipment, inform your supplier.

## Chapter 2. Determining Range and Clearance

When you read about wireless outdoor products, you often encounter the terms *output power* of the radio and *gain* of the antenna equipment as measures for the *strength* of the transmitted signal.

- Output power of radio equipment often depends on maximum limits as defined by local radio regulations; consequently, output power is, by definition, not the way to enhance wireless performance.
- High gain antennas are larger in size than low gain antennas and are characterized by a narrow focus of the antenna beam. These two characteristics make it more difficult to aim the antennas and adjust antenna alignment to optimize the performance of the wireless point-to-point link.

The 5054, 2454-R, and 5054-R outdoor solution is based upon the following principles:

- Output power and antenna gain that comply with the maximum limits as defined by local governing bodies concerning radio transmissions.
- Enhanced radio sensitivity for optimal receive quality of radio signals transmitted by remote antennas.

### DETERMINING THE OUTDOOR RANGE

The range of your outdoor antenna installation is closely related to a number of different factors. To let you determine the range of the antenna system in your situation, we have defined the following formula:

$$\text{Range} = \text{Maximum Range} \times \text{Clearance Factor}$$

where:

Maximum Range	Identifies the theoretical maximum that could be achieved under optimal circumstances using the available Tsunami MP.11 products according to their specifications and in compliance with local radio regulations.
Clearance Factor	Identifies a correction value (in percentage) that should be used in case the signal path of your wireless link does not provide the minimum clearance as listed in the Maximum Range table. (See "Clearance Factor" on page 24.)

---

**Note:** You also can use a calculation sheet provided by Proxim to generate an estimate of link distance and reliability.

---

## Maximum Range

The maximum range of your system is based upon:

- The type of outdoor antenna equipment
- The data speed of the wireless link
- The clearance of the signal path (see “Clearance Factor” below).

The values in this section are based upon calculations that assume optimal radio conditions. They do not represent a guarantee that the same maximum distance can be achieved at your location. Differences in performance figures can result from:

- Incorrect alignment of antennas (see “Aligning the Antenna” on page 19)
- Polarization mismatch of the antennas
- Sources of interference or unexpected reflections in the signal path that affect the communications quality (see “Antenna Placement” on page 14)
- Severe weather conditions such as heavy rain or snow fall, or strong winds
- Unexpected obstacles in the link path
- Seasonal influences such as leaves on trees, or icing on the antennas

## Clearance Factor

For optimal performance of your outdoor wireless link, the signal path between the Base Station Unit and Subscriber Unit must provide sufficient clearance.

---

**Note:** An outdoor wireless link that lacks sufficient clearance will suffer from poor performance, which is typically perceived as slow network response times. Although your radio equipment automatically retransmits every lost data frame due to an out-of-range situation or frame collision, the larger the number of retransmissions, the lower the throughput efficiency of your wireless link.

---

This section explains how to determine the clearance that applies in your environment and (if applicable) the effect of insufficient clearance on the range of your outdoor wireless link.

In “Chapter 1. Preparing for Installation” on page 7, we described the shape of the antenna beam as being bulged in the middle.

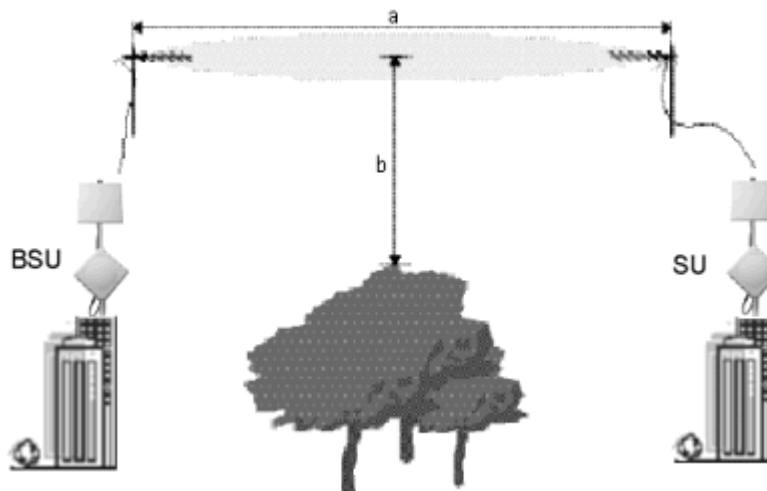

Figure 3. Fresnel Zone



If any significant part of this bulged zone is obstructed, a portion of the radio energy is lost, which can affect the performance of your wireless link in terms of maximum range and transmit rate.

In Figure 3, you see two variables that determine the shape of the antenna beam, also referred to as Fresnel Zone:

- The distance between the antennas (a)
- The clearance required for optimal performance (b), where clearance should be interpreted as:
  - Vertical clearance above the ground and the highest buildings or objects in the signal path
  - Horizontal clearance from neighboring buildings and objects in the signal path

For optimal range and throughput performance, you must ensure that your antenna installation provides maximum clearance in both horizontal and vertical direction.

Clearance should be interpreted as follows:

- In open areas without obstacles in the signal path, clearance is measured as height above the surface of the earth. For example, if the antenna is mounted on the roof, this height includes the height of the building plus the height of the mast above the rooftop.
- In areas with obstacles in the signal path between the two antennas, clearance should be measured as height above the highest obstacle in the signal path.
- In dense urban areas, the clearance should be measured as height above the highest rooftop or any other obstacles in the signal path between the two antennas.

For situations in which local authorities, the proprietor of the premises, or other factors do not let you set up an antenna mast that lets you meet the listed clearance requirements, you may be unable to achieve a full line-of-sight clearance. At the same time, however, when the distance that your wireless outdoor installation must cover is less than the listed maximum range, you may not even need full clearance.

To determine the effect of insufficient signal path clearance, you must determine the Clearance Factor as described below, and calculate its effect on the range for your antenna installation using the formula described in "Determining the Outdoor Range" on page 23.

- If the clearance for your antenna installation is equal to or better than the minimum clearance requirement, the Clearance Factor for your installation is 100%.
- If your actual clearance is less than the minimum clearance, use the diagram depicted in the following figure to determine the actual range that applies in your situation.

---

**Note:** The Clearance Factor Diagram should be used as a rule-of-thumb for estimating the probable range in case the clearance requirements are not fully met. In real life, using FCC approved products, you will also find it almost impossible to achieve the level of clearance for maximum range, due to interference from other radio products.

---

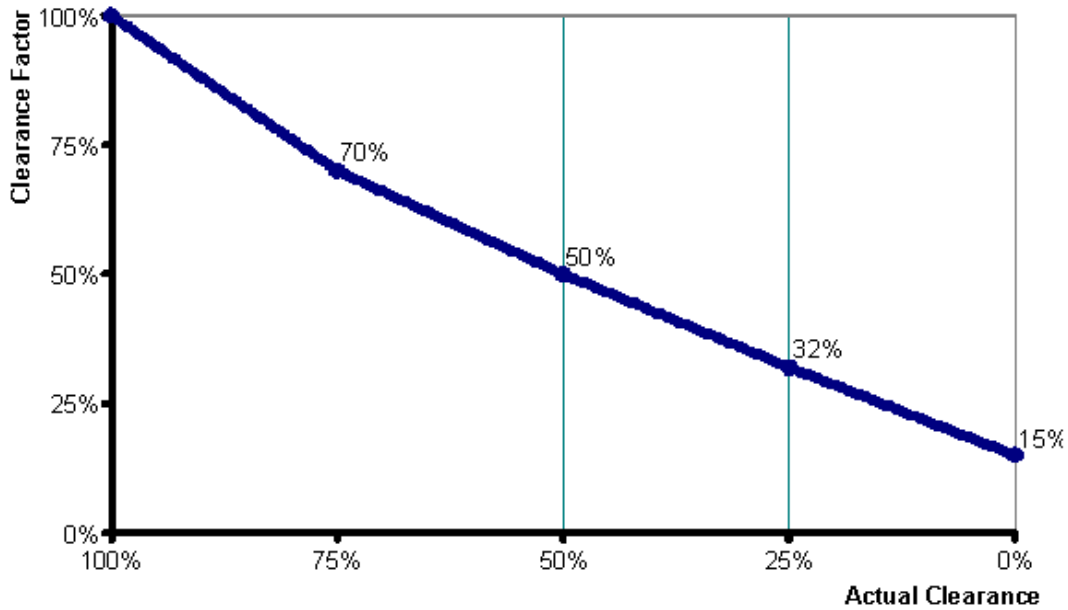

Figure 4. Clearance Factor Diagram

## DISTANCE ASSUMPTIONS AND EXPECTATIONS

### Model 5054

#### Assumptions

- Point-to-multipoint configuration using USA regulations for L and U bands, ETSI regulations for M bands
- Clear line-of-sight with no unusual multipath
- Sector antenna (17 dBi, 60°) at Base Station with 20 feet LMR-600 cable
- Three-foot parabolic dish (31.4 dBi) at Subscriber Unit with 20-foot LMR-600 cable
- With a fade margin minimum of 10 dB to 2 miles, and 0.2 dB additional fade margin for every 0.1 miles, to 15 dB, availability is greater than 99.99%.

#### Expectations

5.25 – 5.35 GHz	0.9 miles at peak performance (36 Mbps mode) Up to 2.8 miles maximum (6 Mbps mode)
5.47 – 5.725 GHz	0.85 miles at peak performance (36 Mbps mode) Up to 2.65 miles maximum (6 Mbps mode)
5.725 – 5.850 MHz	4.0 miles at peak performance (36 Mbps mode) Up to 11.2 miles maximum (6 Mbps mode)

## Model 5054-R

### Assumptions

- Point-to-multipoint configuration using USA regulations for L and U bands, ETSI regulations for M bands
- Clear line-of-sight with no unusual multipath
- Sector antenna (17 dBi, 60°) at Base Station with short 6 ft LMR-600 (1 dB loss) jumper cable
- Standard integrated antenna for Subscriber Unit
- With a fade margin minimum of 10 dB to 2 miles, and 0.2 dB additional fade margin for every 0.1 miles, to 15 dB, availability is greater than 99.99%.

### Expectations

5.25 – 5.35 GHz	0.5 miles at peak performance (36 Mbps mode) Up to 1.7 miles maximum (6 Mbps mode)
5.47 – 5.725 GHz	0.4 miles at peak performance (36 Mbps mode) Up to 1.6 miles maximum (6 Mbps mode)
5.725 – 5.850 MHz	2.8 miles at peak performance (36 Mbps mode) Up to 7.6 miles maximum (6 Mbps mode)

## Model 2454-R

### Assumptions

- Point-to-multipoint configuration using USA regulations for L and U bands, ETSI regulations for M bands
- Clear line-of-sight with no unusual multipath
- Sector antenna (17 dBi, 60°) at Base Station with 20-foot LMR-600 cable
- Three-foot parabolic dish (31.4 dBi) at Subscriber Unit with 20-foot LMR-600 cable for USA
- 14 dBi panel antenna at Subscriber Unit with 20-foot LMR-600 cable for ETSI
- With a fade margin minimum of 10 dB to 2 miles, and 0.2 dB additional fade margin for every 0.1 miles, to 15 dB, availability is greater than 99.99%.

### Expectations

6.8 miles at peak performance (11 Mbps) for FCC

0.9 miles at peak performance (11 Mbps) for ETSI

Up to 1.73 miles maximum (1 Mbps) for FCC

Up to 3 miles maximum (1 Mbps) for ETSI

## CALCULATIONS

Availability of the microwave path is a prediction of the percent of time that the link operates without producing an excessive bit error rate (BER) due to multipath fading. In the absence of direct interference, availability is affected by the following:

- Path length
- Fade margin
- Frequency
- Terrain (smooth, average, mountainous)
- Climate (dry, temperate, humid)

Depending upon the type of information carried over the link and the overall network design redundancy, you may want to design for a specific availability rate. For example, if the data or voice traffic carried by the radio is critical, the link can be designed for a very high availability rate (for example, 99.999% or 5.3 minutes of predicted outage per year).

Availability can be improved by increasing the fade margin either by making the path shorter or by using the higher gain antennas in conjunction with lower loss antenna cable (using a higher quality antenna cable, shortening the length, or both).

If the system is intended to operate with “roaming” of Subscriber Units between BSUs, the SU must maintain a high enough signal level while switching from one BSU to the next. Due to the time necessary to switch, the coverage (and therefore the distance between the BSUs) is impacted by the speed of movement of the SU or RSU. The Link Budget of both links between an SU or RSU and either BSU must be high enough to allow good quality communication and a smooth handover.

---

**Note:** In previous 1.x versions of the software in which the SU had a long timeout upon registration, the switch to a new BSU is made only when the link with the current BSU is lost for at least 30 seconds).

---

### Calculating Received Signal Level and Link Budget

Use the following formula to estimate the received signal level (RSL):

$$\text{RSL (dBm)} = P_{\text{out}} - L_1 + G_1 + G_2 - L_2 - L_p$$

where:

- $P_{\text{out}}$  is the transmitter output power (in dBm)
- $L_1$  is the total loss of all transmission elements between the antenna and the RF Unit on one side of the link (in dB)
- $G_1$  is the gain of the antenna on one side of the link (in dB)
- $G_2$  is the gain of the antenna on the opposite side of the link (in dB)
- $L_2$  is the total loss of all transmission elements between the antenna and the RF Unit on the opposite side of the link (in dB)
- $L_p$  is the Path loss, defined by:  $L_p \text{ (dB)} = 96.6 + 20 \log_{10} F + 20 \log_{10} D$   
where:
  - $F$  is the Frequency of the radio system in GHz (5.8 or 2.4 GHz)
  - $D$  is the Distance of the path in miles

---

**Note:** This formula is available on a calculation sheet provided by Proxim to generate an estimate of link distance and reliability.

---

See the following figure for a visual representation of the elements of this equation.

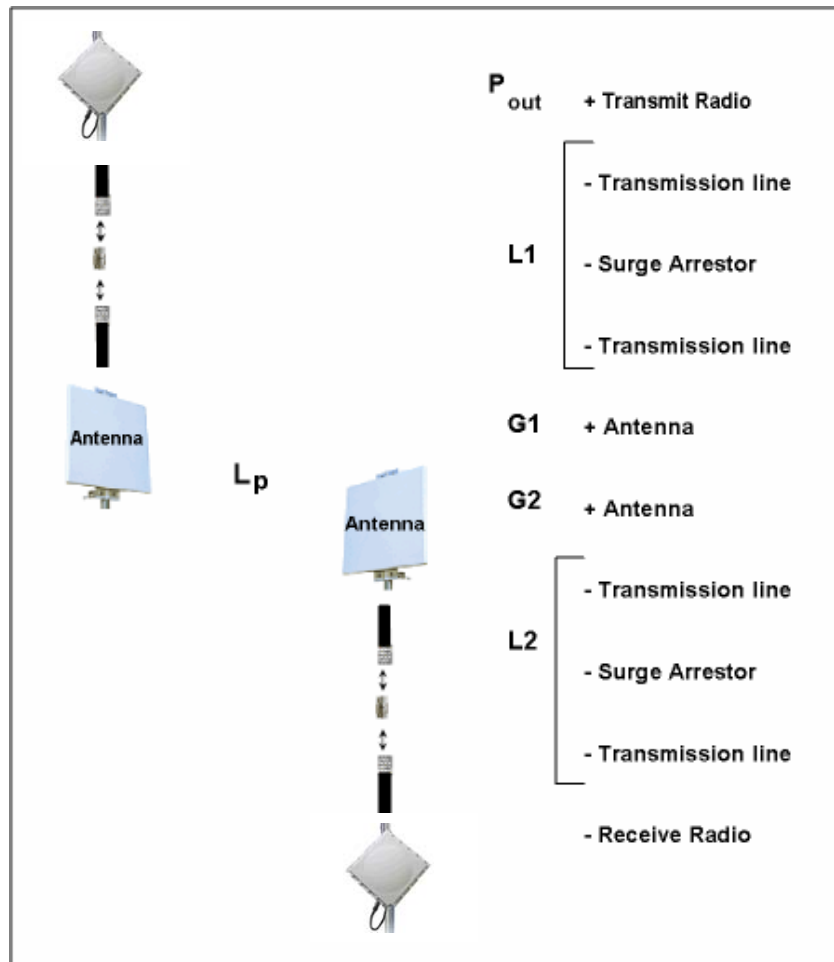

### Procedure

1. Start with the transmit power and the number of the channel to be used. From the *output power tables* on page 30 find the dBm associated with this output power and channel.
2. Subtract the total loss of all transmission elements between the antenna and the radio on one side of the link (dB).
3. Add the dBi of the antenna you will be using. The total is the **EIRP** (equivalent isotropically radiated power).
4. Determine your link budget from the *Distance and Path Loss* table, For example, if the distance between the two radios is approximately 5 km, the link budget would be 121. (Note that this is the value for 4.8 km, which is closest to the actual value.)
5. Add the gain of the antenna on the second side of the link.
6. Subtract the total loss of all transmission elements between the antenna and the radio on the second side of the link. The result is the **Received Signal Level (RSL)**.
7. From the Receiver Sensitivity tables in the *Tsunami MP.11 Installation and Management* manual Technical Specifications, find the dBm value for the data rate used for the link.
8. Subtract this value from the Received Signal Level; this is the **Fade Margin**.

**Notes:**

- The RSL must be higher than the Receiver Sensitivity plus the fade margin for a good link. See Table 1 to have a working link with no excessive errors. The amount of Fade Margin indicates the reliability of the link; the more Fade Margin, the more reliable the link.
- The path loss must be smaller than the link budget minus the minimum required fade margin. The maximum ranges cause the path loss plus the fade margin to be the same as the link budget.

The results of this link budget calculation are very important for determining any potential problems during installation. If you have calculated the expected RSL, you can verify that it has been achieved during installation and troubleshooting, if necessary.

In the USA and Canada, this model radio can be installed with any gain directional antennas, as there is no Effective Isotropic Radiated Power (EIRP) limit for the application of these systems for fixed point-to-point applications in the 5.8 GHz frequency band. In other bands and in other countries, EIRP limits may apply.

In the case of EIRP limits, use the lesser of either ( $P_{out} - L_1 + G_1$ ) or the EIRP limit within the previous equation. You should check this equation in both directions to assure legal application. An EIRP limit is the maximum RF energy that can be transmitted, as measured at the transmitting antenna, and is usually determined by government regulations.

Proxim's recommendation is to keep at least 60-70% of the first Fresnel zone free. If the clearance is lower than this percentage, the *link budget* and achieved *fade margin* are affected. Clearances more than 100% of the Fresnel zone can cause reflections that are 180 degrees out of phase and can cancel out the signal. The Fresnel zone works in both the horizontal and vertical paths.

The first Fresnel zone size is a list; Proxim's recommendation is to keep at least 60-70% of this zone free. If the clearance is lower than this percentage, the *link budget* and achieved *fade margin* are affected. Clearances more than 100% of the Fresnel zone can cause reflections that are 180 degrees out of phase and can cancel out the signal. The Fresnel zone works in both the horizontal and vertical paths.

Tables for output levels can be found in the Technical Specifications in the *Tsunami MP.11 Installation and Management* manual.

Table 1. Examples of Minimum Antenna Cable Loss

Frequency Band	Antenna Gain	TPC Setting	Minimum Cable Loss for Data up to 24 Mbps*	EIRP	Deployment
5.25-5.35 GHz	10	0	0	28.5	USA
5.25-5.35 GHz	17	-6	0	29.5	USA
5.25-5.35 GHz	23	-10	1.5	30	USA
5.25-5.35 GHz	31	-10	9.5	30	USA
5.725-5.85 GHz	10	0	0	28.5	USA, PtMP
5.725-5.85 GHz	17	0	0	35.5	USA, PtMP
5.725-5.85 GHz	23	-6	0	35.5	USA, PtMP
5.725-5.85 GHz	31	-10	3.5	36	USA, PtMP
5.725-5.85 GHz	10	0	0	28.5	USA, PtP
5.725-5.85 GHz	17	0	0	35.5	USA, PtP
5.725-5.85 GHz	23	0	0	41.5	USA, PtP
5.725-5.85 GHz	31	0	0	49.5	USA, PtP
5.47-5.725 GHz	10	0	0	28.5	ETSI
5.47-5.725 GHz	17	-6	0	29.5	ETSI
5.47-5.725 GHz	23	-10	1.5	30	ETSI
5.47-5.725 GHz	31	-10	9.5	30	ETSI

\* Note that higher data rates use lower output power, so less cable loss is required to meet the maximum EIRP limit.

Table 2. Distance and Link Budget

Reference Frequency: 5600 MHz Center Frequency for Europe								
Link Budget (dB)	Distance (m)	Fresnel Zone (m)	Link Budget (dB)	Distance (m)	Fresnel Zone (m)	Link Budget (dB)	Distance (km)	Fresnel Zone (m)
61	4.8	0.3	91	151	1.4	121	4.8	8.0
62	5.4	0.3	92	170	1.5	122	5.4	8.5
63	6.0	0.3	93	190	1.6	123	6.0	9.0
64	6.8	0.3	94	214	1.7	124	6.8	9.5
65	7.6	0.3	95	240	1.8	125	7.6	10.1
66	8.5	0.3	96	269	1.9	126	8.5	10.7
67	9.5	0.4	97	302	2.0	127	9.5	11.3
68	11	0.4	98	339	2.1	128	10.7	12.0
69	12	0.4	99	380	2.3	129	12.0	12.7
70	13	0.4	100	426	2.4	130	13.5	13.4
71	15	0.5	101	478	2.5	131	15.1	14.2
72	17	0.5	102	537	2.7	132	17.0	15.1
73	19	0.5	103	602	2.8	133	19.0	16.0
74	21	0.5	104	676	3.0	134	21.4	16.9
75	24	0.6	105	758	3.2	135	24.0	17.9
76	27	0.6	106	850	3.4	136	26.9	19.0
77	30	0.6	107	954	3.6	137	30.2	20.1
78	34	0.7	108	1071	3.8	138	33.9	21.3
79	38	0.7	109	1201	4.0	139	38.0	22.6
80	43	0.8	110	1348	4.2	140	42.6	23.9
81	48	0.8	111	1512	4.5	141	47.8	25.3
82	54	0.8	112	1697	4.8	142	53.7	26.8
83	60	0.9	113	1904	5.0	143	60.2	28.4
84	68	1.0	114	2136	5.3	144	67.6	30.1
85	76	1.0	115	2397	5.7	145	75.8	31.9
86	85	1.1	116	2689	6.0	146	85.0	33.7
87	95	1.1	117	3018	6.4	147	95.4	35.7
88	107	1.2	118	3386	6.7	148	107.1	37.9
89	120	1.3	119	3799	7.1	149	120.1	40.1
90	135	1.3	120	4263	7.6	150	134.8	42.5

The distance is based upon the assumption that 60% of the 1st Fresnel is clear.

---

## Chapter 3. Antenna Cabling System

### INTRODUCTION

As radio regulations differ between the various countries worldwide, not all of the outdoor solutions described in this manual may be allowed in the country where you plan to install this equipment.

Local radio regulations or legislation may impose restrictions on the use of specific combinations of:

- Low-loss antenna cables and outdoor antennas
- Radio channels selected at the units that are connected to specific outdoor antennas

---

**Note:** A basic rule for selecting a combination of cables and antennas is that no combination is allowed unless explicitly approved in this manual. Therefore, always use this chapter in combination with “Chapter 2. Determining Range and Clearance” on page 19 of this document to select the right type of antenna equipment and to inform your antenna installer and LAN administrator about the impact of regulatory constraints on their job or activities.

---

### CABLE COMPONENTS

To comply with local radio regulations, the BSUs and SUs have a selectable radio power output level. It can be selected through the TPC (Transmit Power Control) parameter in the user Interface. See the product's *Installation and Management* manual for more information.

The low-loss antenna cable recommended is an LMR-600 (2 meters / 6 feet). You can order this accessory from Proxim Wireless Corporation.

When you order the antenna equipment, make sure that you order cables that comply with the regulations that apply in your country. In case of doubt, consult the Proxim Wireless Corporation Sales office for more information

To connect your radio hardware to an outdoor antenna installation, you will need the following cabling components:

- Surge arrestor
- Low-loss antenna cables
- One of the outdoor antennas described in *Tsunami MP.11 Recommended 5 Gz and 2.4 GHz Antennas*.

When purchasing new MP.11 products, each of these components will be equipped with standard N-type connectors.

When ordering separate components, for example as a spare part or replacement to previously purchased outdoor antenna equipment, carefully read the note on the following page to ensure that you order components with an N-type connector that matches the other parts of your outdoor antenna cabling system.



## SELECTING THE CORRECT CONNECTOR TYPE

The following are differences between the Tsunami MP.11 Model 5054 and Model 5054-R:

- Male versus Female N-type connector
- Indoor install and long coax versus Outdoor install and short coax
- Low-loss antenna coax versus outdoor-rated Ethernet cable and surge arrester

All cabling components of the outdoor antenna system come with standard-N type connectors as depicted in the following table.

Table 3. Standard N-Type Connector Diagram

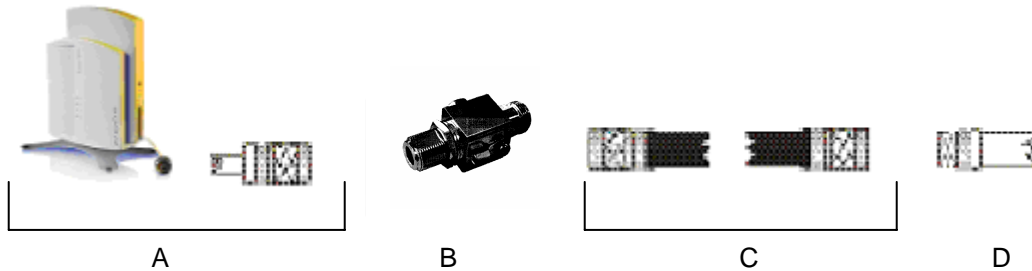

Cabling Component	Standard-N Cabling Systems
A TMP 5054-R / 5054 (5054 shown)	Standard-N female / male
B Surge arrester	Standard-N female on both ends
C Low-loss cable	Standard-N male on both ends
D Outdoor antenna	Standard-N female

Note that the gender of the connector is not determined by the connector's thread, but by its center pin; a solid center pin = male, a hollow pin = female.

### **DANGER!**

**Outdoor antennas and antenna cables are electrical conductors. Transients or electrostatic discharges that may occur at the antenna (for example a lightning strike during thunderstorms) may damage your electronic equipment and cause personal injury or death to persons touching the exposed metal connectors of the antenna cable.**

**To avoid damage and personal injury, the entire antenna cabling system must be grounded at all times.**

**When installing, disconnecting or replacing one of the cabling components, you must ensure at all times that each exposed metal connectors of the antenna cabling system will be grounded locally during the work.**

When mounting or replacing the surge arrester:

1. First connect each of the connectors of the low-loss antenna cables to the grounding system.
2. Next connect the cable connector to the grounding system.
3. Finally connect the surge arrester to the grounding system.

Before you proceed, verify that each of the items is properly grounded and that the ground will not be interrupted when disconnecting one of the antenna system components.

Check with a qualified electrician if you are in doubt as to whether the surge arrester and cable connectors are properly grounded. Only after you have verified that each of the items is properly grounded, replace the surge arrester and disconnect the cables from the grounding system in exactly the reverse order of the previous steps.

## USING A SURGE ARRESTOR

Lightning protection is used to maximize the reliability of communications equipment by safely re-directing current from a lightning strike or a power surge traveling along the Cat 5 Ethernet cabling to ground using the shortest path possible. Designing a proper grounding system prior to installing any communications equipment is critical to minimize the possibility of equipment damage, void warranties, and cause serious injury.

The surge arrester (sometimes referred to as a lightning protector) can protect your sensitive electronic equipment from high-voltage surges caused by discharges and transients at the antenna.

Proxim Wireless offers provides superior lightning and surge protection for Tsunami MP.11 and Tsunami QuickBridge.11 products. See the following sections for more information.

## Mechanical Layout

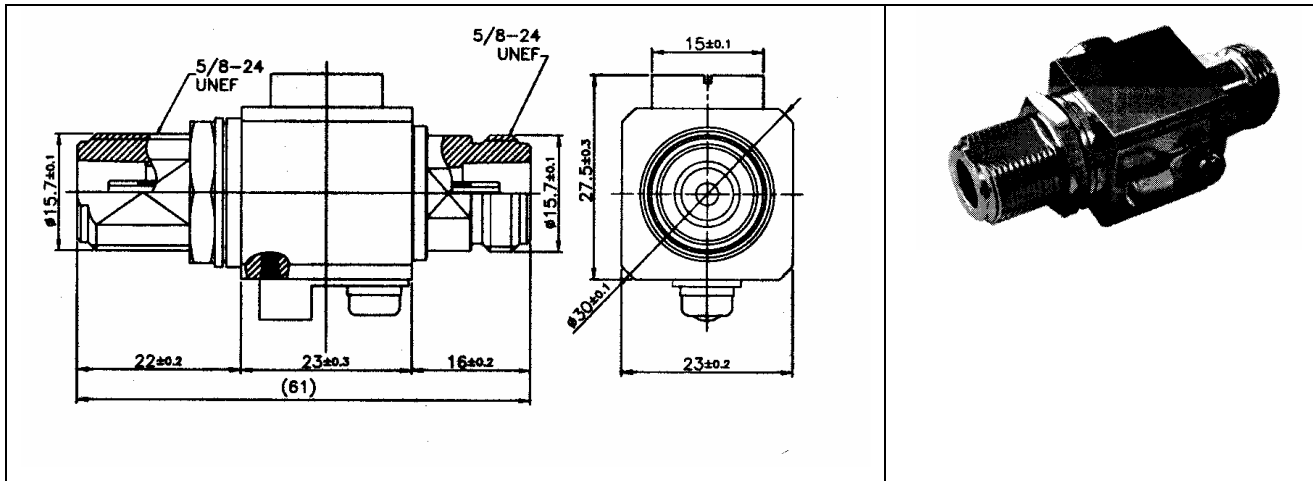

**CAUTION!** To avoid damage to electronic equipment and your radio equipment, always apply the surge arrester between the outdoor antenna installation and the radio hardware or other computing device that is connected to the outdoor antennas.

## Specifications

<b>Part number</b>	5054-SURGE
<b>Frequency range</b>	DC~ 5.875 GHz
<b>VSWR</b>	1.25 : 1 Max. @ DC~4 GHz 1.45 : 1 Max. @ 4~5.875 GHz
<b>Insertion loss</b>	0.5 dB Min. @ DC~5.875 GHz
<b>Impedance</b>	50 Ω
<b>DC breakdown voltage</b>	90 V +/- 15%
<b>Impulse breakdown voltage</b>	1000 V
<b>Insulation resistance</b>	10000 MΩ
<b>Maximum withstand current</b>	5 KA
<b>Clamping voltage (PoE,Data)</b>	58 volts
<b>Connectors</b>	2 modular RJ45 N-Female jacks, 2 removable terminal strips
<b>Cable type</b>	Cat5, UV-shielded and outdoor-rated, 100 ohms, 4 UTP, 24 AWG, UL rated, 330 feet / 100 meters total length with in-line unit
<b>Dimensions</b>	6.3 x 3.15 x 2.17 in (160 x 80 55 mm)
<b>Weight</b>	0.38lb (0.17kg)
<b>Operating Temperature</b>	-20C to +80C (-4F to +176F)
<b>Grounding</b>	10-32 stud with wire-clamp. 10 AWG grounding wire is recommended

## VSWR and Insertion Loss

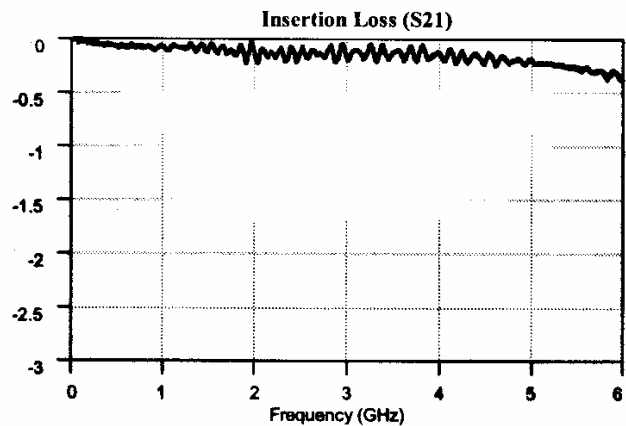
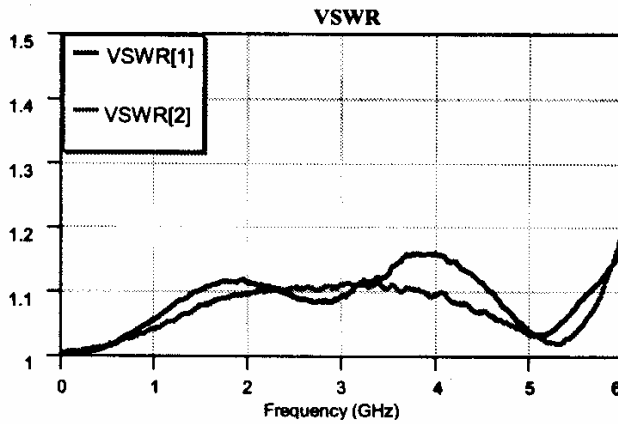

---

## Support and Warranty

If you are having a problem using a Proxim product and cannot resolve it with the information in the product documentation, gather the following information and contact Proxim Technical Support:

- What kind of network are you using?
- What were you doing when the error occurred?
- What error message did you see?
- Can you reproduce the problem?

Be sure to obtain an RMA number before sending any equipment to Proxim for repair.

To receive E-mail technical support, be sure to include the serial number of the product(s) in question. The serial number should be on the product and conform to the following format: ##AT##### or ##UT##### or ##R7#####. We are unable to respond to your inquiry without this information.

### **USA & Canada Customers**

Call Technical Support: WAN Toll Free

1-866-674-6626 or

408-542-5390

Hours: 6:00 AM to 5:00 PM M-F Pacific Time

LAN Toll Free

1-866-674-6626 Hours: 24x7

### **International Customers**

Call Technical Support:

WAN 408-542-5390

Hours: 6:00 AM to 5:00 PM M-F Pacific Time

LAN 408-542-5390 Hours: 24x7

**Search Knowledgebase:** <http://support.proxim.com/>

**Latest software and documentation:** <http://support.proxim.com/>

## WARRANTY AND REPAIR

If it appears that your unit needs a repair or replacement, return the unit to your Dealer or Distributor in its original packaging. When returning a defective product for Warranty, always include the following documents:

- The Warranty Repair card (last page of this appendix)
- A copy of the invoice or proof of purchase
- Problem Report Form

Proxim Wireless Corporation extends a limited warranty from date of purchase of:

- Twelve (12) months for the MP.11a and 5054-R hardware
- Twelve (12) months for the media on which the software is furnished and the reproduction of the software on the media.

Upon proof-of-purchase Proxim Wireless Corporation shall, at its discretion, repair or replace the defective item at no cost to the buyer.

Defective items shall be returned to the dealer or distributor:

- Freight prepaid.
- Accompanied by a copy of proof-of-purchase.
- Accompanied by a filled out Warranty and Repair card.

This warranty is contingent upon proper use in the application for which the products are intended and does not cover products which have been modified without the seller's approval or which have been subjected to unusual physical or electrical demands or damaged in any way.

This Warranty constitutes the sole and exclusive remedy of any buyer or seller's equipment and the sole and exclusive liability of Proxim Wireless Corporation in connection with the products and is in lieu of all other warranties, express, implied or statutory, including, but not limited to, any implied warranty of merchantability of fitness for a particular use and all other obligations or liabilities of Proxim Wireless Corporation.

In no event will Proxim Wireless Corporation or any other party or person be liable to you or anyone else for any damages, including lost profits, lost savings or other incidental or consequential damages, or inability to use the software provided on the software media even if Proxim Wireless Corporation or the other party person has been advised of the possibility of such damages.

**TO BE FILLED OUT BY USER:**

Product Description \_\_\_\_\_

COMCODE (Product ID) \_\_\_\_\_

Serial Number \_\_\_\_\_

Invoice Date (mm/dd/yyyy): \_\_\_\_\_

Name: \_\_\_\_\_

Title \_\_\_\_\_

Company \_\_\_\_\_

Address \_\_\_\_\_

City/State/Zip Code \_\_\_\_\_

Country \_\_\_\_\_

Telephone \_\_\_\_\_

Fax \_\_\_\_\_

*TO BE FILLED OUT BY THE DEALER OR DISTRIBUTOR*

Dealer Name \_\_\_\_\_

City/State/Zip Code \_\_\_\_\_

Country \_\_\_\_\_

Telephone \_\_\_\_\_

Fax \_\_\_\_\_

Warranty (Yes / No) \_\_\_\_\_

Comment \_\_\_\_\_

Return Approval Reference \_\_\_\_\_

Reported Problem	Problem Description

## Free Manuals Download Website

<http://myh66.com>

<http://usermanuals.us>

<http://www.somanuals.com>

<http://www.4manuals.cc>

<http://www.manual-lib.com>

<http://www.404manual.com>

<http://www.luxmanual.com>

<http://aubethermostatmanual.com>

Golf course search by state

<http://golfingnear.com>

Email search by domain

<http://emailbydomain.com>

Auto manuals search

<http://auto.somanuals.com>

TV manuals search

<http://tv.somanuals.com>