

SANYO

VCC-5775P

INSTRUCTION MANUAL BEDIENUNGSANLEITUNG MANUEL D'INSTRUCTIONS 使用说明书

COLOUR CCD camera
CCD-Farbkamera
Caméra CCD COULEUR
彩色CCD摄像机

About this manual

Before installing and using the camera, please read this manual carefully. Be sure to keep it handy for later reference.

Über diese Bedienungsanleitung

Lesen Sie bitte vor der Montage und dem Inbetriebnehmen der Kamera zuerst diese Bedienungsanleitung sorgfältig durch und bewahren Sie sie zum späteren Nachschlagen auf.

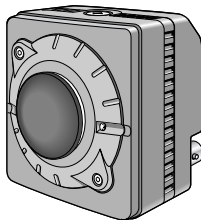

A propos de ce manuel

Avant d'installer et d'utiliser la caméra, veuillez lire ce manuel attentivement. Gardez-le à portée de main pour toute référence ultérieure.

关于本说明书

在安装和使用摄像机之前，请仔细阅读本使用说明书，并务必保存好本使用说明书，以备今后查阅。

Download from [Www.Somanuals.com](http://www.Somanuals.com). All Manuals Search And Download.

Depending on the conditions of use, installation and environment, please be sure to make the appropriate settings and adjustments. If you need help with installation and/or settings, please consult your dealer.

CONTENTS

PRECAUTIONS	3
PARTS NAMES	5
MOUNTING THE LENS.....	7
CONNECTIONS.....	9
FLANGE-BACK ADJUSTMENT	11
SETTINGS	12
TROUBLESHOOTING	15
SPECIFICATIONS.....	16
ACCESSORIES.....	18

FEATURES

- Built-in interline transfer method 1/3" CCD, approx. 470,000 picture elements
- Low smear, anti-blooming, low lag, no burning and no geometric distortion using the CCD solid state image device.
- 100% solid state components giving excellent immunity to shock and vibration
- Not subject to interference from magnetic or electrostatic fields
- High sensitivity, minimum required illumination is 1.4 lux (F1.2)
- Horizontal resolution, more than 480 TV lines
- Equipped with connectors for AC 24 V and DC 12 V power supply.

PRECAUTIONS

■ In case of problem

Do not use the camera if smoke or a strange odour comes from the unit, or if it seems not to function correctly. Disconnect the power cord immediately, and consult your dealer (or a Sanyo Authorized Service Centre).

■ Do not open or modify

Do not open the cabinet, as it may be dangerous and cause damage to the unit. For internal settings and repairs, consult your dealer (or a Sanyo Authorized Service Centre).

■ Do not put objects inside the unit

Make sure that no metal objects or flammable substance get inside the camera. If used with a foreign object inside, it could cause a fire, short-circuits or damages.

If water or a liquid gets inside the camera, disconnect the power cord immediately, and consult your dealer (or a Sanyo Authorized Service Centre). Be careful to protect the camera from rain, sea water, etc.

■ Be careful when handling the unit

To prevent damages, do not drop the camera or subject it to strong shock or vibration.

■ Install away from electric or magnetic fields

If installed close to a TV, radio transmitter, magnet, electric motor, transformer, audio speakers the magnetic field they generate will distort the image.

■ Protect from humidity and dust

To prevent damages to the camera, do not install it where there is greasy smoke or steam, where the dampness may get too high, or where there is a lot of dust.

PRECAUTIONS

■ Protect from high temperatures

Do not install close to stoves, or other heat generating devices, such as spotlights, etc., or where it could be subject to direct sunlight, as that could cause deformation, discoloration or other damages.

Be careful when installing close to the ceiling, in a kitchen or boiler room, as the temperature may raise to high levels.

Install where the temperature range will stay between -10°C and 50°C .
(no condensation)

■ Cleaning

- Dirt can be removed from the cabinet by wiping it with a soft cloth. To remove stains, wipe with a soft cloth moistened with a soft detergent solution and wrung dry, then wipe dry with dry soft cloth.
- Do not use benzine, thinner or other chemical product on the cabinet, as that may cause deformation and paint peeling. Before using a chemical cloth, make sure to read all accompanying instructions. Make sure that no plastic or rubber material comes in contact with the cabinet for a long period of time, as that may cause damage or paint peeling.

PARTS NAMES

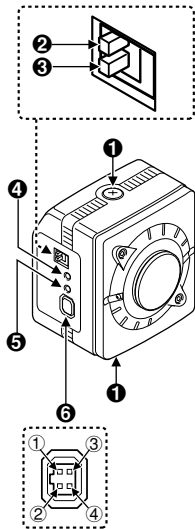

❶ Camera mounting screw hole

CAUTION:

When installing the camera, select a location that can support the total weight of the camera and accessories.

❷ Electronic iris function switch (EI OFF/EI ON)

❸ Sync switch (INT/L-L)

INT (Internal sync) position

L-L (Line lock) position

❹ Line phase adjustment volume (LINE PHASE)

❺ Lens iris level volume (LEVEL)

❻ Lens iris output connector (LENS)

This 4-pin connector is used to send the DC control signal and power supply to an auto-iris type lens.

PARTS NAMES

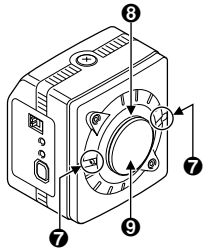

7 Flange-back lock screw

8 CS mount ring

9 Lens mount cap

The cap is installed to protect the lens mount section.

Remove the lens mount cap before installing a lens.

10 Video output connector (VIDEO OUT: BNC type)

Connect this connector to a device such as a VCR or monitor with a VIDEO IN connector.

11 24 V AC or 12 V DC input terminal
(24 V AC, 12 V DC, GND) ... See page 9

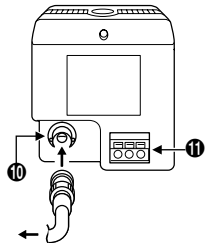

MOUNTING THE LENS

Please use a DC type auto-iris lens (sold separately).

Checking the lens mount

Do not use lens with a length **L** more than **5 mm**. If not, that may damage the camera and prevent proper installation.

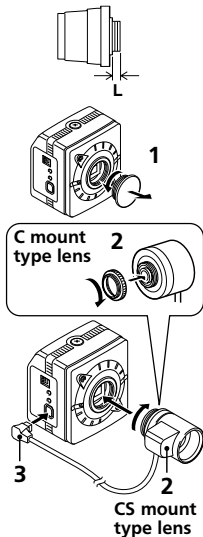

1 Remove the lens mount cap from the camera.

2 Install the auto-iris lens.

CS mount type lens

Carefully align the lens mount with the camera opening, then turn the lens slowly to install it.

C mount type lens

Install the supplied C-mount adaptor on the lens mount, then carefully align the lens mount with the camera opening and turn the lens slowly to install it.

3 Connect the lens plug to the lens iris output connector (LENS) on the side of the camera.

The plug shape may not correspond to the terminal on the camera. In such a case, remove the original plug and using a soldering iron, connect the supplied **lens iris plug** according to the diagram. (Refer to page **8**.)

MOUNTING THE LENS

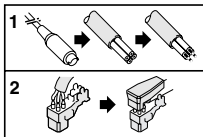

■ Rewiring the lens cable in the lens iris plug

1 Prepare the lens cable.

Cut the cable at the plug, then remove approx. 8 mm of the cable sheath and strip about 2 mm from each wire.

2 Install the lens iris plug.

Solder the cable to the pins following the correct pin layout (refer to the table and illustrations), then close the plug cover.

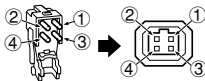

■ Compatible auto-iris lenses (1/3 inch COSMICAR DC type lens)

- Standard angle, $f = 8$ mm (TS812E Equivalent)
- Wide angle, $f = 4$ mm (TS412E Equivalent)
- Ultra-wide angle, $f = 2.8$ mm (TS212E Equivalent)

Pin layout

①	Brake coil (-)
②	Brake coil (+)
③	Drive coil (+)
④	Drive coil (-)

CONNECTIONS

Basic connection for monitoring or recording

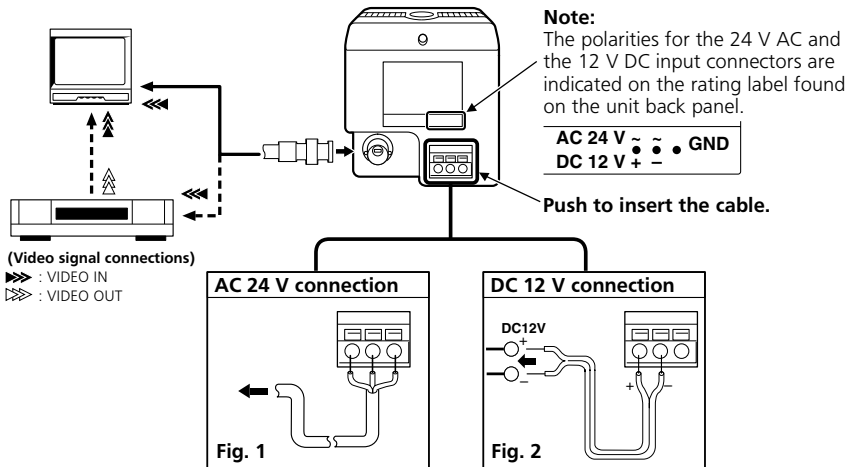

CONNECTIONS

The peripheral devices (VCR, monitor, lens, etc.) and cables are sold separately.

1 Make the video signal connection between the camera and the monitor or timelapse VCR.

2 Power supply choices

- Use a commercially available 24 V AC adaptor. Make sure to use a cable with an earth line (22AWG or more) to connect to the earth connector. (**Fig.1.**)
- When using a DC 12 V power supply, make the connections as indicated in **Fig. 2.**

CAUTION:

To prevent camera and/or power supply failure, pay close attention to polarity when making the connections.

3 Insert the plug of this power supply into a wall outlet.

Adjust the picture on the monitor using the Brightness and Contrast controls.

■ **Coaxial cable type and maximum length**

- Cable type RG-59U (3C-2V), 250 m maximum.
- Cable type RG-6U (5C-2V), 500 m maximum.
- Cable type RG-11U (7C-2V), 600 m maximum.

Note: Use CCTV/Video-grade coaxial cable.

FLANGE-BACK ADJUSTMENT

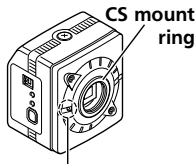

Flange-back lock screw

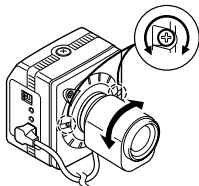

If the pick-up surface is not correctly positioned with relation to the lens focal point, the picture will be out of focus (**in particular when using auto-iris power zoom lenses, sold separately**). If that is the case, adjust the flange-back position as described below.

- 1** Before installing the lens, check that the two **flange-back lock screws** have been tightened.

If the **flange-back lock screws** are loose, the CS mount ring will not be secured and it will not be possible to adjust the flange-back.

- 2** Fully install the lens, then loosen the two **flange-back lock screws**.
- 3** Set the zoom lens to the maximum telephoto position (TELE), then set the focus using the focus ring on the lens.
- 4** Set the zoom lens to the maximum wide angle position (WIDE), then set the focus by turning the CS mount ring.
- 5** Repeat steps **3** and **4** until the image stays in focus when changing from a telephoto shot to a wide angle shot. When the setting is complete, tighten the **flange-back lock screws**.

SETTINGS

■ Line phase adjustment

When using a camera switcher to connect 2 cameras or more to one monitor, there may be a vertical roll of the images when switched. In such a case, set as described below.

- 1 Set the **Sync** switch to the **L-L** position.
- 2 Switch the display on the monitor from camera 1 to camera 2.

Adjust the **LINE PHASE** volume on camera 2 until the vertical roll of the image stops.

If more than two cameras are used, please repeat this procedure for all the cameras.

CAUTION:

If the vertical roll cannot be corrected by setting the **LINE PHASE** volume on camera 2, try setting the **LINE PHASE** volume on camera 1. If it still cannot be corrected, please check that the polarity of the power cords of all connected devices is correct.

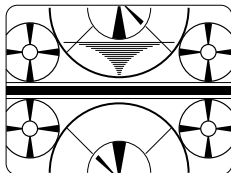

(Monitor)

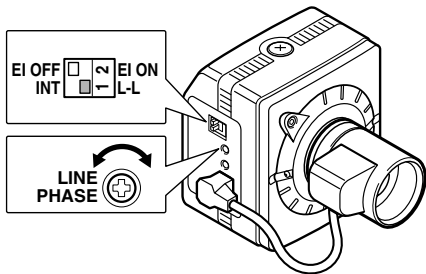

SETTINGS

■ Lens iris adjustment

If using a DC type auto-iris lens, you will need to set the **LEVEL** volume when shooting in the conditions described below.

Counterclockwise: To decrease the brightness

Clockwise: To increase the brightness

- If shooting simultaneously in a dark room and through a bright window.
- If the subject background is extremely bright or dark.
- If the brightness of the picture on the monitor is not correct.

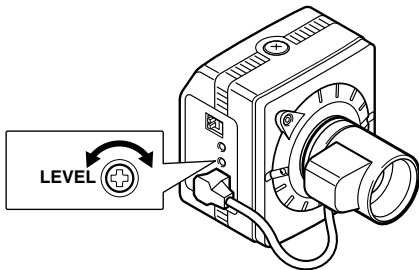

SETTINGS

■ EI (Electronic iris) function setting

Under normal conditions, set the **EI** switch to the **EI OFF** position and use an auto-iris lens. However, if you have a manual lens or fixed iris lens, set the lens aperture to the shortest F stop and set the **EI** switch to the **EI ON** position.

Note:

Please refer to the specifications for dynamic range of the electronic iris.

CAUTION:

- The electronic iris is suitable for normal indoor use. When the **EI** switch is set to the **EI ON** position, do not use an auto-iris lens.
- If used under fluorescent light, the image may flicker. In such a case, change to incandescent lighting or set the **EI** switch to the **EI OFF** position and use an auto-iris lens.
- When shooting bright subjects, pay attention to the light angle in order to avoid or minimize the smear phenomenon effect.

- If conditions are outside the electronic iris operation range or more than the maximum brightness, it will cause saturation of the CCD. In that case, use a auto iris lens.

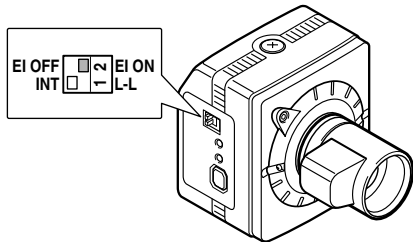

TROUBLESHOOTING

Before taking the camera for repairs, please check below to make sure that the camera is used correctly. If it still does not perform correctly, please consult your dealer or a Sanyo Authorized Service Centre.

■ No picture on the monitor screen

- Is the power turned on to all connected devices?
Is the voltage correct?
- Are all the signal connecting cables correctly connected?
- Is the lighting sufficient?
- Has the lens cap been removed?
- Is the iris control correctly set?

■ The picture is not clear

- Is the monitor correctly adjusted?
- Is the flange-back position correctly set?
- Is the lens focus correctly adjusted?
- Are the lens surfaces clean?

If there is dust or finger prints on the lens, the image quality will deteriorate. To clean the lens use a soft cloth or a commercially available lens cleaning set.

SERVICE

This camera is a precision instruments and if treated with care, will provide years of satisfactory performance. However, in the event of a problem, the owner is advised not to attempt to make repairs or open the cabinet. Servicing should always be referred to your dealer or Sanyo Authorized Service Centre.

SPECIFICATIONS

- Scanning system:** PAL standard
(625 TV lines, 25 frames/sec.)
- Interlace:** 2:1 interlace
- Image device:** 1/3 inch solid state image device CCD
- Picture elements:** 798 (H) x 584 (V)
- Effective picture elements:** 753 (H) x 582 (V)
- Synchronizing system:** Manual internal sync/
Line lock switching
- Resolution:** 480 TV lines horizontally,
400 TV lines vertically
- Video output level:** 1.0 Vp-p/75 ohms, composite
- Video S/N ratio:** More than 48 dB
- Minimum required illumination
(incandescent lighting):**
Approx. 1.4 lux with a F 1.2 lens
- Backlight compensation:** ON condition only
- Electronic iris function:** Manual ON/OFF switching

- Electronic iris range:**
1.4 lux to 70,000 lux (F 1.2, lens)
2.0 lux to 100,000 lux (F 1.4, lens)
- Flange-back:** 12.5 mm \pm 0.5 mm
- White balance:** ATW
- Lens mount:** CS mount
- Environmental conditions:**
Temperature: $-10^{\circ}\text{C} \sim +50^{\circ}\text{C}$
Humidity: less than 90% (no condensation)
- Power supply:** 24 V AC or 12 V DC
- Power consumption:**
24 V AC, 50 Hz: 3.2 W (with auto-iris lens)
2.5 W (without auto-iris lens)
12 – 15 V DC: 4.0 W (with auto-iris lens)
2.7 W (without auto-iris lens)
- Weight:** Approx. 160 g (without lens)

SPECIFICATIONS

■ Dimensions: mm

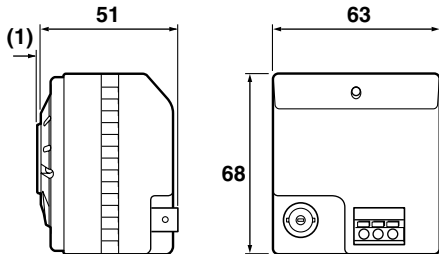

Features and specifications are subject to change without prior notice or obligations.

ACCESSORIES

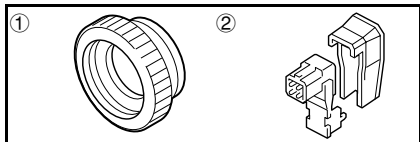

- ① C mount adaptor (5 mm)1 pc.
The C mount adaptor must be used to be able to install a C mount lens on the camera.
- ② Lens iris plug (4-pin).....1 pc.

1AC6P1P2347--
L53V2/XE(0700KP-DSP)

SANYO

Sanyo Electric Co, Ltd.

Printed in Japan

Download from [Www.Somanuals.com](http://www.Somanuals.com). All Manuals Search And Download.

Free Manuals Download Website

<http://myh66.com>

<http://usermanuals.us>

<http://www.somanuals.com>

<http://www.4manuals.cc>

<http://www.manual-lib.com>

<http://www.404manual.com>

<http://www.luxmanual.com>

<http://aubethermostatmanual.com>

Golf course search by state

<http://golfingnear.com>

Email search by domain

<http://emailbydomain.com>

Auto manuals search

<http://auto.somanuals.com>

TV manuals search

<http://tv.somanuals.com>