



Proxima Desktop Projector 5500 User's Guide

Final 06/21/96





Warranty

Proxima Corporation warrants that the Proxima® Desktop Projector™ product manufactured by Proxima is free from defects in materials and workmanship under normal use during the Warranty Period. The Warranty Period commences on the day of purchase by the end-user. The Warranty Period is one year. The Projector lamp not covered by this Warranty.

Each Proxima product is manufactured from new parts, or new and some used parts. In some cases, the product may have been delivered to another end-user and then returned. In all cases, the product has undergone testing and quality inspection, meets all of Proxima's requirements for a new product, and our full warranty terms apply.

The end-user's sales receipt or invoice showing the date of purchase of the product and the name of the Reseller is proof of date of purchase. The Warranty extends only to the original purchaser and is not transferable.

During the Warranty Period, Proxima will, at no additional charge, repair or replace defective parts or at the option of Proxima, replace the entire unit.

This limited Warranty does not extend to any Proxima product that has been damaged or been rendered defective (a) as a result of accident, misuse or other abuse; (b) by the use of parts not manufactured or sold by Proxima; (c) by modification of the product; or (d) as a result of servicing by non-authorized personnel.

Limitation of Warranties

The foregoing Warranty is expressly in lieu of any other expressed or implied warranties, including, without limitation, warranties of merchantability or fitness for a particular purpose. To the extent not prohibited by law, all statutory warranties are hereby waived and excluded from this Warranty. Proxima expressly disclaims all warranties not stated in this Limited Warranty.

FCC Statement

Warning: This equipment generates, uses and can radiate radio frequency energy and, if not installed and used in accordance with the instruction manual, may cause interference to radio communications. It has been tested and found to comply with limits for a Class "A" computing device pursuant to Subpart B of Part 15 of the FCC Rules, which are designed to provide reasonable protection against such interference when operated in a commercial environment. Operation of this equipment in a residential area is likely to cause interference in which case the user, at his own expense, will be required to take whatever measures may be necessary to correct the interference.

Trademarks, Patents, and Copyright

Proxima and Cyclops are registered trademarks of Proxima Corporation. Desktop Projector and Desktop Projection are trademarks of Proxima Corporation. Other trademarks are the property of their respective owners.

© 1996 Proxima Corporation. All rights reserved. Specifications are subject to change without notice.



Contents

Chapter 1

Your Proxima Desktop Projector 5500

What's in the Box?	1-2
Quick Start	1-3
Connector Panel	1-5
Control Panel	1-6
Options and Accessories	1-6

Chapter 2

Setting Up the Desktop Projector 5500

Your DP5500	2-1
Getting Started	2-2
Connector Panel	2-5
Connecting Power to the Projector	2-6
Connecting Computer Video	2-6
Connecting Computer Audio	2-10
Connecting Composite Video	2-11
Connecting an S-Video Source	2-11
Connecting Non-Computer Audio	2-12

Chapter 3

Using the Desktop Projector 5500

Turning on the Projector and Lamp	3-1
Focusing and Zooming the Image	3-2
Turning off the Projector	3-2
Control Panel Keys	3-3
Control Panel Indicators	3-4
Using the Remote Control	3-6
Using the Joystick	3-8
Operating the Projector	3-8
The Graphical User Interface	3-9
Using the Main Menu	3-10
Setup Menu	3-11
Input Menu	3-12
Image Menu	3-13
Option Menu	3-14
Quick Menus	3-16



Chapter 4

Maintenance

Cleaning the Lens	4-1
Replacing the Lamp	4-2
Cleaning the Air Filter	4-4
Changing the Remote Control's Batteries	4-5

Chapter 5

Troubleshooting

Where to get Help	5-1
Returning your DP5500 for Repair	5-5
Ordering Parts	5-5

Appendix A

Specifications

DP5500 Specifications	A-1
-----------------------------	-----

Appendix B

Replacement Parts and Accessories

Replacement Parts	B-1
Optional Accessories	B-1

Index



Chapter 1

Your Proxima Desktop Projector 5500

The Proxima® Desktop Projector™ family consists of portable, color data and video Desktop Projection™ products that make sharing data and presenting information as easy as connecting your computer to your monitor.

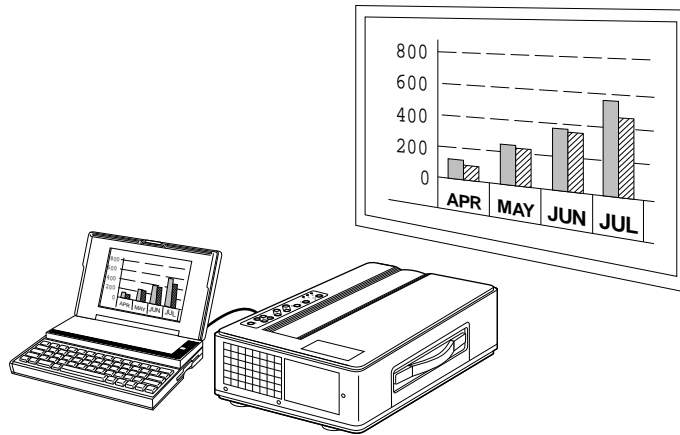

Figure 1-1 The Proxima DP5500 in use

This manual covers the Desktop Projector 5500, which provides images of unrivaled brightness, clarity, and color accuracy.



WHAT'S IN THE BOX?

After you've opened the box and removed the DP5500 and accessory packs, make sure you have all of the items shown in Figure 1-2.

CAUTION! *The DP5500 should be treated like any other precision optical instrument. Handle it carefully.*

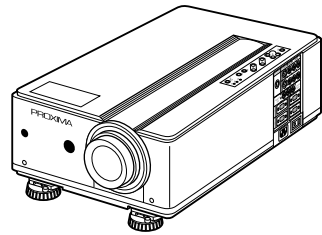

Proxima
Desktop Projector



Remote Control



Power Cords

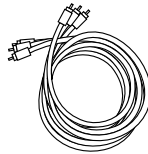

AV Cable

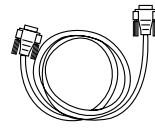

VGA Video Cable

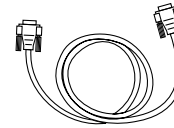

Serial Cable

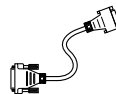

Mac - VGA
Cable Adapter

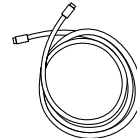

S-Video Cable

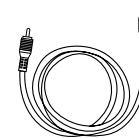

Mini-stereo to Mini-stereo Cable

Also included but not shown:

- (2) AAA Alkaline Batteries
- User's Guide
- Product Registration Card

Figure 1-2 Items included with the DP5500

Your projector also includes power cords for Europe and Great Britain.



QUICK START

Place the DP5500 on a solid flat surface at a right angle (perpendicular) to the projection screen, parallel to the floor. Follow the appropriate section below for the type of system that you have. These steps are described in detail in Chapter 2.

NOTE: The DP5500 has two sets of computer video and audio inputs. The following examples describe how to use INPUT 1.

Desktop PCs

- 1 Unplug the monitor cable from the computer.
- 2 Plug one end of the supplied VGA cable into the RGB 1 IN port on the projector. Plug the other end into the computer's Monitor Out port.
- 3 Connect your audio source to the AUDIO 1 IN port on the projector using the AV cable.
- 4 You can project with or without a PC monitor. To use the monitor, plug the monitor cable into the RGB OUT port on the projector.
- 5 Turn the projector on and press the STANDBY/ON key.

NOTE: An external monitor is not needed to use the DP5500.

Desktop Macintosh Computers

- 1 Unplug the monitor cable from the computer.
- 2 Plug one end of the supplied VGA video cable into the RGB IN 1 port on the projector. Attach the VGA end of the Mac - VGA cable adapter to the other end of the VGA video cable.
- 3 Plug the Mac end of the Mac - VGA cable adapter into your computer's Video port.
- 4 Connect your audio source to the AUDIO 1 IN port on the projector using the AV cable.
- 5 To project and view the monitor at the same time, plug your monitor cable into the RGB OUT port of the projector.

NOTE: The DP5500 only supports Multi-Sync monitors for Macintosh computers. Other monitors cannot be used.



6 Turn the projector on and press the STANDBY/ON key.

NOTE: If you turn the projector off while the computer is running, the external monitor will go blank. This is normal. Just turn the projector back on, and the monitor display will return.

Notebooks

NOTE: If you are connecting to an Apple PowerBook, attach the Mac - VGA cable adapter to the computer's Video Out port (or video adapter cable).

- 1 Plug the COMPUTER end of the VGA Video cable into the notebook's VGA Out port or into the Mac - VGA cable adapter (Macintosh only).
- 2 Plug one end of the VGA Video cable into the RGB IN 1 port on the projector.
- 3 Connect your audio source to the AUDIO 1 IN port on the projector.
- 4 Turn on the projector and press the STANDBY/ON key.

Special Configurations

If your computer has an internal monitor but no external video capability (such as the Macintosh Performa 575, PowerMac 5200, and certain PowerBooks), you need a video adapter card in order to attach the DP5500.

Setup for a third-party adapter is identical to the procedures outlined in the *Quick Start* section above. Contact your dealer, Proxima Customer Service, or a third-party supplier for more information about an appropriate video adapter.



CONNECTOR PANEL

All connections between the DP5500 and your computer or video source are made on the side connector panel.

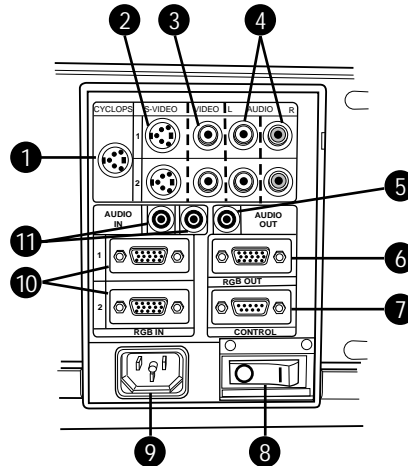

Figure 1-3 The Connector Panel

CONNECTOR	DESCRIPTION
1 CYCLOPS Port	Connects your computer to the Cyclops Interactive Pointer System.
2 S-VIDEO 1 & 2	Connects to an S-Video source.
3 VIDEO 1 & 2	Connects to video output from an NTSC, PAL, or SECAM source.
4 L-AUDIO-R 1 & 2	Connects to stereo/mono audio output from an NTSC, PAL, or SECAM source.
5 AUDIO OUT	Provides audio output to an external stereo system.
6 RGB OUT	Provides computer output to a separate monitor.
7 CONTROL	Connects to a serial cable for computer control.
8 POWER SWITCH	Turns power on and off.
9 POWER RECEPTACLE	For AC power cord connection.
10 RGB IN 1 & 2	Connects computer video to the projector.
11 AUDIO IN 1 & 2	Connects to stereo/mono audio output from a computer.



CONTROL PANEL

Use the DP5500's control panel keys to turn the projector on or off, adjust the projected image, and to display and hide the menus. Power, warning, and alert lights give you important information about how your projector is working.

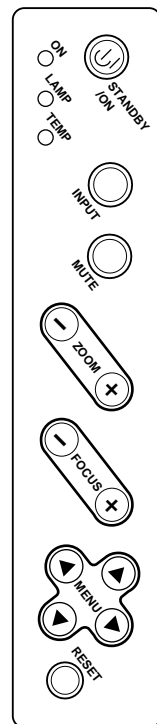

KEY	FUNCTION
STANDBY/ON	Turns the lamp on or off.
INPUT	Switches the video inputs.
MUTE	Turns the Audio on or off.
ZOOM +/-	Zooms in and out.
FOCUS +/-	Adjusts the focus.
MENU	Controls the menu.
RESET	Resets the image to the factory defaults.
INDICATOR	FUNCTION
ON	Flashes green during start-up. Glowes green if AC input and projector power supplies are functioning. Glows red if they are not, or if the air filter door is removed.
TEMP	Glowes red to warn of an over-temperature condition. Flashes red if the fan is not working.
LAMP	Glowes red if the projection lamp burns out.

Figure 1-4 The DP5500 Control Panel

OPTIONS AND ACCESSORIES

The Cyclops Interactive Pointer system

The Proxima Cyclops® interactive pointer system uses a built-in camera to function like a cordless mouse. With the Cyclops system, you can control your computer's cursor on the projected image by moving the hand-held wand or optional hand-held laser pointer.



Chapter 2

Setting Up the Desktop Projector 5500

YOUR DP5500

Before you begin, locate the main parts of the DP5500.

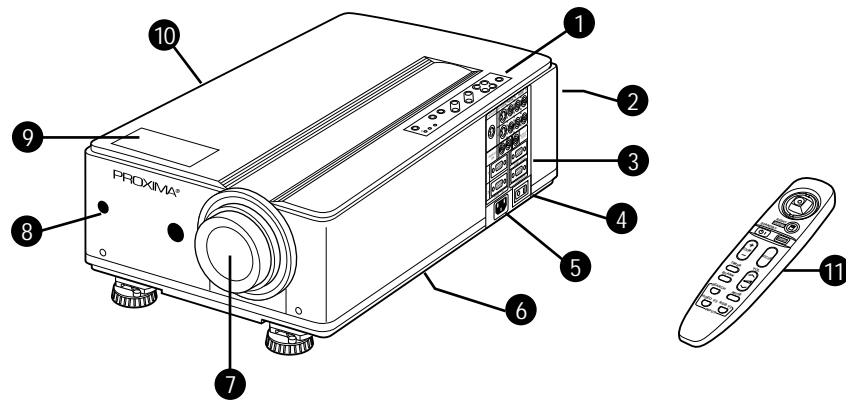

Figure 2-1 The Proxima DP5500 and Cyclops Remote Control

- | | |
|--------------------------|---------------------|
| 1. Control panel | 7. Projection lens |
| 2. Rear exhaust | 8. Infrared lens |
| 3. Connector panel | 9. Internal speaker |
| 4. AC power switch | 10. Handle |
| 5. Power cord receptacle | 11. Remote control |
| 6. Bottom intake filter | |



GETTING STARTED

Positioning the Projector

Place the projector on a solid, flat surface at a right angle (perpendicular) to the projection screen and parallel to the floor. If you're using a media cart, make sure the wheels are locked to prevent it from moving.

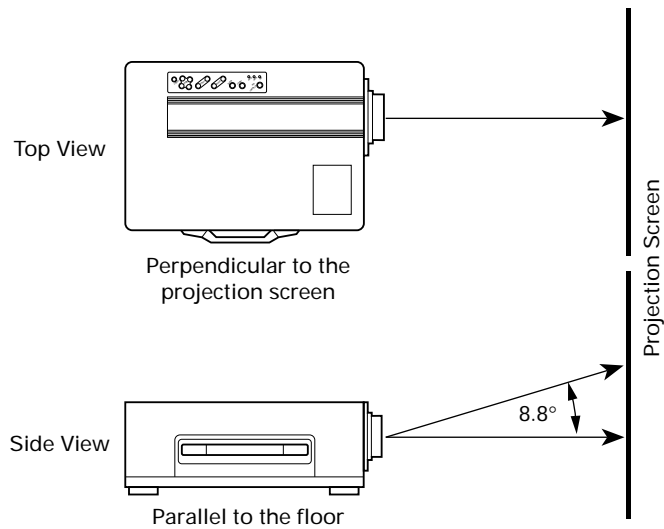

Figure 2-2 Positioning the projector



Transporting and Moving the Projector

The projector has a recessed handle on one of the side panels. Always use the handle to transport it. The projector has protective feet on the side opposite the handle, as well as on the bottom.

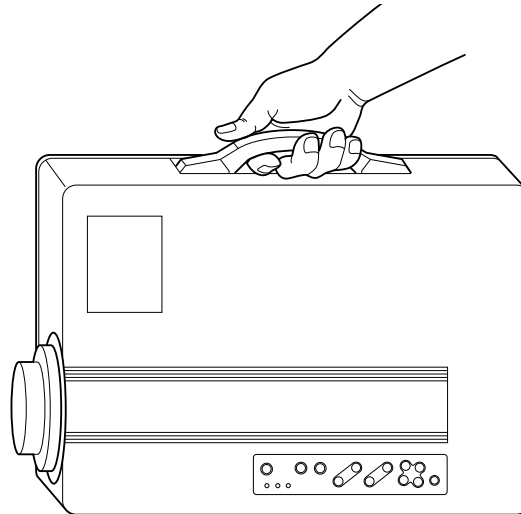

Figure 2-3 Transporting the projector

If you are moving the projector a short distance, grasp it securely at the sides by the lower parts of the housing to support the weight of the unit.

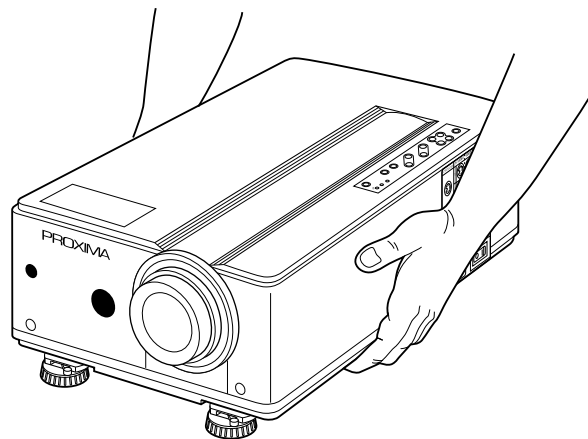

Figure 2-4 Moving the projector



Projector Cooling and Airflow

The air intake grill is on the bottom of the projector. The air exhaust grill is on the rear panel.

⚠ CAUTION! *Never operate the projector if these grills are clogged or obstructed, or if the electric fans are not running.*

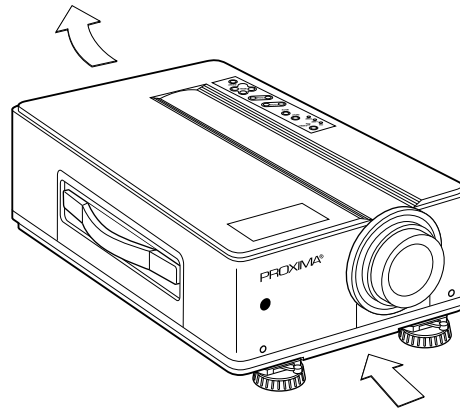

Figure 2-5 Allow for proper air flow



CONNECTOR PANEL

All connections between the projector and your computer or video source are made on the side connector panel.

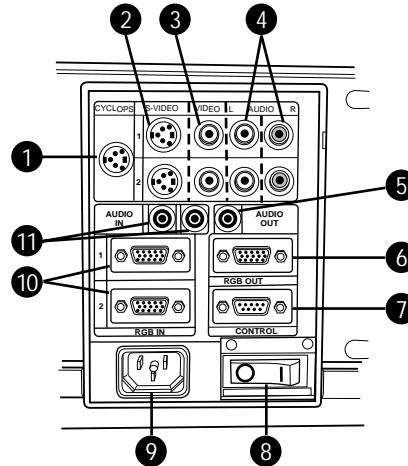

Figure 2-6 The Connector Panel

CONNECTOR	DESCRIPTION
1	CYCLOPS Port Connects your computer to the Cyclops Interactive Pointer System.
2	S-VIDEO 1 & 2 Connects to an S-Video source.
3	VIDEO 1 & 2 Connects to video output from an NTSC, PAL, or SECAM source.
4	L-AUDIO-R 1 & 2 Connects to stereo/mono audio output from an NTSC, PAL, or SECAM source.
5	AUDIO OUT Provides audio output to an external stereo system.
6	RGB OUT Provides computer output to a separate monitor.
7	CONTROL Connects to a serial cable for computer control.
8	POWER SWITCH Turns power on and off.
9	POWER RECEPTACLE For AC power cord connection.
10	RGB IN 1 & 2 Connects computer video to the projector.
11	AUDIO IN 1 & 2 Connects to stereo/mono audio output from a computer.



CONNECTING POWER TO THE PROJECTOR

The power cord receptacle and AC POWER switch are located below the projector's connector panel.

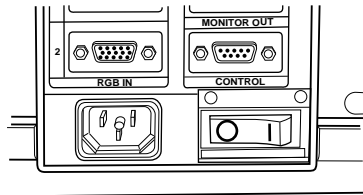

Figure 2-7 Power receptacle and AC Power switch

- 1 Plug the appropriate power cord for your location into the power receptacle on the side of the projector.
- 2 Connect the power cord to a properly-grounded wall outlet.

CONNECTING COMPUTER VIDEO

Connecting a PC

Use the included VGA video cable to connect your PC to the projector. If you want to use your monitor and DP5500 at the same time, use your existing monitor cable to connect the projector to a separate monitor.

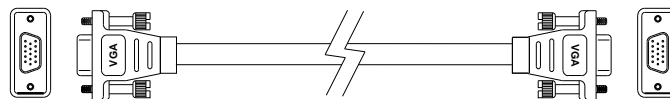

VGA Connector Cable

Figure 2-8 VGA Video cable

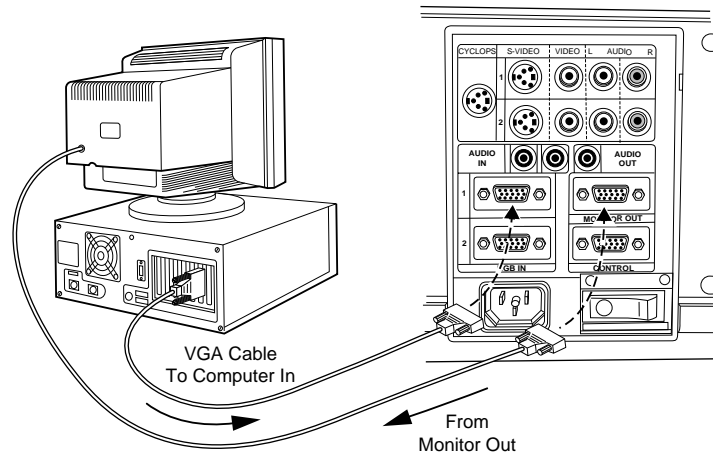

Figure 2-9 VGA connections

- 1 Unplug the monitor cable from the computer.
- 2 Plug one end of the supplied VGA cable into the RGB IN 1 port on the projector. Plug the other end of the VGA cable into the computer's Video Out (VGA) port.
- 3 Connect your audio source to the AUDIO IN 1 port on the projector (see page 2-10).

NOTE: If you are using a second computer video or audio source, plug their outputs into the RGB IN 2 and AUDIO IN 2 connectors.

- 4 If you want to use an external monitor, connect the monitor cable to the RGB OUT port of the projector.
- 5 Turn the projector on and press the STANDBY/ON key.

NOTE: An external monitor is not required to use the DP5500.



Connecting Macintosh Computers

Use the video adapter cable shown below to connect a Macintosh computer to the DP5500.

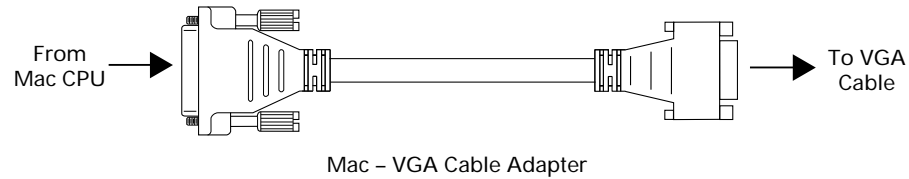

Figure 2-10 The Macintosh adapters

Use the cable adapter and supplied VGA video cable to connect the projector to your Macintosh computer.

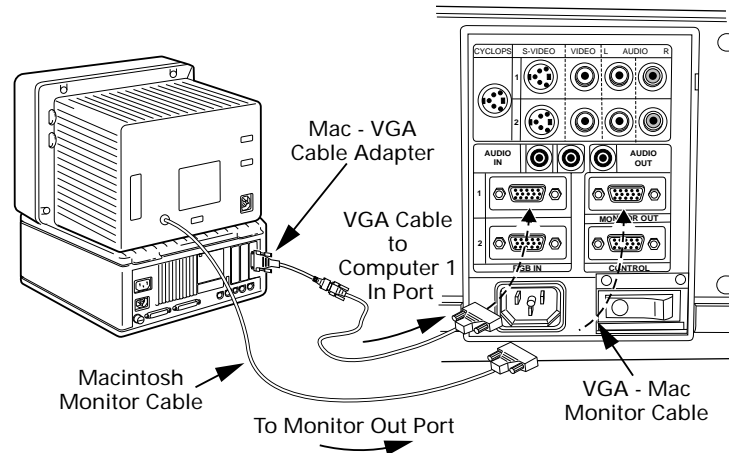

Figure 2-11 Macintosh connections

- 1 Unplug the Macintosh monitor cable from the computer.
- 2 Plug one end of the supplied VGA video cable into the RGB IN 1 port on the projector. Attach the VGA end of the Mac - VGA cable adapter to the other end of the VGA video cable.
- 3 Plug the Mac end of the Mac - VGA cable adapter into the Macintosh video port.
- 4 Connect the audio source to the projector's AUDIO IN 1 port (see page 2-10).

NOTE: If you are using a second computer video or audio source, plug their outputs into the RGB IN 2 and AUDIO IN 2 connectors.





Use your existing monitor cable to connect the projector to a separate computer monitor, so you can use the projector and monitor at the same time.

NOTE: The DP5500 only supports Multi-Sync monitors for Macintosh computers. Other monitors cannot be used.

5 Turn the projector on and press the STANDBY/ON key.

NOTE: An external monitor is not required to use the DP5500.

Connecting Notebook Computers

Use the appropriate cable and adapter to connect your portable computer to the projector.

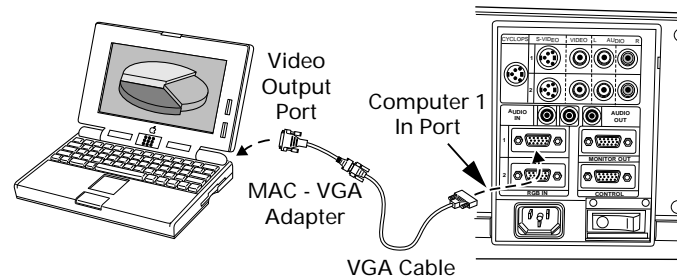

Figure 2-12 Laptop connections

NOTE: If you are connecting to an Apple PowerBook, attach the Mac - VGA cable adapter to the computer's VIDEO OUTPUT port (or video adapter cable).

- 1 Plug the COMPUTER end of the VGA cable into the computer's VGA or Video Out port or into the Mac - VGA cable adapter (Macintosh only).
- 2 Plug one end of the supplied VGA cable into the RGB IN 1 port on the projector.
- 3 Connect your audio source to the AUDIO IN 1 port on the projector.
- 4 Turn the projector on and press the STANDBY/ON key.

NOTE: If your projector won't project an image at the same time as your laptop monitor, refer to your laptop documentation for information on switching between the internal screen and the video port.



Special Configurations

If your computer has an internal monitor but no external video capability (Macintosh Performa 575, PowerMac 5200, and certain PowerBooks), you need a separate video adapter card in order to attach the DP5500.

Setup for a third-party adapter is identical to the procedures outlined in the *Quick Start* section in Chapter 1. Contact your dealer, Proxima Customer Service, or a third-party supplier for more information about an appropriate video adapter.

CONNECTING COMPUTER AUDIO

The AUDIO IN 1 and 2 ports allow audio input from two separate computers or microphones.

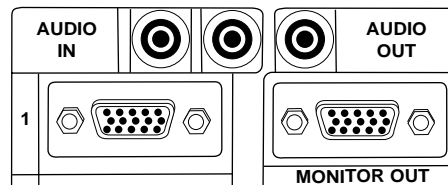

Figure 2-13 Computer 1 & 2 Audio ports

- 1 Insert one mini jack end of the Computer Audio cable into the AUDIO OUT port of a Macintosh or the sound card of a PC.
- 2 Insert the mini-jack at the other end of the AV cable into the projector's AUDIO 1 or 2 ports.

NOTE: Although two COMPUTER AUDIO sources and two other AUDIO sources may be connected simultaneously, only one can be active. If computer video is selected, COMPUTER AUDIO is active. If NTSC, PAL, SECAM, or S-VHS video are being viewed, the L-AUDIO-R are active.



CONNECTING COMPOSITE VIDEO

You can display composite video (NTSC, PAL or SECAM) on the DP5500.

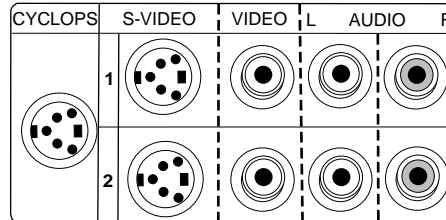

Figure 2-14 Video 1 & 2 ports

Use the supplied AV cable (see page 1-2) to connect an NTSC, PAL, or SECAM source to your projector.

- 1 Find the RCA connector on your video source marked Video Out (or something similar). This connector is usually yellow. Insert one of the AV cable's yellow connectors into the Video Out jack on the video source.
- 2 Insert the other yellow connector into the projector's VIDEO 1 port.

CONNECTING AN S-VIDEO SOURCE

To connect an S-Video source, use the supplied S-Video cable (see page 1-2) instead of an RCA cable connection. The S-Video cable has identical, round, 4-pin mini-DIN connectors on both ends.

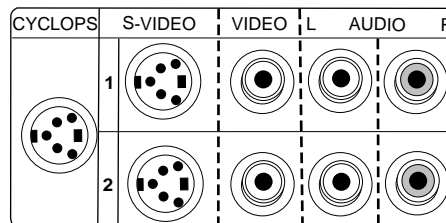

Figure 2-15 The S-VHS port

To connect an S-Video source:

- 1 Insert one end of the S-Video cable into the mini-DIN Video Out port on the video source.
- 2 Insert the other end of the S-Video cable into the projector's S-VIDEO port.



- 3 Use the red and white AV Cable connectors to connect audio from the S-Video source to the projector. See connecting Non-Computer Audio, below.

CONNECTING NON-COMPUTER AUDIO

The AUDIO ports allow you to connect stereo or monaural audio from a composite video source.

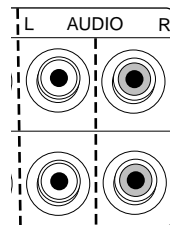

Figure 2-16 Audio Input ports

For stereo audio, use the supplied AV cable.

- 1 Insert the red (right) and white (left) ends of the cable into the Audio Out ports of a composite video's audio source.
- 2 Connect the other end of each cable to the projector's AUDIO IN ports.

NOTE: Although two COMPUTER AUDIO sources and two other AUDIO sources may be connected simultaneously, only one can be active. If computer video is selected, COMPUTER AUDIO is active. If NTSC, PAL, SECAM, or S-VHS video are being viewed, AUDIO is active.

If your audio source is monaural, connect it to the left AUDIO port.



Connecting the PC to the Projector Through the CONTROL Port

You can connect the projector to a computer through the CONTROL port. You can then use the joystick on your remote control as the computer's system mouse (see page 3-8). Before you begin, make sure that the projector and computer power is on and that the cables are securely connected.

NOTE: This CONTROL feature is only available for PCs.

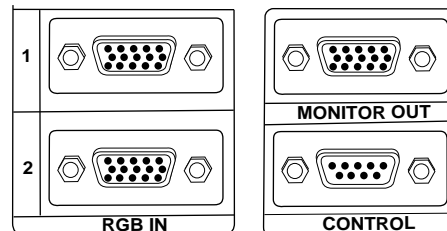

Figure 2-17 The Control port

Connecting the Cyclops Interactive Pointer System

Use the CYCLOPS port to connect the projector and optional Cyclops interactive pointer system to the computer. You can use the Cyclops system to control your computer's on-screen mouse cursor.

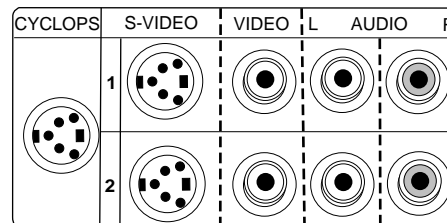

Figure 2-18 The Cyclops port

The optional Cyclops interactive pointer system is shipped with its own Installation and User's Guides. The Cyclops kit also includes extra cables to connect the projector and the computer.

- 1 Connect one end of the appropriate serial cable to the projector's CYCLOPS port.
- 2 Connect the other end of the cable to the computer:
 - On a PC, connect the computer end to a Serial port.
 - On a Macintosh, connect the computer end to an ADB connector.



Projector Audio Out

The projector contains an internal stereo system consisting of an amplifier and one speaker. Although this system provides high-quality audio output, a multimedia presentation may require independently powered stereo speakers or an external sound system.

NOTE: Use the *MUTE* key to turn the projector's internal and any connected external speakers on or off.



Figure 2-19 The Audio Out port

To connect your projector to an external stereo system:

- 1 Insert one end of a Computer Audio cable into the projector's AUDIO OUT port.
- 2 Insert the plug at the other end into the external amplifier or powered speaker system's Audio In port.



Chapter 3

Using the Desktop Projector 5500

TURNING ON THE PROJECTOR AND LAMP

Power the DP5500 up before the computer. This allows the computer to sense the projector during its start-up sequence.

Move the AC POWER switch to the ON position. The ON indicator on the projector control panel glows orange.

The lamp is off when you first turn on the projector. Press the STANDBY/ON key on the operator panel for one second to turn the lamp on. The ON indicator blinks green for a few seconds while the lamp warms up, and then turns to a steady green color. Next, turn on your computer.

CAUTION! Never operate the projector if the air intake or exhaust grills are clogged or obstructed, or if the electric fans are not running.

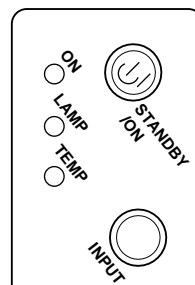

Figure 3-1 Projector STANDBY/ON key



FOCUSING AND ZOOMING THE IMAGE

You can use the title screen that appears when you first start the projector to make your focus and image size adjustments.

- 1 Press the ZOOM +/- key on the Control Panel or Remote Control to make the image larger (+) or smaller (-).

NOTE: If you have a Cyclops interactive pointer system installed and you change the image size, you will have to recalibrate the Cyclops camera.

- 2 Adjust the focus using the FOCUS +/- buttons on the Control Panel or Remote Control.

Image Size

The size of the projected image will change as you move the projector closer to the screen or adjust the zoom lens. The following table indicates the minimum and maximum distance from the projector to the screen for most standard size screens.

SCREEN SIZE	DISTANCE FROM PROJECTOR TO SCREEN	
	MINIMUM	MAXIMUM
40 in.	53.9 in.	87.8 in.
60 in.	82.3 in.	134 in.
80 in.	111 in.	179 in.
100 in.	139 in.	224 in.
120 in.	168 in.	270 in.
150 in.	210 in.	338 in.
200 in.	281 in.	452 in.

TURNING OFF THE PROJECTOR

- 1 Press and hold the STANDBY/ON key on the Control Panel for one second to turn the lamp off. When using the remote control, press and hold the STANDBY/ON key for two seconds.
- 2 The fan will stop about one minute later and the ON indicator will glow. Turn the AC POWER switch off.



CONTROL PANEL KEYS

Use the DP5500's control panel keys to turn the projector on or off, adjust the projected image, and to display and hide the menus. Power, warning, and alert lights give you important information about how your projector is working.

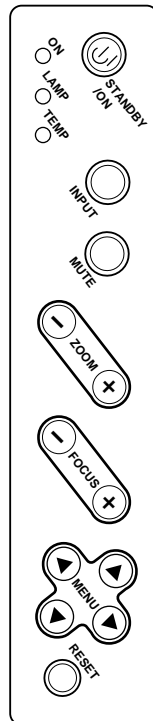

KEY	FUNCTION
STANDBY/ON	Turns the lamp on or off.
INPUT	Switches between active connected video inputs.
MUTE	Turns the Audio on or off.
ZOOM +/-	Zooms in and out. Press + to make the picture larger. Press - to make the picture smaller.
FOCUS +/-	Adjusts the focus of the image.
MENU	Controls the menu.
RESET	Resets all image settings to the factory defaults. Hold the button down to display the number of hours that the lamp has already been used.

Figure 3-2 Control Panel keys

MENU

Press any of the MENU keys to display the menu options over the projected image. If a menu selection is not made within five seconds, the menu will disappear. Menu settings are automatically stored when you exit the menus or turn off the projector. See page 3-9 for more information about using the menus.



CONTROL PANEL INDICATORS

Power, warning, and alert indicators give you important information about how your projector is working.

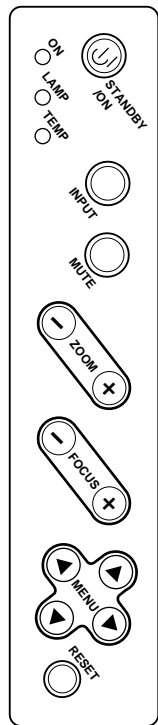

INDICATOR FUNCTION

INDICATOR	FUNCTION
ON	Glows green if AC input and projector power supplies are okay. Glows red if not, or if the air filter door is removed.
	Glows orange while in standby mode.
	Flashes green during lamp start-up.
	Flashes orange during lamp cool-down.
TEMP	Glows red to warn of an over-temperature condition or if the air filter door on the bottom of the projector is open.
LAMP	Glows red if the projection lamp burns out. Flashes red if the air filter door is removed.

Figure 3-3 The DP5500's Control Panel indicators



TEMP

The TEMP indicator illuminates if the projector overheats or if the air filter door on the bottom of the projector is open. A thermostat automatically turns off the power to the lamp until the projector cools.

If an over-temperature condition occurs, perform the following checks while you allow the projector to cool:

- Make sure that the room temperature is below 95° F (35° C).
- Check the intake and exhaust vents. Clear any obstruction to the air flow.
- Make sure that the fans are working. If the projector has reached an over-temperature condition and the fans are working, you should feel a strong flow of hot air from the top vent and a strong rush of air directly into the front and rear of the projector. If either fan is not working, the projector needs service.

After the projector returns to its normal operating temperature, you must turn the main power switch off and back on to clear the over temperature indicator. Press the STANDBY/ON key on the control panel to relight the lamp.

NOTE: The remote control's STANDBY/ON button will not function after an over-temperature condition until the main power switch is turned off and on and the lamp is turned on from the Control Panel.

LAMP Indicator

The LAMP indicator flashes red if the air filter door is removed. It will show solid red if the lamp burns out.

CAUTION! If the lamp fails during a presentation, make sure that the projector cools for a few minutes with the power off before attempting to change the lamp. See page 4-2 for instructions on changing lamps. The lamp and surrounding parts get very hot. Use appropriate care when changing lamps.



USING THE REMOTE CONTROL

The remote control contains all the key functions available on the DP5500 control panel, as well as several additional features. For best results, aim the remote control at the projection screen or at the projector's front panel. Do not obstruct the red infrared eye located on the front of the projector.

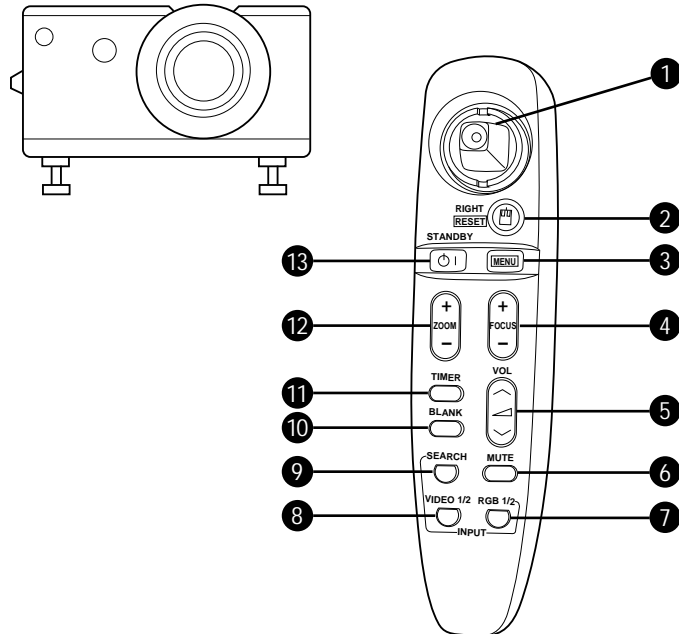

Figure 3-4 Remote Control and Infrared Eye



	KEY	FUNCTION
1	JOYSTICK	Functions as arrow keys or as a mouse.
2	RIGHT/RESET	Resets the projector settings to the factory defaults if the menus are open. Functions as a right mouse button if the projector is in Host mode (see page 3-8).
3	MENU	Displays or hides the menu.
4	FOCUS +/-	Adjusts the focus.
5	VOLUME +/-	Decreases or increases the volume of internal and/or external speakers.
6	MUTE	Turns audio on or off.
7	RGB 1/2	Switches between connected computer sources.
8	VIDEO 1/2	Switches between connected video sources.
9	SEARCH	Switches between all connected and active video sources.
10	BLANK	Turns a solid background on and off.
11	TIMER	Starts and stops the break timer.
12	ZOOM +/-	Zooms in and out.
13	STANDBY/ON	Turns the lamp on and off.



USING THE JOYSTICK

Use the joystick to move through the menus and select items or change values in them. You can also use the joystick as your system mouse if you install the serial cable and follow the boot instructions detailed in the Host Mode section (see below).

- Move the joystick left or right to move across the menus.
- Move the joystick up or down to move up or down in a menu. Move the joystick up to move up one level when you are at the top of a menu.
- Press the joystick to make a menu selection.

If you have are operating in Host Mode, the joystick will provide the following functions:

- Move the joystick up, down, left or right to move the cursor.
- Press the joystick to initiate a mouse click.
- Press the joystick twice for a double mouse click.

OPERATING THE PROJECTOR

The control panel and remote control provide access to all of the projector's features. Press a key to select a function or to navigate through the menus.

Operating Modes

The DP5500 can operate in Local or Host Mode.

Local Mode

Any time you activate the projector's menus, the projector is in Local Mode. In Local Mode, the remote control can be used to move through and select items in the projector menus.

Host Mode

The DP5500 can emulate a serial mouse, allowing you to control your computer from the joystick on the remote control. You do not need a special mouse driver to emulate a serial mouse with the remote control.

To use your remote as the system mouse:

- 1 Turn off your computer and disconnect the mouse.
- 2 Connect one end of the Proxima serial data cable to the computer's serial port and the other end to the CONTROL port on the projector.



- 3 Turn on the projector and light the lamp.
- 4 Turn on your computer. It should detect the projector as a serial mouse.
- 5 Use the joystick on the IR remote control to move the mouse.

Notebook users may need to disable their integrated pointing device before using an external serial mouse. Consult your notebook's user's guide for instructions on connecting a serial mouse.

THE GRAPHICAL USER INTERFACE

Your DP5500 graphical user interface makes it easy to control all of the projector's functions. Menu selections can be made with the control panel or the remote control.

NOTE: Menu selections will change based on the type of video source you have selected.

Using the Menus with the Control Panel

- 1 Press any of the MENU keys to display the on-screen menus.
- 2 Press the ◀ and ▶ MENU keys to select the desired menu. The items on the menu highlighted in green can then be changed.
- 3 Use the ▲ and ▼ MENU keys to move up or down a menu column or to change a menu value. For some items (e.g. Video Source), you may also need to use the ◀ and ▶ keys to access an item.
- 4 The menus automatically disappear after five seconds. Settings are automatically saved when you exit the menus or turn off the projector.

Using the Menus with the Remote Control

- 1 Press the MENU key to display the on-screen menus.
- 2 Move the joystick to to the left or right to adjust highlighted menu items.
- 3 Move the joystick up or down to select items in a menu column or to change a value. For some items (e.g. Video Source), you may need to move the joystick left or right to select an item.
- 4 Press the center of the joystick to change a value or to select a check box.
- 5 Move the joystick away from you to move up one level in any menu.
- 6 Press MENU again to close the menu, or wait five seconds and it will automatically disappear. Settings are automatically saved when you exit the menus or turn off the projector.



USING THE MAIN MENU

When you press MENU, the Main menu appears at the top of the screen.

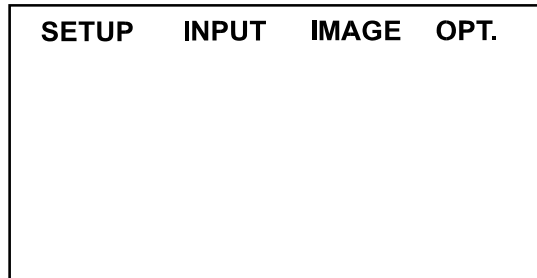



Figure 3-5 Main menu

To turn the menu off, press MENU again. The menus will automatically disappear after a few seconds.

The following table lists the main menu options that you can select. The Input and Image menus display only those items that are relevant to the selected input source (computer, video, or S-Video).

MENU	FUNCTION
SETUP	Adjusts image quality and position.
INPUT	Selects a video input source.
IMAGE	Allows image inversion and other functions.
OPT	Changes communication functions.

Default Settings

The projector's factory settings are indicated by  in the individual menu tables. Press RESET when any menu item is selected to return it to the factory default.



SETUP MENU

The SETUP menu is used to adjust image quality and position. The selections are different for each type of video source. The computer source Setup menu is shown below.

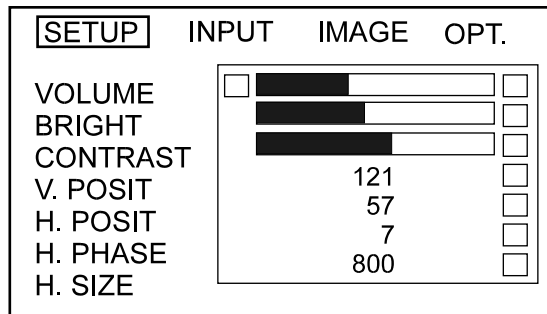

Figure 3-6 Setup Menu Screen

OPTION	WHAT IT DOES	SOURCE
VOLUME	Increases or decreases the volume level.	All sources
BRIGHT	Increases or decreases the intensity level of the projected image.	All sources
CONTRAST	Adjusts the contrast in the projected image.	All sources
SHARPNESS	Adjusts the sharpness of the image.	Video only
COLOR	Adjusts the color saturation for NTSC, PAL, or S-VIDEO sources.	Video only
TINT	Adjusts the red or green color balance for NTSC, or S-VIDEO sources.	Video only (Except PAL)
V. POSIT	Adjusts the vertical position of the projected image.	Computer only
H. POSIT	Adjusts the horizontal position of the projected image.	Computer only
H. PHASE	Adjusts the horizontal phase setting. Use this setting if you see uneven horizontal features, streaks, or shimmering in a computer video image.	Computer only
H. SIZE	Adjusts the width of a computer display.	Computer only



INPUT MENU

Use the Input menu to select a video source.

- Use the Arrow keys to select a source.
- If you choose Video 1 or Video 2, select a video format.
- Select Test Pattern to adjust the focus.

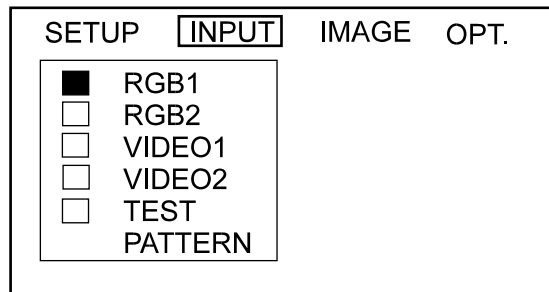

Figure 3-7 Input menu

MENU ITEM	OPTIONS	FUNCTION
RGB 1 or 2		Selects the RGB 1 or 2 port.
VIDEO 1 or 2	<p>SETUP INPUT IMAGE OPT.</p> <ul style="list-style-type: none"> <input type="checkbox"/> RGB1 <input type="checkbox"/> RGB2 <input checked="" type="checkbox"/> VIDEO1 <input type="checkbox"/> VIDEO2 <input type="checkbox"/> TEST PATTERN <p>SYSTEM</p> <ul style="list-style-type: none"> <input type="checkbox"/> AUTO <input type="checkbox"/> NTSC <input type="checkbox"/> PAL <input type="checkbox"/> SECAM 	Selects the VIDEO 1 or 2 port and the video signal type: AUTO, NTSC, PAL, or SECAM.
TEST PATTERN		Displays a full-screen test pattern.



IMAGE MENU

This menu is used to adjust the projected video image and select how the projector will display.

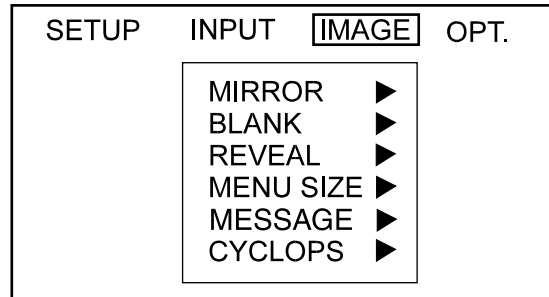

Figure 3-8 Image menu

MENU ITEM	OPTIONS	FUNCTION
MIRROR	<input type="checkbox"/> NORMAL <input type="checkbox"/> H: INVERT <input type="checkbox"/> V: INVERT <input type="checkbox"/> H&V: INVERT	Standard operating mode. Flips the picture horizontally, vertically, or horizontally and vertically.
BLANK	<input type="checkbox"/> WHITE <input type="checkbox"/> BLANK <input type="checkbox"/> BLACK	Selects a blank color (white, blue, or black).
REVEAL	<input type="checkbox"/> FAST <input checked="" type="checkbox"/> MEDIUM <input type="checkbox"/> SLOW	Selects the speed for revealing an image.
MENU SIZE	<input type="checkbox"/> LARGE <input checked="" type="checkbox"/> SMALL	Changes the on-screen menu size.
MESSAGE	<input checked="" type="checkbox"/> TURN ON <input type="checkbox"/> TURN OFF	Turn the on-screen image source messages on or off.
CYCLOPS	<input type="checkbox"/> CALIBRATE <input checked="" type="checkbox"/> CANCEL	Initiates Cyclops calibration. See the <i>Cyclops User's Guide</i> for more information. Press CANCEL to cancel the calibration.



OPTION (OPT.) MENU

The OPT menu is used to control the projector's communications settings.

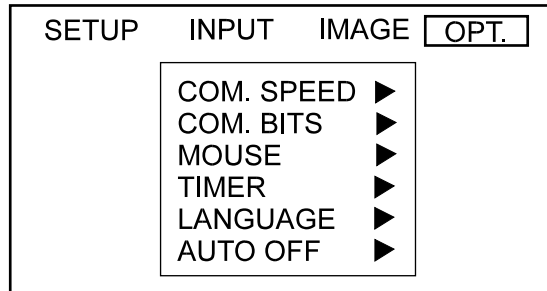

Figure 3-9 OPT Menu Screen



MENU ITEM	OPTIONS	FUNCTION
COMM SPEED	COM. SPEED bps <input type="checkbox"/> 1200 <input checked="" type="checkbox"/> (MOUSE) <input type="checkbox"/> 2400 <input type="checkbox"/> 4800 <input type="checkbox"/> 9600 <input type="checkbox"/> 19200	Selects the speed of data transmission.
COM. BITS	<input type="checkbox"/> 7N1 <input checked="" type="checkbox"/> (MOUSE) <input type="checkbox"/> 8N1	Selects the format of data transmission: Use 7N1 for 7 data-bits, No parity, 1 stop bit. Use 8N1 for 8 data-bits, No parity, 1 stop bit.
MOUSE	<input type="checkbox"/> FAST <input type="checkbox"/> ↑ <input checked="" type="checkbox"/> MEDIUM <input type="checkbox"/> ↓ <input type="checkbox"/> SLOW	Selects the speed of mouse movement.
TIMER	↑ # ↓	Sets the duration of the Break Timer.
LANGUAGE	<input type="checkbox"/> ENGLISH <input type="checkbox"/> FRANCAIS <input type="checkbox"/> DEUTSCH <input type="checkbox"/> ESPANOL <input type="checkbox"/> ITALIANO <input type="checkbox"/> NORSK <input type="checkbox"/> NEDERLANDS	Sets the language for the menu displays.
AUTO OFF	↑ ## MIN. STOP	Sets the time the projector can run with no action before it will automatically turn off. The maximum is 99. Press RESET to set it to zero.



Setting the Timer

You can set the Timer to count down for breaks, class activities, and other presentation requirements.

- 1 From the Options menu, choose Timer and press the right MENU key on the control panel or move the joystick to the right.
- 2 When the Timer menu appears, use the MENU keys on the control panel or the joystick on the remote control to set the time.
- 3 Press TIMER on the remote control, and the clock will begin to count down.

QUICK MENUS

The DP5500 has Quick Menus that allow you to easily adjust the volume, focus, and video source. Adjustment slide bars appear at the bottom of the screen when you press the following Remote Control keys.

ADJUSTMENT ITEM	FUNCTION
VOLUME +/-	Increases or decreases the volume level.
FOCUS +/-	Adjusts the focus of the image.
SEARCH, VIDEO 1/2, RGB 1/2	Displays the currently selected video input port.



Chapter 4

Maintenance

There is very little involved with the care and maintenance of your DP5500. However, common sense and periodic maintenance will ensure top performance.

The lamp, lenses, mirrors, and LCD panels have been carefully aligned at the factory to give you the clearest, brightest image possible. However, physical abuse can cause misalignment or damage to the optical elements. Be careful when you use or handle any of the optical elements.

CLEANING THE LENS

From time to time, you'll need to clean the lens.

- 1 Take a piece of lens tissue and form it into a loose swab. Wet it with lens cleaning fluid or denatured alcohol, and gently move it over the lens surface.
- 2 Take a part of the lens tissue that you haven't touched, and repeat the process, going over the lens in another direction.

⚠ CAUTION! *Your projector contains electric circuitry and sensitive optics. Protect it from potential fluid spills.*



REPLACING THE LAMP

- 1 Turn off the projector.
- 2 Unplug the projector's power cord from the wall socket and remove it from the projector's power receptacle.
- 3 Remove the screw on the right side of the rear panel and remove the service door.

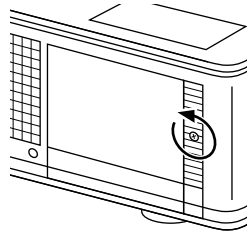

Figure 4-1 Removing the service door

- 4 Unscrew the four lamp assembly screws (they will not come out of the lamp assembly).

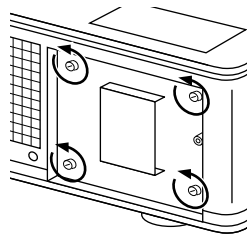

Figure 4-2 Unscrewing the lamp assembly retaining screws



⚠ CAUTION! *The lamp assembly gets very hot during operation. Use appropriate care when changing lamps. Make sure that the lamp assembly has cooled for at least three to five minutes before touching it.*

5 Grasp the rear of the lamp assembly and firmly pull the assembly out.

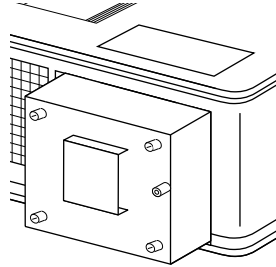

Figure 4-3 Removing the lamp assembly

6 Replace the old lamp assembly with a new one, carefully aligning the power pins on the bottom, and pressing it firmly into place. When it is properly placed, a small alignment mark etched on the projector chassis will be visible below the lamp assembly.

7 Tighten the four lamp assembly retaining screws.

8 Replace the service door and screw it into place.

9 Replace the power cord.



CLEANING THE AIR FILTER

You should change or clean the air intake filter after every 250 operating hours to maintain proper cooling. This filter is located on the bottom of the projector, under the grill.

- 1 Disconnect all cables and cords from the projector.
- 2 Turn the projector on its side, connector panel down.
- 3 Remove both screws on the filter cover.

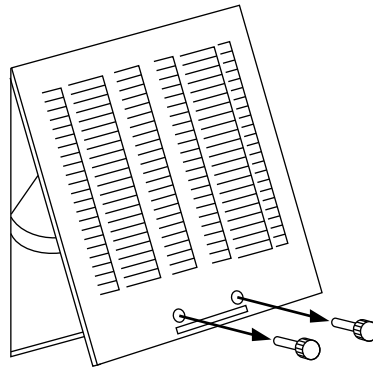

Figure 4-4 Removing the screws on the air filter cover

- 4 Press up on the air filter cover tab to release the cover latch and then pull the grill cover down and out (see Figure 4-5).

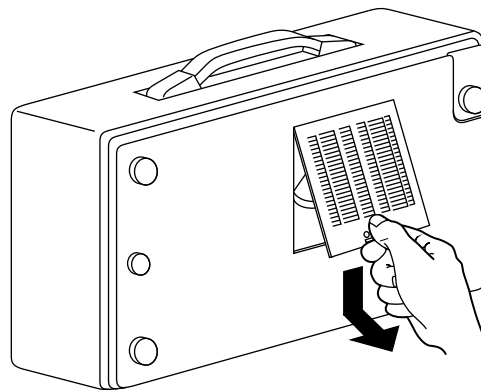

Figure 4-5 Removing the air intake filter grill



- 5 After you have disassembled it, clean the air filter using a vacuum cleaner. If it is still dirty, wipe the air filter with a moist cloth, then wipe it with a dry cloth.

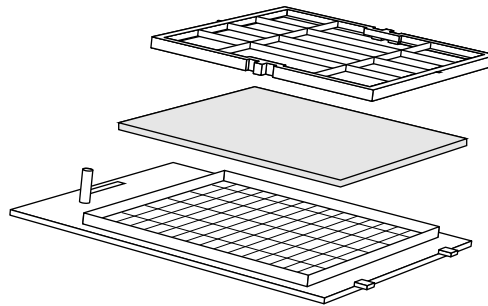

Figure 4-6 The components of the air filter

- 6 Reassemble and reinstall the air filter.

CHANGING THE REMOTE CONTROL'S BATTERIES

If the remote control is not going to be used for awhile, remove the batteries from the unit. If the remote control does not appear to be working properly, replace the batteries.

To install or change the two AAA alkaline batteries in the remote control unit:

- 1 Locate the battery compartment at the lower rear of the case. Slide the cover off of the battery compartment.
- 2 Insert new batteries as illustrated inside the battery compartment.
- 3 Replace the cover.



CAUTION! Do not:

- Use batteries not specified for this unit.
- Use old and new batteries together.
- Insert batteries incorrectly.



Chapter 5

Troubleshooting

WHERE TO GET HELP

If you need help:

- 1 Check the Troubleshooting Chart.
- 2 Call your dealer's technical support line and explain your problem.
- 3 Call Proxima at:

USA. and Canada:

(619) 457-5500. Press 1 for Customer Service.

(619) 457-8542 (Fax)

Outside USA and Canada:

(619) 457-5500. Press 1 for Customer Service.

(619) 622-0173 (Fax)

Europe:

+31-43-358 5200

+31-43-358 5201 (Fax)

Internet (WorldWide Web)

<http://www.prxm.com> (Click **Customer Service.**)



Projector

PROBLEM	LIKELY CAUSE	POSSIBLE SOLUTION(S)
No image projected	No power to projector.	Turn power ON. Check AC cord. Check power to electrical outlet.
	Lamp not on. Lamp burned out.	Turn lamp ON. Replace lamp assembly.
	Over temperature indication.	Allow projector to cool; turn projector OFF and then ON. Make sure the bottom air filter door is closed.
No computer image projected	Loose cable.	Check and secure cable connections.
	No power to computer.	Turn on computer.
	Incompatible video system.	If possible check computer with another monitor.
No video image projected	Video source(s).	Check power on the video source(s).
	Loose cable.	Check and secure cable connections between video source and projector.
LAMP indicator glowing red	Burned-out lamp.	Replace lamp assembly.
Displayed image not square (keystoning)	Projector set at an improper angle to projection screen.	Adjust relative positions of projector and screen.
Projected image out of focus	Projection lens not focused.	Adjust the lens focus.
Projected image larger than screen	Zoom lens not adjusted properly, or projector too far from screen.	Adjust zoom lens, or move projector closer to screen.



PROBLEM	LIKELY CAUSE	POSSIBLE SOLUTION(S)
Projected image smaller than screen	Zoom lens not adjusted properly, or projector too close to screen.	Adjust zoom lens or move projector away from screen.
Image off-center	H. or V. POSIT adjusted incorrectly.	Adjust H. and/or V. POSIT; if image will not center, check for compatibility problems.
	Compatibility problem.	Verify projector is image compatible with one of the standards listed in Appendix A.
	Misalignment or damage to optical elements.	Projector requires service.
No image on the computer screen	Projector power is off or projector is not running.	Computer must be on for computer monitor to display.
	Lamp is burned out.	Turn off projector. Replace lamp.
	Cable not connected.	Connect cable.
Streaks on monitor	Video cable plugged into the computer or projector is upside down.	Check cable connections and projector.
Faint screen	Low intensity.	Adjust BRIGHT (brightness) and CONTRAST settings.
Jittery, fuzzy letters	Out of sync.	Adjust H. PHASE setting.
Cannot get entire image on screen; scrambled image	Compatibility problems.	Verify projector is image compatible.
"Shimmering" colors	H. PHASE or BRIGHT setting out of adjustment.	Adjust H.PHASE or BRIGHT (brightness) settings.
Colors weak in video mode NTSC, PAL, or S-VHS	Weak video signal.	Check for faulty video source, bad connection, or frayed cable.
	COLOR setting may be too low.	Adjust color setting.



PROBLEM	LIKELY CAUSE	POSSIBLE SOLUTION(S)
Getting excessive white or washout in NTSC, PAL, or S-VHS mode	CONTRAST setting is too high.	Adjust CONTRAST setting, then adjust BRIGHT (brightness) setting.
No audio	Audio source(s).	Check audio source(s) for power ON and proper operation.
	Loose/improper cable.	Check and secure cabling between audio source(s) and projector.
TEMP indicator	Air vent(s) clogged.	Allow projector to cool; clear obstructions from vents Clean or replace filter as necessary.
	Internal fan failure.	Allow projector to cool; Check for fan and blower operation, service if necessary.
	Bottom air filter door is open.	Close bottom air filter door.
Remote Control doesn't work	Batteries upside-down or old.	Check battery placement or replace with new batteries.
	Projector IR receiver window is blocked.	Remove object obstructing red IR receiver on front of projector.
	Out of range.	Move within 20 ft. and within a 30° angle from the front of the projector.
Remote Control won't work as mouse control	Serial cable not connected.	Connect cable.
	Wrong mouse driver installed.	Use Microsoft serial mouse driver.
	Projector powered up out of sequence.	Power up projector, connect cable, and power up computer.



RETURNING YOUR DP5500 FOR REPAIR

If the DP5500 or any of its accessories are determined to be defective:

- 1 Contact Proxima Customer Service to request a Return Material Authorization (RMA) number.
- 2 Send the defective unit, including any accessories, cables, and the remote control, with the RMA number clearly marked on the outside of the shipping box, freight prepaid, to:

USA and Canada:

Proxima Corporation
RMA #
9440 Carroll Park Drive
San Diego, CA 92121

Europe:

Proxima Corporation
RMA #
Horsterweg 24
6191 RX Beek
The Netherlands

- 3 Pack the projector in its original box for safe shipment (include all accessories, cables, and the remote control). If you no longer have the original shipping materials, contact Proxima Customer Service for packaging.

ORDERING PARTS

Please order replacement and accessory parts through your local reseller, or call Proxima at:

USA and Canada:

(800) 447-7694 or
(619) 457-5500
Press 1 for Customer Service
Fax: (619) 457-8542

Europe:

+31-43-358 5200
+31-43-358 5201 (Fax)

Outside USA and Canada:

(619) 457-5500
Press 1 for Customer Service
Fax: (619) 622-0173



Appendix A Specifications

DP5500 SPECIFICATIONS

Color	16.7 million colors
Display	3 polysilicon liquid crystal panels
Compatibility	NTSC, PAL, SECAM, and S-VHS
Projection Lamp	250 Watt, metal-halide lamp
Optics	Zoom lens F3.0 ~ 3.8 f46.5 ~ 74.4mm
Keystone Correction	8.8°
Audio System	One built-in speaker, 3 Watt
Inputs	2 Computer video 2 TV video (NTSC, PAL, SECAM, S-VHS) 2 Computer stereo audio 2 TV stereo audio RS-232 control port Cyclops System
Outputs	Stereo audio 1 RGB monitor
Power Source	100 - 120 VAC, 5 A or 220 - 240 VAC, 2A
Dimensions	12.6 in. (W) x 6.9 in. (H) x 18.2 in (D)
Weight	23.1 lbs.
Compatibility	PC (VGA) Apple Macintosh & Powerbook series Quadra, Centris, Video NTSC/PAL/SECAM/S-Video



Appendix B

Accessories and Replacement Parts

REPLACEMENT PARTS

PART	PART NUMBER
Lamp Assembly	L84
Remote Control	A15
Power Cord - US	C151-10
Power Cord - Europe	C152-10
VGA Video Cable	C950-06
VGA - Mac Cable Adapter	C951
S-Video Cable	C552-6
AV Cable	C550-6
Serial Cable	C551-6
Mini-stereo to Mini-stereo Cable	900-55010
Lens Cap	280-00099
Air Filter	280-00153

OPTIONAL ACCESSORIES

OPTION	MODEL / PART NUMBER
Rolling Hard Case	A295
Rolling Soft Case	A298
Cyclops Interactive Pointer System	A2075



Index

A

- AC Power switch 2-6
- Accessories B-1
- AUDIO 1-5, 2-5
- AUDIO OUT 1-5, 2-5
- Audio Out Ports 2-14
 - External Speaker System Connection 2-14
 - External Stereo System Connection 2-14
- Audio Ports
 - Monaural Source 2-12
 - Stereo Source 2-12

C

- Circuit Breaker Reset switch 2-6
- Computer Audio Port
 - Connecting a Monaural Source 2-10
 - Connecting a Stereo Source 2-10
- Computer Video Connection
 - Macintosh Computers 2-8
 - Notebook Computers 2-9
 - PC 2-6
 - Special Configurations 2-10
- Connector Panel 1-5, 2-5
- Connector Table 1-5, 2-5
- Contents of Box
 - Accessories 1-2
- Control Panel
 - Keys Table 1-6
- Control Panel Keys 3-3
- Control Panel Lights 3-4
- CYCLOPS 1-5, 2-5
- Cyclops 1-6
- Cyclops Connection 2-13

D

- Desktop Projector
 - Turning Off 3-2
- DP5500
 - Powering Up 3-1

F

- Focusing the Image
 - Non-Zoom Models 3-2
 - Zoom Lens Models 3-2

G

- Getting Started 2-2
- Graphical User Interface 3-8

I

- Image Menu
 - Adjust Submenu 3-12
- Infrared Eye 3-6
- Input Source Menu
 - Source Mode 3-12
 - Source Select 3-12
 - Sync Status 3-12

L

- LAMP Indicator 3-5
- Laptop Connections 2-9
- Lens Cleaning 4-1

M

- Macintosh Adapters 2-8
- Macintosh Connections 2-8
- Main Menu 3-10
- Maintenance
 - Lens Cleaning 4-1
- MENU 3-7
- MONITOR OUT 1-5, 2-5
- MUTE 3-7

N

- Notebooks 1-4

O

- Operating Modes
 - Host Mode 3-8
 - Local Mode 3-8
- Ordering Parts 5-5
- Over-Temperature 3-4

P

- Parts
 - Optional Accessories B-1
 - Replacement B-1
- Power 3-4
- Power receptacle 2-6
- Power to the Projector 2-6
- Powering Up Projector 3-1

Projector

- Moving 2-3
- Positioning 2-2
- Transporting 2-3
- Projector Cooling and Airflow 2-4
- Projector Operation
 - Using a Mouse 3-8
 - Using Control Panel and Remote 3-8

Q

- Quick Start
 - Desktop Macintosh computers 1-3
 - Desktop PCs 1-3
 - Notebooks 1-4

R

- Remote Control Keys 3-7
- Remote Control Unit 3-6
- Repair of your DP5500 5-5
- Replacement Parts B-1
- Returning your DP5500 for Repair 5-5

S

- S-VHS 1 & 2 1-5, 2-5
- Special Configurations 1-4

T

- Turning off the Projector 3-2

V

- VGA Connections 2-7
- VGA Video Cable 2-6
- VIDEO 1 & 2 1-5, 2-5
- Video Input Ports
 - Composite Video Connections 2-11
 - S-VHS Connections 2-11
- VOLUME 3-7

Free Manuals Download Website

<http://myh66.com>

<http://usermanuals.us>

<http://www.somanuals.com>

<http://www.4manuals.cc>

<http://www.manual-lib.com>

<http://www.404manual.com>

<http://www.luxmanual.com>

<http://aubethermostatmanual.com>

Golf course search by state

<http://golfingnear.com>

Email search by domain

<http://emailbydomain.com>

Auto manuals search

<http://auto.somanuals.com>

TV manuals search

<http://tv.somanuals.com>