

.....[User's Guide]

proxima[®]

DP[®]6870

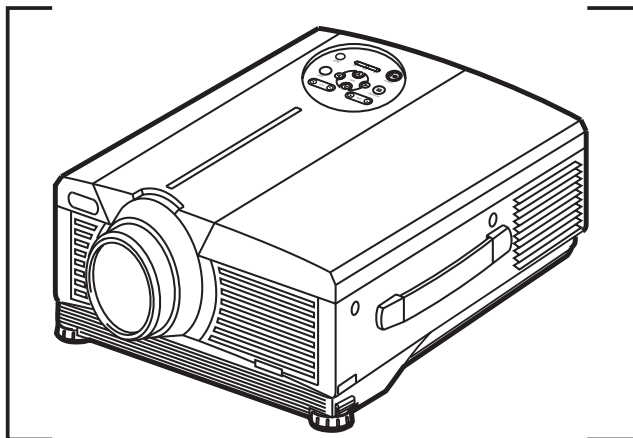

proxima [®]	www.infocus.com 1.888.294.6400
	PRESENTATION SOLUTIONS
DP6870	

proxima[®]

InFocus Corporation: 27700B SW Parkway Avenue • Wilsonville , Oregon 97070-9215
Phone: 503-685-8888 • 1-800-294-6400 • Fax: 503-685-8887
<http://www.infocus.com>

In Europe: Strawinskylaan 585. 1077 XX Amsterdam, The Netherlands
Phone: (31) 20 579 2000 • Fax: (31) 20 579 2999

In Asia: 238A Thomson Road • #18-01/04 Novena Square
Singapore 307684 • Telephone: (65) 6334-9005 • Fax: (65) 6334-4525

User's Guide 010-0410-00



Part No.010-0410-00
DP6870 User's Manual.qxd
Printed in Japan

010-0410-00

QR55041

Download from [Www.Somanuals.com](http://www.Somanuals.com). All Manuals Search And Download.

Liquid Crystal Projector

User's Guide

Thank you for purchasing this liquid crystal projector.



WARNING • Please read the accompanying manual "Safety Instruction" and this user's guide thoroughly to ensure correct usage through understanding. After reading, store this instruction manual in a safe place for future reference.

NOTE

- The information in this manual is subject to change without notice.
- The manufacturer assumes no responsibility for any errors that may appear in this manual
- The reproduction, transmission or use of this document or contents is not permitted without express written authority.

TRADEMARK ACKNOWLEDGMENT : PS/2, VGA and XGA are registered trademarks of International Business Machines Corporation. Apple, Mac and ADB are registered trademarks of Apple Computer, Inc. VESA and SVGA are trademarks of the Video Electronics Standard Association. Windows is a registered trademark of Microsoft Corporation. Carefully observe the trademarks and registered trademarks of all companies, even when not mentioned.

CONTENTS

	Page		Page
FEATURES	2	TROUBLESHOOTING	20
BEFORE USE	2	OSD Message	20
Contents of Package	2	Indicators Message	21
Part Names.....	3	Symptom	22
Loading the Batteries.....	5	SPECIFICATIONS	23
INSTALLATION	6	
Installation of the Projector and Screen.....	6	TABLES	
Angle Adjustment	6	Table 1. Installation Reference	6
Cabling	7	Table 2. Cabling	7
Power Connection	8	Table 3. Basic Operation	10
Example of System Setup	8	Table 4. Setup Menu	12
Plug & Play	8	Table 5. Input Menu.....	13
OPERATIONS	9	Table 6. Image Menu.....	14
Power ON	9	Table 7. Options Menu	15
Power OFF	9	Table 8. No Signal Menu	16
Basic Operation	10	Table 9. OSD Message	20
Setup Menu	12	Table 10. Indicators Message	21
Input Menu.....	13	Table 11. Symptom	22
Image Menu.....	14	Table 12. Specifications	23
Options Menu	15	
No Signal Menu	16	For "TECHNICAL" and "REGULATORY	
MAINTENANCE	17	NOTICE", see the end of the manual.	
Lamp.....	17		
Air Filters	19		
Other Maintenance.....	19		

FEATURES

This liquid crystal projector is used to project various computer signals as well as NTSC / PAL / SECAM video signals onto a screen. Little space is required for installation and large images can easily be realized.

Outstanding Brightness

The UHB lamp and high-efficiency optical system assure a high level of brightness.

Partial Magnification Function

Interesting parts of images can be magnified for closer viewing.

Distortion Correction Function

Distortion-free images are quickly available.

BEFORE USE

Contents of package

Make sure all of the following items are included in the package. If anything is missing, please contact your dealer.

NOTE • Keep the original packing material for future reshipment.

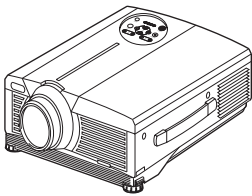

Projector
(with Lens Cap)



User's Guide (this manual)
Safety Instruction
Quick Start Guide
Product Registration Card
"Technology Upgrade Program" Card
"Thank you" Card



Power Cord
(US Type)



Power Cord
(Europe Type)

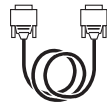

RGB Cable

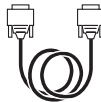

Digital RGB Cable



Video/Audio Cable
(with white lead)



Component Video Cable
(with green lead)

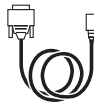

Mouse cable
(PS/2)



Batteries
for Remote Control
Transmitter



Remote Control
Transmitter

BEFORE USE (continued)

Part Names

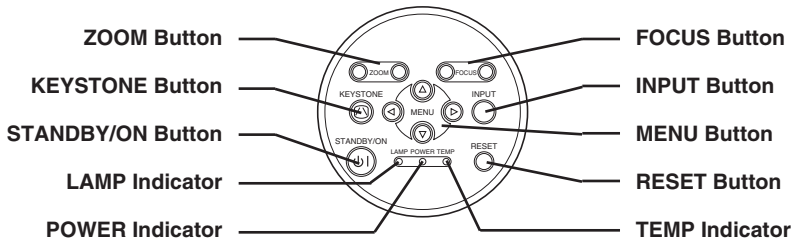

Control Panel
(Refer to P.9 "OPERATIONS")

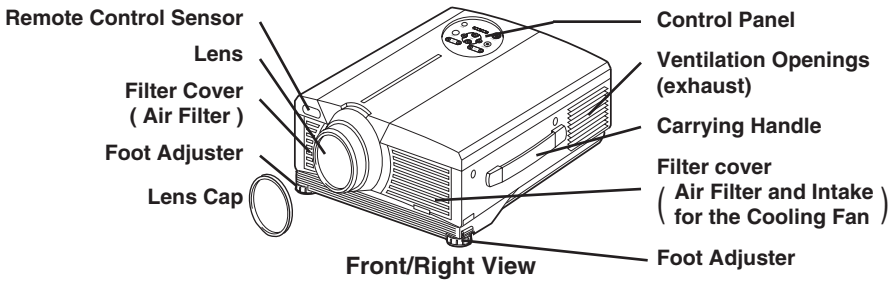

Front/Right View

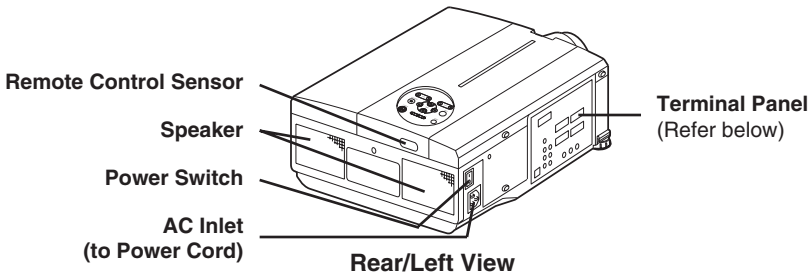

Rear/Left View

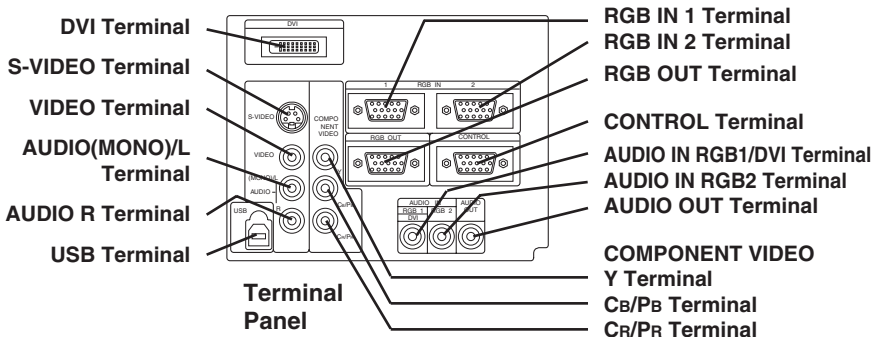

Terminal Panel

BEFORE USE (continued)

Part Names (continued)

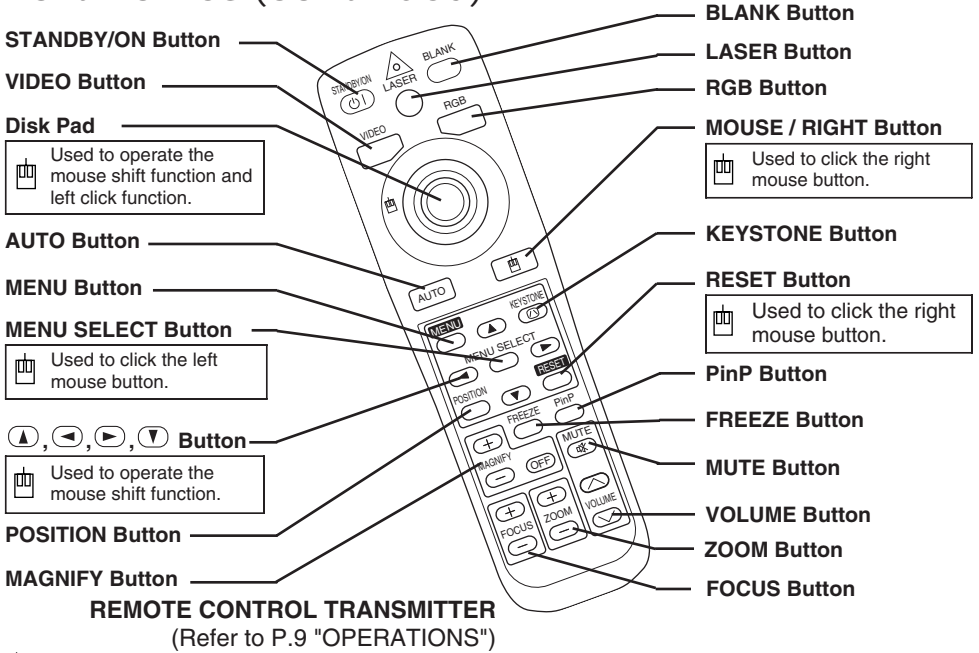

These functions work when the mouse control function is activated. Remember, the POSITION, BLANK ON and MENU ON functions disable the mouse control function.

- WARNING** • The laser pointer of the remote control transmitter is used in place of a finger or rod. Never look directly into the laser beam outlet or point the laser beam at other people. The laser beam can cause vision problems.
- CAUTION** • Use of controls or adjustments or performance of procedures other than those specified herein may result in hazardous radiation exposure.

AVOID EXPOSURE:
LASER RADIATIONS IS
EMITTED FROM THIS
APERTURE

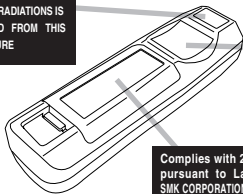

CAUTION
LASER RADIATION
DO NOT STARE INTO BEAM
MAX. OUTPUT: 1mW
WAVE LENGTH: 650nm
CLASS II LASER PRODUCT

LASER RADIATION
DO NOT STARE INTO BEAM
CLASS II LASER PRODUCT
MAX. OUTPUT: 1mW
WAVE LENGTH: 650nm
E2C30055-1 1993-A1-1997



Complies with 21 CFR 1040. 10 and 1040. 11 except for deviations pursuant to Laser Notice No.50, dated 2001.7.26
SMK CORPORATION
6-5-5 Togoshi Shinagawa-ku, Tokyo, JAPAN 142-8511
MANUFACTURED November 2001
PLACE OF MANUFACTURER: A

- NOTE** • Keep the remote control transmitter away from children and pets.
- Do not give the remote control transmitter any physical impact. Take care not to drop.
- Do not place the heavy objects on the remote control transmitter.
- Do not wet the remote control transmitter or place it on any wet object.
- Do not place the remote control transmitter close to the cooling fan of the projector.
- Do not disassemble the remote control transmitter.

BEFORE USE (continued)

Loading the Batteries

Install the AA batteries into the remote control transmitter.

1. Remove the battery cover.
Push the knob while lifting up the battery cover.
2. Load the batteries.
Make sure the plus and minus poles are correctly oriented.
3. Close the battery cover.

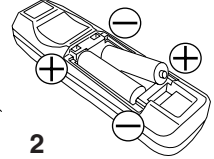
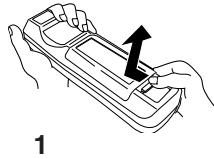

CAUTION • Use only the specified batteries with this remote control transmitter. Also, do not mix new and old batteries. This could cause battery cracking or leakage, which could result in fire or personal injury.

- When loading the batteries, make sure the plus and minus terminals are correctly oriented as indicated in the remote control transmitter. Incorrect orientation could cause battery cracking or leakage, which could result in personal injury or pollution of the surrounding environment.
- When you dispose the battery, you should obey the law in the relative area or country.
- Keep the battery away from children and pets.
- When not to be used for an extended period, remove the batteries from the remote control transmitter.

NOTE Replace the batteries when remote control transmitter operation becomes difficult.

INSTALLATION

Installation of the Projector and Screen

Refer to the drawing and table below for determining the screen size and projection distance.

The projection distances shown in the table below are for full size (1024 x 768 dots).

a: Distance from the projector to the screen. ($\pm 10\%$)

b: Distance from the lens center to the bottom of the screen. ($\pm 10\%$)

Table 1. Installation Reference

Screen size [inches (m)]	a [inches (m)]		b [inches (cm)]
	Min.	Max.	
40 (1.0)	55 (1.4)	73 (1.9)	1 (3)
60 (1.5)	85 (2.2)	114 (2.9)	2 (4)
80 (2.0)	114 (2.9)	151 (3.8)	2 (6)
100 (2.5)	144 (3.7)	191 (4.9)	3 (7)
120 (3.0)	176 (4.5)	231 (5.9)	3 (9)
150 (3.8)	220 (5.6)	282 (7.2)	4 (11)
200 (5.0)	291 (7.4)	386 (9.8)	6 (15)

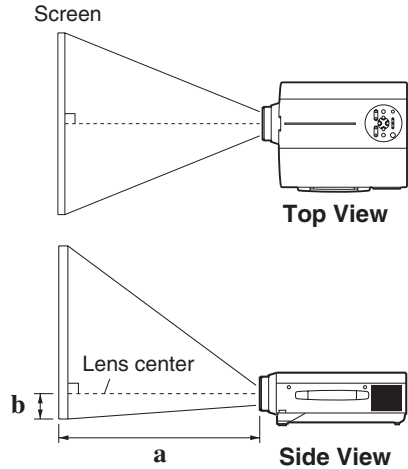

CAUTION • Install the projector in a suitable environment according to instructions of the accompanying manual “Safety instruction” and this manual.

• When you fix this unit with a metal tool and the like, you must connect it with ground wire; otherwise, fire or electric shock can result.

Connect the ground terminal of AC inlet of this unit with the ground terminal provided at the building using an optional three-core power-supply cord.

• Please basically use liquid crystal projector at the horizontal position. If you use liquid crystal projector by the lens up position, the lens down position and the side up position, this may cause the heat inside to build up and cause damage. Be especially careful not to install it with ventilation holes blocked.

• Do not install LCD projector in smoke effected environment. Smoke residue may buildup on critical parts (i.e.LCD panel, Lens Assy etc.).

Angle Adjustment

Use the foot adjusters on the bottom of the projector to adjust the projection angle. It is variable within 0° to 9° approximately.

1. Lift up the front side of the projector, and pressing the foot adjuster button, adjust the projection angle.
2. Release the button to lock at the desired angle.
3. Use the foot adjusters for fine adjustment. Do not force the adjuster screws. This could damage the adjusters or cause the lock to fail.

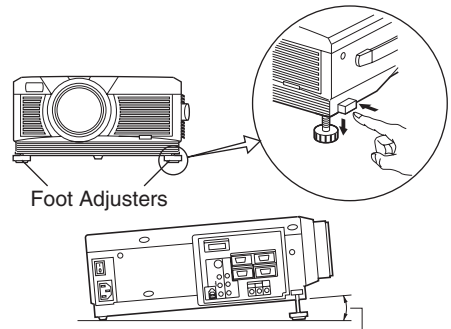

Variable within the range of approximately 0° - 9°



CAUTION • Do not release the foot adjuster button unless the projector is being held; otherwise, the projector could overturn or fingers could get caught and cause personal injury.

INSTALLATION (continued)

Cabling

Refer to the table below for connecting each terminal of the projector to a device.

Table 2. Cabling

Function	Terminal	Cable
Analog RGB input	RGB IN 1	RGB cable with D-sub 15-pin shrink jack and inch thread screws
	RGB IN 2	
Analog RGB output	RGB OUT	
Digital RGB input	DVI	DVI cable with inch thread screws
Audio input (from the computer)	AUDIO IN [RGB 1] / [DVI] (interlocked with RGB IN 1 or DVI)	Audio cable with stereo mini jack
	AUDIO IN [RGB 2] (interlocked with RGB IN 2)	
PS/2 mouse control	CONTROL	PS/2 mouse cable
ADB mouse control		ADB mouse cable
Serial mouse control		Serial mouse cable
RS-232C communication		RS-232C cable
USB mouse control	USB	USB cable
S-video input	S-VIDEO	S-video cable with mini DIN 4-pin jack
Video input	VIDEO	Video/Audio cable
Component video input	COMPONENT VIDEO Y	Component Video cable
	COMPONENT VIDEO Cb/Pb	
	COMPONENT VIDEO Cr/Pr	
Audio input (from video equipment)	AUDIO (MONO)/L	Video/Audio cable or Audio cable with RCA jack
	AUDIO R	
Audio output	AUDIO OUT	Audio cable with stereo mini jack



CAUTION • Incorrect connecting could result in fire or electrical shock.

Please read this manual and the separate “Safety Instruction”.

- Before connecting, turn off to all devices to be connected, except for the USB cable.
- The cables may have to be used with the core set to the projector side. Use the cables which are included with the projector or specified.

NOTE

• Before connecting, read instruction manuals of the devices to be connected, and make sure that the projector is compatible with the device.

- Secure the screws on the connectors and tighten.
- For some RGB input modes, the optional Mac adapter is necessary.
- To select the DVI input, the computer may need some settings. See the manuals of the computer for details.
- Some computers may have multiple display screen modes. Use of some of these modes will not be possible with this projector.
- Refer to the “TECHNICAL” section for the pin assign of connectors and RS-232C communication data.
- When the DVI terminal is used, the RGB OUT terminal may not function.

INSTALLATION (continued)

Power Connection

Use the correct power cord depending on the power outlet to be used.

Connect the AC inlet of the projector to the power outlet firmly by the power cord.

- CAUTION** • Be careful in handling the power cord according to instructions of the accompanying manual "Safety Instruction" and this manual.
- Connect the power cord firmly. Avoid using a loose, unsound outlet or failed contact.

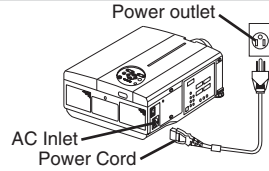

Example of System Setup

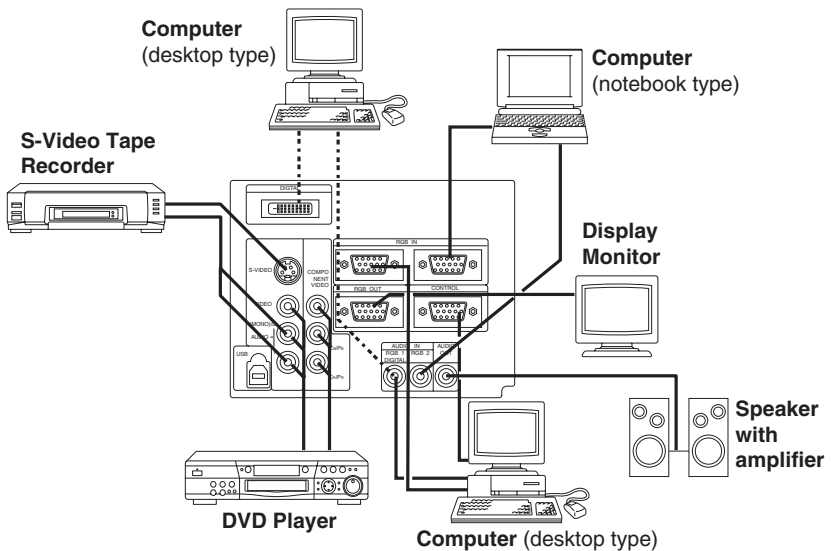

NOTE • When connecting with a notebook computer, set the proper RGB external image output (setting CRT display or simultaneous display of LCD and CRT). Please read instruction manual of the notebook for more information.

Plug & Play

This projector is VESA DDC 1/2B compatible. Plug & play is possible by connecting to a computer that is VESA DDC (Display Data Channel) compatible.

Please use this function by connecting the RGB cable with RGB IN 1 terminal (DDC 1/2B compatible), or by connecting a DVI cable with DVI terminal (DDC 2B compatible). Plug & play may not operate by other connections.

NOTE • Plug & play is a system configured with peripheral equipment including a computer, display and an operating system.

- This projector is recognized as a plug & play monitor. Use the standard display drivers.
- Plug & play may not operate by the computer to connect. Use the RGB IN 2 terminal if plug & play does not operate correctly.

OPERATIONS

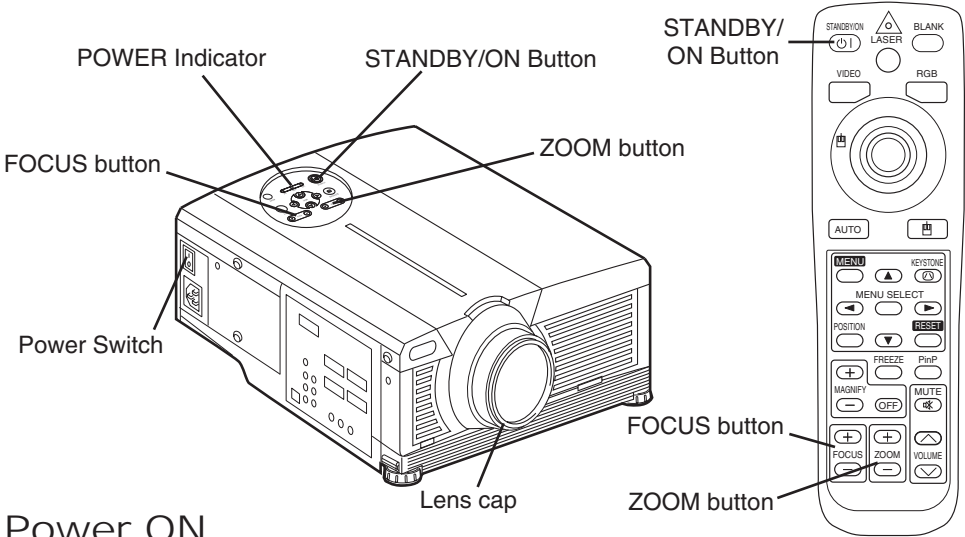

Power ON

1. Check that the power cord is connected correctly.
2. Set the power switch to [I]. The standby mode is selected, and the POWER indicator is turned to orange.
3. Press the STANDBY/ON button (Ⓜ) on the control panel or the remote control transmitter. Warm-up begins and the POWER indicator blinks in green.
4. The POWER indicator ceases blinking and turns to green when power is on. Remove the lens cap.
5. Adjust picture size using the ZOOM button.
6. Adjust focus using the FOCUS button .

Power OFF

1. Press the STANDBY/ON button (Ⓜ) on the control panel or the remote control transmitter. Then, the message "Power off?" will appear on the screen, and the message will disappear by any operation or no operation for 5 seconds. During this message indication, press the STANDBY/ON (Ⓜ) button again. The projector lamp is extinguished and lamp cooling begins. The POWER indicator blinks orange during lamp cooling. Pressing the STANDBY/ON button (Ⓜ) has no effect while the POWER indicator is blinking.
2. The system assumes the Standby mode when cooling is complete, and the POWER indicator ceases blinking and changes to orange. Check that the indicator is orange and set the Power switch to [O].
3. The POWER indicator is extinguished when power is off. Attach the lens cap.



WARNING • Please read this manual, and the separate "Safety Instruction" thoroughly before using the equipment. Always ensure that the equipment is used safely.

NOTE

- Except in emergencies, follow the above-mentioned procedure for turning power off. If the projector is used improperly, it may be very difficult to turn off the projector caused by heating inside the unit. And the reduction of life time of lamp and LCD panels will be caused by incorrect procedure.
- To prevent any trouble, turn on/off the projector when the computer or video tape recorder is OFF. Providing a RS-232C cable is connected, turn on the computer before the projector.
- When a projector continues projecting the same image, the image may remain as an afterimage. Please do not project the image same for a long time.

OPERATIONS (continued)

Basic Operation

The basic operations shown in Table 3 is performed from the supplied remote control transmitter or the projector control panel. Items indicated by (*) may be used from the control panel.

Table 3 . Basic Operation

Item	Description
INPUT SELECT	<p>Select Input Signal (*) : Press the INPUT button. RGB IN 1 → RGB IN 2 → DVI → VIDEO → S-VIDEO → COMPONENT VIDEO (→ RGB IN 1)</p> <p>Select RGB Input : Press the RGB button. VIDEO/S-VIDEO/COMPONENT VIDEO → RGB IN 1/RGB IN 2/DVI RGB IN 1 → RGB IN 2 → DVI (→ RGB IN 1)</p> <p>Select Video Input : Press the VIDEO button. RGB IN 1/RGB IN 2/DVI → VIDEO/S-VIDEO/COMPONENT VIDEO VIDEO → S-VIDEO → COMPONENT VIDEO (→ VIDEO)</p> <ul style="list-style-type: none"> • The selected signal name is displayed for approximately 3 seconds when the input signal is changed.
POSITION	<p>Set/Clear Position Adjustment Mode : Press the POSITION button. The [] icon is displayed in the POSITION mode.</p> <p>Image Position Adjustment: Press the ←, →, ▲ and ▼ buttons in the POSITION mode.</p> <ul style="list-style-type: none"> • Valid only in the MAGNIFY mode with a video signal is input. • After approximately 10 seconds of inactivity the [] icon is extinguished and the POSITION mode is cleared automatically. • ←, →, ▲ and ▼ buttons may operate as the mouse control button. Refer to page 4.
RESET (*)	<p>Initialize Each Item : Select an item and press the RESET button.</p> <p>Initialize Position Adjustment : Press the RESET button and the POSITION mode. This function is valid only when RGB signal is input.</p> <ul style="list-style-type: none"> • Valid except for the VOLUME, LANGUAGE, WHISPER and H PHASE. • The RESET button may operate as the mouse control button. Refer to page 4.
MAGNIFY	<p>Set MAGNIFY Mode : Press the MAGNIFY ⊕ button.</p> <p>Move Magnified Area : Run the POSITION in the MAGNIFY mode.</p> <p>Adjust Magnification : Press the MAGNIFY ⊕ / ⊖ button in MAGNIFY mode.</p> <p>Clear MAGNIFY Mode : Press the MAGNIFY ⊖ button.</p> <ul style="list-style-type: none"> • The MAGNIFY mode is cleared by running or setting the AUTO, ASPECT, INPUT SELECT or VIDEO, or by changing the input signal.
FREEZE	<p>Set/Clear FREEZE Mode : Press the FREEZE button. The [] icon is displayed, and the image is frozen, in the FREEZE mode.</p> <ul style="list-style-type: none"> • The FREEZE mode is cleared by running or setting POSITION, VOLUME, MUTE, Automatic Adjustment, BLANK ON/OFF, or MENU ON/OFF, or by changing the input signal. • Do not forget to clear frozen static images.

NOTE • Use the remote control transmitter at a distance of approximately 5m from the sensor on the front of the projector, and within a range of 30° left-right. Strong light and obstacles will interfere with operation of the remote control transmitter.

OPERATIONS (continued)

Items indicated by (*) may be used from the control panel.

Table 3. Basic Operation (continued)

Item	Description
VOLUME	Volume Adjustment : Press the VOLUME ⏪ / ⏩ button.
MUTE	Set/Clear Mute Mode : Press the MUTE button. No sound is heard in the MUTE mode.
AUTO	<p>Automatic Adjustment at RGB Input : Press the AUTO button. Horizontal position(H.POSIT), vertical position (V.POSIT),clock phase (H.PHASE), and horizontal size(H.SIZE) are automatically adjusted. Use with the window at maximum size in the application display.</p> <p>Automatic Adjustment at Video Input : Press the AUTO button. A signal type appropriate for the input signal is selected automatically. Valid only when AUTO is set for VIDEO on the menu.</p> <ul style="list-style-type: none"> • This operation requires approximately 10 seconds. It may not function correctly with some input signals.
BLANK ON/OFF	Set/Clear Blank Mode: Press the BLANK button. No image is displayed in the Blank mode. The screen color is as set in BLANK on the Image menu.
MENU ON/OFF (*)	<p>Menu Display Start/Stop: Press the MENU button.</p> <ul style="list-style-type: none"> • The menu display is terminated automatically after approximately 10 seconds of inactivity.
MENU SELECT	<p>Select Menu Type: Press the MENU SELECT button. Allows the user to select the normal menu or the single menu. Only the selected item is displayed on the single menu, and other items are displayed with the ⏪ and ⏩ buttons as with the normal menu.</p> <ul style="list-style-type: none"> • Valid only when the Setup menu is used. Push the MENU SELECT button after selecting items such as "BRIGHTNESS". • The MENU SELECT button may operate as the mouse control button. Refer to page 4. <div style="text-align: center;">  <p>The diagram illustrates the 'MENU SELECT' function. It shows two menu states: 'Normal menu' and 'Single menu'. The 'Normal menu' is a list of various settings like BRIGHTNESS, CONTRAST, etc., with left and right arrows. The 'Single menu' shows only one item selected. A double-headed arrow between them is labeled '(MENU SELECT)', indicating that pressing this button toggles between the two menu types.</p> </div>
P.IN P. MODE	<p>Select Mode of P.IN P. Display : Press the PinP button.</p> <p>Small → Large → P.IN P. off (→ Small)</p> <ul style="list-style-type: none"> • P.IN P. function superimposes a video image over RGB or DVI signals.
ZOOM (*)	Adjust Screen Size : Press the ZOOM ⊕ / ⊖ button.
FOCUS (*)	Adjust Focus : Press the FOCUS ⊕ / ⊖ button.
KEYSTONE (*)	<p>Set / Clear KEYSTONE Mode : Press the KEYSTONE Ⓞ button.</p> <p>Select KEYSTONE Mode : Press the ⏪ / ⏩ button in the KEYSTONE mode.</p> <p>Vertical ⏪ ↔ ⏩ Horizontal</p> <p>Adjust KEYSTONE : Press the ⏪ / ⏩ button.</p> <ul style="list-style-type: none"> • The image may not be appeared properly when this function is activated on some input signals. • The adjustable range of distortion correction will be different among input signals.

OPERATIONS (continued)

Setup Menu

The following adjustments and settings are possible when SETUP is selected at the top of the menu. Part of the Setup menu differs between RGB input and video input. Select an item with the \blacktriangle and \blacktriangledown buttons, and start operation. Use the Single menu to reduce menu size (see Table 3, MENU SELECT).

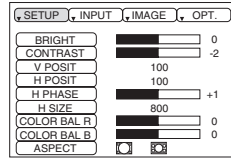

RGB IN 1
RGB IN 2
DVI

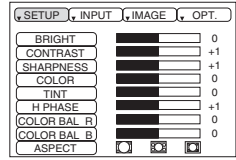

VIDEO
S-VIDEO
COMPONENT VIDEO

Table 4. Setup Menu

Item	Description	RGB IN 1 RGB IN 2	DVI	VIDEO S-VIDEO COMPONENT
BRIGHT	Adjustment: Dark \blacktriangleleft \leftrightarrow Light \blacktriangleright	✓	✓	✓
CONTRAST	Adjustment: Weak \blacktriangleleft \leftrightarrow Strong \blacktriangleright	✓	✓	✓
V POSIT	Adjustment: Down \blacktriangleleft \leftrightarrow Up \blacktriangleright	✓	-	-
H POSIT	Adjustment: Left \blacktriangleleft \leftrightarrow Right \blacktriangleright	✓	-	-
H PHASE	Adjustment: Left \blacktriangleleft \leftrightarrow Right \blacktriangleright • Adjust to eliminate flicker.	✓	-	✓
H SIZE	Adjustment: Small \blacktriangleleft \leftrightarrow Large \blacktriangleright • The image may not be displayed correctly if the horizontal size is excessive. In such cases, press the RESET button, and initialize the horizontal size.	✓	-	-
SHARPNESS	Adjustment: Soft \blacktriangleleft \leftrightarrow Clear \blacktriangleright	-	-	✓
COLOR	Adjustment: Light \blacktriangleleft \leftrightarrow Dark \blacktriangleright	-	-	✓
TINT	Adjustment: Red \blacktriangleleft \leftrightarrow Green \blacktriangleright • Valid only when NTSC or NTSC 4.43 signal is received.	-	-	✓
COLOR BAL R	Adjustment: Light \blacktriangleleft \leftrightarrow Dark \blacktriangleright	✓	✓	✓
COLOR BAL B	Adjustment: Light \blacktriangleleft \leftrightarrow Dark \blacktriangleright	✓	✓	✓
ASPECT	Select Image Aspect Ratio : 4:3[] \blacktriangleleft \leftrightarrow \blacktriangleright 16:9[] Select Position of Image: Press the \blacktriangledown button while 16:9[] is selected. Center \rightarrow \blacktriangledown Down \rightarrow \blacktriangledown Up (\rightarrow Center \blacktriangledown)	✓	✓	-
	Select Image Aspect Ratio: 4:3[] \blacktriangleleft \leftrightarrow \blacktriangleright 16:9[] \blacktriangleleft \leftrightarrow \blacktriangleright 4:3 small[] Select Position of Image : Press the \blacktriangledown button while 16:9[] / 4:3 small[] is selected. Center \rightarrow \blacktriangledown Down \rightarrow \blacktriangledown Up (\rightarrow Center \blacktriangledown) • 4:3 small cannot be selected with the input of 720P or 1080i component. • 4:3 small may not be displayed correctly with some input signals.	-	-	✓

OPERATIONS (continued)

Input Menu

The following functions are available when INPUT is selected on the menu. Select an item with the **▲** and **▼** buttons, and start or stop operation with the **▶** and **◀** buttons. The function indicated (**) are effective on video input mode only, not on RGB input mode, except in the P.IN P. window on RGB input mode.

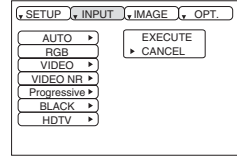

Table 5. Input Menu

Item	Description
AUTO	<p>Automatic Adjustment at RGB Input: Select the EXECUTE with the ▲ button. Horizontal position (H.POSIT), vertical position (V.POSIT), clock phase (H.PHASE), and horizontal size (H.SIZE) are automatically adjusted. Use with the window at maximum size in the application display.</p> <p>Automatic Adjustment at Video Input: Select the EXECUTE with the ▲ button. A signal type appropriate for the input signal is selected automatically when EXECUTE is selected automatically. Valid only when AUTO is set for VIDEO on the menu.</p> <ul style="list-style-type: none"> • This operation requires approximately 10 seconds. It may not function correctly with some input signals. Pressing the AUTO button in this case may correct this problem. • This function is the same as for the AUTO function in Basic operation.
RGB	<p>Displays RGB Input Frequency: Displays the horizontal and vertical sync signal frequencies for RGB input.</p> <ul style="list-style-type: none"> • Valid only at RGB input.
VIDEO (**)	<p>Select Video Signal Type: Select the signal type with the ▲ and ▼ buttons. Select NTSC, PAL, SECAM, NTSC4.43, M-PAL, or N-PAL as appropriate for the input signal. The selection of AUTO enables and executes the function AUTO (Automatic Adjustment at Video Input), except for the N-PAL input.</p> <ul style="list-style-type: none"> • Use this function when the image becomes unstable (eg. the image becomes irregular, or lacks color) at VIDEO/S-VIDEO input. • Automatic Adjustment requires approximately 10 seconds. It may not function correctly with some input signals. Pressing the AUTO button in this case may correct this problem except for the N-PAL input. • For the COMPONENT VIDEO input, this function is not effective and the signal type is distinguished automatically. Refer to the item HDTV of the OPT. Menu for the signal of HDTV.
VIDEO NR (**)	<p>Set/Clear Noise Reduction Mode: Select the TURN ON / TURN OFF with the ▲ / ▼ button. When the TURN ON is selected, the NR mode is active and the noise on screen of the video input will be reduced.</p> <ul style="list-style-type: none"> • Valid except for the HDTV.
Progressive (**)	<p>Select Progressive Mode: Select the mode suitable for the input signal with the ▲ and ▼ buttons. The TV mode and the FILM mode convert the interlaced video signal into the progressive signal. The FILM mode is adaptable 2-3 Pull-Down system to the conversion.</p> <ul style="list-style-type: none"> • Use this function to raise resolution, at the interlaced video input except HDTV signal.
BLACK(**)	<p>Set/Clear Black Enhancement Mode: Select the TURN ON / TURN OFF with the ▲ / ▼ button. When the TURN ON is selected, the black enhancement mode is active and the contrast ratio of the screen for the video input will be raised by making black level darker.</p>
HDTV (**)	<p>Select HDTV mode: Select the 1035i mode or 1080i mode suitable for the input signal with the ▲ / ▼ button.</p>

OPERATIONS (continued)

Image Menu

The following adjustments and settings are available when IMAGE is selected on the menu. Select an item with the **▲** and **▼** buttons, and start or stop operation with the **▶** and **◀** buttons.

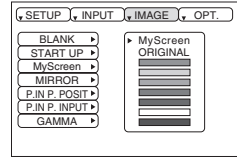

Table 6. Image Menu

Item	Description
BLANK	<p>Select Blank Screen: Select the screen in case of the BLANK mode with the ▲ / ▼ button. The selected one (MyScreen, ORIGINAL or one colors) is displayed when the BLANK mode is ON.</p> <p>MyScreen is a mode that the customer-customized screen is displayed. This is the blue screen at the factory setting. Refer to the description of MyScreen below.</p> <p>ORIGINAL is a mode that the factory fixed screen is displayed.</p> <ul style="list-style-type: none"> When MyScreen or ORIGINAL is selected, the screen is going to the black after several minutes.
START UP	<p>Select Start Up Screen: Select the screen in case of no signal input with the ▲ / ▼ button. The selected one (MyScreen, ORIGINAL or TURN OFF) is displayed when no signal is input</p> <p>MyScreen is a mode that the customer-customized screen is displayed. This is the blue screen at the factory setting. Refer to the description of MyScreen below.</p> <p>ORIGINAL is a mode that the factory fixed screen is displayed.</p> <p>TURN OFF displays the blue screen.</p> <ul style="list-style-type: none"> When MyScreen or ORIGINAL is selected, the screen is going to the black after several minutes.
MyScreen	<p>Set MyScreen Mode: Select the EXECUTE with the ▶ button to display the MyScreen menu and set the MyScreen mode for BLANK and START UP functions. ESC clears and closes the menu box.</p> <p>NORM. is default of the MyScreen menu.</p> <p>FREEZE freezes the image and displays the frame to capture. Press the ▶ button after freeze to go to the MyScreen Capture Position mode. <u>In the MyScreen Capture Position mode</u>, the buttons ▼, ▲, ◀ and ▶ allow to move the frame to capture. After adjusting the position, press the KEYSTONE button to go to the MyScreen Display Size mode. To cancel freezing and return to the NORM. of the MyScreen menu, press the RESET button.</p> <p><u>In the MyScreen Display Size mode</u>, select the magnification x1, x2 or FULL with the button ◀ / ▶. After selecting the magnification, press the KEYSTONE button to go to the CAPT. mode and start capturing. To return to the MyScreen Capture Position mode, press the RESET button. CAPT. executes a capturing the image. It requires about 20 seconds. After capturing, the captured image will be displayed for about 10 seconds.</p>
MIRROR	<p>Select Mirror Status: Select mirror status with ▲ / ▼ button.</p>
P. IN P. POSIT	<p>Select Position of P. in P. Display : Press the ▲ / ▼ button.</p> <p><input type="checkbox"/> ▲ ↔ ▼ <input type="checkbox"/> ▲ ↔ ▼ <input type="checkbox"/> ▲ ↔ ▼ <input type="checkbox"/></p> <ul style="list-style-type: none"> P.IN P. function superimposes a video image over RGB or DVI signals.
P. IN P. INPUT	<p>Select signal of P. in P. Display : Press the ▲ / ▼ button.</p> <p>VIDEO ▲ ↔ ▼ S-VIDEO ▲ ↔ ▼ COMPONENT</p>
GAMMA	<p>Select Gamma Mode: Select the gamma mode with the ▲ / ▼ button.</p> <p>NORMAL ▲ ↔ ▼ CINEMA ▲ ↔ ▼ DYNAMIC</p>

OPERATIONS (continued)

Options Menu

The following adjustments and settings are available when OPT. is selected on the menu. Select an item with the **▲** and **▼** buttons, and start operation.

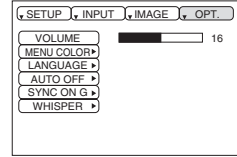

Table 7. Options Menu

Item	Description
VOLUME	Volume Adjustment: Reduce VOLUME ◀ ↔ Increase VOLUME ▶
MENU COLOR	Select Menu Background Color: Select with the ▶ and ◀ buttons.
LANGUAGE	Operation Start/Stop: Press the ▶ / ◀ button. Select Menu Display Language: Select with the ▲ and ▼ buttons.
AUTO OFF	Operation Start/Stop: Press the ▶ / ◀ button. Set AUTO OFF: Set 1~99 minutes with the ▲ and ▼ buttons. The system automatically enters the standby mode when a signal is not received for the set time. Clear AUTO OFF: Select STOP (0 min.) with the ▼ button. When STOP is selected the system does not enter the standby mode even if no signal is received.
SYNC ON G	Operation Start/Stop: Press the ▶ / ◀ button. SYNC ON G Valid: Select TURN ON with the ▲ button. SYNC ON G Invalid: Select TURN OFF with the ▼ button. • May not be displayed correctly with some input signals when SYNC ON G is valid. In such cases, remove the signal connector so that no signal is received, set SYNC ON G to invalid, and reconnect the signal.
WHISPER	Set / Crear WHISPER Mode: Press the ▲ / ▼ button. When the WHISPER is selected, the WHISPER mode is active. In the WHISPER mode, acoustic noise level from the unit is reduced, and brightness level on screen is a little lower.

OPERATIONS (continued)

No Signal Menu

The same adjustments and settings are available with the Image and Options menus when the MENU button is pressed during display of the “NO INPUT IS DETECTED ON ***” or “SYNC IS OUT OF RANGE ON ***” message while no signal is received.

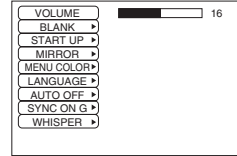

Table 8. No Signal Menu

Item	Description
VOLUME	<p>Volume Adjustment: Reduce VOLUME ◀ ↔ Increase VOLUME ▶</p> <ul style="list-style-type: none"> When this function is used, audio input is automatically switched to video. The audio input can be switched by moving the DISK PAD left and right during the display of the volume adjustment bar. The volume adjustment bar is displayed by pressing VOLUME ◀ or VOLUME ▶ button.
BLANK	<p>Select Blank Screen: Select the screen in case of the BLANK mode with the ▲ / ▼ button. The selected one (MyScreen, ORIGINAL or one colors) is displayed when the BLANK mode is ON.</p> <p>MyScreen is a mode that the customer-customized screen is displayed. This is the blue screen at the factory setting. Refer to the description of MyScreen below.</p> <p>ORIGINAL is a mode that the factory fixed screen is displayed.</p> <ul style="list-style-type: none"> When MyScreen or ORIGINAL is selected, the screen is going to the black after several minutes.
START UP	<p>Select Start Up Screen: Select the screen in case of no signal input with the ▲ / ▼ button. The selected one (MyScreen, ORIGINAL or TURN OFF) is displayed when no signal is input</p> <p>MyScreen is a mode that the customer-customized screen is displayed. This is the blue screen at the factory setting. Refer to the description of MyScreen below.</p> <p>ORIGINAL is a mode that the factory fixed screen is displayed.</p> <p>TURN OFF displays the blue screen.</p> <ul style="list-style-type: none"> When MyScreen or ORIGINAL is selected, the screen is going to the black after several minutes.
MIRROR	<p>Operation Start/Stop: Press the ▶ / ◀ button.</p> <p>Select Mirror Status: Select the mirror status with the ▲ and ▼ buttons.</p>
MENU COLOR	<p>Select Menu Background Color: Select the color with the ▶ and ◀ buttons.</p>
LANGUAGE	<p>Operation Start/Stop: Press the ▶ / ◀ button.</p> <p>Select Menu Display Language: Select the language with the ▲ and ▼ buttons.</p>
AUTO OFF	<p>Operation start/stop: Press the ▶ / ◀ button.</p> <p>Set AUTO OFF: Set 1~99 minutes with the ▲ and ▼ buttons. The system automatically enters the standby mode when a signal is not received for the set time.</p> <p>Clear AUTO OFF: Select the STOP (0 min.) with the ▼ button. When the STOP is selected the system does not enter the standby mode even if no signal is received.</p>
SYNC ON G	<p>Operation Start/Stop: Press the ▶ / ◀ button.</p> <p>SYNC ON G Valid: Select the TURN ON with the ▲ button.</p> <p>SYNC ON G Invalid: Select the TURN OFF with the ▼ button.</p> <ul style="list-style-type: none"> May not be displayed correctly with some input signals when the SYNC ON G is valid. In such cases, remove the signal connector so that no signal is received, set the SYNC ON G to invalid, and reconnect the signal.
WHISPER	<p>Set / Crear WHISPER Mode: Press the ▲ / ▼ button. When the WHISPER is selected, the WHISPER mode is active. In the WHISPER mode, acoustic noise level from the unit is reduced, and brightness level on screen is a little lower.</p>

MAINTENANCE

Lamp



**HIGH VOLTAGE
HIGH TEMPERATURE
HIGH PRESSURE**

Contact your dealer before replacing the lamp.

For the optional lamp, see the item "Option Parts" of the Table 12.

Before replacing the lamp, switch power OFF, remove the power cord from the power outlet, and wait approximately 45 minutes until the lamp has cooled. The lamp may explode if handled at high temperatures.



WARNING A mercury lamp used in this LCD projector is made of glass and has high internal pressure. The mercury lamp can burst with a big noise due to deterioration resulting from a shock, crack and passage of time, and can end its service life in unlit condition. Lamps also have a considerably different service life and can sometimes end up in burst or turn to unlit condition soon after use. Furthermore, when the lamp is blown up, glass fragments can get scattered around the lamp house and some gas containing mercury inside the lamp can leak out of the projector's air vent.

- Handle the lamp with utmost care as it can burst during use if subjected to a shock or impact or if scratched or cracked.
- Probability for the burst will increase if the lamp is used for extended period of time or used exceeding the period of replacement. You are advised to follow instructions for lamp replacement as soon as they are given (Refer to Table 9 of Page 20, Table 10 of Page 21). Avoid any reuse of an old lamp (used lamp) since such reuse can result in burst.
- In case the lamp gets blown up in a short period of time after use, some electrical failures or troubles other than the lamp itself may be suspected as causes. Under such circumstances, consult the store where you purchased it or a service company.
- Should the lamp burst (accompanied by a big bursting noise), perform ventilation sufficiently, and exercise maximum caution not to inhale any gas out of the projector's air vent or not to let it enter your eyes or mouth.
- Should the lamp burst (accompanied by a big bursting noise), make absolutely sure to unplug the power cord from the outlet and ask the store where you bought the lamp for immediate replacement. You should not engage in cleanup or replacement of the lamp by yourself since scattered glass fragments can damage the inside of projector or can result in personal injury when you handle it.
- When you dispose of any used lamps, be sure to observe and follow local ordinances and regulations of the area or district where they are subjected to disposal. Generally speaking, the lamps are treated similarly as glasses and bottles in most cases, but there are areas or districts where lamps are classified as a separate collection, and so be sure to use caution.
- Never use the lamp in a state where the lamp cover is removed.

Lamp Life

Projector lamps have a finite life. The image will become darker, and hues will become weaker, after a lamp has been used for a long period of time.

Replace the lamp if the LAMP indicator is red, or the CHANGE THE LAMP message appears when the projector is switched ON. See Table 9 of P.20 and Table 10 of P.21.

NOTE • The LAMP indicator is also red when the lamp unit reaches high temperature. Before replacing the lamp, switch power OFF, wait approximately 20 minutes, and switch power ON again. If the LAMP indicator is still red, replace the lamp.

MAINTENANCE (continued)

Replacing the Lamp

1. Switch the projector OFF, remove the power cord from the power outlet, and wait at least 45 minutes for the unit to cool.
2. Prepare a new lamp.
3. Check that the projector has cooled sufficiently, and gently turn it upside down.
4. Loosen the screw as shown in the diagram, and remove the lamp cover.
5. Loosen the two screws, and gently remove the lamp while holding the grips. Touching the inside of the lamp case may result in uneven coloring.
6. Install the new lamp and tighten the two screws firmly. Also steadily push the opposite side of the screwed lamp into the unit.
7. Replace the lamp cover in position and tighten the screw firmly.
8. Gently turn the projector right-side up.

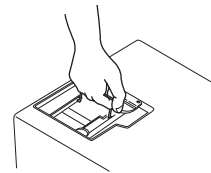
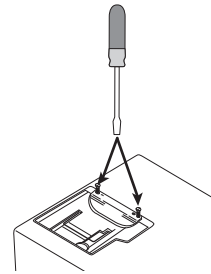
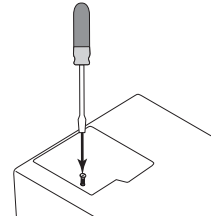

CAUTION • Ensure that screws are tightened properly. Screws not tightened fully may result in injury or accidents.
• Do not use the projector with the lamp cover removed.

Resetting the Lamp Timer

Reset the lamp timer after replacing the lamp. When the lamp has been replaced after the LAMP indicator is red, or the CHANGE THE LAMP message is displayed, complete the following operation within ten minutes of switching power ON. The power will be turned off automatically in over 10 minutes.

1. Switch power ON, and press the RESET button, for approximately three seconds. The 'LAMP xxxx hr' message will appear on the lamp timer on the bottom of the screen.
2. Press the MENU button on the remote control transmitter, or the RESET button on the control panel, while the lamp timer is displayed. The 'LAMP xxxx □ → 0 ■ CANCEL' message will then appear.
3. Press the  and select 0, and wait until the timer display is cleared.

NOTE • Do not reset the lamp timer without replacing the lamp. Reset the lamp timer always when replacing the lamp. The message functions will not operate properly if the lamp timer is not reset correctly.

MAINTENANCE (continued)

Air Filters

Cleaning Air Filters

This projector uses 2 air filters. These air filters should be cleaned as described below at intervals of approximately 100 hours.

1. Switch the projector power supply OFF, and remove the power cord from the power outlet.
2. Remove the filter cover and the air filter.
3. Clean the air filter with a vacuum cleaner.
4. Set the air filter and the filter cover.

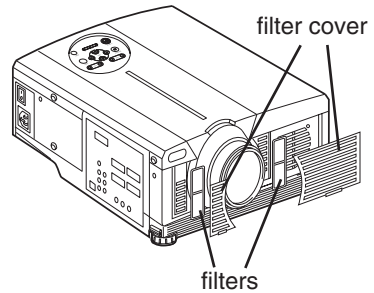

Replacing the Air Filter

Replace the air filter if contamination cannot be removed, or if it is damaged.

1. Switch the projector power supply OFF, and remove the power cord from the power outlet.
2. Remove the filter cover and the old filter.
3. Set the new filter and the filter cover.



CAUTION • Switch power OFF and remove the power cord from the power outlet before beginning maintenance work. Please read the separate “Safety Instruction” thoroughly to ensure that maintenance is performed correctly.

- Replace the air filter if contamination cannot be removed, or if it is damaged. Contact your dealer in such case. For the optional air filter, see the item “Optional Parts” of the Table 12.

- Do not use the equipment with the air filter removed.
- When the air filter is clogged with dust etc. the power supply is switched OFF automatically to prevent the temperature rising inside the projector.

Other Maintenance

Maintenance Inside the Equipment

For safety reasons, ensure that the equipment is cleaned and checked by the dealer once every two years. Maintaining the equipment by yourself is dangerous.

Cleaning the Lens

Gently wipe the lens with lens cleaning paper. Do not touch the lens with your hands.

Cleaning the Cabinet and Remote control transmitter

Gently wipe with a soft cloth. If dirt and stains etc. are not easily removed, use a soft cloth dampened with water, or water and a neutral detergent, and wipe dry with a soft, dry cloth.



CAUTION • Switch power OFF and remove the power cord from the power outlet before beginning maintenance work. Please read the separate “Safety Instruction” thoroughly to ensure that maintenance is performed correctly.

- Do not use detergents or chemicals other than those noted above (e.g. benzene or thinners).

- Do not use cleaning sprays.
- Do not rub with hard materials, or tap the equipment.

NOTE • When this projector is brought into a warm room from a cold outdoor, condensation can take place on the projection lens and mirror inside, blurring the screen and reducing your eyesight, but do not worry. The condensation will disappear and the screen will return to a normal condition no sooner than the projector acclimates to the surrounding temperature.

TROUBLESHOOTING

OSD Message

The messages as described below may appear on the screen at power ON. Take the appropriate measures when such messages appears.

Table 9. OSD Message

Message	Contents
CHANGE THE LAMP AFTER REPLACING LAMP, RESET THE LAMP TIME. (*1)	The usage time of lamp will be reaching 2000 hr shortly.(*2) It is recommended to replace the lamp soon. Prepare a new lamp as a replacement.
CHANGE THE LAMP AFTER REPLACING LAMP, RESET THE LAMP TIME. THE POWER WILL TURN OFF AFTER ** hr. (*1)	The usage time of lamp will be reaching 2000 hr shortly. It is recommended to replace the lamp within * * hours.(*2) It might be happened that the lamp is cut off before * * hr by any chance. Power will be switched OFF automatically in * * hours. Replace the lamp as shown in P.17~18 "Lamp". Always reset the lamp timer after replacing the lamp.
CHANGE THE LAMP AFTER REPLACING LAMP, RESET THE LAMP TIME. THE POWER WILL TURN OFF AFTER 0 hr.	The usage time of lamp is about to reach. Power will be switched OFF in a few minutes.(*2) Switch power OFF immediately and replace the lamp as shown in P.17 ~18 "Lamp". Always reset the lamp timer after replacing the lamp.
NO INPUT IS DETECTED ON ***	No input signal found. Check signal input connections and signal sources.
SYNC IS OUT OF RANGE ON ***	The horizontal or vertical frequency of the input signal is not within the specified range. Check the specifications of the equipment and the signal source.
CHECK THE AIR FLOW	The internal temperature has risen. Switch power OFF, and wait 20 minutes until the equipment cools. Check the following and Switch power ON again. * Are the ventilation openings blocked. * Is the air filter dirty. * Is the ambient temperature in excess of 35°C.

NOTE (*1) This message is cleared automatically after approximately three minutes, and appears every time power is switched ON.

(*2) The unit has a function to turn the power off which will be active when the usage time reaches 2000 hr. However the life of lamp might be much different among lamps, so that it might be happened that a lamp is cut off before the function is active.

TROUBLESHOOTING (continued)

Indicators Message

The POWER indicator, LAMP indicator, and TEMP indicator are lit and blank as follows. Take the appropriate measures.

Table 10. Indicators Message

POWER indicator	LAMP indicator	TEMP indicator	Contents
Lights orange	Turns off	Turns off	The Standby mode has been set.
Blinks green	Turns off	Turns off	Warming up. Please wait.
Lights green	Turns off	Turns off	ON. Normal operation possible.
Blinks orange	Turns off	Turns off	Cooling. Please wait.
Lights red	Lights red	Turns off	Lamp is not lit. The interior of the equipment may be too hot. Switch power OFF, wait 20 minutes until the equipment cools, and check whether the ventilation openings are blocked, whether the air filter is dirty, or whether the ambient temperature exceeds 35 °C. And switch power ON again. Replace the lamp if the same problem occurs.
Lights red	Blinks red	Turns off	Lamp or lamp cover is not found, or hasn't been fitted in correctly. Switch power OFF, and wait for 45 minutes until the equipment cools. Check fitting of the lamp and lamp cover, and switch power ON again. Contact your dealer if the same problem occurs again.
Lights red	Turns off	Blinks red	The cooling fan is not operating. Switch power OFF, and wait for 20 minutes until the equipment cools. Check for foreign matters in the fan, and switch power ON again. Contact your dealer if the same problem occurs again.
Lights red	Turns off	Lights red	The interior of the equipment is too hot. Switch power OFF, and wait for 20 minutes until the equipment cools. Check whether the ventilation openings are blocked, whether the air filter is dirty, or whether the ambient temperature exceeds 35 °C. Then switch power ON again. Contact your dealer if the same problem occurs again.



NOTE When the internal temperature becomes excessive power is switched OFF automatically for safety reasons, and the indicator is extinguished. Set the power switch to [O] and wait for 20 minutes until the equipment has cooled sufficiently.

TROUBLESHOOTING (continued)

Symptom

Before requesting repair, check in accordance with the following chart. If the situation cannot be corrected, then contact your dealer.

Table 11. Symptom

Symptom	Possible cause	Remedy	Page
The power is not turned on.	The main power switch is not turned on.	Turn on the main power switch.	8,9
	The power cord is disconnected.	Plug the power cord into an AC power outlet.	
	The main power was disconnected during operation by the power failure and so on.	Turn off the projector with the main power switch (set the power switch to [O]), and wait for about 20 minutes. When the equipment has cooled enough, turn power on.	9
No video or audio.	The input is not correctly set.	Use the projector or remote control transmitter to set.	10
	No signal input.	Connect correctly.	7,8
Video is present but no audio.	The projector is not correctly connected.	Connect correctly.	7,8
	The volume is set to minimum.	Press VOLUME  on the remote control or display the menu screen and adjust the volume.	11,15
	Mute is turned on.	Press the MUTE  button.	11
Audio is present but no video.	The projector is not correctly connected.	Connect correctly.	7,8
	The brightness adjustment knob is rotated fully clockwise.	Select BRIGHT with the MENU button and the press the  button.	12
	The lens cap is still attached.	Remove the lens cap.	9
Colors are pale and color matching is poor.	Color density and color matching are not correctly adjusted.	Adjust the video.	12
Images are dark.	Brightness and contrast are not correctly adjusted.	Adjust the video.	12
	The lamp is nearing the end of its service life.	Replace with a new lamp.	17
Video is blurred.	Focus or H PHASE is out of adjustment.	Adjust the focus or H PHASE.	9,12

SPECIFICATIONS

Table 12. Specifications

Item			Specification
Product name			Liquid crystal projector
Liquid crystal panel	Panel size	3.3 cm (1.3 type)	
	Drive system	TFT active matrix	
	Pixels	786,432 pixels (1024 horizontal x 768 vertical)	
Lens			Zoom lens F=1.7 ~ 2.3 f=49.0 ~ 64.0 mm
Lamp			275 W UHB
Speaker			1.2 W + 1.2W (Stereo)
Power supply			AC100 ~ 120V, 4.7A / AC220 ~ 240V, 2.0A
Power consumption			440W
Temperature range			0 ~ 35°C (Operating)
Size			289 (W) x 144 (H) x 350 (D) mm
Weight (mass)			6.5 kg
RGB signal input	RGB IN	1	Video: Analog 0.7Vp-p, 75Ω terminator (positive) H/V. sync.: TTL level (positive/negative) Composite sync.: TTL level D-sub 15-pin shrink jack
		2	
	DVI		TMDS, DC: 150~1200 mV / AC: 1.56 Vp-p TTL Level (Positive/Negative)
	AUDIO IN	RGB1	200mVrms, 50 kΩ (max. 3.0Vp-p) Stereo mini jack
DVI			
RGB2			
Video signal input	VIDEO		1.0Vp-p, 75Ω terminator RCA jack
	S-VIDEO		Brightness signal: 1.0Vp-p, 75Ω terminator Color signal: 0.286Vp-p (burst signal), 75Ω terminator Mini DIN 4-pin jack
	COMPONENT VIDEO	Y	1.0 Vp-p, 75 Ω Terminator (Positive)
		Cb/Pb	0.7 Vp-p, 75 Ω Terminator (Positive)
		Cr/Pr	0.7 Vp-p, 75 Ω Terminator (Positive)
	AUDIO	L/MONO	200mVrms, 50 kΩ (max. 3.0Vp-p)
R		RCA jack	
Signal output	RGB OUT		Video: Analog 0.7Vp-p, 75Ω output impedance (positive) H/V. sync.: TTL level (positive/negative) Composite sync.: TTL level D-sub 15-pin shrink jack
	AUDIO OUT		200mVrms, output impedance 1 kΩ (max. 3.0Vp-p) Stereo mini jack
Control functions	CONTROL		D-sub 15-pin shrink plug
	USB		USB jack (B type)
Optional Parts			Lamp: DT00491 Air Filter: MN04531 * For others, consult your dealer.

NOTE • This specifications are subject to change without notice.

TECHNICAL

Dimension Diagram

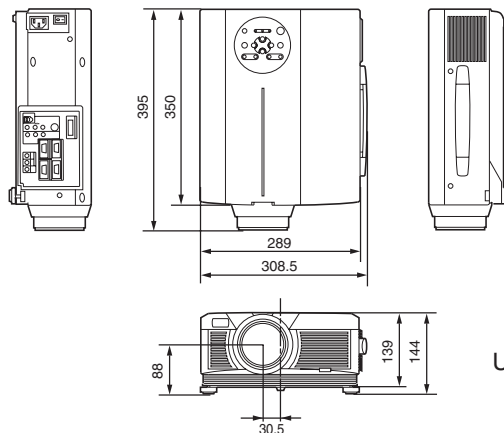

Unit : mm

Signal Connector Pin Assignment

1. D-sub 15-pin Shrink Connector (RGB IN 1/RGB IN 2/RGB OUT)

Pin No	Signal	Pin No	Signal	Pin No	Signal
1	Video input Red	9	-	15	RGB IN 1: SCL(DDC)
2	Video input Green	10	Ground		RGB IN 2: -
3	Video input Blue	11	-		RGB OUT: -
4	-	12	RGB IN 1: SDA(DDC)		
5	Ground		RGB IN 2: -		
6	Ground Red		RGB OUT: -		
7	Ground Green	13	H. sync./ Composite sync.		
8	Ground Blue	14	Vertical sync		

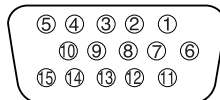

2. Digital Receptacle Connector (DVI)

Pin No	Signal	Pin No	Signal	Pin No	Signal
1	T.M.D.S. Data 2 -	11	T.M.D.S. Data 1 / 3 Shield	21	-
2	T.M.D.S. Data 2 +	12	-	22	T.M.D.S. Clock Shield
3	T.M.D.S. Data 2 / 4 Shield	13	-	23	T.M.D.S. Clock +
4	-	14	+5V Power	24	T.M.D.S. Clock -
5	-	15	Ground (+5V, Analog H/V Sync.)		
6	DDC Clock	16	Hot-Plug Sense		
7	DDC Data	17	T.M.D.S. Data 0 -		
8	Analog V. Sync.	18	T.M.D.S. Data 0 +		
9	T.M.D.S. Data 1 -	19	T.M.D.S. Data 0 / 5 Shield		
10	T.M.D.S. Data 1 +	20	-		

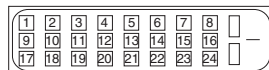

3. Mini Din 4-pin Connector (S-VIDEO)

Pin No	Signal
1	Color:0.286Vp-p (NTSC, burst signal),75Ω terminator 0.3Vp-p (PAL/SECAM, burst signal),75Ω terminator
2	Brightness:1.0Vp-p, 75Ω terminator
3	Ground
4	Ground

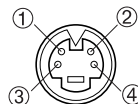

TECHNICAL

TECHNICAL (continued)

Example of computer signal

Resolution H x V	fH (kHz)	fV (Hz)	Rating	Signal mode	Display mode
720 x 400	37.9	85.0	VESA	TEXT	Zoom in
640 x 480	31.5	59.9	VESA	VGA (60Hz)	Zoom in
640 x 480	35.0	66.7		Mac13" mode	Zoom in
640 x 480	37.9	72.8	VESA	VGA (72Hz)	Zoom in
640 x 480	37.5	75.0	VESA	VGA (75Hz)	Zoom in
640 x 480	43.3	85.0	VESA	VGA (85Hz)	Zoom in
800 x 600	35.2	56.3	VESA	SVGA (56Hz)	Zoom in
800 x 600	37.9	60.3	VESA	SVGA (60Hz)	Zoom in
800 x 600	48.1	72.2	VESA	SVGA (72Hz)	Zoom in
800 x 600	46.9	75.0	VESA	SVGA (75Hz)	Zoom in
800 x 600	53.7	85.1	VESA	SVGA (85Hz)	Zoom in
832 x 624	49.7	74.5		Mac16" mode	Zoom in
1024 x 768	48.4	60.0	VESA	XGA (60Hz)	
1024 x 768	56.5	70.1	VESA	XGA (70Hz)	
1024 x 768	60.0	75.0	VESA	XGA (75Hz)	
1024 x 768	68.7	85.0	VESA	XGA (85Hz)	
1152 x 864	67.5	75.0	VESA	SXGA (75Hz)	Zoom out
1280 x 960	60.0	60.0	VESA	SXGA (60Hz)	Zoom out
1280 x 1024	64.0	60.0	VESA	SXGA (60Hz)	Zoom out
1280 x 1024	80.0	75.0	VESA	SXGA (75Hz)	Zoom out
1600 x 1200	75.0	60.0	VESA	VXGA (60Hz)	Zoom out

- NOTE** • Some computers may have multiple display screen modes. Use of some of these modes will not be possible with this projector.
- Be sure to check jack type, signal level, timing and resolution before connecting this projector to a computer.
 - Depending on the input signal, full-size display may not be possible in some cases. Refer to the number of display pixels above.
 - The image may not be displayed correctly when the input sync. signal is "Composite Sync." or "Sync. on G".
 - The image might be something wrong with computer by computer on the DVI mode. In the case, it is recommended to reduce the resolution and / or refresh rate.

TECHNICAL (continued)

Initial set signals

The following signals are used for the initial settings.

The signal timing of some computer models may be different. In such case, refer to adjust the V.POSIT and H.POSIT of the menu.

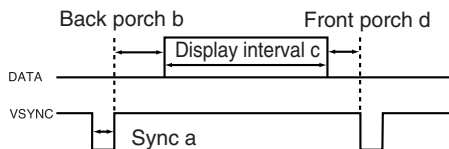
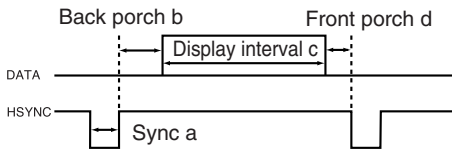

Computer / Signal	Horizontal signal timing (μs)			
	a	b	c	d
TEXT	2.0	3.0	20.3	1.0
VGA (60Hz)	3.8	1.9	25.4	0.6
Mac 13"mode	2.1	3.2	21.2	2.1
VGA (72Hz)	1.3	3.8	20.3	1.0
VGA (75Hz)	2.0	3.8	20.3	0.5
VGA (85Hz)	1.6	2.2	17.8	1.6
SVGA (56Hz)	2.0	3.6	22.2	0.7
SVGA (60Hz)	3.2	2.2	20.0	1.0
SVGA (72Hz)	2.4	1.3	16.0	1.1
SVGA (75Hz)	1.6	3.2	16.2	0.3
SVGA (85Hz)	1.1	2.7	14.2	0.6
Mac 16"mode	1.1	3.9	14.5	0.6
XGA (60Hz)	2.1	2.5	15.8	0.4
XGA (70Hz)	1.8	1.9	13.7	0.3
XGA (75Hz)	1.2	2.2	13.0	0.2
XGA (85Hz)	1.0	2.2	10.8	0.5
1152×864 (75Hz)	1.2	2.4	10.7	0.6
1280×960 (60Hz)	1.0	2.9	11.9	0.9
1280×1024 (60Hz)	1.0	2.3	11.9	0.4
1280×1024 (75Hz)	1.1	1.8	9.5	0.1
1600×1200 (60Hz)	1.2	1.9	9.9	0.4

Computer / Signal	Vertical signal timing (lines)			
	a	b	c	d
TEXT	3	42	400	1
VGA (60Hz)	2	33	480	10
Mac 13"mode	3	39	480	3
VGA (72Hz)	3	28	480	9
VGA (75Hz)	3	16	480	1
VGA (85Hz)	3	25	480	1
SVGA (56Hz)	2	22	600	1
SVGA (60Hz)	4	23	600	1
SVGA (72Hz)	6	23	600	37
SVGA (75Hz)	3	21	600	1
SVGA (85Hz)	3	27	600	1
Mac 16"mode	3	39	624	1
XGA (60Hz)	6	29	768	3
XGA (70Hz)	6	29	768	3
XGA (75Hz)	3	28	768	1
XGA (85Hz)	3	36	768	1
1152×864 (75Hz)	3	32	864	1
1280×960 (60Hz)	3	36	960	1
1280×1024 (60Hz)	3	38	1024	1
1280×1024 (75Hz)	3	38	1024	1
1600×1200 (60Hz)	3	46	1200	1

TECHNICAL (continued)

Connection to the Mouse Control

1. PS/2, ADB or Serial Mouse

- (1) Turn off the projector and computer, and connect the two units with the appropriate cable. For PS/2 mouse control (for IBM and compatible), use the enclosed mouse cable. For others, consult your dealer.
- (2) Disconnect the USB cable from the projector if it is connected. Then turn on the projector.
- (3) Turn on the computer.
- (4) Start the mouse function. If the mouse has not been started, reboot the computer (soft reboot or reboot buttons). Refer to the descriptions of "DISC PAD" and "MOUSE/RIGHT button" of page 4.

2. USB Mouse

- (1) Connect the projector and computer with a suitable commercially available USB cable. Consult your dealer to get the cable, if you need.
- (2) Start the mouse function. Refer to the descriptions of "DISC PAD" and "MOUSE/RIGHT button" of page 4.

NOTE • Before connecting, read the instruction manuals of the devices to be connected.

• In the case of notebook type computers with an internal pointing device, the mouse control function will not work unless the internal pointing device is disabled. In such case, disable the internal pointing device and change the BIOS setting to select an external mouse before the operations described in (1) to (4) above.

Also, some computers may not have a utility program to operate a mouse.

Refer to the computer hardware manual for detail.

PS/2 Mouse

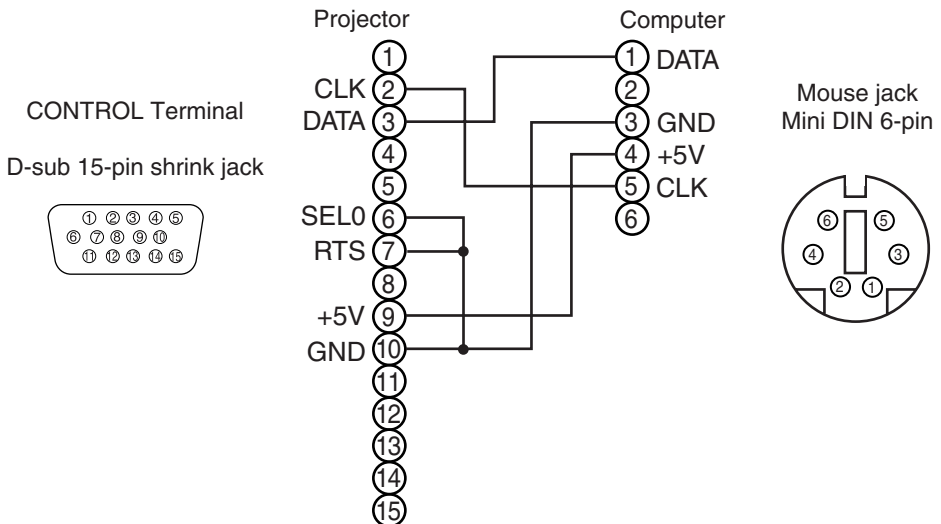

TECHNICAL (continued)

ADB Mouse

CONTROL Terminal

D-sub 15-pin shrink jack

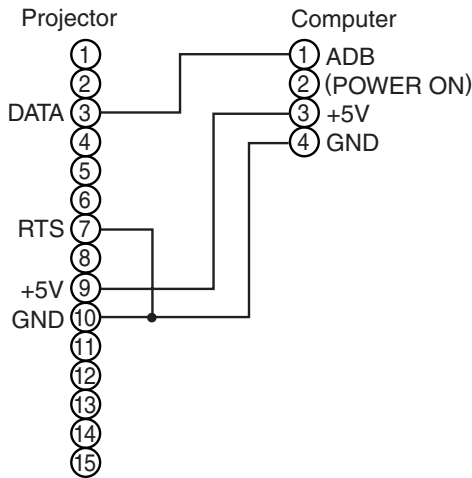
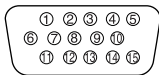

Mouse jack
Mini DIN 4-pin

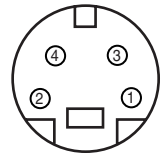

Serial Mouse

CONTROL Terminal

D-sub 15-pin shrink jack

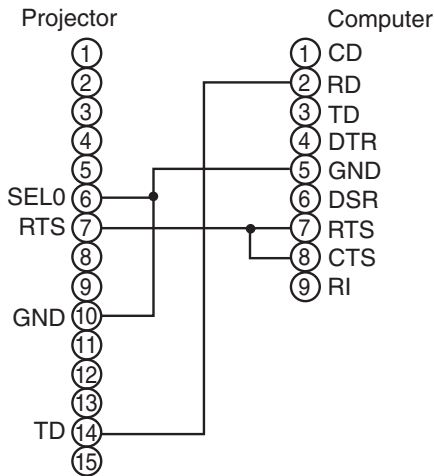
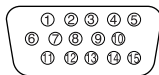

Mouse jack
D-sub 9-pin

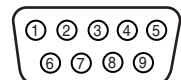

USB Mouse

USB jack
(B type)

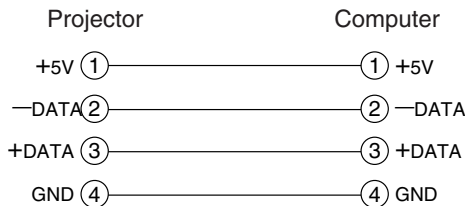
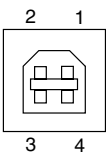

USB cable

USB jack
(A type)

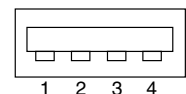

TECHNICAL

TECHNICAL (continued)

RS-232C communication

- (1) Turn off the projector and computer power supplies and connect with the RS-232C cable.
- (2) Turn on the computer power supply and, after the computer has started up, turn on the projector power supply.

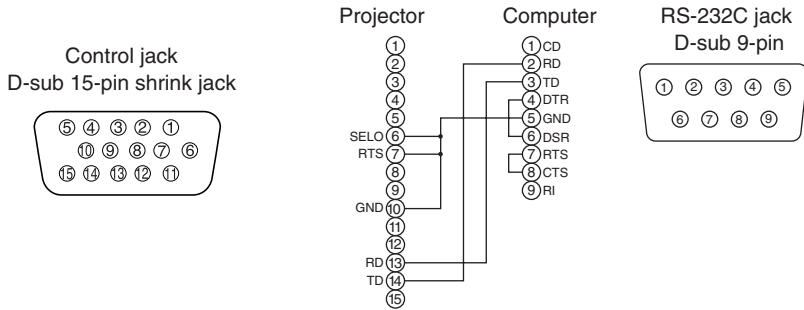

Communications setting

19200bps, 8N1

1 Protocol

Consist of header (7 bytes) + command data (6 bytes).

2 Header

BE + EF + 03 + 06 + 00 + CRC_low + CRC_high

CRC_low : Lower byte of CRC flag for command data.

CRC_high : Upper byte of CRC flag for command data.

3 Command data

Command data chart

byte_0	byte_1	byte_2	byte_3	byte_4	byte_5
Action		Type		Setting code	
low	high	low	high	low	high

Action (byte_0 - 1)

Action	Classification	Content
1	SET	Change setting to desired value.
2	GET	Read projector internal setup value.
4	INCREMENT	Increment setup value by 1.
5	DECREMENT	Decrement setup value by 1.
6	EXECUTE	Run a command.

TECHNICAL (continued)

Requesting projector status (Get command)

- (1) Send the request code Header + Command data ('02H'+ '00H' + type (2 bytes) + '00H'+ '00H') from the computer to the projector.
- (2) The projector returns the response code '1DH'+ data (2 bytes) to the computer.

Changing the projector settings (Set command)

- (1) Send the setting code Header + Command data ('01H'+ '00H' + type (2 bytes) + setting code (2 bytes)) from the computer to the projector.
- (2) The projector changes the setting based on the above setting code.
- (3) The projector returns the response code '06H' to the computer.

Using the projector default settings (Reset Command)

- (1) The computer sends the default setting code Header + Command data ('06H'+ '00H' + type (2 bytes) + '00H'+ '00H') to the projector.
- (2) The projector changes the specified setting to the default value.
- (3) The projector returns the response code '06H' to the computer.

Increasing the projector setting value (Increment command)

- (1) The computer sends the increment code Header + Command data ('04H'+ '00H' + type (2 bytes) + '00H'+ '00H') to the projector.
- (2) The projector increases the setting value on the above setting code.
- (3) The projector returns the response code '06H' to the computer.

Decreasing the projector setting value (Decrement command)

- (1) The computer sends the decrement code Header + Command data ('05H'+ '00H' + type (2 bytes) + '00H'+ '00H') to the projector.
- (2) The projector decreases the setting value on the above setting code.
- (3) The projector returns the response code '06H' to the computer.

When a command sent by the projector cannot be understood by the computer

When the command sent by the projector cannot be understood, the error command '15H' is returned by the computer. Some times, the projector ignores RS-232C commands during other works. If the error command '15H' is returned, please send the same command again.

When data sent by the projector cannot be practice

When the command sent by the projector cannot be practiced, the the error code '1cH' + 'xxxxH' is returned.

When the data length is greater than indicated by the data length code, the projector will ignore the excess data code.

Conversely, when the data length is shorter than indicated by the data length code, an error code will be returned to the projector.

NOTE • Operation cannot be guaranteed when the projector receives an undefined command or data.

- Provide an interval of at least 40ms between the response code and any other code.
- The projector outputs test data when the power supply is switched ON, and when the lamp is lit. Ignore this data.
- Commands are not accepted during warm-up.

TECHNICAL (continued)

Command data chart

Names	Operation type		Header			Command data			
						CRC	Action	Type	Setting code
Blank Color	Set	Red	BE EF	03 06 00	3B D3	01 00	00 30	00 00	
		Orange	BE EF	03 06 00	AB D2	01 00	00 30	01 00	
		Green	BE EF	03 06 00	5B D2	01 00	00 30	02 00	
		Blue	BE EF	03 06 00	CB D3	01 00	00 30	03 00	
		Purple	BE EF	03 06 00	FB D1	01 00	00 30	04 00	
		White	BE EF	03 06 00	6B D0	01 00	00 30	05 00	
		Black	BE EF	03 06 00	9B D0	01 00	00 30	06 00	
		MyScreen	BE EF	03 06 00	FB CA	01 00	00 30	20 00	
	ORIGINAL	BE EF	03 06 00	FB E2	01 00	00 30	40 00		
	Get	BE EF	03 06 00	08 D3	02 00	00 30	00 00		
Mirror	Set	Normal	BE EF	03 06 00	C7 D2	01 00	01 30	00 00	
		H Inverse	BE EF	03 06 00	57 D3	01 00	01 30	01 00	
		V Inverse	BE EF	03 06 00	A7 D3	01 00	01 30	02 00	
		H&V Inverse	BE EF	03 06 00	37 D2	01 00	01 30	03 00	
		Get	BE EF	03 06 00	F4 D2	02 00	01 30	00 00	
Freeze	Set	Normal	BE EF	03 06 00	83 D2	01 00	02 30	00 00	
		Freeze	BE EF	03 06 00	13 D3	01 00	02 30	01 00	
		Get	BE EF	03 06 00	B0 D2	02 00	02 30	00 00	
Menu Color	Set	Red	BE EF	03 06 00	7F D3	01 00	03 30	00 00	
		Orange	BE EF	03 06 00	EF D2	01 00	03 30	01 00	
		Green	BE EF	03 06 00	1F D2	01 00	03 30	02 00	
		Blub	BE EF	03 06 00	8F D3	01 00	03 30	03 00	
		Purple	BE EF	03 06 00	BF D1	01 00	03 30	04 00	
		Transparent	BE EF	03 06 00	2F D0	01 00	03 30	05 00	
		Gray	BE EF	03 06 00	DF D0	01 00	03 30	06 00	
		Get	BE EF	03 06 00	4C D3	02 00	03 30	00 00	
Startup	Set	ORIGINAL	BE EF	03 06 00	0B D2	01 00	04 30	00 00	
		OFF	BE EF	03 06 00	9B D3	01 00	04 30	01 00	
		MyScreen	BE EF	03 06 00	CB CB	01 00	04 30	20 00	
		Get	BE EF	03 06 00	38 D2	02 00	04 30	00 00	
Language	Set	English	BE EF	03 06 00	F7 D3	01 00	05 30	00 00	
		Français	BE EF	03 06 00	67 D2	01 00	05 30	01 00	
		Deutsch	BE EF	03 06 00	97 D2	01 00	05 30	02 00	
		Español	BE EF	03 06 00	07 D3	01 00	05 30	03 00	
		Italiano	BE EF	03 06 00	37 D1	01 00	05 30	04 00	
		Norsk	BE EF	03 06 00	A7 D0	01 00	05 30	05 00	
		Nederlands	BE EF	03 06 00	57 D0	01 00	05 30	06 00	
		Português	BE EF	03 06 00	C7 D1	01 00	05 30	07 00	
		Japanese	BE EF	03 06 00	37 D4	01 00	05 30	08 00	
		Get	BE EF	03 06 00	C4 D3	02 00	05 30	00 00	

TECHNICAL (continued)

Command data chart

Names	Operation type		Header				Command data		
						CRC	Action	Type	Setting code
Magnify	Get		BE EF	03 06 00	7C D2	02 00	07 30	00 00	
	Increment		BE EF	03 06 00	1A D2	04 00	07 30	00 00	
	Decrement		BE EF	03 06 00	CB D3	05 00	07 30	00 00	
Auto off	Get		BE EF	03 06 00	08 86	02 00	10 31	00 00	
	Increment		BE EF	03 06 00	6E 86	04 00	10 31	00 00	
	Decrement		BE EF	03 06 00	BF 87	05 00	10 31	00 00	
Brightness Reset	Execute		BE EF	03 06 00	58 D3	06 00	00 70	00 00	
Contrast Reset	Execute		BE EF	03 06 00	A4 D2	06 00	01 70	00 00	
V.Position Reset	Execute		BE EF	03 06 00	E0 D2	06 00	02 70	00 00	
H.Position Reset	Execute		BE EF	03 06 00	IC D3	06 00	03 70	00 00	
H.Size Reset	Execute		BE EF	03 06 00	68 D2	06 00	04 70	00 00	
Color Balance R Reset	Execute		BE EF	03 06 00	94 D3	06 00	05 70	00 00	
Color Balance B Reset	Execute		BE EF	03 06 00	D0 D3	06 00	06 70	00 00	
Sharpness Reset	Execute		BE EF	03 06 00	C4 D0	06 00	09 70	00 00	
Color Reset	Execute		BE EF	03 06 00	80 D0	06 00	0A 70	00 00	
Tint Reset	Execute		BE EF	03 06 00	7C D1	06 00	0B 70	00 00	
Keystone_V Reset	Execute		BE EF	03 06 00	08 D0	06 00	0C 70	00 00	
Keystone_H Reset	Execute		BE EF	03 06 00	98 D8	06 00	20 70	00 00	
Auto	Execute		BE EF	03 06 00	91 D0	06 00	0A 20	00 00	
Blank on/off	Set	off	BE EF	03 06 00	FB D8	01 00	20 30	00 00	
		on	BE EF	03 06 00	6B D9	01 00	20 30	01 00	
	Get		BE EF	03 06 00	C8 D8	02 00	20 30	00 00	
Error Status	Get		BE EF	03 06 00	D9 D8	02 00	20 60	00 00	
		(Example of Return) 00 00 01 00 02 00 03 00 (Normal) (Cover-error) (Fan-error) (Lamp-error) 04 00 05 00 06 00 (Temp-error) (Air flow-error) (Lamp-Time-over)							
Power	Set	OFF	BE EF	03 06 00	2A D3	01 00	00 60	00 00	
		ON	BE EF	03 06 00	BA D2	01 00	00 60	01 00	
	Get		BE EF	03 06 00	19 D3	02 00	00 60	00 00	
Input Source	Set	RGB1	BE EF	03 06 00	FE D2	01 00	00 20	00 00	
		RGB2	BE EF	03 06 00	3E D0	01 00	00 20	04 00	
		Digital	BE EF	03 06 00	0E D2	01 00	00 20	03 00	
		Video	BE EF	03 06 00	6E D3	01 00	00 20	01 00	
		SVideo	BE EF	03 06 00	9E D3	01 00	00 20	02 00	
		Component	BE EF	03 06 00	AE D1	01 00	00 20	05 00	
	Get		BE EF	03 06 00	CD D2	02 00	00 20	02 00	
Volume	Get		BE EF	03 06 00	31 D3	02 00	01 20	00 00	
	Increment		BE EF	03 06 00	57 D3	04 00	01 20	00 00	
	Decrement		BE EF	03 06 00	86 D2	05 00	01 20	00 00	

TECHNICAL (continued)

Command data chart

Names	Operation type		Header				Command data		
							CRC	Action	Type
Mute	Set	Normal	BE EF	03 06 00	46 D3	01 00	02 20	00 00	
		Mute	BE EF	03 06 00	D6 D2	01 00	02 20	01 00	
	Get	BE EF	03 06 00	75 D3	02 00	02 20	00 00		
Brightness	Get	BE EF	03 06 00	89 D2	02 00	03 20	00 00		
	Increment	BE EF	03 06 00	EF D2	04 00	03 20	00 00		
	Decrement	BE EF	03 06 00	3E D3	05 00	03 20	00 00		
Contrast	Get	BE EF	03 06 00	FD D3	02 00	04 20	00 00		
	Increment	BE EF	03 06 00	9B D3	04 00	04 20	00 00		
	Decrement	BE EF	03 06 00	4A D2	05 00	04 20	00 00		
Color Balance R	Get	BE EF	03 06 00	01 D2	02 00	05 20	00 00		
	Increment	BE EF	03 06 00	67 D2	04 00	05 20	00 00		
	Decrement	BE EF	03 06 00	B6 D3	05 00	05 20	00 00		
Color Balance B	Get	BE EF	03 06 00	45 D2	02 00	06 20	00 00		
	Increment	BE EF	03 06 00	23 D2	04 00	06 20	00 00		
	Decrement	BE EF	03 06 00	F2 D3	05 00	06 20	00 00		
Keystone_V	Get	BE EF	03 06 00	B9 D3	02 00	07 20	00 00		
	Increment	BE EF	03 06 00	DF D3	04 00	07 20	00 00		
	Decrement	BE EF	03 06 00	0E D2	05 00	07 20	00 00		
Keystone_H	Get	BE EF	03 06 00	E9 D0	02 00	0B 20	00 00		
	Increment	BE EF	03 06 00	8F D0	04 00	0B 20	00 00		
	Decrement	BE EF	03 06 00	5E D1	05 00	0B 20	00 00		
Aspect	Set	4:3	BE EF	03 06 00	9E D0	01 00	08 20	00 00	
		16:9	BE EF	03 06 00	0E D1	01 00	08 20	01 00	
		Small	BE EF	03 06 00	FE D1	01 00	08 20	02 00	
	Get	BE EF	03 06 00	AD D0	02 00	08 20	00 00		
Display Position at 16 : 9 or Small	Set	Default	BE EF	03 06 00	62 D1	01 00	09 20	00 00	
		Bottom	BE EF	03 06 00	F2 D0	01 00	09 20	01 00	
		Top	BE EF	03 06 00	02 D0	01 00	09 20	02 00	
	Get	BE EF	03 06 00	51 D1	02 00	09 20	00 00		
V.Position	Get	BE EF	03 06 00	0D 83	02 00	00 21	00 00		
	Increment	BE EF	03 06 00	6B 83	04 00	00 21	00 00		
	Decrement	BE EF	03 06 00	BA 82	05 00	00 21	00 00		
H.Position	Get	BE EF	03 06 00	F1 82	02 00	01 21	00 00		
	Increment	BE EF	03 06 00	97 82	04 00	01 21	00 00		
	Decrement	BE EF	03 06 00	46 83	05 00	01 21	00 00		
H.Size	Get	BE EF	03 06 00	B5 82	02 00	02 21	00 00		
	Increment	BE EF	03 06 00	D3 82	04 00	02 21	00 00		
	Decrement	BE EF	03 06 00	02 83	05 00	02 21	00 00		
H.Phase	Get	BE EF	03 06 00	49 83	02 00	03 21	00 00		
	Increment	BE EF	03 06 00	2F 83	04 00	03 21	00 00		
	Decrement	BE EF	03 06 00	FE 82	05 00	03 21	00 00		

TECHNICAL (continued)

Command data chart

Names	Operation type	Header				Command data					
					CRC	Action	Type	Setting code			
Sharpness	Get	BE	EF	03	06	00	F1 72	02 00	01 22	00 00	
	Increment	BE	EF	03	06	00	97 72	04 00	01 22	00 00	
	Decrement	BE	EF	03	06	00	46 73	05 00	01 22	00 00	
Color	Get	BE	EF	03	06	00	B5 72	02 00	02 22	00 00	
	Increment	BE	EF	03	06	00	D3 72	04 00	02 22	00 00	
	Decrement	BE	EF	03	06	00	02 73	05 00	02 22	00 00	
Tint	Get	BE	EF	03	06	00	49 73	02 00	03 22	00 00	
	Increment	BE	EF	03	06	00	2F 73	04 00	03 22	00 00	
	Decrement	BE	EF	03	06	00	FE 72	05 00	03 22	00 00	
Video Format	Set	Auto	BE	EF	03	06	00	9E 75	01 00	00 22	0A 00
		NTSC	BE	EF	03	06	00	FE 71	01 00	00 22	04 00
		PAL	BE	EF	03	06	00	6E 70	01 00	00 22	05 00
		SECAM	BE	EF	03	06	00	6E 75	01 00	00 22	09 00
		NTSC 4.43	BE	EF	03	06	00	5E 72	01 00	00 22	02 00
		M-PAL	BE	EF	03	06	00	FE 74	01 00	00 22	08 00
	N-PAL	BE	EF	03	06	00	0E 71	01 00	00 22	07 00	
Get	BE	EF	03	06	00	0D 73	02 00	00 22	00 00		
Video NR	Set	off	BE	EF	03	06	00	B6 73	01 00	06 22	00 00
		on	BE	EF	03	06	00	26 72	01 00	06 22	01 00
	Get	BE	EF	03	06	00	85 73	02 00	06 22	00 00	
Progressive	Set	off	BE	EF	03	06	00	4A 72	01 00	07 22	00 00
		TV	BE	EF	03	06	00	DA 73	01 00	07 22	01 00
		FILM	BE	EF	03	06	00	2A 73	01 00	07 22	02 00
	Get	BE	EF	03	06	00	79 72	02 00	07 22	00 00	
Black	Set	off	BE	EF	03	06	00	5E 71	01 00	08 22	00 00
		on	BE	EF	03	06	00	CE 70	01 00	08 22	01 00
	Get	BE	EF	03	06	00	6D 71	02 00	08 22	00 00	
HDTV	Set	1080i	BE	EF	03	06	00	F2 73	01 00	05 22	00 00
		1035i	BE	EF	03	06	00	62 72	01 00	05 22	01 00
	Get	BE	EF	03	06	00	C1 73	02 00	05 22	00 00	
PinP Size	Set	off	BE	EF	03	06	00	FE 22	01 00	00 23	00 00
		Large	BE	EF	03	06	00	6E 23	01 00	00 23	01 00
		Small	BE	EF	03	06	00	9E 23	01 00	00 23	02 00
	Get	BE	EF	03	06	00	Cd 22	02 00	00 23	00 00	

TECHNICAL (continued)

Command data chart

Names	Operation type		Header				Command data								
						CRC	Action	Type	Setting code						
PinP Position	Set	Upper left	BE	EF	03	06	00	02	23	01	00	01	23	00	00
		Upper right	BE	EF	03	06	00	92	22	01	00	01	23	01	00
		bottom left	BE	EF	03	06	00	62	22	01	00	01	23	03	00
		bottom right	BE	EF	03	06	00	F2	23	01	00	01	23	02	00
	Get	BE	EF	03	06	00	31	23	02	00	01	23	00	00	
PinP Audio ch	Set	RGB	BE	EF	03	06	00	BA	22	01	00	03	23	00	00
		Video	BE	EF	03	06	00	2A	23	01	00	03	23	01	00
	Get	BE	EF	03	06	00	89	22	02	00	03	23	00	00	
PinP Input	Set	Video	BE	EF	03	06	00	D6	22	01	00	02	23	01	00
		S-Video	BE	EF	03	06	00	26	22	01	00	02	23	02	00
		Component	BE	EF	03	06	00	16	20	01	00	02	23	05	00
	Get	BE	EF	03	06	00	75	23	02	00	02	23	00	00	
FOCUS	Increment	BE	EF	03	06	00	6A	93	04	00	00	24	00	00	
	Decrement	BE	EF	03	06	00	BB	92	05	00	00	24	00	00	
Zoom	Increment	BE	EF	03	06	00	96	92	04	00	01	24	00	00	
	Decrement	BE	EF	03	06	00	47	93	05	00	01	24	00	00	
Sync on G	Set	off	BE	EF	03	06	00	CB	D0	01	00	08	30	01	00
		on	BE	EF	03	06	00	5B	D1	01	00	08	30	00	00
	Get	BE	EF	03	06	00	68	D1	02	00	08	30	00	00	
WHISPER	Set	NORMAL	BE	EF	03	06	00	3B	23	01	00	00	33	00	00
		WHISPER	BE	EF	03	06	00	AB	22	01	00	00	33	01	00
	Get	BE	EF	03	06	00	08	23	02	00	00	33	00	00	
GAMMA	Set	NORMAL	BE	EF	03	06	00	C7	F0	01	00	A1	30	00	00
		CINEMA	BE	EF	03	06	00	57	F1	01	00	A1	30	01	00
		DYNAMIC	BE	EF	03	06	00	A7	F1	01	00	A1	30	02	00
		6500K	BE	EF	03	06	00	37	F0	01	00	A1	30	03	00
	Get	BE	EF	03	06	00	F4	F0	02	00	A1	30	00	00	

REGULATORY NOTICES

EN 55022 Warning

This is a Class A product. In a domestic environment it may cause radio interference, in which case the user may be required to take adequate measures. The typical use is in a conference room, meeting room or auditorium.

FCC Statement Warning

WARNING: This equipment has been tested and found to comply with the limits for a Class A digital device, pursuant to Part 15 of the FCC Rules. These limits are designed to provide reasonable protection against harmful interference when the equipment is operated in a commercial environment. This equipment generates, uses, and can radiate radio frequency energy and, if not installed and used in accordance with the instruction manual, may cause harmful interference to radio communications. Operation of this equipment in a residential area is likely to cause harmful interference in which case the user will be required to correct the interference at his own expense.

INSTRUCTIONS TO USERS: This equipment complies with the requirements of FCC (Federal Communication Commission) Class A equipments provided that following conditions are met.

The cables may have to be used with the core set to the projector side. Use the cables which are included with the projector or specified.

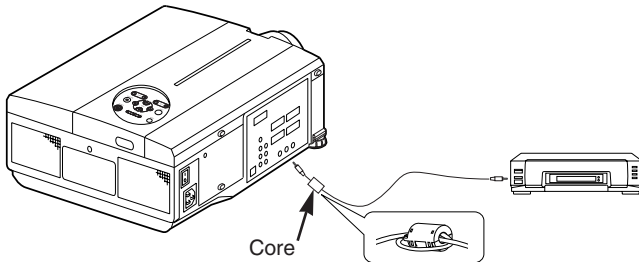

CAUTION: Changes or modifications not expressly approved by the party responsible for compliance could void the user's authority to operate the equipment.

For the Customers in CANADA

NOTICE: This Class A digital apparatus complies with Canadian ICES-003.

Pour les utilisateurs au Canada

AVIS: Cet appareil numérique de la Classe A est conforme à la norme NMB-003 du Canada.

Limited Warranty

InFocus Corporation ("InFocus") warrants that the Projector ("Product") purchased from InFocus, an InFocus distributor, or an InFocus reseller will conform to the manufacturer's specifications and be free from defects in material or workmanship for the Warranty period provided below. InFocus does not warrant that the Product will meet the specific requirement of the end-user customer.

If the Product, which is the subject of this Limited Warranty, is defective in material or workmanship during the warranty period, InFocus, at its option, will REPAIR or REPLACE the Product.

All exchanged parts and products replaced under this Warranty will become property of InFocus. InFocus' sole obligation is to supply (or pay for) all labor necessary to repair the Product found to be defective within the Warranty period and to repair or replace defective parts with new parts or, at the option of InFocus, serviceable used parts that are equivalent or superior to new parts performance.

Limited Warranty Alternatives: Subject to the Limitations, Exclusions and Disclaimers, InFocus Warrants as follows:

- **2 Year Parts and Labor Product Warranty** - From the date of purchase, InFocus warrants that the Product will conform to the manufacturer's specifications and free from defects in material or workmanship for a period of two (2) years.
- **1 Year Parts Only Accessory Warranty** - From the date of purchase, InFocus warrants that the customer replaceable and accessory products will conform to the manufacturers' specifications and be free from defects in material or workmanship for a period of one (1) year.
- **90 Day/500 Hour Replacement Lamp Warranty** - Lamp Products purchased in projectors or separately as replacements after the original projector purchases is Ninety (90) days or 500 hours, whichever comes first. During the Warranty period for the Product, InFocus warrants that Replacement lamps, which are purchased at the time of projector purchase, will have a 90-day or 500 hour warranty, whichever comes first, from the date the spare lamp is put into use.

WARRANTY LIMITATION AND EXCLUSION

THIS WARRANTY SETS FORTH INFOCUS' MAXIMUM LIABILITY FOR ITS PRODUCT. THIS WARRANTY EXTENDS ONLY TO PRODUCTS PURCHASED FROM INFOCUS OR AN INFOCUS AUTHORIZED RESELLER. InFocus shall have no further obligation under foregoing Limited Warranty if the Product has been damaged due to abuse, misuse, neglect, smoke exposure (cigarette or otherwise), accident, unusual physical or electrical stress, unauthorized modifications (including use of an unauthorized mount), tampering, alterations, or service other than by InFocus or its authorized agents, causes other than from ordinary use or failure to properly use the Product in the application for which said Product was intended.

This Warranty excludes Product or accessory cleaning, repair, or replacement of plastics due to cosmetic damage and damage as a result of normal wear. Product repair outside of the terms of the Limited Warranty will be on a time and material basis. Prolonged Product "demonstration" causes manual Product wear and is not considered normal use under the terms of this Limited Warranty.

The Accessory Warranty covers the accessory items only and excludes normal wear. The Lamp product Warranty excludes expected lamp degradation.

Remanufactured products and Software Products are exempt from the foregoing Limited Warranty. Please refer to the appropriate Remanufactured Product Limited Warranty or Software Product Limited Warranty for applicable Warranty information.

DISCLAIMER OF UNSTATED WARRANTIES

THE WARRANTY PRINTED ABOVE IS THE ONLY WARRANTY APPLICABLE TO THIS PRODUCT. ALL OTHER WARRANTIES, EXPRESS OR IMPLIED, INCLUDING, BUT NOT LIMITED TO, THE IMPLIED WARRANTIES OF MERCHANTABILITY AND FITNESS FOR PARTICULAR PURPOSE ARE DISCLAIMED. THERE ARE NO WARRANTIES THAT EXTEND BEYOND THE DESCRIPTION ON THE FACE HEREOF AND THE FOREGOING WARRANTY SHALL NOT BE EXTENDED, ALTERED OR VARIED EXCEPT BY WRITTEN INSTRUMENT SIGNED BY INFOCUS. SOME JURISDICTION DO NOT ALLOW LIMITATIONS ON HOW LONG AN IMPLIED WARRANTY MAY LAST, SO SUCH LIMITATIONS MAY NOT APPLY TO YOU.

Limited Warranty Period

The Limited Warranty period commences on the date of purchase by the end-user customer for both the 2 year Product Warranty and the 1 year Accessory Warranty. These Limited Warranty provisions shall apply only to the end-user purchaser (first person or entity that purchased a new Product for personal or business use and not for the purpose of distribution or resale).

To Be Eligible For Limited Warranty Coverage

Any person exercising a claim under Limited Warranty must establish to the satisfaction of InFocus both the date of purchase and that the Product was purchased new. The sales receipt or invoice, showing the date of purchase of the Product or Accessory is the proof of the date of purchase.

To Obtain Warranty Service

During the Limited Warranty period, to exercise this Limited Warranty, the purchaser must first contact 1) InFocus, 2) a service facility authorized by InFocus or 3) the place of original purchase.

InFocus Customer Service – 1-800-799-9911 or techsupport@infocus.com

For Warranty service, the purchaser will be advised to return or deliver the defective Product freight and all fees prepaid, to an InFocus Service Center or to a service facility authorized by InFocus. When returning Product to InFocus, a Return Material Authorization Number (RMA #) is required and must be clearly displayed on the outside of the shipping carton or similar package affording an equal degree of protection. InFocus or the service facility authorized by InFocus will return the repaired/replaced Product freight prepaid to the purchaser.

Products returned for Warranty service must be accompanied by a written letter that: (i) explains the problem; (ii) provides proof of date of purchase; (iii) provides the dealer's name; and (iv) provides the model and serial number of the Product. Upon request of InFocus Corporation or an authorized repair center for InFocus, proof of legal importation must accompany the warranty repair Product, otherwise the Product must be returned to the place of original purchase, to the manufacturer (Purchaser must bear all tax, duty and freight), or the Purchaser must bear charges for the warranty repair.

No repair or replacement of Product or part thereof shall extend the Limited Warranty period as to the entire Product. Warranty on the repair part and workmanship shall only be effective for a period of ninety (90) days following the repair or replacement of that part or the remaining period of the Product Limited Warranty whichever is greater.

LIMITATION OF LIABILITY

IT IS UNDERSTOOD AND AGREED THAT INFOCUS' LIABILITY WHETHER IN CONTRACT, IN TORT, UNDER ANY WARRANTY, IN NEGLIGENCE OR OTHERWISE SHALL NOT EXCEED THE RETURN OF THE AMOUNT OF THE PURCHASE PRICE PAID BY PURCHASER AND UNDER NO CIRCUMSTANCES SHALL INFOCUS BE LIABLE FOR SPECIAL, INDIRECT, INCIDENTAL OR CONSEQUENTIAL DAMAGES OR LOST PROFITS, LOST REVENUES OR LOST SAVINGS. THE PRICE STATED FOR THE PRODUCTS IS A CONSIDERATION IN LIMITING INFOCUS' LIABILITY.

Limitation on Bringing Action – No action, regardless of form, arising out of the agreement to purchase the product may be brought by purchaser more than one year after the cause of action has accrued.

Governing Law – Any action, regardless of form, arising out of the agreement to purchase the product is governed by Oregon law.

Mandatory Arbitration – Any action, regardless of form, arising out of the agreement to purchase the product is subject to mandatory arbitration.

SOME JURISDICTIONS DO NOT ALLOW THE EXCLUSION OR LIMITATION OF INCIDENTAL OR CONSEQUENTIAL DAMAGES SO THE ABOVE LIMITATION OR EXCLUSION MAY NOT APPLY TO YOU. THIS LIMITED WARRANTY GIVES YOU SPECIFIC LEGAL RIGHTS, AND YOU MAY ALSO HAVE OTHER RIGHTS, DEPENDING ON JURISDICTION.

Eingeschränkte Garantie

InFocus Corporation („InFocus“) garantiert, dass der von InFocus, einem InFocus-Distributor oder einem InFocus-Wiederverkäufer erworbene Projektor („Produkt“) den technischen Angaben des Herstellers entspricht und für die unten angegebene Garantiedauer frei von Material- und Herstellungsfehlern ist. InFocus garantiert nicht, dass das Produkt den spezifischen Anforderungen des Endbenutzerkunden entspricht.

Falls das Produkt, das Gegenstand dieser eingeschränkten Garantie ist, während der Garantiezeit Material- oder Herstellungsfehler aufweist, wird das Produkt nach Ermessen von InFocus REPARIERT oder ERSETZT.

Alle im Rahmen dieser Garantie ausgetauschten Teile und ersetzten Produkte gehen in das Eigentum von InFocus über. Die ausschließliche Verpflichtung von InFocus besteht in der Bereitstellung (bzw. Bezahlung) der gesamten Arbeitsleistung, die zum Reparieren des Produkts erforderlich ist, das während der Garantiezeit als mangelhaft festgestellt wurde, und im Reparieren oder Ersetzen mangelhafter Teile durch neue Teile oder im Ermessen von InFocus durch verwendbare gebrauchte Teile, die der Leistung neuer Teile gleichwertig oder besser sind.

Umfang der eingeschränkten Garantie: Vorbehaltlich der Einschränkungen und Ausschlüsse garantiert InFocus Folgendes:

- **2-Jahre-Produktgarantie auf Teile und Arbeitsleistung** - InFocus garantiert für die Dauer von zwei (2) Jahren ab dem Kaufdatum, dass das Produkt den technischen Angaben des Herstellers entspricht und frei von Material- und Herstellungsfehlern ist.
- **1-Jahr-Zubehörgarantie nur auf Teile** - InFocus garantiert für die Dauer von einem (1) Jahr ab dem Kaufdatum, dass kundenseitig auswechselbare Produkte und Zubehörprodukte den technischen Angaben des Herstellers entsprechen und frei von Material- und Herstellungsfehlern sind.
- **90-Tage/500-Stunden-Ersatzlampengarantie** - Auf Lampenprodukte, die in Projektoren oder gesondert als Ersatzteile nach dem Originalkauf des projectors erworben wurden, wird eine Garantie von neunzig (90) Tagen oder 500 Stunden gewährt, je nachdem, was zuerst eintritt. Während der Garantiezeit für das Produkt gewährt InFocus auf die Ersatzlampen, die zusammen mit dem Projektor gekauft wurden, eine Garantiedauer von 90 Tagen oder 500 Stunden, je nachdem, was zuerst eintritt, ab dem Datum, an dem die Ersatzlampe eingesetzt wurde.

GARANTIEEINSCHRÄNKUNG UND -AUSSCHLUSS

DIESE GARANTIE LEGT DIE MAXIMALE HAFTUNG SEITENS INFOCUS FÜR INFOCUS-PRODUKTE FEST. DIESE GARANTIE GILT NUR FÜR PRODUKTE, DIE VON INFOCUS ODER EINEM AUTORISIERTEN INFOCUS-WIEDERVERKÄUFER ERWORBEN WURDEN. InFocus übernimmt hiermit keine Haftung, wenn das Produkt aufgrund von Misshandlung, Missbrauch, Fahrlässigkeit, Rauch (Zigarettenrauch oder anderer Rauch), Unfall, ungewöhnlicher physikalischer oder elektrischer Belastung, nicht genehmigten Modifikationen (einschließlich nicht genehmigter Befestigung), unsachgemäßen Eingriffen, Änderungen, Wartung durch nicht von InFocus autorisierte Stellen, Ursachen, die nicht auf normalen Einsatz zurückzuführen sind, oder Verwendung des Produkts in einer nicht für das Produkt bestimmten Anwendung beschädigt wird.

Diese Garantie gilt nicht für die Produkt- bzw. Zuberreinigung, Reparatur oder den Austausch von Kunststoffteilen aufgrund eines kosmetischen Schadens oder Achäden infolge normaler Abnutzung. Für Produktreparaturen, die nicht im Rahmen der eingeschränkten Garantie durchgeführt werden, werden Zeit- und Materialkosten berechnet. Eine „Produktdemonstration“ über einen längeren Zeitraum verursacht eine ungewöhnlich hohe Produktabnutzung, die unter den Bedingungen dieser eingeschränkten Garantie nicht als normaler Gebrauch betrachtet wird.

Die Zibehörgarantie gilt nur für das Zubehör und schließt normale Abnutzung aus. Die Lampenproduktgarantie schließt einen erwarteten Qualitätsverlust der Lampe durch Alterung aus..

Wiederaufbereitete Produkte und Softwareprodukte sind von der vorangegangenen eingeschränkten Garantie ausgeschlossen. Die hierfür zutreffenden Garantieinformationen sind in der eingeschränkten Garantie für das wiederaufbereitete Produkt bzw. Das betreffende Softwareprodukt zu finden.

AUSSCHLUSS ODER STILLSCHWEIGENDE GARANTIE

DIE OBEN AUFGEFÜHRTE GARANTIE IST DIE EINZIG GÜLTIGE GARANTIE FÜR DIESES PRODUKT. ALLE ANDEREN, GLEICH OB AUSDRÜCKLICH ODER IMPLIZIT GEWÄHRTEN GARANTIEN, EINSCHLIESSLICH, JEDOCH NICHT BESCHRÄNKT AUF DIE IMPLIZITEN GARANTIEN DER MARKTFÄHIGKEIT UND EIGNUNG FÜR EINEN BESTIMMTEN ZWECK, SIND NICHT GÜLTIG. DIE OBIGE GARANTIE KANN NICHT DURCH ANDERE GARANTIEN ERWEITERT UND NUR DURCH EINE SCHRIFTLICHE UNTERLAGE, DIE VON INFOCUS UNTERSCHRIEBEN WURDE, ERWEITERT ODER GEÄNDERT WERDEN. EINIGE GERICHTSBARKEITEN ERLAUBEN KEINE FRISTEN FÜR GESETZLICHE GEWÄHRLEISTUNGEN. IN DIESEM FALL TRIFFT DIE OBEN AUFGEFÜHRTE EINSCHRÄNKUNG U.U.NICHT AUF SIE ZU.

Dauer der eingeschränkten Garantie

Die Garantiezeit sowohl für die 2-Jahre-Produktgarantie als auch für die 1-Jahr-Zubehörgarantie beginnt am Tag des Kaufs durch den Endbenutzerkunden. Die eingeschränkte Garantie gilt nur für Endbenutzerkäufer (erste Person bzw. Organisation, die ein neues Produkt zur persönlichen oder geschäftlichen Verwendung und nicht zur Verteilung oder zum Wiederverkauf erwirbt).

Ansprüche im Rahmen dieser eingeschränkten Garantie

Jede Person, die einen Anspruch im Rahmen dieser eingeschränkten Garantie geltend macht, muss zur Befriedigung von InFocus das Kaufdatum nachweisen und beweisen, dass das Produkt neu gekauft wurde. Die Verkaufsquittung oder Verkaufsrechnung mit dem Kaufdatum des Produkts oder Zubehörs ist der Nachweis für das Kaufdatum.

Inanspruchnahme von Garantieleistungen

Zur Inanspruchnahme von Leistungen während der Garantiezeit muss sich der Käufer zuerst mit 1) InFocus, 2) einer von InFocus autorisierten Wartungsstätte oder 3) dem Händler, bei dem er das Produkt erworben hat, in Verbindung setzen.

InFocus-Kundendienst – 1-800-799-9911 oder techsupport@infocus.com

Für den Erhalt von Dienstleistungen im Rahmen der Garantie muss der Käufer das fehlerhafte Produkt mit vorausbezahlter Fracht und vorausbezahlten Gebühren an ein InFocus-Servicecenter oder eine von InFocus autorisierte Wartungsstätte einsenden. Bei der Rücksendung des Produkts an InFocus ist eine sogenannte „Return-Material-Authorization“- (RMA-) Nummer erforderlich, die gut lesbar auf der Außenseite des Originalkartons oder eines ähnlichen Kartons, der einen gleichwertigen Schutz bietet, angebracht werden muss. InFocus oder die von InFocus autorisierte Wartungsstätte wird das reparierte bzw. Ersetzte Produkt mit vorausbezahlter Fracht an den Käufer zurücksenden.

Produkten, die für Garantieleistungen eingesendet werden, muss ein Schreiben beigefügt werden, das (i) das Problem beschreibt, (ii) den Nachweis für das Kaufdatum enthält, (iii) den Namen des Händlers enthält und (iv) das Modell und die Seriennummer des Produkts angibt. Auf Anfrage von InFocus Corporation oder einem von InFocus autorisierten Reparaturzentrum muss dem zu Garantiezwecken eingesandten Produkt ein Nachweis zur legalen Einfuhr beigelegt werden; andernfalls muss das Produkt zu dem Händler, bei dem das Produkt gekauft wurde, oder zum Hersteller (Käufer übernimmt sämtliche Steuern, Zölle und Frachtkosten) zurückgesandt werden, oder der Käufer muss die Kosten für die Garantiereparatur übernehmen.

Durch eine Reparatur oder einen Austausch des Produkts oder Teilen davon wird die Garantiezeit des gesamten Produkts nicht verlängert. Die Garantie für das reparierte Teil und die Herstellung gilt nur für eine Zeitdauer von neunzig (90) Tagen nach der Reparatur bzw. Dem Austausch dieses Teils oder die restliche Zeitdauer der Produktgarantie, je nachdem, welcher Zeitraum länger ist.

HAFTUNGSEINSCHRÄNKUNG

DIE HAFTUNG SEITENS INFOCUS, GLEICH OB VERTRAGSMÄSSIG, WEGEN UNERLAUBTER HANDLUNG, UNTER EINER GARANTIE, AUS FAHRLÄSSIGKEIT ODER AUS ANDEREN GRÜNDEN, ÜBERSCHREITET NICHT DIE RÜCKERSTATTUNG DES KAUFPREISES AN DEN KÄUFER. INFOCUS ÜBERNIMMT AUF KEINEN FALL DIE HAFTUNG FÜR SPEZIELLE, MITTELBARE, NEBEN- ODER FOLGESCHÄDEN ODER ENTGANGENEN GEWINN, UMSATZVERLUST ODER VERLUST VON ERSPARNISSEN. DER AUFGEFÜHRTE PREIS FÜR DAS PRODUKT IST EIN FAKTOR BEI DER HAFTUNGSEINSCHRÄNKUNG SEITENS INFOCUS.

Rechtsbehelfsfrist – Keine Rechtshandlung, gleich welcher Art, die sich aus Einkaufsvereinbarung für das Produkt ergibt, kann vom Käufer nach mehr als einem Jahr nach Entstehendes Klageanspruchs eingebracht werden.

Anwendbares Recht – Alle Rechtshandlungen, gleich welcher Art, die sich aus Einkaufsvereinbarung für das Produkt ergeben, unterliegen dem Gesetzen des US-Bundesstaates Oregon.

Zwangsschlichtung – Alle Rechtshandlungen, gleich welcher Art, die sich aus Einkaufsvereinbarung für das Produkt ergeben, sind vorbehaltlich einer Zwangsschlichtung.

EINIGE GERICHTSBARKEITEN ERLAUBEN KEINEN HAFTUNGS AUSSCHLUSS BZW. KEINE HAFTUNGSEINSCHRÄNKUNG FÜR NEBEN- ODER FOLGESCHÄDEN. IN DIESEM FALL TRIFFT DIE OBEN AUFGEFÜHRTE EINSCHRÄNKUNG BZW. DER AUSSCHLUSS U.U. NICHT AUF SIE ZU. DIESE GARANTIE GIBT IHNEN BESTIMMTE RECHTE. SIE KÖNNEN WEITERE RECHTE HABEN, DIE VON DER GERICHTSBARKEIT ABHÄNGIG SIND.

Garantía limitada

InFocus Corporation ("InFocus") garantiza que el Proyector ("Producto") adquirido de InFocus, o de uno de los distribuidores o revendedores de InFocus, cumplirá con las especificaciones del fabricante y estará libre de defectos de material o mano de obra durante el período de garantía detallado a continuación. InFocus no garantiza que el Producto cumplirá con los requisitos específicos del usuario.

Si el Producto sujeto a esta Garantía limitada es defectuoso en material o mano de obra durante el período de garantía, InFocus REPARARÁ o REEMPLAZARÁ el Producto como opción exclusiva de InFocus.

Todas las piezas intercambiadas y los productos repuestos bajo esta Garantía pasarán a ser propiedad de InFocus. La única obligación de InFocus es proveer (o pagar) la mano de obra necesaria para reparar el Producto defectuoso durante el período de Garantía y separar o reemplazar cualquier pieza defectuosa con una pieza nueva o, como opción exclusiva de InFocus, con una pieza servible usada que sea equivalente o superior en rendimiento a una nueva.

Alternativas de la Garantía limitada: Sujeto a las Limitaciones, Exclusiones y Declinaciones de responsabilidad, InFocus garantiza lo siguiente:

- **Garantía de productos de 2 años para partes y mano de obra** - A partir de la fecha de la compra, InFocus garantiza que el producto cumplirá con las especificaciones de los fabricantes y estará libre de defectos de material o mano de obra durante un período de dos (2) años.
- **Garantía de accesorios de 1 año para partes únicamente** - A partir de la fecha de la compra, InFocus garantiza que las partes reemplazables por el usuario y los Productos accesorios cumplirán con las especificaciones de los fabricantes y estarán libres de defectos de material o mano de obra durante un período de un (1) año.
- **Garantía de lámpara de repuesto de 90 días/500 horas** - La garantía de los productos de lámpara adquiridos como parte de los proyectores o como piezas de repuesto luego de la adquisición del proyector original es de noventa (90) días o 500 horas, lo que anteceda. Durante el período de Garantía del Producto, InFocus garantiza que las Lámparas de repuesto adquiridas al momento de la compra del proyector tendrán una garantía de 90 días o 500 horas, lo que anteceda, a partir de la fecha en la que la lámpara de repuesto es utilizada por primera vez.

LIMITACIÓN Y EXCLUSIÓN DE LA GARANTÍA

ESTA GARANTÍA ESTIPULA LA RESPONSABILIDAD MÁXIMA DE INFOCUS POR SU PRODUCTO. LA MISMA CUBRE ÚNICAMENTE PRODUCTOS ADQUIRIDOS DE INFOCUS O DE UN DISTRIBUIDOR AUTORIZADO DE INFOCUS. InFocus no tendrá ninguna otra responsabilidad bajo la Garantía limitada previa si el Producto ha sufrido daños—debido a uso indebido, negligencia, exposición al humo (de cigarrillo u otro), accidente, fuerza física o eléctrica intensa, modificación no autorizada (incluyendo el uso de una instalación de techo no autorizada), manipulación inexperta, alteraciones o cualquier otro servicio no realizado por InFocus o por sus agentes autorizados—causados por el uso fuera de lo común o por uso indebido del Producto o por sometimiento a un uso para el cual el Producto no ha sido diseñado.

Esta Garantía limitada excluye la limpieza, la reparación o el reemplazo de las piezas de plástico, ya que estas últimas están sujetas a sufrir daños cosméticos y otros daños causados por el uso normal. Toda reparación de Productos que se encuentre fuera de los términos de la Garantía limitada deberá considerarse en base al tiempo y los materiales utilizados. La "demostración" prolongada de un Producto provoca un desgaste inusual del mismo, por lo que no se considera como uso normal bajo los términos de esta Garantía limitada.

La Garantía de accesorios cubre artículos accesorios únicamente y excluye el uso normal. La Garantía de productos de lámpara excluye la degeneración esperada de la vida útil de la lámpara.

Los Productos industrialmente reciclados y los Productos de software están exentos de la Garantía limitada precedente. Consulte la Garantía limitada de productos industrialmente reciclados o la Garantía limitada de productos de software para obtener información adicional.

EXCLUSIÓN DE GARANTÍAS IMPLÍCITAS

LA GARANTÍA EMPRESA ARRIBA ES LA ÚNICA GARANTÍA APLICABLE A ESTE PRODUCTO. CUALQUIER OTRA GARANTÍA, EXPRESA O IMPLÍCITA, INCLUYENDO PERO SIN LIMITARSE A LAS GARANTÍAS IMPLÍCITAS DE COMERCIABILIDAD O ADECUACIÓN PARA UN USO DETERMINADO, ES RECHAZADA. NO EXISTE NINGUNA GARANTÍA SALVO LA GARANTÍA AQUÍ EXPUESTA Y ÉSTA NO SERÁ PROLONGADA, MODIFICADA O ALTERADA SALVO POR ESCRITO FIRMADO POR INFOCUS. ALGUNAS JURISDICCIONES NO PERMITEN LA LIMITACIÓN DE GARANTÍAS IMPLÍCITAS, POR LO QUE ES POSIBLE QUE DICHAS LIMITACIONES NO APLIQUEN A SU CASO PARTICULAR.

Periodo de la Garantía limitada

El periodo de la Garantía limitada comienza a partir de la fecha en la que el usuario adquiere el producto, tanto para la Garantía de productos de 2 años como para la Garantía de accesorios de 1 año. Estas disposiciones de la Garantía limitada serán aplicables únicamente al usuario comprador (la primera persona o entidad que adquirió un nuevo Producto de uso personal o empresarial y no para su distribución o reventa).

Para ser elegible para obtener cobertura de la Garantía limitada

Cualquier persona que realice un reclamo bajo esta Garantía limitada debe, a la satisfacción de InFocus, validar la fecha de compra y probar que el Producto fue adquirido nuevo. El recibo de compra o factura con la fecha de adquisición del Producto o Accesorio constituye la prueba de la fecha de compra.

Para obtener el servicio de Garantía

Durante el periodo de la Garantía limitada, para hacer uso de la misma, el comprador deberá primero comunicarse con 1) InFocus, 2) un proveedor de servicio autorizado por InFocus o 3) el establecimiento en el que se realizó la compra original.

Servicio al cliente de InFocus - 1-800-799-9911 o techsupport@infocus.com

Para obtener el servicio de Garantía, se le solicitará al comprador devolver o entregar el Producto defectuoso, pagados de antemano el embalaje y todas las tarifas asociadas, a un Centro de servicio InFocus o a un proveedor de servicio autorizado por InFocus. Al devolver un Producto a InFocus, se requiere un Número de Autorización para la Devolución de Mercancías (RMA #), que debe mostrarse claramente en el exterior de la caja de envío o en otra similar que ofrezca el mismo grado de protección. InFocus, o el proveedor de servicio autorizado por InFocus, devolverá al comprador el Producto reparado o reemplazado cubriendo de antemano los costos de embalaje.

Los Productos devueltos para el Servicio de garantía deberán acompañarse de una carta escrita que: (i) explique el problema; (ii) proporcione un comprobante de la fecha de compra; (iii) proporcione el nombre del distribuidor; y (iv) proporcione el modelo y el número de serie del Producto. Bajo previa solicitud de InFocus Corporation o de un centro de reparación autorizado por InFocus, deberá presentarse una prueba de importación legal junto con el Producto a ser reparado. De lo contrario, el Producto deberá ser devuelto al lugar de la compra original o al fabricante (el Comprador deberá pagar todos los impuestos, los aranceles de aduana y el embalaje).

Ni la reparación ni el reemplazo de un Producto o de alguna de sus piezas podrán ampliar el periodo de Garantía limitada del Producto entero. La Garantía de la pieza reparada y la mano de obra será efectiva únicamente durante un periodo de noventa (90) días a partir de la reparación o el reemplazo de dicha pieza o durante el resto del periodo de Garantía del Producto, el que sea mayor de los dos plazos.

EXCLUSIÓN DE LIMITACIÓN DE RESPONSABILIDAD

USTED INTIENDE Y ESTÁ DE ACUERDO EN QUE LA RESPONSABILIDAD DE INFOCUS, BAJO CONTRATO, BAJO AGRAVIO, BAJO CUALQUIER GARANTÍA, BAJO NEGLIGENCIA O POR CUALQUIER OTRA CAUSA, NO SOBREPASARÁ LA CANTIDAD DEL PRECIO DE COMPRA ABONADO POR EL COMPRADOR Y QUE EN NINGÚN CASO INFOCUS SE RESPONSABILIZARÁ POR DAÑOS ESPECIALES, DIRECTOS O INDIRECTOS O PÉRDIDA DE BENEFICIOS, INGRESOS O AHORROS. EL PRECIO ESTABLECIDO PARA LOS PRODUCTOS ES UNA CONSIDERACIÓN DE LIMITACIÓN DE LA RESPONSABILIDAD DE INFOCUS.

Limitación de interposición de acciones - Ninguna forma de acción surgida por el acuerdo de adquisición del producto será realizada por el comprador transcurrido un año desde la fecha de la causa de la acción.

Leyes aplicables - Cualquier forma de acción surgida de adquisición del producto será regida por las leyes de Oregon.

Arbitraje obligatorio - Cualquier forma de acción surgida por el acuerdo de adquisición del producto está sujeta a arbitraje obligatorio.

ALGUNAS JURISDICCIONES NO PERMITEN LA EXCLUSIÓN O LA LIMITACIÓN DE DAÑOS CONSECUENTES O INCIDENTALES, POR LO QUE ES POSIBLE QUE LA LIMITACIÓN O LA EXCLUSIÓN CITADA ANTERIORMENTE NO SE APLIQUE A SU CASO PARTICULAR. ESTA GARANTÍA LIMITADA LE PROPORCIONA DERECHOS LEGALES ESPECÍFICOS. ASIMISMO, ES POSIBLE QUE USTED TENGA OTROS DERECHOS, DEPENDIENDO DE LA JURISDICCIÓN.

Fingeschränkte Garantie

Infocus Corporation („Infocus“) garantiert, dass der von Infocus, einem Infocus-Distributor oder einem Infocus-Wiederverkäufer erworbene Projektor („Produkt“) den technischen Angaben des Herstellers entspricht und für die unten angegebene Garantiedauer frei von Material- und Herstellungsfehlern ist. Infocus garantiert nicht, dass das Produkt den spezifischen Anforderungen des Endbenutzerkunden entspricht.

Falls das Produkt, das Gegenstand dieser eingeschränkten Garantie ist, während der Garantiezeit Material- oder Herstellungsfehler aufweist, wird das Produkt nach Ermessen von Infocus REPARIERT oder ERSETZT.

Alle im Rahmen dieser Garantie ausgetauschten Teile und ersetzten Produkte gehen in das Eigentum von Infocus über. Die ausschließliche Verpflichtung von Infocus besteht in der Bereitstellung (bzw. Bezahlung) der gesamten Arbeitsleistung, die zum Reparieren des Produkts erforderlich ist, das während der Garantiezeit als mangelhaft festgestellt wurde, und im Reparieren oder Ersetzen mangelhafter Teile durch neue Teile oder im Ermessen von Infocus durch verwendbare gebrauchte Teile, die der Leistung neuer Teile gleichwertig oder besser sind.

Umfang der eingeschränkten Garantie: Vorbehaltlich der Einschränkungen und Ausschlüsse garantiert Infocus Folgendes:

- **2-Jahre-Produktgarantie auf Teile und Arbeitsleistung** - Infocus garantiert für die Dauer von zwei (2) Jahren ab dem Kaufdatum, dass das Produkt den technischen Angaben des Herstellers entspricht und frei von Material- und Herstellungsfehlern ist.
- **1-Jahre-Zubehörgarantie nur auf Teile** - Infocus garantiert für die Dauer von einem (1) Jahr ab dem Kaufdatum, dass kundenseitig austauschbare Produkte und Zubehörprodukte den technischen Angaben des Herstellers entsprechen und frei von Material- und Herstellungsfehlern sind.
- **90-Tage/500-Stunden-Ersatzlampengarantie** - Auf Lampenprodukte, die in Projektoren oder gesondert als Ersatzteile nach dem Originalkauf des Projektors erworben wurden, wird eine Garantie von neunzig (90) Tagen oder 500 Stunden gewährt, je nachdem, was zuerst eintritt. Während der Garantiezeit für das Produkt gewährt Infocus auf die Ersatzlampen, die zusammen mit dem Projektor gekauft wurden, eine Garantiedauer von 90 Tagen oder 500 Stunden, je nachdem, was zuerst eintritt, ab dem Datum, an dem die Ersatzlampe eingesetzt wurde.

GARANTIEEINSCHRÄNKUNG UND -AUSSCHLUSS

DIESE GARANTIE LEGT DIE MAXIMALE HAFTUNG SEITENS INFOCUS FÜR INFOCUS-PRODUKTE FEST. DIESE GARANTIE GILT NUR FÜR PRODUKTE, DIE VON INFOCUS ODER EINEM AUTORISIERTEN INFOCUS-WIEDERVERKÄUFER ERWORBEN WURDEN. Infocus übernimmt hiermit keine Haftung, wenn das Produkt aufgrund von Misshandlung, Missbrauch, Fahrlässigkeit, Rauch (Zigarettenrauch oder anderer Rauch), Unfall, ungewöhnlicher physikalischer oder elektrischer Belastung, nicht genehmigten Modifikationen (einschließlich nicht genehmigter Befestigung), unsachgemäßen Eingriffen, Änderungen, Wartung durch nicht von Infocus autorisierte Stellen, Ursachen, die nicht auf normalen Einsatz zurückzuführen sind, oder Verwendung des Produkts in einer nicht für das Produkt bestimmten Anwendung beschädigt wird.

Diese Garantie gilt nicht für die Produkt- bzw. Zubehörrückführung, Reparatur oder den Austausch von Kunststoffteilen aufgrund eines kosmetischen Schadens oder Schäden infolge normaler Abnutzung. Für Produktreparaturen, die nicht im Rahmen der eingeschränkten Garantie durchgeführt werden, werden Zeit- und Materialkosten berechnet. Eine „Produktdemonstration“ über einen längeren Zeitraum verursacht eine ungewöhnlich hohe Produktabnutzung, die unter den Bedingungen dieser eingeschränkten Garantie nicht als normaler Gebrauch betrachtet wird.

Die Zubehörgarantie gilt nur für das Zubehör und schließt normale Abnutzung aus. Die Lampenproduktgarantie schließt einen erwarteten Qualitätsverlust der Lampe durch Alterung aus.

Wiederaufbereitete Produkte und Softwareprodukte sind von der vorangegangenen eingeschränkten Garantie ausgeschlossen. Die hierfür zutreffenden Garantiekennzeichnungen sind in der eingeschränkten Garantie für das wiederaufbereitete Produkt bzw. das betreffende Softwareprodukt zu finden.

AUSSCHLUSS ODER STILLSCHWEIGENDE GARANTIE

DIE OBEN AUFGEFÜHRTE GARANTIE IST DIE EINZIG GÜLTIGE GARANTIE FÜR DIESES PRODUKT. ALLE ANDEREN, GLEICH OB AUSDRÜCKLICH ODER IMPLIZIT GEWÄHRTEN GARANTIE, EINSCHLIESSLICH, JEDOCH NICHT BESCHRÄNKT AUF DIE IMPLIZITEN GARANTIE DER MARKTFÄHIGKEIT UND EIGNUNG FÜR EINEN BESTIMMTEN ZWECK, SIND NICHT GÜLTIG. DIE OBIGE GARANTIE KANN NICHT DURCH ANDERE GARANTIE ERWEITERT UND NUR DURCH EINE SCHRIFTLICHE UNTERLAGE, DIE VON INFOCUS UNTERSCHRIEBEN WURDE, ERWEITERT ODER GEÄNDERT WERDEN. EINIGE GERICHTSBARKEITEN ERLAUBEN KEINE FRISTEN FÜR GESETZLICHE GEWÄHRLEISTUNGEN. IN DIESEM FALL TRIFFT DIE OBEN AUFGEFÜHRTE EINSCHRÄNKUNG U.U. NICHT AUF SIE ZU.

Dauer der eingeschränkten Garantie

Die Garantiezeit sowohl für die 2-Jahre-Produktgarantie als auch für die 1-Jahre-Zubehörgarantie beginnt am Tag des Kaufs durch den Endnutzverkäufer. Die eingeschränkte Garantie gilt nur für Endbenutzerkäufer (erste Person bzw. Organisation, die ein neues Produkt zur persönlichen oder geschäftlichen Verwendung und nicht zur Verteilung oder zum Wiederverkauf erwirbt).

Ansprüche im Rahmen dieser eingeschränkten Garantie

Jede Person, die einen Anspruch im Rahmen dieser eingeschränkten Garantie geltend macht, muss zur Befriedigung von InFocus das Kaufdatum nachweisen und beweisen, dass das Produkt neu gekauft wurde. Die Verkaufsquittung oder Verkaufsrechnung mit dem Kaufdatum des Produkts oder Zubehörs ist der Nachweis für das Kaufdatum.

Inanspruchnahme von Garantieleistungen

Zur Inanspruchnahme von Leistungen während der Garantiezeit muss sich der Käufer zuerst mit 1) InFocus, 2) einer von InFocus autorisierten Wartungsstätte oder 3) dem Händler, bei dem er das Produkt erworben hat, in Verbindung setzen.

InFocus-Kundendienst - 1-800-799-9911 oder techsupport@infocus.com

Für den Erhalt von Dienstleistungen im Rahmen der Garantie muss der Käufer das fehlerhafte Produkt mit vorausbezahlter Fracht und vorausbezahlten Gebühren an ein InFocus-Servicecenter oder eine von InFocus autorisierte Wartungsstätte einsenden. Bei der Rücksendung des Produkts an InFocus ist eine sogenannte „Return-Material-Authorization“- (RMA-) Nummer erforderlich, die gut lesbar auf der Außenseite des Originalkartons oder eines ähnlichen Kartons, der einen gleichwertigen Schutz bietet, angebracht werden muss. InFocus oder die von InFocus autorisierte Wartungsstätte wird das reparierte bzw. ersetzte Produkt mit vorausbezahlter Fracht an den Käufer zurücksenden.

Produkten, die für Garantieleistungen eingesendet werden, muss ein Schreiben beigelegt werden, das (i) das Problem beschreibt, (ii) den Nachweis für das Kaufdatum enthält, (iii) den Namen des Händlers enthält und (iv) das Modell und die Seriennummer des Produkts angibt. Auf Anfrage von InFocus Corporation oder einem von InFocus autorisierten Reparaturzentrum muss dem zu Garantiezwecken eingesandten Produkt ein Nachweis zur legalen Einfuhr beigelegt werden; andernfalls muss das Produkt zu dem Händler, bei dem das Produkt gekauft wurde, oder zum Hersteller (Käufer übernimmt sämtliche Steuern, Zölle und Frachtkosten) zurückgesandt werden, oder der Käufer muss die Kosten für die Garantiereparatur übernehmen.

Durch eine Reparatur oder einen Austausch des Produkts oder Teilen davon wird die Garantiezeit des gesamten Produkts nicht verlängert. Die Garantie für das reparierte Teil und die Herstellung gilt nur für eine Zeitdauer von neunzig (90) Tagen nach der Reparatur bzw. dem Austausch dieses Teils oder die restliche Zeitdauer der Produktgarantie, je nachdem, welcher Zeitraum länger ist.

HAFTUNGSEINSCHRÄNKUNG

DIE HAFTUNG SEITENS INFOCUS, GLEICH OB VERTRAGSMÄSSIG, WEGEN UNERLAUBTER HANDLUNG, UNTER EINER GARANTIE, AUS FAHRLÄSSIGKEIT ODER AUS ANDEREN GRÜNDEN, ÜBERSCHREITET NICHT DIE RÜCKERSTATTUNG DES KAUFPREISES AN DEN KÄUFER. INFOCUS ÜBERNIMMT AUF KEINEN FALL DIE HAFTUNG FÜR SPEZIELLE MITTELBARE, NEBEN- ODER FOLGESCHÄDEN ODER ENTGANGENEN GEWINN, UMSATZVERLUST ODER VERLUST VON ERSPARNISSEN. DER AUFGEFÜHRTE PREIS FÜR DAS PRODUKT IST EIN FAKTOR BEI DER HAFTUNGSEINSCHRÄNKUNG SEITENS INFOCUS.

Rechtsbehelfsfrist - Keine Rechtsbehandlung, gleich welcher Art, die sich aus der Einkaufsvereinbarung für das Produkt ergibt, kann vom Käufer nach mehr als einem Jahr nach Entstehen des Klageanspruchs eingebracht werden.

Ausendliches Recht - Alle Rechtsbehandlungen, gleich welcher Art, die sich aus der Einkaufsvereinbarung für das Produkt ergeben, unterliegen den Gesetzen des US-Bundesstaates Oregon.

Zwangspflichtung - Alle Rechtsbehandlungen, gleich welcher Art, die sich aus der Einkaufsvereinbarung für das Produkt ergeben, sind vorbehaltlich einer Zwangspflichtung.

EINIGE GERICHTSBARKEITEN ERLAUBEN KEINEN HAFTUNGSAUSSCHLUSS BZW. KEINE HAFTUNGSEINSCHRÄNKUNG FÜR NEBEN- ODER FOLGESCHÄDEN. IN DIESEM FALL TRIFFT DIE OBEN AUFGEFÜHRTE EINSCHRÄNKUNG BZW. DER AUSSCHLUSS U.U. NICHT AUF SIE ZU. DIESE GARANTIE GIBT IHNIEN BESTIMMTE RECHTE. SIE KÖNNEN WEITERE RECHTE HABEN, DIE VON DER GERICHTSBARKEIT ABHÄNGIG SIND.

Free Manuals Download Website

<http://myh66.com>

<http://usermanuals.us>

<http://www.somanuals.com>

<http://www.4manuals.cc>

<http://www.manual-lib.com>

<http://www.404manual.com>

<http://www.luxmanual.com>

<http://aubethermostatmanual.com>

Golf course search by state

<http://golfingnear.com>

Email search by domain

<http://emailbydomain.com>

Auto manuals search

<http://auto.somanuals.com>

TV manuals search

<http://tv.somanuals.com>