

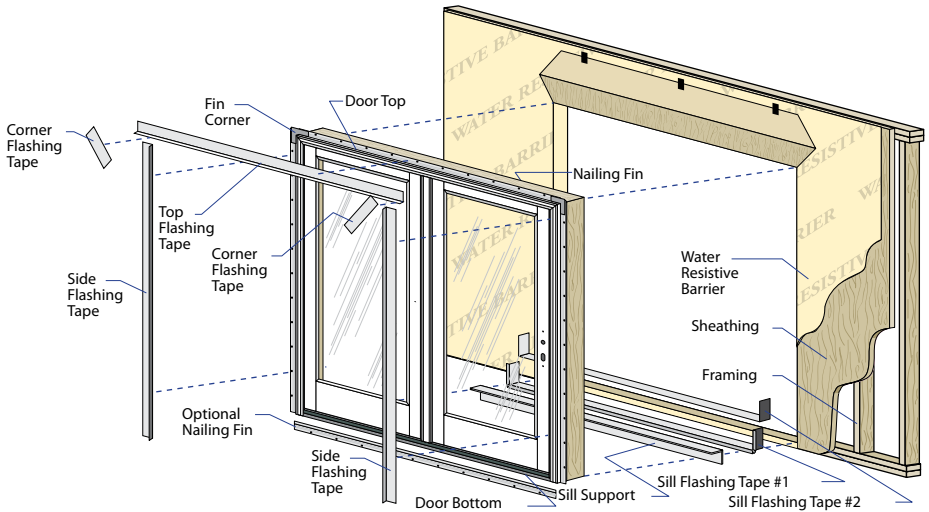

INSTALLATION INSTRUCTION – INSTRUCCIONES DE INSTALACIÓN FOR CLAD HINGED PATIO DOOR PUERTA DE BISAGRA PARA PATIO

REMEMBER TO USE APPROPRIATE PERSONAL PROTECTIVE EQUIPMENT.



Always read the Pella® Limited Warranty before purchasing or installing Pella products. By installing this product, you are acknowledging that this Limited Warranty is part of the terms of the sale. Failure to comply with all Pella installation and maintenance instructions may void your Pella product warranty. See Limited Warranty for complete details at <http://warranty.pella.com>.

Installation Instructions for Typical Wood Frame Construction.

These instructions were developed and tested for use with typical wood frame wall construction in a wall system designed to manage water. These instructions are not to be used with any other construction method. Installation instructions for use with other construction methods, multiple units or bow and bay windows, may be obtained from Pella Corporation or a local Pella retailer, or by visiting <http://www.pella.com>. Building designs, construction methods, building materials, and site conditions unique to your project may require an installation method different from these instructions and additional care. Determining the appropriate installation method is the responsibility of you, your architect, or construction professional.

YOU WILL NEED TO SUPPLY:

- Cedar or Impervious shims/spacers (12 to 20)
- 2" galvanized roofing nails (1/4 lb.)
- Closed cell foam backer rod/sealant backer (12 to 30 ft.)
- Pella® SmartFlash™ foil backed butyl window and door flashing tape or equivalent
- High quality exterior grade polyurethane or silicone sealant (1 tube per window)
- Great Stuff™ Window and Door Insulating Foam Sealant by the Dow Chemical Company or equivalent low pressure polyurethane window and door foam - DO NOT use high pressure or latex foams
- Pella aluminum sill support or 2 x 4 wood blocking
- Interior trim and/or jamb extensions (15 to 40 ft.)

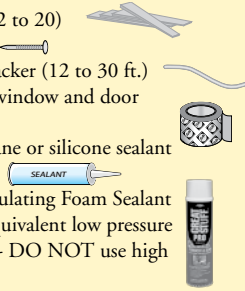

TOOLS REQUIRED:

- Tape measure
- Level
- Square
- Hammer
- Stapler
- Scissors or utility knife
- Sealant Gun
- Drill
- Screwdrivers (#2 Phillips & small flat blade)

1 ROUGH OPENING PREPARATION

A. Verify the opening is plumb and level.

Note: It is critical that the bottom is level.

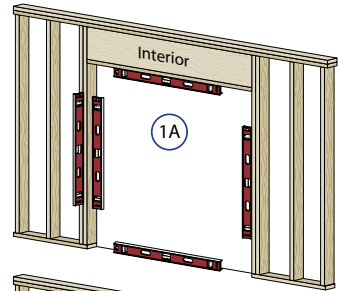

B. Verify the door will fit the opening. Measure all four sides of the opening to make sure it is 3/4" larger than the door in width and 1/2" larger in height. On larger openings measure the width and height in several places to ensure the header or studs are not bowed.

Note: 1-1/2" or more of solid wood blocking is required around the perimeter of the opening. Fix any problems with the rough opening before proceeding.

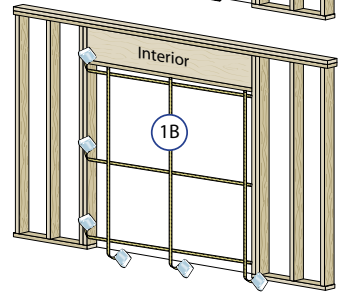

C. Cut the water resistive barrier (1C).

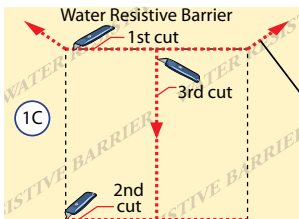

4th cut: Make a 6" cut up from each top corner at a 45° angle to allow the water resistive barrier to be lapped over the fin at the head of the door.

D. Fold the water resistive barrier (1D). Fold side flaps into the opening and staple to inside wall. Fold top flap up and temporarily fasten with flashing tape.

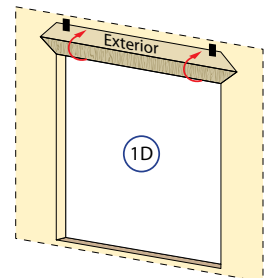

- E. **Apply sill flashing tape #1.** Cut a piece of flashing tape 12" longer than the opening width. Apply at the bottom of the opening as shown (1E) so it overhangs 1" to the exterior.

Note: The tape is cut 12" longer than the width so that it will extend 6" up each side of the opening.

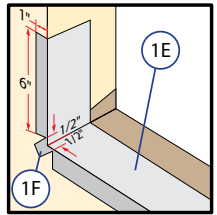

- F. **Tab the sill flashing tape and fold.** Cut 1" wide tabs at each corner (1/2" from each side of corner) (1F). Fold tape to the exterior and press firmly to adhere it to the water resistive barrier.

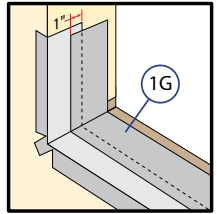

- G. **Apply sill flashing tape #2.** Cut a piece of flashing tape 12" longer than the opening width. Apply at the bottom, overlapping tape #1 by at least 1". Do not allow the tape to extend past the interior face of the framing (1G).

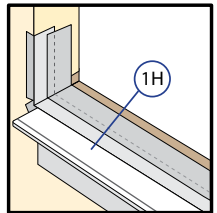

- H. **Attach the aluminum sill support or wood blocking** to the exterior of the box plate to support the edge of the door sill. Place the sill support flush with the subfloor.

2 SETTING AND FASTENING THE DOOR

- A. **Remove plastic wrap and cardboard packaging from door.** Do not remove plastic shipping spacers. The shipping spacers will help keep the door square during installation. DO NOT unlock or open the door until it is fully fastened.

Note: If screens, grilles or hardware are removed from the door at this time, label them and store them in a protected area.

- B. **Fold out installation fin to 90°.** Be careful not to remove or tear the fin corners.

Note: If the fin is not at 90°, the door will not line up correctly on the interior.

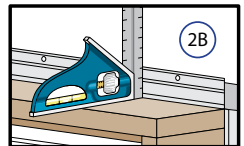

- C. **Place three 3/8" beads of sealant.** The first bead should be approximately 3/4" from the exterior of the rough opening, the second bead should be placed so it is under the wood interior threshold of the door. Placement will vary depending on wall thickness and door type. Place a third bead of sealant in the groove of the sill support or 1/4" from the exterior edge of the wood blocking.

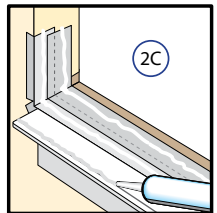

TWO OR MORE PEOPLE WILL BE REQUIRED FOR THE FOLLOWING STEPS.

- D. **Insert the door from the exterior of the building. DO NOT slide the bottom of the door into the opening. Sliding will damage the sealant lines.** Place the bottom of the door at the bottom of the opening, then tilt the top into position. Center the door between the sides of the opening to allow clearance for shimming, and insert one roofing nail in the first hole from the corner on each end of the top nailing fin. These are used to hold the door in place while shimming it plumb and square.

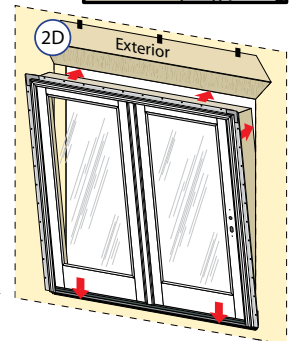

- E. **Plumb and square door.** Place shims at each hinge and lock strike location between the door and the sides of the opening. Insert shims in other locations as needed starting up 6" from the bottom of the door to square it in the opening. Make sure that the reveal around the door(s) is equal. On double doors, make sure that panels are even across the bottom.

Note: DO NOT over shim.

- F. **Check the interior reveal.** Make sure the measurement from the interior face of the door to the interior face of the wall is equal at several points around the door.

Note: If the dimensions are not equal, check to make sure the fins are folded out to 90° at all points.

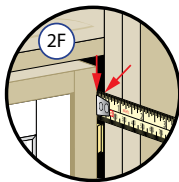

- G. **Fasten the door to opening** by driving 2" galvanized roofing nails into each pre-punched hole in the nailing fin.

Note: Make sure the fin corner is lying as flat as possible.

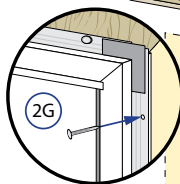

- H. **Carefully open the door(s)** and remove all shipping spacers.

Note: Be sure to remove the spacers from the bottom edge of the door panel.

- I. **Insert and attach shims directly above the astragal** in the center of the unit.

- J. **Center hinge double doors only: On each hinge, starting at the top, insert a 3" long screw** (provided) into the open screw hole. Make sure that the screw passes through the shims and into the structural framing.

- K. **Check door operation.** Open and close the door to check for proper operation. Make sure the door will latch correctly.

Note: If there are any problems with the operation, recheck and adjust the reveal. Plastic shims located behind the hinges may be removed to adjust the reveal between the door panel and door frame. Additional hinge shims may be added if required.

- L. **Drill a 1/8" diameter x 2" deep pilot hole** through the lock strike and into the rough opening. Insert a #8 x 3" screw (provided) into pilot hole making sure that it passes through the shim and into the stud.

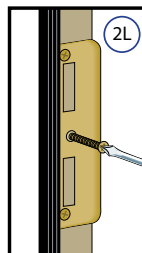
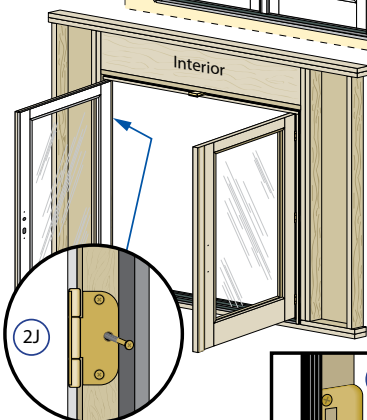
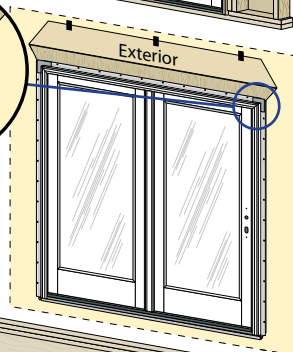
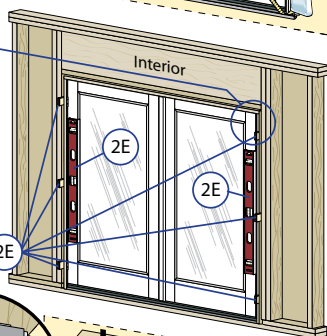
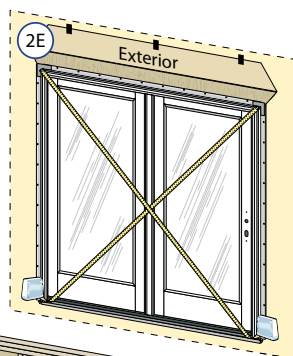

3 INTEGRATING THE DOOR TO THE WATER RESISTIVE BARRIER

Note: The flashing tape must be applied approximately 1/2" onto the frame cladding at the jambs and head. Pre-folding the tape at 1/2" before removing the paper backing will make it easier to apply the tape correctly. If the siding is less than 1/2" thick, adjust the dimension of the fold so the exterior sealant line will cover the exterior edge of the tape.

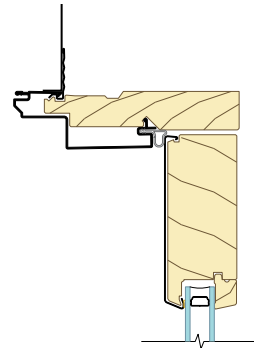

- A. **Apply side flashing tape.** Cut two pieces of flashing tape 4" longer than the frame height of the door. Apply one piece 1/2" onto the frame cladding, over the nailing fin and onto the water resistive barrier. The tape should extend 2" above the top of the door and 2" below the bottom of the door. Press the tape down firmly while folding down the excess tape at the top and bottom of the door.

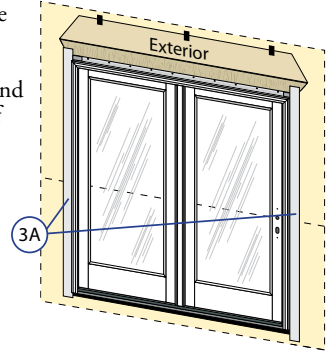

- B. **Apply top flashing tape.** Cut a piece of flashing tape long enough to go across the top of the door and extend at least 1" past the side flashing tape on both sides. Apply the tape 1/2" onto the frame cladding, over the top nailing fin as shown. Fold the overlapping tape down, and press all tape down firmly.

Note: The top flashing tape must overlap the side flashing tape to prevent water from getting behind it.

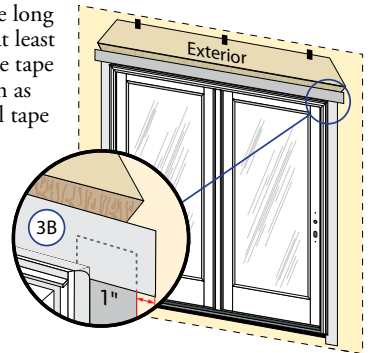

- C. **Fold down top flap** of water resistive barrier (3C).

- D. **Apply flashing tape to diagonal cuts.** Cut pieces of flashing tape at least 1" longer than the diagonal cuts in the water resistive barrier. Apply the tape covering the entire diagonal cut in the water resistive barrier at both upper corners of the door.

Note: Be sure to overlap the top corners (3D).

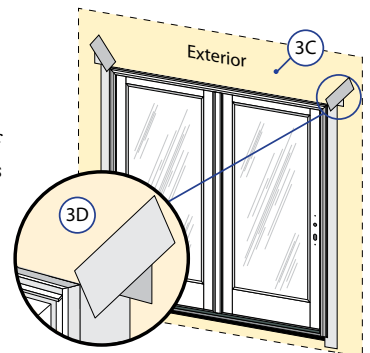

4 INTERIOR SEAL

Caution: Ensure use of low pressure polyurethane window and door insulating foams and strictly follow the foam manufacturer's recommendations for application. Use of high pressure foams or improper application of the foam may cause the door frame to bow and hinder operation.

- A. **Apply insulating foam sealant.** From the interior, insert the nozzle of the applicator approximately 1" deep into the space between the door and the rough opening and apply a 1" deep bead of foam. This will allow room for expansion of the foam and will minimize squeeze out. If using insulating foam other than Great Stuff™ Window and Door Insulation Foam by the Dow Chemical Company, allow the foam to cure completely (usually 8 to 24 hours) before proceeding to the next step.

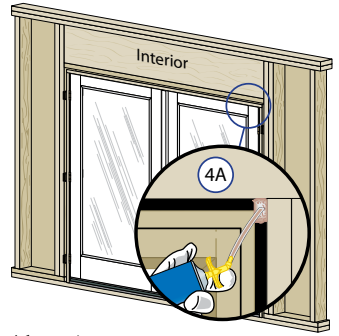

Note: DO NOT completely fill the space from the back of the fin to the interior face of the opening.

- B. **Check the door operation** by opening and closing the door.

Note: If the door does not operate correctly, check to make sure it is still plumb, level, square and that the sides are not bowed. If adjustments are required, remove the foam with a serrated knife. Adjust the shims, and reapply the insulating foam sealant.

5 SEALING THE DOOR TO THE EXTERIOR WALL CLADDING

When applying siding, brick veneer or other exterior finish material, leave adequate space between the door frame and the material for sealant. Refer to the illustration that corresponds to your finish material.

Note: The sealant details shown are standard recommendations from the sealant industry. Contact your sealant supplier for recommendations and instructions for these and any other applications.

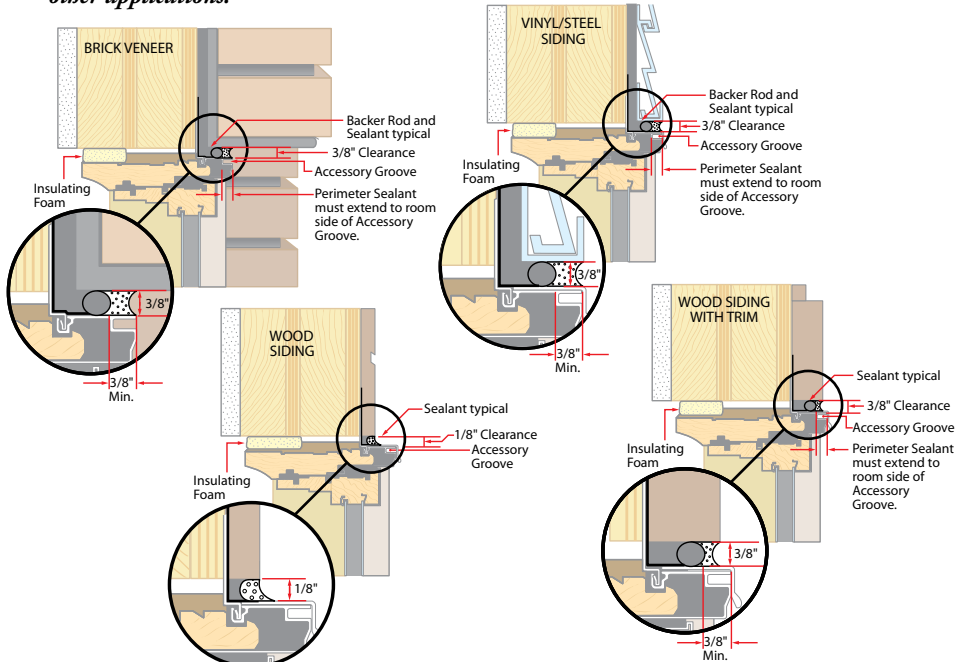

- A. **Install the hardware.** Refer to the instructions included in the hardware box.
- B. **Insert backer rod into the space around the door** 3/8" to 1/2". This should provide at least a 3/8" clearance between the backer rod and the exterior face of the door.

Note: Backer rod adds shape and depth for the sealant line.

- C. **Apply a bead of high quality exterior grade sealant** to the entire perimeter of the door. At each end of the bottom of the door, insert sealant into the spaces between the bottom of the door and the sill support and connect it to the perimeter sealant.

- D. **Shape, tool and clean excess sealant.** When finished, the sealant should be the shape of an hourglass.

Note: This method creates a more flexible sealant line capable of expanding and contracting.

- E. **Remove plastic guards at the base of the door** once construction is complete.

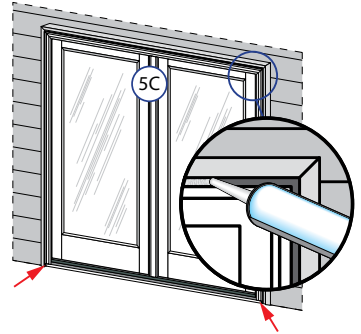
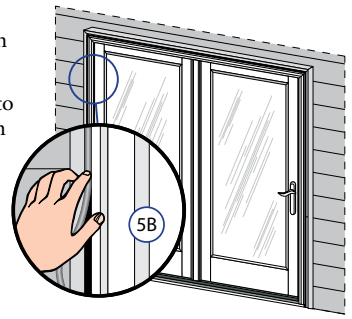

INTERIOR FINISHING

If products cannot be finished immediately, cover with clear plastic to protect from dirt, damage and moisture. Remove any construction residue before finishing. Sand all wood surfaces lightly with 180 grit or finer sandpaper. DO NOT use steel wool. BE CAREFUL NOT TO SCRATCH THE GLASS. Remove sanding dust.

Pella products must be finished per the below instructions; failure to follow these instructions voids the Limited Warranty.

- On casement and awnings, it is optional to paint, stain or finish the vertical and horizontal sash edges.
- On single-hung and double-hung, do not paint, stain or finish the vertical sash edges, any finish on the vertical sash edges may cause the sash to stick; it is optional to paint, stain or finish the horizontal sash edges.
- On patio doors, it is optional to paint, stain or finish the vertical and horizontal panel edges.

Note: To maintain proper product performance do not paint, finish or remove the weather-stripping, mohair dust pads, gaskets or vinyl parts. Air and water leakage will result if these parts are removed. After finishing, allow venting.

Pella Corporation is not responsible for interior paint and stain finish imperfections for any product that is not factory-applied by Pella Corporation. Use of inappropriate finishes, solvents, brickwash, or cleaning chemicals will cause adverse reactions with window and door materials and voids the Limited Warranty.

For additional information on finishing see the Pella Owner's Manual or go to www.pella.com.

EXTERIOR FINISH

The exterior frame and sash are protected by aluminum cladding with our tough EnduraClad® or EnduraClad Plus baked-on factory finish that needs no painting. Clean this surface with mild soap and water. Stubborn stains and deposits may be removed with mineral spirits. **DO NOT** use abrasives. **DO NOT** scrape or use tools that might damage the surface.

Use of inappropriate finishes, solvents, brickwash or cleaning chemicals will cause adverse reactions with window and door materials and voids the Limited Warranty.

CARE AND MAINTENANCE

Care and maintenance information is available in the Pella Owner's Manual. You can obtain an owner's manual by contacting your local Pella retailer. This information is also available on <http://www.pella.com>.

IMPORTANT NOTICE

Because all construction must anticipate some water infiltration, it is important that the wall system be designed and constructed to properly manage moisture. Pella Corporation is not responsible for claims or damages caused by anticipated and unanticipated water infiltration; deficiencies in building design, construction and maintenance; failure to install Pella products in accordance with Pella's installation instructions; or the use of Pella products in wall systems which do not allow for proper management of moisture within the wall systems. The determination of the suitability of all building components, including the use of Pella products, as well as the design and installation of flashing and sealing systems are the responsibility of the Buyer or User, the architect, contractor, installer, or other construction professional and are not the responsibility of Pella.

Pella products should not be used in barrier wall systems which do not allow for proper management of moisture within the wall systems, such as barrier Exterior Insulation and Finish Systems, (EIFS) (also known as synthetic stucco) or other non-water managed systems. Except in the states of California, New Mexico, Arizona, Nevada, Utah, and Colorado, **Pella makes no warranty of any kind on and assumes no responsibility for Pella windows and doors installed in barrier wall systems. In the states listed above, the installation of Pella Products in barrier wall or similar systems must be in accordance with Pella's installation instructions.**

Product modifications that are not approved by Pella Corporation will void the Limited Warranty.

Free Manuals Download Website

<http://myh66.com>

<http://usermanuals.us>

<http://www.somanuals.com>

<http://www.4manuals.cc>

<http://www.manual-lib.com>

<http://www.404manual.com>

<http://www.luxmanual.com>

<http://aubethermostatmanual.com>

Golf course search by state

<http://golfingnear.com>

Email search by domain

<http://emailbydomain.com>

Auto manuals search

<http://auto.somanuals.com>

TV manuals search

<http://tv.somanuals.com>