

INSTALLATION INSTRUCTION - INSTRUCCIONES DE INSTALACION FOR SLIDING PATIO DOOR

Lea las instrucciones en español en el reverso.

Installation Instructions for Typical Wood Frame Construction.

These instructions were developed and tested for use with typical wood frame wall construction in a wall system designed to manage water. **These instructions are not to be used with any other construction method.** Installation instructions for use with other construction methods or multiple units may be obtained from Pella Corporation or local Pella retailer. Building designs, construction methods, building materials, and site conditions unique to your project may require an installation method different from these instructions and additional care. Determining the appropriate installation method is the responsibility of you, your architect, or construction professional.

Handling and Storage: Provide full support under the framework while storing, moving and installing the product. DO NOT lift the product by the head member only. Remove the plastic shipping material prior to storing or installing the product. DO NOT store in direct sunlight. Allow sufficient spacing between products for ventilation.









YOU WILL NEED TO SUPPLY:

- Cedar or Impervious shims/spacers (12 to 20)
- 2" galvanized roofing nails (1/4 to 1/2 lb.)
- Closed cell foam backer rod/sealant backer (12 to 30 ft.)
- Pella® SmartFlash™ foil backed butyl window and door flashing tape or equivalent
- High quality exterior grade polyurethane or silicone sealant (2 to 3 tubes per door)
- Great Stuff™ Window and Door Insulating Foam Sealant by the Dow Chemical Company or equivalent low pressure polyurethane window and door foam - DO NOT use high pressure or latex foams.
- Wood blocking for sill
- Optional stainless steel screws and anchors for installation on concrete floor.

For High Performance Applications:

- #8 x 1-1/2" corrosion resistant Phillips pan head screws (75 to 100)
- #8 x 3/4" outside diameter corrosion resistant flat washers (75 to 100)

TOOLS REQUIRED:

- Tape measure 
- 2' or 4' Level 
- Square 
- Hammer 
- Stapler 
- Sealant gun 
- Scissors or utility knife 
- Screwdrivers (#2 Phillips with 8" shaft and small flat blade) 
- Drill 

Installation will require two or more persons for safety reasons.

REMEMBER TO USE APPROPRIATE PERSONAL PROTECTIVE EQUIPMENT.

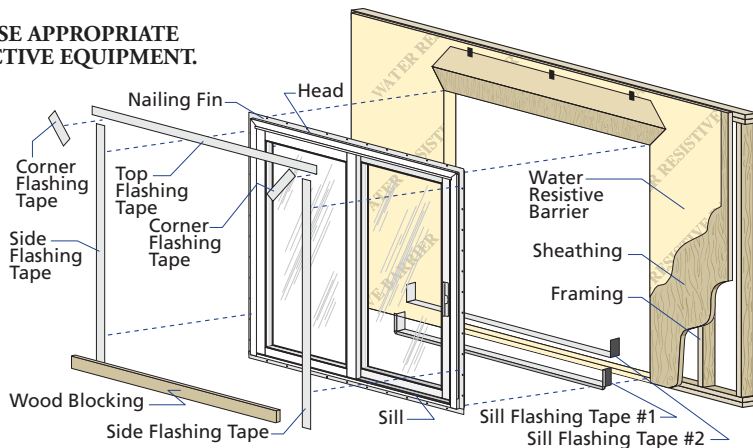

Always read the Vinyl Window and Door Limited Warranty before purchasing or installing Vinyl Windows and Doors manufactured by Pella Corporation. By installing this product, you are acknowledging that this Limited Warranty is part of the terms of the sale. Failure to comply with all Pella installation and maintenance instructions may void your Pella product warranty. See Limited Warranty for complete details at <http://warranty.pella.com>.

1 ROUGH OPENING PREPARATION

- A. **Verify the opening is plumb and level.** Ensure the bottom of the rough opening does not slope toward the interior.

Note: It is critical that the bottom is level.

- B. **Verify the door will fit the opening.** Measure all four sides of the opening to make sure it is 1/2" larger than the door in width and height. Measure the width at the top, bottom, and center. Measure the height at the far left side, the far right side, and in the center.

Note: 1-1/2" or more of solid wood blocking is required around the perimeter of the opening. Fix any problems with the rough opening before proceeding.

- C. **Cut the water resistive barrier (1C).**

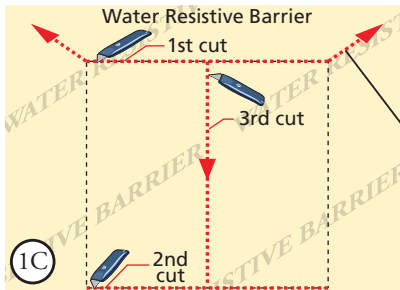

4th cut:
Make a 6" cut up from each top corner at a 45° angle to allow the water resistive barrier to be lapped over the fin at the head of the door.

- D. **Fold the water resistive barrier (1D).** Fold side flaps into the opening and staple to inside wall. Fold top flap up and temporarily fasten with flashing tape.

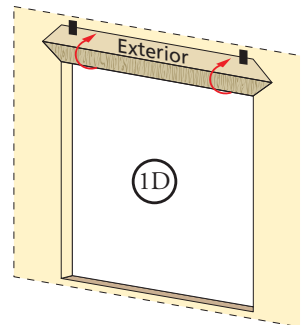

- E. **Apply sill flashing tape #1.** Cut a piece of flashing tape 12" longer than the opening width. Apply at the bottom of the opening as shown (1E) so it overhangs 1" to the exterior.

Note: The tape is cut 12" longer than the width of the opening so that it will extend up each side approximately 6".

- F. **Tab the sill flashing tape and fold.** Cut 1" wide tabs at each corner (1/2" from each side of corner) (1F). Fold tape to the exterior and press firmly to adhere it to the water resistive barrier.

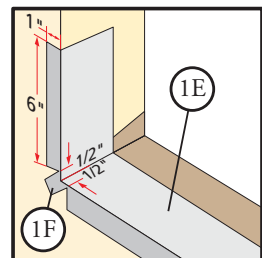

- G. **Apply sill flashing tape #2.** Cut a piece of flashing tape 12" longer than the opening width. Apply at the bottom, overlapping tape #1 by at least 1". DO NOT allow the tape to extend past the interior face of the framing (1G).

Note: The flashing tape does not need to extend all the way to the interior of the framing.

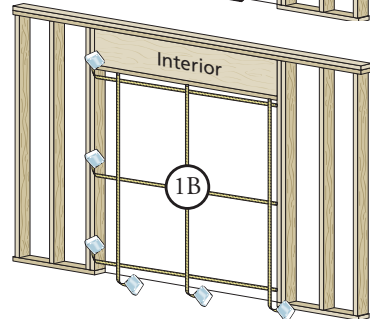
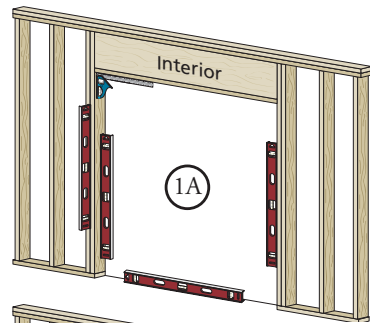
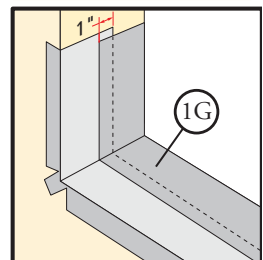

2 PREPARE THE DOOR FOR INSTALLATION

TWO OR MORE PEOPLE WILL BE REQUIRED TO HANDLE THE PANEL SAFELY.

- A. **Remove the packaging from the door.** Inspect the frame and sash for damage. DO NOT install damaged units.

Note: If screens or hardware are removed from the door at this time, label them and store them in a protected area.

- B. **Relocate the slide panel bumper.** Remove the bumper located at the top of the fixed jamb, and install in the fixed jamb against the sill track.

- C. **Remove the venting panel.** Slide the panel to the open position, making sure it clears the anti-lift clip. Lift the panel out of the lower track and tilt the bottom of the panel away from the door frame. Then, lower the panel out of the top track. Carefully set the panel aside in a safe place.

REVERSING DOOR SLIDE: If changing the slide of the door panel, refer to Installation Instructions (Reversing Door Slide) later in this booklet. Note: Doors with Blinds-Between-the-Glass are not reversible.

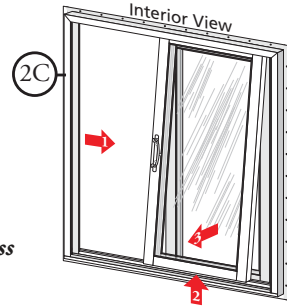
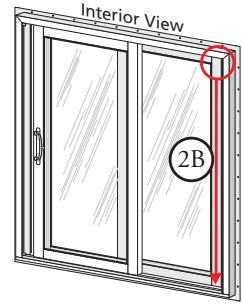

3 SETTING AND FASTENING THE DOOR

TWO OR MORE PEOPLE WILL BE REQUIRED FOR THE FOLLOWING STEPS.

IF INSTALLING ON A CONCRETE FLOOR, refer to Installation Instructions (Bottom Fin Removal) later in this booklet.

- A. **Insert the door from the exterior of the building.** Place the bottom of the door at the bottom of the opening, then tilt the top into position. Center the door between the sides of the opening to allow equal clearance for shimming, and insert one roofing nail in the first hole from the corner on each end of the top nailing fin. These are used to hold the door in place while shimming it plumb and square.

Note: When installing doors without a bottom fin, DO NOT slide the bottom of the door into the opening, as sliding will damage the sealant lines. Insert sill anchor screws prior to shimming.

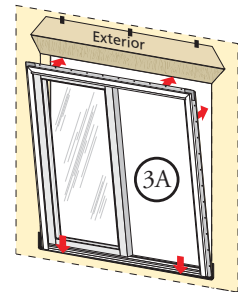
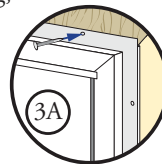

- B. **Plumb and square door.** Insert shims between the door and the sides of the rough opening starting up 6" from the bottom of the door. Also shim between the top of the door and the rough opening above the fixed interlocker and at the mid-point between the fixed interlocker and the lock jamb.

Note: DO NOT over shim.

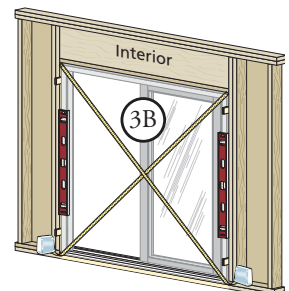

C. Fasten the door to opening:

Note: Pre-drilling the additional holes in the fin at the interlocker will make installation easier and will help prevent damage to the fin. Use a 3/16" drill bit to pre-drill the holes.

Standard Installation: Beginning in the first hole from the fin corner, drive 2" galvanized roofing nails into every other pre-punched hole in the nailing fin. Drive four additional nails through the head and sill fin at the fixed interlock location. Space the nails 2" on center and position them so there are two nails on each side of the interlocker. Drive the nails until the head contacts the fin, however do not sink the head. This will allow for movement of building material.

High Performance Installation: Beginning in the first hole from the fin corner, insert a #8 x 1-1/2" corrosion resistant screw with a 3/4" outside diameter flat washer into every hole of the installation fin. Drive four additional screws through the head and sill fin at the fixed interlock location. Space the screws 2" on center and position them so there are two screws on each side of the interlocker. Drive the screws until the head/washer contacts the fin, however do not sink the washer. This will allow for movement of building material.

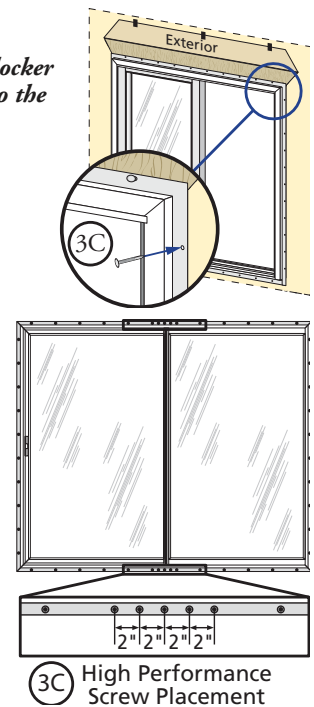

4 INTEGRATING THE DOOR TO THE WATER RESISTIVE BARRIER

A. **Apply side flashing tape.** Cut two pieces of flashing tape 4" longer than the frame height of the door. Apply one piece to each side over the nailing fin and onto the water resistive barrier. The tape should extend 2" above the top of the door and 2" below the bottom of the door. Press the tape down firmly.

B. **Apply top flashing tape.** Cut a piece of flashing tape long enough to go across the top of the door and extend at least 1" past the side flashing tape on both sides. Apply the tape over the top nailing fin as shown. Press the tape down firmly.

Note: The tape should cover the entire nailing fin, but not extend onto the door frame. The top flashing tape must overlap the side flashing tape to prevent water from getting behind it.

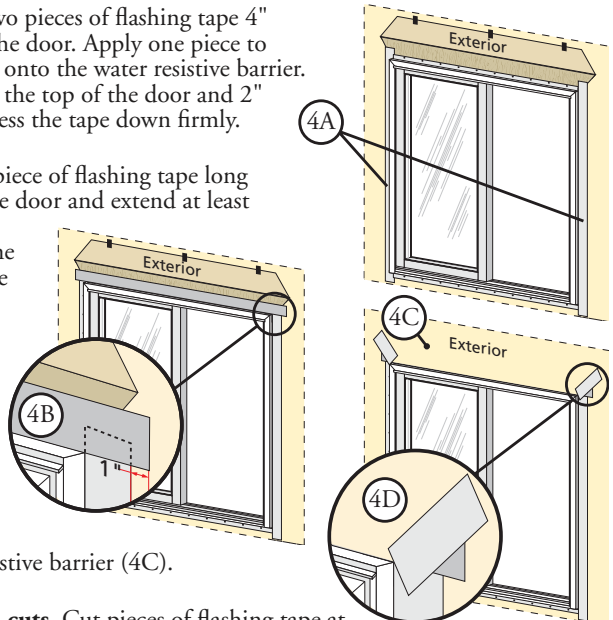

C. **Fold down top flap** of water resistive barrier (4C).

D. **Apply flashing tape to diagonal cuts.** Cut pieces of flashing tape at least 1" longer than the diagonal cuts in the water resistive barrier. Apply the tape, covering the entire diagonal cut in the water resistive barrier at both upper corners of the door. Press the tape down firmly.

Note: Be sure to overlap the top corners (4D).

E. **Attach wood blocking** to the exterior of the opening to support the edge of the door sill.

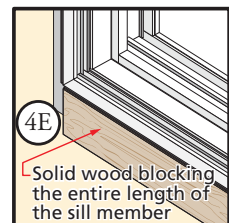

5 REINSTALL THE SLIDING PANEL

TWO OR MORE PEOPLE WILL BE REQUIRED TO HANDLE THE PANEL SAFELY.

- A. **Insert door panel.** From the interior of the building, tilt the top of the panel toward the door frame and insert the top of the door panel into the top track. Move the bottom of the panel toward the door frame until it is vertical. Gently set the panel down into the bottom track.

Note: Make sure the top of the panel clears the anti-lift clip before attempting to place the panel on the bottom track.



- B. **Adjust the rollers** so that the slide panel runs freely and is parallel to the fixed interlocker. Rotate roller adjustment screws clockwise to raise the panel or counter-clockwise to lower the panel. They are located at the bottom of the slide panel at both ends. Once plumb, adjust the slide panel to the proper height to attain even coverage of the weatherstrip at both the top and bottom as viewed from the exterior.

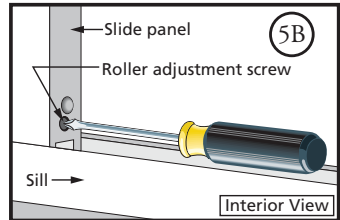

- C. **Identify the keeper** in the hardware package and perform the keeper attachment steps based on which keeper is in the package.

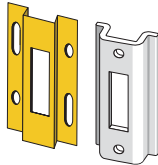

Determine the keeper location by opening the panel a few inches, and extending the lock hook. With a pencil, mark the location on the jamb directly across from the top of the shank.

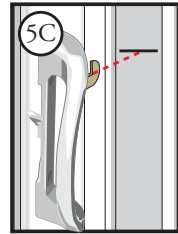
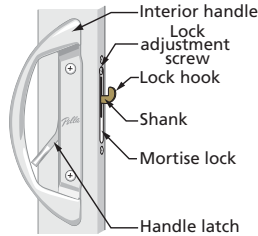

- D. **Place the keeper with 4 screw holes** on the jamb so the top of the slot is aligned with the pencil mark. Attach by inserting a #6 x 1/2" starter screw into one of the slotted keeper holes.

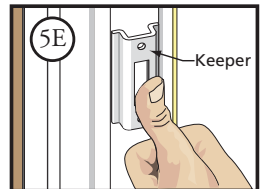
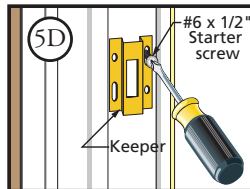

- E. **Place the keeper with 2 screw holes** on the jamb by "snapping" it into the frame jamb at the desired location. The keeper may be moved up or down to align with the pencil mark. The keeper will stay in position until attached with screws.

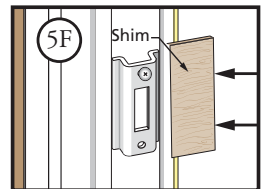
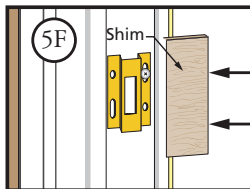

- F. **Insert a shim** between the frame jamb and the rough opening at the keeper location.

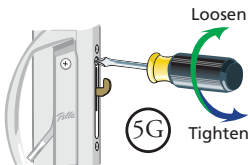

- G. **Adjust the lock hook** by turning the door lock adjustment screw clockwise to loosen or counter-clockwise to tighten until the mortise lock is aligned properly, the door locks easily, and there is less than 1/16" movement when the door is locked.

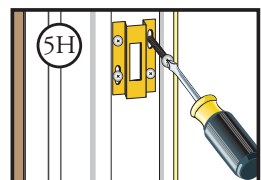

- H. **Install the keeper** by inserting 3" long screws (provided) through the keeper holes, the shim and into the rough opening frame members. Remove the starter screw from the 4 screw hole keeper and replace it with a 3" long screw.

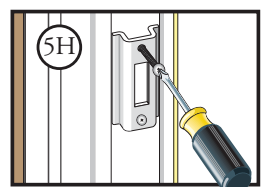

- I. **Install screen** by inserting the top of the screen into the screen pocket located at the exterior head of the patio door. Compress the top rollers just enough to allow the bottom of the screen to be inserted onto the bottom screen track. Adjust the screen rollers by turning the adjustment screw located at the top and bottom until the screen operates smoothly and is plumb and centered from top to bottom. Install the screen keeper if desired.

6 INTERIOR SEAL

Caution: Ensure use of low pressure polyurethane window and door insulating foams and strictly follow the foam manufacturer's recommendations for application. Use of high pressure foams or improper application of the foam may cause the door frame to bow and hinder operation.

- A. **Apply insulating foam sealant.** From the interior, insert the nozzle of the applicator approximately 1" deep into the space between the door and the rough opening and apply a 1" deep bead of foam. This will allow room for expansion of the foam and will minimize squeeze out. If using foam other than Great Stuff™ Window and Door Insulating Foam Sealant by the Dow Chemical Company, allow the foam to cure completely (usually 8 to 24 hours) before proceeding to the next step.

Note: It may be necessary to squeeze the end of the tube with pliers to be able to insert into the space between the door frame and the rough opening. **DO NOT** completely fill the space from the back of the fin to the interior face of the door.

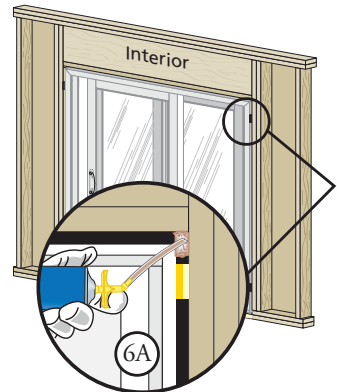

- B. **On the interior, seal the door sill to the floor** with a corner bead of sealant. Connect this bead of sealant to the insulating foam at both door jambs.
- C. **Check door operation** by opening and closing the door.

Note: If the door does not operate correctly, check to make sure it is still plumb, level, square and that the sides are not bowed. If adjustments are required, remove the foam with a serrated knife. Adjust the shims, and reapply the insulating foam sealant.

7 SEALING THE DOOR TO THE EXTERIOR WALL CLADDING

Note: When applying siding, brick veneer or other exterior finish materials, leave adequate space between the door frame and the material for sealant. Refer to the illustration that corresponds to your finish material. Not allowing adequate space or not using backer rod may cause the sealant to break down prematurely and allow water to infiltrate.

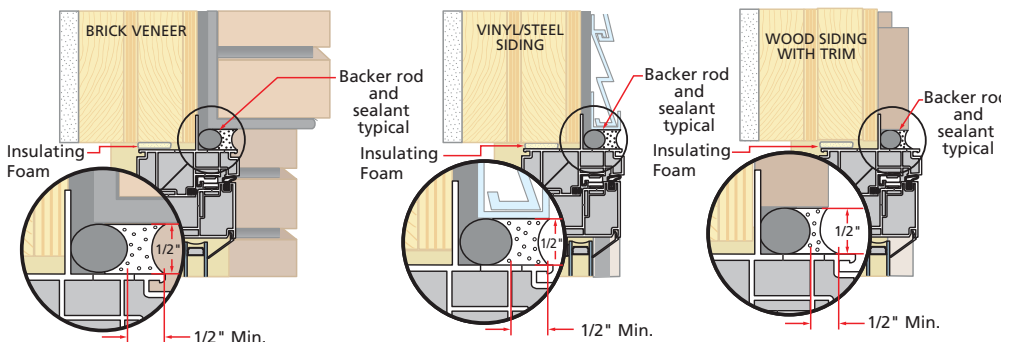

- A. **Insert closed cell foam backer rod** into the space around the door approximately 1/2". This should provide at least a 1/2" clearance between the backer rod and the exterior face of the door.

Note: Backer rod adds shape and depth for the sealant line.

- B. **Apply a bead of high quality exterior grade sealant** to the entire perimeter of the door. On doors where the bottom fin has been removed, insert sealant into the spaces between the bottom of the door and the sill support and connect it to the perimeter sealant.

Note: Refer to the sealant manufacturer's label to verify compatibility with vinyl and the adjoining building components and priming requirements.

- C. **Seal the exterior drainage weeps at the head only** with high quality exterior grade sealant. **DO NOT** seal the drainage weeps at the sill.

- D. **Shape, tool and clean excess sealant.** When finished, the sealant should be the shape of an hourglass.

Note: This method creates a more flexible sealant line capable of expanding and contracting.

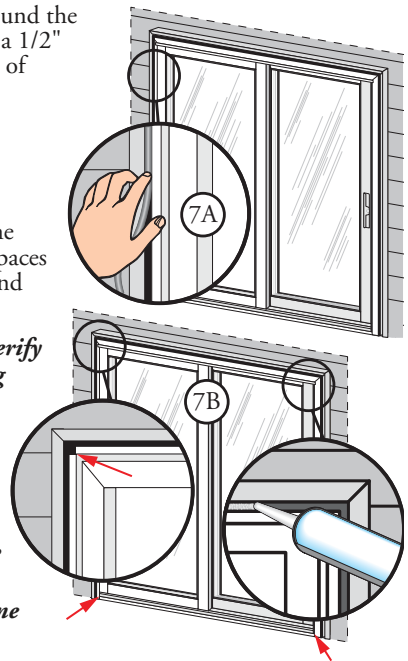

INSTALLATION INSTRUCTIONS (BOTTOM FIN REMOVAL)

- A. **To remove the bottom fin**, lay the door down with the interior facing up. With a utility knife, carefully score the entire length of the fin three times where it meets the sill. Bend the fin back and forth a few times, then peel the fin off.

Note: Keep the body of the knife against the frame to prevent gouging the sill.

- B. **Remove the sill track** by beginning at one end and carefully pulling it up. This will expose the slide panel pocket.

Note: A hooked tool like an allen wrench will easily get the track started.

- C. **Drill 3/16" holes through the sill** 18" from each corner and 1-3/16" from the interior of the door. Continue every 18" thereafter. Follow up by counter drilling the holes with a 3/8" drill making sure to only penetrate the interior wall of the door frame.

Note: You will need a drill guide set at 1/4" from the end of the drill bit. Without a drill guide, it is extremely difficult to prevent drilling through both walls of vinyl with the 3/8" drill. Penetrating the lower wall with this drill will make it very difficult to seal against water penetration and difficult to secure.

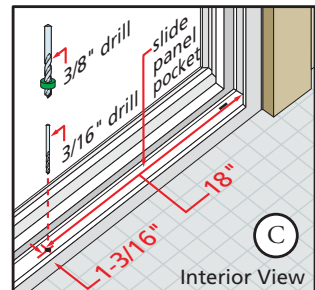

- D. **Dry fit the door.** Make sure that the door is plumb, square and level. Mark and drill anchor locations. Mark the interior of the door frame at the sill to show a boundary for sealant placement. Carefully remove and set the door aside. Install anchors.

- E. **Apply 2 continuous 1/4" to 3/8" diameter beads of sealant** across the sill of the opening and 12" up the jambs, towards the interior side of the door (between the anchor holes and interior edge of door). **DO NOT** apply sealant between the anchor holes and the exterior side of the sill plate or floor.

Note: Failure to properly seal the sill attachment screws and sill plate may allow water to penetrate the interior of the home.

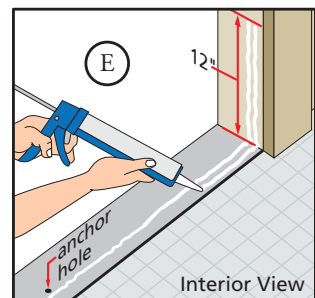

INSTALLATION INSTRUCTIONS (BOTTOM FIN REMOVAL) (continued)

F. Go to steps 3 and 4 to install the door frame into the opening. Then install the sill track before proceeding to step 5.

Note: At the sill, it is imperative that sealant be applied under the screw heads and that it surrounds them to prevent water leakage.

G. To snap the sill track in, place an 8" long 2" x 4" block on edge and begin tapping it from one end with a rubber mallet until the track snaps into its original position.

INSTRUCTIONS (REVERSING DOOR SLIDE)

Note: Doors with Blinds-Between-the-Glass are not reversible.

A. Remove the sill and screen tracks from the door.
(Use an allen wrench or small hook to begin removal.)

B. Rotate the main frame 180° (so the sill becomes the head).
Snap the sill and screen tracks into place at the bottom of the door. Carefully lay the panel on saw horses or a clean surface.

C. Extend the lock hook and clamp the lock hook with the vise grip.

Note: Use of the vise grip on the lock hook will prevent the mortise lock from falling when the lock mounting screws are removed.

D. Remove the door handle by removing the two attachment screws.

E. Remove the mortise lock. Remove the two screws that attach the lock assembly to the door panel. Work the lock down, then tilt it out and pull up.

F. Rotate 180° and reinstall the lock. Insert the mortise lock into the door panel with the lock adjusting screw positioned at the bottom, then tilt the top in and lift the lock into position. Insert the two mounting screws into the lock mounting holes.

G. Rotate the handle 180° and install the door handle by inserting the two backplate screws through the door panel and into the exterior handle.

Note: Rotating the handle will result in "Pella" script being upside down. A new handle must be ordered for "Pella" to be in correct orientation.

Note: The latch lever must engage the slot in the side of the mortise lock assembly.

H. Remove the bottom rollers from the slide panel by removing the upper screw. Reinstall the rollers in the opposite end of the door panel.

I. High Performance Doors only: Remove the blocks from the top rail of the door panel and reinstall them at the opposite end of the panel.

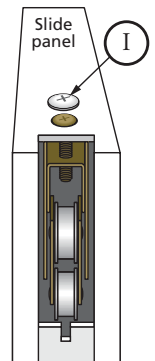
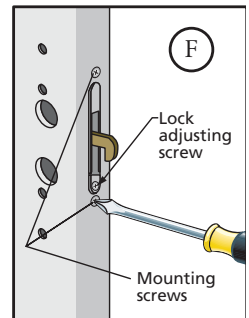
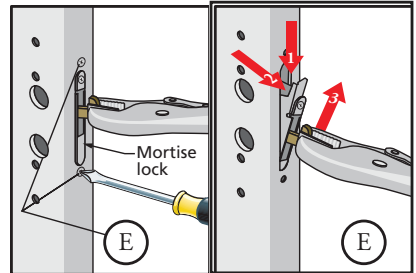
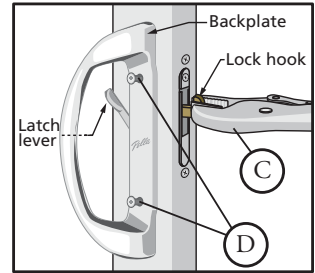

CLEANING INSTRUCTIONS

Remove labels and clean the glass, using a soft, clean, grit-free cloth and mild soap or detergent. Be sure to remove all liquid by wiping dry or use a clean squeegee. The vinyl frame may be cleaned as described above. For stubborn dirt, a "non-abrasive" cleaner such as Bon-Ami® or Soft Scrub® may be used. Do not use solvents such as mineral spirits, toluene, xylene, naphtha or muriatic acid as they can dull the finish, soften the vinyl and/or cause failure of the insulated unit seal. Keep door tracks clear of dirt and debris. Keep weep holes open and clear of obstructions.

IMPORTANT NOTICE

Because all construction must anticipate some water infiltration, it is important that the wall system be designed and constructed to properly manage moisture. Pella Corporation is not responsible for claims or damages caused by anticipated and unanticipated water infiltration; deficiencies in building design, construction and maintenance; failure to install Pella products in accordance with Pella's installation instructions; or the use of Pella products in wall systems which do not allow for proper management of moisture within the wall systems. The determination of the suitability of all building components, including the use of Pella products, as well as the design and installation of allow for proper management of moisture within the wall systems. The determination of the suitability of all building components, including the use of Pella products, as well as the design and installation of flashing and sealing systems are the responsibility of the Buyer or User, the architect, contractor, installer, or other construction professional and are not the responsibility of Pella.

Pella products should not be used in barrier wall systems which do not allow for proper management of moisture within the wall systems, such as barrier Exterior Insulation and Finish Systems, (EIFS) (also known as synthetic stucco) or other non-water managed systems. Except in the states of California, New Mexico, Arizona, Nevada, Utah, and Colorado, **Pella makes no warranty of any kind on and assumes no responsibility for Pella windows and doors installed in barrier wall systems. In the states listed above, the installation of Pella Products in barrier wall or similar systems must be in accordance with Pella's installation instructions.**

Product modifications that are not approved by Pella Corporation will void the Limited Warranty.

Free Manuals Download Website

<http://myh66.com>

<http://usermanuals.us>

<http://www.somanuals.com>

<http://www.4manuals.cc>

<http://www.manual-lib.com>

<http://www.404manual.com>

<http://www.luxmanual.com>

<http://aubethermostatmanual.com>

Golf course search by state

<http://golfingnear.com>

Email search by domain

<http://emailbydomain.com>

Auto manuals search

<http://auto.somanuals.com>

TV manuals search

<http://tv.somanuals.com>