



INSTALLATION INSTRUCTION - INSTRUCCIONES DE INSTALACION 350 SERIES O,OX/XO SLIDING PATIO DOOR WITH FIXED PANEL INSTALLED

Lea las instrucciones en español en el reverso.

Table Of Contents

Installation Instruction Information	Page-1
Exploded View of Installation and Parts List.....	Page-2
Step 1: Rough Opening Preparation.....	Page-3
Step 3: Setting and Fastening the Door	Page-4
Step 2: Prepare the Door for Installation	Page-4
Step 4: Reinstall the Sliding Panel	Page-7
Step 5: Integrating the Door to the Water Resistive Barrier	Page-8
Step 6: Interior Seal	Page-8
Step 7: Sealing the Door to the Exterior Wall Cladding	Page-9
Step 8: Flush Flange Opening Preparation.....	Page-11
Step 9: Setting and Fastening the Door in Flush Flange Applications.....	Page-13
Step 10: Optional Sill Pan Fabrication and Installation.....	Page-15
Cleaning Instructions and Important Notice Preparation.....	Page-16

Installation Instructions for Typical Wood Frame Construction and Concrete Block Constructions.

These instructions were developed and tested for use with typical wood frame wall and concrete block constructions in a wall system designed to manage water. Installation details specific to replacement of Aluminum Sliding Doors in Hard Coat Stucco applications can be found at the end of this instruction. **These instructions are not to be used with any other construction method.** Installation instructions for use with other construction methods or multiple units may be obtained from Pella Corporation or local Pella retailer. Building designs, construction methods, building materials, and site conditions unique to your project may require an installation method different from these instructions and additional care. Determining the appropriate installation method is the responsibility of you, your architect, or construction professional.

The performance of any building is dependent upon the design, installation, and workmanship of the entire building system. Pella Corporation strongly recommends consulting an experienced architect, contractor, or structural engineer prior to installation of Pella products. The individual (building owner, architect, contractor, installer and/or consumer) responsible for the project must take into account local conditions, building codes, inherent component limitations, the effects of aging and weathering on building components, and other design issues relevant to each project. The determination of the suitability of all building components for each project, as well as the design and installation of flashing and sealing systems, are the responsibility of the building owner, architect, contractor, installer and/or consumer





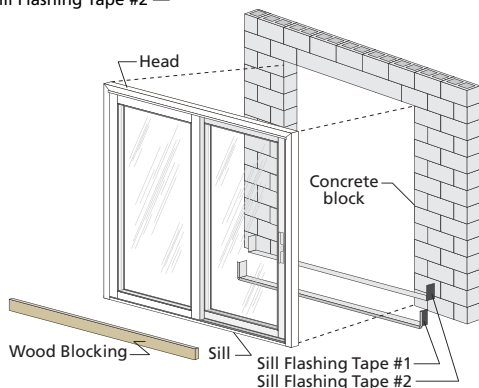
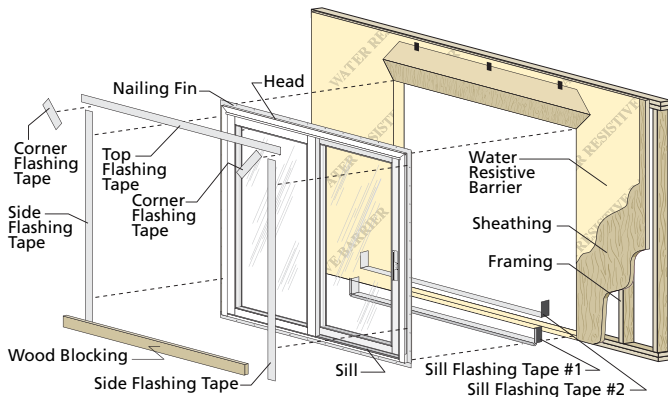

Handling and Storage: Provide full support under the framework while storing, moving and installing the product. **DO NOT** lift the product by the head member only. Remove the plastic shipping material prior to storing or installing the product. **DO NOT** store in direct sunlight. Allow sufficient spacing between products for ventilation

REMEMBER TO USE APPROPRIATE PERSONAL PROTECTIVE EQUIPMENT.













Always read the Vinyl Window and Door Limited Warranty before purchasing or installing Vinyl Windows and Doors manufactured by Pella Corporation. By installing this product, you are acknowledging that this Limited Warranty is part of the terms of the sale. Failure to comply with all Pella installation and maintenance instructions may void your Pella product warranty. See Limited Warranty for complete details at <http://warranty.pella.com>.

YOU WILL NEED TO SUPPLY:

- Cedar/impervious shims/spacers (24 to 40) 
- 2" galvanized roofing nails (Nail-fin only) (1/4 lb.) 
- 1/4" x 2" masonry screws for concrete application 
- Closed cell foam backer rod/sealant backer (20 to 30 ft.) 
- Pella® SmartFlash™ foil backed butyl window and door flashing tape or equivalent 
- High quality exterior grade polyurethane or silicone sealant (2 to 3 tubes per door) 
- Great Stuff™ Window and Door Insulating Foam Sealant by the Dow Chemical Company or equivalent low pressure polyurethane window and door foam - **DO NOT** use high pressure or latex foams. 
- Pella aluminum sill support or 2 x 4 wood blocking
- Pella sill pan or equivalent
- Interior trim and/or jamb extensions (20 to 30 ft.)

TOOLS REQUIRED:

- Tape measure 
- Level 
- Square 
- Hammer 
- Stapler 
- Sealant gun 
- Scissors or utility knife 
- Screwdrivers (#2 Phillips) 
- 3"-5" Wide putty knife 
- Drill 
- #2 Phillips bit 
- Square (Robertson) drill bit 

Installation will require two or more persons for safety reasons.

1 ROUGH OPENING PREPARATION

If replacing an Aluminum sliding door in hardcoat stucco, see Step 8 Flush Flange Opening Preparation on page 11.

- A. **Confirm the opening is plumb and level.** Ensure the bottom of the rough opening does not slope toward the interior.

Note: For peak water performance it is critical the bottom be level within +/- 1/16".

- B. **Confirm the door will fit the opening.** Measure all four sides of the opening to make sure it is 1/2" larger than the door in width and height. Measure the width at the top, bottom, and center. Measure the height at the far left side, the far right side, and in the center.

Note: 1-1/2" or more of solid wood blocking is required around the perimeter of the opening. Fix any problems with the rough opening before proceeding.

- C. **Nail-fin only: Cut the water resistive barrier (1C).**

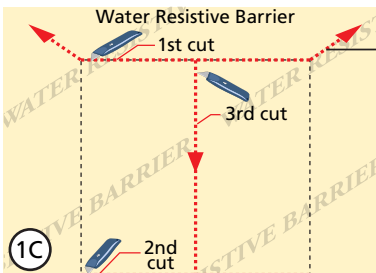

4th cut:
Make a 6" cut up from each top corner at a 45° angle to allow the water resistive barrier to be lapped over the fin at the head of the door.

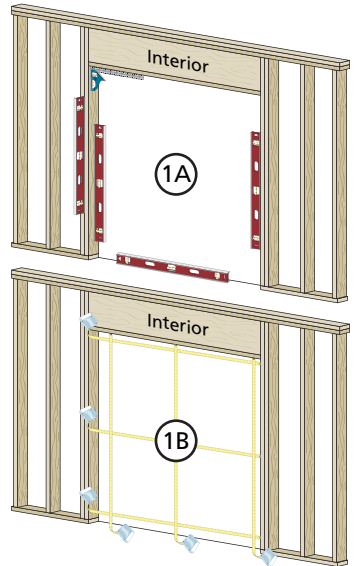

- D. **Nail-fin Only:** Fold the water resistive barrier (1D). Fold side flaps into the opening and staple to inside wall. Fold top flap up and temporarily fasten with flashing tape.

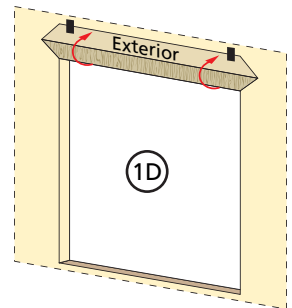

- E. **Apply sill flashing tape #1.** Cut a piece of flashing tape 12" longer than the opening width. Apply at the bottom of the opening as shown (1E) so it overhangs 1" to the exterior.

Note: The tape is cut 12" longer than the width of the opening so that it will extend up each side approximately 6".

- F. **Tab the sill flashing tape and fold.** Cut 1" wide tabs at each corner (1/2" from each side of corner) (1F). Fold tape to the exterior and press firmly to adhere it to the water resistive barrier.

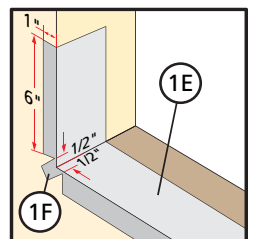

1 ROUGH OPENING PREPARATION (CONTINUED)

- G. **Apply sill flashing tape #2.** Cut a piece of flashing tape 12" longer than the opening width. Apply at the bottom, overlapping tape #1 by at least 1". **DO NOT** allow the tape to extend past the interior face of the framing (1G).

Note: The flashing tape does not need to extend all the way to the interior of the framing.

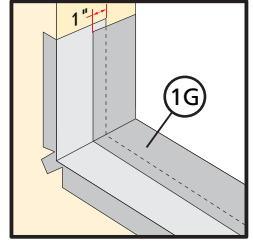

If using optional sill pan, see Step 10 Sill Pan Fabrication and Installation on page 15.

2 PREPARE THE DOOR FOR INSTALLATION

TWO OR MORE PEOPLE WILL BE REQUIRED TO HANDLE THE PANEL SAFELY

- A. **Remove the packaging from the door.** Inspect the frame and panels for damage. **DO NOT** install damaged units.
- Note: If screens or hardware are removed from the door at this time, label them and store them in a protected area.**
- B. **Locate the kitted parts bag.** Remove from unit and place in a safe location that is accessible during the door installation.
- C. **Remove the vent panel.** With the jamb side of the door down, slide the panel all the way to one direction, while lifting the panel out of the bottom frame pocket. Swing the panel out of the frame.
- D. **Transom/Sidelight only:** Remove the sill track and pocket covers by pulling on the paper ring. **DO NOT** damage these items as they will be re-installed once the frame is fastened to the opening.

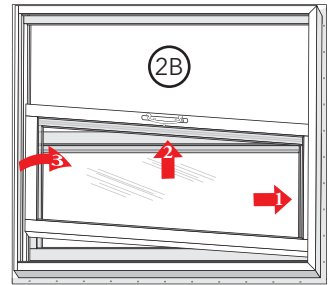

Interior View

3 SETTING AND FASTENING THE DOOR

TWO OR MORE PEOPLE WILL BE REQUIRED TO HANDLE THE PANEL SAFELY

If installing in a block replacement or a concrete floor, go to Step 3A to remove the bottom fin. If NOT removing the bottom fin go to Step B.

- A. **To remove the bottom fin,** lay the door down with the interior facing up. With a utility knife, carefully score the entire length of the fin three times where it meets the sill. Bend the fin back and forth a few times, then peel the fin off.

Note: Keep the body of the knife against the frame to prevent gouging the sill.

3 SETTING AND FASTENING THE DOOR (CONTINUED)

B. **Dry fit the door.** Make sure the door is plumb, square and level. Drill anchor locations with 1/8" masonry bit. Mark the interior of the door frame at the sill to show a boundary for sealant placement. Carefully remove and set the door aside.

C. **Apply two continuous 1/4" to 3/8" diameter beads of sealant** across the sill of the opening and 12" up the jambs, towards the interior side of the door (between the anchor holes and interior edge of door). **DO NOT** apply sealant between the anchor holes and the exterior side of the sill plate or floor.

Note: Failure to properly seal the sill attachment screws and sill plate may allow water to penetrate the interior of the home.

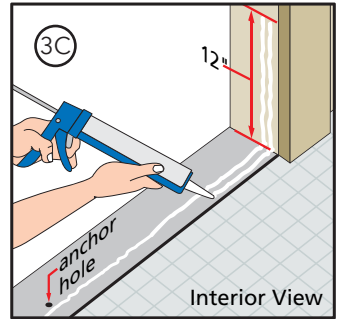

D. **Insert the door from the exterior of the building.** Place the bottom of the door at the bottom of the opening, then tilt the top into position. Center the door between the sides to allow equal clearance for shimming. Make sure the door is plumb, level and square.

Door Frames with Nail Fin: Insert one 2" galvanized roofing nail into the top of each jamb nailing fin.

Door Frames without Nail Fin: Insert one screw in the top hole of each jamb.

Note: When installing doors without a bottom fin, DO NOT slide the bottom of the door into the opening, as sliding will damage the sealant lines. Insert sill anchor screws prior to shimming.

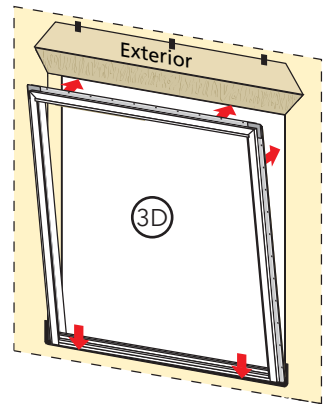

E. **Plumb and square the door.** Insert shims at the jambs between the door and the sides of the rough opening. Place shims behind each of the pre-drilled installation holes. **DO NOT** place shims at the sill. **DO NOT** place shims at the head until Step 4I.

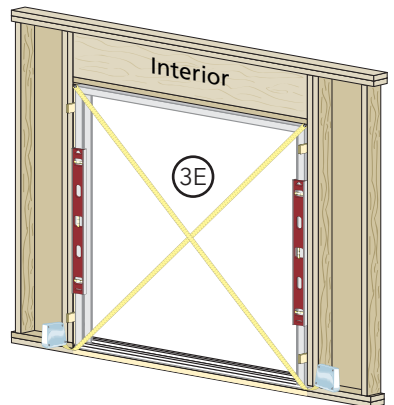

3 SETTING AND FASTENING THE DOOR (CONTINUED)

F. Fasten the door to the opening:

Door Frames with Nail Fin Only: Insert one 2" galvanized roofing nail into every other pre-punched hole in the nailing fin.

All Frame Types:

Transom/Sidelight: Remove the sill track and pocket covers by pulling on the paper ring.

Head and Jamb: At each pre-drilled installation hole, drill 1/8" pilot holes through the outer frame wall, shims and the rough opening. Drive #10 x 2" corrosion resistant pan head screws (wood rough openings) or 1/4" x 2" masonry screws (masonry rough openings) into each pre-drilled hole.

Sill: Place a dab of sealant in each pre-drilled hole in the sill prior to installing the sill screws. Place a #10 rubber washer on each sill screw. Drive the screw until the head contacts the frame, however **DO NOT** sink the head.

Note: At the sill, it is imperative that sealant be applied under the screw heads and that it surrounds them to prevent water leakage. Failure to properly seal the sill attachment screws may allow water to penetrate the interior of the home.

Sidelights and Transoms Only: Replace the pocket covers and sill track.

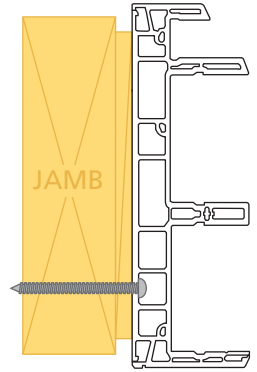

- G. **Secure the fixed panel(s)** by driving in the #10 x 1-1/2" fixed panel screws. Install the screws from the interior at an angle as shown. Space one screw 16" from the top and one 16" from the bottom then one screw in the center.

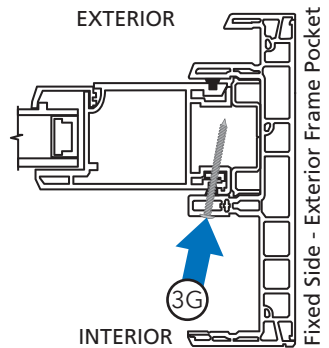

- H. **Install the panel track.** Clean the pocket of any debris and snap the track into the interior panel pocket.

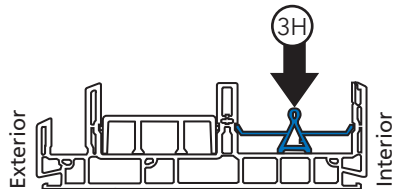

- I. **Install the panel bumpers.** Locate the slit on the bumper(s) and place it on the track. Press down to seat the bumper onto the panel track cap.

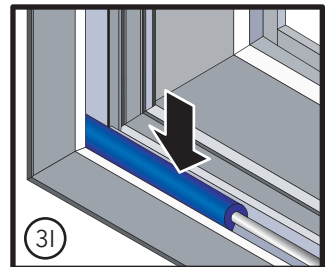

3 SETTING AND FASTENING THE DOOR (CONTINUED)

- J. **Install jamb pocket cover** in pocket above bumper.

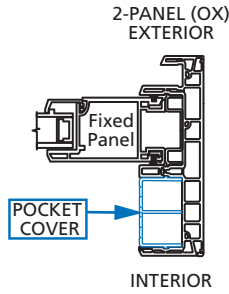

- K. **Install the lock keeper/strike.** Position the keeper/strike at the pre-drilled pilot holes. Insert a shim between the frame jamb and rough opening at the keeper/strike location. Fasten using (3) #10 x 3" screws (provided).

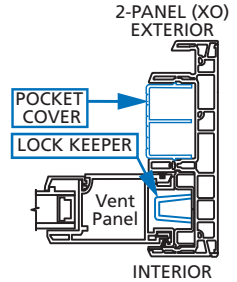

4 REINSTALL THE SLIDING PANEL

TWO OR MORE PEOPLE WILL BE REQUIRED TO HANDLE THE PANEL SAFELY.

- A. **Insert door panel.** From the interior of the building, tilt the top of the panel toward the door frame and insert the top of the door panel into the top track. Move the bottom of the panel toward the door frame until it is vertical. Gently set the panel down into the bottom track.

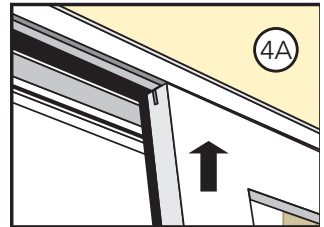

Note: Make sure the top of the panel clears the anti-lift clip before attempting to place the panel on the bottom track.

Note: A wide putty knife may be needed to raise the rollers above the sill when installing the panel.

- B. **Adjust the rollers** so that the slide panel runs freely and is parallel to the fixed interlocker. Rotate the middle roller screw clockwise to raise the panel or counter-clockwise to lower the panel. They are located at the bottom of the slide panel at both ends. Once plumb, adjust the slide panel to the proper height to attain even coverage of the weather strip at both the top and bottom as viewed from the exterior.

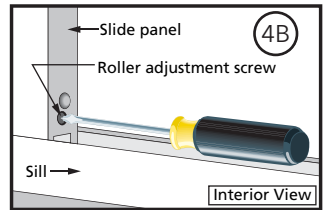

- C. **Install the weep hoods** in the weep slots on the sill. Place the top of the weep hood against the sill then swing the bottom into the latched position.

Note: The screen track ends do not need weep hoods. This is where the screen track weeps.

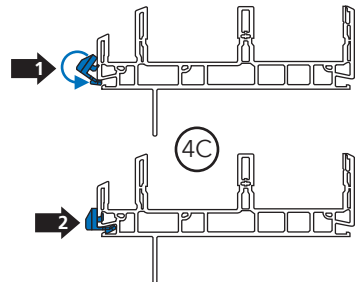

5 INTEGRATING THE DOOR TO THE WATER RESISTIVE BARRIER

A. **Apply the side flashing tape.** Cut two pieces of flashing tape 4" longer than the frame height of the door. Apply one piece to each side over the nailing fin and onto the water resistive barrier. The tape should extend 2" above the top of the door and 2" below the bottom of the door. Press the tape down firmly.

B. **Apply the top flashing tape.** Cut a piece of flashing tape long enough to go across the top of the door and extend at least 1" past the side flashing tape on both sides. Apply the tape over the top nailing fin as shown. Press the tape down firmly.

Note: The tape should cover the entire nailing fin, but not extend onto the door frame. The top flashing tape must overlap the side flashing tape to prevent water from getting behind it.

C. **Fold down the top flap** of the water resistive barrier.

D. **Apply flashing tape to the diagonal cuts.** Cut pieces of flashing tape at least 1" longer than the diagonal cuts in the water resistive barrier. Apply the tape, covering the entire diagonal cut in the water resistive barrier at both upper corners of the door. Press the tape down firmly.

Note: Be sure to overlap the top corners.

E. **Attach the wood blocking** or aluminum sill support to the exterior of the opening to support the edge of the door sill.

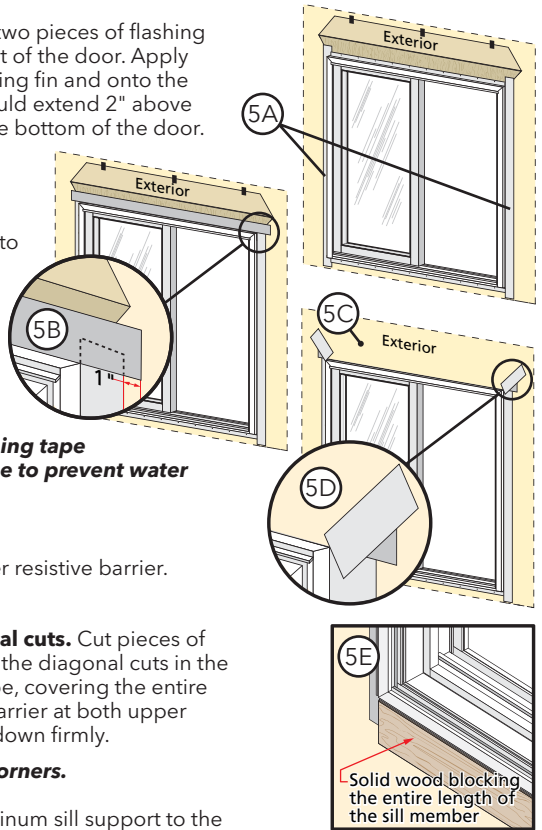

6 INTERIOR SEAL

Caution: Ensure use of low pressure polyurethane window and door insulating foams and strictly follow the foam manufacturer's recommendations for application. Use of high pressure foams or improper application of the foam may cause the door frame to bow and hinder operation.

A. **Apply insulating foam sealant.** From the interior, insert the nozzle of the applicator approximately 1" deep into the space between the door and the rough opening and apply a 1" deep bead of foam. This will allow room for expansion of the foam and will minimize squeeze out. If using foam other than Great Stuff™ Window and Door Insulating Foam Sealant by the Dow Chemical Company, allow the foam to cure completely (usually 8 to 24 hours) before proceeding to the next step.

Note: It may be necessary to squeeze the end of the tube with pliers to be able to insert into the space between the door frame and the rough opening. DO NOT completely fill the space from the back of the fin to the interior face of the door.

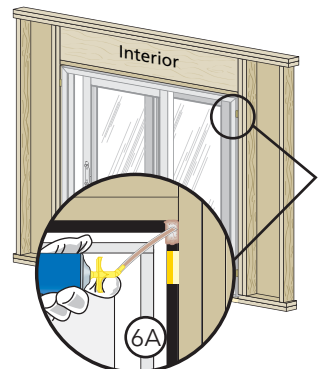

6 INTERIOR SEAL (CONTINUED)

- B. **On the interior, seal the door sill to the floor** with a corner bead of sealant. Connect this bead of sealant to the insulating foam at both door jambs.
- C. **Check the door operation** by opening and closing the door.

Note: If the door does not operate correctly, check to make sure it is still plumb, level, square and the sides are not bowed. If adjustments are required, remove the foam with a serrated knife. Adjust the shims, and reapply the insulating foam sealant.

7 SEALING THE DOOR TO THE EXTERIOR WALL CLADDING

NAIL-FIN FRAME:

Note: When applying siding, brick veneer or other exterior finish materials, leave adequate space between the door frame and the material for sealant. Refer to the illustration that corresponds to your finish material. Not allowing adequate space or not using backer rod may cause the sealant to break down prematurely and allow water to infiltrate.

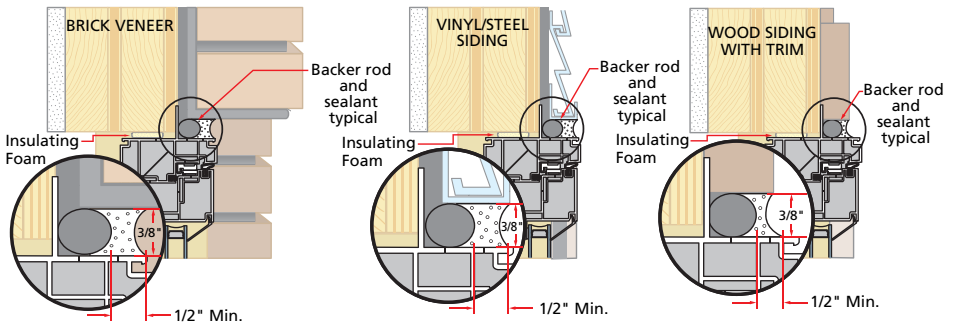

REPLACEMENT FRAME:

Note: When applying siding, brick veneer or other exterior finish materials, leave adequate space between the door frame and the material for sealant. Refer to the illustration that corresponds to your finish material. Not allowing adequate space or not using backer rod may cause the sealant to break down prematurely and allow water to infiltrate.

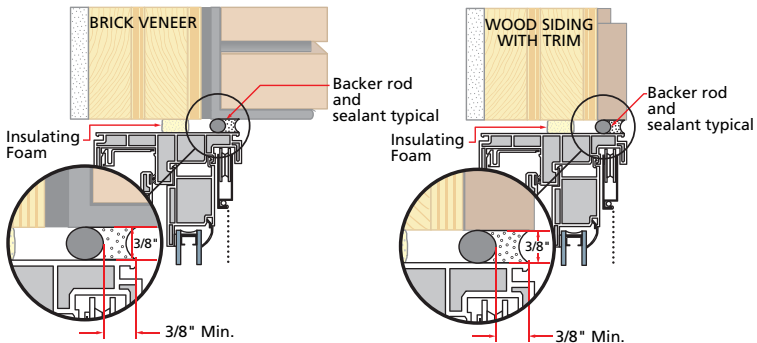

7 SEALING THE DOOR TO THE EXTERIOR WALL CLADDING (CONTINUED)

NAIL-FIN FRAME AND REPLACEMENT FRAME:

- A. **Insert closed cell foam backer rod** into the space around the door approximately 1/2". This should provide at least a 1/2" clearance between the backer rod and the exterior face of the door.

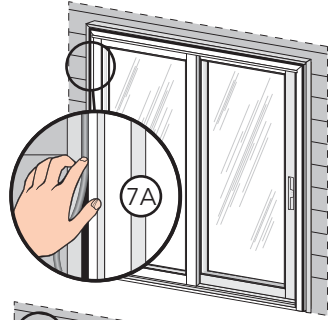

- B. **Apply a bead of high quality exterior grade sealant** to the entire perimeter of the door. On doors where the bottom fin has been removed, insert sealant into the spaces between the bottom of the door and the sill support and connect it to the perimeter sealant.

Note: Refer to the sealant manufacturer's label to verify compatibility with vinyl and the adjoining building components and priming requirements.

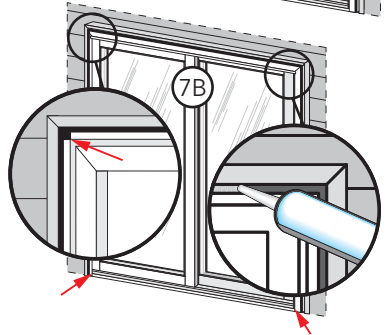

- C. **Shape, tool and clean excess sealant.** When finished, the sealant should be the shape of an hourglass.

Note: This method creates a more flexible sealant line capable of expanding and contracting.

FLUSH FLANGE FRAME:

- D. **Place a corner bead of sealant** on the edge of the door flush flange on top and sides. **DO NOT** seal the sill of the door frame to the opening.

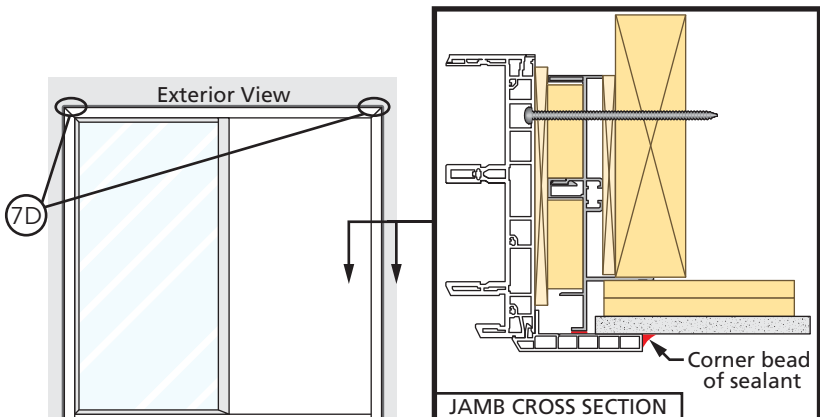

8 FLUSH FLANGE OPENING PREPARATION

Installation Instructions for Replacement of Aluminum Sliding Doors in Hard Coat Stucco Applications.

These instructions are designed for typical California hard coat stucco exterior applications. The installation must leave the existing aluminum sliding door frame and weep system in place. **These instructions are not to be used with any other construction method and rely on the integrity of the existing aluminum sliding door frame and flashing system.** Building designs, construction methods, building materials, and site conditions unique to your project may require an installation method different from these instructions and additional care. Determining the appropriate installation method is the responsibility of you, your architect, or construction professional. If you have questions, please contact your local Pella retailer.

- A. **Prepare the door opening** by removing the venting panel and the glass from the existing fixed side of the aluminum door frame.

Note: It may be necessary to cut the divider between the venting panel and fixed glass areas with a hacksaw. The existing aluminum frame is left in place so as not to disturb the existing exterior stucco flashing or drainage system.

- B. **Cut the existing door sill out of the opening.** Using a hacksaw or side grinder, cut the existing sill as close to the longest leg of the jamb extrusion as possible.

Note: Be careful to avoid damage to the interior flooring materials. Drilling holes in the sill prior to cutting may make the removal of the existing sill easier. If existing sill has a stainless steel cap on the sill, removing the cap prior to cutting will make cutting easier.

- C. **Clean old sealant and other debris** from the door opening.
- D. **Remove the door lock strike** from the lock jamb of the existing door frame.

- E. **Place a bead of sealant at each joint** where the existing door frame jambs meet the existing door sill pieces. Fill any holes in the jamb and head with sealant.

- F. **If the weep holes of the existing sill have been cut away, drill new weep holes** in the existing door jambs. Be sure to drill weep holes in all vertical jamb legs, except the most interior leg.

Note: Ensure that all new or existing weep holes are open before proceeding with the installation.

- G. **Cut wood blocking to fill the vent and fixed panel cavities** in the head and jamb of the existing door frame. The depth of the blocking should be the same height as the tallest leg of the existing jamb extrusion. Cut the head blocking to fill the entire length of the head in both channels. Cut the jamb blocking to fill both jamb channels to within approximately 1" of the bottom of the jamb.

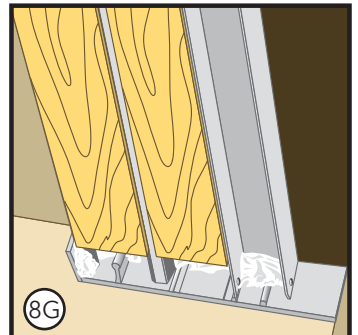
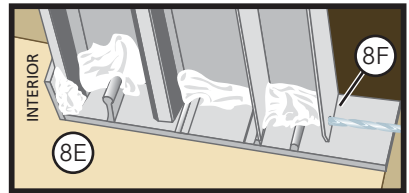
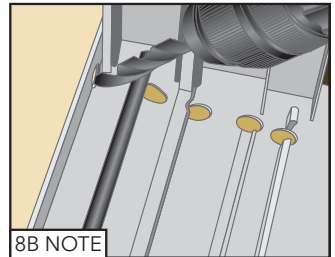
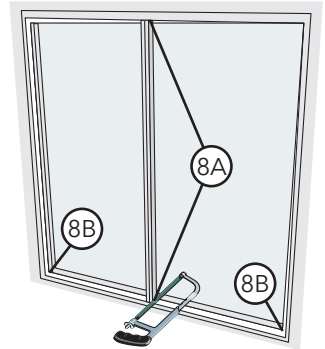

8 FLUSH FLANGE OPENING PREPARTATION (CONTINUED)

- H. **Install the wood blocking in the head existing door frame.** Place a 3/16" bead of sealant in the door panel cavities, then insert the wood blocking into the head cavities. Next insert the wood blocking into the jamb panel cavities of the existing door frame.
- I. **Construct a door sill pan for the door.** Measure the distance between the cut ends of the existing door sill and add 2". Measure 1" from each end and cut through the vertical leg of the pan material. Bend bottom flaps of the pan material up, then bend the back leg around the end of the pan.

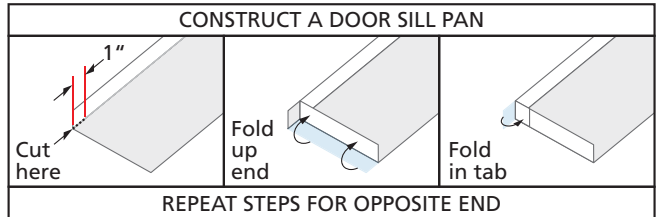

TWO OR MORE PERSONS ARE REQUIRED FOR THE FOLLOWING STEPS.

- J. **Remove the packaging from the door.** Inspect the frame and panels for damage. **DO NOT** install damaged units.

Note: If screens or hardware are removed from the door at this time, label them and store them in a protected area.

- K. **Remove the panel(s).** With the jamb side of the door down, slide each panel all the way to the right or left, while lifting the panel out to the bottom frame pocket, swing the panel out of the frame.

Note: Door may have fixed panel fully installed. If so, remove the vent panel only.

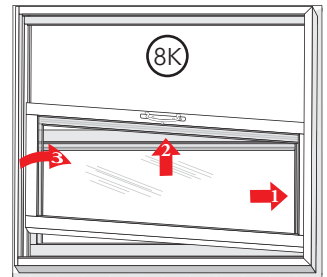

Interior View

- L. **Dry fit the sill pan and the door** into the opening.

Note: If the new door frame is deeper than the existing door frame, it will be necessary to cut the interior flooring material back to allow the door flush flanges to contact the existing aluminum door frame.

- M. **From the exterior, set the door into the opening.** Set the sill of the door on the sill pan and tilt the door into position.

- N. **Insert shims around the door temporarily** while you verify that the door will fit into the opening and that the door flanges will overlap the stucco or existing aluminum door frame by a minimum of 3/4" on all sides.

Note: Fix any problems with the opening before proceeding.

8 FLUSH FLANGE OPENING PREPARTATION (CONTINUED)

O. **Using a pencil, mark the interior and exterior edges of the sill pan** on the sill of the rough opening. Remove the door and sill pan.

P. **Place a 1/4" diameter bead of sealant in the following locations:**

- The exterior side of the interior pencil mark.
- The interior side of the exterior pencil mark.
- Midway between the exterior and interior sealant beads.

Sealant Placement, arrows indicate sealant locations.

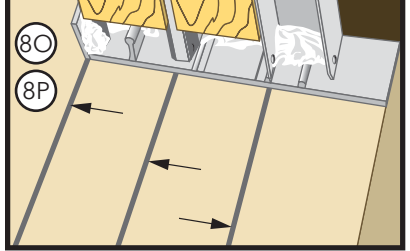

Q. **Place a bead of sealant across the ends of the three sealant beads**, connecting the three beads and sealing the exposed ends of the existing aluminum sill. Also place a bead of sealant on the vertical legs of the existing sill.

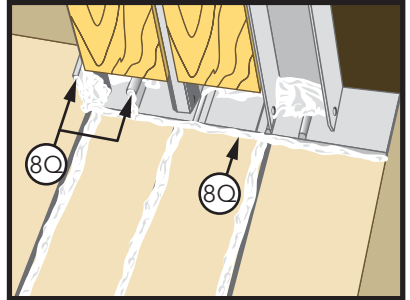

R. **Install the sill pan** into the opening, aligning the interior and exterior edges with the pencil marks from Step O. Press down on the sill pan to seal it into the opening.

S. **Check all visible sealant lines for voids** and fill any voids with sealant.

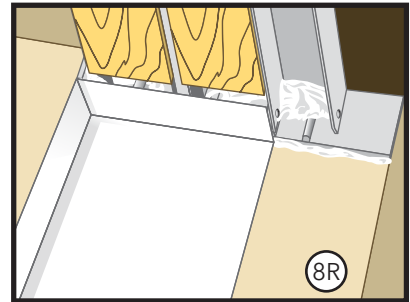

9 SETTING AND FASTENING THE DOOR IN FLUSH FLANGE APPLICATIONS

A. **Place one 1/4" diameter bead of sealant in the following locations:**

- In the bend at the back of the sill pan.
- 1/2" from the exterior edge of the sill pan.
- Midway between the interior and exterior beads of sealant.

Also seal the joint between the back and side legs of the sill pan with sealant.

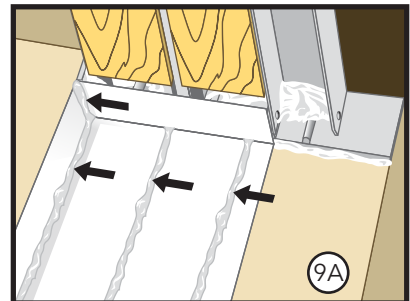

9 SETTING AND FASTENING THE DOOR IN FLUSH FLANGE APPLICATIONS (CONTINUED)

- B. **Place a 1/4" diameter continuous bead of sealant** on the face of the existing door frame jamb and head.
- C. **From the exterior, set the door into the opening.** Set the sill of the door onto the sill pan and tilt the door into position, centering it in the opening. **DO NOT** slide the door on the sill pan.

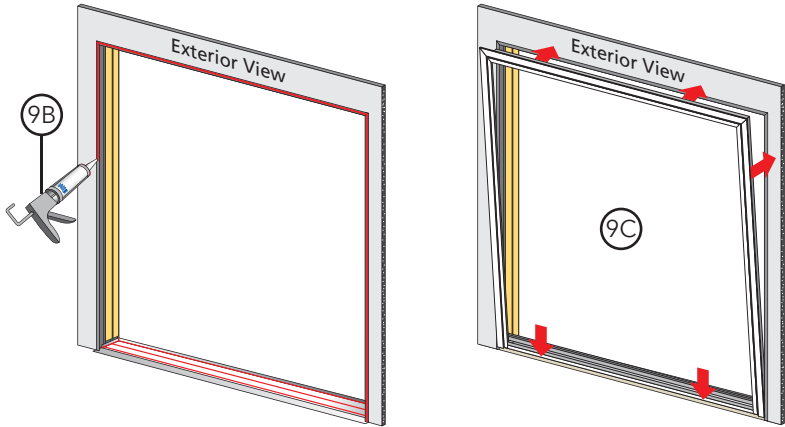

- D. **Insert shims** between the door and the sides of the opening at the top two anchor hole locations in the door.

Note: Keep the exterior of the door pressed against the existing door frame to ensure a good sealant line.

- E. **At the top pre-drilled installation hole of each jamb, drill a 1/8" pilot hole** through the frame shims, wood blocking and aluminum door frame.

1-1/4" minimum screw embedment required

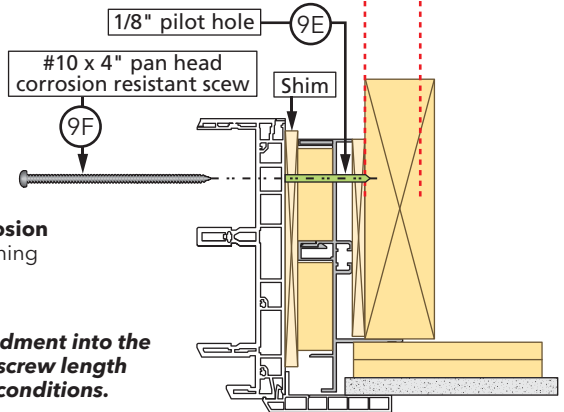

- F. **Drive a #10 x 4" pan head corrosion resistant screw** through the opening at the installation hole locations.

***Note: A minimum of 1-1/4" embedment into the wood blocking is required. Adjust screw length accordingly based on the existing conditions.**

9 SETTING AND FASTENING THE DOOR IN FLUSH FLANGE APPLICATIONS (CONTINUED)

- G. **Plumb and square the door.** Insert shims between the new door frame and the existing door frame at the pre-drilled anchor hole locations in the door jambs. **DO NOT SHIM THE HEAD UNTIL ALL FIXED PANELS ARE INSTALLED.** Move the door in the opening until the flanges are tight against the existing aluminum door frame.

Note: DO NOT over shim.

- H. **Drill a 1/8" pilot hole** through the door frame, shims, blocking and aluminum frame at each pre-drilled installation screw hole location.
- I. **Drive a #10 pan head corrosion resistant screw into the rough opening** at the installation hole locations. **DO NOT INSTALL FASTENERS IN HEAD UNTIL ALL FIXED PANELS HAVE BEEN INSTALLED.**

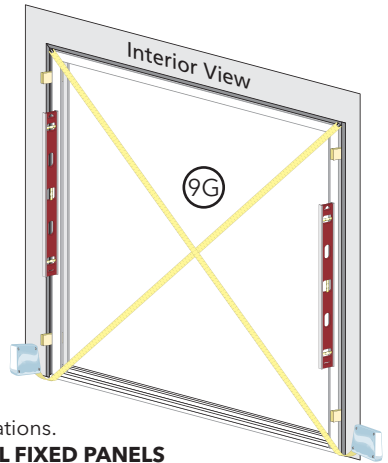

Go to Step 4

10 OPTIONAL SILL PAN FABRICATION AND INSTALLATION

Construct a door sill pan for the door. Measure the distance between the cut ends of the existing door sill and add 2". Measure 1" from each end and cut through the vertical leg of the pan material. Bend bottom flaps of the pan material up, then bend the back leg around the end of the pan.

Dry fit the sill pan and the door into the opening.

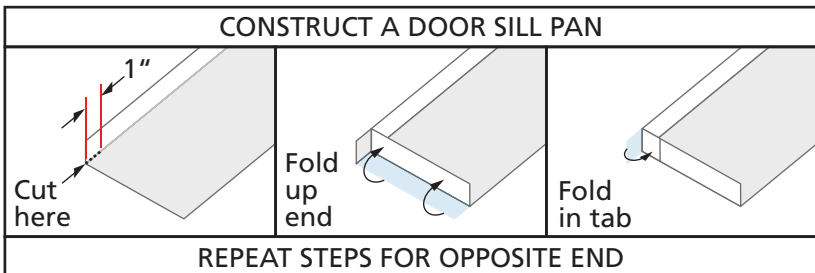

From the exterior, set the door into the opening.

Set the sill of the door on the sill panel and tilt the door into position.

Using a pencil, mark the interior and exterior edges of the sill pan on the sill of the rough opening. Remove the door and sill pan.

Place a 1/4" diameter bead of sealant in the following locations:

- The exterior side of the interior pencil mark.
- The interior side of the exterior pencil mark.
- Midway between the exterior and interior sealant beads.

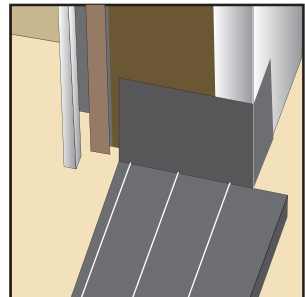

10 OPTIONAL SILL PAN FABRICATION AND INSTALLATION (CONTINUED)

Install the sill pan into the opening, aligning the interior and exterior edges with the pencil marks from previous illustration. Press down on the sill pan to seal it into the opening.

Place one 1/4" diameter bead of sealant in the following locations:

- In the bend at the back of the sill pan.
- 1/2" from the exterior edge of the sill pan.
- Midway between the interior and exterior beads of sealant.
- Leave a 2" sealant gap at each end of the two exterior lines of sealant for drainage.

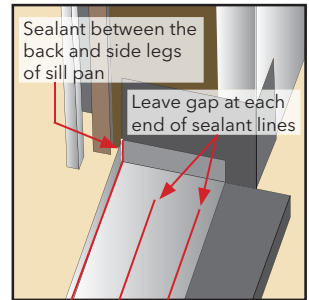

Also seal the joint between the back and side legs of the sill pan with sealant.

Return to Step 2

CLEANING INSTRUCTIONS

Remove labels and clean the glass, using a soft, clean, grit-free cloth and mild soap or detergent. Be sure to remove all liquid by wiping dry or use a clean squeegee. The vinyl frame may be cleaned as described above. For stubborn dirt, a "non-abrasive" cleaner such as Bon-Ami® or Soft Scrub® may be used. **DO NOT** use solvents such as mineral spirits, toluene, xylene, naphtha or muriatic acid as they can dull the finish, soften the vinyl and/or cause failure of the insulated unit seal. Keep door tracks clear of dirt and debris. Keep weep holes open and clear of obstructions.

IMPORTANT NOTICE

Because all construction must anticipate some water infiltration, it is important that the wall system be designed and constructed to properly manage moisture. Pella Corporation is not responsible for claims or damages caused by anticipated and unanticipated water infiltration; deficiencies in building design, construction and maintenance; failure to install Pella® products in accordance with Pella installation instructions; or the use of Pella products in wall systems which do not allow for proper management of moisture within the wall systems. The determination of the suitability of all building components, including the use of Pella products, as well as the design and installation of flashing and sealing systems are the responsibility of the Buyer or User, the architect, contractor, installer, or other construction professional and are not the responsibility of Pella.

Pella products should not be used in barrier wall systems which do not allow for proper management of moisture within the wall systems, such as barrier Exterior Insulation and Finish Systems, (EIFS) (also known as synthetic stucco) or other non-water managed systems. Except in the states of California, New Mexico, Arizona, Nevada, Utah, and Colorado, **Pella makes no warranty of any kind and assumes no responsibility for Pella windows and doors installed in barrier wall systems. In the states listed above, the installation of Pella products in barrier wall or similar systems must be in accordance with Pella installation instructions.**

Product modifications that are not approved by Pella Corporation will void the Limited Warranty.



V983492

Free Manuals Download Website

<http://myh66.com>

<http://usermanuals.us>

<http://www.somanuals.com>

<http://www.4manuals.cc>

<http://www.manual-lib.com>

<http://www.404manual.com>

<http://www.luxmanual.com>

<http://aubethermostatmanual.com>

Golf course search by state

<http://golfingnear.com>

Email search by domain

<http://emailbydomain.com>

Auto manuals search

<http://auto.somanuals.com>

TV manuals search

<http://tv.somanuals.com>