



# INSTALLATION INSTRUCTIONS

## SLIDING, SINGLE-HUNG and FIXED WINDOW WITH FINIS

### Installation Instructions for Typical Wood Frame Construction.

These instructions were developed and tested for use with typical wood frame wall construction in a wall system designed to manage water. **These instructions are not to be used with any other construction method.** Installation instructions for use with other construction methods or multiple units may be obtained from Pella Corporation or a local Pella retailer. Building designs, construction methods, building materials, and site conditions unique to your project may require an installation method different from these instructions and additional care. Determining the appropriate installation method is the responsibility of you, your architect, or construction professional.

#### YOU WILL NEED TO SUPPLY:

- Cedar or Impervious shims/spacers (12 to 20)
- 2" galvanized roofing nails (1/4 lb.)
- Closed cell foam backer rod/sealant backer (12 to 30 ft.)
- Pella® SmartFlash™ foil backed butyl window and door flashing tape or equivalent
- Pella Window and Door Installation Sealant or equivalent high quality, multi-purpose sealant (1 tube per window)
- Low expansion, low pressure polyurethane insulating window and door foam sealant - DO NOT use high pressure or latex foams

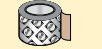

#### TOOLS REQUIRED:

- Tape measure
- Level
- Square
- Hammer
- Stapler
- Sealant gun
- Scissors or utility knife
- Small flat blade screwdriver
- Rubber mallet

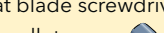
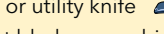
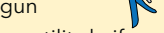
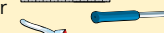
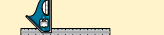

**Installation will require two or more persons for safety reasons.**

### REMEMBER TO USE APPROPRIATE PERSONAL PROTECTIVE EQUIPMENT

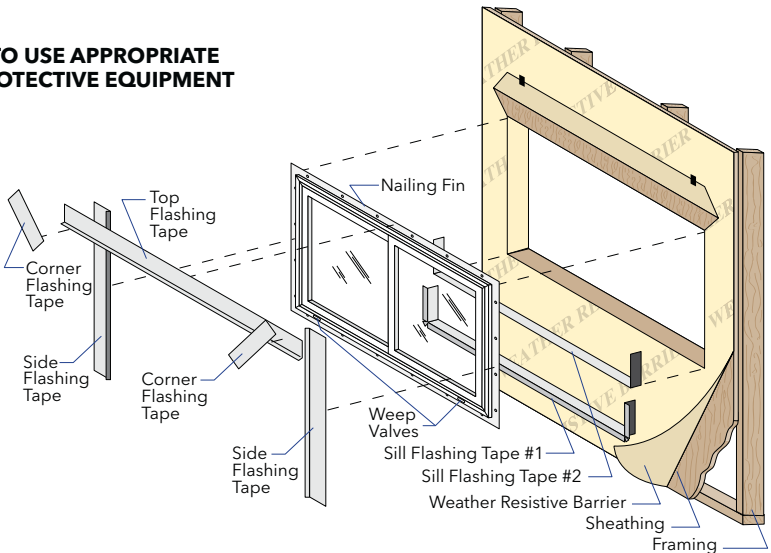

Always read the Pella Impervia Limited Warranty before purchasing or installing Pella Impervia products. By installing this product, you are acknowledging that this Limited Warranty is part of the terms of the sale. Failure to comply with all Pella Impervia installation and maintenance instructions may void your Pella Impervia product warranty. See Limited Warranty for complete details on <http://warranty.pellaimpervia.com>.

Download from [www.Somanuals.com](http://www.Somanuals.com). All Manuals Search And Download.

# 1 ROUGH OPENING PREPARATION

- A. **Confirm the opening is plumb and level.**

**Note: It is critical the bottom is level.**

- B. **Confirm the window will fit the opening.** Measure all four sides of the opening to make sure it is 1/2" larger than the window in both width and height. On larger openings measure the width and height in several places to ensure the header or studs are not bowed.

**Note: 1-1/2" or more of solid wood blocking is required around the perimeter of the opening. Fix any problems with the rough opening before proceeding.**

- C. **Cut the water resistive barrier.**

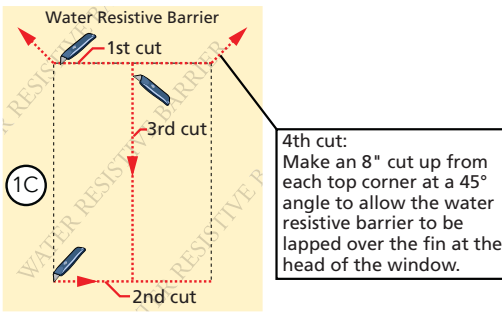

- D. **Fold the water resistive barrier.** Fold side flaps into the opening and staple to the inside wall. Fold the top flap up and temporarily fasten with flashing tape.

- E. **Apply sill flashing tape #1.** Cut a piece of flashing 12" longer than the opening width. Apply at the bottom of the opening as shown so it overhangs 1" to the exterior.

**Note: The tape is cut 12" longer than the width of the opening so it will extend up each side approximately 6".**

- F. **Tab the sill flashing tape and fold.** Cut 1" wide tabs at each corner (1/2" from each side of corner). Fold tape to the exterior and press firmly to adhere it to the water resistive barrier.

- G. **Apply sill flashing tape #2.** Cut a piece of flashing tape 12" longer than the opening width. Apply at the bottom, overlapping tape #1 by at least 1". DO NOT allow the tape to extend past the interior face of the frame.

**Note: The flashing tape does not need to extend all the way to the interior of the framing.**

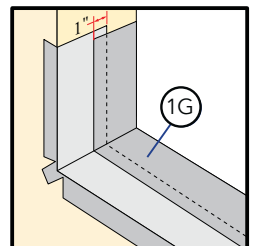
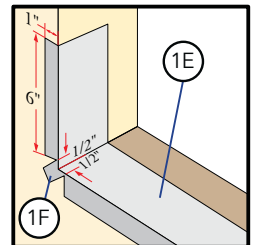
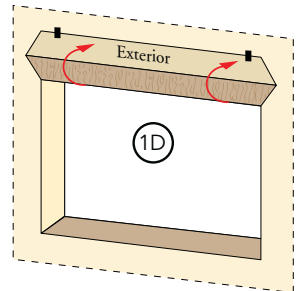
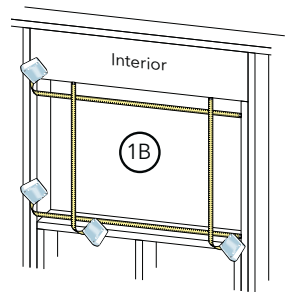
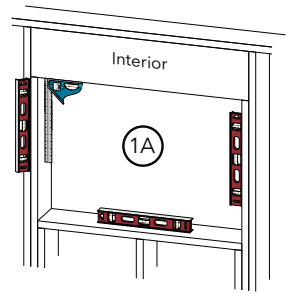

# 2 SETTING AND FASTENING THE WINDOW

- A. **Install and level shims.** Place 1" wide by 1/4" thick shims on the bottom of the opening, 1/4" from each side, beneath transition bars and mullion joints. Keep shims back 1/2" from interior face of window. Adjust shims as necessary to ensure the sill is level. Once level, attach shims to prevent movement.

**Note: Improper placement of shims may result in bowing the bottom of the window.**

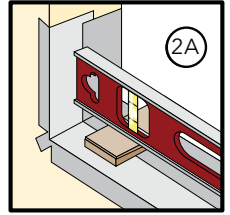

- B. **Remove plastic wrap and cardboard packaging** from window. DO NOT open the window until it is fully fastened.

**Note: For best results, install the window with the sash closed and locked with the shipping spacers in place.**

**TWO OR MORE PEOPLE WILL BE REQUIRED FOR THE FOLLOWING STEPS.**

**Note: If fins are to be installed to no fin units, go to the Applying Installation Fin instructions on the back before proceeding to step C.**

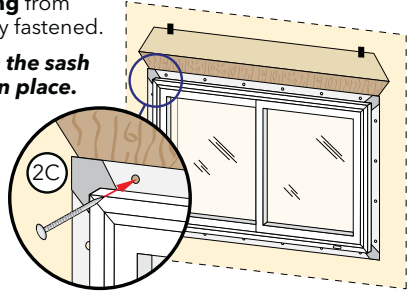

- C. **Insert the window** from the exterior of the building. Place the bottom of the window on the spacers at the bottom of the opening, then tilt the top into position. Center the window between the sides of the opening to allow clearance for shimming and insert one roofing nail in the first hole from the corner on each end of the top nailing fin. These are used to hold the window in place while shimming it plumb and square.

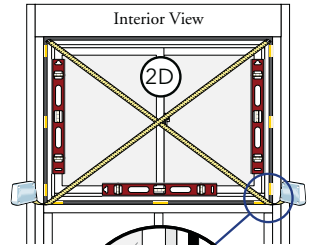

- D. **Plumb and square window.** Place shims 1" from the bottom and top of the window between the window and the sides of the opening. Keep shims back 1/2" from interior face of window. Adjust the shims as required to plumb and square the window in the opening. If the frame height exceeds 53", place shims at the quarter points of the window sides.

**Note: DO NOT shim above the window or in the space between the spacers at the bottom of the window. DO NOT over shim.**

- E. **Check the interior reveal.** Make sure the measurement from the interior face of the window to the interior face of the wall is equal at several points around the window.

- F. **Fasten the window to opening** by driving 2" galvanized roofing nails into each prepunched hole in the nailing fin.



- G. **Check the window operation.** Remove the plastic spacers located between the bottom of the vent panel and the frame sill. Open and close the window a few times to check for proper operation. Close and lock the window.

**Note: If there are any problems with the operations of the window, recheck shim locations and adjust for plumb and square.**

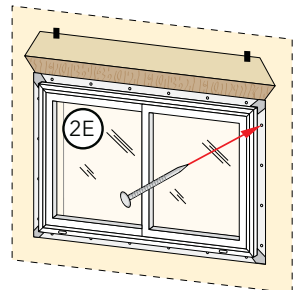

# 3 INTEGRATING THE WINDOW TO THE WATER RESISTIVE BARRIER

A. **Apply side flashing tape.** Cut two pieces of flashing tape 4" longer than the frame height of the window. Apply one piece to each side 1/2" onto the frame, over the nailing fin and onto the water resistive barrier. The tape should extend 2" above the top of the window and 2" below the bottom of the window. Press the tape down firmly while folding down the excess tape at the top and bottom of the window.

B. **Apply top flashing tape.** Cut a piece of flashing tape long enough to go across the top of the window and extend at least 1" past the side flashing tape on both sides. Apply the tape 1/2" onto the frame, over the top nailing fin as shown. Fold the overlapping tape down, and press all tape down firmly.

**Note: DO NOT tape or seal the bottom nailing fin.**

C. **Fold down top flap** of the water resistive barrier.

D. **Apply flashing tape to diagonal cuts.** Cut pieces of flashing tape at least 1" longer than the diagonal cuts in the water resistive barrier. Apply the tape covering the entire diagonal cut in the water resistive barrier at both upper corners of the window.

**Note: Be sure to overlap the top corners.**

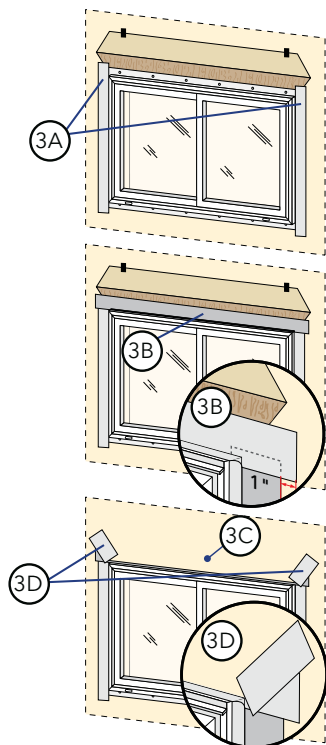

# 4 INTERIOR SEAL

**Caution: Ensure use of low pressure polyurethane window and door insulating foams and strictly follow the foam manufacturer's recommendations for application. Use of high pressure foams or improper application of the foam may cause the window frame to bow and hinder operation.**

A. **Apply insulating foam sealant.** From the interior, insert the nozzle of the applicator approximately 1" deep into the space between the window and the rough opening and apply a 1" deep bead of foam. This will allow room for expansion of the foam and will minimize squeeze out. Apply sealant across interior surface of shims to create a continuous seal. For windows with jamb extensions installed, ensure the foam is placed between the window frame and the rough opening, not between the jamb extension and the rough opening. Follow foam manufacturer's instructions.

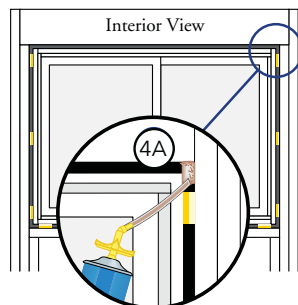

**Note: It may be necessary to squeeze the end of the tube with pliers to be able to insert into the space between the window frame and the rough opening. DO NOT completely fill the space from the back of the fin to the interior face of the opening.**

B. **Check window operation** (vent units only) by opening and closing the window.

**Note: If the window does not operate correctly, check to make sure it is still plumb, level, square and that the sides are not bowed. If adjustments are required, remove the foam with a serrated knife. Adjust the shims, and reapply the insulating foam sealant.**

# 5 SEALING THE WINDOW TO THE EXTERIOR WALL CLADDING

When applying siding, brick veneer or other exterior finish material, leave adequate space between the window frame and the material for sealant. Refer to the illustration corresponding to your finish material.

Note: The sealant details shown are standard recommendations from the sealant industry. Contact your sealant supplier for recommendations and instructions for these and any other applications.

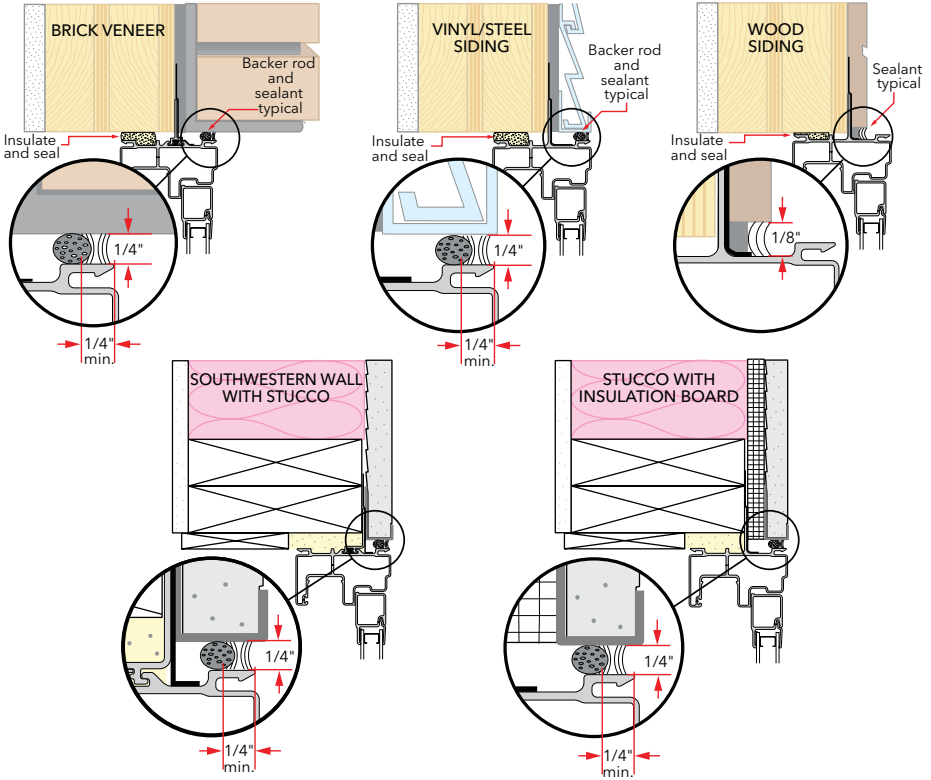

- A. **Insert closed cell foam backer rod** into the space around the window as deep as it will go. This should provide at least a 1/4" clearance between the backer rod and the exterior face of the window.

**Note: Backer rod adds shape and depth for the sealant line.**

- B. **Apply a bead of high quality exterior grade sealant** to the entire perimeter of the window.
- C. **Shape, tool and clean excess sealant.** When finished, the sealant should be the shape of an hourglass.

**Note: This method creates a more flexible sealant line capable of expanding and contracting.**

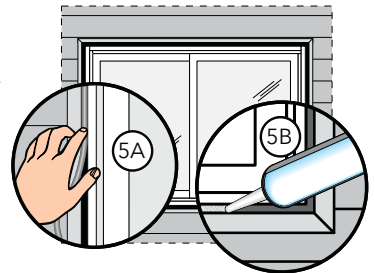

## APPLYING INSTALLATION FINS

- A. Slide the precut bottom fin into the frame sill groove located on the bottom window frame member.
- B. Install the 2 precut side fins into the top of the frame jamb grooves located on the side frame members of the window. Slide the fins into place.

**Note: The side fins must overlap the exterior of the bottom fin.**

- C. Install and slide the precut top fin into the frame head groove located in the top frame member.

**Note: The top fin must overlap the exterior of the side fins.**

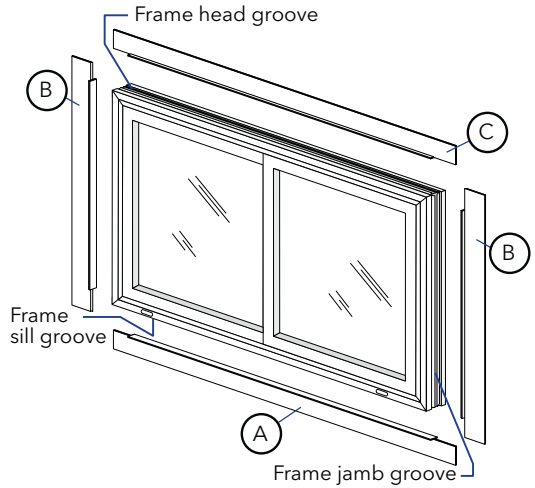

- D. Seal the over-lapping fin joints with sealant.

**TO INSTALL THE WINDOW(S) PROCEED TO STEP 2C.**

## FINISH

The interior and exterior frame and sash are protected by a powder coat baked-on factory finish that requires no painting. Clean this surface with mild soap and water. Stubborn stains and deposits may be removed with mineral spirits. DO NOT use abrasives. DO NOT scrape or use tools that might damage the surface.

Use of inappropriate solvents, brickwash or cleaning chemicals will cause adverse reactions with window and door materials and voids the Limited Warranty.

## CARE AND MAINTENANCE

Care and maintenance information is available by contacting your local Pella retailer. This information is also available at [www.pellaimpervia.com](http://www.pellaimpervia.com).

## IMPORTANT NOTICE

Because all construction must anticipate some water infiltration, it is important that the wall system be designed and constructed to properly manage moisture. Pella Corporation is not responsible for claims or damages caused by anticipated and unanticipated water infiltration; deficiencies in building design, construction and maintenance; failure to install Pella® products in accordance with Pella installation instructions; or the use of Pella products in wall systems which do not allow for proper management of moisture within the wall systems. The determination of the suitability of all building components, including the use of Pella products, as well as the design and installation of flashing and sealing systems are the responsibility of the Buyer or User, the architect, contractor, installer, or other construction professional and are not the responsibility of Pella.

Pella products should not be used in barrier wall systems which do not allow for proper management of moisture within the wall systems, such as barrier Exterior Insulation and Finish Systems, (EIFS) (also known as synthetic stucco) or other non-water managed systems. Except in the states of California, New Mexico, Arizona, Nevada, Utah, and Colorado, **Pella makes no warranty of any kind and assumes no responsibility for Pella windows and doors installed in barrier wall systems. In the states listed above, the installation of Pella products in barrier wall or similar systems must be in accordance with Pella installation instructions.**

Product modifications that are not approved by Pella Corporation will void the Limited Warranty.

## Free Manuals Download Website

<http://myh66.com>

<http://usermanuals.us>

<http://www.somanuals.com>

<http://www.4manuals.cc>

<http://www.manual-lib.com>

<http://www.404manual.com>

<http://www.luxmanual.com>

<http://aubethermostatmanual.com>

Golf course search by state

<http://golfingnear.com>

Email search by domain

<http://emailbydomain.com>

Auto manuals search

<http://auto.somanuals.com>

TV manuals search

<http://tv.somanuals.com>