



## INSTALLATION INSTRUCTION -

**NAIL FIN INSTALLATION BEFORE WEATHER BARRIER AND  
FRAME SCREW OR CLIP INSTALLATION FOR REPLACEMENT**

ALUMINUM-CLAD EXTERIOR HINGED PATIO DOORS (PELLA® PROLINE AND DESIGNER SERIES\*)

ALUMINUM-CLAD EXTERIOR ENTRY DOORS (PELLA® AND ARCHITECT SERIES\*)

*Please read thoroughly and understand completely all the steps in this instruction prior to beginning installation.*

|  |                                      |
|--|--------------------------------------|
| <i>Installation with Nail Fin</i>                | <i>follow steps 1, 2, 3, 4, 6, 7</i> |
| <i>Replacement Installation Without Nail Fin</i> | <i>follow steps 1, 2, 3, 5, 6, 7</i> |

**Instrucciones en español en el reverso.**

These instructions were developed and tested for use with typical wood frame wall construction in a wall system designed to manage water. **These instructions are not to be used with any other construction method.** Installation instructions for use with other construction methods or multiple units may be obtained from Pella Corporation, a local Pella retailer or by visiting <http://www.pella.com>. Building designs, construction methods, building materials, and site conditions unique to your project may require an installation method different from these instructions and additional care. Determining the appropriate installation method is the responsibility of you, your architect or construction professional. Check with the individual (building owner, architect, contractor, installer and/or consumer) responsible for the project in addition to local building code officials to determine if these products comply with local codes.

**REMEMBER TO USE APPROPRIATE PERSONAL PROTECTIVE EQUIPMENT.**

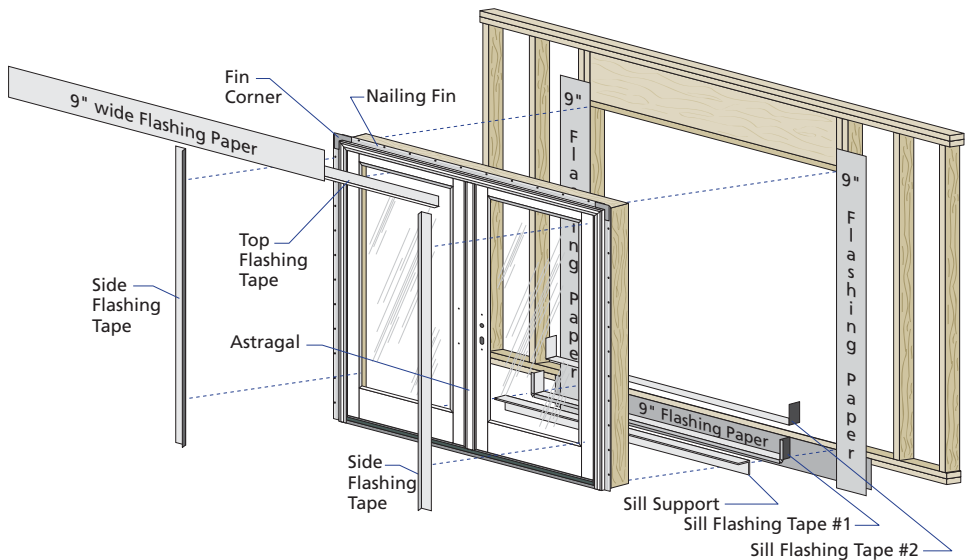

**Note:** This instruction is intended for walls with or without sheathing. Illustrations show wall without sheathing.



Always read the Pella® Limited Warranty before purchasing or installing Pella products. By installing this product, you are acknowledging that this Limited Warranty is part of the terms of the sale. Failure to comply with all Pella installation and maintenance instructions may void your Pella product warranty. See Limited Warranty for complete details at <http://warranty.pella.com>.







Download from [www.Somanuals.com](http://www.Somanuals.com). All Manuals Search And Download.

The performance of any building is dependent upon the design, installation, and workmanship of the entire building system. Pella Corporation strongly recommends consulting an experienced architect, contractor or structural engineer prior to installation of Pella products.

The individual (building owner, architect, contractor, installer and/or consumer) responsible for the project must take into account local conditions, building codes, inherent component limitations, the effects of aging and weathering on building components, and other design issues relevant to each project.

The determination of the suitability of all building components for each project, as well as the design and installation of flashing and sealing systems, are the responsibility of the building owner, architect, contractor, installer and/or consumer.













### YOU WILL NEED TO SUPPLY:

- Composite or Impervious shims/spacers (12 to 20)
- 2" galvanized roofing nails (1/4 lb.) 
- #10 x 3-1/2" corrosion resistant wood screws (Performance Upgrade & HurricaneShield) 
- Masonry screws for concrete applications (Minimum of 3/16" diameter x 3") 
- Closed cell foam backer rod/sealant backer (21 to 30 ft.) 
- Pella® SmartFlash™ foil backed butyl window and door flashing tape or equivalent 
- High quality exterior grade polyurethane or silicone sealant (2 to 3 tubes per door) 
- Great Stuff™ Window and Door Insulating Foam Sealant by the Dow Chemical Company or equivalent low pressure polyurethane window and door foam - DO NOT use high pressure or latex foams 
- Sill pan (optional)
- Pella aluminum sill support or wood blocking
- Interior trim and/or jamb extensions (15 to 40 ft.)

### Installation Clip Option:

- 6" or 8" installation clips 
- #6 x 5/8" corrosion resistant flat head wood screws
- #8 x 1-1/2" corrosion resistant screws or 3/16" x 1-1/2" masonry screws

### TOOLS REQUIRED:

- Tape measure 
- Level 
- Square 
- Hammer 
- Stapler 
- Sealant Gun 
- Scissors or utility knife 
- Tin Snips 
- Screwdrivers (#2 Phillips with 8" shaft and small flat blade) 
- T20 Torx Wrench (Architect Series®) 
- 1/8" Allen wrench (Designer Series®) 
- Drill 
- Drill Bits 13/64" and 1/8" and masonry bit for concrete applications 

# 1 ROUGH OPENING PREPARATION:

A. Confirm the opening is plumb and level.

**Note: It is critical the bottom is level.**

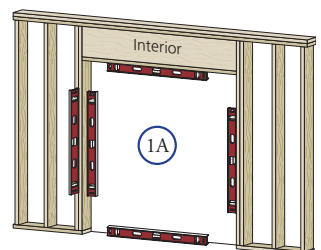

# 1 ROUGH OPENING PREPARATION (continued):

- B. **Confirm the door will fit the opening.** Measure all four sides of the opening to make sure it is  $\frac{3}{4}$ " larger than the door in width and  $\frac{1}{2}$ " larger in height. Measure the width at the top, bottom, and center. Measure the height at the far left side, the far right side, and in the center.

**Note:** *1-1/2" or more of solid wood blocking is required around the perimeter of the opening. Fix any problems with the rough opening before proceeding.*

**For Replacement Installation where nail fin is NOT being used, go to Step 5.**

- C. **Apply flashing paper at the bottom (1C).** Cut one piece of flashing paper 18" longer than the width of the rough opening. Position the top edge of the flashing paper with the top of the sill plate. Center the flashing paper with the opening width. Staple the flashing paper to the sill plate.

**Note:** *Sill flashing paper is not required for installation on concrete floors.*

- D. **Apply flashing paper to the sides of the rough opening (1D).** Cut two pieces of flashing paper 18" longer than the height of the rough opening. Apply one piece to each jamb. Position the edge of the flashing paper with the inside edge of the trimmer (jack stud), and center the flashing paper with the height of the rough opening. Staple the flashing paper to the trimmer.

**FOR DOORS USING OPTIONAL SILL PAN GO TO STEP 11.**

- E. **Apply sill flashing tape #1.** Cut a piece of flashing tape 12" longer than the opening width. Apply at the bottom of the opening as shown (1E) so it overhangs 1" to the exterior.

**Note:** *The tape is cut 12" longer than the width so that it will extend 6" up each side of the opening.*

- F. **Tab the sill flashing tape and fold.** Cut 1" wide tabs at each corner ( $\frac{1}{2}$ " from each side of the corner) (1F). Fold tape to the exterior and press firmly to adhere it to the water resistant barrier.

- G. **Apply sill flashing tape #2.** Cut a piece of flashing tape 12" longer than the opening width. Apply at the bottom, overlapping tape #1 by at least 1". DO NOT allow the tape to extend past the interior face of the framing (1G).

**In-swing doors:**

If the wall depth is greater than 5", add a third piece of flashing tape. The flashing tape should come to within 1" of the interior face of the framing.

**Note:** *The flashing tape may not fully cover the framing members.*

- H. **Attach the aluminum sill support** or wood blocking to the exterior of the box plate to support the edge of the door sill. Place the sill support flush with the subfloor.

**GO TO STEP 2**

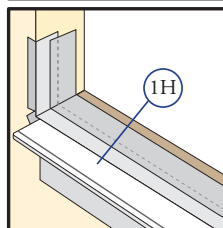
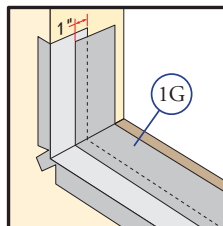
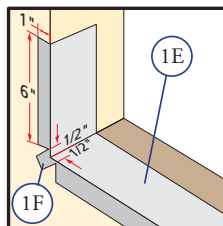
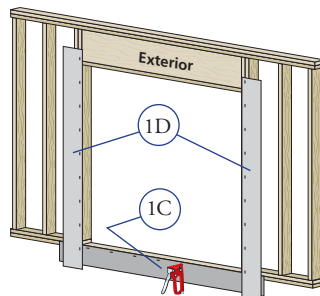
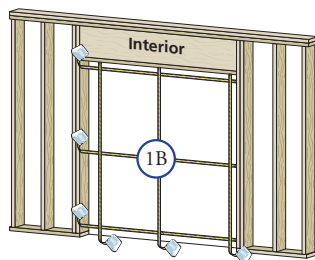

# 1 ROUGH OPENING PREPARATION (continued):

## Optional Sill Pan Instructions:

- I. Cut the sill pan to the width of the rough opening plus 2".

*Note: The 2" added onto the rough opening width is for a 1" bend on each end.*

- J. Make a 1" cut in each fold at both end of the sill pan.

*Note: These cuts will allow the edges of the sill pan to be bent.*

*Note: 4-5/8" wide for Out-Swing and In-Swing for 4-9/16" wall condition. For other wall conditions, measure wall depth and add 1/16".*

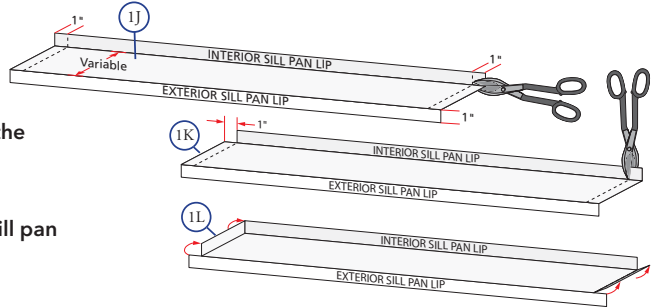

- K. Cut 1" off each end of the interior sill pan lip.

- L. Bend each end of the sill pan upwards.

- M. Install the sill pan by sliding into place until the exterior sill pan lip is flush with the exterior of the rough opening.

- N. Apply sill flashing tape. Cut a piece of flashing tape 2" longer than the opening width. Apply at the bottom of the opening, covering the exterior sill pan lip as shown.

*Note: If applicable, apply spray adhesive to building felt prior to applying the flashing tape.*

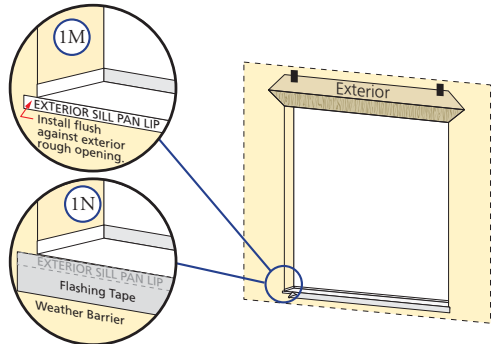

- O. Cut two 9" pieces of flashing tape with a 1-1/2" x 3" tab at the bottom, on opposite corners as shown.

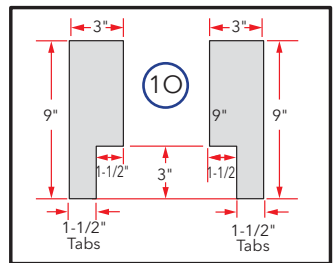

- P. Apply the tabbed 9" pieces of flashing tape. The tape is applied so 1-1/2" will cover the inside of the rough opening and lap over the side flange of the sill pan. The 1-1/2" x 3" tab laps over the bottom flashing tape as shown.

- Q. Cut two 6" pieces of flashing tape and apply to each side of the rough opening, overlapping the first piece by 1" and lapping the bottom over the side flange of the sill pan as shown.

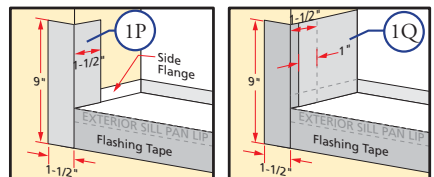

# 1 ROUGH OPENING PREPARATION (continued):

- R. **Cut a piece of flashing tape** to the width of the opening. Install to the flanges of the sill pan and overlap the tape from step 1N by 1". If needed add a second or third piece of flashing tape until the sill pan is covered to the interior sill pan lip.

**Note:** *The purpose of this tape is to seal the sill screws when installing the door.*

- S. **Cut two pieces of flashing tape 1-1/2" x 6"** and apply to the bottom corners of the opening by beginning in the corner of the sill pan, with 3/4" of the tape applied to the sill pan and 3/4" of the tape applied to the side flange. The remainder of the tape is to be at a 45 degree angle onto the exterior.

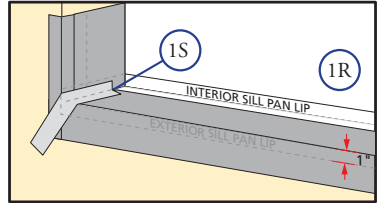

- T. **Attach the aluminum sill support or wood blocking** to the exterior of the box plate to support the edge of the door sill. Place the sill support flush with the subfloor.

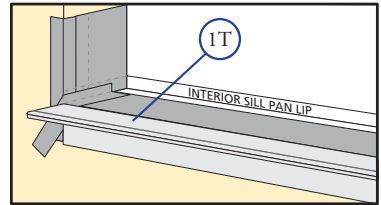

# 2 PREPARE THE DOOR FOR INSTALLATION:

**TWO OR MORE PEOPLE WILL BE REQUIRED TO HANDLE THE PANEL AND FRAME SAFELY.**

- A. **Remove plastic wrap and cardboard packaging from door.** Do not remove plastic shipping spacers. The shipping spacers will help keep the door square during installation. Do not open the door until it is fully fastened.

**Note:** *If grilles or hardware are removed from the door at this time, label them and store them in a protected area.*

- B. **For doors without EnduraClad® Brickmould:** Fold out installation fin to 90°. Be careful not to remove or tear the fin corners.

**Note:** *If the fin corner is not at 90°, the door will not align correctly on the interior.*

**Note:** *The nail fin on doors with brickmould and nail fin will come from the factory folded up.*

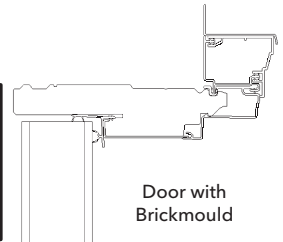
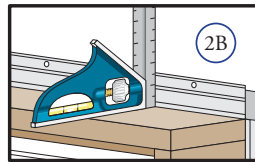

Door with Brickmould

- C. **Doors using Installation Clips:** Install installation clips. Place each clip so the lip is facing up and against the installation fin at the locations shown in the placement diagram. Secure each clip by driving a #6 x 5/8" corrosion resistant screw through each of the outer two holes of the three holes shown.

**Note:** *If clips are to be bent; pre-bend before attaching to frame.*

**Note:** *Bending clips after attaching to frame will bow the frame.*

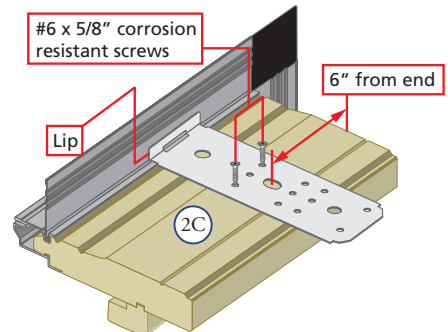

# 3 SETTING AND FASTENING THE DOOR:

- A. **Place three 3/8" beads of sealant.** Place the first beads sealant 1/2" in front of the base of the interior sill pan lip. This bead should also continue up the corner of the sill pan at each end, sealing the vertical joints of the sill pan legs. Continue the first bead up 6" onto each jamb side of the rough opening. The second bead should be approximately 1/2" from the exterior edge of the rough opening, running from jamb to jamb with a 2" break in the middle of the opening. Place a third sealant bead in the groove of the sill support from end to end or 1/4" from the exterior edge of the wood blocking.

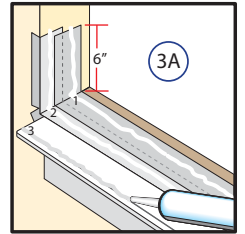
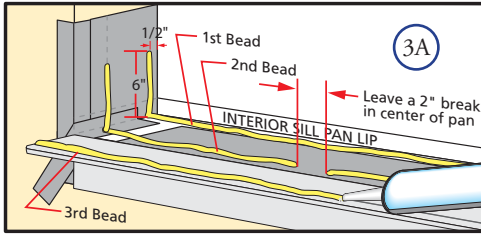

Applications without sill pan

**TWO OR MORE PEOPLE WILL BE REQUIRED FOR THE FOLLOWING STEPS:**

## Designer Series Doors:

- B. **Cut and remove the strap** that runs from the door lock to the sill of the door.

## For doors with no lock/bore:

- C. **Remove the screws and blocking** from the head and sill.

**Caution:** *The door panels will swing freely.*

- D. **Insert the door from the exterior of the building.** DO NOT slide the bottom of the door into the opening. Sliding will damage the sealant lines. Place the bottom of the door at the bottom of the opening, then tilt the top into position. Center the door between the sides of the opening to allow clearance for shimming, and insert one roofing nail in the first hole from the corner on each end of the top nailing fin. These are used to hold the door in place while shimming it plumb and square.

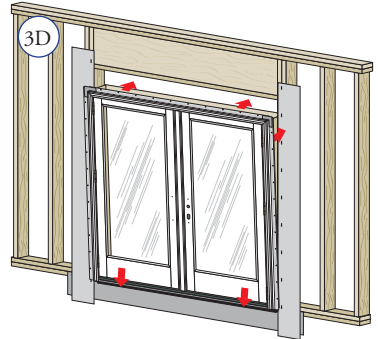

- E. **Plumb and square door.** Place shims at each hinge and lock strike location between the door and the sides of the opening. Keep shims back 1/2" from the interior face of the door frame. Insert shims in other locations as needed starting up 6" from the bottom of the door to square it in the opening. Check for frame twist; confirm consistent weatherstrip compression around the perimeter of the door. Make sure the panels are even across the bottom.

**Note:** *On center latch double doors the lock strike will not be shimmed since it is located in the center of the unit. DO NOT over shim.*

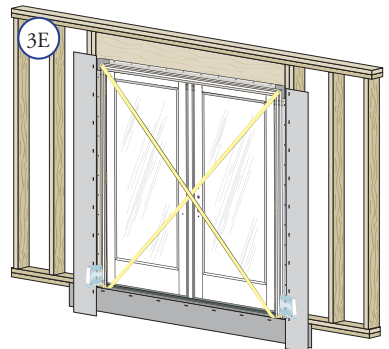

# 3 SETTING AND FASTENING THE DOOR (continued):

- F. **Check the interior reveal.** Make sure the measurement from the interior face of the door to the interior face of the wall is equal at several points around the door.

**Note:** If dimensions are not equal, check to make sure the fins are folded out to 90° at all points.

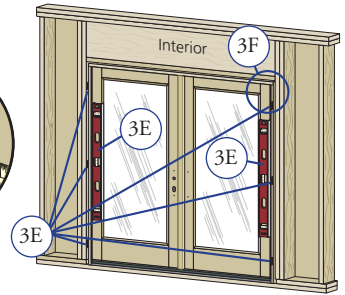
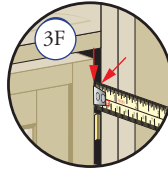

## Clip or Frame Screw Installation, go to Step 5I

- G. **Fasten the door** to opening by driving 1-1/2" galvanized roofing nail into each pre-punched hole in the nailing fin.

**Note:** Make sure the fin corner is lying as flat as possible

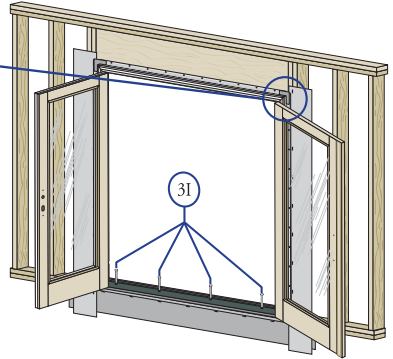
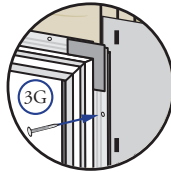

- H. **Carefully open the door(s)** and remove all shipping spacers.

**Note:** Be sure to remove the spacers from the bottom edge of the door panel.

**Double Doors with Multipoint latch in center:** Use the construction handle to operate the active door handle. Operate the flushbolts per the instructions on the label on the strike located on the astragal.

- I. **Designer Series® Out-Swing:** Install sill screws. Place a dab of sealant in each of the pre-drilled holes in the bottom of the unit (sill). Then insert a #8 x 2" corrosion resistant screw (provided) into each hole. For masonry floors use a 3/16" masonry screw in place of the provided screw, pilot drill per screw manufacturer's recommendations.

**All other:** Sill screws are not needed.

**For combinations (Multi-wide):** Pre-drill frame at mullion ends 3" & 6" from each mullion joint and insert #10 x 3" corrosion resistant screws. For masonry applications, use 3/16" masonry screws.

- J. **For Low Profile Sills:** Through each installation screw hole drill a 1/8" pilot; and install a #8 x 3" corrosion resistant screw (provided) into the pilot hole into the floor. For doors including a standard lock install tubs per instruction included with the sill strike package.

**Note:** For concrete floors use masonry screws a minimum size of 3/16" diameter x 3" and pilot per manufacturer's recommendations for the screw.

# 3 SETTING AND FASTENING THE DOOR (continued):

## K. Double Doors Only:

**Designer Series®:** Place a dab of sealant into the center sill strike hole and install the #8 x 3" flat head corrosion resistant screws (provided) or a 3/16" masonry screws into the hole.

**ProLine®:** Remove the screw from the sill strike located on the door sill, then place a dab of sealant into the sill strike hole and install the #8 x 3" flat head corrosion resistant screw (provided) or a 3/16" masonry screw into the hole.

**Entry Doors:** Remove the two screws from the sill strike located on the door sill. Place a dab of sealant into the center sill strike hole and install the #12 x 2-1/2" flat head corrosion resistant screws (provided) or a 3/16" masonry screws into the hole.

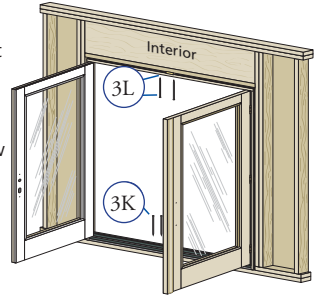

- L. **Double Doors Only:** Shim between the frame and the rough opening at the head strike location and at every frame anchor hole location. Keep shims back 1/2" from interior face of the door frame.

**Designer Series:** Install the #8 x 3" flat head corrosion resistant screws (provided) into the hole.

**ProLine:** Remove the screw from the head strike located on the door head then install the #8 x 3" flat head corrosion resistant screws (provided) into the hole.

**Entry Doors:** Remove the two screws from the head strike located on the door head. Install the #12 x 2-1/2" flat head corrosion resistant screws (provided) into the hole

**Note:** For doors with pre-drilled installation holes in the head. If installation holes are present, drill 1/8" diameter pilot hole into the rough opening and install a #8 x 3" corrosion resistant screw (provided) in each hole.

- M. On each hinge, starting at the top insert a corrosion resistant screw (#8 x 3" provided) into the open screw hole. Make sure the screw passes through the shims and into the structural framing.

- N. **Check door operation.** Open and close the door to check for proper operation. Make sure the door will latch correctly.

**Note:** If there are any problems with the operation, check to confirm the door frame is installed plumb, level and square. If the reveal between the door panel(s) and frame is not even, adjustments may be made:

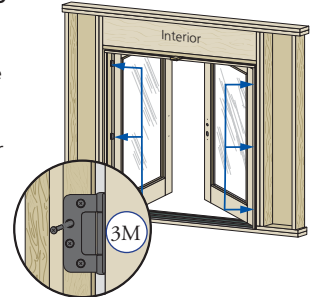

**Doors without adjustable hinges:** Plastic shims located behind the hinges may be removed to adjust the reveal between the door panel and door frame. Additional hinge shims may be added if required.

**Note:** Doors with adjustable hinges will have a (+)/(-) on the door panel hinge leaf to indicate possible adjustments and doors without adjustable hinges do not have adjustment indicators.

**Adjustable hinges are not designed to make up for incorrect installation of a door frame. Before adjusting hinges, confirm the door is installed plumb, level and square.**

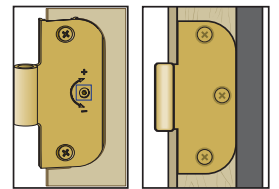

Adjustable Hinge

Non-Adjustable Hinge

- O. **For Doors with adjustable hinges:** The hinges can be used to move the panel side to side by moving all hinges in the same direction or the hinges can slightly rotate the panel by adjusting the hinges in opposite directions. Use a T20 Torx wrench for Entry Doors or a 1/8" Allen wrench for Designer Series doors to turn the center screw clockwise (+) to increase the space between the hinge side of the frame and door panel. Turn the center screws counter-clockwise (-) to decrease the space between the hinge side of the frame and the door panel.

**Note:** Do not adjust the hinge with the top and bottom screws loose; this could force the hinge to adjust beyond its design capability which can cause the hinge to bind, damage the hinge and/or pull out the screws. A 3/4 turn of the center screw provides approximately 5/32" adjustment.



# 3 SETTING AND FASTENING THE DOOR (continued):

- P. **Doors with a lock strike in the side (jamb) and without a sidelight on the lock side:**  
Drill an 1/8" diameter x 2" deep pilot hole into the rough opening through the pre-drilled holes located in the frame as follows:
  - P1. **Door Frame Corner:**  
Drill pilot holes through the pre-drilled hole located in the upper frame corner on the lock jamb side, approximately 8" from the top of the door frame head.
  - P2. **Doors with Multi-point Lock:**  
Drill through the one pre-drilled hole located in each lock strike. (Pull back frame weatherstrip to locate open hole in strike).
  - P3. **Center Latch and Deadbolt Lock:**  
Drill through the mounting hole locations. Insert a # 8 x 3" screw into the pilot holes making sure it passes through the shim and into the rough opening.  
**Note: This step does not apply to center latching double doors.**

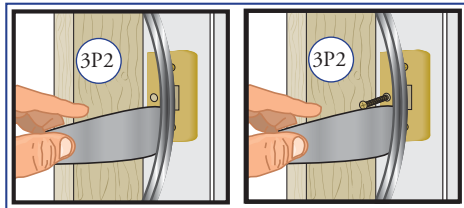
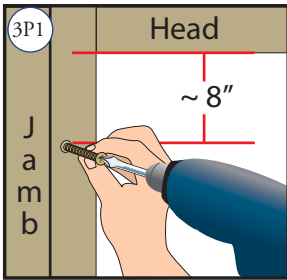

Pull back weatherstrip to expose strike hole.

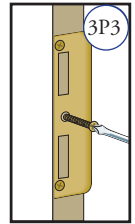

# 4 INTEGRATING THE DOOR TO THE WATER RESISTIVE BARRIER:

*Note: The flashing tape must be applied approximately 1/2" onto the frame cladding at the jambs and head. Pre-folding the tape at 1/2" before removing the paper backing will make it easier to apply the tape correctly. If the siding is less than 1/2" thick, adjust the dimension of the fold so the exterior sealant line will cover the exterior edge of the tape.*

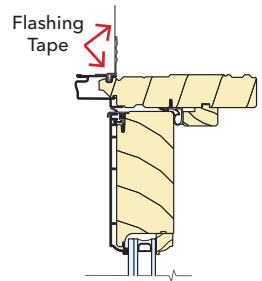

- A. **Apply side flashing tape.** Cut two pieces of flashing tape 4" longer than the frame height of the door. Apply one piece 1/2" onto the frame cladding, over the nailing fin and onto the water resistive barrier on each side. The tape should extend 2" above the top of the door and 2" below the bottom of the door. Press the tape down firmly while folding down the excess tape at the top and bottom of the door.

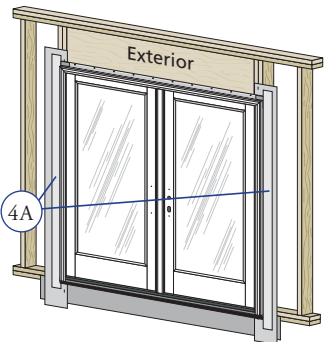

# 4 INTEGRATING THE DOOR TO THE WATER RESISTIVE BARRIER (continued):

- B. **Apply top flashing tape.** Cut a piece of flashing tape long enough to go across the top of the door and extend at least 1" past the side flashing tape on both sides. Apply the tape 1/2" onto the frame cladding, over the top nailing fin as shown. Fold the overlapping tape down, and press all tape down firmly.

*Note: The top flashing tape must overlap the side flashing tape to prevent water from getting behind it.*

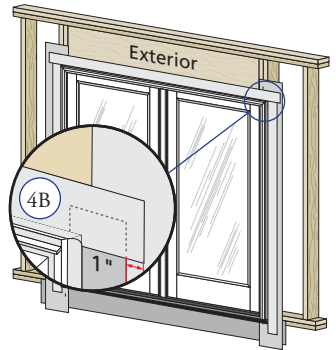

- C. **Apply the top flashing paper.** Cut one piece of flashing paper at least 21" longer than the width of the rough opening. Position the bottom edge of the flashing paper flush with the frame of the door and center the flashing paper with the door. Staple the flashing paper to the header.

*Note: When applying the first layer of building felt, ensure the sill flashing paper overlaps the building felt. This will tie the door system into the building water management system.*

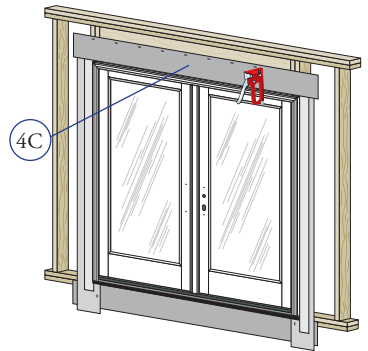

*As required by local code (such as Florida product approval system), additional anchors may be required. Install them at this time.*

# 5 DOOR REPLACEMENT IN SIDING WITHOUT NAIL FIN:

## Head Flashing Instruction and Rough Opening Preparation

*Note: Pella Recommends and some codes require the use of a head drip flashing. If there is a functioning, existing flashing, proceed to step 5D.*

- A. **Prepare the head flashing** by cutting it the same width as the j-channel/siding opening.
- B. **Pry the top (head) j-channel/siding away from the sheathing** enough so the head flashing can be slid under the house wrap.
- C. **Insert the head flashing behind the j-channel/siding** and behind the house wrap (if present).

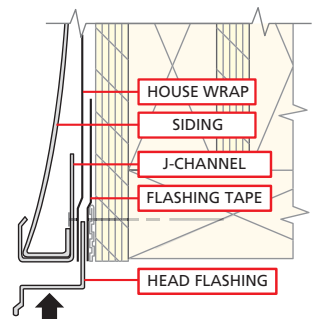

# 5 DOOR REPLACEMENT IN SIDING WITHOUT NAIL FIN (continued):

- D. Clean the vinyl j-channel/trim and rough opening with isopropyl alcohol or window cleaner to make sure it is free of dirt and debris before proceeding.
- E. Place a 3/8" bead of sealant (or enough to cover the area) between the j-channel and the rough opening at the head and jambs only. Tool the sealant with a putty knife to press the sealant into the opening.  
**CAUTION: The cut fin may have sharp edges!**

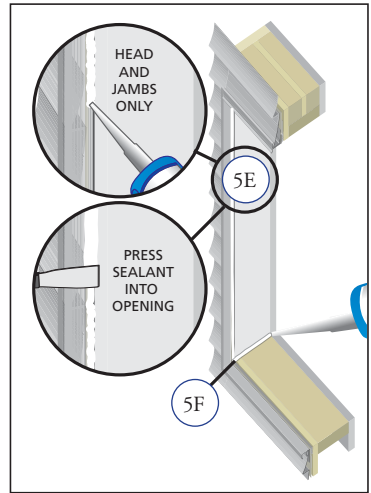

- F. Place a 3/8" bead of sealant at each corner of the opening.

- G. Starting at the top (head) of the opening, cut one piece of flashing tape 12" longer than the width of the rough opening. Place the flashing tape onto the j-channel edge, over the sealant and onto the rough opening surface and extend down the jambs 6".

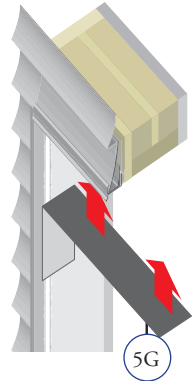

For Sill Preparation see steps 1E - 1T.

- H. Cut two pieces of flashing tape 6" longer than the height of the opening. On one side (jamb) of the opening, start the tape in the upper corner and work down and onto the sill. Make sure the tape is applied from the j-channel edge over the sealant and onto the rough opening surface.

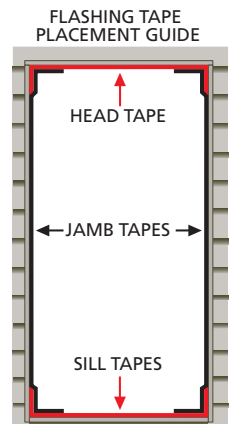
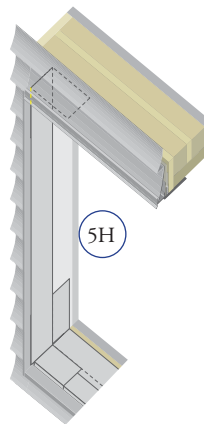

See steps 3A - 3F only for Setting the Door.

# 5 DOOR REPLACEMENT IN SIDING WITHOUT NAIL FIN (continued):

## Fastening Door to Opening

1. **After setting the door plumb level & square**, secure the door to the opening. If using frame screw method then have two people hold the door upright and secure while a third person opens one panel and inserts a screw through the jamb 6" down from the top corner, then open the other panel and repeat on the opposite jamb. See below for pilot hole, screw size, & location details.

### ALTERNATE ANCHORING METHODS, CLIP AND SCREW PLACEMENT:

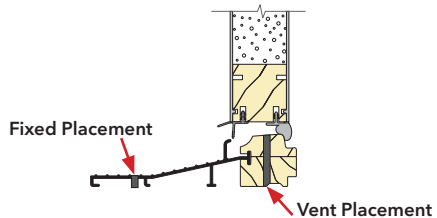
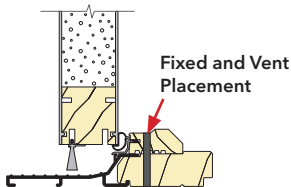
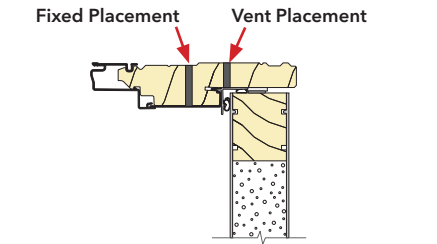
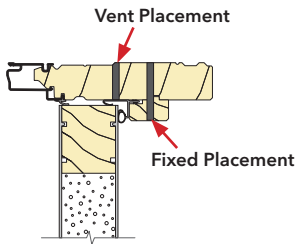
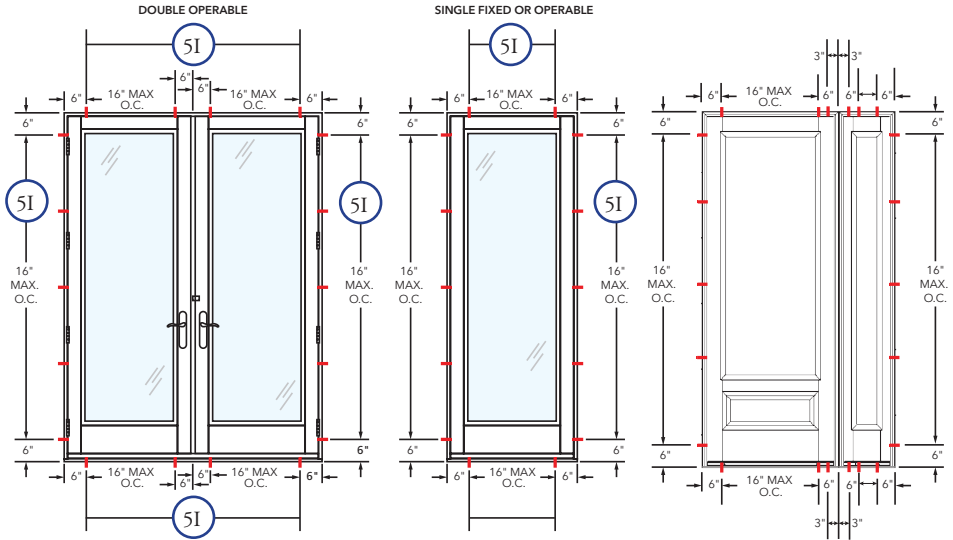

Out-Swing Screw Locations

In-Swing Screw Locations

# 5 DOOR REPLACEMENT IN SIDING WITHOUT NAIL FIN (continued):

## Frame Screw Method:

*Note: If installing with installation clips, proceed to step P.*

- J. **Jambs:** Drill and counter sink 3/16" diameter clearance holes through the door frame only and not into the rough opening at the locations shown on the diagrams.

*Note: Out-Swing Doors Only - If choosing to locate clearance holes through the frame to be concealed by door panel; remove frame weatherstrip and drill holes under the weatherstrip.*

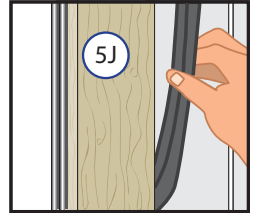

- K. **Frame Head:** Drill and counter sink 3/16" diameter clearance holes through the door frame head only and not into the rough opening at the locations shown on the diagrams.

- L. **Threshold:** Drill and counter sink 3/16" diameter clearance holes through the threshold but not into the rough opening at the locations shown on the diagrams

- M. **Drill 1/8" x 1" deep pilot holes through the clearance holes** and into the rough opening framing in the head, jambs and threshold of the unit frame.

- N. **Secure the jambs and head of the door.** Drive #10 x 3-1/2" corrosion resistant wood screws through the door frame and shim, into the rough framing. Drive the screws until snug but DO NOT over-tighten the screws. DO NOT bend or bow the unit frame.

- O. **Secure the sill** by driving #10 x 3-1/2" corrosion resistant wood screw through the threshold into the floor. For masonry applications use masonry screws a minimum of 3/16" diameter x 3" and pilot drill per screw manufacturer's recommendations.

**Go back to 3H - 3P to complete fastening through hinges and strikes.**

## Installation Clip Method:

**See Step 2C for Clip Application Details**

- P. **Fasten the door to the opening** by driving two #8 x 1-1/4" corrosion resistant screws into the pre-punched holes in the clips. If the clips are bent and fastened to the interior stud/block, install the screws as close to the bend as possible.

*Note: DO NOT shim above the door. For masonry openings use two masonry screws that are a minimum size of 3/16" x 1-1/2" per clip. Pre-drill the masonry per screw manufacturer's recommendations before attempting to drive the screws in.*

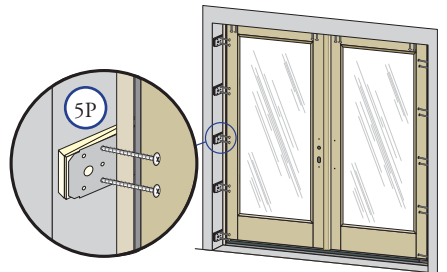

**Go back to 3H - 3P to complete fastening through hinges and strikes.**

Download from [www.Somanuals.com](http://www.Somanuals.com). All Manuals Search And Download.

# 6 INTERIOR SEAL:

**Caution:** Ensure use of low pressure polyurethane window and door insulating foams and strictly follow the foam manufacturer's recommendations for application. Use of high pressure foams or improper application of the foam may cause the door frame to bow and hinder operation.

- A. **Add a sealant bead across the inner sill and 6" up each jamb** between the frame and rough opening.
- B. **Apply insulating foam sealant.** From the interior, insert the nozzle of the applicator into the space between the door and the rough opening approximately 1" past the edge of the frame (and past the jamb extensions) and apply a 1" deep bead of foam. This will allow room for expansion of the foam and will minimize squeeze out. Apply sealant across the interior surface of the shims to create a continuous seal. Follow foam manufacturer's instructions.

**Note:** *DO NOT place any foam between jamb extensions and the rough opening.*

- C. **Check the door operation** by opening and closing the door.

**Note:** *If the door does not operate correctly, check to make sure it is still plumb, level, square and that the sides are not bowed. If adjustments are required, remove the foam with a serrated knife. Adjust the shims, and reapply the insulating foam sealant.*

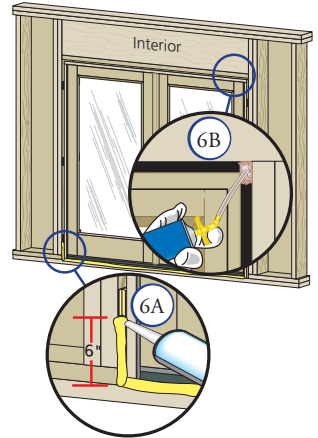

# 7 SEALING THE DOOR TO THE EXTERIOR WALL CLADDING:

When applying siding, brick veneer or other exterior finish material, leave adequate space between the door frame and the material for sealant. Refer to the illustration corresponding to your finish material.

Note: The sealant details shown are standard recommendations from the sealant industry. Contact your sealant supplier for recommendations and instructions for these and any other applications.

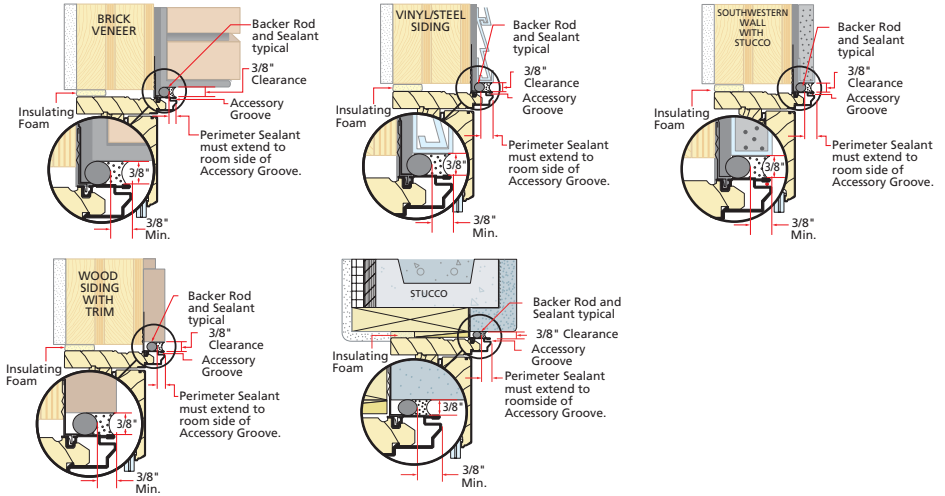

## Replacement Frame:

Note: When applying siding, brick veneer or other exterior finish materials, leave adequate space between the door frame and the material for sealant. Refer to the illustration corresponding to your finish material. Not allowing adequate space or not using backer rod may cause the sealant to break down prematurely and allow water to infiltrate.

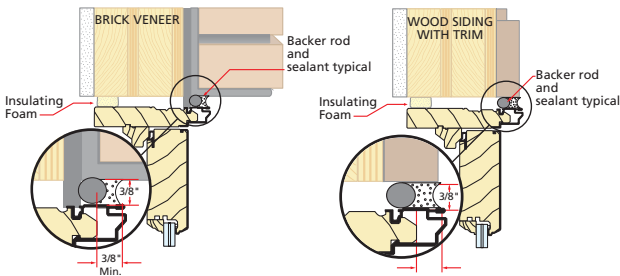

# 7 SEALING THE DOOR TO THE EXTERIOR WALL CLADDING (continued)

- A. **Insert backer rod** into the space around the door so there is approximately 3/8" to 1/2" clearance between the backer rod and the exterior face of the door.

**Note:** *Backer rod adds shape and depth for the sealant line.*

- B. **Apply a bead of high quality exterior grade sealant** to the entire perimeter of the door.
- C. **Shape, tool and clean excess sealant.** When finished, the sealant should be the shape of an hourglass.
- D. **Remove plastic guards** at the base of the door once construction is complete.
- E. **Install the hardware.** Refer to the instructions included in the hardware box.

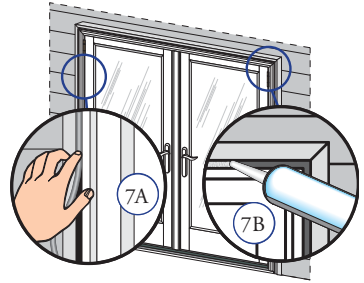



## INTERIOR FINISHING

If products cannot be finished immediately, cover with clear plastic to protect from dirt, damage and moisture. Remove any construction residue before finishing. Sand all wood surfaces lightly with 180 grit or finer sandpaper. DO NOT use steel wool. BE CAREFUL NOT TO SCRATCH THE GLASS. Remove sanding dust.

Pella products must be finished per the below instructions; failure to follow these instructions voids the Limited Warranty.

## FINISHING INSTRUCTIONS

Paint or finish immediately after installation.

**Note:** DO NOT paint, stain or finish weatherstrip or vinyl parts! If paint, stain or finish gets on the weatherstripping, wipe it off immediately with a damp cloth. To maintain proper performance, do not remove weatherstrip, foam corner seal wedges or gaskets. Air and water leakage may result if these factory-installed items are removed. After finishing, allow doors to dry completely before closing them. Pella will not be responsible for finishing imperfections. The use of unapproved finishes, solvents or cleaning chemicals may cause adverse reactions with door materials. Pella will not be responsible for problems caused by the use of unapproved materials. If in doubt, contact your local retailer or representative.

Use of inappropriate finishes, solvents, brickwash or cleaning chemicals will cause adverse actions with window and door materials and voids the Limited Warranty.

Care and maintenance information is available in the Pella Owner's Manual. You can obtain an owner's manual by contacting your local Pella retailer. This information is also available on [www.pella.com](http://www.pella.com).

**Factory Prefinished Panels:** A door panel that has been prefinished with stain or paint from the factory requires no additional finishing. Clean the surface with mild soap and water. DO NOT use abrasives. DO NOT scrape or use tools that might damage the surface.

**Clad Exterior Frame:** The exterior frame is protected by aluminum cladding with our tough EnduraClad® baked-on-factory finish that needs no painting. Clean this surface with mild soap and water. DO NOT use abrasives. DO NOT scrape or use tools that might damage the surface.

**Panel Cleaning and Prep Instructions for Unfinished or Primed Panels:** Dry wipe dust from doors gently. Examine door for possible smudges or fingerprints made from normal handling or construction. To remove smudges, lightly wipe surface with warm water. DO NOT sand surface of fiberglass panel. Scuff sand with light grade sand paper or abrasive pad (220 grit or higher). Rinse surface with mineral spirits for fiberglass panels and warm water for steel panels. Let door and sidelight surfaces dry completely before applying finish. Finish the door panels as soon as possible after installation.

**Staining fiberglass panels or unfinished interior frame members:** Fiberglass door and sidelight panels may be stained with a gel stain if a wood look is desired. Pella offers stain kits in a variety of colors. Apply and finish per the stain kit manufacturer's instruction. Ensure that all exposed panel edges are finished to minimize the chance of damage. Unprimed interior frame parts may be stained with wood stains and should be finished with a minimum of two coats of a clear polyurethane finish. DO NOT bridge the top coat between the outer edge of the glazing frame and the door panel.

**Note:** The fiberglass base color tone will vary. This variance is normal and will not impact the stain color of the door.

**Painting Instructions:** Wood door frame exteriors, premium steel door panels and sidelights are factory primed. If a paint finish is desired, finish the parts with two coats of a 100% latex paint that has a good blocking resistance. On units with glass, do not bridge paint between the outer edges of the glazing frame and the door panel. On fiberglass products, brush the paint in the same direction as the simulated wood grain. Ensure that all exposed panel edges are finished to minimize the change of panel damage.

Failure to use the correct type of finish may result in a door that sticks shut. Ask a qualified paint professional to specify a product with good blocking resistance.

**On patio doors:** It is optional to paint, stain or finish the vertical and horizontal panel edges.

## EXTERIOR FINISHING

The exterior frame and sash are protected by aluminum cladding with a Pella EnduraClad® or EnduraClad Plus baked-on factory finish that needs no painting. Clean this surface with mild soap and water. Stubborn stains and deposits may be removed with mineral spirits. **DO NOT** use abrasives. **DO NOT** scrape or use tools that might damage the surface.

Use of inappropriate finishes, solvents, brickwash or cleaning chemicals will cause adverse reactions with window and door materials and voids the Limited Warranty.

## CARE AND MAINTENANCE

Care and maintenance information is available in the Pella Owner's Manual. You can obtain an owner's manual by contacting your local Pella retailer. This information is also available at [www.pella.com](http://www.pella.com).

## IMPORTANT NOTICE

Because all construction must anticipate some water infiltration, it is important that the wall system be designed and constructed to properly manage moisture. Pella Corporation is not responsible for claims or damages caused by anticipated and unanticipated water infiltration; deficiencies in building design, construction and maintenance; failure to install Pella® products in accordance with Pella installation instructions; or the use of Pella products in wall systems which do not allow for proper management of moisture within the wall systems. The determination of the suitability of all building components, including the use of Pella products, as well as the design and installation of flashing and sealing systems are the responsibility of the Buyer or User, the architect, contractor, installer, or other construction professional and are not the responsibility of Pella.

Pella products should not be used in barrier wall systems which do not allow for proper management of moisture within the wall systems, such as barrier Exterior Insulation and Finish Systems, (EIFS) (also known as synthetic stucco) or other non-water managed systems. Except in the states of California, New Mexico, Arizona, Nevada, Utah, and Colorado, **Pella makes no warranty of any kind and assumes no responsibility for Pella windows and doors installed in barrier wall systems. In the states listed above, the installation of Pella products in barrier wall or similar systems must be in accordance with Pella installation instructions.**

Product modifications that are not approved by Pella Corporation will void the Limited Warranty.

# TROUBLESHOOTING - Adjustable Strike Latching Issues

## Issue 1:

Door is difficult to latch. Remove the strike and adjustable strike shim then reinstall the strike.

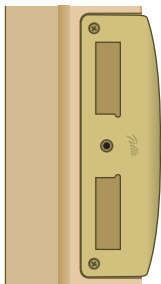

## Issue 2:

Door needs to close more tightly against the weather-strip. Remove the strike and adjustable strike shim. Remove the tabs from the adjustable strike shim and install so that the thicker side is visible at the strike edge. Reinstall the strike.

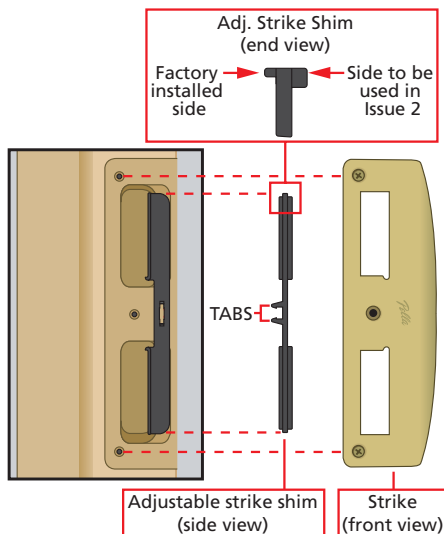
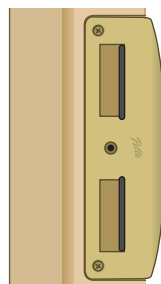

## Free Manuals Download Website

<http://myh66.com>

<http://usermanuals.us>

<http://www.somanuals.com>

<http://www.4manuals.cc>

<http://www.manual-lib.com>

<http://www.404manual.com>

<http://www.luxmanual.com>

<http://aubethermostatmanual.com>

Golf course search by state

<http://golfingnear.com>

Email search by domain

<http://emailbydomain.com>

Auto manuals search

<http://auto.somanuals.com>

TV manuals search

<http://tv.somanuals.com>