



Pentair
Pool Products®

MiniMax® Plus HP

Because reliability matters most

OWNERS OPERATION MANUAL

WARNING

FOR YOUR SAFETY - READ BEFORE OPERATING

Warning: If you do not follow these instructions exactly, a fire or explosion may result, causing property damage, personal injury or loss of life.

WARNING

Improper installation, adjustment, alteration, service or maintenance may cause property damage, personal injury or death. Installation and service must be performed by a qualified technician or service agency.

Models:

MiniMax Plus HP 400 (XLS400)
MiniMax Plus HP 600 (XLS600)
MiniMax Plus HP 800 (XLS800)
MiniMax Plus HP 1000 (XLS1000)
MiniMax Plus HP 230 (CP12)

Part #471949 Revision #C

© 2003 Pentair Pool Products, Inc.

1620 Hawkins Avenue, Sanford, NC 27330

10951 West Los Angeles Avenue, Moorpark, CA 93021

Note: Specifications may change without notice.

Owners Operational Information Only

Technicians See Separate Installation Manual

OWNERS SECTION - TABLE OF CONTENTS

1. OPERATIONAL INSTRUCTIONS	3 - 7
a. Introduction & Design Features	
b. Heater Control Panels & L.E.D. Status Lights	
2. START UP PROCEDURES	8 - 13
a. Compressor Warm Up Time	
b. Filter System Cleaning	
c. Operational Description	
c. Circulation Pump Timer	
d. Thermostat Setting	
e. Heat Loss & Pool Covers	
3. OWNERS CARE	14 - 17
a. Placement Area	
b. Sprinkler Placement & Plants & Condensation Run Off	
c. Clearance and Air Flow.	
d. Cleaning The Unit	
e. Pool Circulation System Maintenance	
f. Auto Vacuum's & Vacuuming	
4. PLUMBING & WATER FLOW	18 - 19
a. Plumbing Connections & Auto Bypass	
b. Large Water Pump Plumbing Bypass	
c. Mandatory Chlorinator Loop & Check Valve	
5. CHEMICAL & CHLORINATOR APPLICATION & USE	20 -24
a. Water Quality and Testing Values	
a. Heat Exchanger Protection & Sacrificial Water Fittings	
b. Chemical Feeder Placement & Use & Hand Feeding Chemicals	
c. Commercial Feeders	
d. Spa Chemical Application.	
6. SHUT DOWN AND FREEZE PROTECTION PROCEDURES	25
a. Seasonal Shut Down	
b. Short Term and Long Term Freezing Protection	
7. OWNERS TROUBLE SHOOTING GUIDE.....	26 - 27
8. ELECTRICAL WIRING SPECIFICATIONS BY MODEL NUMBER	28
8. HOW TO GET SERVICE	29
10. GLOSSARY OF TERMS	30 - 33
ADDITIONAL MANUALS AVAILABLE:	
INSTALLATION MANUAL - TECHNICIAN ONLY	
OPTIONS/ACCESSORY MANUAL - TECHNICIANS ONLY	
OWNERS MANUALS	

Manufactured By Pentair Pool Products, Inc.

WARNING

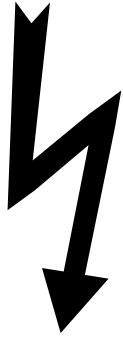

THE MISUSE OF THIS PRODUCT CAN RESULT IN SEVERE INJURY, DEATH, OR PROPERTY DAMAGE. BE ADVISED OF THE FOLLOWING CONDITIONS THAT MAY EXIST:

1. ELECTROCUTION AND/OR FIRE DUE TO IMPROPER WIRING.
2. HAND AND HAIR ENTRAPMENT MAY OCCUR NEAR THE FAN LOCATED ON THE TOP OF THIS UNIT.
3. LOSS OF POOL WATER AND/OR FLOODING AND/OR PROPERTY DAMAGE.
4. DAMAGE AND/OR MISUSE TO THE PRODUCT RESULTING IN FAILURE OR EXCESSIVE WEAR.
5. ALL ELECTRICAL WORK BY LICENSED PROFESSIONAL ONLY.

Owners/users should contact the factory service department for advice at:

Pentair Pool Products, Inc.
(800) 831-7133

HEAT PUMP EFFICIENCY

Your new highly efficient heat pump pool/spa heater will deliver warm pool water for your comfort for pennies a day. For every dollar you spend to run your heat pump, you will receive between \$4.00 and \$5.00 worth of heat in return. The heat pump transfers the heat from the outside air to your pool or spa. Your heat pump costs about 60 to 75 percent less than L.P. Gas heaters to operate with less maintenance and gas storage tank is not needed. Your heat pump produces no pollution and no pilot lights to deal with.

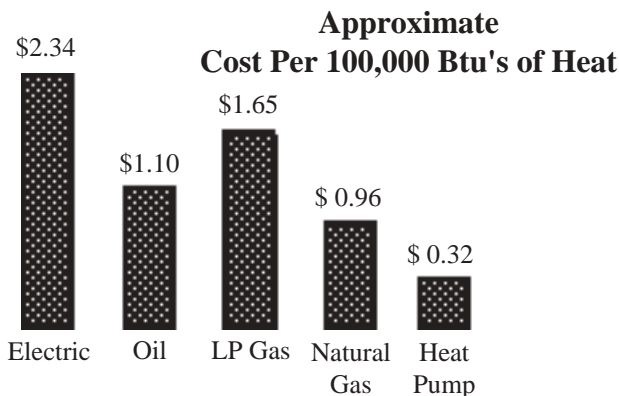

RETURN ON INVESTMENT

The costs of installing a heat pump are somewhat higher than a gas heater but you will save enough in operational costs to offset the difference, probably in the first year or two. After a few heating seasons you will have saved enough, compared to LP gas heat, to pay for the entire heat pump and installation

LONGER SWIMMING SEASON

A heat pump is the least expensive way to heat your pool. It will out perform solar by delivering heat on demand, no matter how much sunshine is available. A solar system with a gas back L.P. Gas back up will cost more to operate than the heat pump alone. In Florida, a heat pump offers a full 12 months of swimming season compared to a solar systems 10 month swimming season. A heat pump will provide higher temperatures than a solar system. Solar will not heat a spa on demand after sundown & during inclement weather.

LOW MAINTENANCE

Maintenance cost can be more for a gas heater, considering the fact that a gas heater starts to lose efficiency as it gets older. The heat pump's sealed system needs far less attention.

SPECIAL FEATURES

Separate Air Handling / Electric Compartment
An internal electrical compartment substantially reduces future service from moisture and salt laden air flow.

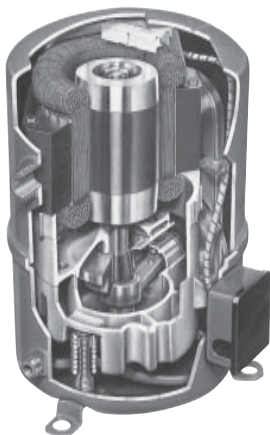
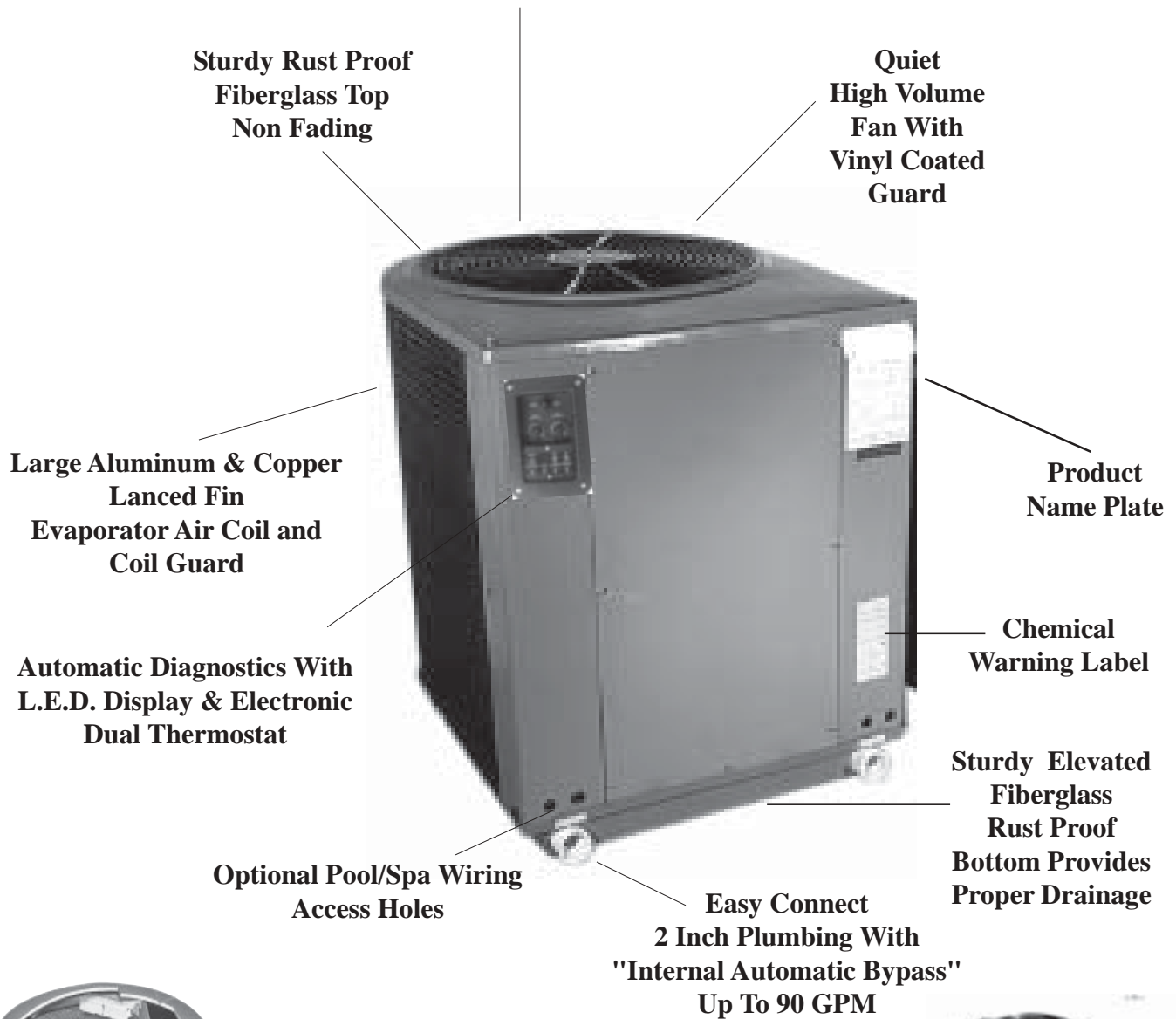

**TRANE®
COMPRESSOR**
with 410-A, the safe
and clean refrigerant.

**And
SCROLL
COMPRESSOR**



Super Quiet & Highly Efficient Compressor Design

DESIGN ADVANTAGES

The electrical panel has an isolated compartment, located within the mechanical compartment to prevent corrosion. The heat from the compressor located just below the electrical compartment helps eliminate moisture as well. This exclusive design will substantially extend the life cycle of the heater. The fiberglass cabinets is corrosion proof and is much stronger than plastic cabinets.

Heat Exchanger Special Cupronickel Alloy

Encased In A Block of Foam
to Prevent Heat Loss & Corrosion



Dual Thermostat

L.E.D. Diagnostic Lights



Internal Automatic Bypass

Free Flow 2" Plumbing
Automatically adjusts the water flow.

Lowest water flow restriction available.

2" PVC Water IN
15-90 GPM

2" PVC Water OUT with Elevated Fiberglass Bottom Pan for Proper Condensation Drainage.

WARNING

The heater must be electrically grounded and bonded in accordance with local codes, or in the absence of local codes, with the latest national electrical codes ANSI/NFPA No. 70. All wiring must comply with all local codes, or in the absence of local codes, with the latest national electrical codes ANSI/NFPA No. 70. For proper wire and/or breaker size, please refer to specification sheet and your local licensed electrician. **Always bond heat pump cabinet to pool steel and ground to power supply.**

DUAL THERMOSTAT CONTROL PANEL

THERMOSTAT

The thermostat dial is just like any other, when you set it at a certain setting the heater will heat up to that temperature and then shut off. When the pool/spa water temperature drops below this setting the heater will come on and start heating the water back up to the setting on the thermostat.

You will notice there are no number settings printed on the dial face. There is a certain procedure to follow to determine the exact temperature you have the thermostat set at. This is described further on next pages.

The maximum setting for a thermostat is 104 degrees F. You will only be able to reach this high temperature in a spa application. Pool temperatures are normally between 78 and 82 degrees F. Actual pool temperatures are determined by your installer, when the unit is sized to your specifications. The lowest setting on the thermostat is around 60 degrees F.

To disable the heater, turn the thermostat dial all the way to the left. If you live in a climate where the water temperature may drop below 60 degrees F you must shut the circuit breaker off. Otherwise do not use the breaker as an on/off switch.

See "Start up Procedures" regarding compressor preheating if the main power breaker is shut off. The compressor must be preheated for 8 hours after the power supply has been disconnected.

DUAL Thermostat



L.E.D. Status Lights
(See page 7 for details.)

L.E.D. STATUS LIGHT PANEL

The indicator lights will help you determine that the unit is running normally or if there is a condition that may keep the heater from running. Note that the spa light is inactive on single thermostat units. See next page for details on reading the status lights.

L.E.D. STATUS LIGHT PANEL

Control Ready "Green": The green control ready indicator light lets you know that the heater has power and it is ready to heat. This light must be on before the heater can run. If this light is off, check you power supply and circuit breakers. If this light is off, none of the others will light either.

CAUTION

The unit may still have "live voltage" when the control light is off.

NOTE: The bottom four indicator lights work in sequence from left to right.

(To use indicator lights see troubleshooting guide pages 26 & 27)

POOL MODE "Yellow": The yellow pool mode indicator light lets you know that you have selected the pool mode with the pool /spa select switch, (dual thermostat control only). This light will be off when the control is in spa mode.

SPA MODE "Orange": The orange spa mode indicator light tells you that you have selected the spa mode with the pool spa select switch, (dual thermostat control only). This light will be inactive when used with the standard single thermostat control (pool only). **WATER PRESS. OK "Green":** The green water pressure OK indicator light tells you that the internal water pressure switch is OK. The internal water pressure switch is used to shut the heater on and off with the circulation pump. The heater should not run when the water pump is not pumping water through the heater. Dirty filters and lint traps will cause low water flow to the heater and may cause the water pressure switch to deactivate the heater. If this light stays off, clean all filters and check all filter system valving to insure proper water flow. See pages 12, 13 and 20, for more information regarding water flow requirements. When this water flow indicator light is off the t-stat light and the low and high press. lights will not come on either and the heater will stay off.

T-STAT ON "Green": The green thermostat on indicator light is used to let you know that the thermostat is set higher than the pool or spa water temperature. If the light is not on, turn the thermostat to a higher position and the fan should then start, (compressor starts after a 5 minute delay). If the thermostat is already all the way up and the light is still off, means that the pool or spa water temperature has reached the maximum of 104 F + or - allowed. When this light goes off, the heater has heated the pool or spa to the preset temperature. When this light is off the heater and the low and high pressure lights will stay off.

LOW PRESS. OK "Green": The green low pressure indicator light is designed to let you know that the low side refrigerant pressure is OK. If the refrigerant pressure was too low for the unit to operate this light the heater will shut off. The heater is charged with Freon™ (refrigerant). If the outside air temperature drops below 40 degrees the refrigerant pressure will drop below the required operational range. The internal low refrigerant pressure switch will act as a defrost control to keep the unit from forming ice on the outer evaporator coil when this light is off. It may also indicate that the unit may have a refrigerant leak as well. When this light is off the high pressure light and the heater will be off as well.

HIGH PRESS. OK "Green": The green high pressure OK indicator light is used to tell you that the heater is operating at the correct high side refrigerant pressure range. If the refrigerant pressure exceeds the maximum needed for proper operation, this light and the heater will shut off. Excessive high refrigerant pressure is usually caused by low water flow through the heater. If this light goes out, clean the filtering system and check all plumbing valves to insure proper water flow then try to restart the heater. See pages 8,18 and 19 for information regarding water flow. When this light is off the heater will not run.

START UP PROCEDURES

TURN T-STAT ALL THE WAY DOWN

Make sure the thermostat dial is turned all the way to the "LEFT" so the unit will not start until you are ready. Then turn the circuit breaker on.

COMPRESSOR TIME DELAY

BE AWARE THERE IS A 5 TO 7 MINUTE TIME DELAY BEFORE THE COMPRESSOR WILL START ONCE THE UNIT IS TURNED ON OR WHENEVER IT RESTARTS. All models.

ADVISE YOUR POOL SERVICE CO.

If you have a regular pool service on a weekly basis make sure your owners manual available for them to inspect. You may request that one be sent to them, by calling the factory service department at (800) 831-7133. Be sure that they are aware of the chemical balance and chemical introduction rules, in this manual. The conditions in this manual must be followed in accordance with the warranty, if for any reason, the heater is improperly installed and or operated, the manufacturers warranty may be void.

CLEAN FILTERING SYSTEM

Next, make sure that the pool filter is as clean as possible. A dirty filter will hamper the efficiency of the unit and cause the unit to cycle on and off resulting in damaging effects. Filters may look clean but can be clogged with oils or minerals. Replacement is suggested every year and a half for cartridge type filters. See manufacturers directions for proper filter cleaning methods.

Next clean the lint trap basket inside the circulation pump. Then clean the skimmer leaf trap basket of all debris. A clogged lint trap or skimmer basket will restrict the water flow to the unit. Make sure there is adequate water in the pool so that the skimmer does not draw air. Never place any chemicals of any type, especially chlorine, in the skimmer.

If you are unfamiliar with your pool filtering system, you should consult your local pool company. The diagram shown above are not of any specific brand but are common in nature. The following diagram is of a typical filtering system.

WATER FLOW & EXISTING WATER PUMP

To filter the pool water each day, the water pump will come on & off according to the existing timer device. The heater will only heat if there is water running through it.

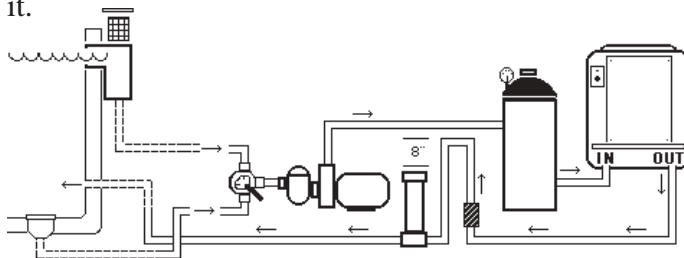

WATER PRESSURE SWITCH

If there is proper water flow through the unit the water pressure switch will close allowing the unit to run. When the circulation pump timer stops the water flow, the water pressure switch will shut the unit down. When the pump restarts for the next day, the pressure switch will close and allow the heater to run.

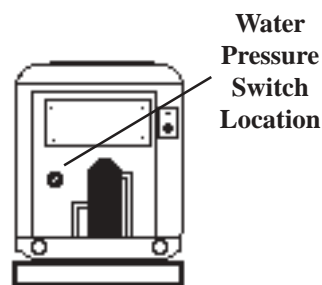

Filter & Trap Locations

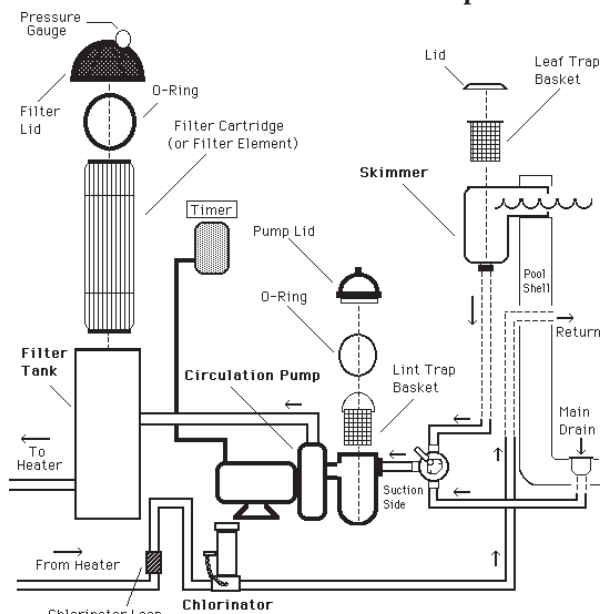

OPERATIONAL SEQUENCE

WATER FLOW & EXISTING WATER PUMP

To filter the pool water each day, the water pump will come on & off according to the existing timer device. The heater will only heat if there is water running through it and it operates long enough.

pool
or
spa

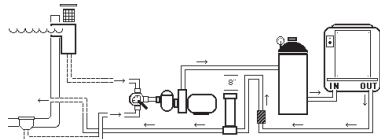

WATER PRESSURE SWITCH

When water starts flowing through the unit the water pressure switch will activate and allow the unit to run. When the circulation pump timer stops the water flow, the water pressure switch will shut the unit off. When the pump restarts for the next day, the pressure switch will activate and allow the heater to run again.

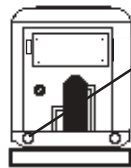

Water Pressure Switch Location

THERMOSTAT CONTROL & SETTINGS

Turning up the thermostat will start the unit. When the pool water has been heated to the thermostat setting, the unit will shut off. When the pool water temperature loses one to two degrees, the thermostat will activate the unit. There are no temperature graduate numbers printed on the thermostat face. To obtain an exact temperature for a pool, turn the t-stat 3/4's of the way up and then place a pool type thermometer in the pool water itself. Once the water has reached your target temperature on the thermometer, turn the thermostat knob backwards until the heater just shuts off. Therefore your thermostat will be set at the thermometer reading.

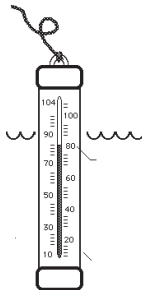

THERMOSTAT CONTROL & SETTINGS FOR HEAT & COOL MODELS

For heating mode on these models, make sure toggle is selected to heat and follow the previous instructions above. For cooling mode, make sure toggle is selected to cool. Turning down the thermostat counter clockwise will start the unit running. When the pool water has been cooled to the thermostat setting, the unit will shut off. When the pool water temperature rises one to two degrees, the thermostat will activate the unit. There are no temperature graduate numbers printed on the thermostat face. To obtain an exact temperature, turn the t-stat all the way down and then place a pool type thermometer in the pool water itself. Once the water has reached your target temperature on the thermometer, turn the thermostat knob forwards until the heater just shuts off. Therefore your thermostat will be set at the thermometer reading.



FAN-AIR CIRCULATION

Once the t-stat is activated the fan will begin to turn. To collect the heat from the air, the fan circulates warmer air through the evaporator air coil at about 4200 cubic feet per minute. The fan runs independently from the compressor. The compressor will start within 5 to 7 minutes after the fan.

EVAPORATOR AIR COIL

The fan circulates the warmer outside air through the evaporator air coil to collect any available heat. The cooler refrigerant absorbs this heat. This evaporates the refrigerant into a gas. Therefore the compressor can compress the gas to maximize the gained heat from the air.

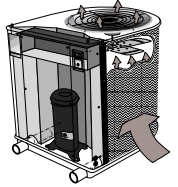

COMPRESSOR

Once the fan is running, the compressor will start 5 to 7 minutes later and is controlled by a time delay device. The compressor pumps and compresses refrigerant gas. When gas is compressed it gets very hot and intensifies the energy and then is released to the pool water. This compressed hot gas is pumped through the heat exchanger where it delivers heat to the pool water passing through the same heat exchanger.



WATER HEAT EXCHANGER

The compressed hot gas releases its heat to the pool water inside the heat exchanger. The exchanger is a tube within a tube construction, water passing through the inner tube, and the hot refrigerant passing through the outer tube. The refrigerant is transformed into a liquid (condensed) state as it releases its heat to the pool water. Therefore, it is also referred to as a condenser coil. The alloy exchanger is designed for maximum transfer surface area and strength.



Cross section

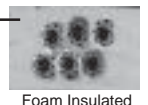

Foam Insulated

SYSTEM OVERVIEW

The heat pump system uses 410-A refrigerant to transfer the heat from the outside air to the pool water.

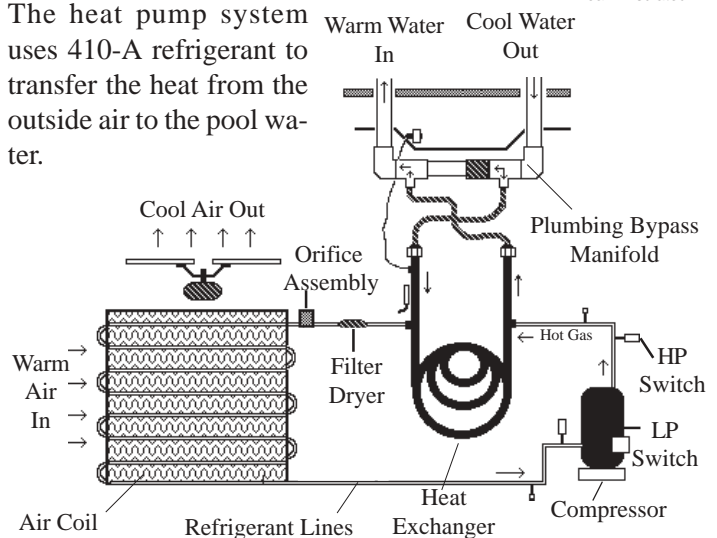

TIME CLOCK SETTING

Now that all the filters are clean and the pump is running with a full prime, you will need to set the pool circulation pump timer. Set the filter pump time clock for a long enough period of time to heat the pool or spa. The heater will not operate unless there is water running through the heat exchanger supplied by the circulation pump. Therefore, your pool will only heat during the period set on the timer. When setting the timer, be sure that you shut off the pool circulation pump circuit breaker. Then follow the timer manufacturers instructions to prevent electrical shock. Consult your dealer first.

INITIAL HEAT UP TIME (HEATERS)

You should start by letting the circulation pump run 24 hours a day until the pool reaches the desired temperature. Once the pool is up to your desired temperature you should reset the timer for a cycle of 6 to 18 hours per day during the hottest part of the day. Heat up time and operational time will vary with pool size, exposure and weather conditions. Spas will require considerably less time to reach temperature, usually in a matter of hours if a cover is used.

INITIAL COOL DOWN TIME (HEAT & COOL MODELS)

You should start by letting the circulation pump run 24 hours a day until the pool reaches the desired temperature. Once the pool is down to your desired temperature you should reset the timer for a cycle of 6 to 18 hours per day during the coldest part of the day. Cool down time and operational time will vary with pool size, exposure and weather conditions.

ADJUSTING THE TIMER

Timer styles vary, read the manufacturers instructions before attempting to reset timer. Make sure the plastic guard is in place. On this type of timer, note the On and OFF trippers located on the clock face. If you loosen the lock screw on the tripper you can move it to a new time. Make sure the time of day is correct.

To run the 24 hours needed for the initial heat up, just remove the "OFF" tripper. When the pool reaches temperature, replace the tripper and set timer to run the water pump during the hottest part of the day.

Read your particular timer manufacturers instructions to identify the one you have. Do not attempt to adjust the timer unless you have read these instructions.

COMMON MECHANICAL TIMER

24 Hour Clock Face

ON Tripper Peg

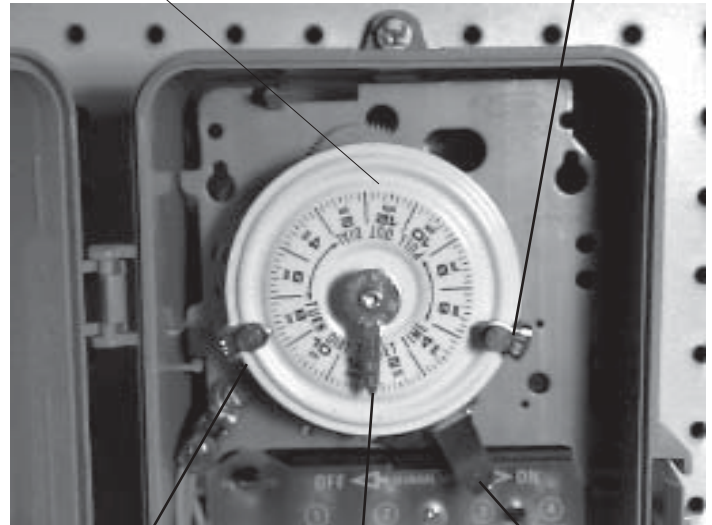

OFF Tripper Peg

Time of Day
Indicator

ON/OFF
Switch

NORMAL RUNNING TIME

The heat pump system extracts the heat from the outside air and delivers it to your pool. Therefore it produces more BTU's (heat) the warmer it is outside. So take advantage of the higher air temperatures during the day by setting the timer for the warmest hours. Winter operation (during cold fronts) may require longer run times up to 16 hours daily.

SET THERMOSTAT TO MAXIMUM

Turn the thermostat dial all the way to the right. You will turn the thermostat back to a lower position later, as described on the next page. The fan should now be turning.

There is a compressor start time delay and generally it will not start for about 5 to 7 minutes. Cooler air will come from the fan when the compressor is running. Become familiar with the compressor sound and remember the compressor time delay.

Scroll compressors may not start on the first try. Allow Scroll type compressors several starts and time delay cycles before the compressor starts. This condition is most common to new compressors or when starting

10 during colder air temperatures.

THERMOSTAT SETTING

There are no temperature reading numbers printed on the thermostat dial due to calibration changes from unit to unit. The demand for exact temperatures should be regulated by using a high quality thermometer right in the pool water. Normal temperatures for pools are 78 to 82 degrees F. Spa temperatures are 98 to a maximum of 104 degrees F.

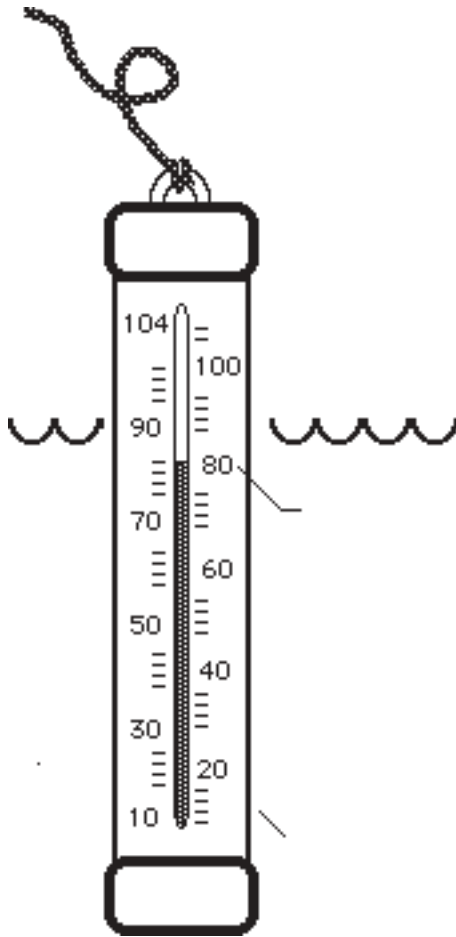

Thermometer

You should place a high quality "tie on type" or a "floating type" thermometer directly in the pool or spa water, so you can determine what temperature that is suitable to you. Check the pool temperature occasionally during the heat up time until it has reached the temperature you desire.

Then go to the heater and turn thermostat counter clockwise, to the left, away from warmer, SLOWLY until the unit just shuts off. Therefore, the thermostat will be set exactly at the current temperature shown on your floating thermometer. Make a mark on the thermostat dial so you know the approximate setting that you desire.

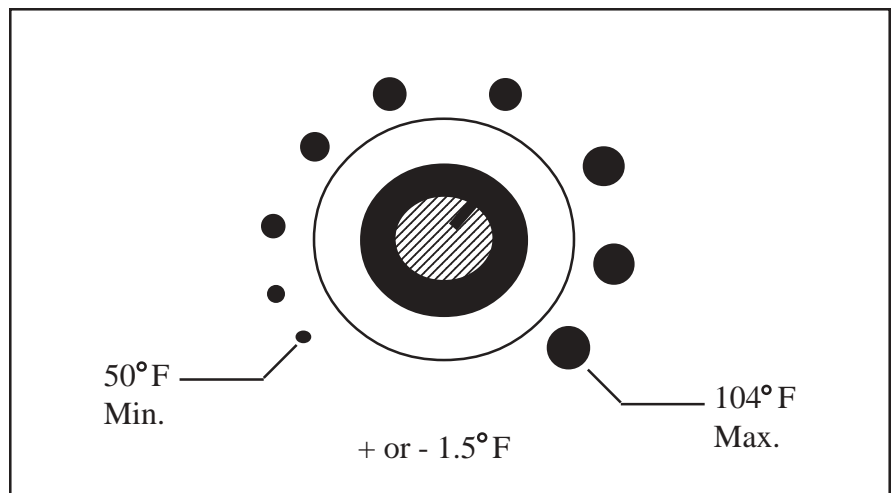

If the pool temperature on the thermometer reads 80 degrees F, and you turn the thermostat to the "left" until the heater shuts off, the thermostat will now be set at 80 degrees F.

Now the heater will come on each day when the circulation pump starts, then it will bring the pool up to that set temperature. The pool will lose some heat overnight but will come back up to temperature with minimal delay. If you have a pool and spa combination, you can set the spa thermostat the same way once you are in the spa heating mode. When adjusting the thermostat, remember that it will take some time for the water temperature to reach a higher setting. The cooler the outside air, the longer heat up time needed.

CAUTION

MAKE SURE YOU ADJUST THE THERMOSTAT BACK FROM THE HIGHEST POSITION SET DURING THE START UP PROCEDURE OR THE POOL MAY GET TOO WARM. BE SURE TO RESET THE CIRCULATION PUMP TIMER FOR 6 TO 18 HOURS PER DAY OR AS NEEDED, ACCORDING TO THE SIZE OF YOUR POOL AND WEATHER CONDITIONS. COLDER CLIMATES WILL REQUIRE MORE TIME. LARGER POOLS WILL REQUIRE MORE TIME. EXPOSED POOLS WILL REQUIRE MORE TIME. WINTER TIME OPERATION WILL REQUIRE MORE OPERATIONAL TIME EACH DAY.

UNDERSTANDING HEAT LOSS

It is important to understand how your pool loses heat. The greatest heat loss occurs at the water surface. You will need to adjust the operational time to compensate for added heat loss during the colder months. See the diagram on the next page. There are four types of heat loss to be concerned with:

Evaporation accounts for the greatest amount of heat loss. As the water changes from a liquid to a vapor it requires heat taken from the pool. You are usually heating the pool when temperatures and humidity are low. The temperature difference between the pool and outside air increase the evaporation rate. Windy conditions will accelerate evaporation heat loss.

Convection is simply the loss of heat due to the cooler outside air moving across the waters surface. Heat moves from hot to cold only, so the warmer pool heat transfers to the moving cooler air. Windy conditions will accelerates heat loss. Pools and spas located on or nearby open area such as the ocean, lakes, fields or golf courses will experience increased wind speeds therefore heat loss will be greater for these conditions. Evaporation and Convection account for as much or more than 82% of the total heat loss.

Conduction is the transfer of heat from the warm pool through the pool or spa shell to the surrounding cooler earth. Conduction only accounts for 5 % or less of the total heat loss. If you live in an area where the ground water surrounds the pool shell and plumbing, this type of heat loss will be greater.

Reradiation is the transfer for heat from the warm pool to the cooler sky. Reradiation heat loss will be at it's greatest on clear nights. Cloud cover will reduce this type of heat loss.

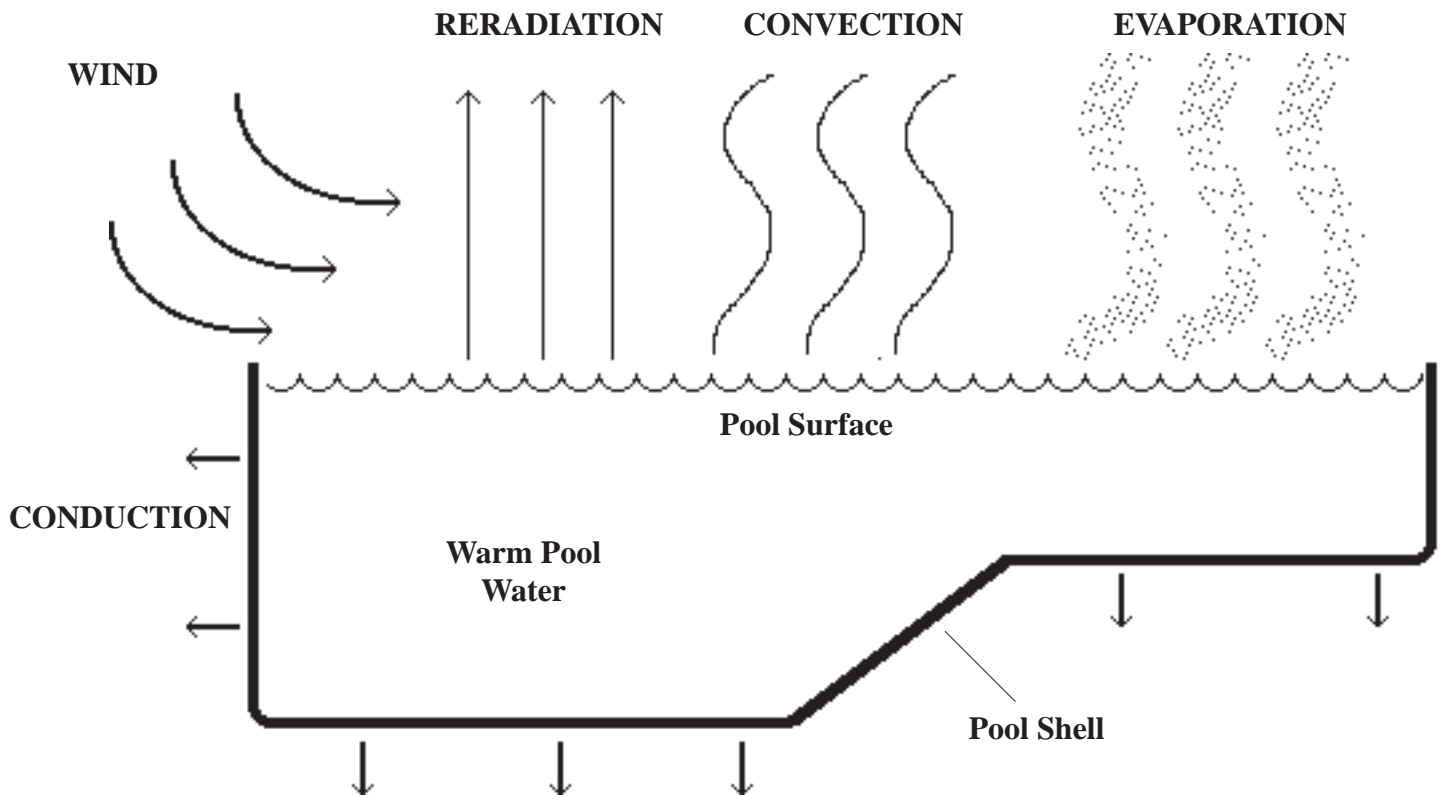

CONTROLLING HEAT LOSS

A good way to control heat loss is to slow the wind speed through your pool area by placing plants such as shrubs or bushes around the pool's perimeter. Plants will break up the air flow and diffuse the wind speed. If the pool area is to be fenced in, choose a wood shadow box type design.

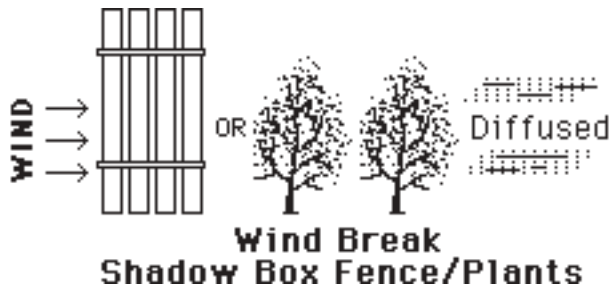

A solid type fence or wall does not act as a good wind break. They tend to create a wind spoil (vortex) across the water surface increasing air turbulence and heat loss. Pools located in windy areas such as water front, golf courses or open fields will experience greater heat loss.

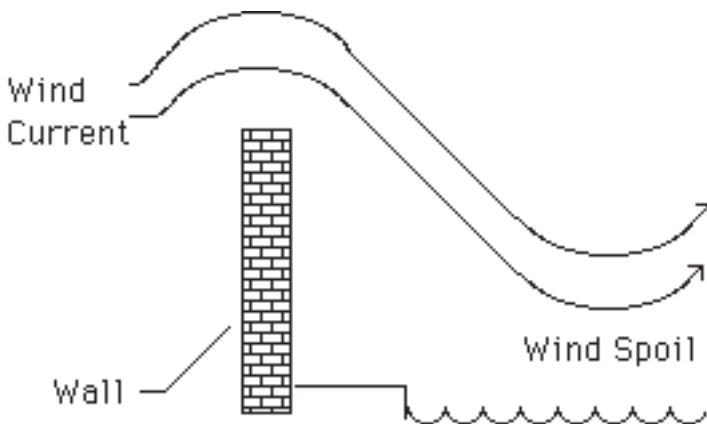

COVERS SAVE TIME & MONEY

As discussed on the previous page, the greatest heat loss is at the water surface. The very best way to reduce heat loss (and operational cost), is to cover the pool or spa.

Covering the pool or spa during the initial heat up time will help the pool get to the desired temperature much faster. If properly used, a cover can lower your total operating costs as much as **50%**. Covers reduce evaporation, thus you will save on pool chemicals and fill water usage as well.

TYPICAL POOL BLANKET & ROLLER

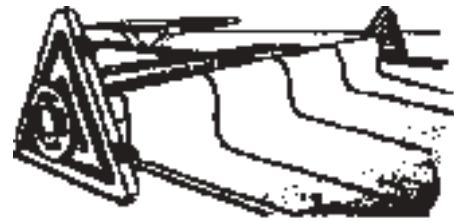

Pool Blanket/Cover
(Shown here with a roller attachment.)

Using a pool cover can be somewhat cumbersome but they are worth the trouble in regards to the great cost savings. Covers are sometimes referred to as blankets or solar blankets.

WARNING

NEVER SWIM WITH POOL COVER ON. Swimmers can tangle easily in the pool cover and subsequently may result in drowning. See manufacturer's Safety Precautions before using.

SPAS HEATING TIPS

It is strongly suggested that you use a cover during the initial heat up time. This will save time as well as electrical costs.

When heating a spa make sure that there are no air bubbles coming from the air blower or hydrotherapy air inlets. The air bubbles will dissipate the heat into the air and prolong the heating time.

Electric air blowers inject cooler outside air into the spa and will lower the temperature. You can shorten the heating time of your spa by shutting off any air injection devices until the spa is up to the desired temperature.

If you have any health problems, high blood pressure etc., consult a doctor before using a hot water spa. You should get out of the spa and cool off every fifteen minutes. Do not consume alcoholic beverages while using the spa. To prevent drowning, do not use the cover while in the spa.

OWNERS MAINTENANCE & CARE

There are some considerations that should be taken concerning the environment where your heater is installed. The heater is usually placed near the pool filtering system. There are certain things in this area you will need to be aware of to insure long life and prevent unnecessary damage.

SPRINKLERS

Make sure there are absolutely no sprinkler heads near the heater that will in any way spray on or into the heater.

Sprinkler damage is not covered under the warranty agreement.



Make sure that they are a sufficient distance away so that normal winds will not carry the mist to the heater. If your filtering system area has plants that need water, use a trickle type irrigation sprinkler instead of the broadcast type.

The heater is designed to handle the wettest weather conditions that are typical of rain and humidity, etc. Sprinkler heads force high pressure water into the unit from the side at an odd angle. Most sprinkler systems are connected to a well system. Most well water is high in minerals, sulphur and other aggressive contaminants. These contaminants will leave a build up on the evaporator coils and electronics causing corrosion and hamper the efficiency. If you are located within 15 miles of the coast, salt may be in the well water also.

PLANTS

Plants in the installation area should be kept trimmed away to the proper clearances shown here. Plants too close to the heater will restrict the air flow into the unit from the side as well as air flow through the top. Plants also bring extra moisture and insects that may get inside the unit. There should be enough clearance to easily service and adjust the heater.



CAUTION

Chemicals should NOT be stored near the heater. The fan may draw corrosive chemical vapor through the unit causing damage. Do NOT store anything on top, underneath or around the heater. You will need access to the disconnect breakers in the event of an emergency.

CONDENSATION DRAINS

The unit will produce a condensation of water that will drain from the unit at a steady rate. This condensation is from the humidity in the outside air. The more humidity, the more condensation the unit will produce. There are several drain ports in the bottom of the unit, make sure they do not become clogged with debris. This condensation will attract weeds and insects, make sure that the water drains properly and plants are kept trimmed. (Heat and Cool Models) In the cooling mode this unit will produce no condensation.

The air handling compartment below the fan should be cleaned and vacuumed to remove debris that may clog the condensation drains at the bottom of the heater. Accumulated debris will clog the condensation drains causing the water to pool in the bottom of the heater. Accumulated condensation water will cause corrosion to the heaters components.

AIR FLOW

Do not install the unit in an area where the cooler discharge air may accumulate and be drawn back into the unit. Provide ventilation through containment walls or fencing for the air intake if needed. Do not install this unit indoors or in filtering system equipment rooms. Do not restrict the air flow in any way.

ROOF RUN OFF

To prevent large amounts of rain water from running through the unit you may need to install a gutter and down spout when the roof has a sharp pitch. **IMPORTANT: Do not allow roof run off water to rush through the unit.** Do not install the unit under roof valleys, where two roof sections meet. The two roof sections channel water to the valley and will allow massive amounts of water to run through the unit at high velocity.

CLEANING

To clean the heater, you should take a sponge and mild soapy water and wipe the surfaces clean. Do not use a pressurized garden hose to clean the heater. Never force water into the unit from any direction. You may use a garden hose at low pressure with no nozzle attachment. Clean the evaporator coils at least twice a year. If you live near the sea coast you will need to clean at least four times a year to remove salt and sand. Use a very soft brush with soap and gently remove any build up. Clogged evaporator coils will reduce the efficiency of the unit and cause corrosion. Use a fin comb to straighten any minor indentations in the evaporator coils

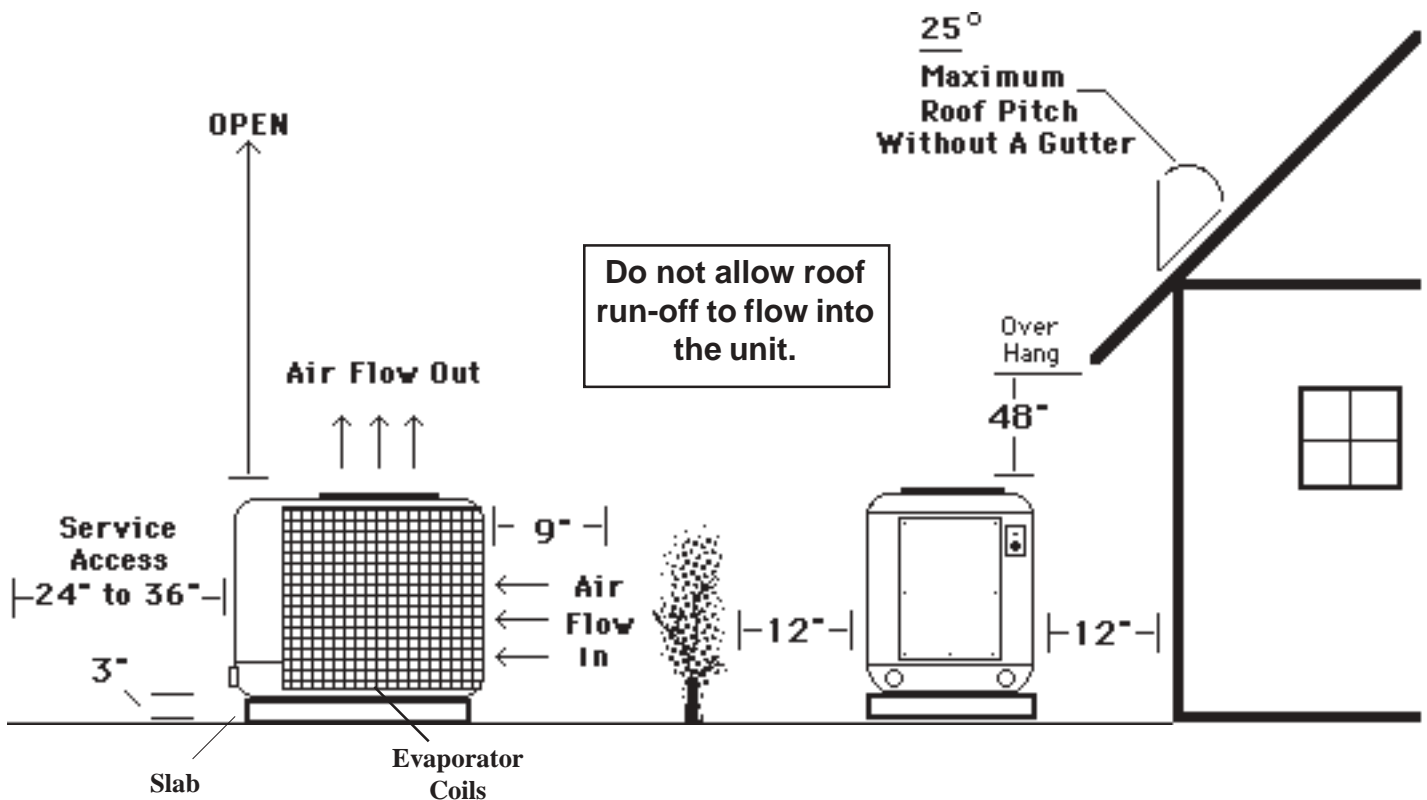

WATER PIPING LEAK ?

When the unit operates, it will produce condensation that will drain from the bottom of the unit. Do not mistake condensation with a water piping leak. There is a certain procedure to follow to check the unit for leaks: Shut the heat pump and filtering system off. Allow all the condensation to drain from the unit for at least an hour or so. Then start the circulation pump only, leave the heater off. If the unit is still leaking water steadily, you may have a water piping leak. The unit should not condensate when the heater is off. Consult your dealer.

FILTER SYSTEM MAINTENANCE REQUIREMENTS

WATER FLOW

Proper water flow is critical to the heaters performance and longevity. The maintenance of your filtering system is directly related to the proper operation of the heat pump. See pages 8 for other information regarding filter cleaning and the start up procedures.

CIRCULATION PUMP

The circulation pump must be kept in good working order to provide a steady rate of flow to the heater and filtering system as a whole. The circulation pump must be producing a flow rate in accordance with the manufacturers specifications within 10%. The pump should run with a "full prime" without excessive restriction on the vacuum and pressure side of the filtering system.

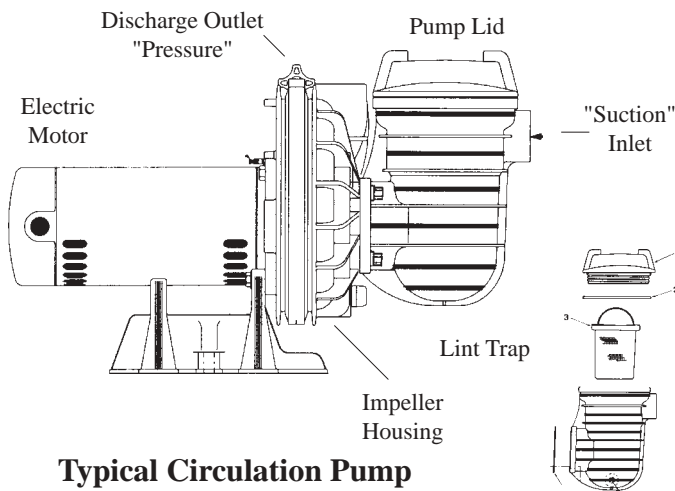

Typical Circulation Pump

VACUUM & PRESSURE LEAKS

All vacuum and pressure leaks in the filtering system must be eliminated immediately after occurring. Air allowed into the filter system from the vacuum side of the circulation pump will cause premature wear and physical erosion to the heat exchanger and water piping inside the heater. Air turbulence will cause the water pressure switch to malfunction.

Pressure leaks on the filtering system will allow the system to lose vacuum and cause the water in the filter and piping to back siphon or reverse flow through the system when the circulation pump is off. Reverse flow may cause the water pressure switch to malfunction.

CHLORINATORS

See chlorinator placement and chemical use guidelines.

FILTER CLEANING & CARE

Your filter system should be cleaned at least twice a month. See manufacturer's directions for proper filter cleaning methods. Size and conditions may require you to clean the filter more often. A filter is considered "dirty", whenever it restricts the flow rate by 10% or more.

You can use the pressure gauge on the filter tank to determine a restriction in the filter due to clogging. After the filter has been replaced or when it is new, you should record the actual operating pressure with a "clean filter". When the pressure increases more than 5 p.s.i., the filter should be cleaned. If the pressure does not return to normal you must replace it. Make sure your pressure gauge is kept in good working condition.

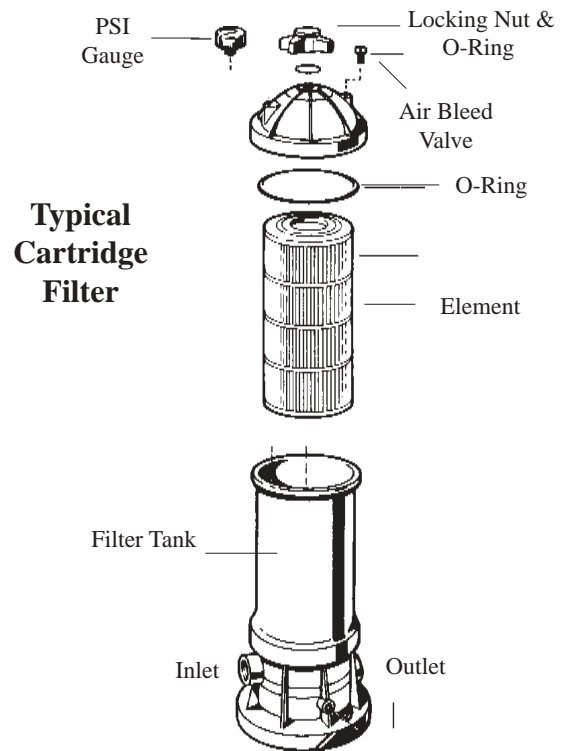

Typical Cartridge Filter

There are some after market filter element cleaning solutions that will help remove oil and minerals that may clog the filter. Oil and minerals can not be removed with normal cleaning and back-washing. Spas are particularly susceptible to oil build up in the filter. Do not acid wash a filter until you have removed all oil and grease with a solution designed to remove such. Acid washing a filter with oil in it will cause that oil to become permanently embedded in the fibers. Cartridge filter element replacement is suggested every 1 to 2 years. Sand filters should have the sand replaced every 3 to 5 years. D.E. type filter elements should be removed and soaked in a solution at least every two years.

AUTOMATIC POOL VACUUMS

Automatic pool cleaners will decrease the water flow by restricting the suction of the circulation pump. Most automatic type pool cleaners operate from the suction provided by the circulation pump.

Some automatic pool vacuums are plugged into the skimmer suction port. The main floor drain is then restricted some, so that the auto vac has enough vacuum to operate. It can then move freely and not become stuck to the main drain port.

**Typical
Automatic
Pool Cleaner**

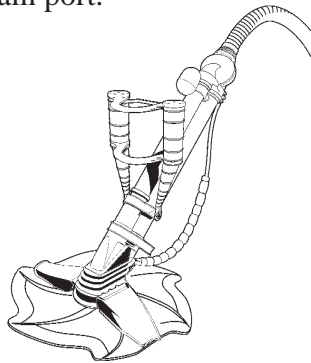

Often times, when these auto vacuums begin to wear, they require more suction from the pump to operate. Diverting all vacuum through the auto vac may help it run better but will restrict the overall water flow through the entire system and the heater.

If you have a low water flow situation where the heater is not getting enough water through the condenser coil, remove the pool vac and open all skimmer and main floor drain vacuum valves to provide maximum flow.

The auto vac manufacturer has a special valve that plugs into the skimmer before the auto vac hose. These special valves will properly regulate the water flow through the auto vac without creating too much vacuum restriction on the skimmer suction port.

The hose connecting the auto vac to the skimmer should be checked for the presence of suction leaks that allow air into the system. (See damage caused by vacuum leaks previously). As the auto vac hose gets older and sun damaged, it may develop an air vacuum leak or known as a "suction leak".

In all cases, you should do what ever necessary to gain the proper water flow through the heat exchanger. Once the pool vac is working, make sure you have the proper water flow through the heater at all times. If the low flow created by an auto vac is causing a problem with the unit, it is not considered a warranty condition.

CAUTION

When manually vacuuming the pool or performing service to the filtering system, **"shut the heater off !"** When the vacuum hose is plugged in, it may cause the pump to loose prime due to the air in the hose. You may also need to restrict the main drain suction port to gain more vacuum to the vacuum hose and head. This will lower the overall flow through the unit and cause it to cycle on & off, possibly causing damage. Shut the heater off whenever there is a chance of restricted water flow or loss of prime.

PROFESSIONAL SERVICE

As part of routine maintenance you should schedule a licensed air conditioning contractor or the factory service department to check the refrigeration circuit and components of the heat pump against factory specifications. An improper adjustment or diagnosis by others may limit your warranty. You can call the factory service department for a list of factory authorized service centers in your area. Have all the refrigeration components checked against the factory specifications. You can request this information from the factory service department.

Verify correct installation according to the owners and installation manuals. Verify water flow through the heat exchanger and filtering system. Check all chlorinator placement and pool water balance. Test the supply voltage, amperage draw, wire size against factory specifications and local codes. Test the operating refrigerant pressures and corresponding components to factory specifications. Adjust refrigerant according to the sub cooling reading and factory specification.

Clean and flush the evaporator coils to remove debris, salt and mineral build up at least twice a year. Clean more often if you live in a costal and or sandy environment. Clean them with a mild soap and a very soft brush. Do not use a pressurized garden hose. The air handling compartment below the fan must be cleaned of debris regularly. Contact an air conditioning contractor for proper methods of cleaning the evaporator coils. Remember to make sure the irrigation sprinkler system does not spray on the unit!

The fan motor should be oiled when the unit is serviced otherwise once per year or more if needed. Coastal installation should oil the fan motor 4 times per year or

17 more depending on exposure.

PLUMBING & WATER FLOW

PLUMBING CONNECTIONS

Filtered Water "IN" on the LEFT front.

Heated Water "OUT" on the RIGHT front.

The plumbing inlets are "slip" p.v.c. pipe that will accept a 2 inch p.v.c. glue fitting. The pipe is left plain so you can adapt to your needs. Use p.v.c. cleaner to prime the fitting and pipe. Use a quality medium body p.v.c. glue.

FOR PUMPS UP TO 2 H.P. OR 90 G.P.M. MAX.

SEE PAGE 19 FOR LARGER WATER PUMPS.



WATER IN

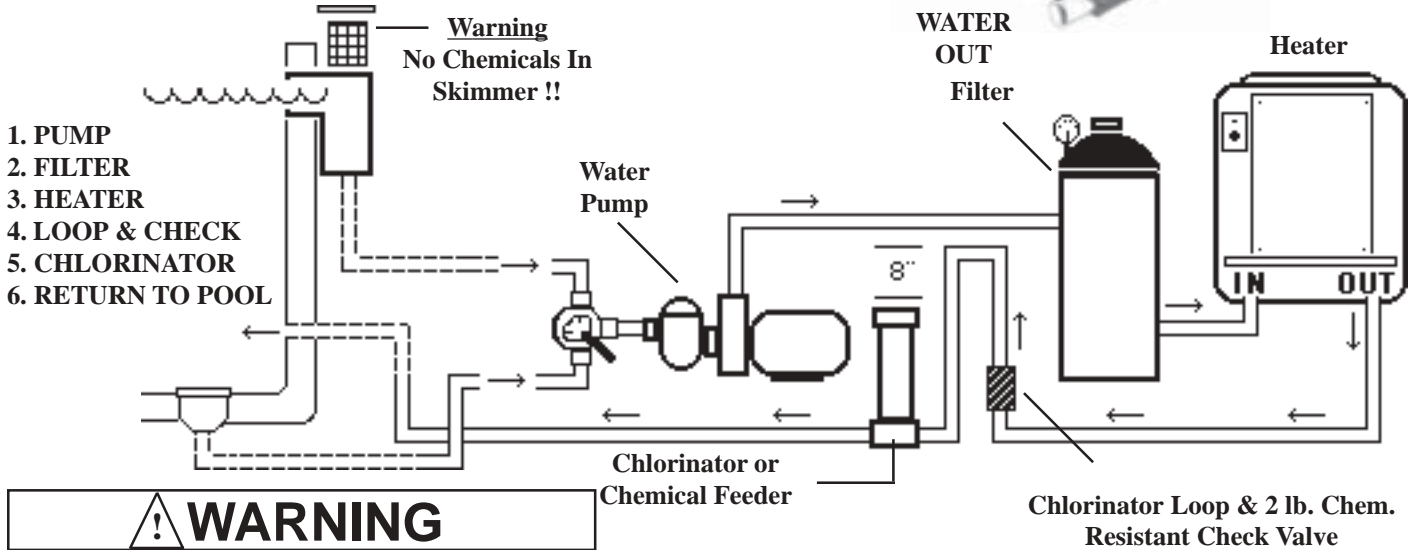

! WARNING
See mandatory chlorinator placement and install of the loop & check valve.

INTERNAL AUTOMATIC BYPASS

The heat pump is equipped with an internal "Automatic Bypass" valve. A variable rate spring valve is used to regulate the water flow through the heat exchanger. Steady flow will be delivered over a wide range of flow rates. This automatic valve can handle a maximum flow rate of 90 gallons per minute.

The automatic valve will compensate for flow loss due to normal filter debris accumulation or changes in flow due to valving and other conditions.

See chlorinator placement guidelines.

Automatic Bypass Valve
Variable Rate Self Adjusting
up to 90 G.P.M.

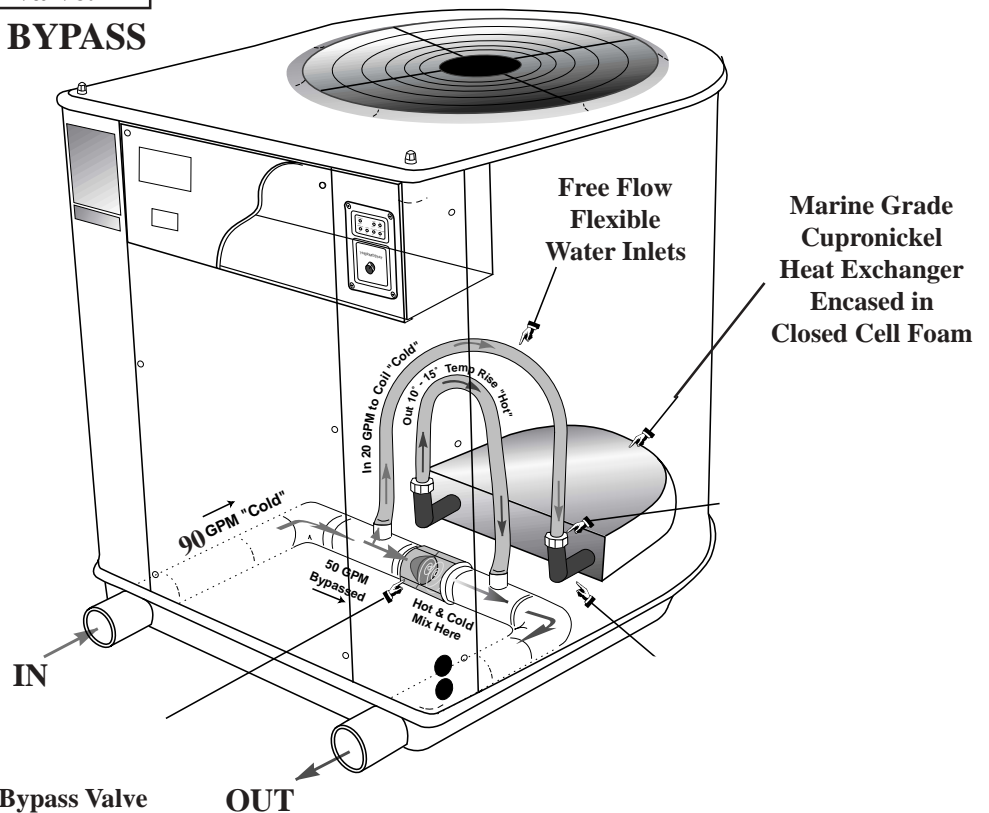

HIGH RATE WATER PUMPS

EXCESSIVE FLOW BYPASS MANIFOLD FOR LARGE 2 H.P. PUMPS OR OVER 90 G.P.M.

If the pool circulation pump is over 2 HP OR if the total flow exceeds 90 GPM you will have to add the "excessive flow valve" as shown here. Do not install a bypass valve that will completely shut off flow to the heater, see shut-down procedures.

Some larger water pumps may be restricted if the pipe size is not adequate therefore reducing its overall flow rate. When determining if you need an excessive bypass valve, one has to consider the hydraulic restriction of the filter, valving, amount of 90° fittings and the distance of pipe to the pool in the existing filtering system. If you have a 2 HP water pump that does not exceed 90 G.P.M. considering the above, you may not need the excessive bypass. **Excessive water flow can damage the heat exchanger. SPECIAL NOTE: See chlorinator placement instructions at the bottom of this page.**

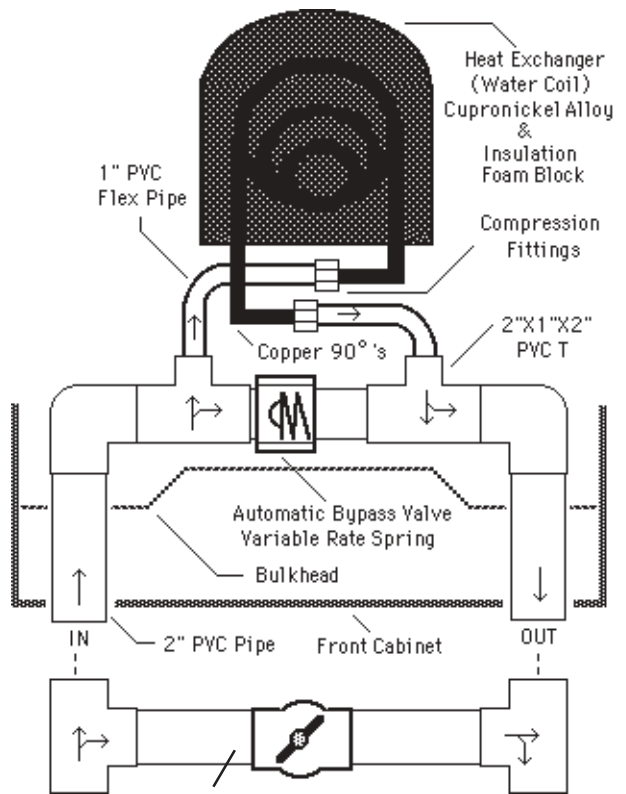

"Excessive Flow Valve Manifold"

Do not valve in a manner that will totally isolate heater from water flow see page 25.

! CAUTION

BE SURE THE BYPASS VALVE IS POSITIONED TO ALLOW REMOVAL OF THE FRONT ACCESS PANEL!

Position the valve so that the access panel can be easily removed, always check before final gluing. Angle the valve out 45° to provide adequate clearance. You may use a 2-way valve or other type if desired. **"Do not" use a brass gate valve or a 3-way valve for bypass !**

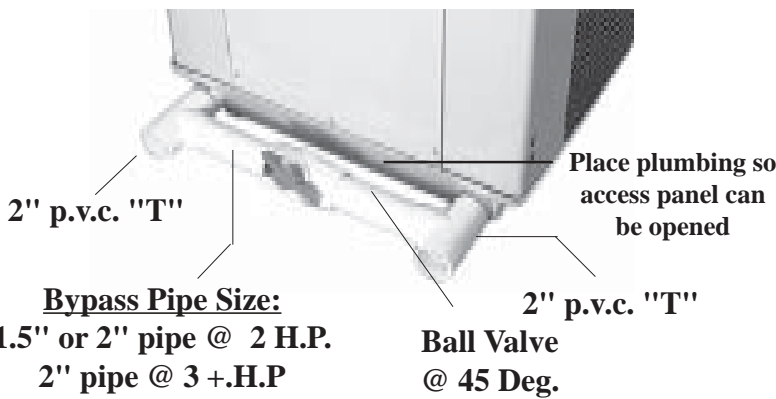

- 2 H.P Pumps Close Bypass 50%

- 3 H.P. Pumps Close Bypass 25%

All others must be set by flow meter.
See Commercial Plumbing Diagram

! CAUTION

Exercise care when installing chemical feeders so as not to allow back siphoning of chemicals into the heater, filters or pump.

The chemical resistant check valve and loop must be installed with all types of chlorinators to prevent chlorine migration to the heater. The loop should extend at least 8 inches above the chlorinator top. The chemical resistant check valve should be placed on the pipe leading "up" to the chlorinator. Therefore, the weight of the water above the check valve will hold it closed even if the spring is weak or damaged. Mount it as low as possible. Be sure to keep the chlorinator, pump and filter lid o-rings lubricated with silicone grease to insure a good seal. If it loses its seal, it will allow the chlorine to migrate to the heater when the system shuts off. The loss of vacuum allows reverse flow.

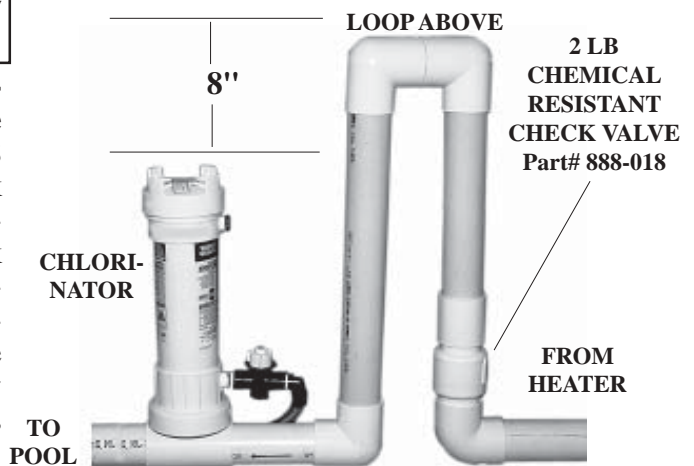

WATER BALANCE MAINTENANCE

The chemical balance of your pool/spa water and the methods used in adding pool chemicals will directly effect the life of your heater. Like no other precaution you could take, it is very important that these guidelines are followed in order to prevent damage to the heat exchanger/water coil and possibly the entire system.

Improperly maintained water balance and incorrect introduction of pool chemicals will cause extreme corrosion to the heat exchanger. If this condition goes unnoticed, it will eventually damage the compressor and evaporator coil. The heat exchanger in your unit is made of the highest quality cupronickel metal alloy. This makes the heat exchanger as chemical resistant as possible. The heat exchanger will withstand what is considered normal pool water balance. Unfortunately, chemical damage is usually diagnosed after the unit has failed because the corrosive pool/spa water attacks the metal from the inside out.

! WARNING

Chemical damage to the unit and / or heat exchanger in any way is not covered under the warranty agreement.

The following are water balance specifications that are considered standard pool and spa water testing values and quality. These water balance values are the industry standard in which professional pool contractors follow. Make sure your pool water is tested and balanced on a weekly basis or more if required. Spas will need extra attention. See your local pool dealer for help in properly balancing the water chemistry.

STANDARD POOL WATER BALANCE REQUIREMENTS

- Ph.....7.4 to 7.8
- Chlorine/Bromine.....1 to 5 ppm
- Total Alkalinity.....90 to 120 ppm
- Calcium Hardness.....250 to 400 ppm

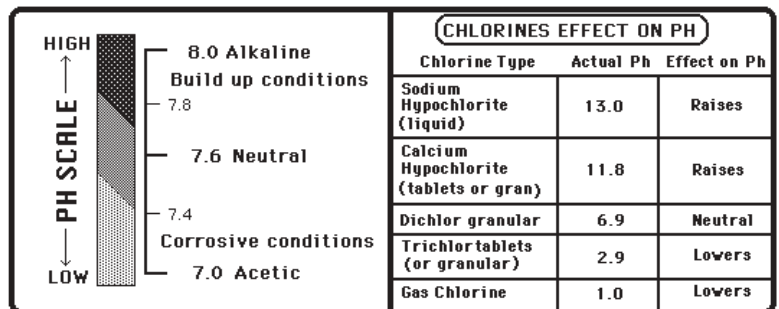

ADVANCED HEAT EXCHANGER DESIGN

This diagram is a cross section of the heat exchanger. The seamless tube within another tube design transfers heat very efficiently. The inner water tube is made of thicker resilient cupronickel metal alloy to help resist corrosive pool water. The outer heavy gauge Freon™ tube is dipped in a special weather proofing material. Then to insulate from heat loss and help prevent exterior corrosion the heat exchanger is encased in a block of special closed cell foam.

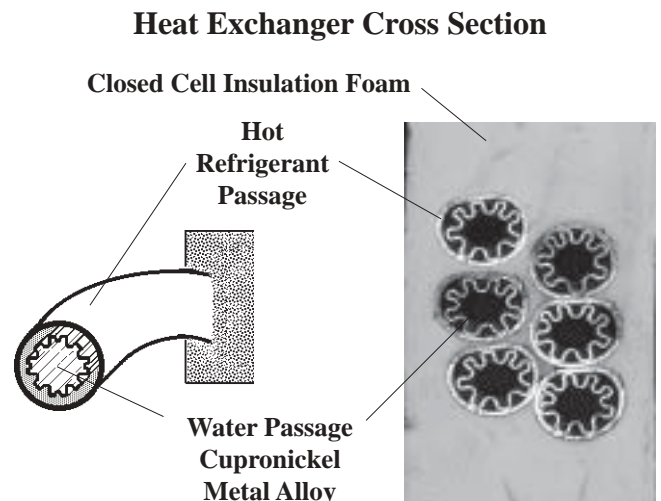

These chemical outlines should not be considered as a “how to” balance your pool/spa water, but just a reference on how chemical balance effects the heater and gives suggested test values. You should always consult a pool professional and follow all chemical manufacturers directions, unless they conflict with this manual.

CHLORINE

Chlorine levels should remain within a range from 1 p.p.m. to a maximum of 5 p.p.m. (p.p.m.=parts per million). Excessive chlorine saturation of the pool water will cause corrosive damage to the heat exchanger.

Chlorines Effect on pH

Review the diagram on the previous page. Some tablets, granular and gas forms of chlorine have an acetic nature to start with and may lower the pH of the water when introduced (see diagram on previous page). Be sure that the pH remains between 7.4 and 7.8 after adding chlorine. If these types of chlorine are introduced into the system in the wrong place, you can run full strength chlorine through the heat exchanger before it has a chance to mix with the rest of the pool water. See the next section on chemical usage and chlorinator placement.

Shock Treatments

A shock treatment is a large dose of chlorine added to the pool water all at once to reduce the amount of combined (contaminated) chlorine in the water or to kill algae. Make sure you do not over shock treat, calculate the exact amount of chlorine needed. When “shock treating” the pool make sure that the pH levels remain at the prescribed levels after the chlorine is introduced. Do not add any more chlorine to the water until the chlorine levels have dropped to normal. Prolonged high chlorine levels will cause damage to the heat exchanger. The combination of high chlorine and low pH (acetic) will deteriorate the heat exchanger at an accelerated rate. Do not add shock treatment or chlorine tablets in the skimmer.

Read and follow the chemical manufacturers directions when adding chemicals unless they conflict with this booklet. Contact your dealer or the factory service department for advice.

pH

The **pH** level in your pool should be maintained within the range of 7.4 to 7.8. A pH test will tell you how acetic or how alkaline the pool water is. For example, acetic like orange juice or alkaline like milk. A 7.6 pH is considered the middle of the road. Lower than 7.6 means that the water has an acetic tendency. Higher than 7.6 indicates that the water has alkaline tendency.

pH Below 7.4 Will...

A lower (acetic) pH reading will cause corrosion to the heat exchanger. Prolonged exposure to low pH and / or high chlorine will damage the heat exchanger. The lower the pH the more aggressive the chlorine is and the quicker the damage takes place. The metal is oxidized and deteriorates.

Piping Leaks & Stains

An early indicator of low pH and / or high chlorine would be if a leak were discovered in the piping leading to the heat exchanger. The copper in the piping will dissolve into a solution and mix with the pool water. This dissolved metal will show back up as a blue-green colored stain on the masonry materials in your pool. The commonly used, white plaster (Marcite) finishes will stain from the metal in the water quite easily.

Although there will have already been some chemical damage. You can make corrections immediately to protect the very expensive cupronickel heat exchanger. Follow the chemical guidelines in order to prevent such damage from occurring. Do not wait until you see the metal stains or piping leaks.

pH Above 7.8 Will...

If your pool water is extremely high in pH (alkaline), you may get a mineral build up in the heat exchanger and piping. Restriction from build up will restrict the water flow to the heater. This condition is very rare except where mineral content is high in the tap water used for the pool.

TOTAL ALKALINITY

Total Alkalinity is a test given to determine the overall mineral content of the water. Total alkalinity levels should be within the range from 90 p.p.m. to 120 p.p.m. The total alkalinity is described as a buffer against acetic conditions and acts as a stabilizer for the pH. It keeps the pH from fluctuating up and down. A low alkalinity will allow the pH to fluctuate, usually to the acetic side. A high alkalinity may cloud the water. The pH of your water will change when it is used after rain, from dirt and debris and many other natural conditions. The proper total alkalinity will prevent those changes from being drastic. Test for total alkalinity on a weekly basis.

POOL CHEMICAL & CHLORINATOR USE

When you are adding pool chemicals as part of your regular maintenance there are several rules of thumb to follow. Where you add the chemicals are just as important as how much you add. This section will discuss the "do's and don'ts" of where you add chemicals or where chlorinators are placed.

PROTECT HEAT EXCHANGER

You want to prevent any chemicals from running through the piping and heat exchanger of the unit. Chlorine solution will damage the heat exchanger. Some chlorinating devices inject chlorine solution through the suction side of the filtering system, thus the chlorine passes through the heat exchanger at full strength before it has a chance to mix and dilute with the rest of the pool water. Also note: The overall chemical balance of the pool water will directly effect the life of the heat exchanger.

CHLORINE MIGRATION

Some chlorinating devices will back siphon when the system is shut off, therefore allowing the chlorine solution to migrate through the heat exchanger causing damage. You have to make sure your filtering system does not have a vacuum leak that would allow the system to lose prime. When this happens, water will move backwards through the chlorinator thus moving the chlorine solution into the heat exchanger. Note: Chlorine solution is heavier than water and will migrate through the plumbing even if there is no vacuum leak.

CALCIUM HARDNESS

Calcium Hardness levels should remain within the range from 250 p.p.m. to 400 p.p.m. Calcium hardness is a test that determines the saturation levels of calcium and magnesium salts in the water. This tells you in layman terms how "hard" the water is. Please refer to your pool builders instructions concerning calcium hardness and how it effects your particular pool surfacing material.

VACUUM LEAKS

Suction leaks that allow air into the system when the pump is running will cause damage to the heat exchanger. Suction leaks are what cause the system to back siphon or reverse flow. Make sure that all the o-ring seals in the pump lid, filter and chlorinator are in good condition and are lubricated with silicone grease.

If your filter repeatedly has excessive air inside it when you open, air the bleed valve, you may have a vacuum leak. Vacuum leaks that allow an accumulation of air in the filter and will cause the system to lose prime when the pump is off and allow reverse flow. Reverse flow may allow chlorine solution to migrate to the heat exchanger.

Vacuum leaks will cause premature wear to the heat exchanger. The air allowed into the system causes turbulence in the heat exchanger. The result is physical erosion to the metal alloy water channel.

Note: Chlorine solution is heavier than water and will migrate through the plumbing even if there is no vacuum leak.

CHLORINATOR PLACEMENT

1. All chlorinators should have a chemical resistant check valve and a loop plumbed at least 8 inches above the chlorinator, between it and the heater, as far down line from the heater as possible.
2. Never plumb a chlorinator into the suction side of the circulation pump. All automatic chemical feeders should be as far down line of the heaters water flow as possible.
3. Off line type chlorinators should be tapped into the plumbing only as shown on the diagram. See pool/spa combinations requiring special placement. See plumbing diagram.
4. Never install a chlorinator at a higher elevation than the lowest heater piping even if a loop check valve is used. Doing so may allow chlorine to migrate to the heat exchanger, causing damage.
5. Do not allow floating chlorinators to be drawn up to the skimmer inlet.
6. Keep the chlorinator lid o-ring lubricated with silicone grease. Replace when needed.

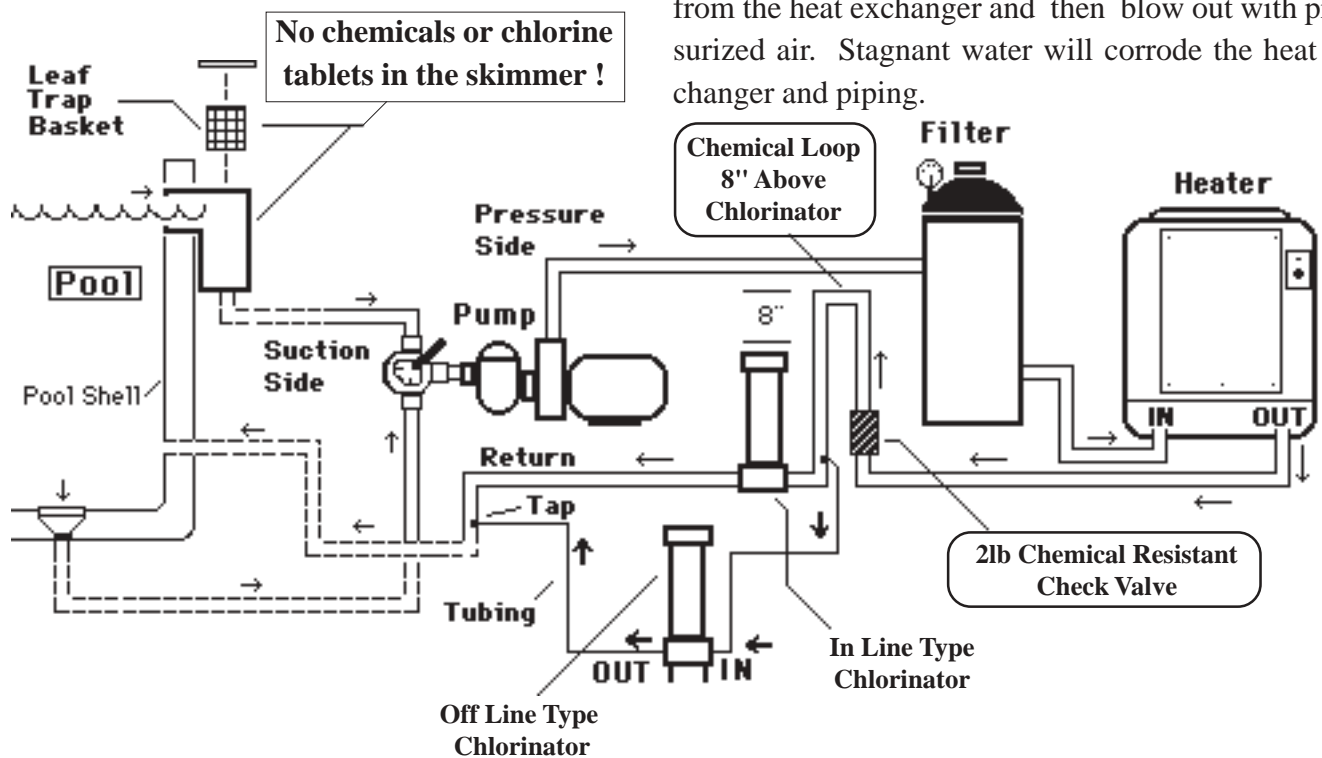

See plumbing & water flow and high rate water pumps for more information.

ADDING CHEMICALS

⚠ CAUTION

Absolutely no chemicals in the skimmer !

Do not place any chemicals in the skimmer throat. Chlorine tablets placed in the skimmer will allow a concentrated solution of chlorine to pass through the heat exchanger causing damage.

7. Do not place any chemicals in the pump lint trap cavity or filter. Make sure the lint trap basket is placed properly to prevent debris from clogging the heat exchanger.
8. Do not over load chlorinator feeder cavity. Excessive amounts of chlorine tablets will increase the chance of migration of acetic, concentrated chlorine to migrate to the heat exchanger causing damage. 25% of maximum is suggested.
9. When adding gas chlorine make sure that the pH does not drop below 7.4. Make sure that the total alkalinity does not drop below 90 p.p.m. Gas chlorine is very acetic.
10. Do not isolate the heater from the water flow unless you have installed a drain plug to drain all the water from the heat exchanger and then blow out with pressurized air. Stagnant water will corrode the heat exchanger and piping.

COMMERCIAL FEEDERS

We strongly suggest that all chemical feeders be placed "down line" of the heater. In a "closely monitored" commercial pool situation where a vacuum type filter system is used in conjunction with a surge tank, there are some exceptions to chemical injection. Some liquid chlorine (sodium hypochlorite) feeders and liquid muriatic acid feeders will inject their solutions into the surge tank on the suction side of the unit. You may inject diluted liquid chlorine and muriatic acid as long as each are diluted with 75 % water in the supply tank. The feeders must be adjusted to a slow enough rate to prevent the water in the surge tank from dropping below 7.6 pH and or chlorine levels above 5 p.p.m. You can test the surge tank water while the feeders and circulation pump is running just as you would the pool water. Then adjust the solution or rate of feed accordingly. The circulation pump usually moves the water through the surge tank rapidly enough to keep chemical concentrations down. Never place chlorine tablets in the surge tank.

Also note: Electric type feeders must be electrically relayed to the circulation pump, so the feeders will shut off when the pump does.

CHEMICAL APPLICATION FOR SPAS

Spas require some special attention due to their small water volume and high heat compared to a normal swimming pool. A spas water balance fluctuates more rapidly than a pool. The following are suggestions that we feel will prolong the life of the heat exchanger used for a spa heater.

1. Test the water frequently to prevent drastic fluctuations in pH and sanitizer levels especially after usage. Keep total alkalinity at 100 p.p.m. to 120 p.p.m.
2. Spas react quickly to chemicals when added. Use small amounts and retest the water until you reach the desired chemical values.
3. Some chlorine tablets are very acetic and will lower the pH of the spa water as the solution is fed. Make sure the spa water does not drop below 7.4 pH, see page 20 and 21 for more information.
4. Bromine has a more neutral pH value and works well in spa water if pH is maintained at 7.8-8.0. It is a form of chlorine widely used for spas. Do not install a brominator on the suction side of the filtering system.

WARNING

Working with muriatic acid can be dangerous. When cleaning elements always wear rubber gloves and eye protection. Add acid to water, do not add water to acid. Splashing or spilling acid can cause severe personal injury and/or property damage.

5. Using muriatic acid right from the bottle at the same strength as packaged may drastically lower the pH uncontrollably. There are some dry powdered forms of acid that work better for spas and are somewhat milder and are easier to handle.
6. All the same rules of chemical application and chlorinator placement that apply in the previous chemical section also apply to spas. Always consult a professional pool builder or service and follow the chemical manufacturers directions.

SHUT DOWN & FREEZE PROTECTION PROCEDURES

When shutting the unit down for the end of the swimming season, you must consider some items to protect the unit from inclement weather. It is best in most situations to shut the unit off by turning the thermostat all the way down, to the "left". **Leave power (circuit breaker), to the unit "on" unless the pool or spa water temperature drops below 50 degrees F.**

SHORT TERM FREEZE PROTECTION PROCEDURES

When the outside air temperature is forecast to drop below 32 degrees F for a short time:

You should set the circulation pump timer to run 24 hours per day in order to circulate water through the unit and filtration system. Standing water inside the piping will freeze and damage the water heat exchanger and refrigerant system. Shut the heat pump off and do not try to heat the pool during freezing temperatures. If the unit is left running it may ice up and the compressor will stop running. The defrost control inside the unit will shut the compressor off, but allow the fan to run. The fan will circulate air through the unit to help defrost the evaporator air coil. If you know that the temperatures are going to be below 36 degrees F, you should eliminate the possibility of icing and just shut the unit off. Do not use the circuit breaker as the "on/off" switch, if you want to shut down for a long period of time use the disconnect. (See page 27)

LONG TERM FREEZE PROTECTION / DRAIN VALVE INSTALLATION

If you live in a climate that has a seasonal swim season due to winter, you should follow these long term freezing procedures.

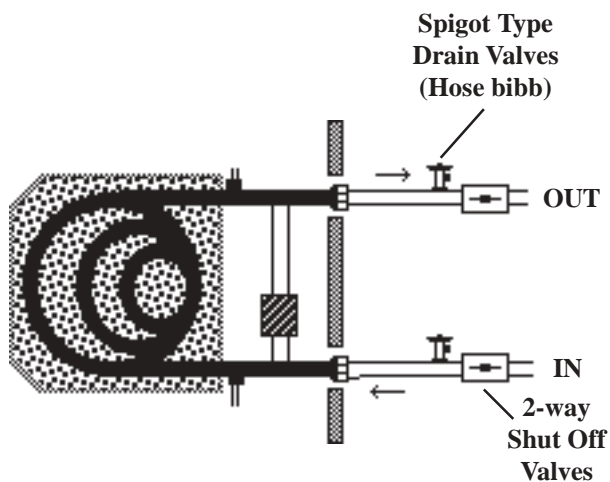

Shut the water pump off. Close both shut off valves. Open both drains and allow water to exit. Use pressurized air on the water in, one spigot only, to force the rest of the water out the other spigot.

If you live in an area that experiences freezing temperatures, the heat exchanger/water coil and bypass plumbing must have all water removed to prevent freeze and chemical damage to the heat pump system. This procedure should be done prior to the first freeze along with your other pool winterizing routine. When you drain the filter system and piping you should include the heat pump as well.

There should be two spigot type drains, (hose bibbs), plumbed into the heater's water in and water out piping. Place these valves as close to the heater and at the lowest point possible so as much water will drain as possible. Install two shut off valves on the water in and out lines as shown here. The rest of the water should be blown out with pressurized air to insure all water is removed. A antifreeze designed for pool equipment may be used, see a local pool professional.

CAUTION

Do not add isolation valves unless you intend to clear the heat exchanger of water with pressurized air! Stagnant water left in the heat exchanger can cause corrosion and will freeze causing damage!

OWNER TROUBLE SHOOTING GUIDE

WARNING



Risk of electrical shock or electrocution.

Improper installation will create an electrical hazard which could result in death or serious injury to pool users, installers, or others due to electrical shock, and may also cause damage to property.

Do NOT attempt any internal adjustments inside the heater.

1. Keep your hands and hair clear of the fan blades to avoid injury.
2. If you are not familiar with your pool filtering system and heater:
 - a. Do not attempt to adjust or service without consulting your dealer, professional pool or air conditioning contractor.
 - b. Read the entire Owner and Installation Manual before attempting to use, service or adjust the heater or pool filtering system.

CONDITION	POSSIBLE CAUSE	POSSIBLE REMEDY
All control lights off. Unit will not start.	No power supply to heater. Tripped breaker or blown fuse. Control failure.	Reset breaker. Replace fuse. Call dealer for advise. Call factory for advise.
Control Ready light ON. Water Press. OK light OFF. T-Stat On light OFF. Low & High Press. lights OFF. Unit will not start.	Low water flow through heater. Dirty or worn filters or clogged lint traps. Clogged filter pump impeller. Improper plumbing valve settings. Suction leak allowing air into the water flow. Internal water pressure switch failure.	Clean entire filtering system and or replace filter element. Inspect & clean pump impeller. Adjust plumbing valves. Repair suction air leaks, grease pump lid o-ring. Replace filter. Replace water pressure switch.
Control Ready light ON. Water Press. OK light ON. T-Stat On light OFF. Low & High Press. lights OFF. Unit will not start.	Thermostat is not set higher than the pool/spa water temperature. The water temperature has reached the maximum setting. The thermostat is malfunctioning. (Dual thermostat), the pool spa select switch is not in the correct mode.	Turn the thermostat up to the "right" more. Use a high quality thermometer to test the water temperature. Maximum water temperature is 104°F + or - 3°F. Call your dealer for advise. Call the factory for advise.
Control Ready light ON. Water Press. OK light ON. T-Stat On light ON. Low Press. light OFF. High Press. light OFF. Unit will not start. OR Unit is forming ice or frost on the outer air coil, usually at the bottom.	Outside air temperature below operating range of 45°F, unit is in "defrost" mode. Discharge air flow is restricted. Discharge air is accumulating and being drawn back through the outer air coil. The fan is obstructed, low air flow. Large amounts of roof run off water restricting fan blade rotation. Sprinklers spraying on the outer air coil during cooler temperatures. Outer air coil clogged with debris. Plants too close to heater, blocking air flow. Low refrigerant pressure caused by a Freon™ leak. Possible malfunctioning of the internal low refrigerant pressure switch.	Do not try to operate the heater when the outside air temperature drops below 36°F and 45°F with very high humidity or high wind speed. Make sure heater is installed with the required placement clearances for air flow and roof clearance. Do not install indoors. Make sure that your sprinklers do not spray on the heater in any way what so ever. If ice forms on the outer coil, shut the heater off and allow ice to thaw. You may use water at low pressure to thaw ice build up on the outer coil, shut the heater off when doing so. Call the factory for advice.
Control Ready light ON. Water Press. OK light ON. T-Stat On light ON. Low Press. light ON. High Press. light OFF. Unit will not start.	Low or restricted water flow through heater. Dirty or worn filters or clogged lint traps. Clogged filter pump impeller. Improper plumbing valve settings. Suction leak allowing air into the water flow. Low water flow when switched to spa mode. Unit is plumbed backwards. Heat exchanger clogged with debris. Internal bypass valve damaged or clogged with debris. Water temperature exceeding 104°F maximum. Refrigerant system malfunction.	Clean entire filtering system and or replace filter element. Inspect & clean pump impeller. Adjust all plumbing valves. Repair suction air leaks, grease pump lid o-ring. Replace filter. Wrong filter pump pipe size. Automatic pool vacuum causing restriction. Thermostat not shutting unit off at 104°F. Call your dealer for advise. Call the factory for advise.
Control Ready light ON. Unit is cycling on & off.	Low or restricted water flow through heater. Dirty or worn filters or clogged lint traps. Clogged filter pump impeller. Improper plumbing valve settings. Suction leak allowing air into the water flow. Low water flow when switched to spa mode. Unit is plumbed backwards. Heat exchanger clogged with debris. Internal bypass valve damaged or clogged with debris.	Clean entire filtering system and or replace filter element. Inspect & clean pump impeller. Adjust all plumbing valves. Repair suction air leaks, grease pump lid o-ring. Replace filter. Wrong filter pump pipe size. Automatic pool vacuum causing restriction. Call your dealer for advise. Call the factory for advise.

Control Ready light ON. Water Press. OK light ON T-Stat On light ON Fan is not turning. Unit will not start.	Low water flow through heater. Dirty or worn filters or clogged lint traps. Clogged filter pump impeller. Improper plumbing valve settings.	Clean entire filtering system and or replace filter element. Inspect & clean pump impeller. Adjust plumbing valves. Call the factory for advice.
All control lights ON Fan is turning, no cool air discharging out the top of heater. Unit is not heating.	Compressor has not started yet. Low water flow through heater. Dirty or worn filters or clogged lint traps. Clogged filter pump impeller. Improper plumbing valve settings.	Wait for the 5 minute compressor time delay. Clean entire filtering system and or replace filter element. Inspect & clean pump impeller. Adjust plumbing valves. Call factory or dealer.
Spa will not heat to maximum temperature of 104 F + or - 3 . Thermostat is turned all the way up. OR Spa is heating very slowly.	Low or restricted water flow through heater. Dirty or worn filters or clogged lint traps. Clogged filter pump impeller. Improper plumbing valve settings. Suction leak allowing air into the water flow. Low water flow when switched to spa mode or the control is not in spa mode. Unit is plumbed backwards. Heat exchanger clogged with debris. Internal bypass valve damaged or clogged with debris. Your spa thermometer is not reading the correct temperature. Air blower is running. Venturi air inlets are open. It is very cold outside. Spa pump is not running.	Clean entire filtering system and or replace filter element. Inspect & clean pump impeller. Adjust all plumbing valves. Repair suction air leaks, grease pump lid o-ring. Shut off air blower and or Venturi inlets that allow air turbulence in the spa. Use a cover while heating the spa. Outside air temp. too cold. Set spa pump timer for longer time. Call your dealer for advice. Call the factory for advice.
Pool is heating very slowly. Pool is not getting up to temperature.	Low or restricted water flow through heater. Dirty or worn filters or clogged lint traps. Clogged filter pump impeller. Improper plumbing valve settings. Suction leak allowing air into the water flow. It is cold outside. Pool pump timer is not set for a long enough running period. Pool is not covered. High wind speed over pool. Shaded pool area.	Clean entire filtering system and or replace filter element. Inspect & clean pump impeller. Adjust all plumbing valves. Repair suction air leaks, grease pump lid o-ring. Use a pool cover. Place a wind break around pool. Set pool pump timer longer. Call your dealer for advice. Call the factory for advice.
For dual thermostat units: Unit is in pool mode but spa is on, or unit is in spa mode but pool is on.	The optional motorized plumbing valves are out of synchronization with the dual thermostat control. The motor valves are not turning. The manual pool/spa valves have not been turned correctly. A third party external control device is overriding the dual control. Motor valves have a tendency to rotate after a power outage and then they are out of sync.	Use the motor valve actuator switches so the valves go to the mode selected on the dual thermostat pool/spa select switch. Grease motor valves. Adjust manual valves correctly. Adjust third party control device. Possible defective motor valve. Call your installer for advice. Call the factory for advice.
Compressor will not start. Fan comes on, compressor time delay passes, compressor attempts to start but unit shuts all the way off (and or circuit breaker trips).	Low or restricted water flow through heater. Dirty or worn filters or clogged lint traps. Clogged filter pump impeller. Improper plumbing valve settings. Suction leak allowing air into the water flow. Low water flow when switched to spa mode. Compressor was not preheated properly (reciprocating type R-series only). Scroll type (S-series) compressors "only" require several start cycles before it will start when new, during cold temperatures or if the unit has been idle for some time. Weak power supply voltage.	Clean entire filtering system and or replace filter element. Inspect & clean pump impeller. Adjust all plumbing valves. Repair suction air leaks, grease pump lid o-ring. Replace filter. Preheat reciprocating type (R-series) compressor for 8 hours. Allow Scroll type (S-series) compressors several start cycles. Have a licensed electrician check the power supply voltage and wire size. Call your installer for advice. Call the factory for advice.
Water running from the bottom of the heater when it is running. OR The heater seems to have a water leak.	The heater produces water condensation when it operates. The water will trickle from the drain holes designed in the bottom of the heater. The higher the humidity the more water condensation the heater will produce. This is similar to the effect that a glass of ice water has when it sweats. Corrosive pool water, chemical damage to water tubing inside heater. Chlorinator is not isolated from the heater, chlorine migration.	Shut the heater off for several hours but leave the pool water pump running. Allow enough time for all the normal condensation to evaporate. If the heater continues to trickle water after that time, when it is not running, you may have a pool water leak. You can test this water for chlorine to confirm. Make sure your chlorinator has a check valve and loop installed between the heater & chlorinator.

ELECTRICAL WIRING SPECIFICATIONS

WARNING

The heater must be electrically grounded and bonded in accordance with local codes, or in the absence of local codes, with the latest national electrical codes ANSI/NFPA No. 70. All wiring must comply with all local codes, or in the absence of local codes, with the latest national electrical codes ANSI/NFPA No. 70. For proper wire and/or breaker size, please refer to specification sheet and your local licensed electrician.

Unit has 3/4" knockout on left side of unit.

A pool water pump bond wire lug is in the same location.

The wire path from the knockout to the main contactor is about 3 feet.

Line side of the main contactor will be on the top.

The model number is located on a silver label on the front of the unit.

UNIT IDENTIFICATION



MANDATORY BONDING TO POOL STEEL (This is in addition to electrical ground)

Make sure that the unit cabinet is bonded to the pool steel. Most codes require that the circulation pump be bonded as well. You can connect at that point using at least a #6 gauge or larger **solid** copper wire. Use the external bond lug on the cabinet to insure a good bond.

Bonding the unit to the pool steel will help reduce the chance of electrolysis, also known as electrical corrosion. A heater left un-bonded may experience corrosion to the metal water tubing inside the heater.

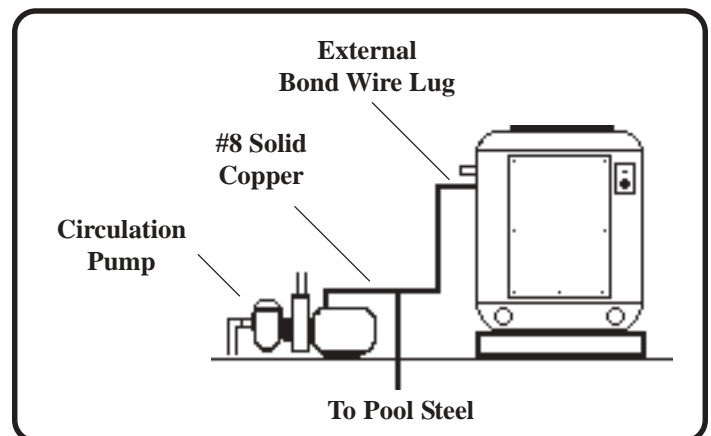

CAUTION

IN SOME CASES WE HAVE SPECIFIED "BETTER" THAN N.E.C. CODE THEREFORE, THE MANUFACTURERS SPECIFICATION "BECOMES" THE CODE FOR THAT PARTICULAR UNIT.
NOTE: TECHNICIANS SEE SEPARATE INSTALLATION MANUAL FOR EXACT DETAILS.

HOW TO GET SERVICE

When you experience trouble with your unit, you should follow these simple procedures before requesting service on your pool/spa heat pump.

1. You should follow all start up procedures as described in this booklet. Without exception you should clean the filtering system thoroughly, consult the manufacturers directions for proper filter cleaning methods. You must eliminate any water flow or filtering system problems. Check all electrical service, breakers and switches.
2. Inform your dealer that the unit is having trouble and you would like them to check the unit for any obvious non warranty problems, including but not limited to: installation specifications, water flow and filtration problems, bypass adjustment, timers and control devices or any field installed options that may effect normal operation of the heat pump.
3. Make sure the filtering system and any control devices are properly adjusted and corrected before you request service from the factory. These listed items and others like them are not considered factory defects. If the factory authorized warranty service is sent to the site and no factory defects are found or there is a problem not associated with the unit as it was manufactured, the pool owner will be liable for all charges. Water flow adjustments, filter cleaning, and control devices, etc. that effect the heater or damage caused by such equipment is not covered under the warranty agreement. The pool owner is responsible for the correct adjustment and maintenance of the filtering system.
4. If the dealer is unavailable to help you, the factory service manager will assist you or your pool service over the phone. The service manager will give suggestions on how to check the filtering system and other obvious problems. You may save yourself the cost of a service call and learn more about your pool heat pump if you take the time to seek advise before requesting the factory service crew. Literature can be sent to you directly that will help you understand the heat pump system.
5. Once you have made contact with the dealer or the factory service department make sure that you can be present when the heater is serviced. The authorized factory service centers will require the pool owner or dealer be present.

Heat Pump Service Department
(800) 831-7133

Required Information:

Serial #

Model # _____,

Install Date ___ / ___ / ___

Dealer Name _____

The actual receipt or canceled check may be needed to verify installation date and proof of ownership. Any service request resulting in a repair or adjustment not considered a factory defect with the heater as it was manufactured will be the responsibility of the heater owner and therefore billed directly to the owner. Always read and follow the owners manual and then seek advice from your dealer and / or the installer. BE ADVISED THERE ARE SEPARATE INSTALLATION, SERVICE & ACCESSORY MANUALS.

GLOSSARY OF TERMS

A/C Contractor: A company licensed by the state and local authorities to perform heating ventilation and air-conditioning installation or repair including pool heat pumps. Allow no others to repair this unit.

Acetic: Describing pool/spa water that is aggressive in nature with a Ph value below 7.6. Like acid, orange juice, vinegar etc.

Accumulator: a containment housing in the Freon circuit that collects liquid forms freon that does not evaporate after passing through the evaporator coil, thus protecting the compressor from damage.

Air Blower: An electronic device that forces air under pressure through the spa plumbing giving the spa a bubbling effect.

Air Inlet: Used to create bubbling effects for the spa jets. Water passing through a vortex draws air into the plumbing without the use of an electronic air blower. Usually controlled by some sort of knob or lever to shut it on or off.

Alkaline: Describing pool/spa water that is the opposite of acetic with a Ph value above 7.6. Base, like milk or chalk etc.

Anti Short Cycle Time Delay Device: Keeps the compressor from being damaged due to the freon gas not being allowed to settle between cycles, preventing liquid freon from entering the compressor. When the unit stops there will be a certain time delay before the compressor will start again.

Automatic Chlorinator: A device that feeds either tablet type or liquid type chlorine concentration into the plumbing piping and then delivered to the pool/spa water.

Authorized Factory Service: An A/C Contractor factory trained and under contract with the manufacturer to provide repair service.

Back-Siphon: In regards to pool filtering systems where the water flow reverses through the system when the circulation pump shuts off. This is usually caused by the vacuum created by the water in the filtering being above the pool level, or breach in the sealed water plumbing, allowing air into the system. This condition is sometimes referred to as a suction or vacuum leak.

Back Pressure: The pressure created by the circulation pump being restricted by plumbing, filters, solar panels and other related equipment. Usually due to a dirty filter, measured by the pressure gauge in the filter housing

Blanket: A plastic cover several mills thick with trapped air bubbles, cut to the same size as the pool and floats on top of the water to provide insulation and prevent heat loss. Some types collect small amounts of heat from the sun and transfer it to the pool water. Sometimes referred to as a solar blanket.

BTU: British Thermal Units. Measures heat output of a heat pump, in Btu's per hour.

Broadcast Type Sprinklers: Part of an irrigation system used to water plants or grass where the water is sprayed into the air and distributed directional.

Bypass: Used in the water piping to allow the control of water flow through the heater at a prescribed rate, thus the rest of the water flow not needed is diverted through the bypass

Calcium Hardness: The amount of calcium and magnesium content in pool/spa water calculated by using a test kit for such purposes.

Calcium Hypochlorite: A form of chlorine in a powder form and rarely in a tablet form used to sanitize pool/spa water. Calcium is a major component and by-product.

Cartridge Filter: A pool/ spa water filter that is made of pleated paper and nylon. Usually round with plastic base and top, placed into a tank that the water is pumped through trapping debris and dirt. Usually removed and cleaned with a high pressure garden hose.

Check Valve: A P.V.C. fitting used on the water piping to prevent reverse flow through the system and insure proper water direction. Sometimes used to create back pressure and slow the water velocity.

Chemical Values: The numerical reading you get by using a pool/spa water test kit to calculate levels of pool chemicals and minerals in the pool water at any given time.

Chemical Damage: Any damage or corrosion from pool chemicals or any other chemicals used around the heat pump or pool. Usually concentrated chlorine or acetic water corroding the copper piping or the heat exchanger or other equipment.

Chemical Resistant Check Valve: A check valve placed between the heater and a chlorinator to prevent the migration of concentrated chlorine into the heater.

Chlorinator: A device that is used to feed chlorine to the pool/spa through the filtering system. Water is pumped through a containment holding the chlorine. This makes a solution that is then fed to the pool or spa.

Chlorinator Placement: (Illustrated in this owners manual), showing the proper location and placement of chlorinating devices in order to prevent chemical damage to the heater.

Chlorine: A common pool/spa water sanitizer available in several different forms of powder, solid tablets, liquid or gas.

Chlorine Tablets: A common form of chlorine that is solid in nature used in a chlorinator that is eroded by water rushing over these tablets, making a solution to be slowly fed to the pool water.

Circuit Breaker: An automatic switch that will shut the power off to an electrical device (heater, circulation pump) when an overload or short occurs. Located in the electrical supply panel in your home or near the associated equipment.

Circulation Pump: An electric water pump that circulates water through the filter and other pool related equipment. Usually controlled by a timer.

Condensation: Water that accumulates inside the heater due to the humidity in the air coming in contact with the colder freon piping in the evaporator coil. This water will trickle out of the drain ports on the bottom of the heater. Like sweat on a glass of ice water.

Control Devices: Electronic devices used to manipulate the pool/spa functions and equipment other than those manufactured into the heater itself. Sometimes by remote control, switches or sensors.

Convection: The transfer of heat from between two mediums, of different temperatures, in this case from hot to cold, from warm pool to cooler outside air

Compressor: A reciprocating piston in a cylinder, much like a car engine, that compresses freon gas in a chamber before it is released to the heat exchanger.

Commercial Pool: A pool for public use or for the use of community residents that are governed by state and local codes. Usually larger than a residential pool with a larger capacity filtering system, running at a high rate of water flow.

Copper Piping: The piping inside the unit as it was manufactured, leading up to the heat exchanger.

Corrosion: The dissolving of the metals in the heater due to chemical action.

Cover: Used to cover the pool surface and prevent heat loss, referred to as a blanket.

Cupronickel Metal Alloy: A special metal blend copper and nickel that is corrosion resistant.

Cycle: Referred to here as, on and off repeatedly, either the fan and or compressor.

D.E. Filter: A filter type that uses diatomaceous earth powder as a filter media. The D.E. is discharged with the debris via a valve that reverses flow through the filter. This is referred to as backwashing. The D.E. must then be replaced in the filter.

Dealer: As authorized by agreement, with the factory to sell and install this particular brand of heat pump.

Defrost Control: An internal device that will prevent the evaporator coil from getting an ice build up when the outside air temperature drops below 36 degrees. It will shut the compressor off, but allow the fan to run until the air temperature increases.

Down Line: A reference that pertains to chlorinator placement and chemical application meaning, to introduce such, into the water flow piping, after it passes through the heater, as far away from the unit as possible.

Drain Holes: Located in the heater cabinet bottom, that allows the condensation water produced normally to drain out.

Drain Plug: A type of valve installed on the plumbing near the heater to allow the heat exchanger to be completely drained of pool water to prevent freeze damage in such climates.

Dry Acid Powder: A dry powder (sodium bisulfate) used to lower Ph in pool or especially spa water.

Dual Thermostat: A kit added to the unit to allow for two separate thermostats to be used for a pool and spa sharing the same heater. It is also capable of other functions such as motorized valve operation.

Initial Heat Up Time: The time required to heat the pool up to the desired temperature when you turn the unit on for the first time. When the pool water temperature is at its lowest temperature.

Electrocution: To be shocked by electrical current, to have electrical current pass through your body resulting in death or injury.

Elevation: The height of the installed unit, in comparison to the pool water level.

Evaporation: When referring to heat loss of the pool water, when the pool water changes from a liquid to a gas then dissipates into the air, taking heat away with it.

Evaporator Coil: The aluminum and copper air/freon manifold that is used to change the properties of the Freon as it passes through it. The warmer air is forced through the fins to produce the reaction due to dissimilar temperatures.

Expansion Valve: A control valve that regulates the Freon pressure to the evaporator coil.

Fan: Used to move air through the evaporator coil.

Fan Blades: The aluminum mechanism that moves the air through the unit. Located on top of the cabinet. Caution: fan blades can be sharp and cause injury.

Filter: Use to clean the pool water by pumping water through a media that collects debris and is cleaned later as part of regular pool maintenance.

Filter System: The equipment installed to circulate and clean the pool water usually consisting of an electric water pump on a timer, a filter containment, flow control valves, and other equipment needed for that particular pool and/or spa.

Floating Chlorinator: A device that floats on the pool waters surface that feeds chlorine to the water by eroding solid tablet type chlorine, inside its containment.

Floating Thermometer: A thermometer that floats on the water surface with the main sensing bulb in the water. Indicates the actual pool or spa temperature it's floating in. A tie on type will work the same.

Flow Control Valve: A valve or check valve that controls water flow either automatically or manually.

Freon™: Trade name for a type of refrigerant. The heat transfer medium used to transfer the generated heat to the pool water, in the vapor compression cycle of the heat pump system. Changing from a gas to a liquid state in cycles.

Full Prime: A reference used to describe a water pump running normally without air entering into the system, running at full capacity.

Gas Chlorine: Chlorine in a pure state, gas.

G.P.M. : Gallons per minute, used to measure flow rate

Heat & Cool: The unit, the heater, the appliance referenced in this manual. A reverse cycle unit capable of both heating and cooling.

Heat Exchanger: A manifold where the compressed hot freon gas transfers its heat to the pool water. A tube within a tube. Hot freon gas passing through one tube and water passing through the other tube, bent in a coiled fashion. Made from a cupronickel metal alloy.

Heat Loss: The act of the pool losing heat due to certain conditions such as weather, wind, evaporation, radiance, convection etc.

Heat Pump: The unit, the heater, the appliance referenced in this manual.

Hydro-Therapy Jets: Used in spas to create high pressure water flow with air turbulence. Water is forced through a restriction that creates a vortex that draws air into the water flow thus increasing velocity. This air flow is usually regulated by a manual control.

Icing Up: Ice forming on the evaporator coil.

In Line Type Chlorinator: A chlorinating device that is mounted directly on the piping, that has an internal manifold within the plumbing, used to allow water flow through the containment, where a solid tablet type chlorine is held. This type requires no water tubing in and out of the containment.

Injection: In regard to feeding pool chemicals into the water flow in whatever fashion.

Installer: Same as dealer, person or company where the unit was purchased.

Internal Adjustments: Any part or component inside the cabinet of the unit.

Lint Trap Basket: A strainer type basket that collects debris and prevents such from being trapped in other equipment, including the heat exchanger.

Liquid Chlorine: Chlorine in a liquid form, (sodium hypochlorite).

Long Term Freeze: When the outside air temperature drops below 36 degrees as part of a seasonal weather change lasting for an extended period of time.

Marcite: A white plaster type pool wall and surface finishing material made of white Portland cement and marble dust.

Migrate: Referring to concentrated chlorine moving through the filter system plumbing with or without the water flowing.

Motorized Plumbing Valves: Valves that are driven by low voltage motors mounted on top of such a valve. Usually used to change from pool to spa mode via a control switch or device without having to go to the filter system and turn these valves manually.

Muriatic Acid: A liquid acid that is used to lower the Ph of pool water. Handle with extreme caution. (Use a dry powder acid for spas.)

Normal Operation: When the heat pump is running as intended by the manufacturer.

Nozzle Attachment: A device attached to the end of a garden hose, that increases pressure and controls direction.

On/Off Switch: Located on the unit next to the thermostat dial use to shut the unit off and on, so you do not have to move the thermostat or shut off the circuit breaker to control the unit.

O-Ring: A round rubber gasket that is used for sealing removable access lids to pool filtering equipment and other related items.

Ph: A term used when determining the alkalinity or acetic nature of water.

Pool/Spa Combination: When you have a pool and spa together, where the two body's of water are connected by a spill-over or other plumbing means.

PPM: Parts per million. Use as a term to tell you how much of a certain chemical ratio is in the water.

Pressure Switch: A device inside the heater, that senses water pressure and keeps the unit from running when there is little or no water flow going through it.

Radiant Heat Loss: When the water loses heat through the walls and floor of the pool shell.

Return: The term used to indicate water flow direction back to the pool, after it passes through the filtering system. There are orifices in the pool called return outlets.

Run Dry: When any pool equipment is running without water, usually causing some sort of damage.

Serial Number: A twelve digit number on the identification sticker on the outside of the heater cabinet. Needed for all records, warranty request etc.

Shadow-Box Fence: A fence that is made to allow air to pass through it freely without restriction.

Shock Treatment: Adding a larger than normal dose of chlorine to the pool water to kill contaminants, algae and to remove combined chlorine.

Short Cycle: The act of the compressor going on and off without letting the refrigerant gas to settle.

Short Term Freeze: When the outside air temperature drops below 36 degrees for a short period of time, usually for only a few days or so, but not part of a normal seasonal change where lower temperatures are expected as a norm.

Sodium Hypochlorite: A liquid form of chlorine.

Skimmer: A housing mounted at the pool water level in the pool wall and deck, that is used to capture debris as water is drawn into it. The water is drawn in by the suction created by the circulation pump.

Skimmer Basket: The strainer type debris catch, inside the skimmer housing that keeps debris from clogging other related equipment.

Skimmer Inlet: The square opening right at the pool water level, flush with the pool wall.

Skimmer Throat: The main cavity of the skimmer where the skimmer basket is located.

Solar Panels: A manifold placed on a roof top, to collect heat from the sun and transfer it to the pool water being pumped through it.

Spa: a smaller body of water using hotter water temperature and high pressure water flow mixed with air to create a therapy effect.

Sprinkler Heads: Irrigation water distribution device, placed in areas of the yard that broadcast water to the surrounding area.

Surge Tank: Part of a filtering system that holds a specific amount of water to supply the circulation pump. Filter elements are sometimes placed in this tank so when the pump suctions water through them it cleans the water. This tank is fed pool water through plumbing piped from the pool by gravity.

Temperature Rise/Difference: A calculation used to determine how many degrees the water passing through the heat exchanger is increased in order to set it at a prescribed difference.

Thermometer: Used to determine the actual pool or spa water temperature. Sometimes a floating type or a tie on type.

Thermostat: Located on the unit itself, used to set the desired temperature you would like the actual pool or spa water to be.

The unit will activate if the water temperature is below the setting. The unit will shut off when the water temperature has reached that particular setting.

Three-Way Valve: A plumbing valve that controls water flow having three ports in which to connect plumbing to.

Timer: A timing device that activates the water circulation pump according to preset times.

Time Delay: A device inside the heater, that will delay the compressor from running until the refrigerant gas and crank case oil settle, before allowing the compressor to run, preventing damage to the compressor..

Trickle Type Sprinkler: An irrigation distributor that does not broadcast water into the air but slowly waters the surrounding ground directly.

Vacuum Type Filter: A filter on the suction side of the circulation pump usually mounted inside a surge tank. Water is drawn through the filter media trapping debris.

Variable Rate Flow Control Valve: The "internal" valve used to as a bypass for the heater water flow. This spring type valve will automatically adjust the water flow rate to the unit when the flow rate changes for what ever reason, (30 to 70 G.P.M. range).

Water Coil: Same as heat exchanger.

Water Chemical Balance: The standard pool water test and chemical amounts and values, that the water needs to be considered balanced, according to standard practice.

This page is blank.

This page is blank.

Manufactured by:
Pool Products, Inc.
10000s Avenue, Sanford, NC 27330
10000s Angeles Avenue, Moorpark, CA 93021

Free Manuals Download Website

<http://myh66.com>

<http://usermanuals.us>

<http://www.somanuals.com>

<http://www.4manuals.cc>

<http://www.manual-lib.com>

<http://www.404manual.com>

<http://www.luxmanual.com>

<http://aubethermostatmanual.com>

Golf course search by state

<http://golfingnear.com>

Email search by domain

<http://emailbydomain.com>

Auto manuals search

<http://auto.somanuals.com>

TV manuals search

<http://tv.somanuals.com>