

PENTAX



SLR Digital Camera

K-5 II / K-5 II s

Operating Manual

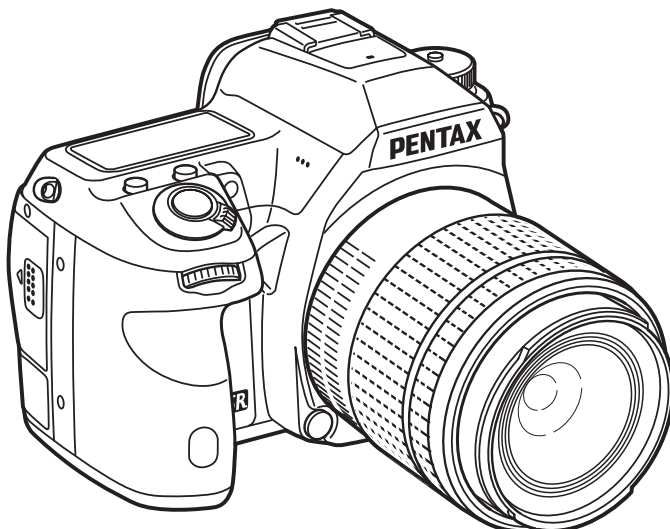

SILKYPIX[®]
The Excellent digital development technology



HDMI[™]
HIGH-DEFINITION MULTIMEDIA INTERFACE

For optimum camera performance, please read the Operating Manual before using the camera.

Thank you for purchasing this PENTAX *K-5 II / K-5 IIs* Digital Camera. Please read this manual before using the camera in order to get the most out of all the features and functions. Keep this manual safe, as it can be a valuable tool in helping you to understand all the camera's capabilities.

Lenses you can use

In general, lenses that can be used with this camera are DA, DA L, D FA and FA J lenses and lenses that have an **A** position on the aperture ring. To use any other lens or accessory, see p.56 and p.297.

Regarding copyrights

Images taken with the *K-5 II / K-5 IIs* that are for anything other than personal enjoyment cannot be used without permission according to the rights as specified in the Copyright Act. Please take care, as there are cases where limitations are placed on taking pictures even for personal enjoyment during demonstrations, performances or of items on display. Images taken with the purpose of obtaining copyrights also cannot be used outside the scope of use of the copyright as laid out in the Copyright Act, and care should be taken here also.

Regarding trademarks

Microsoft and Windows are registered trademarks of Microsoft Corporation in the United States and other countries. Windows Vista is either a registered trademark or trademark of Microsoft Corporation in the United States and/or other countries.

Macintosh and Mac OS are trademarks of Apple Inc., registered in the U.S. and other countries.

Intel, Intel Core, and Pentium are trademarks of Intel Corporation in the U.S. and other countries.

SDXC Logo is a trademark of SD-3C, LLC.

This product includes DNG technology under license by Adobe Systems Incorporated. The DNG logo is either a registered trademark or trademark of Adobe Systems Incorporated in the United States and/or other countries.

HDMI, the HDMI logo and High-Definition Multimedia Interface are trademarks or registered trademarks of HDMI Licensing, LLC in the United States and/or other countries.

All other brands or product names are trademarks or registered trademarks of their respective companies.

This product supports PRINT Image Matching III. PRINT Image Matching enabled digital still cameras, printers and software help photographers to produce images more faithful to their intentions. Some functions are not available on printers that are not PRINT Image Matching III compliant.

Copyright 2001 Seiko Epson Corporation. All Rights Reserved.

PRINT Image Matching is a trademark of Seiko Epson Corporation.

The PRINT Image Matching logo is a trademark of Seiko Epson Corporation.

To users of this camera

- Do not use or store this camera in the vicinity of equipment that generates strong electromagnetic radiation or magnetic fields. Strong static charges or the magnetic fields produced by equipment such as radio transmitters could interfere with the monitor, damage the stored data, or affect the camera's internal circuitry and cause camera misoperation.
- The liquid crystal panel used for the monitor is manufactured using extremely high precision technology. Although the level of functioning pixels is 99.99% or better, you should be aware that 0.01% or fewer of the pixels may not illuminate or may illuminate when they should not. However, this has no effect on the recorded image.
- There is a possibility that the illustrations and the display screen of the monitor in this manual are different from the actual ones.
- In this manual, SD Memory Cards, SDHC Memory Cards and SDXC Memory Cards are referred to as SD Memory Cards.
- In this manual, the generic term "computer(s)" refers to either a Windows PC or a Macintosh hereafter.
- In this manual, the term "battery(ies)" refers to any type of batteries used for this camera and its accessories.
- The **K-5 II** and **K-5 II S** can essentially be used in the same manner. In this manual, the explanations and examples are mainly for using the **K-5 II**. **K-5 II S** users should refer to "About the **K-5 II S**" (p.18).

For Using Your Camera Safely

We have paid close attention to the safety of this camera. When using this camera, we request your special attention regarding items marked with the following symbols.



Warning

This symbol indicates that ignoring this item could cause serious personal injuries.



Caution

This symbol indicates that ignoring this item could cause minor or medium personal injuries, or loss of property.

About the Camera



Warning

- Do not disassemble or modify the camera. High voltage areas are present inside the camera, with the risk of electric shock.
- If the camera interior is exposed due to dropping or otherwise damaging the camera, never touch the exposed portion. There is a risk of electric shock.
- Do not aim the camera at the sun or other strong light sources when taking pictures or leave the camera sitting in direct sunlight with the lens cap off. Doing so may cause the camera to malfunction or cause a fire.
- Do not look at the sun or other strong light sources through the lens. Doing so may lead to a loss of eyesight or cause vision to be impaired.

- If any irregularities occur during use, such as smoke or a strange odor, stop use immediately, remove the battery or the AC adapter, and contact your nearest PENTAX Service Center. Continued use can cause a fire or electrical shock.



Caution

- Do not place your finger over the flash when discharging the flash. You may burn yourself.
- Do not cover the flash with clothing when discharging the flash. Discoloration may occur.
- Some portions of the camera heat up during use. There is a risk of low temperature burns when holding such portions for long periods.
- Should the monitor be damaged, be careful of glass fragments. Also, be careful not to allow the liquid crystal to get on your skin or in your eyes or mouth.
- Depending on your individual factors or physical condition, the use of the camera may cause itching, rashes or blisters. In case of any abnormality, stop using the camera and get medical attention immediately.

About the Battery Charger and AC Adapter



Warning

- Always use the battery charger and AC adapter exclusively developed for this camera, with the specified power and voltage. Using a battery charger or AC adapter not exclusive to this camera, or using the exclusive battery charger or AC adapter with an unspecified power or voltage can cause a fire, electric shock, or camera breakdown. The specified voltage is 100 - 240V AC.
- Do not disassemble or modify the product. This can cause a fire or electrical shock.
- If the generation of smoke or strange odor from the product or other abnormality occurs, immediately discontinue using and consult a PENTAX Service Center. Continued use can cause a fire or electrical shock.
- If water should happen to get inside the product, consult a PENTAX Service Center. Continued use can cause a fire or electrical shock.
- If you see a lightning flash or hear thunder during use of the battery charger or AC adapter, unplug the power plug and discontinue use. Continued use can cause damage to the product, fire or electrical shock.
- Wipe off the power plug if it should become covered with dust. Accumulated dust may cause a fire.
- To reduce the risk of hazards, use only CSA/UL certified power supply cord set, cord is Type SPT-2 or heavier, minimum NO.18 AWG copper, one end with a molded-on male attachment plug cap (with a specified NEMA configuration), and the other is provided with a molded-on female connector body (with a specified IEC nonindustrial type configuration) or the equivalent.



Caution

- Do not place or drop heavy objects on or forcefully bend the AC plug cord. Doing so may damage the cord. Should the AC plug cord be damaged, consult a PENTAX Service Center.
- Do not touch or short-circuit the terminal area of the AC plug cord while the cord is plugged in.
- Do not handle the power plug with wet hands. This can cause an electric shock.
- Do not drop the product, or subject it to violent impact. This can cause the product to breakdown.
- Do not use the battery charger D-BC90 to charge batteries other than the rechargeable lithium-ion battery D-LI90. Attempting to charge other types of batteries may cause an explosion or heating, or may damage the battery charger.

About the Battery



Warning

- If any leakage from the battery should come in contact with your eyes, do not rub them. Flush your eyes with clean water and get medical attention immediately.



Caution

- Only use the specified battery with this camera. Use of other batteries may cause an explosion or fire.
- Do not disassemble the battery. Disassembling the battery may cause an explosion or leakage.
- Remove the battery from the camera immediately if it becomes hot or begins to smoke. Be careful not to burn yourself during removal.
- Keep wires, hairpins, and other metal objects away from the + and - contacts of the battery.
- Do not short the battery or dispose of the battery in fire. This can cause an explosion or fire.
- If any leakage from the battery should come in contact with skin or clothing, it may cause irritation to the skin. Wash the affected areas thoroughly with water.
- Precautions for D-LI90 Battery Usage:
 - USE SPECIFIED CHARGER ONLY.
 - RISK OF FIRE AND BURNS.
 - DO NOT INCINERATE.
 - DO NOT DISASSEMBLE.
 - DO NOT SHORT CIRCUIT.
 - DO NOT EXPOSE TO HIGH TEMP. (140°F / 60°C)
 - SEE MANUAL.

Keep the Camera and its Accessories out of the Reach of Small Children



Warning

- Do not place the camera and its accessories within the reach of small children.
 1. If the product falls or is operated accidentally, it may cause serious personal injuries.
 2. Wrapping the strap around a neck may cause suffocation.
 3. To avoid the risk of a small accessory such as the battery or SD Memory Cards from being swallowed by mistake, keep them out of the reach of small children. Seek medical attention immediately if an accessory is accidentally swallowed.

Care to be Taken During Handling

Before Using Your Camera

- When traveling, take the Worldwide Service Network listing that is included in the package. This will be useful if you experience problems abroad.
- When the camera has not been used for a long time, confirm that it is still working properly, particularly prior to taking important pictures (such as at a wedding or when traveling). Contents of the recording cannot be guaranteed if recording, playback or transferring your data to a computer, etc. is not possible due to a malfunction of your camera or recording media (SD Memory Card), etc.

About the Battery and Charger

- To keep the battery in optimum condition, avoid storing it in a fully charged state or in high temperatures.
- If the battery is left inserted and the camera is not used for a long time, the battery will over-discharge and shorten the battery's life.
- Charging the battery a day before use or on the day of use is recommended.
- The AC plug cord provided with this camera is developed exclusively for the battery charger D-BC90. Do not use it with other devices.

Precautions on Carrying and Using Your Camera

- Do not subject the camera to high temperatures or high humidity. Do not leave the camera in a vehicle, as the temperature can get very high.
- Do not subject the camera to strong vibrations, shocks, or pressure. Use a cushion to protect the camera from vibrations of motorcycles, automobiles, or ships.
- The temperature range for camera use is -10°C to 40°C (14°F to 104°F).
- The monitor may appear black at high temperatures, but will return to normal at normal temperatures.
- The monitor may respond more slowly at low temperatures. This is due to liquid crystal properties, and is not a malfunction.
- Sudden temperature changes will cause condensation on the inside and outside of the camera. Place the camera in your bag or a plastic bag, and remove it after temperatures of the camera and surroundings are equalized.
- Avoid contact with garbage, mud, sand, dust, water, toxic gases, or salt. These could cause the camera to breakdown. Wipe the camera to dry off any rain or water drops.
- Do not press the monitor with excessive force. This could cause it to break or malfunction.
- Be careful not to overtighten the screw in the tripod socket when using a tripod.

Cleaning Your Camera

- Do not clean the camera with organic solvents such as thinner, alcohol, or benzine.
- Use a lens brush to remove dust accumulated on the lens or viewfinder. Never use a spray blower for cleaning as it may damage the lens.
- Please contact a PENTAX Service Center for professional cleaning of the CMOS sensor. (This will involve a fee.)
- Periodic inspections are recommended every one to two years to maintain high performance.

Storing Your Camera

- Do not store the camera with preservatives or chemicals. Storage in high temperatures and high humidity can cause mold to grow on the camera. Remove the camera from its case and store it in a dry and well-ventilated place.
- Avoid using or storing the camera where it may be exposed to static electricity or electrical interference.
- Avoid using or storing the camera in direct sunlight or in locations where it may be exposed to rapid changes in temperature or to condensation.

Other Precautions

- The SD Memory Card is equipped with a write-protect switch. Setting the switch to LOCK prevents new data from being recorded on the card, the stored data from being deleted, and the card from being formatted by the camera or computer.
- The SD Memory Card may be hot when removing the card immediately after using the camera.
- Do not remove the SD Memory Card or turn off the power while the card is being accessed. This may cause the data to be lost or the card to be damaged.
- Do not bend the SD Memory Card or subject it to violent impact. Keep it away from water and store away from high temperatures.
- Do not remove the SD Memory Card while formatting. The card may be damaged and become unusable.
- Data on the SD Memory Card may be deleted in the following circumstances. We do not accept any liability for data that is deleted if
 1. the SD Memory Card is mishandled by the user.
 2. the SD Memory Card is exposed to static electricity or electrical interference.
 3. the SD Memory Card has not been used for a long time.
 4. the SD Memory Card or the battery is removed while the card is being accessed.
- If the SD Memory Card is not used for a long time, the data on the card may become unreadable. Be sure to regularly make a backup of important data on a computer.
- Format new SD Memory Cards. Also format SD Memory Cards previously used with other cameras or devices.
- Please note that deleting data stored on an SD Memory Card, or formatting an SD Memory Card does not completely erase the original data. Deleted data can sometimes be recovered using commercially available software. If you are going to discard, give away or sell your SD Memory Card, you should ensure that the data on the card is completely deleted or the card itself is destroyed if it contains any personal or sensitive information.
- The data on your SD Memory Card should be managed at your own risk.

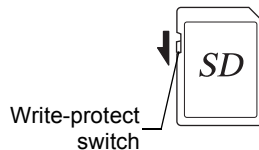

Regarding Product Registration

In order to better serve you, we request that you complete the product registration, which can be found on the CD-ROM supplied with the camera or on the PENTAX website. Refer to p.286 for details. Thank you for your cooperation.

Contents

For Using Your Camera Safely	1
Care to be Taken During Handling	4
Contents	7
Composition of the Operating Manual	13
Before Using Your Camera	15
<i>K-5 II</i> Characteristics	16
Checking the Contents of the Package.....	19
Names and Functions of Working Parts	20
Capture Mode	21
Playback Mode	23
Monitor	25
Viewfinder	36
LCD Panel	38
How to Change Function Settings.....	40
Using the Direct Keys	40
Using the Control Panel.....	41
Using the Menus.....	42
Using the Mode Dial.....	45
Getting Started	47
Attaching the Strap	48
Inserting the Battery	49
Charging the Battery	49
Inserting/Removing the Battery	50
Battery Level Indicator	51
Using the AC Adapter (Optional)	52
Inserting/Removing an SD Memory Card	54
Attaching a Lens	56
Adjusting the Viewfinder Diopter	58
Turning the Camera On and Off.....	59
Initial Settings	60
Setting the Display Language.....	60
Setting the Date and Time.....	62

Basic Operations

65

Basic Shooting Operation	66
Letting the Camera Choose the Optimal Settings	66
Using a Zoom Lens	68
Using the Built-in Flash	69
Setting the Flash Mode	69
Using Built-in Flash	72
Playing Back Images	73
Playing Back Images	73
Deleting a Single Image	74

Shooting Functions

77

How to Operate the Shooting Functions	78
Direct Keys Setting Items	78
Rec. Mode Menu Setting Items	79
Custom Setting Menu Setting Items	81
Setting the Exposure	83
Setting the Sensitivity	83
Reducing Image Noise (Noise Reduction)	85
Changing the Exposure Mode	88
Selecting the Metering Method	103
Adjusting Exposure	105
Locking the Exposure Before Shooting (AE Lock)	107
Focusing	108
Using the Autofocus	108
AF Fine Adjustment	111
Selecting the Focusing Area (AF Point)	113
Adjusting the Focus Manually (Manual Focus)	116
Checking the Composition, Exposure and Focus Before Shooting (Preview)	118
Selecting the Preview Method	118
Displaying the Optical Preview	120
Displaying the Digital Preview	120
Using the Shake Reduction Function to Prevent Camera Shake	122
Using the Shake Reduction Function	122
Shooting with Self-timer	125
Shooting with Remote Control (Optional)	127
Shooting with the Mirror Lock-up Function	130

Taking Pictures Continuously	132
Continuous Shooting	132
Interval Shooting.....	133
Multi-exposure	136
Shooting while Adjusting the Settings (Auto Bracketing)	138
Shooting while the Exposure is Automatically Changed (Exposure Bracketing).....	138
Shooting while Adjusting Other Settings (Extended Bracketing).....	141
Taking Pictures Using Digital Filters.....	143
Shooting with Live View	146
Setting Live View	147
Taking a Still Picture	149
Recording Movies	152
Changing the Movie Settings.....	152
Connecting a Microphone.....	154
Recording Movies	155
Playing Back Movies.....	157
Editing Movies	159
Using the Flash	161

Using the Built-in Flash	162
Flash Characteristics in Each Exposure Mode	162
Using the Slow-speed Sync.....	162
Using the Trailing Curtain Sync	164
Distance and Aperture when Using the Built-in Flash	165
Lens Compatibility with the Built-in Flash	166
Using an External Flash (Optional)	167
Using the P-TTL Auto Flash	168
Using High-Speed Flash Sync Mode.....	169
Using Flash in Wireless Mode	170
Connecting an External Flash with an Extension Cord.....	173
Contrast-Control-Sync Flash	174
X-sync Socket.....	175

Shooting Settings **177**

Setting a File Format	178
Setting the JPEG Recorded Pixels.....	178
Setting the JPEG Quality Level	179
Setting a File Format	180
Setting the White Balance	183
Adjusting the White Balance Manually	185

Adjusting the White Balance with Color Temperature	188
Setting the Color Space	189
Correcting Images	190
Adjusting Brightness	190
Lens Correction	193
Adjusting the Composition	195
Setting the Image Finishing Tone.....	197
Setting Custom Image	197
Setting Cross Processing	200
Storing Frequently Used Settings	202
Saving the Settings	202
Checking the Saved USER Settings.....	204
Using Saved USER Settings	205
Resetting to Default Settings	206
Playback Functions	207
<hr/>	
Playback Functions Operation	208
Playback Mode Palette Setting Items	208
Playback Menu Setting Items	209
Setting the Playback Display Method	210
Enlarging Images	211
Displaying Multiple Images	212
Multi-image Display Screen	212
Displaying Images by Folder	213
Displaying Images by the Shooting Date (Calendar Display)	214
Joining Multiple Images (Index)	215
Playing Back Images Continuously	217
Rotating Images	219
Deleting Multiple Images	220
Deleting Selected Images	220
Deleting a Folder	221
Deleting All Images	222
Protecting Images from Deletion (Protect).....	222
Connecting the Camera to an AV Device.....	224
Connecting the Camera to a Video Input Terminal.....	224
Connecting the Camera to an HDMI Terminal.....	226

Processing Images 229

Changing the Image Size	230
Changing the Number of Recorded Pixels and Quality Level (Resize)	230
Cutting Out Part of the Image (Cropping)	231
Processing Images with Digital Filters	233
Applying the Digital Filter	235
Recreating Filter Effects	236
Developing RAW Images.....	238
Developing One RAW Image.....	238
Developing Multiple RAW Images	240

Changing Additional Settings 243

How to Operate the Set-up Menu.....	244
Set-up Menu Setting Items	244
Formatting the SD Memory Card	246
Customizing Buttons and Dials	247
Setting the Functions for the E-dials	247
Setting the Functions for the Buttons.....	249
Setting the Beep, Date and Time, and Display Language	252
Setting the Beep	252
Changing the Date and Time Display	253
Setting the World Time	253
Setting the Display Language.....	256
Adjusting the Monitor and the Menu Display	257
Setting the Text Size.....	257
Setting the Guide Display Time	257
Setting the Initial Menu Tab Displayed	258
Setting the Status Screen Display	258
Setting the Display for Instant Review	259
Adjusting the Brightness of the Monitor	260
Adjusting the Color of the Monitor	261
Setting the Electronic Level Display	262
Setting the Folder/File Number.....	263
Changing the Naming System of the Folder.....	263
Creating New Folders	263
Setting the File Name	264
Selecting the Power Settings.....	266
Setting the Auto Power Off Function	266
Selecting a Battery.....	267

Setting the Photographer Information	269
Setting the DPOF Settings	271
Correcting Defective Pixels in the CMOS Sensor (Pixel Mapping)	273
Selecting Settings to Save in the Camera (Memory)	274
Connecting to a Computer	277
<hr/>	
Manipulating Captured Images on a Computer	278
Saving Images on Your Computer	279
Setting the USB Connection Mode	279
Connecting the Camera and a Computer	280
Using the Provided Software	281
Installing the Software	281
Screens of the PENTAX Digital Camera Utility 4	283
Appendix	287
<hr/>	
Default Settings	288
Resetting the Menus	296
Resetting the Rec. Mode/Playback/Set-up Menus	296
Resetting the Custom Menu	296
Functions Available with Various Lens Combinations	297
Using the Aperture Ring	299
Cleaning the CMOS Sensor	300
Removing Dust with Ultrasonic Vibrations (Dust Removal)	300
Detecting Dust on the CMOS Sensor (Dust Alert)	301
Removing Dust with a Blower	303
Using the GPS Unit	305
Displaying the Distance and Direction to the Destination (Simple Navigation)	306
Shooting Celestial Bodies (ASTROTRACER)	308
Error Messages	310
Troubleshooting	313
Main Specifications	315
Index	321
WARRANTY POLICY	327

Composition of the Operating Manual

This Operating Manual contains the following chapters.

1 Before Using Your Camera

Explains camera characteristics, accessories and the names and functions of various parts.

2 Getting Started

Explains your first steps from purchasing the camera to taking pictures. Be sure to read this chapter and follow the instructions.

3 Basic Operations

Explains the procedures for taking and playing back pictures.

4 Shooting Functions

Explains the shooting-related functions.

5 Using the Flash

Explains how to use the built-in flash and external flashes.

6 Shooting Settings

Explains the procedures for configuring image processing and setting the file format.

7 Playback Functions

Explains the procedures for playing back, deleting, and protecting pictures.

8 Processing Images

Explains the procedures for changing the image size, applying digital filters and developing images taken in RAW format.

9 Changing Additional Settings

Explains the procedures for changing the camera settings, such as the monitor display settings and the image file naming convention.



10 Connecting to a Computer

Explains how to connect the camera to a computer, and includes installation instructions and a general overview of the provided software.

11 Appendix

Explains troubleshooting and provides various resources.

The symbols used in this Operating Manual are explained below.

	Indicates reference page number explaining a related operation.
	Indicates useful information.
	Indicates precautions to take when operating the camera.

In this Operating Manual, the buttons of the four-way controller are referred to in the following way.

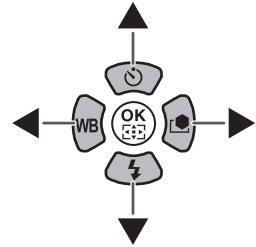

1 Before Using Your Camera

Check the package contents and the names and functions of working parts before use.

<i>K-5 II</i> Characteristics	16
Checking the Contents of the Package	19
Names and Functions of Working Parts	20
How to Change Function Settings	40
Using the Mode Dial	45

- Features a 23.7×15.7 mm CMOS sensor with approximately 16.28 million effective pixels for high precision and a wide dynamic range.
- Features Shake Reduction (SR), an image sensor shifting shake reduction system. This enables you to capture sharp pictures with minimal camera shake regardless of the lens type.
- Features an AF sensor with 11 focusing points. The central 9 focusing points are wide cross area sensors.
- Features a viewfinder similar to that of a conventional 35 mm camera, with a magnification of approximately 0.92 and field of view of approximately 100%, for easier manual focusing. Also features a superimpose function in which the active AF point(s) on the viewfinder illuminate red.
- Features a large 3.0-inch monitor with approximately 921,000 dots, a wide viewing angle and brightness and color adjusting functions for high-precision viewing performance.
- Features a Live View function for shooting while viewing the subject in real-time on the monitor.
- Movies can be recorded by taking advantage of the lens properties. The camera can also output composite and HDMI video signals so that you can watch recorded still pictures and movies on a TV or high-quality monitor.
- A user-friendly design has been implemented in various parts of the camera. The large text size, high-contrast monitor and easy-to-use menus make the camera easier to operate.
- The body exterior is magnesium alloy, and the dials, buttons, joints, and retractable parts of the camera are dust-proof and water-resistant.
- Features the Dust Removal function to remove dust on the CMOS sensor.
- Features Hyper-program and Hyper-manual modes that let you take pictures with the intended exposure. Also features Sensitivity Priority Automatic Exposure mode **Sv** that automatically adjusts aperture and shutter speed according to the set sensitivity, and Shutter & Aperture Priority Automatic Exposure mode **TAv** that automatically adjusts sensitivity according to the set aperture and shutter speed.
- Features Digital Filters to internally process the image in the camera. You can use digital filters such as Color or Soft while taking pictures or to process images after taking them.
- Features Custom Image which allows you to adjust settings while previewing the end result of the edited image, enabling a wider range of photographic expression.

- Records images in the versatile JPEG format or the high quality and fully editable RAW format. You can also select JPEG+RAW and record in both formats simultaneously. When the file format of the last captured image is JPEG, and its data still remains in the buffer memory, you can save the image in RAW format. RAW images can be easily processed internally by the camera.
- Up to five setting patterns can be saved as **USER** mode. In addition, functions for the **RAW/Fx** button and the e-dials can also be customized, enabling speedy operation by any type of photographer.
- Supports the optional Battery Grip D-BG4 with vertical shutter release button. If a battery (D-LI90) is inserted in both the camera and grip, the battery with more power is prioritized. This enables you to get the best camera performance for an extended period. By using a menu item, you can prioritize either one of the batteries in the camera and battery grip, and use its full power before switching to the other battery.

Shake Reduction (SR)

Shake Reduction (SR) on this camera features a PENTAX original system which uses magnetic force to move the image sensor at high speeds, compensating for camera shake.

The camera may generate some operating noise when it is shaken, such as when changing the composition of a picture. This is normal and not a malfunction.

The captured area (view angle) will differ between this camera and 35 mm SLR cameras even if the same lens is used because the format sizes for 35 mm film and CMOS sensor are different.

Sizes for 35 mm film and CMOS sensor

35 mm film : 36×24 mm

CMOS sensor on this camera : 23.7×15.7 mm

The focal length of a lens used with a 35 mm camera is about 1.5 times longer than that of this camera. To shoot images with an angle of view framing the same area, divide the focal length of the 35 mm lens by 1.5.

Example) To capture the same image as a 150 mm lens attached to a 35 mm camera

$$150 \div 1.5 = 100$$

Use a 100 mm lens with this camera.

Inversely, multiply the focal length of the lens used with this camera by 1.5 to determine the focal length for 35 mm cameras.

Example) If a 300 mm lens is used with this camera

$$300 \times 1.5 = 450$$

The focal length is equivalent to a 450 mm lens on a 35 mm camera.

About the *K-5 II S*

Compared with the *K-5 II*, the *K-5 II S* is superior in its ability to express the fine details, which enables taking even higher definition images.

Please note the following to enjoy the high resolution of your *K-5 II S* to the fullest.

Relationship between High Resolution and Aperture

When taking photographs in situations where the ability to record fine details is important, an open aperture up to an aperture of F8 is recommended to reduce the effects of diffraction. Try using an aperture higher than F8 in situations where false color or moiré are noticeable.

False Color and Moiré

While the *K-5 II S* is more suited for expressing fine details than the *K-5 II*, false color and moiré are more noticeable.

For example, when sharpness is emphasized in Custom Image, the image may turn out looking unnatural in some cases. Be sure to take pictures while adjusting the balance between capturing fine details and image processing.

To check for false color and moiré, transfer images to a computer and view them at 100%.

JPEG Quality

If you are going to shoot in JPEG with the quality set to ★ or ★★, high-definition images will not be captured and the ability to record fine details will diminish. Set [JPEG Quality] to ★★★ or ★★★★ as much as possible.

Camera Shake

High-definition images cannot be captured if camera shake occurs.

Prevent camera shake from occurring by using a tripod when necessary.

Checking the Contents of the Package

The following accessories are packaged with your camera. Check that all accessories are included.



Hot shoe cover F κ
(Installed on camera)



Eyecup F κ
(Installed on camera)



ME viewfinder cap



Sync socket 2P cap
(Installed on camera)

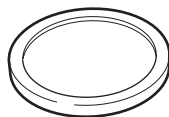

Body mount cover
(Installed on camera)



Triangular ring and
protective cover
(Installed on camera)



Rechargeable lithium-ion
battery D-LI90

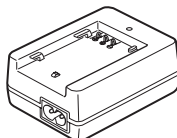

Battery charger
D-BC90



AC plug cord

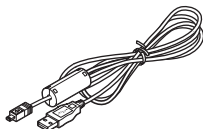

USB cable
I-USB7

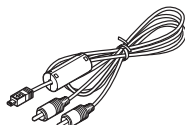

AV cable
I-AVC7

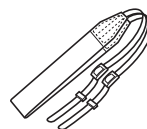

Strap
O-ST132



Software (CD-ROM)
S-SW132

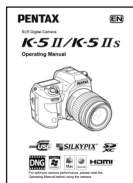

Operating Manual
(this manual)

Names and Functions of Working Parts

1

Before Using Your Camera

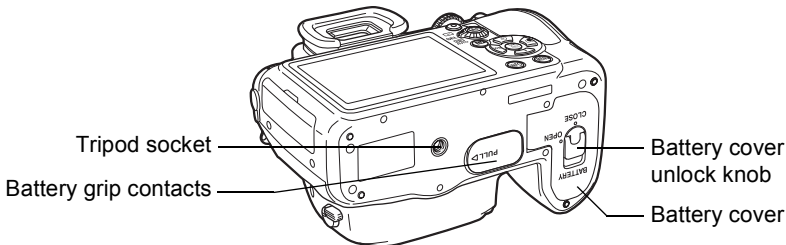
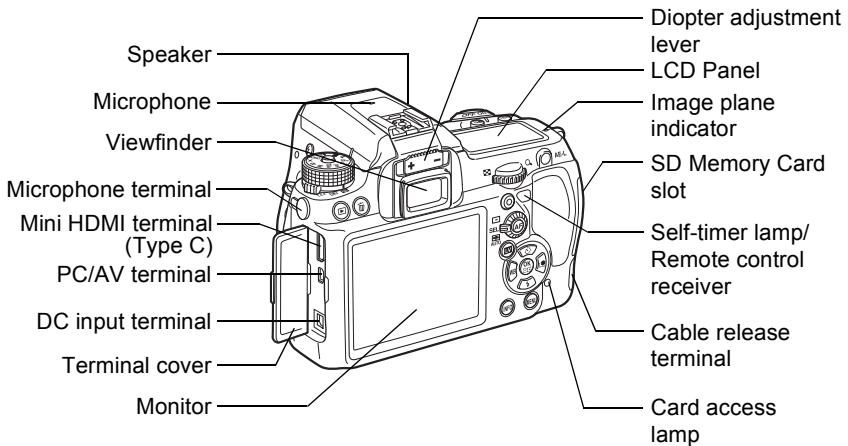
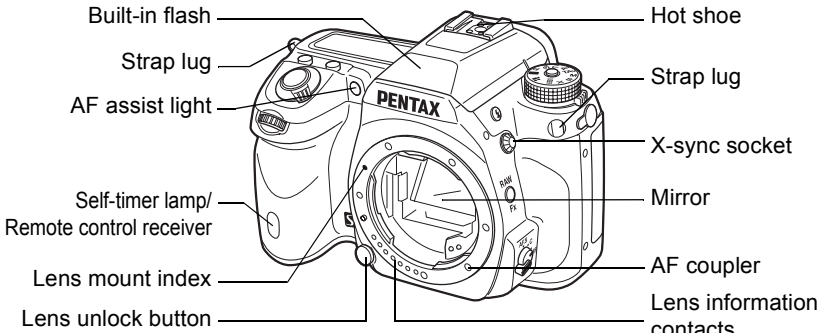

* In the first illustration, the camera is shown with the Hot shoe cover F_K removed.

* In the second illustration, the camera is shown with the Hot shoe cover F_K and the Eyecup F_R removed.



If the terminal covers are not closed correctly, the dust-proof and water-resistant qualities of the camera will not be effective.

Capture Mode

Functions of buttons and dials used during shooting are noted.



The factory default setting of each part is explained here, but some parts have multiple functions and work differently depending on the selected setting.

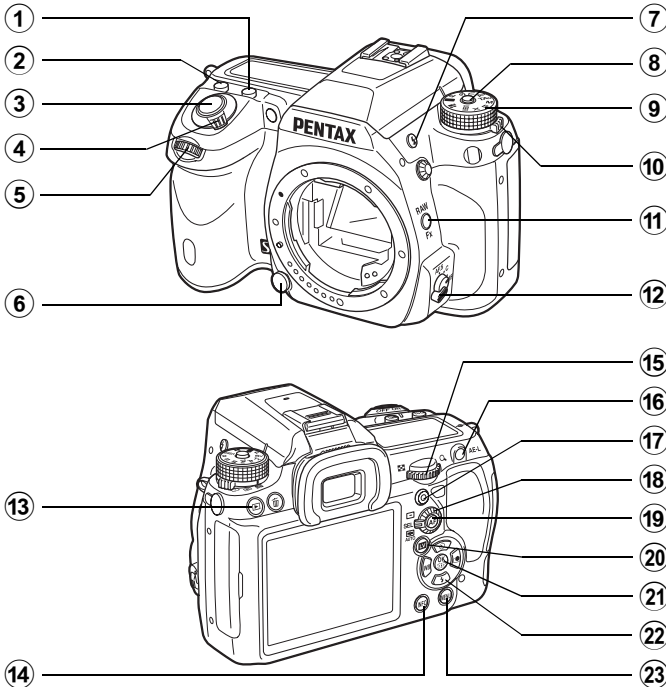

- | | |
|--|---|
| <p>① ☒ (EV Compensation) button
Turn the rear e-dial (☀) while pressing this button to set the EV compensation value. (p.105)</p> <p>② ISO button
Turn the rear e-dial (☀) while pressing this button to set the ISO sensitivity. (p.83)</p> | <p>③ Shutter release button
Press to capture images. (p.67)</p> <p>④ Main switch
Move to turn the power on/off (p.59) or to preview (p.118).</p> <p>⑤ Front e-dial (☀)
Changes the settings. You can change the menu when a menu screen is displayed. (p.43)</p> |
|--|---|

- ⑥ **Lens unlock button**
Press to detach a lens. (p.57)
- ⑦ **⚡ (Flash pop-up) button**
Press to pop up the built-in flash. (p.72)
- ⑧ **Mode dial lock button**
Press to allow the mode dial to be turned. (p.45)
- ⑨ **Mode dial**
Switches the exposure modes. (p.45)
- ⑩ **Metering mode switch**
Changes the metering method. (p.103)
- ⑪ **RAW/Fx button**
You can assign a function to this button. (p.249)
- ⑫ **Focus mode switch**
Switches between autofocus modes (**A.F.S/A.F.C**) (p.108) and manual focus mode (p.116).
- ⑬ **▶ (Playback) button**
Switches to Playback mode. (p.73)
- ⑭ **INFO button**
Changes the style of the display on the monitor. (p.26)
- ⑮ **Rear e-dial (☀️)**
Changes the settings.
You can change the menu when a menu screen is displayed. (p.43)
- ⑯ **AE-L button**
Records the exposure before shooting (p.107) and saves a preview image.
- ⑰ **⦿ (Green) button**
Sets the exposure mode to Automatic Exposure and resets the settings.
- ⑱ **AF point switching dial**
Sets the focusing area. (p.113)
- ⑲ **AF button**
Sets the focusing area and temporarily provides manual focus. (p.110)
- ⑳ **📺 (Live View) button**
Displays a Live View image. (p.149)
- ㉑ **OK button**
When the control panel or a menu screen is displayed, press this button to confirm the selected item.
When the AF point switching dial is set to **SEL** (Select), press this button to enable or disable changing the AF point. (p.114)

22 Four-way controller**(▲▼◀▶)**

Displays the Drive Mode/Flash Mode/White Balance/Custom Image setup menu. (p.78)

When the control panel or a menu screen is displayed, use this to move the cursor or change items.

When the AF point switching dial is set to **SEL** (Select), use this to change the AF point. (p.114)





23 MENU button



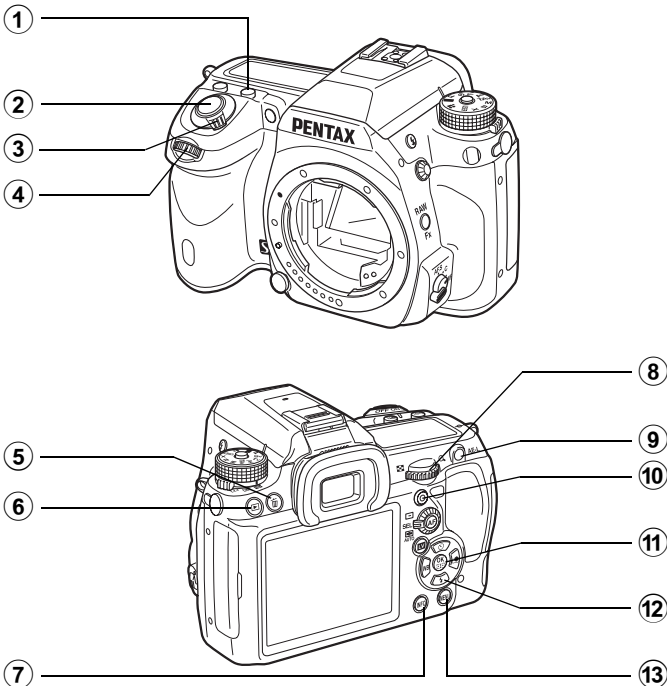

Displays the [📷 Rec. Mode 1] menu (p.79). Press this button when a menu screen is displayed to return to the previous screen.

Playback Mode

Functions of buttons and dials used during playback are noted.



- ① ** (EV Compensation) button**
Press in the enlarged view to increase the magnification. (p.211)
- ② **Shutter release button**
Press halfway to switch to Capture mode.
- ③ **Main switch**
Move to turn the camera on and off. (p.59)
- ④ **Front e-dial ()**
Use this to display the next or previous image.
- ⑤ ** (Delete) button**
Press to delete images. (p.74)
- ⑥ ** (Playback) button**
Press to switch to Capture mode.
- ⑦ **INFO button**
Changes the style of the display on the monitor. (p.30)
- ⑧ **Rear e-dial ()**
Use this to change the magnification in the enlarged view (p.211) or display multiple images at the same time (p.212).

- ⑨ **AE-L button**
When the file format of the last captured image is JPEG, and its data still remains in the buffer memory, press this button to save the image in RAW format. (p.74)
- ⑩ ** (Green) button**
Press in the enlarged view to decrease the magnification. (p.211)
- ⑪ **OK button**
Confirms the setting you selected in the menu screen or playback screen.
- ⑫ **Four-way controller ()**
When a menu screen or playback screen is displayed, use this to move the cursor or change items.
Press the four-way controller () to display the playback mode palette. (p.208)
- ⑬ **MENU button**
Press to display the [ Playback 1] menu (p.209).

Monitor

The various information appears on the monitor depending on the status of the camera.



The brightness and the color of the monitor can be adjusted. (p.260, p.261)

1

Before Using Your Camera

At Start-up or when Operating the Mode Dial

Guides appear on the monitor for 3 seconds (default setting) when the camera is switched on or the mode dial is turned.

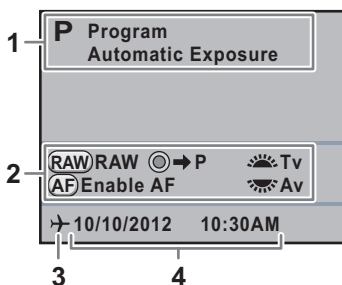

- | | |
|------------------------|--------------------------------|
| 1 Exposure Mode (p.88) | 3 World Time (p.253) |
| 2 Guide indicator | 4 Current date and time (p.62) |

* 3 appears only when [World Time] is set to [Destination].



- Select [Off] for [Guide Display] in the [Set-up 1] menu to not show guides. (p.257)
- When the mode dial is set to **USER**, the screen for selecting one of the **USER** modes from **USER 1** to **USER 5** is displayed for 30 seconds regardless of the [Guide Display] setting. (p.205)

Capture Mode

While shooting, the status screen is displayed showing the current shooting function settings. You can change the type of the screen displayed by pressing the **INFO** button.

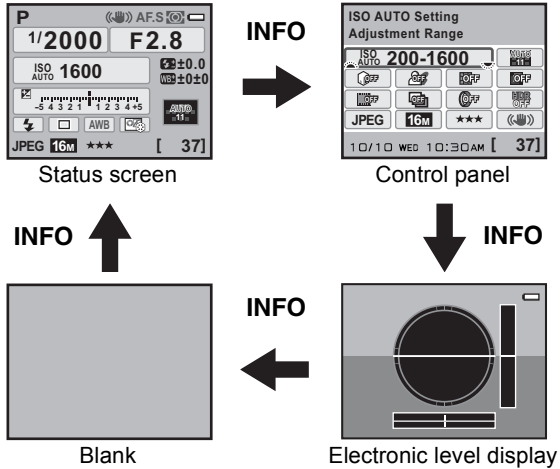

[Electronic Level] is (Off) by default. Set in the [📷 Rec. Mode 4] menu. (p.262)

● Status screen

(All items are displayed here for explanatory purposes. The actual display may differ.)

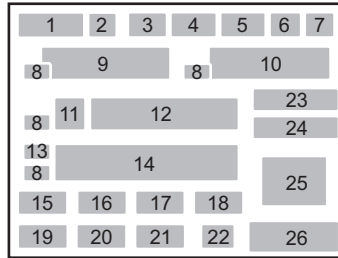
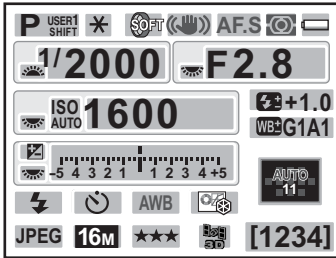

- | | |
|--|--|
| 1 Exposure Mode (p.88) | 14 EV bar |
| 2 AE Lock (p.107) | 15 Flash Mode (p.69) |
| 3 Interval Shooting (p.133)/Multi-exposure (p.136)/Extended Bracketing (p.141)/Digital Filter (p.143)/HDR Capture (p.191) | 16 Drive Mode (p.78) |
| 4 Shake Reduction (p.122)/Horizon Correction (p.123) | 17 White Balance (p.183) |
| 5 Focus Mode (p.108) | 18 Custom Image (p.197) |
| 6 Metering Method (p.103) | 19 File Format (p.180) |
| 7 Battery level (p.51) | 20 JPEG Recorded Pixels (p.178) |
| 8 E-dial guide | 21 JPEG Quality (p.179) |
| 9 Shutter speed | 22 GPS positioning status |
| 10 Aperture value | 23 Flash Exposure Compensation (p.71) |
| 11 ISO/ISO AUTO | 24 White Balance fine-tuning (p.184)/Cross Processing (p.200) |
| 12 Sensitivity (p.83) | 25 AF point (p.113) |
| 13 EV Compensation (p.105)/Exposure Bracketing (p.138) | 26 Remaining image storage capacity/⊙ button guide |

* Indicator 22 appears only when the optional GPS unit is attached to the camera and is operating. (p.305)

● Control panel

Press the **INFO** button in the status screen to display the control panel and change settings. (p.41)

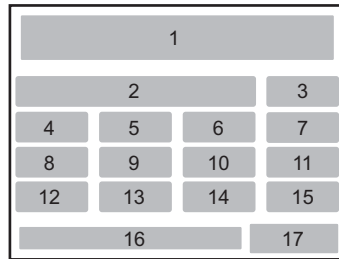
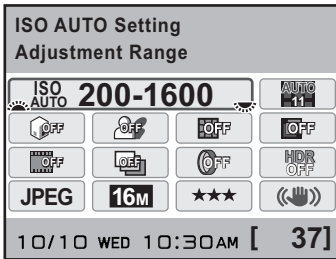

- | | | | |
|---|---|----|----------------------------------|
| 1 | Function name | 10 | Digital Filter (p.143) |
| 2 | ISO AUTO Setting (p.84) | 11 | HDR Capture (p.191) |
| 3 | AUTO AF Point Setting (p.113) | 12 | File Format (p.180) |
| 4 | Highlight Correction (p.190) | 13 | JPEG Recorded Pixels (p.178) |
| 5 | Shadow Correction (p.190) | 14 | JPEG Quality (p.179) |
| 6 | Distortion Correction (p.193) | 15 | Shake Reduction (p.122) |
| 7 | Lateral Chromatic Aberration Adjustment (p.193) | 16 | Current date and time |
| 8 | Cross Processing (p.200) | 17 | Remaining image storage capacity |
| 9 | Extended Bracketing (p.141) | | |



- Settings that cannot be changed due to the current camera setup cannot be selected.
- When [Status Screen] (p.258) in the [Set-up 1] menu is set to (Off), the status screen is not displayed.
- On the status screen, the setting currently being changed or guide display for the buttons that can be operated are displayed in blue (when [Status Screen] (p.258) in the [Set-up 1] menu is set to [Display Color 1]).
- The status screen will disappear if no operations are made within 30 seconds. Press the **INFO** button to display it again.
- If no operations are made within 30 seconds in the control panel, the status screen will reappear.
- [9999] is the maximum number of recordable images that can be displayed on the status screen and in the control panel. Even if the number of recordable images is 10,000 or more, [9999] is displayed.

Electronic level display

This camera is equipped with an electronic level for detecting whether the camera is level. When [Electronic Level] is set to (On), press the **INFO** button while the control panel is displayed to view the electronic level. When [Electronic Level] is assigned to the **RAW/Fx** button, press the **RAW/Fx** button to switch the display on/off. A bar graph indicating the horizontal camera angle appears at the bottom of the screen, and a bar graph indicating the vertical camera angle appears on the right side.

Example:

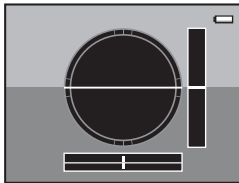

Horizontally and vertically level (green)

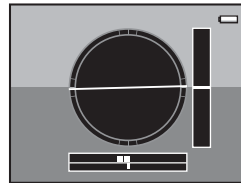

Tilted 1.5° to the left (yellow)
Vertically level (green)

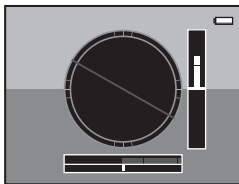

Outside horizontal level display (red)
Tilted 5° up (yellow)

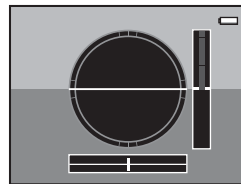

Horizontally level (green)
Outside vertical level display (red)



- [Electronic Level] is (Off) by default. Set in the [📷 Rec. Mode 4] menu. (p.262)
- Refer to p.249 for assigning a function to the **RAW/Fx** button.
- The electronic level display will disappear if no operations are made within 1 minute.
- If the camera angle cannot be detected, both ends and the center of the bar graphs flash red.

When holding the camera vertically

If the camera is held vertically while measuring the brightness, the status screen or control panel is displayed vertically. The directions of the four-way controller (▲▼◀▶) also change to match the orientation of the camera.

To always display the contents of the screen horizontally, set in [Status Screen] of the [↖ Set-up 1] menu. (p.258)

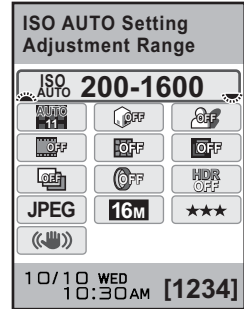

Playback Mode

The camera switches the types of information display when you press the **INFO** button during playback.

Standard	Captured image, file format, and guides are displayed.
Histogram display	Captured image and histogram (Brightness/RGB) are displayed. Not available during movie playback. (p.33)
Detailed information display	Detailed information on how and when the image was taken is displayed. (p.31)
No info. display	Only captured image is displayed.

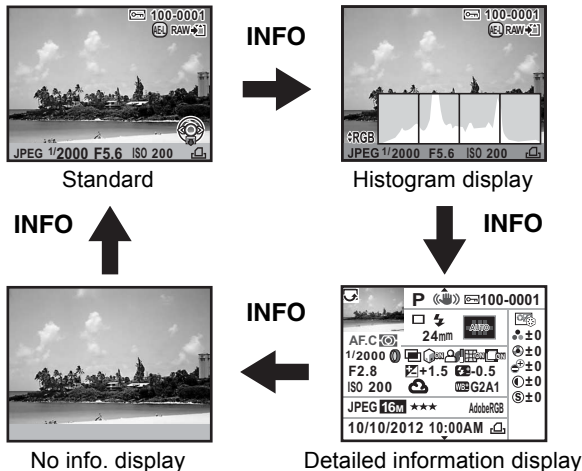



The type of information display that is shown first during playback is the same as that of the last playback in the previous session. If [Playback Info Display] is set to (Off) in [Memory] of the [Rec. Mode 5] menu, the [Standard] screen is always displayed first when the camera is turned on. (p.274)

● Detailed information display

Use the four-way controller (▲▼) to switch between pages.

(All items are displayed here for explanatory purposes. The actual display may differ.)

Page 1

Still Picture

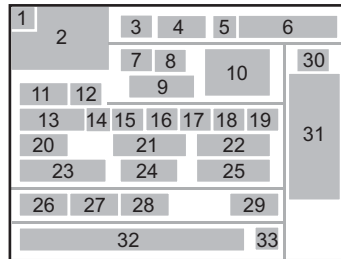

Movie

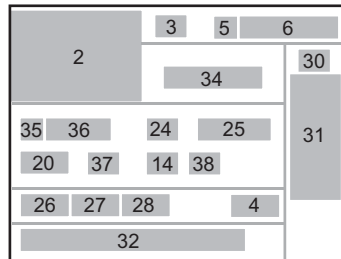

Page 2

Still Picture/Movie

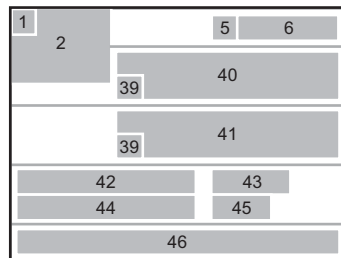
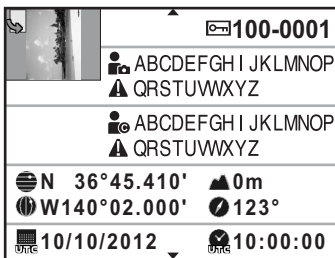

- | | |
|---|--|
| 1 Rotation information (p.219) | 22 Flash Exposure Compensation (p.71) |
| 2 Captured image | 23 Sensitivity (p.83) |
| 3 Exposure Mode (p.88) | 24 White Balance (p.183) |
| 4 Shake Reduction (p.122)/
Horizon Correction (p.123) | 25 White Balance fine-tuning (p.184) |
| 5 Protect (p.222) | 26 File Format (p.180) |
| 6 Folder number-File number (p.263) | 27 Recorded Pixels (p.152, p.178) |
| 7 Drive Mode (p.78) | 28 Quality Level (p.152, p.179) |
| 8 Flash Mode (p.69) | 29 Color Space (p.189) |
| 9 Focal Length | 30 Image finishing tone (p.197) |
| 10 AF point (p.113)/
Autofocus Method (p.147) | 31 Custom Image parameters (p.198) |
| 11 Focus Mode (p.108) | 32 Shooting date and time |
| 12 Metering Method (p.103) | 33 DPOF settings (p.271) |
| 13 Shutter speed | 34 Recording time |
| 14 Digital Filter (p.143) | 35 Sound setting (p.153) |
| 15 Multi-exposure (p.136)/
Extended Bracketing (p.141)/
HDR Capture (p.191)/
Cross Processing (p.200) | 36 Sound type |
| 16 Highlight Correction (p.190) | 37 Drive Mode (Remote Control) |
| 17 Shadow Correction (p.190) | 38 Cross Processing (p.200) |
| 18 Distortion Correction (p.193) | 39 Information tampering warning |
| 19 Lateral Chromatic Aberration Adjustment (p.193) | 40 Photographer (p.269) |
| 20 Aperture value | 41 Copyright Holder (p.269) |
| 21 EV Compensation (p.105) | 42 Latitude |
| | 43 Altitude |
| | 44 Longitude |
| | 45 Lens direction |
| | 46 Universal Coordinated Time |

* Indicators 42 to 46 appear only for images in which GPS information is stored.

● Histogram display

The following histograms can be displayed when playing back still pictures. The “Brightness histogram” shows the distribution of brightness and the “RGB histogram” shows the distribution of color intensity. Press the four-way controller (▲▼) to switch between “Brightness histogram” and “RGB histogram”.

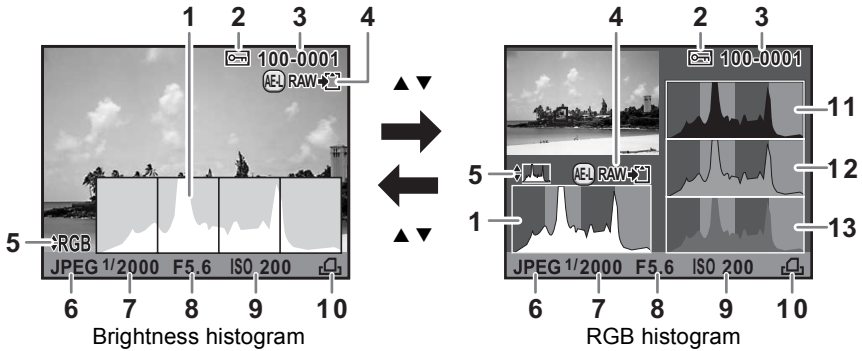

- | | |
|---|------------------|
| 1 Histogram (Brightness) | 7 Shutter speed |
| 2 Protect | 8 Aperture value |
| 3 Folder number-File number | 9 Sensitivity |
| 4 Save RAW data | 10 DPOF settings |
| 5 Switch RGB histogram/
Brightness histogram | 11 Histogram (R) |
| 6 File Format | 12 Histogram (G) |
| | 13 Histogram (B) |

* Indicator 2 appears only for protected images.

* Indicator 4 appears only when the file format of the last captured image is JPEG, and its data still remains in the buffer memory. (p.74)



If [Bright/Dark Area] (p.210) in the [▶ Playback 1] menu is set to (On), areas affected by bright or dark portions blink (except when in RGB histogram display and Detailed information display).

Using the Histogram

A histogram shows the brightness distribution of an image. The horizontal axis represents brightness (dark at the left and bright at the right) and the vertical axis represents the number of pixels.

The shape and the distribution of the histogram before and after shooting tell you whether the exposure level and contrast are correct or not, and lets you decide if you need to adjust the exposure and take a picture again.

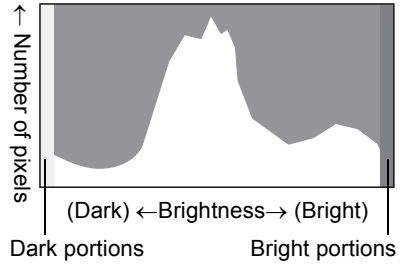

- ☞ Adjusting Exposure (p.105)
- ☞ Adjusting Brightness (p.190)

When the image is too dark, the part to the left is cut off (dark portions with no detail) and when the image is too bright, the part to the right is cut off (bright portions with no detail).

Bright portions blink red and dark portions blink yellow on the monitor when [Bright/Dark Area] is (On).

- ☞ Playing Back Images (p.73)
- ☞ Setting the Playback Display Method (p.210)
- ☞ Setting the Display for Instant Review (p.259)













Distribution of color intensity is displayed for each color in the RGB histogram. The right side of the graphs look similar for images that have White Balance adjusted well. If only one color is lopsided to the left, that color is too intense.

- ☞ Setting the White Balance (p.183)

Guide Indicators

The following indicators appear on the monitor to indicate the keys, buttons and e-dials that can be operated at that time.

Example:

	Four-way controller (▲)		OK button
	Four-way controller (▼)		Green button
	Four-way controller (◀)		AE-L button
	Four-way controller (▶)		Trash button
	Front e-dial		Shutter release button
	Rear e-dial		RAW/Fx button
	MENU button		

Viewfinder

The following information appears in the viewfinder.

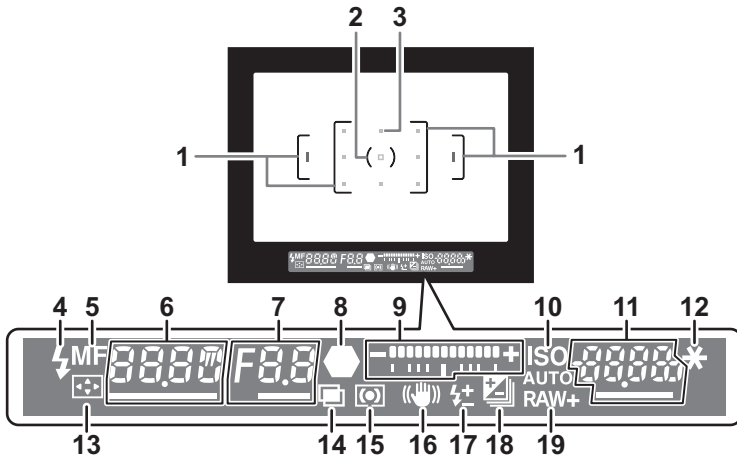

- 1 AF frame
- 2 Spot metering frame (p.104)
- 3 AF point (p.113)
- 4 Flash indicator (p.69)
Lit: when the flash is available.
Blinks: when the flash is recommended but not set or is being charged.
- 5 Focus Mode (p.116)
Appears when the focus mode is set to **MF**.
- 6 Shutter speed
Underlined when the shutter speed can be adjusted.
Displays a countdown of processing time when the Noise Reduction function is activated. (p.85)
- 7 Aperture value
Underlined when the aperture value can be adjusted.
[nr] blinks when the Noise Reduction function is activated. (p.85)
- 8 Focus indicator (p.67)
Lit: when the subject is focused.
Blinks: when the subject is not in focus.
- 9 EV bar
Displays the EV compensation values or difference between the appropriate and current exposure values when the exposure mode is set to **M** or **X**. (p.105)
Displays the camera angle when [Electronic Level] is (On). (p.39)

- 10** ISO/ISO AUTO
Appears when the sensitivity is displayed.
- 11** Sensitivity/Remaining image storage capacity
Underlined when the sensitivity can be adjusted.
Displays the number of recordable images immediately after shooting.
Displays the compensation value while adjusting the EV compensation.
Displays the amount of deviation from the correct exposure when the exposure mode is set to **M** or **X** and [Electronic Level] is set to (On). (p.100)
- 12** AE Lock (p.107)
Appears while the AE Lock function is activated.
- 13** Changing AF point (p.114)
Appears when the AF point can be changed with the AF point switching dial set to **SEL** (Select).
- 14** Multi-exposure (p.136)
Appears when Multi-exposure is set.
- 15** Metering Method (p.103)
Appears when the metering method is (Center-weighted metering) or (Spot metering).
- 16** Shake Reduction (p.122)
Appears when the Shake Reduction function is activated.
- 17** Flash Exposure Compensation (p.71)
Appears when the flash exposure compensation is in use.
- 18** EV Compensation (p.105)/Exposure Bracketing (p.138)
Appears when adjusting the EV compensation or when the drive mode is set to [Exposure Bracketing].
- 19** File Format (p.180)
Displays the image save format in RAW/RAW+ format.
Not displayed in JPEG format.



- The information is displayed in the viewfinder when the shutter release button is pressed halfway and during the meter operating time (default setting: 10 sec.). (p.104)
- The AF point(s) in use for autofocus appear in red (Superimpose AF Area) when the shutter release button is pressed halfway. (p.113)
- When [Cancel AF] is assigned to [AF Button] in [Button Customization] of the [📷 Rec. Mode 5] menu, **MF** is displayed in the viewfinder while the **AF** button is pressed. (p.110)
- [9999] is the maximum number of recordable images that can be displayed in the viewfinder. Even if the number of recordable images is 10,000 or more, [9999] is displayed.

LCD Panel

The following information appears in the LCD panel on top of the camera.

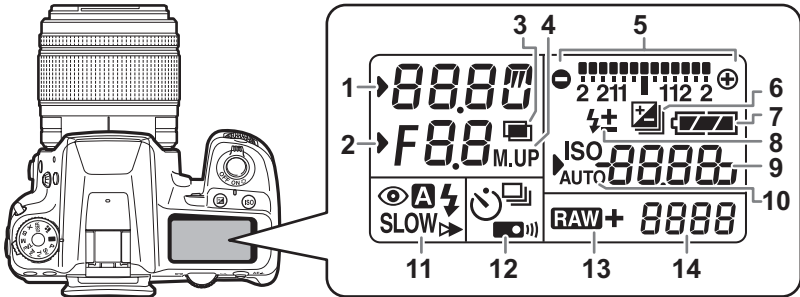

- | | |
|--|---|
| <p>1 Shutter speed/
Countdown of Noise Reduction
processing time (p.85)</p> <p>2 Aperture value
nr : Noise Reduction is
activated (p.85)</p> <p>3 Multi-exposure (p.136)</p> <p>4 Mirror Lock-up Shooting (p.130)</p> <p>5 EV bar (p.105)/
Electronic Level (p.39)</p> <p>6 EV Compensation (p.105)/
Exposure Bracketing (p.138)</p> <p>7 Battery level (p.51)</p> <p>8 Flash Exposure Compensation
(p.71)</p> <p>9 Sensitivity/EV compensation
value</p> <p>10 ISO/ISO AUTO
Appears when the sensitivity is
displayed.</p> | <p>11 Flash Mode (p.78)
⚡ : Built-in flash is ready
(when blinking, flash
should be used)</p> <p>👁️ : Red-eye Reduction
A : Auto Flash Discharge
SLOW : Slow-speed Sync
▶️ : Trailing Curtain Sync
W : Wireless</p> <p>12 Drive Mode (p.78)
□ : Single Frame Shooting
📄 : Continuous Shooting
⌚ : Self-timer Shooting
📡 : Remote Control Shooting</p> <p>13 File Format (p.180)
RAW : RAW capture
RAW+ : RAW+JPEG capture</p> <p>14 Remaining image storage
capacity/USB Connection mode
(p.279)
Pc-S : MSC mode
Pc-P : PTP mode</p> |
|--|---|



LCD panel is illuminated when the exposure metering is performed. You can choose [High], [Low] or [Off] for LCD panel backlight in [22. LCD Panel Illumination] of the [C Custom Setting 4] menu.

Electronic level display

When the camera is not level, a bar graph indicating the horizontal camera angle is displayed in the viewfinder and on the LCD panel.

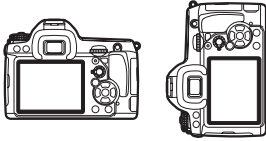

When level (at 0°)



When tilted 5° to the left



When held vertically and tilted 3° to the right



- [Electronic Level] is (Off) by default. Set in the [📷 Rec. Mode 4] menu. (p.262)
- The composition can also be adjusted in the camera when the camera is stabilized using a tripod. (p.195)

Function settings can be changed using the direct keys, control panel or menus. Some functions can be changed using both the control panel and menus.

This section explains the basic ways to change function settings.

Using the Direct Keys

In Capture mode, you can set Drive Mode, Flash Mode, White Balance and Custom Image by pressing the four-way controller (▲▼◀▶). (p.78)

Below, how to set [Flash Mode] is explained as an example.

- 1 Press the four-way controller (▼) in Capture mode.

The [Flash Mode] screen appears.

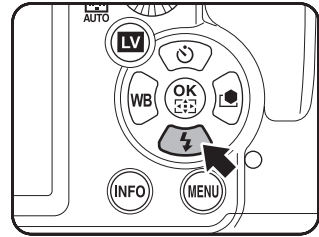

- 2 Use the four-way controller (◀▶) to select a flash mode.

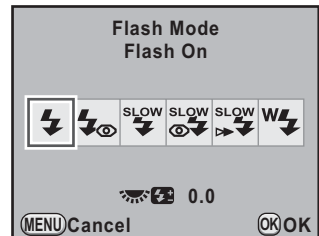

- 3 Press the OK button.

The camera is ready to take a picture.

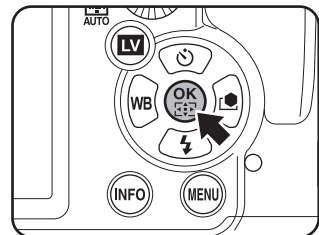



While direct key operation is enabled, the guide indicators for the direct keys are displayed in blue (when [Status Screen] (p.258) in the [Set-up 1] menu is set to [Display Color 1]). Direct key operation is not available when the AF point switching dial is set to **SEL** and the AF point is being changed. In such cases, press and hold the **OK** button. (p.114)

Using the Control Panel

While shooting, the current settings can be checked on the status screen. You can also switch the display to the control panel and change settings. Following, how to set [JPEG Quality] is explained as an example.

1 Check the status screen and then press the **INFO** button.

The control panel appears.

Press the **INFO** button when the status screen is not displayed.

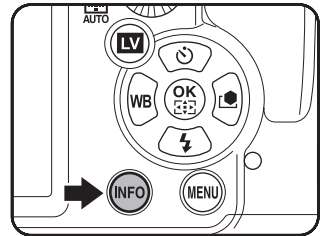

2 Use the four-way controller (▲▼◀▶) to select an item you want to change the setting for.

Items that cannot be changed for the current camera settings appear grayed out and cannot be selected.

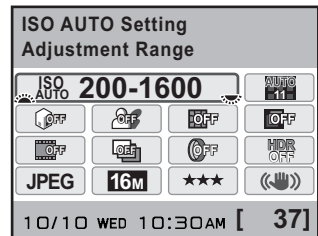

3 Use the front e-dial (☀) or rear e-dial (☀) to change the setting.

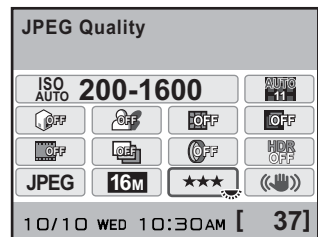

4 Press the **MENU** button or the shutter release button halfway.

The camera returns to the status screen and is ready to take a picture.

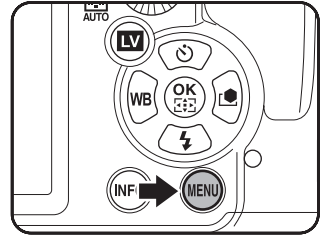

1

Before Using Your Camera



- Press the **OK** button in Step 3 to display the detailed setting screen for the selected item. Make the detailed settings for functions such as Extended Bracketing and Digital Filter on the detailed setting screen.
- The status screen and control panel are not displayed when Live View (p.146) is displayed. Make or change necessary settings in the [📷 Rec. Mode] menu in advance.

Using the Menus

This section explains how to use the menus: [📷 Rec. Mode], [▶ Playback], [🔧 Set-up] and [⚙ Custom Setting] menus.

Following, how to set [Program Line] in the [📷 Rec. Mode 3] menu is explained as an example.

1 Press the **MENU** button in Capture mode.

The [📷 Rec. Mode 1] menu appears on the monitor.

If the **MENU** button is pressed in Playback mode, the [▶ Playback 1] menu appears.

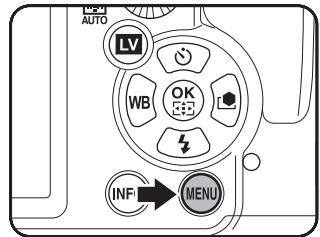

2 Press the four-way controller (▶) twice or turn the rear e-dial (☀) two clicks to the right (toward Q).

Each time the four-way controller (▶) is pressed, the menu will change in the following sequence: [📷 Rec. Mode 2], [📷 Rec. Mode 3], [📷 Rec. Mode 4], [📷 Rec. Mode 5], [▶ Playback 1] ... [📷 Rec. Mode 1].

When the front e-dial (☀) is turned to the right, the menu will change in the following sequence: [📷 Rec. Mode 1], [▶ Playback 1], [🔍 Set-up 1], [C Custom Setting 1].

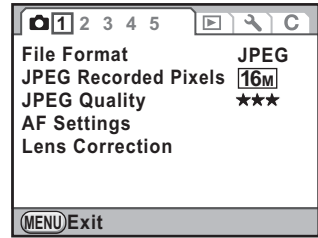

3 Use the four-way controller (▲▼) to choose an item.

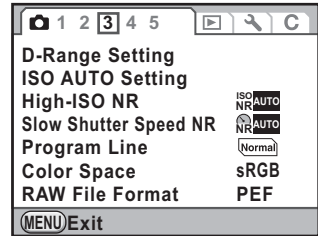

4 Press the four-way controller (▶).

Available settings are displayed in the pop-up menu or submenu.

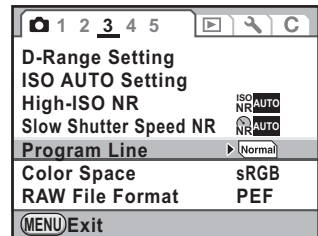

5 Use the four-way controller (▲▼) to select a setting.

Press the **MENU** button to cancel the pop-up menu, or return to the previous screen.

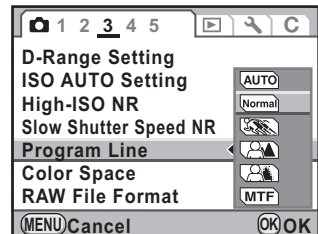

6 Press the OK button.

The setting is saved.

Press the **MENU** button if a submenu is displayed.

Next, set other items.

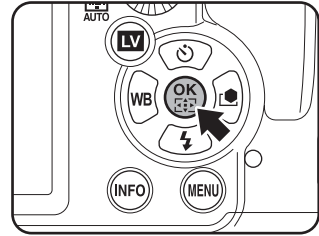

7 Press the MENU button.

The screen that was displayed before selecting the menu appears again.

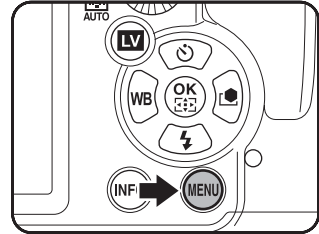

Even after you press the **MENU** button and close the menu screen, your settings will not be saved if the camera is turned off improperly (such as by removing the battery while the camera is on).



- You can select whether to display the menu tab selected the last time first, or to always display the [📷 Rec. Mode 1] menu first. (p.258)
- Refer to the following pages for details on each menu.
 - [📷 Rec. Mode] menu p.79
 - [▶ Playback] menu p.209
 - [🔧 Set-up] menu p.244
 - [C Custom Setting] menu p.81

You can switch the exposure modes by setting the icons on the mode dial to the dial indicator.

Turn the mode dial while pressing the mode dial lock button.

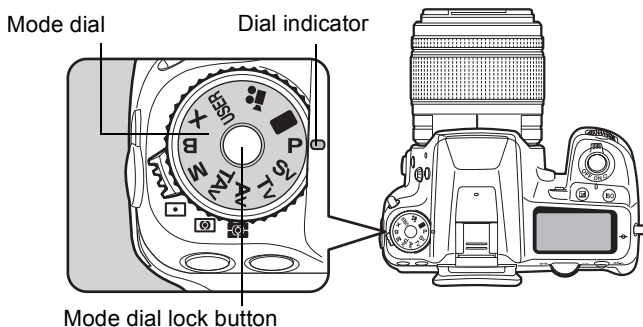

Mode	Characteristics	Page
Green Green	Lets you capture images with fully automatic settings.	p.90
P Program Automatic Exposure	Automatically sets the shutter speed and aperture value to obtain a proper exposure according to Program Line when taking pictures. You can use the front and rear e-dials to switch between shutter priority and aperture priority.	p.91
Sv Sensitivity Priority Automatic Exposure	Automatically sets the shutter speed and aperture value to obtain a proper exposure according to the set sensitivity.	p.92
Tv Shutter Priority Automatic Exposure	Lets you set the desired shutter speed for expressing the movement of the subject.	p.94
Av Aperture Priority Automatic Exposure	Lets you set the desired aperture value for controlling the depth of field.	p.95
TA Shutter & Aperture Priority Automatic Exposure	Automatically sets the sensitivity to obtain a proper exposure with the set shutter speed and aperture value according to the brightness of the subject.	p.97
M Manual Exposure	Lets you set the shutter speed and aperture value to capture the picture with creative intent.	p.98
B Bulb Exposure	Lets you capture images that require slow shutter speeds such as fireworks and night scenes.	p.101

Mode	Characteristics	Page
X Flash X-sync Speed	The shutter speed is locked at 1/180 second. Use this when using an external flash that does not automatically set the sync speed.	p.102
USER	Lets you capture images with the saved exposure mode. Up to five settings can be saved.	p.202
 Movie	Use this to record movies.	p.155

2 Getting Started

This chapter explains your first steps from purchasing the camera to taking pictures. Be sure to read it and follow the instructions.

Attaching the Strap	48
Inserting the Battery	49
Inserting/Removing an SD Memory Card	54
Attaching a Lens	56
Adjusting the Viewfinder Diopter	58
Turning the Camera On and Off	59
Initial Settings	60

Attaching the Strap

2

Getting Started

- 1** Pass the end of the strap through the protective cover and triangular ring.

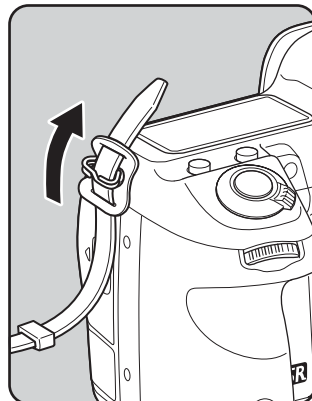

- 2** Secure the end of the strap on the inside of the clasp.

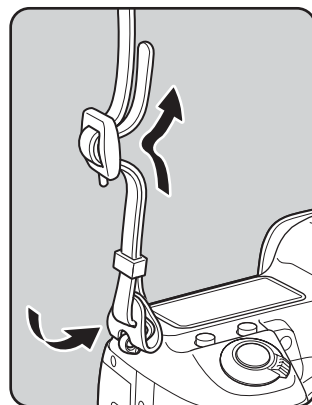
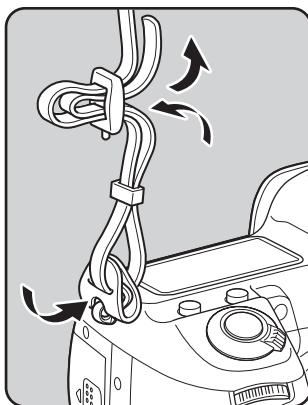

- 3** Attach the other end of the strap in the same manner as described above.

Insert the battery into the camera. Use only a D-LI90 battery.

Charging the Battery

When using the battery for the first time, or when the battery has not been used in a long time, or when [Battery depleted] appears, recharge the battery.

Note: AC plug cord “Listed, Type SPT-2 or NISPT-2, 18/2 flexible cord, rated 125 V, 7A, minimum 6ft (1.8m)”

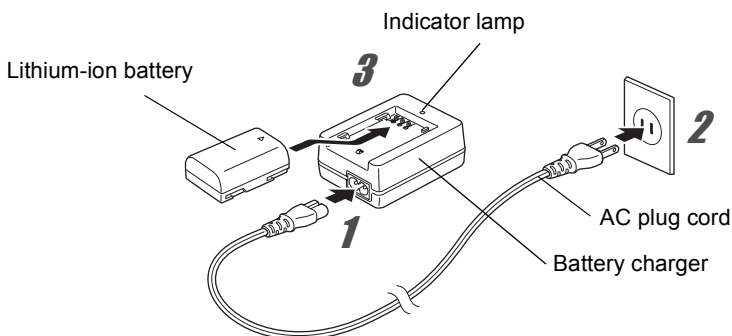

- 1** Connect the AC plug cord to the battery charger.
- 2** Plug the AC plug cord into the power outlet.
- 3** Face the ▲ mark on the battery up and insert it into the battery charger.

The indicator lamp is lit during charging and turns off when the battery is fully charged.

- 4** When the battery is fully charged, remove the battery from the battery charger.



- Do not use the provided battery charger D-BC90 to charge batteries other than D-LI90. Charging other batteries may cause damage or heating.
- Replace the battery with a new one in the following cases:
 - If the indicator lamp blinks or does not light after the battery is inserted correctly
 - If the battery starts to run down more quickly even after being charged (the battery may have reached the end of its service life)



The maximum charging time is approximately 390 minutes (it depends on temperature and remaining battery power.) Charge in a location where the temperature is between 0°C and 40°C.

Inserting/Removing the Battery



- Do not open the battery cover or remove the battery while the power is on.
- Insert the battery correctly. Inserting the battery incorrectly may cause a camera breakdown. Wipe the electrodes of the battery with a soft dry cloth before inserting.
- Be careful as the camera or battery may become hot when the camera is used continuously for a long period of time.
- Remove the battery when you will not use the camera for a long while. The battery may leak and damage the camera if left installed during prolonged periods of non-use. If the removed battery will not be used for six months or longer, charge the battery for about 30 minutes before storing it. Be sure to recharge the battery every six to twelve months.
- Store the battery in a location where the temperature will remain below room temperature. Avoid locations with high temperatures.
- The date and time may be reset if you leave the battery out of the camera for long periods of time. If this occurs, follow the procedure described in “Setting the Date and Time” (p.62) to set the current date and time.

1

Open the battery cover.

Lift the battery cover unlock knob, turn it towards OPEN (①) to unlock, and then pull the cover open (②).

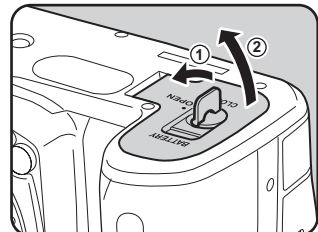

- 2** Face the ▲ mark on the battery towards outside of the camera, push the battery lock lever in the direction of the arrow (③) and insert the battery.

Insert until the battery locks.

To remove the battery, push the battery lock lever in the direction of the arrow (③) with your finger.

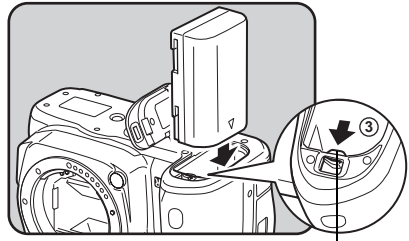



Battery lock lever



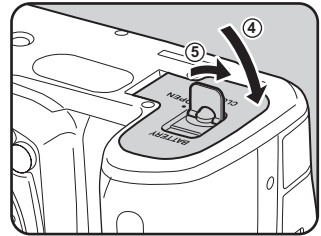





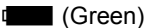

- 3** Close the battery cover (④) and turn the battery cover unlock knob towards CLOSE (⑤) to lock.

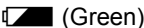
Stow the battery cover unlock knob after closing the battery cover.

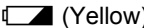

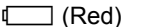
Battery Level Indicator

You can confirm remaining battery level by checking the  /  displayed on the status screen and LCD panel.

Status Screen	LCD Panel	Battery Level
 (Green)		Battery is full.
 (Green)		Battery is close to full.
 (Yellow)		Battery is running low.
 (Red)	 lit	Battery is almost empty.
[Battery depleted]	 blinks	The camera turns off after displaying the message. ( continues blinking on the LCD panel.)



- , , or may appear even when the battery level is sufficient if the camera is used at low temperatures or when performing continuous shooting for a long period of time.
- Battery performance temporarily decreases as the temperature decreases. When using the camera in cold climates, have extra batteries on hand and keep them warm in your pocket. Battery performance will return to normal when returned to room temperature.
- Have extra batteries ready when traveling overseas, taking pictures in cold climates, or taking a lot of pictures.

Using the AC Adapter (Optional)

We recommend the use of the AC adapter kit K-AC132 (optional) when using the monitor for a long time or when connecting the camera to a computer or AV device.



The AC Adapter Kit K-AC132 includes AC Adapter D-AC120 and AC plug cord.

1

Make sure the camera is turned off.

2

Open the terminal cover.

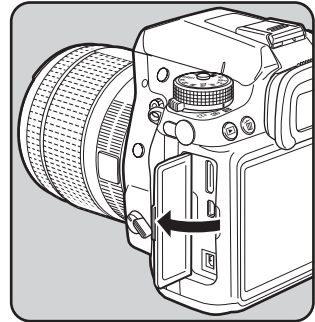

- 3** Face the ▲ mark on the DC terminal of the AC adapter towards the ▲ mark on the camera, and connect the DC terminal to the DC input terminal of the camera.

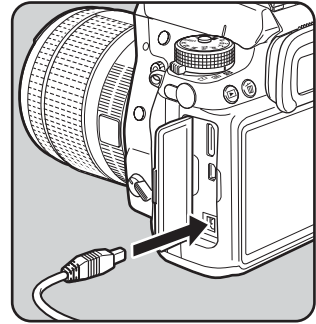

- 4** Connect the AC plug cord to the AC adapter.

- 5** Plug the AC cord into the power outlet.



- Make sure the camera is turned off before connecting or disconnecting the AC adapter.
- Make sure connections are secure between the terminals. The SD Memory Card or data may be corrupted if disconnected while the card is being accessed.



- **DC IN** is displayed on the status screen when using the AC adapter.
- Be sure to read the manual of the AC adapter kit before using the AC adapter.
- The battery in your camera will not charge when connected to the AC adapter.

Inserting/Removing an SD Memory Card

This camera uses a commercially available SD Memory Card, SDHC Memory Card, or SDXC Memory Card.

Make sure the camera is turned off before inserting or removing the SD Memory Card.

2

Getting Started

Caution

- Do not remove the SD Memory Card while the card access lamp is lit.
- Use this camera to format (initialize) an SD Memory Card that is unused or has been used on other cameras or digital devices. Refer to “Formatting the SD Memory Card” (p.246) for details on formatting.
- Use a high-speed memory card when recording movies. If a write speed cannot keep up with a recording speed, the writing may stop during recording.

1 Make sure the camera is turned off.

2 Slide the card cover in the direction of the arrow and then lift it to open (①→②).

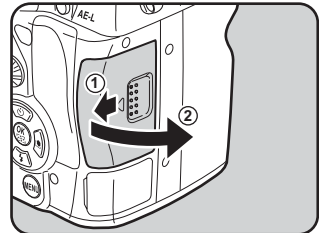

3 Insert the card all the way with the SD Memory Card label facing toward the monitor.

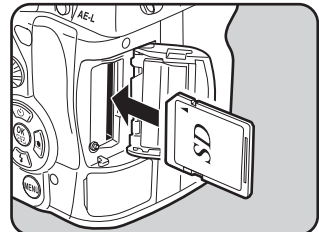

Push the SD Memory Card in once to remove.

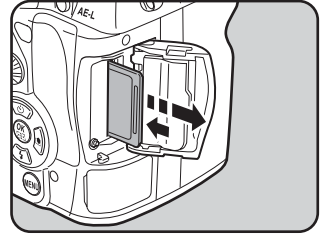

- 4** Close the card cover and then slide it in the direction of the arrow (③→④).

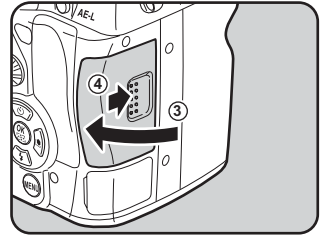

Be sure to fully close the card cover. The camera will not turn on if the card cover is open.



For details on the approximate number of still pictures and amount of time of movies that can be recorded on an SD Memory Card, refer to “Approximate Image Storage Capacity by Size” (p.320).

Attaching a Lens

Attach a proper lens to the camera's body.

When you use one of the following lenses with this camera, all the camera's exposure modes will be available.

- (a) DA, DA L, D FA, FA J lenses
- (b) Lenses with an **A** (Auto) position, when used in the **A** position

2

Getting Started



- Turn the camera off before attaching or removing the lens to prevent unexpected lens movement.
- When attaching or removing a lens, choose an environment that is relatively free of dirt and dust.
- Keep the body mount cover on the camera when a lens is not attached.
- Be sure to attach the lens mount cover and lens cap to the lens after removing the lens from the camera.
- The camera body and lens mount incorporate lens information contacts and an AF coupler. Dirt, dust, or corrosion may damage the electrical system. When necessary, clean the contacts with a soft dry cloth.
- When lenses described in (b) are used in a position other than **A**, some functions will be restricted. Refer to "Using the Aperture Ring" (p.299).
- With factory default setting, the camera will not work with lenses other than those listed above and accessories. Set [27. Using Aperture Ring] to [Permitted] in the [C Custom Setting 4] menu to use them. (p.299)
- We assume no responsibility nor liability for accidents, damages and malfunctions resulting from the use of lenses made by other manufacturers.

1 Make sure the camera is turned off.

2 Remove the body mount cover (①) and lens mount cover (②).

Be sure to put the lens down with the lens mount side facing upward to protect the lens mount from damage when there is no lens mount cover on the lens.

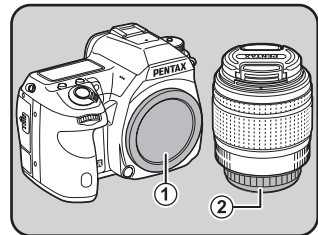

- 3** Align the Lens mount index (red dots; ③) on the camera and the lens, and secure by turning the lens clockwise until it clicks.

After attaching, turn the lens counterclockwise to check that the lens is locked in place.

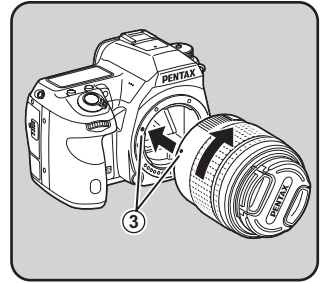

- 4** Remove the front lens cap by pushing the indicated portions inward.

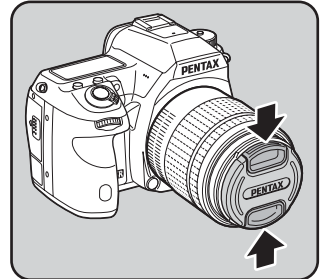

To remove the lens

Attach the lens cap first, and then turn the lens counterclockwise while holding down the lens unlock button (④).

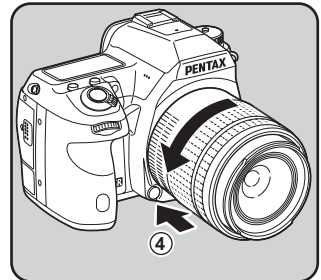

The body mount cover (①) is a cover to prevent scratches and block dust when shipped. Body Mount Cap K is sold separately and has a lock function.

Adjusting the Viewfinder Diopter

You can adjust the viewfinder diopter to suit your eyesight. The Eyecup F_R is attached to the viewfinder portion when the camera leaves the factory. The diopter can be adjusted with the eyecup attached. However, adjustment is easier with the eyecup removed.

2

Getting Started

- 1 Remove the eyecup by pulling it out in the direction of the arrow.

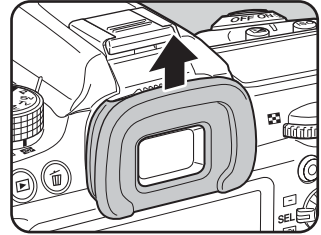

- 2 Look through the viewfinder and slide the diopter adjustment lever left or right.

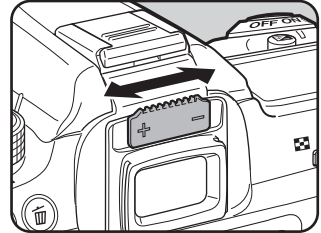

Adjust the lever until the AF frame in the viewfinder is focused.

Point the camera at a white wall or other bright and consistent surface.



AF frame





If it is difficult to see the viewfinder image clearly even if you use the diopter adjustment lever, use the optional diopter correction lens adapter M. However, the Eyecup F_R must be removed to use this adapter.

1 Turn the main switch to [ON].

The camera will turn on.

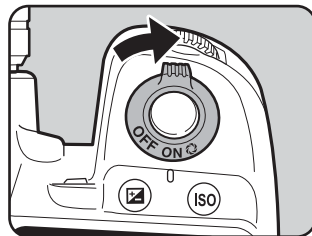
Set the main switch to the position [OFF] to turn off the camera.



- Always turn the camera off when not in use.
- The power will automatically turn off when you do not perform any operations within a set period of time. To reactivate the camera, turn it on again or perform any of the following.
 - Press the shutter release button halfway.
 - Press the  button, **MENU** button or **INFO** button.
- By default, the camera is set to turn off automatically after 1 minute of inactivity. You can change the setting in [Auto Power Off] of the [ Set-up 3] menu. (p.266)

The first time the camera is turned on after purchasing, the [Language/言語] screen appears on the monitor. Follow the procedure below to set the language displayed on the monitor and the current date and time.

If the [Date Adjustment] screen appears, set the date and time by following the procedure in "Setting the Date and Time" (p.62).

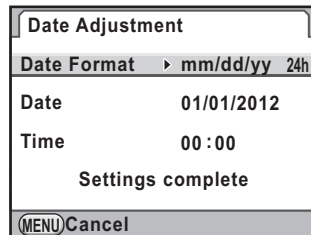

Setting the Display Language

You can choose the language in which the menus, error messages, etc. are displayed from the following: English, French, German, Spanish, Portuguese, Italian, Dutch, Danish, Swedish, Finnish, Polish, Czech, Hungarian, Turkish, Greek, Russian, Korean, Traditional Chinese, Simplified Chinese and Japanese.

1 Use the four-way controller (▲▼◀▶) to select the desired language.

2 Press the OK button.

The [Initial Setting] screen appears in the selected language.

Press the four-way controller (▼) twice and proceed to Step 10 on p.61 if ☰ (Hometown) does not have to be changed.

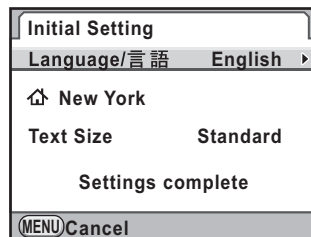

3 Press the four-way controller (▼).

The cursor moves to ☰.

4 Press the four-way controller (▶).

The [☰ Hometown] screen appears.

5 Use the four-way controller (◀▶) to select a city.

Turn the rear e-dial (☀️) to change the region.

Refer to “List of World Time Cities” (p.255) for cities that can be selected as a hometown.

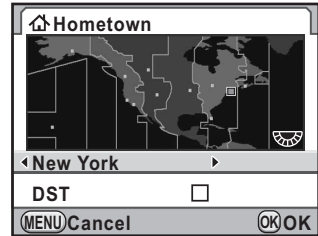

6 Press the four-way controller (▼).

The cursor moves to [DST] (daylight saving time).

7 Use the four-way controller (◀▶) to select or .

8 Press the OK button.

The camera returns to the [Initial Setting] screen.

9 Press the four-way controller (▼).

The cursor moves to [Text Size].

10 Press the four-way controller (▶) and use the four-way controller (▲▼) to select [Standard] or [Large].

Selecting [Large] increases the text size of the selected menu items.

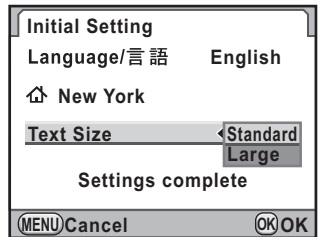

11 Press the OK button.

12 Press the four-way controller (▼) to select [Settings complete].

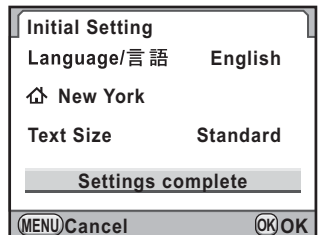

13 Press the OK button.

The [Date Adjustment] screen appears.



- You can change the text size from the [↖ Set-up 1] menu later. In this manual, the menu screens hereafter are described with [Text Size] set to [Standard].
- When the hometown and the date and time are not set, the [Initial Setting] screen or [Date Adjustment] screen will be displayed again next time the camera is turned on.

Setting the Date and Time

Set the current date and time and the display style.

1 Press the four-way controller (▶).

The frame moves to [mm/dd/yy].

2 Use the four-way controller (▲▼) to choose the date format.

Choose [mm/dd/yy], [dd/mm/yy] or [yy/mm/dd].

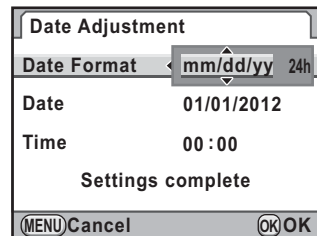

3 Press the four-way controller (▶).

The frame moves to [24h].

4 Use the four-way controller (▲▼) to select 24h (24-hour display) or 12h (12-hour display).

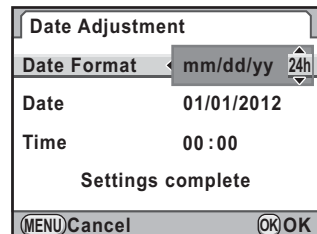

5 Press the **OK** button.

The frame returns to [Date Format].

6 Press the four-way controller (▼).

The frame moves to [Date].

7 Press the four-way controller (▶).

The frame moves to the month.

8 Use the four-way controller (▲▼) to set the month.

Set the day and year in the same manner.

Next, set the time.

If you select [12h] in Step 4, the camera switches between am and pm depending on the time.

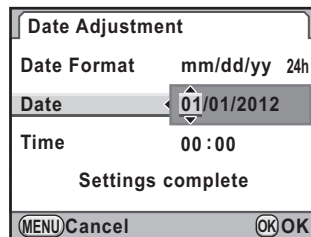

9 Press the four-way controller (▼) to select [Settings complete].

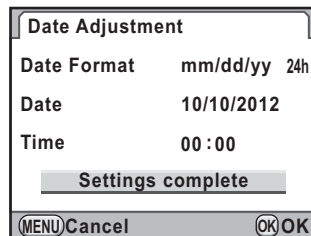

10 Press the **OK** button.

The camera returns to the status screen and is ready to take a picture.

If you set the date and time from the menu, the screen will return to the [🔍 Set-up 1] menu. In this case, press the **MENU** button.



- When you press the **OK** button in Step 10, the seconds value is set to 0. To set the exact time, press the **OK** button when the time signal (on the TV, radio, etc.) reaches 0 seconds.
- Pressing the **MENU** button while setting the date and time cancels the settings made up to that point and switches the camera to capture mode.
- You can change the language and date and time settings from the menu. (p.253, p.256)

Memo

3 Basic Operations

This chapter explains basic operations for shooting by setting mode dial to Green mode (automatic exposure according to the program line set to **AUTO**) to ensure successful capturing.

For information about advanced functions and settings for taking pictures, refer to chapter 4 and onward.

Basic Shooting Operation	66
Using the Built-in Flash	69
Playing Back Images	73

Letting the Camera Choose the Optimal Settings

This camera features various exposure modes, focus modes, and drive modes for expressing your photographic vision. This section explains how to take pictures by simply pressing the shutter release button.

3

Basic Operations

1 Set the mode dial to **■**.

Turn the mode dial while pressing the mode dial lock button.

The exposure mode changes to **■** (Green) mode. In **■** mode, a proper exposure is determined by the camera and the shutter speed and aperture value are automatically set.

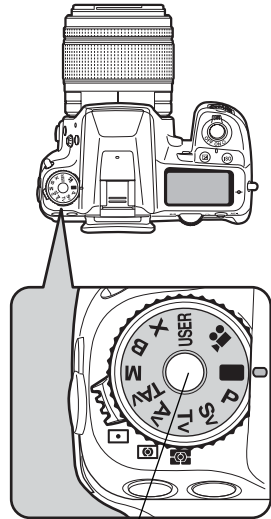

Mode dial lock button

2 Set the focus mode switch to **A.F.S.**

The focus mode changes to **A.F.S** (Autofocus/Single) mode. When the shutter release button is pressed halfway in **A.F.S**, the camera focuses automatically. (p.108)

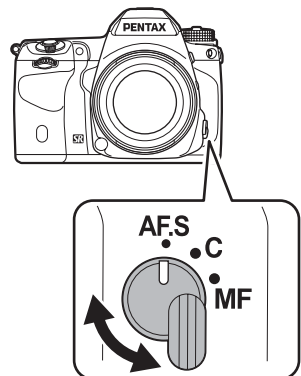

3 Look through the viewfinder to view the subject.

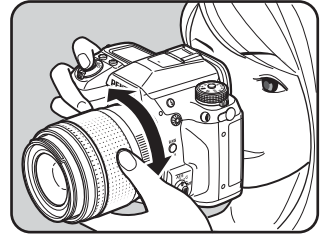

A zoom lens can be used to change the size of the subject in the viewfinder. (p.68)





4 Position the subject inside the AF frame and press the shutter release button halfway.

The autofocus system operates.

The focus indicator  appears and you will hear a beep when the subject comes into focus (focus lock).

The AF assist light turns on in a dark or backlit location, but the flash does not pop up automatically. If the flash is necessary, the flash status  blinks in the viewfinder. Press the  button to pop up the flash.

-  Using the Built-in Flash (p.69)
-  Selecting the Focusing Area (AF Point) (p.113)



Flash status

Focus indicator

5 Press the shutter release button fully.

The picture is taken.

This action is referred to as “releasing the shutter” or “release”.

6 Review the captured image on the monitor.

The image appears for 1 second on the monitor shortly after capturing (Instant Review).

-  Setting the Display for Instant Review (p.259)

You can magnify the image during Instant Review with the rear e-dial (). (p.211)

You can delete the image during Instant Review by pressing the  button.

-  Deleting a Single Image (p.74)



- Refer to p.90 for details on using **■** (Green) mode.
- The beep that sounds when the image is focused can be turned off. (p.252)
- You can set the camera so that pressing the **AF** button will focus automatically, in the same way as pressing the shutter release button halfway. (p.110)
- You can preview the image on the monitor and check the composition, exposure, and focus before shooting. (p.118)

Using a Zoom Lens

3

Basic Operations

Enlarge the subject (telephoto) or capture a wider area (wide angle) with a zoom lens. Adjust the subject to the desired size and take pictures.

1

Turn the zoom ring to the right or left.

Turn the zoom ring clockwise for telephoto and counterclockwise for wide angle.

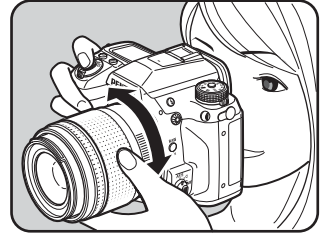

Power Zoom (Auto Zoom) is available if a Power Zoom compatible FA lens is used with this camera. (p.297)

Use the built-in flash when you want to take pictures in low light or backlit conditions.

The built-in flash is optimum for a subject at a distance from 0.7 m to 5 m. Exposure will not be properly controlled and vignetting (darkening of the corners of the image due to a lack of light) may occur when used at a distance closer than 0.7 m (this distance varies slightly depending on the lens being used and set sensitivity. (p.165))

Compatibility of built-in flash and lens

Vignetting may occur depending on the lens being used and the shooting conditions. We recommend taking a test shot to check the compatibility.

 Lens Compatibility with the Built-in Flash (p.166)











- When using the built-in flash, remove the lens hood before shooting.
- The built-in flash fully discharges for lenses without an **A** (Auto) position on the lens aperture ring.







For details on the built-in flash and instructions on how to take pictures with an external flash, refer to "Using the Flash" (p.161).

Setting the Flash Mode

Flash Mode	Function
 Auto Flash Discharge	Automatically measures the ambient light and determines whether to use the flash.
 Auto Flash+ Red-eye Reduction	Discharges a pre-flash for red-eye reduction before the automatic flash.
 Flash On	Discharges the flash for each picture.
 Flash On+ Red-eye Reduction	Discharges a pre-flash for red-eye reduction before the main flash.

Flash Mode	Function
 Slow-speed Sync	Sets to a slow shutter speed depending on the brightness. When using this to shoot a portrait with the sunset in the background, both the person and the background are captured beautifully.
 Slow-speed Sync+ Red-eye Reduction	Discharges a pre-flash for red-eye reduction before the main flash is discharged with Slow-speed Sync.
 Trailing Curtain Sync	Discharges the flash immediately before closing the shutter curtain. Captures moving objects as if they are leaving a light trail behind them. (p.164)
 Wireless Mode	You can synchronize one or more dedicated external flashes (AF540FGZ or AF360FGZ) without using a sync cord. (p.170)

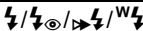
The flash modes that can be selected differ depending on the exposure mode.



Exposure Mode	Selectable Flash Mode	Restrictions
		No flash compensation
P/Av/Sv		-
Tv/TAv/M/B		-
X		-
USER	According to the saved settings	

1 Press the four-way controller (▼) in Capture mode.

The [Flash Mode] screen appears.

The flash modes that can be selected for the set exposure mode appear.

2 Use the four-way controller (◀▶) to select a flash mode.

When not in  (Green) mode, turn the rear e-dial () to perform the flash exposure compensation. (p.71)

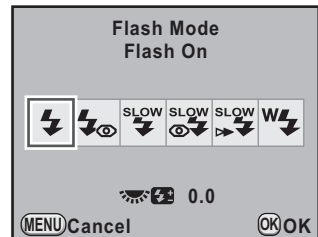

3 Press the OK button.

The camera is ready to take a picture.

Compensating for Flash Output

You can change the flash output in the range of -2.0 to +1.0. The flash compensation values are as follows for 1/3 EV and 1/2 EV.

Step Interval	Flash Compensation Value
1/3 EV	-2.0, -1.7, -1.3, -1.0, -0.7, -0.3, 0.0, +0.3, +0.7, +1.0
1/2 EV	-2.0, -1.5, -1.0, -0.5, 0.0, +0.5, +1.0

Set interval of steps in [1. EV Steps] of the [C Custom Setting 1] menu. (p.106)

1 Turn the rear e-dial (☀️) in the [Flash Mode] screen.

The flash compensation value is displayed.

Press the Ⓞ button to reset the flash output compensation value to 0.0.

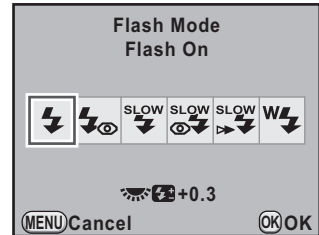

- The flash output compensation cannot be set in ■ (Green) mode.
- ⚡ appears in the viewfinder and on the LCD panel during the flash output compensation. (p.36, p.38)
- When the flash output exceeds its maximum amount, the compensation will not be effective even if the compensation value is set to the plus (+) side.
- Compensating to the minus (-) side may not affect the image if the subject is too close, the aperture value is small or the sensitivity is high.
- The flash output compensation is also effective for external flash units which support the P-TTL auto flash mode.

Enabling Shooting while Charging the Flash

You can set the camera to enable shooting while the built-in flash is charging.

Set [20. Release While Charging] to [On] in the [C Custom Setting 3] menu. By default, pictures cannot be taken while the built-in flash is charging.

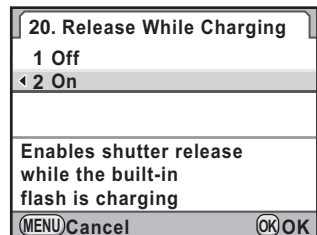

Using Built-in Flash

1 Press the button.

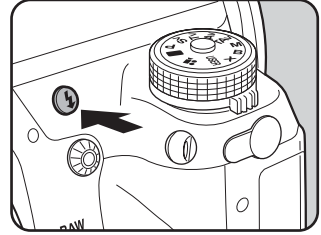

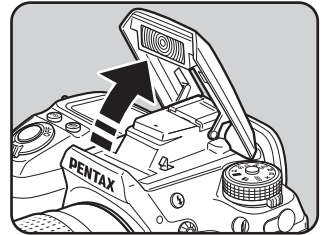

The built-in flash pops up and begins charging. When the flash is fully charged,  appears in the viewfinder and on the LCD panel. (p.36, p.38)



2 Press the shutter release button fully.

The picture is taken.

When the mode dial is at , the flash is not discharged if the lighting conditions do not require flash for correction even when the flash is popped up.

[Flash On] is used if the flash is popped up when the mode dial is at a position other than .

3 Push down on the portion indicated in the illustration to retract the built-in flash.

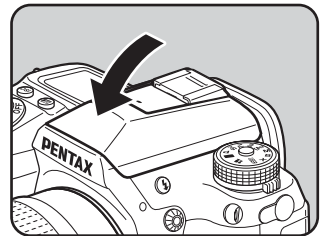

Playing Back Images

You can play back captured images with the camera.



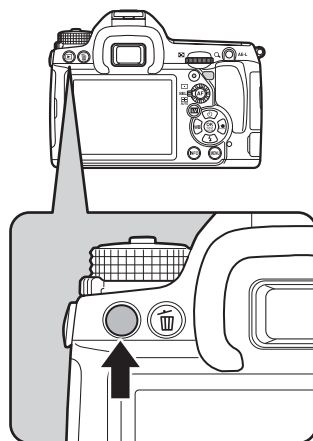

1 Press the button.

The camera enters Playback mode and the most recently captured image (image with the highest file number) is displayed on the monitor. (For movies, only the first frame is displayed on the monitor.)



2 Review the captured image on the monitor.

Available operations

Four-way controller ()/ Front e-dial () to the left	Displays the previous image.
Four-way controller ()/ Front e-dial () to the right	Displays the next image.
INFO button	Switches information display On/Off. (p.30)
AE-L button	Saves the RAW image (only when the data is available).



- When the file format of the last captured image is JPEG, and its data still remains in the buffer memory, you can save the image in RAW format by pressing the **AE-L** button during playback.
If the image was shot using any of the following settings, the corresponding RAW image listed is saved.

- Interval Shooting	RAW image of the last captured image
- Multi-exposure	RAW image with Multi-exposure
- Extended Bracketing	One out of the three images can be selected
- Digital Filter	RAW image without filter effect
- HDR Capture	RAW image with standard exposure
- Cross Processing	RAW image without Cross Processing

- Refer to “Playback Functions” (p.207) for details on the playback mode functions.

3

Deleting a Single Image

You can delete images one by one.



- Deleted images cannot be restored.
- Protected images cannot be deleted. (p.222)

1

Press the  button and use the four-way controller (◀▶) to select an image to delete.

2

Press the  button.

The delete confirmation screen appears.

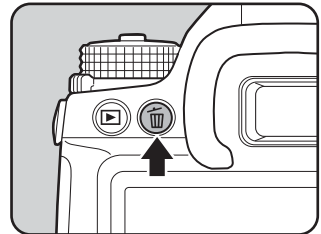

3 Press the four-way controller (▲) to select [Delete].

Select a file format to delete for images saved in RAW+ format.

Delete JPEG	Deletes only the JPEG image.
Delete RAW	Deletes only the RAW image.
Delete RAW+JPEG	Deletes images in both file formats.



4 Press the OK button.

The image is deleted.



When deleting multiple images at once, refer to “Deleting Multiple Images” (p.220).

4 Shooting Functions

This chapter describes the various basic and advanced shooting functions available with this camera.

How to Operate the Shooting Functions	78
Setting the Exposure	83
Focusing	108
Checking the Composition, Exposure and Focus Before Shooting (Preview)	118
Using the Shake Reduction Function to Prevent Camera Shake	122
Taking Pictures Continuously	132
Shooting while Adjusting the Settings (Auto Bracketing)	138
Taking Pictures Using Digital Filters	143
Shooting with Live View	146
Recording Movies	152

How to Operate the Shooting Functions

You can change capture-related settings using the direct keys, control panel, [📷 Rec. Mode] menu or [C Custom Setting] menu.



For details on how to use the direct keys and menus, refer to “How to Change Function Settings” (p.40).

Direct Keys Setting Items

Press the four-way controller (▲▼◀▶) in Capture mode to set the following items.

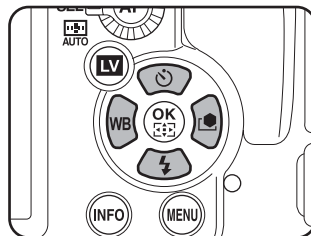

Key	Item	Function	Page
▲	Drive Mode	Sets Continuous Shooting, Self-timer, Remote Control, Exposure Bracketing or Mirror Lock-up Shooting.	p.132 p.125 p.127 p.138 p.130
▼	Flash Mode	Sets the method of flash discharge.	p.69
◀	White Balance	Adjusts the color balance to match the type of the light source illuminating the subject.	p.183
▶	Custom Image	Sets the image finishing tone such as color and contrast before shooting an image.	p.197

Rec. Mode Menu Setting Items

The following settings can be performed in the [📷 Rec. Mode 1-5] menus.

Press the **MENU** button in Capture mode to display the [📷 Rec. Mode 1] menu.

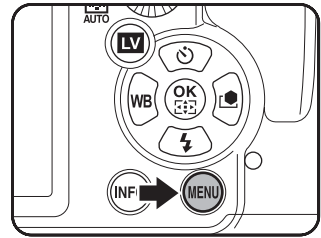

Menu	Item	Function	Page	
📷 1	USER Mode *1	Switches between the saved USER modes.	p.206	
	Exposure Mode *1	Sets the exposure mode when the mode dial is set to USER .	p.205	
	File Format *2	Sets the file format.	p.180	
	JPEG Recorded Pixels *2	Sets the recording size of images saved in JPEG format.	p.178	
	JPEG Quality *2	Sets the quality of images saved in JPEG format.	p.179	
	AF Settings	AUTO AF Point Setting *2	Sets the number of AF points when the focusing area is set to HEF AUTO (AUTO).	p.113
		Expanded Area AF	Sets whether to continue to focus on your subject based on information from the focus points surrounding the selected focus point if your subject briefly moves out from the selected focus point when the AF point switching dial is set to SEL (Select).	p.115
	Lens Correction *2	Corrects distortions and chromatic aberrations occurring due to lens properties.	p.193	
📷 2	Cross Processing *2	Changes the hues and contrast by performing digital cross processing.	p.200	
	Extended Bracketing *2	Sets the Extended Bracketing shooting settings.	p.141	
	Digital Filter *2	Applies a digital filter effect when taking pictures.	p.143	
	HDR Capture *2	Enables capturing images with high dynamic range.	p.191	
	Multi-exposure	Creates a composite picture by taking multiple frames.	p.136	
	Interval Shooting	Takes pictures at a set interval from a set time.	p.133	
	Composition Adjust.	Adjusts the composition of your image using the Shake Reduction mechanism.	p.195	

Menu	Item	Function	Page
☑3	D-Range Setting *2	Expands the dynamic range and prevents bright and dark areas from occurring.	p.190
	ISO AUTO Setting *2	Sets the range of automatic correction in ISO AUTO.	p.84
	High-ISO NR	Sets whether to use Noise Reduction when shooting with a high ISO sensitivity.	p.85
	Slow Shutter Speed NR	Sets whether to use Noise Reduction in slow speed shooting.	p.87
	Program Line	Selects Program Line.	p.89
	Color Space	Sets the color space to use.	p.189
	RAW File Format	Sets the file format of images saved in RAW format.	p.181
☑4	Movie	Sets the movie settings.	p.152
	Live View	Sets the Live View settings.	p.147
	Electronic Level	Sets whether to display the electronic level which detects whether the camera is level.	p.262
	Horizon Correction	Corrects the tilt (right and left) of the image.	p.123
	Shake Reduction *2	Reduces vertical and horizontal camera shake.	p.122
	Input Focal Length	Sets the focal length when using a lens whose focal length information cannot be obtained.	p.124
	GPS	Sets the functions for when the optional GPS unit is attached to the camera.	p.305
☑5	Instant Review	Sets the Instant Review display settings.	p.259
	Digital Preview	Sets the Digital Preview settings.	p.119
	E-Dial Programming	Sets the functions assigned to the e-dials in each exposure mode.	p.247
	Button Customization	Sets the functions for when the RAW/Fx button, AF button, or Preview dial is operated, or the shutter release button is pressed halfway.	p.249
	Memory	Determines which settings to save when the power is turned off.	p.274
	Save USER Mode	Saves the current camera settings as USER .	p.202

*1 Appears only when the mode dial is set to **USER**.

*2 Can also be set using the control panel.

Custom Setting Menu Setting Items

Set the [C Custom Setting 1-4] menus to fully use the functions of a SLR camera.

Menu	Item	Function	Page
C1	1. EV Steps	Sets the adjustment steps for exposure.	p.106
	2. Sensitivity Steps	Sets the adjustment steps for ISO sensitivity.	p.84
	3. Expanded Sensitivity	Expands the lower and upper sensitivity limits.	p.84
	4. Meter Operating Time	Sets the exposure metering time.	p.104
	5. AE-L with AF Locked	Sets whether to lock the exposure value when the focus is locked.	p.115
	6. Link AE to AF Point	Sets whether to link the exposure and AF point in the focusing area during multi-segment metering.	p.104
	7. Auto EV Compensation	Sets whether to automatically compensate when the proper exposure cannot be determined.	-
C2	8. Auto Bracketing Order	Sets the order for Auto Bracketing shooting.	p.138
	9. One-Push Bracketing	Sets whether to shoot all frames with one press of the shutter release button when using Exposure Bracketing.	p.140
	10. WB Adjustable Range	Sets whether to automatically fine-tune the white balance when specifying the light source on the white balance setting.	p.185
	11. WB When Using Flash	Sets the white balance setting when using flash.	p.185
	12. AWB in Tungsten Light	Sets whether to adjust the tungsten light color tone when the white balance is set to AWB (Auto White Balance).	-
	13. Color Temperature Steps	Sets the adjustment steps for color temperature.	p.188
	14. Superimpose AF Area	Sets whether to display the active AF point(s) in red in the viewfinder.	p.113

Menu	Item	Function	Page
C3	15. AF.S Setting	Sets the action priority for when the focus mode is set to AF.S and the shutter release button is fully pressed.	p.109
	16. AF.C Setting	Sets the action priority for Continuous Shooting when the focus mode is set to AF.C .	p.109
	17. AF Assist Light	Sets whether to use the AF assist light when autofocusing in dark locations.	p.109
	18. AF with Remote Control	Sets whether to use autofocus when shooting with remote control.	p.129
	19. Remote Control in Bulb	Sets the remote control operation when using the remote control in B (Bulb Exposure) mode.	p.102
	20. Release While Charging	Sets whether to release shutter while the built-in flash is charging.	p.71
	21. Flash in Wireless Mode	Sets the built-in flash discharge method in wireless mode.	p.172
C4	22. LCD Panel Illumination	Sets the illumination for the LCD panel.	p.38
	23. Saving Rotation Info	Sets whether to save rotation information when shooting.	p.219
	24. Save Menu Location	Sets whether to save the last menu tab displayed on the monitor and to display it again the next time the MENU button is pressed.	p.258
	25. Catch-in Focus	When set to [On], if the focus mode is set to AF.S and a manual focus lens is attached, Catch-in Focus shooting is enabled and the shutter is released automatically when the subject comes into focus.	p.117
	26. AF Fine Adjustment	Adjusts the AF focusing position.	p.111
	27. Using Aperture Ring	Sets whether to enable shutter release when the lens aperture ring is set to the position other than A .	p.299
	Reset Custom Functions	Resets all the settings in the [C Custom Setting 1-4] menus to the defaults.	p.296

Setting the Sensitivity

You can set the sensitivity to suit the brightness of the surroundings. The sensitivity can be set to [ISO AUTO] or within a sensitivity range equivalent to ISO 100 to 12800. The default setting is [ISO AUTO].

- 1 Turn the rear e-dial (☀️) while pressing the ISO button in Capture mode.**

The sensitivity displayed on the status screen and LCD panel and in the viewfinder changes.

Press the  button to set the sensitivity to [ISO AUTO].

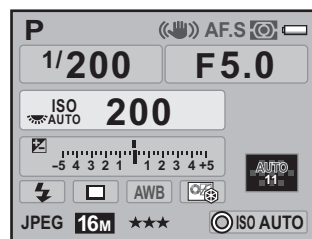
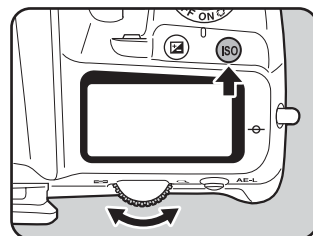

- 2 Take your finger off the ISO button and rear e-dial (☀️).**

The sensitivity is set.



- The sensitivity can also be changed by pressing the **ISO** button once, taking your finger off the button and turning the rear e-dial (☀️). In this case, the sensitivity is fixed when the **ISO** button is pressed again or the exposure metering timer (p.104) elapses.
- When the exposure mode is set to **■** (Green), **TAv** (Shutter & Aperture Priority Automatic Exposure) or **🎬** (Movie), the sensitivity is fixed to [ISO AUTO] and the setting cannot be changed.
- When the exposure mode is set to **Sv** (Sensitivity Priority Automatic Exposure), **M** (Manual Exposure), **B** (Bulb Exposure) or **X** (Flash X-sync Speed), the sensitivity cannot be set to [ISO AUTO].
- The sensitivity range can be expanded to a range of ISO 80 to 51200 when [3. Expanded Sensitivity] in the [**C** Custom Setting 1] menu is set to [On]. However, the minimum sensitivity is ISO 160 when [Highlight Correction] is set to [On] in [D-Range Setting] (p.190) of the [**📷** Rec. Mode 3] menu.
- Captured images may show more noise if a higher sensitivity is set. You can reduce image noise by setting [High-ISO NR] in the [**📷** Rec. Mode 3] menu. (p.85)
- You can select whether to set the sensitivity in increments of 1 EV or in accordance with the EV step setting for exposure (p.106). This can be set in [2. Sensitivity Steps] of the [**C** Custom Setting 1] menu.

Setting the Range of Automatic Sensitivity Correction

Set the range in which the sensitivity is automatically adjusted when the sensitivity is set to [ISO AUTO]. The sensitivity is automatically corrected in the range of [ISO 100-3200] by default.

- 1** Select [ISO AUTO Setting] in the [**📷** Rec. Mode 3] menu and press the four-way controller (▶).

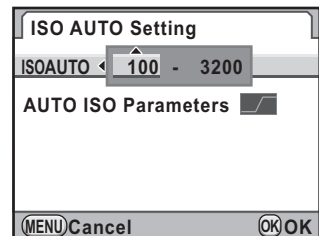

The [ISO AUTO Setting] screen appears.

- 2** Press the four-way controller (▶) and use the four-way controller (▲▼) to set the minimum sensitivity.



- 3** Press the four-way controller (▶) and use the four-way controller (▲▼) to set the maximum sensitivity.

- 4 Press the **OK** button.
- 5 Use the four-way controller (**▲ ▼**) to select [AUTO ISO Parameters] and press the four-way controller (**▶**).
- 6 Use the four-way controller (**▲ ▼**) to select the parameter and press the **OK** button.

 Slow	Increases the sensitivity as little as possible
 Standard	(default setting)
 Fast	Actively increases the sensitivity

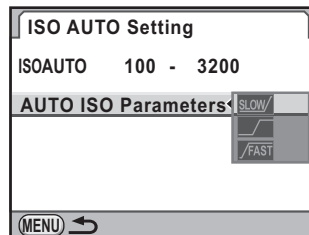

- 7 Press the **MENU** button twice.

The screen that was displayed before selecting the menu appears again.

Reducing Image Noise (Noise Reduction)

When shooting with a digital camera, image noise (image roughness or unevenness) becomes noticeable in the following situations.

- when shooting with a long exposure
- when shooting with a high sensitivity setting
- when the temperature of the CMOS sensor is high

You can reduce image noise by using Noise Reduction. However, images shot with Noise Reduction will take longer to save.

High-ISO NR

Reduces noise at high sensitivity (ISO) settings.

- 1 Select [High-ISO NR] in the [**📷** Rec. Mode 3] menu and press the four-way controller (**▶**).

The [High-ISO NR] screen appears.

- 2 Press the four-way controller (▶) and use the four-way controller (▲▼) to select [Auto], [Off], [Low], [Medium], [High] or [Custom].**

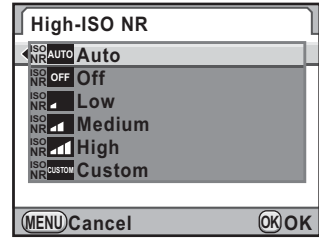

Auto	Applies Noise Reduction at optimally calculated levels throughout ISO range. (default setting)
Off	Does not apply Noise Reduction at any ISO setting.
Low/Medium/High	Applies Noise Reduction at constant chosen level throughout ISO range.
Custom	Applies Noise Reduction at user-defined levels for each ISO setting.

- 3 Press the OK button.**

If you select [Auto], [Off], [Low], [Medium], or [High], proceed to Step 7.

- 4 Use the four-way controller (▲▼) to select [Setting] and press the four-way controller (▶).**

The screen to set the noise reduction level according to the sensitivity appears.

- 5 Use the four-way controller (▲▼) to select a sensitivity value and use the four-way controller (◀▶) to set the level of noise reduction which is applied to the selected sensitivity.**

Turn the rear e-dial (☼) to display the [High-ISO NR 2] screen.

Press the Ⓞ button to reset the setting of the selected sensitivity value.

The sensitivity values displayed vary according to the [1. EV Steps] and [2. Sensitivity Steps] settings made in the [C Custom Setting 1] menu.

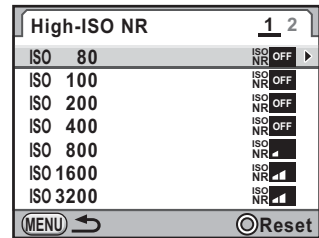

- 6 Press the MENU button.**

The screen that was displayed in Step 2 appears again.

- 7 Press the MENU button twice.**

The camera is ready to take a picture.

Slow Shutter Speed NR

Reduces noise during long exposures.

1 Select **[Slow Shutter Speed NR]** in the **[Rec. Mode 3]** menu and press the four-way controller (▶).

2 Use the four-way controller (▲▼) to select **[Auto]**, **[On]** or **[Off]**, and press the **OK** button.

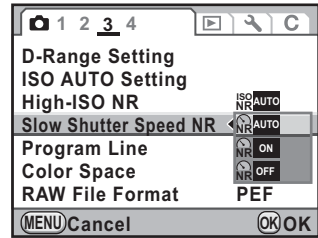

Auto	Determines conditions such as shutter speed, sensitivity, and internal temperature, and automatically applies Noise Reduction as necessary. (default setting)
On	Applies Noise Reduction when the exposure time is longer than 1 second.
Off	Does not apply Noise Reduction.

3 Press the **MENU** button.

The camera is ready to take a picture.



- Processing may take a while when shooting with Slow Shutter Speed NR set to [On]. Pictures cannot be taken while an image is being processed.
- When the Noise Reduction function is activated, **[nr]** blinks on the LCD panel and in the viewfinder where the aperture value is normally displayed, and a countdown of processing time is displayed where the shutter speed is normally displayed.

Changing the Exposure Mode

This camera features the following exposure modes. Use the mode dial to change the exposure mode. (p.45)

The settings available for each exposure mode are as follows.

(✓: Available x: Not available)







Exposure Mode	Change Shutter Speed	Change Aperture Value	Change Sensitivity	EV Compensation	Page
■ Green	x	x	x	x	p.90
P Program Automatic Exposure	✓	✓	✓	✓	p.91
Sv Sensitivity Priority Automatic Exposure	x	x	Other than ISO AUTO	✓	p.92
Tv Shutter Priority Automatic Exposure	✓	x	✓	✓	p.94
Av Aperture Priority Automatic Exposure	x	✓	✓	✓	p.95
TAv Shutter & Aperture Priority Automatic Exposure	✓	✓	ISO AUTO only	✓	p.97
M Manual Exposure	✓	✓	Other than ISO AUTO	–	p.98
B Bulb Exposure	x	✓	Other than ISO AUTO	x	p.101
X Flash X-sync Speed	x	✓	Other than ISO AUTO	–	p.102



For each exposure mode, you can set the functions for when the front/rear e-dial or the button is operated. Set in [E-Dial Programming] of the [Rec. Mode 5] menu. (p.247) You can confirm the functions of the front and rear e-dials and the button by viewing the guides which appear on the monitor when the camera is switched on or the mode dial is turned. (p.25)

Program Line

In [Program Line] of the [📷 Rec. Mode 3] menu, you can choose from the following Program Lines. When [P LINE] is selected for the  button setting in **P/Sv** mode or **TAv/M** mode (p.247), exposure is regulated according to the set Program Line.

Setting	Characteristics
 Auto	Camera determines the appropriate settings.
 Normal	Basic Program Automatic Exposure (default setting)
 Hi-speed Priority	Program Automatic Exposure that prioritizes high shutter speeds.
 DOF Priority (deep)	Program Automatic Exposure that closes the aperture as much as possible for a deep depth of field.
 DOF Priority (shallow)	Program Automatic Exposure that opens the aperture as much as possible for a shallow depth of field.
 MTF Priority	Program Automatic Exposure that prioritizes the best aperture settings for the attached lens when a DA, DA L, D FA, FA J or FA lens is used.

Using a Lens with an Aperture Ring

When using a lens with an aperture ring, set the aperture to the **A** (AUTO) position while holding down the auto-lock button on the lens.

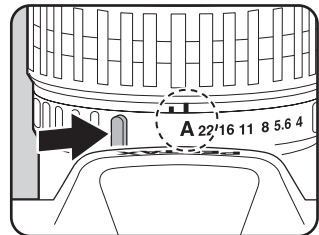

Using the **■** Mode

Lets you capture images with fully automatic settings.

In **■** mode, pictures are taken with the following settings.

- Program Line **AUTO** (AUTO)
- File Format JPEG
- Sensitivity ISO AUTO
- Metering Method **☉** (Multi-segment Metering)
- AF Point **AUTO** (Auto)
- AUTO AF Point Setting 11 AF Points
- White Balance **AWB** (Auto)
- Custom Image Bright
- High-ISO NR Auto
- Slow Shutter Speed NR On
- Shake Reduction **☞☞** (On)
- Color Space sRGB



If the **MENU** button is pressed in **■** mode, the menu for Green Mode appears. You cannot select items that cannot be changed.

1

Set the mode dial to **■**.

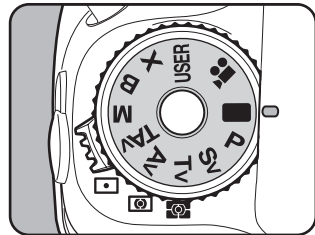



- In **■** mode, the following functions and operations are not available.
 - Changing the shutter speed
 - Changing the aperture value
 - EV Compensation
 - Flash (Flash On, Slow-speed Sync, Trailing Curtain Sync, Wireless Mode, Exposure Compensation)
 - Continuous Shooting
 - Focus Mode **A.F.C** (**A.F.S** is selected)
 - D-Range Setting
 - Lens Correction
 - Exposure Bracketing
 - Mirror Lock-up Shooting
 - Multi-exposure
 - Interval Shooting
 - Extended Bracketing
 - Digital Filter
 - HDR Capture
 - Cross Processing
 - Horizon Correction
 - Saving as **USER** mode
 - **AE-L** and **RAW/Fx** button operations
 - Button Customization (default settings are used)
 - Custom menu settings (default settings are used)
- The control panel cannot be displayed in **■** mode.

Using the P Mode

Automatically sets the shutter speed and aperture value to obtain a proper exposure according to the selected Program Line when taking pictures. You can also use the front and rear e-dials to change the shutter speed or aperture value while maintaining the proper exposure. (p.247)

1 Set the mode dial to **P**.

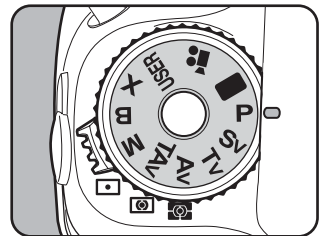

2 Check the shutter speed and aperture value.

Check the settings using the status screen, viewfinder or LCD panel.

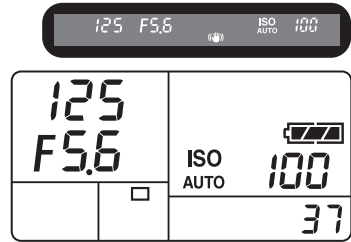
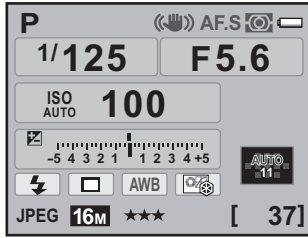

Set the Program Line to use in [Program Line] of the [Rec. Mode 3] menu. (p.89)

4

Using the Sv Mode

You can set the sensitivity to suit the brightness of the subject. The shutter speed and aperture value are automatically set according to the selected sensitivity to obtain a proper exposure.

1 Set the mode dial to Sv.

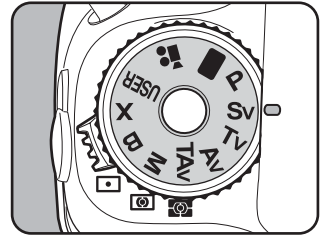

- 2** Turn the rear e-dial (☀️) to adjust the sensitivity.

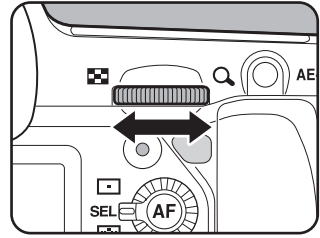

The set values are displayed in the status screen and viewfinder and on the LCD panel.

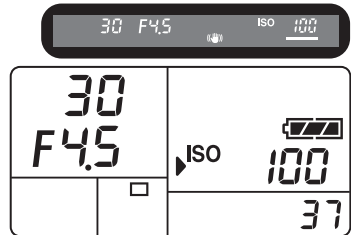
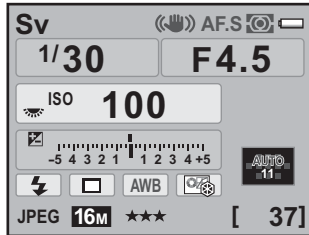

- You can set the sensitivity to a value equivalent to ISO 100 to 12800. [ISO AUTO] is not available.
- The sensitivity can be set in increments of 1/3 EV or 1/2 EV. Set the exposure steps in [1. EV Steps] of the [C Custom Setting 1] menu. (p.106)

Using the Tv Mode

Lets you set the desired shutter speed for expressing moving subjects. When taking pictures of a fast moving subject, you can increase the shutter speed to make the subject look still or decrease the shutter speed to have the subject show movement.

The aperture value is automatically set to give a proper exposure depending on the shutter speed.

1 Set the mode dial to Tv.

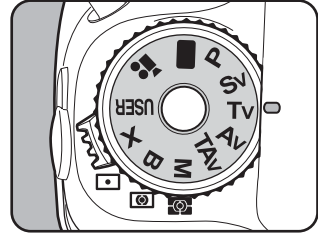

2 Turn the front e-dial (☀️) to adjust the shutter speed.

The shutter speed can be set within the range of 1/8000 to 30 seconds.

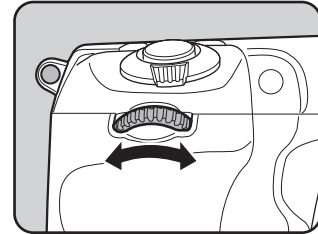

The set values are displayed in the status screen and viewfinder and on the LCD panel.

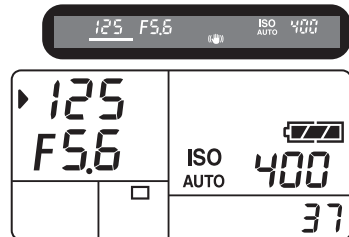
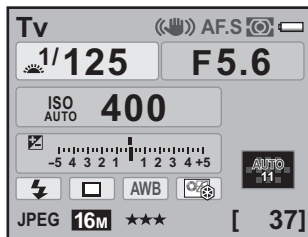



- The shutter speed can be set in increments of 1/3 EV or 1/2 EV. Set the exposure steps in [1. EV Steps] of the [C Custom Setting 1] menu. (p.106)
- The proper exposure may not be obtained with the selected shutter speed when the sensitivity is not set to [ISO AUTO] (p.83).

Exposure Warning

If the subject is too bright or too dark, the aperture value will blink on the status screen and LCD panel and in the viewfinder. If the subject is too bright, choose a faster shutter speed. If it is too dark, choose a slower shutter speed. When the aperture value indication stops blinking, you can take a picture with proper exposure.

Use a commercially available ND (Neutral Density) Filter if the subject is too bright. Use a flash if it is too dark.



Using the Av Mode

Set the aperture value for controlling the depth of field. The depth of field is deeper and the front and back of the focused object is clear when the aperture is set to a large value, small lens opening. The depth of field is shallower and the front and back of the focused object is blurred when the aperture is set to a small value, large lens opening. The shutter speed is automatically set to the proper exposure depending on the aperture value.

1 Set the mode dial to Av.

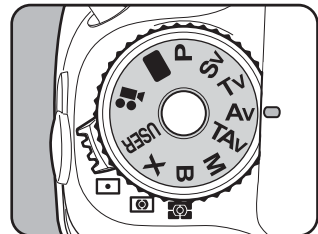

2 Turn the rear e-dial (☀️) to adjust the aperture value.

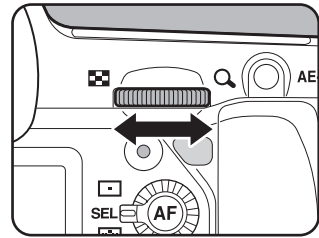

The set values are displayed in the status screen and viewfinder and on the LCD panel.

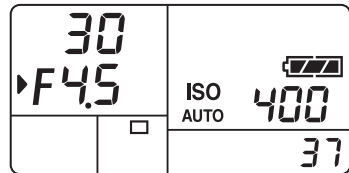
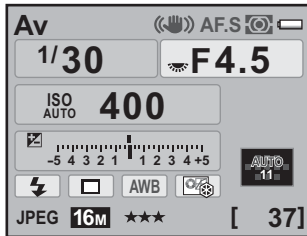

4

Shooting Functions



- The aperture value can be set in increments of 1/3 EV or 1/2 EV. Set the exposure steps in [1. EV Steps] of the [C Custom Setting 1] menu. (p.106)
- The proper exposure may not be obtained with the selected aperture value when the sensitivity is not set to [ISO AUTO] (p.83).

Exposure Warning

If the subject is too bright or too dark, the shutter speed will blink on the status screen and LCD panel and in the viewfinder. When the subject is too bright, set the aperture to a smaller lens opening (larger number), and when too dark, set the aperture to a larger lens opening (smaller number). Once blinking stops, you can take a picture with proper exposure.

Use a commercially available ND (Neutral Density) Filter if the subject is too bright. Use a flash if it is too dark.



Using the TAv Mode

You can set both the desired shutter speed and aperture to take the picture.

Automatically sets the sensitivity so that the manually set shutter speed and aperture value will give the proper exposure according to the brightness of the subject.

1 Set the mode dial to TAv.

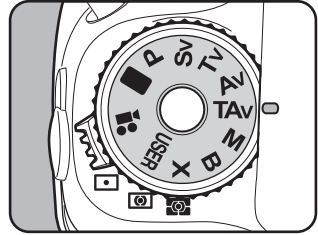

2 Turn the front e-dial (☀️) to adjust the shutter speed.

The shutter speed can be set within the range of 1/8000 to 30 seconds.

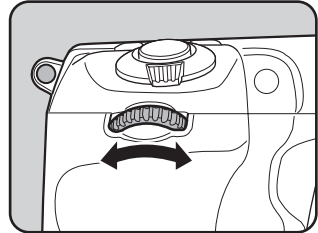

3 Turn the rear e-dial (🔍) to adjust the aperture value.

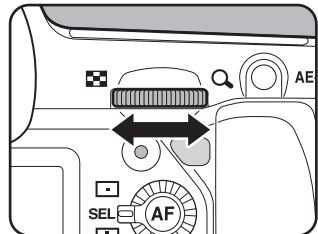

The set values are displayed in the status screen and viewfinder and on the LCD panel.

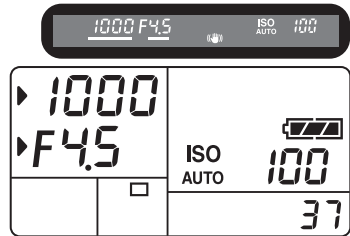
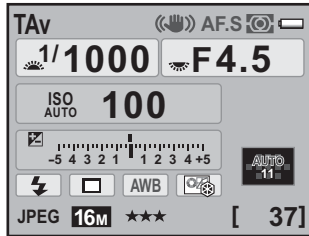

- The shutter speed and aperture value can be set in increments of 1/3 EV or 1/2 EV. Set the exposure steps in [1. EV Steps] of the [C Custom Setting 1] menu. (p.106)
- In **TAv** mode, the sensitivity is fixed to [ISO AUTO].

4

Exposure Warning

If the subject is too bright or too dark, the sensitivity will blink on the status screen and LCD panel and in the viewfinder. In such situations, change the shutter speed and aperture. When the indication stops blinking, you can take a picture with proper exposure.



Use a commercially available ND (Neutral Density) Filter if the subject is too bright. Use a flash if it is too dark.

Using the M Mode

You can set the shutter speed and aperture value. This mode is suitable to take pictures of your choice by combining them. This mode is convenient for taking pictures using the same combination of the shutter speed and aperture settings or taking intentionally underexposed (darker) or overexposed (brighter) photographs.

1 Set the mode dial to M.

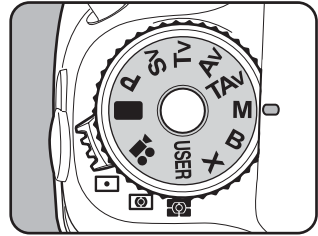

2 Turn the front e-dial (☀️) to adjust the shutter speed.

The shutter speed can be set within the range of 1/8000 to 30 seconds.

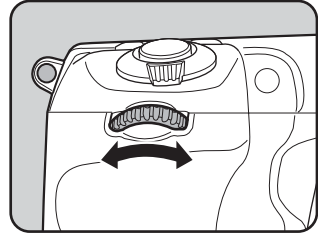

3 Turn the rear e-dial (☀️) to adjust the aperture value.

The set values are displayed in the status screen and viewfinder and on the LCD panel.

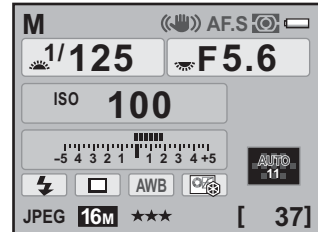
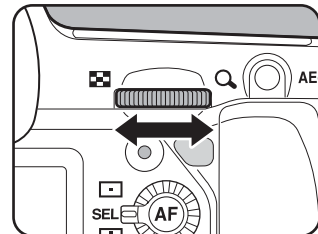

While adjusting the shutter speed or aperture value, the difference from the proper exposure (EV value) is displayed in a bar graph. The proper exposure is set when **█** is in the middle of the EV bar. If it is towards -, it is underexposed. If it is towards +, it is overexposed. If the value exceeds the range of the EV bar, or if the subject is too bright or too dark, the "+" or "-" blinks.

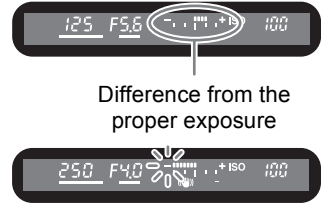

- The sensitivity cannot be set to [ISO AUTO] in **M** mode. If the exposure mode is changed to **M** mode when the sensitivity is set to [ISO AUTO], the sensitivity is also changed to the lowest value set in "Setting the Range of Automatic Sensitivity Correction" (p.84).
- The shutter speed and aperture value can be set in increments of 1/3 EV or 1/2 EV. Set the exposure steps in [1. EV Steps] of the [**C** Custom Setting 1] menu. (p.106)
- Since the bar graphs in the viewfinder and on the LCD panel display the amount of camera tilt to the left or right, the difference from the proper exposure is displayed as a number when [Electronic Level] is set to (On).



Combining with AE-L

When the exposure is locked (p.107) by pressing the **AE-L** button in **M** mode, if the shutter speed or aperture value is changed, the combination of shutter speed and aperture value changes while the exposure value is retained.

Example: If the shutter speed is 1/125 sec. and aperture is F5.6 and these settings are locked with the **AE-L** button, the aperture automatically changes to F11 if the shutter speed is changed to 1/30 sec. with the front e-dial (☀).

Using the B Mode

This setting is useful when shooting night scenes and fireworks which require long exposures.

1 Set the mode dial to B.

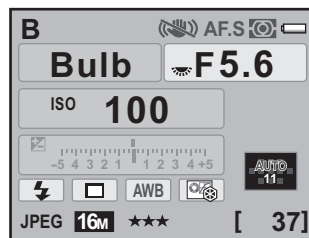
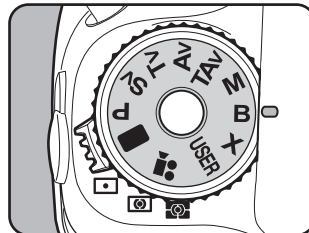

2 Press the shutter release button.

The shutter remains open as long as the shutter release button is kept pressed.

3 Take your finger off the shutter release button.

Exposure ends.



The following functions are not available in **B** mode.

- EV Compensation
- Exposure Bracketing
- Continuous Shooting
- Interval Shooting
- HDR Capture
- AE Lock
- Shake Reduction



- The aperture value can be set in increments of 1/3 EV or 1/2 EV. Set the exposure steps in [1. EV Steps] of the [C Custom Setting 1] menu. (p.106)
- Use a sturdy tripod and the cable switch CS-205 (optional) or Remote Control (optional) to prevent camera shake when using **B** mode. Connect the cable switch to the cable release terminal (p.20).
- When using the remote control, set whether to start exposure with a press and stop it with another press of the shutter release button on the remote control, or to keep the shutter open as long as the release button on the remote control is kept pressed. Set in [19. Remote Control in Bulb] of the [C Custom Setting 3] menu.
- The sensitivity cannot be set to [ISO AUTO] in **B** mode. If the exposure mode is changed to **B** mode when the sensitivity is set to [ISO AUTO], the sensitivity is also changed to the lowest value set in “Setting the Range of Automatic Sensitivity Correction” (p.84).
- There is no limit on exposure time for Bulb shooting. However, we recommend the use of the AC adapter kit (optional) when shooting with a long exposure setting as the battery is being drained while the shutter remains open. (p.52)

4

Shooting Functions

Using the X Mode

The shutter speed is locked at 1/180 second. Use this when using an external flash that does not automatically set the sync speed.

1 Set the mode dial to X.

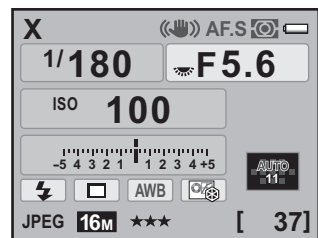
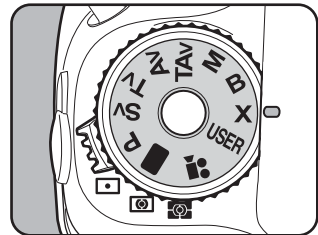



- Turn the rear e-dial () to adjust the aperture value.
- Press the button to retain the shutter speed at 1/180 second and automatically adjust the aperture value.
- The sensitivity cannot be set to [ISO AUTO] in **X** mode. If the exposure mode is changed to **X** mode when the sensitivity is set to [ISO AUTO], the sensitivity is also changed to the lowest value set in “Setting the Range of Automatic Sensitivity Correction” (p.84).

Selecting the Metering Method

Choose the part of the viewfinder to use for measuring brightness and determining exposure. The following three methods are available. The factory default setting is (Multi-segment metering).

1 Turn the metering mode switch.

The set metering method is displayed in the status screen and viewfinder.

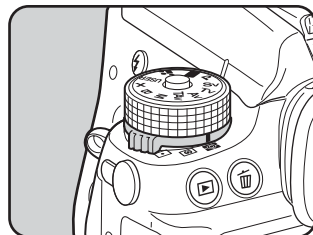

● Multi-segmented Metering

The scene in the viewfinder is metered in 77 different zones. Even in backlit locations, this mode automatically determines what level of brightness is in which portion and automatically adjusts exposure.

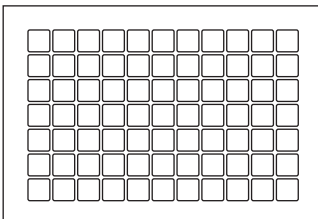

● Center-weighted Metering

Metering is weighted at the center of the viewfinder. Use this metering when you want to compensate for the exposure by experience, instead of leaving it to the camera. The illustration shows that sensitivity increases as the pattern height increases (center). This mode does not automatically compensate for backlit scenes.

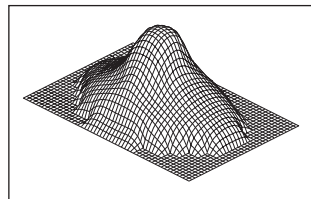

● Spot Metering

The brightness is measured only within a limited area at the center of the viewfinder. You can use this in combination with the AE Lock (p.107) when the subject is extremely small and the correct exposure is difficult to obtain.

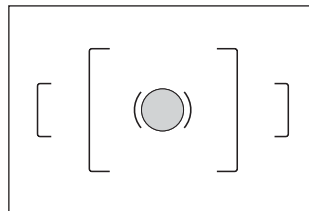

Center-weighted metering mode is automatically set even if you select multi-segment metering mode when using a lens other than a DA, DA L, D FA, FA J, FA, F or A lens, or when the lens aperture ring is set to a position other than **A** (Auto). (Can only be used if [27. Using Aperture Ring] (p.299) in the [C Custom Setting 4] menu is set to [Permitted].)

4

Linking AE to AF Point during Multi-segment Metering

In [6. Link AE to AF Point] of the [C Custom Setting 1] menu, you can link the exposure and AF point in the focusing area during multi-segment metering.

1	Off	Exposure is set separately from the AF point. (default setting)
2	On	Exposure is set in accordance with the AF point.

Setting the Meter Operating Time

You can set the exposure metering time to [10 sec.] (default setting), [3 sec.] or [30 sec.] in [4. Meter Operating Time] of the [C Custom Setting 1] menu.

Adjusting Exposure

This allows you to deliberately overexpose (brighten) or underexpose (darken) your picture.

The exposure steps can be selected from 1/3 EV or 1/2 EV in [1. EV Steps] of the [C Custom Setting 1] menu. You can adjust the EV compensation value from -5 to +5 (EV).

- 1 Turn the rear e-dial (☀️) while pressing the  button.

The exposure is adjusted.

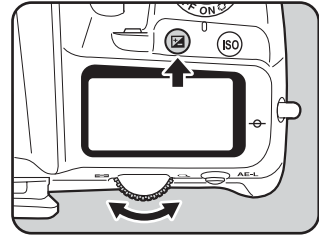

 is displayed in the status screen and viewfinder and on the LCD panel during adjustment.

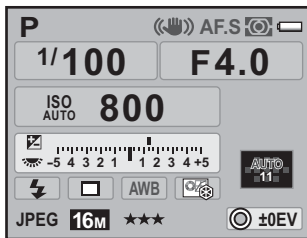

Compensation value

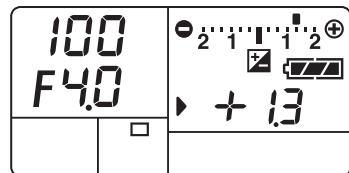



Press the  button to reset the EV compensation value to 0.0.

Press the  button to check the compensation value after adjustment.



EV compensation is not available when the exposure mode is set to  (Green) or **B** (Bulb Exposure) mode.



- The compensation value can also be changed by pressing the  button once, taking your finger off the button and turning the rear e-dial (☀️). In this case, EV compensation is set when the  button is pressed again or the exposure metering timer (p.104) elapses.
- The compensation value is not canceled by turning the camera off or by switching to another exposure mode.

EV Compensation for M and X modes

For example, if the EV compensation value is set to +1.5 for **M** (Manual Exposure) and **X** (Flash X-sync speed) modes, an underexposure of 1.5 EV is displayed on the EV bar. If you set the exposure value so that the **|** is displayed at the center of the EV bar, the image will be captured with the compensated value.



4

Changing the Exposure Steps

Set the exposure compensation steps to increments of 1/3 EV or 1/2 EV in [1. EV Steps] of the [**C** Custom Setting 1] menu.

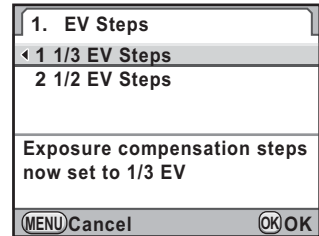

Step Interval	Exposure Setting Value
1/3 EV	±0.3, ±0.7, ±1.0, ±1.3, ±1.7, ±2.0, ±2.3, ±2.7, ±3.0, ±3.3, ±3.7, ±4.0, ±4.3, ±4.7, ±5.0
1/2 EV	±0.5, ±1.0, ±1.5, ±2.0, ±2.5, ±3.0, ±3.5, ±4.0, ±4.5, ±5.0

Changing the Exposure Automatically when Shooting

Auto Bracketing is a function for continuously shooting images with the exposure automatically adjusted for underexposure and overexposure. Each time the shutter release button is pressed, 2, 3 or 5 shots are taken. Refer to “Shooting while the Exposure is Automatically Changed (Exposure Bracketing)” (p.138).

Locking the Exposure Before Shooting (AE Lock)

AE Lock is a function that locks the exposure prior to taking a picture. Use this when the subject is too small to obtain a proper exposure or is backlit.

1 Set the exposure and press the **AE-L** button.

The camera locks the exposure (brightness) at that instant.

* is displayed in the status screen and viewfinder while the AE Lock is engaged.

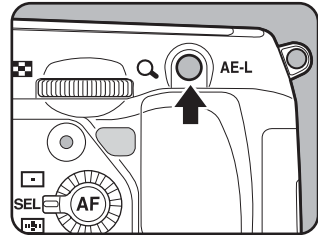

- The exposure remains locked as long as the **AE-L** button is kept pressed or the shutter release button is kept pressed halfway. The exposure remains locked for twice the amount of the exposure metering timer (p.104) even after taking your finger off the **AE-L** button.
- You will hear a beep when the **AE-L** button is pressed. The beep can be turned off. (p.252)
- AE Lock is not available in **■** (Green), **B** (Bulb Exposure) or **X** (Flash X-sync Speed) mode.
- When any of the following operations are performed, AE Lock is canceled.
 - the **AE-L** button is pressed again
 - the **▶** button, **MENU** button or **INFO** button is pressed
 - the mode dial is turned
 - the lens is changed
 - a lens with an **A** (Auto) position is set to a position other than the **A** position
- The combination of shutter speed and aperture value changes depending on the zooming position even while the AE Lock is engaged when using a zoom lens whose maximum aperture value varies depending on the focal length. However, the exposure value does not change and a picture is taken at a brightness level set when the AE Lock is activated.
- The exposure can also be locked when the focus is locked. Set in [5. AE-L with AF Locked] of the [**C** Custom Setting 1] menu. (p.115)

You can focus with the following methods.

AF Autofocus	The camera automatically focuses on the subject when the shutter release button is pressed halfway.
MF Manual focus	Manually adjust the focus. (p.116)

Using the Autofocus

You can also choose the autofocus mode from **A.F.S** (Single mode) where the shutter release button is pressed halfway to focus on the subject and the focus is locked at that position, and **A.F.C** (Continuous mode) where the subject is kept in focus by continuous adjustment while the shutter release button is pressed halfway. The factory default setting is **A.F.S**.

1 Set the focus mode switch to **A.F.S** or **C**.

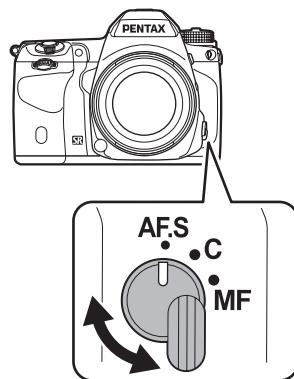

<p>A.F.S Single mode</p>	<p>When the shutter release button is pressed halfway and the subject comes into focus, the focus is locked (focus lock) at that position. If the subject is outside the focusing area, focus the camera on the subject in the focusing area, lock the focus at that position (focus lock), and then recompose your picture.</p> <ul style="list-style-type: none"> • The AF assist light turns on as necessary. (p.109) • Set the action priority for when the shutter release button is pressed fully in [15. AF.S Setting] of the [C Custom Setting 3] menu. <table border="1" data-bbox="327 347 955 549"> <tr> <td data-bbox="327 347 367 486">1</td> <td data-bbox="367 347 473 486">Focus-priority</td> <td data-bbox="473 347 955 486">The shutter cannot be released until the subject is in focus. (default setting) If the subject is too close to the camera, move back and take the picture. If the subject is difficult to focus, adjust the focus manually. (p.116)</td> </tr> <tr> <td data-bbox="327 486 367 549">2</td> <td data-bbox="367 486 473 549">Release-priority</td> <td data-bbox="473 486 955 549">The shutter can be released even if the subject is not in focus.</td> </tr> </table>	1	Focus-priority	The shutter cannot be released until the subject is in focus. (default setting) If the subject is too close to the camera, move back and take the picture. If the subject is difficult to focus, adjust the focus manually. (p.116)	2	Release-priority	The shutter can be released even if the subject is not in focus.
1	Focus-priority	The shutter cannot be released until the subject is in focus. (default setting) If the subject is too close to the camera, move back and take the picture. If the subject is difficult to focus, adjust the focus manually. (p.116)					
2	Release-priority	The shutter can be released even if the subject is not in focus.					
<p>A.F.C (C) Continuous mode</p>	<p>The subject is kept in focus by continuous adjustment while the shutter release button is pressed halfway. The focus indicator ● appears and you will hear a beep when the subject comes into focus. Even if the subject is not in focus, the shutter can be released when the shutter release button is pressed fully.</p> <ul style="list-style-type: none"> • When the shutter release button is pressed halfway to focus, the camera automatically tracks the subject if it is determined to be a moving object. The lens will automatically operate and continuously focus on the subject. • Set the action priority for Continuous Shooting in [16. AF.C Setting] of the [C Custom Setting 3] menu. <table border="1" data-bbox="327 884 955 1035"> <tr> <td data-bbox="327 884 367 970">1</td> <td data-bbox="367 884 473 970">Focus-priority</td> <td data-bbox="473 884 955 970">Takes pictures giving priority to keeping the subject in focus during Continuous Shooting. (default setting)</td> </tr> <tr> <td data-bbox="327 970 367 1035">2</td> <td data-bbox="367 970 473 1035">FPS-priority</td> <td data-bbox="473 970 955 1035">Takes pictures giving priority to the shooting speed during Continuous Shooting.</td> </tr> </table>	1	Focus-priority	Takes pictures giving priority to keeping the subject in focus during Continuous Shooting. (default setting)	2	FPS-priority	Takes pictures giving priority to the shooting speed during Continuous Shooting.
1	Focus-priority	Takes pictures giving priority to keeping the subject in focus during Continuous Shooting. (default setting)					
2	FPS-priority	Takes pictures giving priority to the shooting speed during Continuous Shooting.					

AF Assist Light

You can set whether or not to use the AF assist light during **A.F.S** mode in [17. AF Assist Light] of the [C Custom Setting 3] menu.

1	On	To make focusing easier when the subject is in a dark location, the AF assist light turns on when the shutter release button is pressed halfway. (default setting)
2	Off	The AF assist light will not be used.

Using the AF Button to Focus on the Subject

You can set the camera so that focusing is performed when the **AF** button is pressed.

- 1 Select **[Button Customization]** in the **[Rec. Mode 5]** menu and press the four-way controller (▶).

The **[Button Customization]** screen appears.

- 2 Use the four-way controller (▲ ▼) to select **[AF Button]** and press the four-way controller (▶).

The **[AF Button]** screen appears.

- 3 Press the four-way controller (▶) and use the four-way controller (▲ ▼) to select **[Enable AF]**.

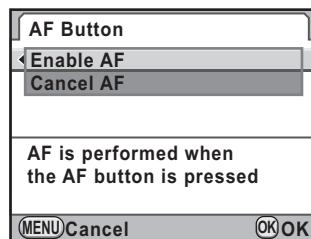

Enable AF	Autofocus is performed by using the AF button or the shutter release button. (default setting)
Cancel AF	MF appears in the viewfinder while the AF button is pressed. Autofocus is not performed when the shutter release button is pressed. (Take your finger off the AF button to return to normal autofocus mode.)

- 4 Press the **OK** button.
- 5 Press the **MENU** button three times.

The camera is ready to take a picture.

6 Press the **AF** button while looking through the viewfinder.

Autofocus is performed.

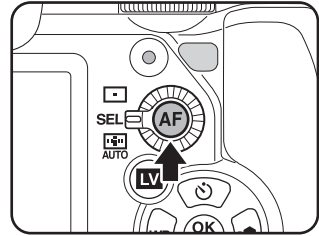

A.F.S Single mode	When the AF button is pressed and the subject comes into focus, the Focus Lock function is activated while the button is pressed.
A.F.C Continuous mode	The subject is kept in focus while the AF button is pressed.

7 Press the shutter release button.

When [Enable AF] is assigned to [Shutter Button Half Press] in [Button Customization], press the shutter release button while holding down the **AF** button.

The picture is taken.

AF Fine Adjustment

You can adjust the AF focusing position.



- Be sure to use [AF Fine Adjustment] only when necessary. Care should be taken as adjusting the autofocus may make it difficult to capture images with the appropriate focus. Set to [Off] if you do not need to adjust the AF focusing position.
- Any camera shake during test shooting may make it difficult to obtain the accurate focusing position. Therefore, always use a tripod when taking test shots.

1 Select [26. AF Fine Adjustment] in the [C Custom Setting 4] menu and press the four-way controller (►).

2 Use the four-way controller (▲ ▼) to select [On] and press the four-way controller (►).

The [26. AF Fine Adjustment] screen appears.

3 Use the four-way controller (▲▼) to select [Apply All] or [Apply One].

Apply All	Applies the same adjustment value to all lenses.
Apply One	This item will appear on the display only when the lens ID is obtained. Saves and applies a different adjustment value for each lens type. (Up to 20 lens types)
Reset	Resets the saved adjustment value.

4 Press the four-way controller (▶) and adjust the value.

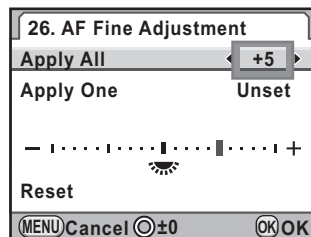

Available operations

Four-way controller (▶)/ Rear e-dial (🔍) to the right (Q)	Adjusts the focus to a closer position.
Four-way controller (◀)/ Rear e-dial (🔍) to the left (Q)	Adjusts the focus to a farther position.
⊙ button	Resets the adjustment value to ±0.

5 Press the OK button.

The adjustment value is saved.

6 Press the MENU button three times.

The camera returns to Capture mode.

7 Take a test picture.

You can easily check the focusing point by enlarging the image during Digital Preview (p.120) or Live View (p.146).





Even when an adjustment value has been saved using [Apply One], if you press the **OK** button with [Apply All] selected in Step 3, the [Apply All] value is used instead of the [Apply One] value.

Selecting the Focusing Area (AF Point)

Choose the part of the viewfinder to set focus to. The factory default setting is  (Auto).

Selected AF point(s) light red in the viewfinder (Superimpose AF Area).

 Center	Sets the focusing area to the center of the viewfinder.
SEL Select	Sets the focusing area to the user selected point from eleven points in the AF frame.
 Auto	The camera selects the optimum AF point even if the subject is not centered. You can select from 11 AF points (default setting) or 5 points in [AUTO AF Point Setting] of [AF Settings] in the [ Rec. Mode 1] menu.

1 Turn the AF point switching dial.

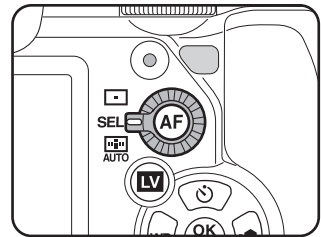

- AF point(s) are not illuminated red in the viewfinder when [Off] is selected for [14. Superimpose AF Area] in the [**C** Custom Setting 2] menu.
- The focusing area is fixed to  regardless of this setting when using lenses other than DA, DA L, D FA, FA J, FA or F lens. (p.297)

Setting the Focus Position in the Viewfinder

1 Set the AF point switching dial to SEL.

 appears in the viewfinder and the AF point can be changed.

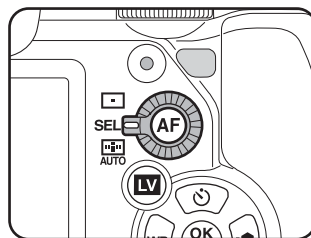

2 Look through the viewfinder and check the position of the subject.

3 Use the four-way controller (▲▼◀▶) to change the AF point.

The selected AF point appears in the status screen.

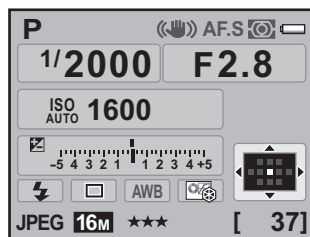

Available operations

OK button	Returns the AF point to the center of the AF frame.
Press and hold OK button	Disables changing the AF point and enables direct key operation of the four-way controller (▲▼◀▶). To enable changing the AF point, press the OK button while direct key operation is enabled. You will hear a beep when switching between enabled and disabled.

The AF point(s) light red in the viewfinder (Superimpose AF Area) and you can check where you set the AF point.



- The position of the changed AF point is stored even if the camera is turned off or the focusing area is switched to or .
- appears in the viewfinder when the AF point can be changed.
- When [Expanded Area AF] is set to (On) in [AF Settings] of the [Rec. Mode 1] menu, if your subject briefly moves out from the focus point that was selected when the focus mode was set to **AFC**, the camera will continue to focus on your subject based on information from the focus points (back-up focus points) surrounding the selected focus point. The back-up focus points are displayed in pink on the status screen.

Locking Exposure when the Focus is Locked

Set [5. AE-L with AF Locked] in the [C Custom Setting 1] menu to lock the exposure value while the focus is locked.

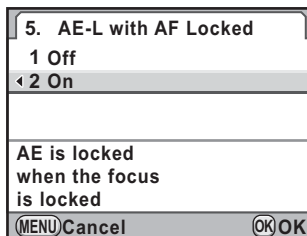



1	Off	Exposure is not locked when the focus is locked. (default setting)
2	On	Exposure is locked when the focus is locked.

Adjusting the Focus Manually (Manual Focus)

When you adjust the focus manually, you can use either the focus indicator or the matte field in the viewfinder.

Using the Focus Indicator

The focus indicator  appears in the viewfinder when the subject is in focus even during manual focus.

You can manually adjust the focus using the focus indicator .

1 Set the focus mode switch to **MF**.

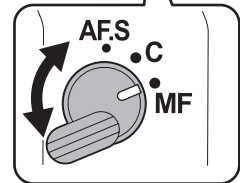
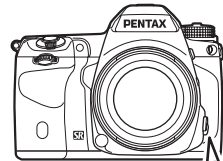

2 Look through the viewfinder, press the shutter release button halfway and turn the focusing ring.

The focus indicator  appears and you will hear a beep when the subject comes into focus.

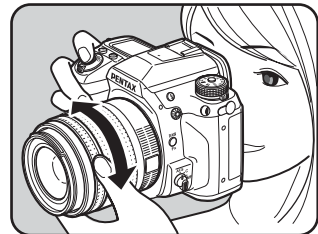

- Adjust the focus manually using the matte field in the viewfinder when the subject is difficult to focus and the focus indicator does not appear.
- The beep that sounds when the image is focused can be turned off. (p.252)

Using the Viewfinder Matte Field

You can manually adjust the focus using the matte field in viewfinder.

- 1 Set the focus mode switch to **MF**.
- 2 Look through the viewfinder and turn the focusing ring until the subject is clearly visible in the viewfinder.

Shooting in Catch-in Focus Mode

When [25. Catch-in Focus] in the [C Custom Setting 4] menu is set to [On], if the focus mode is set to **A.F.S** and one of the following types of lenses is attached, Catch-in Focus shooting is enabled and the shutter is released automatically when the subject comes into focus.

- Manual focus lens
- DA or FA lens that enables switching **AF** and **MF** modes on the lens itself (the setting on the lens must be set to **MF** before shooting)



● How to Take Pictures

- 1 Attach a proper lens to the camera.
- 2 Set the focus mode switch to **A.F.S**.
- 3 Set the focus on a position the subject will pass.
- 4 Press the shutter release button fully.
The shutter is released automatically when the subject comes into focus at the set position.

Checking the Composition, Exposure and Focus Before Shooting (Preview)

You can use the preview function to check depth of field, composition, exposure and focus before taking a picture.

There are two preview methods.

Preview Method	Description
 Optical Preview	For checking the depth of field with the viewfinder.
 Digital Preview	For checking the composition, exposure and focus on the monitor.



You can use the Live View function that displays a real-time image on the monitor and enables you to change the shooting settings and magnify the image. (p.146)

4

Selecting the Preview Method

Choose whether to use Optical Preview or Digital Preview when the main switch is turned to the preview position (🔄).

The default setting is Optical Preview.

- 1 Select [Button Customization] in the [📷 Rec. Mode 5] menu and press the four-way controller (▶).**

The [Button Customization] screen appears.

- 2 Use the four-way controller (▲▼) to select [Preview Dial] and press the four-way controller (▶).**

The [Preview Dial] screen appears.

- 3 Press the four-way controller (▶) and use the four-way controller (▲▼) to select [Optical Preview] or [Digital Preview].**

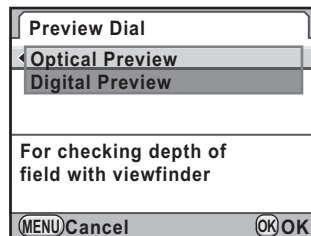

4 Press the **OK** button.

5 Press the **MENU** button three times.

The camera is ready to take a picture.



- While shooting with Mirror Lock-up Shooting, Interval Shooting, Multi-exposure or Live View, Optical Preview is used regardless of the setting.
- Digital Preview can also be assigned to the **RAW/Fx** button. If Optical Preview is assigned to the Preview dial and Digital Preview is assigned to the **RAW/Fx** button, you can use both preview functions easily. Refer to p.249 for assigning a function to the **RAW/Fx** button.

Setting the Display for Digital Preview

For Digital Preview, you can set whether to display the histogram and Bright/Dark Area warning, and whether to enable enlarging images.

1 Select **[Digital Preview]** in the **[📷 Rec. Mode 5]** menu and press the four-way controller (**▶**).

The **[Digital Preview]** screen appears.

2 Use the four-way controller (**▲ ▼**) to select **[Histogram]**, **[Bright/Dark Area]** or **[Enlarge Instant Review]**.

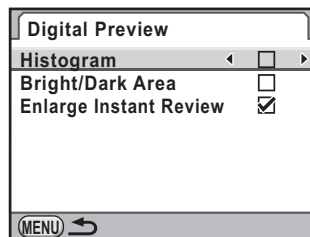

3 Use the four-way controller (**◀ ▶**) to select or .

4 Press the **MENU** button twice.

Displaying the Optical Preview

- 1 Focus on the subject.
- 2 Turn the main switch to  while looking through the viewfinder.

You can check the depth of field in the viewfinder while the main switch is set to the position .

During this time, no shooting information is displayed in the viewfinder, and the shutter cannot be released.

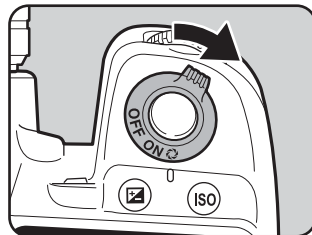

- 3 Take your finger off the main switch.

Optical Preview is ended and the camera is ready to take a picture.

Displaying the Digital Preview

- 1 Focus on the subject and compose the picture in the viewfinder.
- 2 Turn the main switch to .

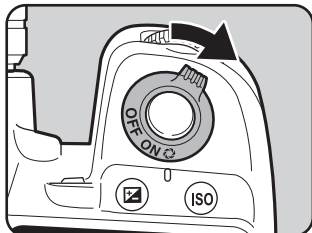

When Digital Preview is assigned to the **RAW/Fx** button, press the **RAW/Fx** button.

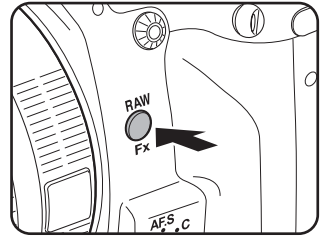

The icon (🔄) appears on the monitor during preview and you can check the composition, exposure and focus.



Available operations

Rear e-dial (🔍)	Enlarges the preview image. (p.211)
AE-L button	Saves the preview image.

3

Press the shutter release button halfway.

Digital Preview is ended and the autofocus system operates.



The maximum display time for Digital Preview is 60 seconds.

4

Shooting Functions

Using the Shake Reduction Function to Prevent Camera Shake

Using the Shake Reduction Function

The Shake Reduction function reduces camera shake that occurs when the shutter release button is pressed.

Ideal when taking pictures in the following situations.

- When taking pictures in dimly lit locations, such as indoors, at night, on cloudy days and in the shade
- When taking telephoto pictures

The Shake Reduction function can be used to reduce horizontal and vertical camera shake or keep the image level.



- The Shake Reduction function does not compensate for blurring caused by subject movement. To take pictures of a moving subject, increase the shutter speed.
- The Shake Reduction function may not fully reduce camera shake when taking close-up shots. In this case, it is recommended to turn off the Shake Reduction function and use the camera with a tripod.
- The Shake Reduction function will not fully work when shooting with a very slow shutter speed, for example when panning or shooting night scenes. In this case, it is recommended to turn off the Shake Reduction function and use the camera with a tripod.
- The Shake Reduction function is available with any PENTAX lens compatible with this camera. However, be sure to set the focal length before using a lens for which focal length information cannot be automatically obtained. Refer to "When the Focal Length Cannot Be Automatically Detected" (p.124) for details.

Reducing Vertical and Horizontal Camera Shake

1 Select [Shake Reduction] in the [Rec. Mode 4] menu and press the four-way controller (▶).

2 Use the four-way controller (▲▼) to select (☞) or (☜) and press the OK button.

	Uses Shake Reduction. (default setting)
	Does not use Shake Reduction.

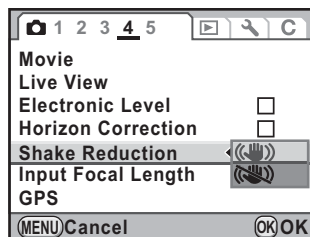

3 Press the MENU button.

The screen that was displayed before selecting the menu appears again.

4 Press the shutter release button halfway.

 appears in the viewfinder and the Shake Reduction function is activated.



- Set [Shake Reduction] to  (Off) when using the camera with a tripod or when this function is not needed.
- The Shake Reduction function automatically turns off in the following situations. Note that the Shake Reduction function cannot be selected when the following functions are set.
 - **B** (Bulb Exposure) mode
 - Self-timer shooting
 - Remote Control shooting
 - Mirror Lock-up shooting
 - when [Auto Align] is set to (Off) in the [HDR Capture] setting
 - when using the flash in wireless mode

Correcting the Tilt of the Images

1 Select [Horizon Correction] in the [CAMERA MODE 4] menu.

2 Use the four-way controller (◀▶) to select or .

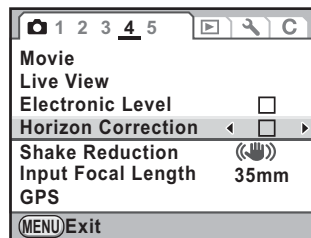





3 Press the MENU button.

The screen that was displayed before selecting the menu appears again.

4

Press the shutter release button halfway.

The following indicators appear on the status screen.

	Shake Reduction On + Horizon Correction Off
	Shake Reduction Off + Horizon Correction Off
	Shake Reduction On + Horizon Correction On
	Shake Reduction Off + Horizon Correction On



- The Shake Reduction function will not fully work (for about 2 seconds) right after turning on the camera or restoring from Auto Power Off. Wait for the Shake Reduction function to become stable, and then press the shutter button gently. If  appears in the viewfinder when you press the shutter release button halfway, the camera is ready to take a picture.
- The Shake Reduction function is available with any PENTAX lens compatible with this camera. However, when the aperture ring is set to a position other than the **A** (Auto) position for a lens with a **A** position or a lens without an **A** position is used, the camera will not operate unless [27. Using Aperture Ring] is set to [Permitted] in the [C Custom Setting 4] menu. Set this beforehand. In such cases, however, some functions will be restricted. Refer to “Using the Aperture Ring” (p.299) for details.

4

When the Focal Length Cannot Be Automatically Detected

The Shake Reduction function operates by obtaining the lens information such as focal length.

If the camera uses a DA, DA L, D FA, FA J, FA or F lens, the lens information is automatically obtained when the Shake Reduction function is activated. Set the focal length if you use a lens whose information such as focal length cannot be automatically obtained (p.297).



- The [Input Focal Length] setting screen does not appear when using a lens whose information such as focal length can be automatically obtained.
- When using a lens without the **A** position on the aperture or with the aperture set to a position other than **A**, set [27. Using Aperture Ring] in the [C Custom Setting 4] menu to [Permitted]. (p.299)
- The effect of Shake Reduction is influenced by the shooting distance as well as focal length information. The Shake Reduction function may not work as effectively as expected when shooting at close ranges.

1 Make sure that [Shake Reduction] is set to (On) and turn the camera off.

Refer to “Reducing Vertical and Horizontal Camera Shake” (p.122) for details.

2 Attach a lens and turn the camera on.

The [Input Focal Length] screen appears.

3 Turn the rear e-dial () to set the focal length.

Select from the following focal length values. (The default setting is 35 mm.)

8	10	12	15	18	20	24	28	30	35
40	45	50	55	65	70	75	85	100	120
135	150	180	200	250	300	350	400	450	500
550	600	700	800						

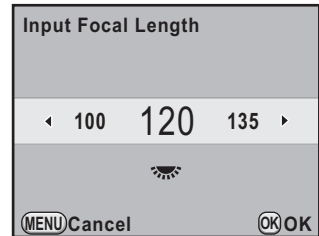

- If the focal length for your lens is not listed above, select the value closest to the actual focal length (example: [18] for 17 mm and [100] for 105 mm).
- When using a zoom lens, select the actual focal length at the zoom setting being used.



4 Press the OK button.



The camera is ready to take a picture.



To change the focal length setting, use [Input Focal Length] in the [Rec. Mode 4] menu.

Shooting with Self-timer

 Self-timer (12 sec.)	Shutter is released after about 12 seconds. Use this mode to include the photographer in the picture.
 Self-timer (2 sec.)	A mirror pops up immediately after the shutter release button is pressed. The shutter is released after about 2 seconds. Use this mode to avoid camera shake when the shutter release button is pressed.

- 1 **Mount the camera onto a tripod.**
- 2 **Press the four-way controller (▲) in Capture mode.**
The [Drive Mode] screen appears.
- 3 **Use the four-way controller (◀▶) to select .**
- 4 **Press the four-way controller (▼) and use the four-way controller (◀▶) to select  or .**

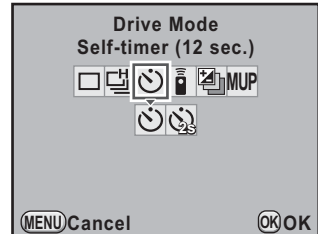

- 5 **Press the OK button.**
The camera is ready to take a picture.
- 6 **Press the shutter release button halfway.**
The autofocus system operates.
- 7 **Press the shutter release button fully.**

For , the front and back self-timer lamps start blinking slowly and blink rapidly 2 seconds before the shutter is released. The beep is heard and the rate increases. The shutter will be released about 12 seconds after the shutter release button is pressed fully.

For , the shutter will be released about 2 seconds after the shutter release button is pressed fully.

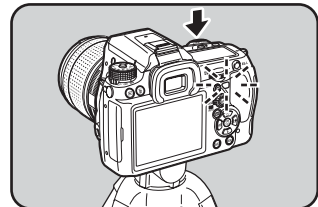
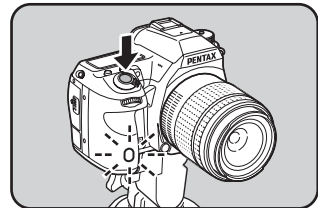



- Select a mode other than or in the [Drive Mode] screen to cancel the Self-timer shooting. The setting is canceled when the camera is turned off if [Drive Mode] is set to (Off) in [Memory] of the [Rec. Mode 5] menu. (p.274)
- The Shake Reduction function is automatically turned off when or is set.
- You can set the camera so that the beep does not sound. (p.252)
- The exposure may be affected if light enters the viewfinder. Use the AE Lock function (p.107) or attach the provided ME viewfinder cap. The light entering the viewfinder has no effect on the exposure when the exposure mode is set to **M** (Manual Exposure).

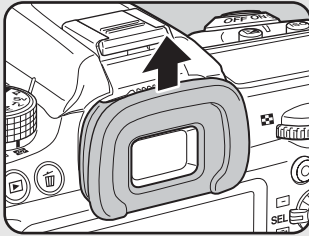

Removing the Eyecup FR

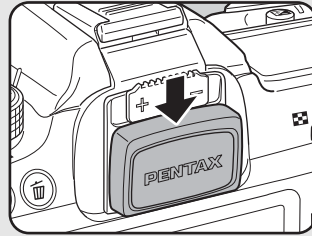

Attaching the ME Viewfinder cap

Shooting with Remote Control (Optional)

The shutter can be released from a distance by using the optional remote control unit.

	Remote Control	The shutter is released immediately after the shutter release button on the remote control unit is pressed.
	Remote Control (3s delay)	The shutter is released about 3 seconds after the shutter release button on the remote control unit is pressed.
	Remote Continuous Shooting	Continuous shooting starts when the shutter release button on the remote control unit is pressed. Press the shutter release button on the remote control unit again to exit continuous shooting.

1 Mount the camera onto a tripod.

2 Press the four-way controller () in Capture mode.

The [Drive Mode] screen appears.

3 Use the four-way controller (◀▶) to select **ii**.

4 Press the four-way controller (▼) and use the four-way controller (◀▶) to select **ii**, **ii_{ss}**, or **ii_Ⓛ**.

ii_Ⓛ appears on the LCD panel. The self-timer lamp will blink and the camera is in a stand-by status.

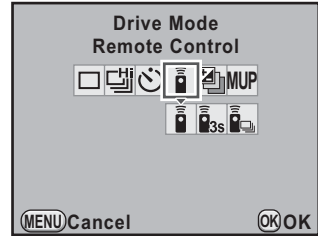

5 Press the **OK** button.

The camera is ready to take a picture.

6 Press the shutter release button halfway.

The autofocus system operates.

7 Point the remote control unit towards the remote control receiver on the front or back of the camera and press the shutter release button on the remote control.

The operating distance of the remote control unit is approximately 4 m from the front of the camera and approximately 2 m from the back of the camera.

After a picture is taken, the self-timer lamp lights for 2 seconds and then returns to blinking.

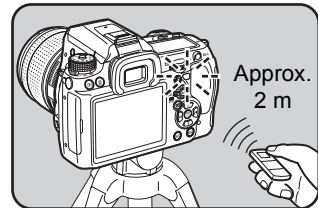
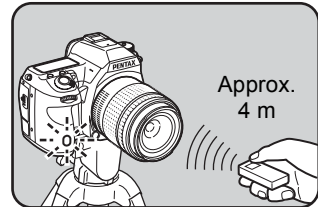



- By default, you cannot adjust the focus with the remote control unit. Focus on the subject first with the camera before operating with the remote control. When [18. AF with Remote Control] is set to [On] in the [C Custom Setting 3] menu, you can use the remote control unit to adjust the focus. (AF cannot be used with the remote control unit during Live View.)
- Select a mode other than $\bar{\text{A}}$, $\bar{\text{S}}$ or $\bar{\text{M}}$ in the [Drive Mode] screen to cancel the Remote Control shooting. The setting is canceled when the camera is turned off if [Drive Mode] is set to \square (Off) in [Memory] of the [Rec. Mode 5] menu. (p.274)
- The Shake Reduction function is automatically turned off when $\bar{\text{A}}$, $\bar{\text{S}}$ or $\bar{\text{M}}$ is set.
- The exposure may be affected if light enters the viewfinder. Use the AE Lock function (p.107) or attach the provided ME viewfinder cap. The light entering the viewfinder has no effect on the exposure when the exposure mode is set to **M** (Manual Exposure).

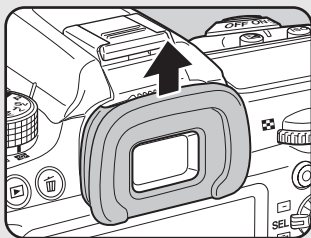

Removing the Eyecup FR

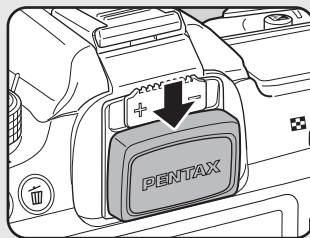
Attaching the
ME Viewfinder cap

- The remote control may not operate in backlit conditions.
- When using the Remote Control Waterproof O-RC1, AF can be operated with the $\frac{1}{\infty}$ button. The **Fn** button cannot be used.
- The Remote Control F can send a remote control signal about 30,000 times. Contact a PENTAX Service Center to replace the battery (this will involve a fee).

Shooting with the Mirror Lock-up Function

Use the Mirror Lock-up function if camera shake is evident even when the remote control or cable switch is used with a tripod.

For Mirror Lock-up Shooting, press the shutter release button to raise the mirror up and press it again to release the shutter.

M.UP Mirror Up	Mirror Lock-up shooting with the shutter release button.
M.UP Mirror Up + Remote Control	Mirror Lock-up shooting with the remote control. The shutter will be released immediately after the shutter release button on the remote control unit is pressed (p.127).

4

Shooting Functions

- 1 Mount the camera onto a tripod.**
- 2 Press the four-way controller (▲) in Capture mode.**
The [Drive Mode] screen appears.
- 3 Use the four-way controller (◀▶) to select M.UP.**
- 4 Press the four-way controller (▼) and use the four-way controller (◀▶) to select M.UP or **M.UP**.**
M.UP appears in the status screen and on the LCD panel.

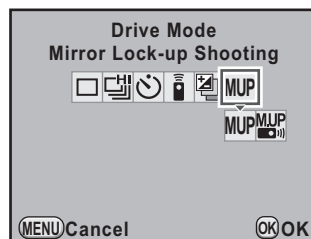

- 5 Press the OK button.**
The camera is ready to take a picture.
- 6 Press the shutter release button halfway.**
The autofocus system operates.
- 7 Press the shutter release button fully.**
The mirror pops up and you will hear a beep. The AE Lock function is enabled with the exposure value set immediately before the mirror pops up.

8

Press the shutter release button fully again.



The shutter is released and the picture is taken.





- Select a mode other than **MUP** or **MUP** in the [Drive Mode] screen to cancel Mirror Lock-up shooting. The setting is canceled when the camera is turned off if [Drive Mode] is set to (Off) in [Memory] of the [📷 Rec. Mode 5] menu. (p.274)
- The mirror automatically returns to its original position if 1 minute elapses after the mirror pops up when the shutter release button is pressed for the first time (except while using Multi-exposure).
- The Shake Reduction function is automatically turned off when **MUP** or **MUP** is set.
- The beep that sounds when the mirror pops up can be turned off. (p.252)

Continuous Shooting

Pictures can be taken continuously while the shutter release button is kept pressed.

	Continuous Shooting (Hi)	For JPEG image with 16M/★★★, up to approx. 30 frames are taken continuously at a maximum of approx. 7.0 fps.
	Continuous Shooting (Lo)	For JPEG image with 16M/★★★, pictures are taken continuously at a maximum of approx. 1.6 fps until the SD Memory Card is full.



When the file format is [RAW] (PEF), up to approx. 20 frames for  and up to approx. 40 frames for  can be taken continuously.

1 Press the four-way controller (▲) in Capture mode.

The [Drive Mode] screen appears.

2 Use the four-way controller (◀▶) to select .

3 Press the four-way controller (▼) and use the four-way controller (◀▶) to select or .

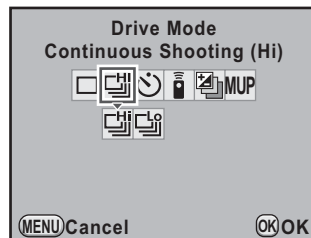

4 Press the OK button.

The camera is ready to take a picture.

5 Press the shutter release button halfway.

The autofocus system operates.

6 Press the shutter release button fully.

Pictures are taken continuously while the shutter release button is fully pressed. Take your finger off the shutter release button to stop.



- If the focus mode is set to **A.F.S** (Single mode), the focus position is locked in the first frame and pictures are taken continuously at the same interval.
- Focusing is continuously activated during Continuous Shooting when the focus mode is set to **A.F.C** (Continuous mode).
- You can also use the remote control for Continuous Shooting. (p.127)
- The shutter cannot be released until charging is complete when using the built-in flash. You can set the camera to enable shutter release before the built-in flash is ready in [20. Release While Charging] of the [**C** Custom Setting 3] menu. (p.71)
- Select a mode other than or in the [Drive Mode] screen to cancel the Continuous Shooting. The setting is canceled when the camera is turned off if [Drive Mode] is set to (Off) in [Memory] of the [Rec. Mode 5] menu. (p.274)
- The shooting speed may be slower when [Lens Correction] (p.193) is set to On.

Interval Shooting

During Interval Shooting, pictures are taken at a set interval from a set time.



- Interval Shooting is not available in the following situations.
 - when the exposure mode is set to (Green), **B** (Bulb Exposure), **USER**, or (Movie)
 - when Extended Bracketing, Digital Filter or HDR Capture is set
 - When Interval Shooting is set, Multi-exposure is not available.

1 Select [Interval Shooting] in the [Rec. Mode 2] menu and press the four-way controller (▶).

The [Interval Shooting] screen appears.

2 Use the four-way controller (▲▼) to select [Interval].

When taking two or more pictures, set the wait time until the next picture is taken.

Use the four-way controller (◀▶) to select the number of hours, minutes, and seconds, and use the four-way controller (▲▼) to set the time.

You can set up to 24 hours, 00 minutes, and 00 seconds.

Press the **OK** button to complete the setting.

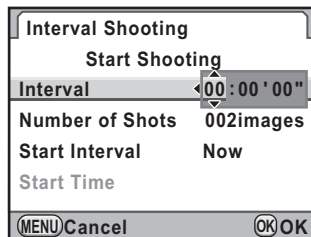

3 Use the four-way controller (▲▼) to select [Number of Shots].

Set the number of shots to be taken.

Press the four-way controller (▶) and use the four-way controller (▲▼) to select the number of shots to be taken.

You can select between 1 and 999 shots.

Press the **OK** button to complete the setting.

4 Use the four-way controller (▲▼) to select [Start Interval].

Set the time when the first picture is taken.

Press the four-way controller (▶) and use the four-way controller (▲▼) to select [Now] or [Set Time].

Now	Shooting starts immediately. You can take two or more pictures.
Set Time	Shooting starts at the set time. Press the four-way controller (▼) to select [Start Time], use the four-way controller (◀▶) to select the time, and use the four-way controller (▲▼) to set the start time.

5 Use the four-way controller (▲▼) to select [Start Shooting] and press the OK button.

The camera is ready to take a series of interval pictures.

6 Press the shutter release button halfway.

The focus during Interval Shooting is locked at this position.

7 Press the shutter release button fully.

When [Start Interval] is set to [Now], the first picture is taken. When set to [Set Time], shooting starts at the set time.

For shooting multiple pictures, pictures are taken at the interval set in Step 2.

To cancel shooting, press the **MENU** button.

After the set number of pictures are taken, [Interval shooting complete] is displayed, and the camera returns to normal standby mode.



- If the mode dial or the main switch is turned while shooting, the pictures that have been already taken are saved and Interval Shooting is ended.
- [Single Frame Shooting] is selected regardless of the current drive mode setting.
- If the subject is not in focus with the focus mode set to **A.F.S** (Single mode) or if the [Interval] setting is too short and the previous image processing cannot be completed before taking the next picture, no picture may be taken.
- Although each shot taken is displayed with Instant Review, they cannot be magnified, deleted, or saved in RAW format.
- Interval Shooting is canceled when the SD Memory Card has no more available space.
- If the Auto Power Off function turns the camera off during Interval Shooting, the camera automatically turns on again when the shooting time approaches.
- It is recommended to use the AC adapter kit (optional) when using the Interval Shooting over a long period of time. (p.52)

Multi-exposure

You can create a composite picture by taking multiple frames.



- Multi-exposure is not available in the following situations.
 - when the exposure mode is set to (Green) or (Movie)
 - when Extended Bracketing, Digital Filter, HDR Capture or Cross Processing is set
- When Multi-exposure is set, the following functions are not available.
 - Exposure Bracketing or Interval Shooting (The function selected last is used)
 - Lens Correction

4

Shooting Functions

1 Select [Multi-exposure] in the [Rec. Mode 2] menu and press the four-way controller (▶).

The [Multi-exposure] screen appears.

2 Use the four-way controller (▲▼) to select [Number of Shots].

3 Press the four-way controller (▶) and use the four-way controller (▲▼) to select the number of shots.

Select from 2 to 9 shots.

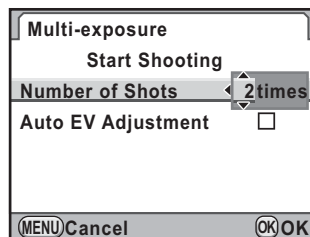

4 Press the OK button.

5 Use the four-way controller (▲▼) to select [Auto EV Adjustment] and use the four-way controller (◀▶) to select or .

When set to (On), the exposure is adjusted automatically according to the number of shots.

6 Use the four-way controller (▲▼) to select [Start Shooting] and press the OK button.

The camera is ready to take a picture.

7 Press the shutter release button halfway.





The autofocus system operates.

8 Press the shutter release button fully.

The composite picture is displayed in Instant Review each time the shutter release button is pressed. Press the  button during Instant Review to discard pictures taken up to that point and take pictures again from the first frame.

The pictures are saved when the set number of shots are taken, and then the [Multi-exposure] screen appears again.



- If any of the following operations are performed while shooting, the pictures that have been already taken are saved and Multi-exposure is ended.
 - when the  button, **MENU** button, four-way controller (   ), **INFO** button or **RAW/Fx** button is pressed
 - when the mode dial is turned
- When shooting in Multi-exposure mode using Live View, a semi-transparent composite image of the pictures taken is displayed. (It is not displayed when the camera is connected to an AV device.)

Shooting while Adjusting the Settings (Auto Bracketing)

Auto Bracketing is a function for shooting while automatically changing the camera settings. There are two Auto Bracketing modes: Exposure Bracketing and Extended Bracketing.

You can set Auto Bracketing Order in [8. Auto Bracketing Order] in the [C Custom Setting 2] menu.

1	0 - +	Standard → Underexposed → Overexposed (default setting)
2	- 0 +	Underexposed → Standard → Overexposed
3	+ 0 -	Overexposed → Standard → Underexposed
4	0 + -	Standard → Overexposed → Underexposed

4

Shooting Functions

Shooting while the Exposure is Automatically Changed (Exposure Bracketing)

You can take continuous pictures with different exposures when the shutter release button is pressed. You can select to take 2 images (Standard/+), 2 images (Standard/-), 3 images or 5 images. When taking 3 pictures, the first image is exposed with no compensation, the second image is underexposed (negative compensation) and the third image is overexposed (positive compensation).



Standard exposure



Underexposure

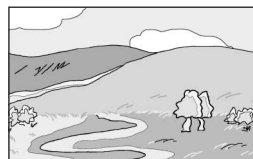

Overexposure



- Exposure Bracketing is not available in the following situations.
 - when the exposure mode is set to **B** (Bulb Exposure)
 - when HDR Capture is set
- Exposure Bracketing and Multi-exposure cannot be used at the same time. The function selected last is used.





1 Press the four-way controller (▲) in Capture mode.

The [Drive Mode] screen appears.

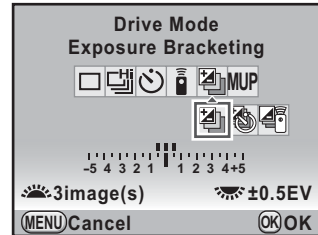
2 Use the four-way controller (◀▶) to select .

3 Press the four-way controller (▼) and use the four-way controller (◀▶) to select , , or .



 Exposure Bracketing	Takes pictures with the shutter release button.
 Exposure Bracketing + Self-timer	Takes pictures with the self-timer. Self-timer operates according to the self-timer (p.125) setting.
 Exposure Bracketing + Remote Control	Takes pictures with the remote control. Remote control operates according to the remote control (p.127) setting. When set to  (Remote Continuous Shooting), the shutter is released immediately.

4 Turn the front e-dial () to set the number of shots.



Select [2 images (+)], [2 images (-)], [3 image(s)] or [5 image(s)].

5 Turn the rear e-dial () to set the bracketing amount.

The following values can be set according to the step interval set in [1. EV Steps] (p.106) in the [C Custom Setting 1] menu.

Step Interval	Bracketing Amount
1/3 EV	±0.3, ±0.7, ±1.0, ±1.3, ±1.7, ±2.0
1/2 EV	±0.5, ±1.0, ±1.5, ±2.0

Available operations

 button + Rear e-dial ()	Adjusts the EV compensation when taking only underexposed or overexposed images with Exposure Bracketing. Images are taken with an EV compensation value set to 0 (intermediate value). (Up to ± 8 EV)
 button	Resets the compensation value to ± 0 .

6 Press the OK button.

The camera is ready to take a picture.

7 Press the shutter release button halfway.





When the subject is in focus, the focus indicator  appears in the viewfinder and the EV compensation value appears on the status screen and LCD panel and in the viewfinder.

8 Press the shutter release button fully.

Continue to press the shutter release button until the set number of shots are captured.

Consecutive images will be taken according to the order set in [8. Auto Bracketing Order] of the [C Custom Setting 2] menu.



- When the focus mode is set to **A.F.S** (Single mode), the focus position is locked in the first image and is used for subsequent images.
- When you take your finger off the shutter release button during Exposure Bracketing, the exposure setting will remain effective for twice the amount of the exposure metering timer (default setting is about 20 seconds) (p.104) and you can take a picture at the next compensation value. In this case, autofocus works for each image. After about twice the amount of the exposure metering timer elapses, the camera returns to settings for taking the first image.
- When [9. One-Push Bracketing] in the [C Custom Setting 2] menu is set to [On], even if the shutter release button is not continuously pressed fully, all images are automatically shot with one press of the shutter release button.
- You can combine Exposure Bracketing with the built-in flash or an external flash (P-TTL auto only) to change only the flash output continuously. However, when using an external flash, holding the shutter release button down to take consecutive images may cause the second and third images to be taken before the flash is fully charged. Take each image after confirming that charging is complete.
- Select a mode other than ,  or  in the [Drive Mode] screen to cancel the Exposure Bracketing. The setting is canceled when the camera is turned off if [Drive Mode] is set to  (Off) in [Memory] of the [Rec. Mode 5] menu. (p.274)
- If you use Exposure Bracketing frequently, you can assign it to the **RAW/Fx** button. (p.249)

Shooting while Adjusting Other Settings (Extended Bracketing)

You can save pictures with three different levels of White Balance, Saturation, Hue, High/Low Key Adjustment, Contrast and Sharpness. Unlike Exposure Bracketing, three pictures are saved each time the shutter is released.



- When Extended Bracketing is set, the file format is always set to [JPEG] and cannot be changed. You cannot use Extended Bracketing when the file format is set to [RAW] or [RAW+].
- When Extended Bracketing is set, the following functions are not available.
 - Interval Shooting or Multi-exposure
 - Cross Processing, Digital Filter or HDR Capture (The function selected last is used)

1 Select [Extended Bracketing] in the [📷 Rec. Mode 2] menu and press the four-way controller (▶).

The [Extended Bracketing] screen appears.

2 Press the four-way controller (▶).

3 Use the four-way controller (▲▼) to select an item and press the OK button.

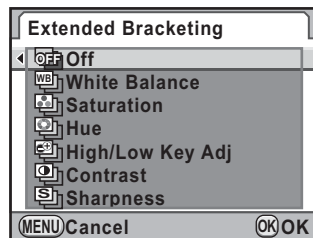

4 Use the four-way controller (▲▼) to select [Bracketing Amount] and press the four-way controller (▶).

5 Use the four-way controller (▲▼) to select the bracketing amount and press the OK button.

Select [± 1] (default setting), [± 2], [± 3] or [± 4].

For [White Balance], select from [BA ± 1] (default setting), [BA ± 2], [BA ± 3], [GM ± 1], [GM ± 2] or [GM ± 3].

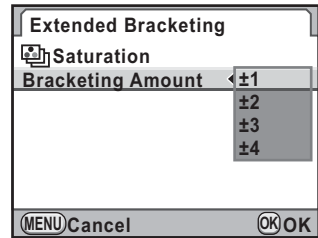

6 Press the MENU button twice.

The camera returns to Capture mode.

7 Press the shutter release button halfway.

The autofocus system operates.

8 Press the shutter release button fully.

Three images are saved.





- Exposure Bracketing and Extended Bracketing can be used at the same time. When used at the same time, each time the shutter is released for Exposure Bracketing, three images with Extended Bracketing applied are saved.
- Parameters that cannot be set due to the image finishing tone setting of Custom Image also cannot be set for Extended Bracketing. (Example: When set to [Monochrome], Saturation and Hue cannot be selected for Extended Bracketing) (p.197)
- When [Fine Sharpness] or [Extra Sharpness] is set for Custom Image, the sharpness of Extended Bracketing operates as Fine Sharpness or Extra Sharpness.
- When [Contrast] is set for Custom Image, the contrast of Extended Bracketing operates according to the [Contrast] setting.

You can apply a filter when taking pictures.
The following filters can be selected.

Filter Name	Effect	Parameter
Toy Camera	For taking pictures that look as if taken with a toy camera.	Shading Level: Low/Medium/High
		Blur: Low/Medium/High
		Tone Break: Red/Green/Blue/Yellow
Retro	For taking pictures with the look of old photos.	Toning (B-A): 7 levels
		Frame Composite: None/Thin/Medium/Thick
High Contrast	For taking pictures with high contrasts.	+1 to +5
Extract Color	For extracting one or two specific colors and making the rest of the image black and white.	Extracted Color 1: Red/Magenta/Blue/Cyan/Green/Yellow
		Extractable Range of Color 1: +1 to +5
		Extracted Color 2: OFF/Red/Magenta/Blue/Cyan/Green/Yellow
		Extractable Range of Color 2: +1 to +5
Soft ^{*1}	For taking pictures with a soft focus throughout the image.	Soft Focus: Low/Medium/High
		Shadow Blur: OFF/ON
Starburst ^{*1}	For taking pictures of night scenes or lights reflected on water with a special sparkling look by adding extra glitter to the highlights.	Shape: Cross/Star/Snow Crystal/Heart/Musical Note
		Effect Density: Small/Medium/Large
		Size: Small/Medium/Large
		Angle: 0°/30°/45°/60°
Fish-eye ^{*1}	For taking pictures that look as if taken with a fish-eye lens.	Low/Medium/High

Filter Name	Effect	Parameter
Custom Filter *1	You can customize and save a filter to your own preferences.	High Contrast: OFF/+1 to +5
		Soft Focus: OFF/+1 to +3
		Tone Break: OFF/Red/Green/Blue/Yellow
		Shading Type: 6 types
		Shading Level: -3 to +3
		Distortion Type: 3 types
		Distortion Level: OFF/Low/Medium/High
		Invert Color: OFF/ON
Color *2	For taking pictures with the selected color filter.	Color: Red/Magenta/Blue/Cyan/Green/Yellow
		Color Density: Light/Standard/Dark

*1 Not available when the exposure mode is set to  (Movie).

*2 Available only when the exposure mode is set to  (Movie).



- When Digital Filter is set, the file format is always set to [JPEG] and cannot be changed. You cannot use Digital Filter when the file format is set to [RAW] or [RAW+].
- When Digital Filter is set, the following functions are not available.
 - Interval Shooting, Multi-exposure, Continuous Shooting
 - Extended Bracketing or HDR Capture (The function selected last is used)



Depending on the filter used, it may take longer to save images.

1

Select [Digital Filter] in the [📷 Rec. Mode 2] menu and press the four-way controller (▶).

The screen for selecting a filter appears.

The last image taken after the camera was turned on is displayed in the background.

- 2 Use the four-way controller (◀▶) to select a filter.**

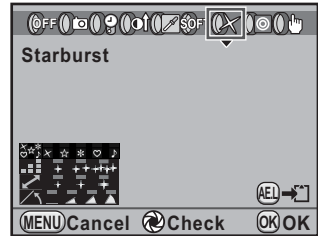

- 3 Use the four-way controller (▲▼) to select the parameter and the four-way controller (◀▶) to adjust the parameter's value.**

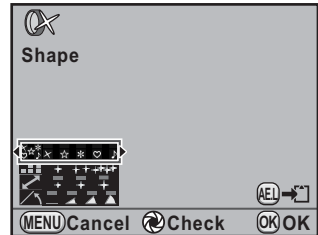

Available operations

Main switch (↻)	Uses Digital Preview to preview the background image with the filter effect applied. (Not available when the exposure mode is set to (Movie).)
AE-L button	Saves the background image.

- 4 Press the OK button.**

The camera returns to the [Rec. Mode 2] menu.

- 5 Press the MENU button.**

The camera is ready to take a picture.



- When the exposure mode is set to (Movie), change the settings from [Movie] in the [Rec. Mode 4] menu. (p.152)
- Select [Not use any filters] in Step 2 to finish shooting with digital filter.
- JPEG and RAW images can be processed with digital filters in Playback mode. (p.233)

You can shoot a picture while displaying the real-time image on the monitor.



- The image in Live View may differ from the captured image if the brightness of the subject is low or high.
- If any changes occur in the shooting light source during Live View, the image may flicker.
- If the camera position is changed rapidly during Live View, the image may not be displayed with the appropriate brightness. Wait for the display to become stable before shooting.
- Noise may appear on the Live View image when used in dark locations.
- The higher the sensitivity, the more noise and color unevenness may occur in the Live View image and/or captured image.
- Live View can be displayed for up to 5 minutes. When Live View is ended after the elapse of 5 minutes, Live View can be restarted by pressing the **LV** button.
- If you continue shooting with Live View for a prolonged period, the internal temperature of the camera may increase, resulting in lower quality images. It is recommended that you turn off Live View when not shooting. To prevent the image quality from degrading, allow enough time for the camera to cool down while shooting with long exposures or recording movies.
- If the internal temperature of the camera becomes high,  (temperature warning) is displayed and Live View may not be available. If this happens, stop shooting or use the viewfinder.



- During Live View, nothing is displayed in the viewfinder.
- Holding the camera by hand and shooting while viewing the monitor may cause camera shake. Use of a tripod is recommended.
- The field of view of the image display is nearly 100%.
- You can use the provided AV cable or a commercially available HDMI cable to display the Live View image on a TV or monitor. (p.224)
- Live View is not displayed when data is being saved to the SD Memory Card.

Setting Live View



You can set the display and autofocus mode for Live View.

- 1 Select [Live View] in the [📷 Rec. Mode 4] menu and press the four-way controller (▶).

The [Live View] screen appears.

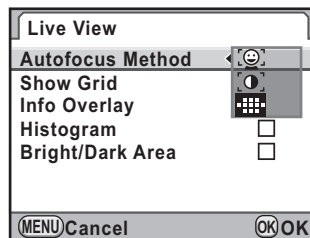

- 2 Press the four-way controller (▶) and use the four-way controller (▲▼) to select an autofocus method.



 Face Detection AF	Gives autofocus priority to detected faces and performs contrast autofocus. A yellow frame appears for a main face (white frames appear for other faces), and autofocus and automatic exposure are performed for the main face. (default setting) The face detection is not performed when the focus mode is set to MF .
 Contrast AF	Displays Live View and performs autofocus based on the information obtained from the image sensor.
 Phase Difference AF	Cancels Live View and performs autofocus with the AF sensor. If the shutter release button is pressed halfway during Live View, the Live View image will disappear and the autofocus system operates. Once focused, the Live View image will be displayed again.

- 3 Press the OK button.
- 4 Use the four-way controller (▲▼) to select [Show Grid] and press the four-way controller (▶).

5 Use the four-way controller (▲▼) to select a grid display type and press the OK button.

Select from [Off] (default setting),  (4x4 Grid),  (Golden Section) or  (Scale).

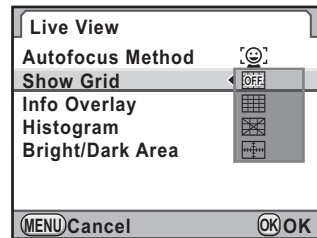



6 Use the four-way controller (▲▼) to select [Info Overlay], [Histogram] or [Bright/Dark Area].

7 Use the four-way controller (◀▶) to select or .

8 Press the MENU button twice.

The screen that was displayed before selecting the menu appears again.



It takes more time to focus on the subject when using  or , than when using . It is also difficult for the camera to focus on the following objects (or under the following conditions).

- objects with poor contrast
- objects with no vertical contrast, such as horizontal stripes
- objects with constantly changing brightness, shape, or color, such as a water fountain
- objects whose distance from the camera changes
- small objects
- objects appearing in both the foreground and background
- when using a special filter
- objects at the edge of the screen

Taking a Still Picture

1 Select an exposure mode.

Set the mode dial to any mode other than .

2 Press the **LV** button.

The mirror pops up and a real-time image is displayed on the monitor. Press the **LV** button again to exit Live View.

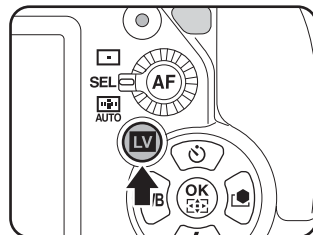

Live View display

(All of the indicators are displayed here for explanatory purposes.)

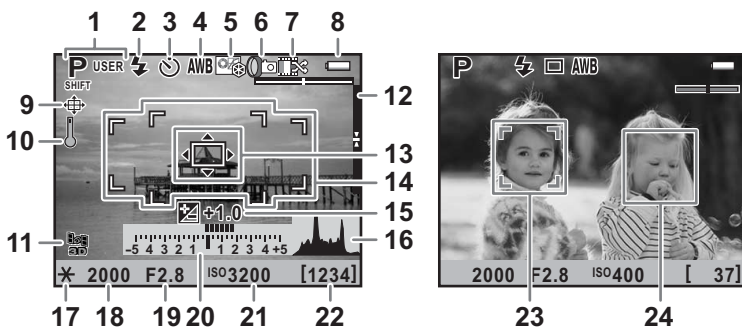



- | | | | |
|---|---|----|------------------------------------|
| 1 | Exposure Mode | 8 | Battery level |
| 2 | Flash Mode | 9 | Adjusting composition |
| 3 | Drive Mode | 10 | Temperature warning |
| 4 | White Balance | 11 | GPS positioning status |
| 5 | Custom Image | 12 | Electronic Level |
| 6 | Extended Bracketing/Multi-exposure/Interval Shooting/Digital Filter/HDR Capture | 13 | Contrast AF frame |
| 7 | Number of shots using Multi-exposure/Cross Processing | 14 | Phase Difference AF frame/AF point |
| | | 15 | EV Compensation |
| | | 16 | Histogram |

- | | | | |
|----|----------------|----|---|
| 17 | AE Lock | 22 | Remaining image storage capacity |
| 18 | Shutter speed | 23 | Main face detection frame (Face Detection AF) |
| 19 | Aperture value | 24 | Face detection frame (Face Detection AF) |
| 20 | EV bar | | |
| 21 | Sensitivity | | |

- * Indicator 9 is displayed when switching to Live View after adjusting the composition in [Composition Adjust.] (p.195) in the [Rec. Mode 2] menu.
- * Indicator 11 is displayed only when the optional GPS unit is attached to the camera and is operating. (p.305)
- * Indicator 12 is displayed when [Electronic Level] is set to (On). (p.262)
- * Indicator 14 (Phase Difference AF frame) is displayed in white during Live View. When the subject is in focus, a green square frame is displayed instead. It turns red when the subject is not in focus. It is not displayed when the focus mode is set to **MF**.
- * When 18, 19, and 21 can be changed, ► appears next to the set value.
- * Indicators 23 and 24 are displayed when [Autofocus Method] is set to  and the camera detects person's face(s). When the subject is in focus, a green frame is displayed. It turns red when the subject is not in focus.

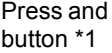
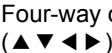
Available operations

INFO button	Enlarges the image. 2, 4, or 6 times original size (when the focus mode is AF) 2, 4, 6, 8 or 10 times original size (when the focus mode is MF)
 button	Returns the position of the display area to the center (during enlarged view).
Press and hold OK button *1	Switches the function of the four-way controller () to Change AF point or direct key operation.
OK button *1	Returns the position of the AF point to the center (when Change AF point is enabled).
Four-way controller ()	Changes the AF point (when Change AF point is enabled). Moves the display area (during enlarged view).

*1 Available only when [Autofocus Method] is  or , and the focus mode is **AF.S** or the AF point switching dial is set to **SEL** (Select).

3

Position the subject on the monitor and press the shutter release button halfway.

The autofocus system operates.

When the focus mode is set to **MF**, turn the focusing ring until the subject is clearly visible on the focusing screen.

4

Press the shutter release button fully.

The picture is taken.



- When the focus mode is set to **A.F.C** and [Autofocus Method] is set to **[O]**, the camera focuses on the center of the screen when autofocus starts and then automatically tracks the subject when it is in focus. When [Autofocus Method] is set to **[@]**, the camera automatically tracks the detected face.
- Images captured in magnified display are recorded at normal size.
- You can check the depth of field on the monitor by turning the main switch to **[R]** during Live View.



The status screen and control panel cannot be displayed during Live View. To change the settings, press the **MENU** button and change them from each menu.

You can record movies using Live View.

Changing the Movie Settings

You can record movies with monaural audio in AVI file format.

- 1 Select [Movie] in the [📷 Rec. Mode 4] menu and press the four-way controller (▶).

The [Movie] screen appears.

- 2 Press the four-way controller (▶), use the four-way controller (▲▼) to select the number of recorded pixels, and press the OK button.

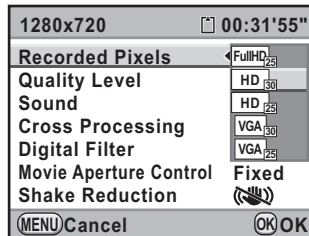



Recorded Pixels	Pixels	Aspect Ratio	Frame Rate
FullHD	1920×1080	16:9	25 fps
HD (default setting)	1280×720	16:9	30 fps
HD	1280×720	16:9	25 fps
VGA	640×480	4:3	30 fps
VGA	640×480	4:3	25 fps



- 3 Use the four-way controller (▲▼) to select [Quality Level] and press the four-way controller (▶).

- 4 Use the four-way controller (▲▼) to select the quality level and press the OK button.

Select from ★★★ (Best; default setting), ★★ (Better) and ★ (Good). When the recorded pixels and quality level are changed, the amount of recordable time at that setting appears at the top right of the screen.

5 Use the four-way controller (▲▼) to select [Sound] and press the four-way controller (▶).

6 Use the four-way controller (▲▼) to select  or  and press the OK button.

	Records sound. (default setting)
	Does not record sound.

7 Set Cross Processing and Digital Filter as necessary.



Refer to p.200 for details on Cross Processing and p.143 for Digital Filter.



8 Use the four-way controller (▲▼) to select [Movie Aperture Control] and press the four-way controller (▶).

9 Use the four-way controller (▲▼) to select the [Fixed] or [Auto] and press the OK button.

Fixed	The movie is recorded at the aperture value set before movie recording starts. (default setting)
Auto	The aperture is controlled automatically.

10 Use the four-way controller (▲▼) to select [Shake Reduction] and press the ▶ button.

11 Use the four-way controller (▲▼) to select  or  and press the OK button.

	Uses Shake Reduction.
	Does not use Shake Reduction. (default setting)

12 Press the MENU button twice.

The camera is ready to record a movie.

Connecting a Microphone

You can connect a commercially available stereo microphone to the microphone terminal on the camera and record stereo sound. Using an external microphone can also help to reduce the possibility of recording camera operation sounds.



The following specifications are recommended for external microphones.

- Plug: Stereo mini plug (ø3.5 mm)
- Format: Stereo electret condenser
- Power: Plug-in Power Method (operating voltage of 2.0 V or lower)
- Impedance: 2.2 kΩ

4

Shooting Functions

1 Turn off the camera.

2 Open the microphone terminal cover and connect the plug of the microphone to the microphone terminal on the camera.

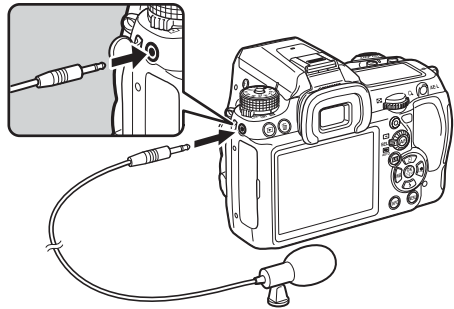

3 Turn the camera on.



If the external microphone is disconnected during recording, the camera cannot switch to the internal microphone until recording has stopped. No sound will be recorded.



If you used an external microphone to record movie sound in stereo, the sound can be played back in stereo when you use a commercially available HDMI cable to output the movie to an HDMI-compatible AV device. If you use an AV cable to output the movie, monaural sound is played back. (p.224)

Recording Movies

1 Set the mode dial to .

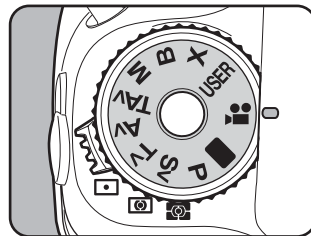

Live View for movie recording is displayed.

Sound







Recordable Time
Shake Reduction



4

Shooting Functions

Available operations

Rear e-dial ()	Changes the aperture value when [Movie Aperture Control] is set to [Fixed]. (default setting)
 button	Sets the aperture value to obtain a proper exposure. (default setting) Returns the position of the display area to the center (during enlarged view).
 button + Rear e-dial ()	Performs EV compensation (up to ± 2 EV).
INFO button	Enlarges the image. 2, 4, or 6 times original size (when the focus mode is AF) 2, 4, 6, 8 or 10 times original size (when the focus mode is MF)
Press and hold OK button *1	Switches the function of the four-way controller () to Change AF point or direct key operation.
OK button *1	Returns the position of the AF point to the center (when Change AF point is enabled).

Four-way controller Changes the AF point (when Change AF point is enabled).
 (▲▼◀▶) Moves the display area (during enlarged view).

*1 Available only when [Autofocus Method] is  or , and the focus mode is **AF.S** or the AF point switching dial is set to **SEL** (Select).

2 Position the subject on the monitor and press the shutter release button halfway.

The autofocus system operates.

When the focus mode is set to **MF**, turn the focusing ring until the subject is clearly visible on the focusing screen.

3 Press the shutter release button fully.

Recording of the movie starts.



4 Press the shutter release button again.

Recording stops.



- When [Sound] is set to  (On), the camera operation sounds are also recorded. When recording a movie, mount the camera onto a tripod and do not operate the camera while recording.
- While recording a movie, the autofocus system does not operate.
- The flash is not available.
- When recording movies using image processing, such as Digital Filter, some frames may be dropped from the recorded movie.
- If the internal temperature of the camera becomes high during movie recording, the recording may be terminated to protect the camera circuitry.



- You can record movies continuously up to 4 GB or 25 minutes. When the SD Memory Card is full, recording stops and the movie is saved.
- The Live View image in  mode is displayed according to the [Live View] settings made in the [Rec. Mode 4] menu. (p.147) However, the Bright/Dark Area warning is not displayed during movie recording.
- You can set the functions for when the front/rear e-dial or the  button is operated. (p.247)
- If you intend to shoot continuously for a long period, use of the AC adapter kit (optional) is recommended. (p.52)
- You can also use the optional remote control to record a movie. (p.127)
- The sensitivity is fixed to [ISO AUTO].
- If you want to view a movie on an external monitor while recording it, connect the camera to an AV device with a mini HDMI terminal. (p.226) You cannot output a movie using the PC/AV terminal while recording.

Playing Back Movies

Recorded movies can be played back in Playback mode in the same manner as saved still pictures.

1 Press the button.

The camera switches to Playback mode.

2 Use the four-way controller () to choose a movie to play back.







The first frame of the movie is displayed on the monitor.

3 Press the four-way controller ()

Movie playback starts.



Available operations

Four-way controller ()	Pauses/Resumes playback.
Rear e-dial ()	Volume control (6 levels)
Four-way controller ()	Forwards a frame (during pause).
Press and hold four-way controller ()	Fast-forwards playback while pressed.
Four-way controller ()	Reverses playback./ Reverses a frame (during pause).
Press and hold four-way controller ()	Fast-reverses playback while pressed.
Four-way controller ()	Stops playback./ Displays the playback mode palette (when stopped). (p.208)
AE-L button	Saves the displayed image in JPEG format (during pause).

When the movie ends, playback stops and the first frame is displayed again.



- You can use the provided AV cable or a commercially available HDMI cable to play back the recorded movies on a TV screen or other AV devices. (p.224)
- Even if you used an external microphone to record movie sound in stereo, monaural sound is played back when you output the movie via the PC/AV terminal. When you output the movie via the mini HDMI terminal, sound is played back in stereo.

Capturing a Still Picture from a Movie

You can capture a single frame from a movie and save it as a JPEG still picture.

- 1 Press the four-way controller (▲) in Step 3 on p.157 to pause the movie, and display the frame to save as a still picture.**

While paused, you can forward or reverse the movie in one-frame increments using the four-way controller (◀▶).

The frame number and total number of frames appear at the top right of the screen.

Frame number/Total number
of frames



- 2 Press the AE-L button.**

The save confirmation screen appears.

- 3 Use the four-way controller (▲▼) to select [Save as] and press the OK button.**

The captured image is saved as a new image.

Editing Movies

Movies can be divided and unwanted segments can be deleted.

1 Press the button.

The camera switches to Playback mode.

2 Use the four-way controller (◀▶) to choose a movie to play back.

The first frame of the movie is displayed on the monitor.

3 Press the four-way controller (▼).

The playback mode palette appears.

4 Use the four-way controller (▲▼◀▶) to select (Movie Editing) and press the OK button.

The movie editing screen appears.

5 Select point(s) where you want to divide the movie.

The first frame at the dividing point is displayed at the top of the screen.

Up to four points can be selected (divided into five segments).



Available operations

Four-way controller (▲)	Plays back/Pauses a movie.
Four-way controller (▶)	Moves forward 1 second (during pause). Moves to the next dividing point (during playback).
Four-way controller (◀)	Moves backward 1 second (during pause). Moves to the previous dividing point (during playback).
Rear e-dial ()	Volume control (6 levels)
⊙ button	Confirms/cancels a dividing point.

Proceed to Step 9 if you do not want to delete any segment.

6 Press the button.

The screen to select the segment(s) to delete is displayed.

7 Use the four-way controller (◀▶) to move the selection frame and press the OK button.

The segment(s) to delete are specified. Multiple segments can be deleted at once.

Press the **OK** button again to cancel the selection.

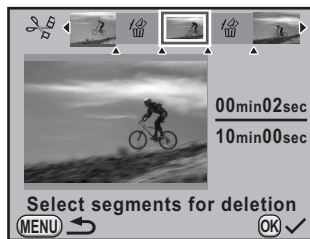

8 Press the **MENU** button.

The screen that was displayed in Step 5 appears again.

9 Press the **OK** button.

The save confirmation screen appears.

10 Use the four-way controller (▲▼) to select [Save as] and press the **OK** button.

The movie is divided at the specified points and the unwanted segments are deleted from it. The divided movie is then saved as separate files and the single image display reappears.



- Select dividing points in chronological order from the beginning of the movie. When canceling the selected dividing points, cancel each of them in reverse order (from the end of the movie to the beginning). In an order other than specified, you can neither select frames as a dividing point nor cancel the selections of the dividing points. You cannot, for example, select the frames prior to the last selected frame as a dividing point while selecting a dividing point.
- Movies with a short recording time cannot be divided.

5 Using the Flash

This chapter provides details on the built-in flash of this camera and describes how to take pictures with the external flash.

Using the Built-in Flash	162
Using an External Flash (Optional)	167

Flash Characteristics in Each Exposure Mode

Using the Flash in Tv Mode

- Any desired shutter speed of 1/180 sec. or slower can be set for taking a flash photograph.
- The shutter speed is locked at 1/180 sec. when a lens other than a DA, DA L, D FA, FA J, FA, F or A lens is used.

Using the Flash in Av Mode

- The shutter speed shifts automatically anywhere from 1/180 sec. to a slow shutter speed that reduces camera shake. The slowest shutter speed depends on the focal length of the lens in use.
- The shutter speed is locked at 1/180 sec. when a lens other than a DA, DA L, D FA, FA J, FA or F lens is used.

Using the Slow-speed Sync

You can use slow-speed-sync in **Tv** (Shutter Priority Automatic Exposure) mode when shooting portraits with the sunset in the background. Both the portrait and the background are captured beautifully.



- Slow-speed Sync slows the shutter speed. Use the Shake Reduction function or turn off the Shake Reduction function and use a tripod to avoid camera shake. The picture will also blur if the subject moves.
- Slow-speed Sync shooting can also be performed with an external flash.

Using P/Sv/Av Mode

- 1** Set the mode dial to **P**, **Sv** or **Av**.
- 2** Press the **⚡** button.
The built-in flash pops up.
- 3** Press the four-way controller (**▼**).
The [Flash Mode] screen appears.
- 4** Select **⚡^{SLOW}** or **Ⓞ^{SLOW}⚡** and press the **OK** button.
The shutter speed is set slower to give a proper exposure for the background.

Using Tv/TAv/M Mode

- 1** Set the mode dial to **Tv**, **TAv** or **M**.
- 2** Press the four-way controller (**▼**).
The [Flash Mode] screen appears.
- 3** Select **⚡** or **⚡[Ⓞ]** and press the **OK** button.
- 4** Set the shutter speed (for **Tv** mode) or shutter speed and aperture value (for **TAv** or **M** mode).
Set so a proper exposure is obtained at a shutter speed of 1/180 second or slower.
- 5** Press the **⚡** button.
The built-in flash pops up.

Using the Trailing Curtain Sync

Trailing Curtain Sync discharges the flash immediately before the shutter curtain closes. When shooting moving objects with a slow shutter speed, Trailing Curtain Sync and Slow-speed Sync produce different effects depending on when the flash is discharged.

For example, when shooting a moving car with Trailing Curtain Sync, trailing light is captured while the shutter is open and the flash captures the car immediately before the shutter is closed. Therefore, the picture will include a sharp, well-lit car with trailing light behind it.

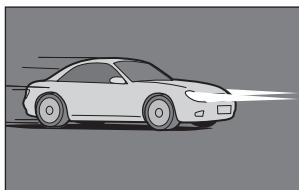



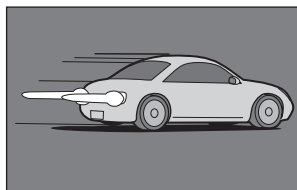

Slow-speed Sync
(Leading Curtain Sync)



Trailing Curtain Sync

5

Using the Flash

- 1 Set the mode dial to any mode other than , **X** or .
- 2 Press the four-way controller (**▼**).
- 3 Select  or  and press the OK button.
- 4 Press the  button.

The [Flash Mode] screen appears.

The built-in flash pops up.



Trailing Curtain Sync slows the shutter speed. Use the Shake Reduction function or turn off the Shake Reduction function and use a tripod to avoid camera shake.

Distance and Aperture when Using the Built-in Flash

Relationships between the guide number, aperture and distance must be considered when shooting with the flash to obtain a correct exposure. Calculate and adjust the shooting conditions if the flash output is not sufficient.

Sensitivity	Built-in Flash Guide Number	Sensitivity	Built-in flash guide number
ISO 100	Approx. 13	ISO 3200	Approx. 73.5
ISO 200	Approx. 18.4	ISO 6400	Approx. 104
ISO 400	Approx. 26	ISO 12800	Approx. 147
ISO 800	Approx. 36.8	ISO 25600 *1	Approx. 208
ISO 1600	Approx. 52	ISO 51200 *1	Approx. 294

*1 This can be used when [3. Expanded Sensitivity] in the [C Custom Setting 1] menu is set to [On].

Calculating Shooting Distance from Aperture Value

The following equation calculates the effective distance of the flash.

Maximum flash distance $L1 = \text{Guide number} \div \text{Aperture value}$

Minimum flash distance $L2 = \text{Maximum flash distance} \div 5^*$

* The value 5 used in the formula above is a fixed value which applies only when using the built-in flash alone.

Example: When the sensitivity is ISO 100 and the aperture value is F2.8

$$L1 = 13 \div 2.8 = \text{approx. } 4.6 \text{ (m)}$$

$$L2 = 4.6 \div 5 = \text{approx. } 0.9 \text{ (m)}$$

Therefore, the flash can be used in a range of about 0.9 m to 4.6 m. However, the built-in flash in this camera cannot be used when the distance is 0.7 m or less. When the flash is used at closer than 0.7 m, it causes vignetting in the picture corners, light is distributed unevenly and a picture may be overexposed.

Calculating Aperture Value from Shooting Distance

The following equation calculates the aperture value for shooting distances.

Aperture value $F = \text{Guide number} \div \text{Shooting distance}$

Example: When the sensitivity is ISO 100 and shooting distance is 4 m, the aperture value is:

$$F = 13 \div 4 = 3.25$$

If the resulting number (3.25, in the above example) is not available as a lens aperture, the smaller number that is closest (2.8, in the above example) is generally used.

Lens Compatibility with the Built-in Flash

Depending on the lens used with this camera, the use of the built-in flash may not be available or may be limited due to vignetting.

The built-in flash cannot be regulated and fully discharges when A lenses not set to the **A** (Auto) position, lenses manufactured prior to the A lenses or soft focus lenses are used.

DA, DA L, D FA, FA J, and FA lenses not listed below can be used without problems.

* The following lenses were evaluated without a hood.

Unavailable due to vignetting

Lens Name
DA FISH-EYE 10-17mm F3.5-4.5ED (IF)
DA12-24mm F4ED AL
DA14mm F2.8ED (IF)
FA★ 300mm F2.8ED (IF)
FA★ 600mm F4ED (IF)
FA★ 250-600mm F5.6ED (IF)

Available with some restrictions

Lens Name	Restrictions
F FISH-EYE 17-28mm F3.5-4.5	Vignetting may occur if the focal length is less than 20 mm.
DA16-45mm F4ED AL	When the focal length is less than 28 mm or when the focal length is 28 mm and the shooting distance is 1 m or less, vignetting may occur.
DA★ 16-50mm F2.8ED AL (IF) SDM	When the focal length is 20 mm or less or when the focal length is 35 mm and the shooting distance is less than 1.5 m, vignetting may occur.
DA17-70mm F4AL (IF) SDM	When the focal length is less than 24 mm or when the focal length is 24 mm and the shooting distance is 1 m or less, vignetting may occur.
DA18-250mm F3.5-6.3ED AL (IF)	Vignetting may occur if the focal length is less than 35 mm.
FA★ 28-70mm F2.8AL	Vignetting may occur if the focal length is 28 mm and the shooting distance is less than 1 m.
FA SOFT 28mm F2.8/ FA SOFT 85mm F2.8	Built-in flash always discharges fully.

Using an optional external flash AF540FGZ, AF360FGZ, AF200FG or AF160FC enables a variety of flash modes such as P-TTL auto flash mode.

(✓: Available #: Restricted ×: Not available)

Camera Function \ Flash	Built-in Flash	AF540FGZ AF360FGZ	AF200FG AF160FC
Red-eye reduction flash	✓	✓	✓
Auto flash discharge	✓	✓	✓
After the flash is charged, the camera automatically switches to the flash sync speed.	✓	✓	✓
Aperture value is automatically set in P mode and Tv mode.	✓	✓	✓
P-TTL auto flash (appropriate sensitivity: ISO 100 to 3200)	✓ ^{*1}	✓ ^{*1}	✓ ^{*1}
Slow-speed Sync	✓	✓	✓
Flash exposure compensation	✓	✓	✓
AF assist light of external flash	×	✓	×
Trailing Curtain Sync ^{*2}	✓	✓	×
Contrast-control-sync flash mode	# ^{*3}	✓	# ^{*4}
Slave flash	×	✓	×
High-speed flash sync	×	✓	×
Wireless flash	# ^{*4}	✓ ^{*5}	×

*1 Available only when using a DA, DA L, D FA, FA J, FA, F or A lens.

*2 Shutter speed of 1/90 sec. or slower.

*3 When combined with the AF540FGZ or AF360FGZ, 1/3 of the flash discharge can be output by the built-in flash and 2/3 can be output by the external flash.

*4 Available only when combined with the AF540FGZ or AF360FGZ.

*5 Multiple AF540FGZ or AF360FGZ units, or a combination of an AF540FGZ or AF360FGZ unit and the built-in flash is required.



- Flashes with reversed polarity (the center contact on the hot shoe is minus) cannot be used due to the risk of damaging the camera and flash.
- Do not combine with accessories that have a different number of contacts, such as a Hot Shoe Grip, as a malfunction may occur.
- Combining with flashes from other manufacturers may cause equipment breakdown. We recommend using the AF540FGZ, AF360FGZ or AF200FG.

About the Display Panel for AF360FGZ

The AF360FGZ itself does not have the function to set the FORMAT size to [DIGITAL]. However, when it is used with a SLR Digital Camera, the difference in focal length between a 35 mm camera and this camera is automatically calculated based on the difference in angle of view and is displayed on the panel (when using DA, DA L, D FA, FA J, FA or F lens). The conversion indicator appears and the FORMAT size indicator disappears when the exposure metering timer of this camera is on (it returns to 35 mm format display when the exposure metering timer is turned off).

Lens Focal Length	85mm /77mm	50mm	35mm	28mm /24mm	20mm	18mm
Exposure metering timer Off	85mm	70mm	50mm	35mm	28mm	24mm*
Exposure metering timer On	58mm	48mm	34mm	24mm	19mm	16mm*

* Using wide-angle panel

Using the P-TTL Auto Flash

You can use the P-TTL auto flash with an AF540FGZ, AF360FGZ, AF200FG or AF160FC flash unit.

The flash pre-flashes before the actual flash and confirms the subject (the distance, brightness, contrast, whether it is backlit, etc.) using the camera 77-segment metering sensor. The flash output for the actual flash is adjusted based on the information obtained from the pre-flash, enabling flash photography with more accurate exposure for the subject than with normal TTL auto.

- 1** Remove the cover of the hot shoe and attach the external flash.
- 2** Turn on the camera and the external flash.
- 3** Set the external flash mode to [P-TTL].
- 4** Confirm that the external flash is fully charged and then take a picture.

The  will light in the viewfinder when the flash is ready (fully charged).



- For details such as operation method and effective distance, please refer to the external flash manual.
- The flash does not discharge if the subject is bright enough when the flash mode is ⚡^A or ⚡^B . Therefore, it may not be suitable for Daylight-Sync shooting.
- Never press the ⚡ button when any external flash unit is attached to the camera. The built-in flash will hit the external flash. If you want to use both at once, set the wireless mode or connect them using the extension cord. (p.173)

Using High-Speed Flash Sync Mode

With the AF540FGZ or AF360FGZ, you can discharge the flash to take a picture at a shutter speed faster than 1/180 second.

1 Remove the cover of the hot shoe and attach the external flash.

2 Set the exposure mode to P, Tv, TAv or M.

Select an exposure mode which allows you to set the shutter speed.

3 Turn on the camera and the external flash.

4 Set the external flash sync mode to HS ⚡ (High-speed flash sync).

5 Confirm that the external flash is fully charged and then take a picture.

The ⚡ will light in the viewfinder when the flash is ready (fully charged).



- High-speed flash sync is available only when the shutter speed is set faster than 1/180 sec.
- High-speed flash sync is not available when the exposure mode is set to **B** (Bulb Exposure).
- High-speed sync is not available with the built-in flash.

Using Flash in Wireless Mode

By using two external flashes (AF540FGZ or AF360FGZ) or using the built-in flash with one or more external flashes, you can shoot in P-TTL flash mode without connecting the flash units with a cord.



- Set the power switch of the external flash to WIRELESS.
- Two or more AF540FGZ/AF360FGZ external flashes are required to use high-speed flash sync in wireless mode. This function cannot be used in combination with the built-in flash.
- Set the wireless mode of the external flashes not directly connected to the camera to SLAVE.

Setting the Channel for the External Flash

5 First, set the channel for the external flash unit.

1

Set the channel for the external flash unit.

2

Remove the cover of the hot shoe and attach the external flash.

3

Turn on the camera and the external flash, and press the shutter release button halfway.

The built-in flash is set to the same channel as the external flash unit.



Be sure to set all the flashes to the same channel. Refer to the manual of the AF540FGZ or AF360FGZ for details on how to set the channel on the external flash.

Wireless Shooting Using a Combination of the Built-in Flash and an External Flash Unit

Set the camera to wireless flash mode when using an external flash in combination with the built-in flash.

1 Remove the external flash unit after the channel is set on the camera, and place it at the desired location.

2 Press the four-way controller (▼).

The [Flash Mode] screen appears.

3 Select **w** and press the **OK** button.

The camera is ready to take a picture.

The channel for the built-in flash is displayed in the viewfinder and on the LCD panel. The factory default setting is CH1.

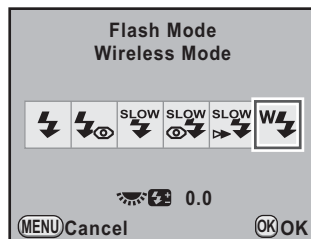

4 Press the **⚡** button.

5 Confirm that both flashes are fully charged, and then take a picture.



- **w** cannot be set when the exposure mode is set to **■** (Green).
- When the drive mode is set to **rs** (Remote Control (3s delay)), **MUP** (Mirror Lock-up) or **MUP** (Mirror Lock-up + Remote Control), or the lens aperture is not set to the **A** position, **w** cannot be selected.

Changing the Built-in Flash Discharge Method

You can change the built-in flash discharge method used in wireless mode.

Set in [21. Flash in Wireless Mode] of the [C Custom Setting 3] menu.

1	On	Discharges the built-in flash as a master. (default setting)
2	Off	Discharges the built-in flash as a control flash.



HS ⚡ (High-speed flash sync) is not available with the built-in flash.

Wireless Shooting Using a Combination of External Flash Units

5

1 Set the wireless mode of the external flash directly connected to the camera to [MASTER] or [CONTROL].

MASTER	Discharges both the flash directly connected to the camera and the wireless flash unit as the main flash.
CONTROL	Discharges the flash directly connected to the camera as a control flash only, not as the main flash.

2 On the wireless remote flash unit, set the wireless flash mode to [SLAVE] and set the channel to the same channel as the flash directly connected to the camera. Then, place it at the desired location.

3 Confirm that both flashes are fully charged and then take a picture.



- The Shake Reduction function is automatically turned off in wireless mode.
- When using multiple AF540FGZ/AF360FGZ external flashes and performing high-speed flash sync shooting in wireless mode, set the flash directly connected to the camera to high-speed flash sync mode.
- When the wireless mode of the external flash directly connected to the camera is set to [MASTER] or [21. Flash in Wireless Mode] (p.172) is set to [On] for the built-in flash, all the flashes will discharge simultaneously.

Connecting an External Flash with an Extension Cord

When using an external flash away from the camera, attach the Hot Shoe Adapter F_G (①; optional) to the camera hot shoe and an Off-Camera Shoe Adapter F (②; optional) to the bottom of the external flash, and then connect these with the Extension Cord F5P (③; optional). The Off-Camera Shoe Adapter F can be mounted to your tripod using the tripod screw.

When combining with the built-in flash

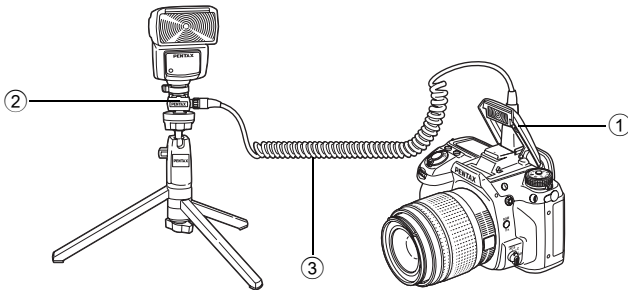

5

Using the Flash

Multiple Flash Shooting Using Extension Cords

You can combine two or more external flashes (AF540FGZ, AF360FGZ or AF200FG) or you can use two or more external flashes in combination with the built-in flash.

For connecting the AF540FGZ flash unit, you can use the extension cord connection terminal on the flash. For connecting the AF360FGZ or AF200FG flash unit, as shown in the following illustration, connect an external flash and the Hot Shoe Adapter F (④; optional) to the Off-Camera Shoe Adapter F (②; optional) and then connect another Off-Camera Shoe Adapter F (②) with another external flash using the Extension Cord F5P (③; optional).

Refer to the manual of the flash for details.

When combining two or more external flashes

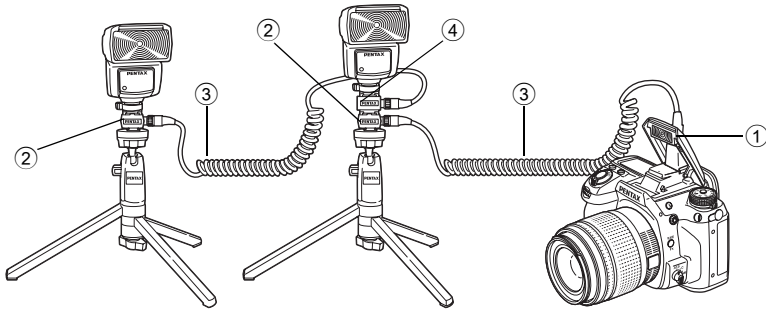

When using multiple external flashes or using an external flash with the built-in flash, P-TTL is used for flash control.

5

Using the Flash

Contrast-Control-Sync Flash

Combining two or more external flashes (AF540FGZ, AF360FGZ or AF200FG) or using an external flash in combination with the built-in flash allows multiple flash photography (contrast-control-sync flash photography). This is based on the difference between the amounts of light discharged from multiple units.



The AF200FG must be combined with the AF540FGZ or AF360FGZ.

1

Connect the external flash to the camera indirectly.

Refer to p.173 for details.

2

Set the sync mode for the external flash to contrast-control-sync mode.

3

Confirm that both the external flash and built-in flash are fully charged and then take a picture.



- When using two or more external flashes and the contrast-control-sync mode is set on the external master flash unit, the flash output ratio is 2 (master unit) : 1 (slave units). When an external flash is used in combination with the built-in flash, the flash output ratio is 2 (external flash) : 1 (built-in flash).
- When using multiple external flashes or using an external flash with the built-in flash, P-TTL is used for flash control.

X-sync Socket

You can connect an external flash to the camera with a sync cord by using the X-sync socket.

Remove the Sync socket 2P cap and connect a sync cord to the X-sync socket.

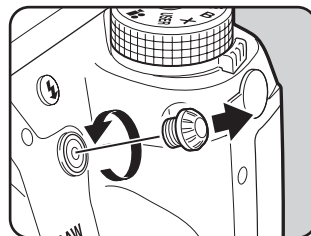

- The use of high-voltage or high-current external flashes may cause a camera breakdown.
- Flashes with reversed polarity (the center of the sync plug is minus) cannot be used due to the risk of damaging the camera and flash.
- When a sync cord is connected to the X-sync socket, linked functions will not work.
- To prevent vignetting caused from Trailing Curtain Sync, it is recommended to take a test shot using a shutter speed one level slower than the flash sync speed.
- The contact of the X-sync socket is not dust-proof and water-resistant. Attach the provided Sync socket 2P cap when not in use.

6 Shooting Settings

This chapter describes how to set the save format for pictures taken and other settings.

Setting a File Format	178
Setting the White Balance	183
Correcting Images	190
Setting the Image Finishing Tone	197
Storing Frequently Used Settings	202

Setting the JPEG Recorded Pixels

You can select the number of recorded pixels from **16M**, **10M**, **6M** and **2M**. The default setting is **16M**.

Recorded Pixels	Pixels
16M	4928×3264
10M	3936×2624
6M	3072×2048
2M	1728×1152

1 Select **[JPEG Recorded Pixels]** in the **[📷 Rec. Mode 1]** menu and press the four-way controller (▶).

2 Use the four-way controller (▲▼) to select the number of recorded pixels and press the **OK** button.

When the number of recorded pixels is changed, the number of pixels appears at the top left of the screen and the number of recordable images for that setting appears at the top right of the screen.

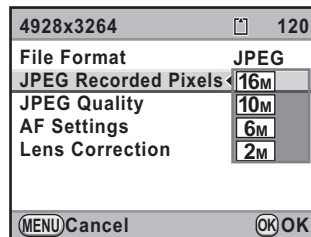

3 Press the **MENU** button.

The camera is ready to take a picture.

Setting the JPEG Quality Level

You can set the image quality level (compression ratio). The default setting is ★★★ (Best).

★★★★ Premium		Images will be clearer but file size will be larger.
★★★ Best		
★★ Better		
★ Good		Images will be grainier but file size will be smaller.

1 Select [JPEG Quality] in the [📷 Rec. Mode 1] menu and press the four-way controller (▶).

2 Use the four-way controller (▲▼) to select a quality level and press the OK button.

When the quality level is changed, the number of recordable images at that quality level appears at the top right of the screen.

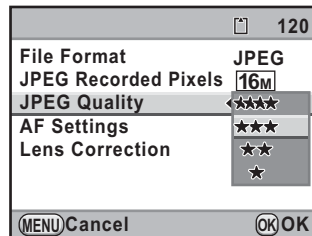

3 Press the MENU button.

The camera is ready to take a picture.

Setting a File Format

You can set the format of image files.

JPEG	Captures images in JPEG format. (default setting) You can change the number of recorded pixels in [JPEG Recorded Pixels] and the image quality level in [JPEG Quality].
RAW	RAW format is a CMOS sensor output format saved without processing. Effects of White Balance, Custom Image and Color Space are not applied to the captured images, but they are saved as actual original information. When you perform the development process by using the [RAW Development] function (p.238), you can create JPEG images with these effects.
RAW+	Images are saved in both RAW and JPEG formats. When [One Push File Format] is assigned to the RAW/Fx button, you can press the RAW/Fx button to temporarily change the file format and save an image in both file formats. (p.181)



When Extended Bracketing, Digital Filter, HDR Capture or Cross Processing is set, the file format is set to [JPEG] and cannot be changed. To change the file format, turn these functions off.

6

Shooting Settings

1 Select [File Format] in the [📷 Rec. Mode 1] menu and press the four-way controller (▶).

2 Use the four-way controller (▲▼) to select a file format.

When the file format is changed, the number of recordable images appears at the top right of the screen.

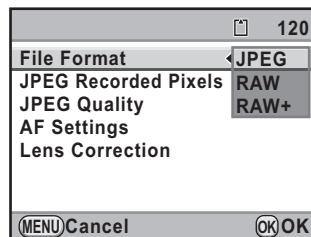

3 Press the **OK** button.

4 Press the **MENU** button.

The camera is ready to take a picture.

Setting the RAW File Format

You can select PEF or DNG format in [RAW File Format] of the [📷 Rec. Mode 3] menu when capturing images in RAW format.

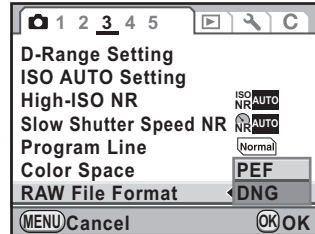

PEF	PENTAX's original RAW file format (default setting)
DNG	General-purpose, publicly available RAW file format designed by Adobe Systems

Temporarily Changing the File Format using the RAW/Fx Button

When [One Push File Format] is assigned to the **RAW/Fx** button, you can temporarily change the file format.

- 1** Select [Button Customization] in the [📷 Rec. Mode 5] menu and press the four-way controller (▶).

The [Button Customization] screen appears.

- 2** Use the four-way controller (▲▼) to select [RAW/Fx Button] and press the four-way controller (▶).

The [RAW/Fx Button] screen appears.

- 3** Press the four-way controller (▶).

- 4** Use the four-way controller (▲▼) to select [One Push File Format] and press the OK button.

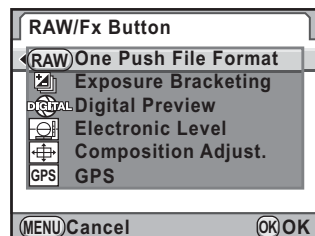

- 5** Use the four-way controller (▲▼) to select [Cancel after 1 shot] and use the four-way controller (◀▶) to select or .

<input checked="" type="checkbox"/>	The recording format returns to the original file format after a picture is taken. (default setting)
<input type="checkbox"/>	The setting is canceled when the following operations are performed. <ul style="list-style-type: none"> - the RAW/Fx button is pressed again - the  button or MENU button is pressed - the main switch is turned off - the mode dial is turned

- 6** Use the four-way controller (▲▼) to choose a file format.

The left side is the [File Format] setting and the right side is the file format when the **RAW/Fx** button is pressed.

- 7** Press the four-way controller (▶), and use the four-way controller (▲▼) to select a file format when the **RAW/Fx** button is pressed.

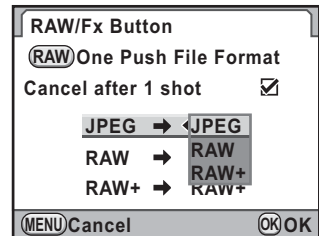







- 8** Press the **OK** button.

- 9** Press the **MENU** button three times.

The screen that was displayed before selecting the menu appears again.

Adjusts the color of an image based on ambient light conditions so that white objects appear white.

Item	Setting	Color Temperature ^{*1}
AWB Auto	Automatically adjusts the white balance. (default setting)	Approx. 4,000 to 8,000K
 Daylight	For use when taking pictures in sunlight.	Approx. 5,200K
 Shade	For use when taking pictures in the shade. It reduces the bluish color tones in a picture.	Approx. 8,000K
 Cloudy	For use when taking pictures on cloudy days.	Approx. 6,000K
 Fluorescent Light	For use when taking pictures under fluorescent lighting. Select the type of fluorescent light. D Fluorescent Light Daylight Color N Fluorescent Light Daylight White W Fluorescent Light Cool White L Fluorescent Light Warm White	Approx. 6,500K Approx. 5,000K Approx. 4,200K Approx. 3,000K
 Tungsten Light	For use when taking pictures under light bulbs or other tungsten light. It reduces the reddish color tones in a picture.	Approx. 2,850K
 WB Flash	For use when taking pictures using the built-in flash.	Approx. 5,400K
CTE ^{*2}	Use this to keep and strengthen the color tone of the light source in the image.	-
 Manual 1-3	Use this to manually adjust the white balance according to the lighting when taking pictures. You can save three settings.	-
K Color Temperature 1~3	Use figures to set the color temperature. You can save three settings.	-

*1 The color temperatures (K) shown above are all estimates. These do not indicate precise colors.

*2 CTE = Color Temperature Enhancement



White balance is fixed to **AWB** when the exposure mode is set to  (Green), or when Cross Processing is set.

1 Press the four-way controller (◀) in Capture mode.

The [White Balance] screen appears.

The last image taken after the camera was turned on is displayed in the background.

2 Use the four-way controller (▲▼) to select the white balance.

When  is selected, press the four-way controller (▶) and use the four-way controller (▲▼) to select **D**, **N**, **W**, or **L**. Proceed to Step 6 if you do not need to change the parameters.

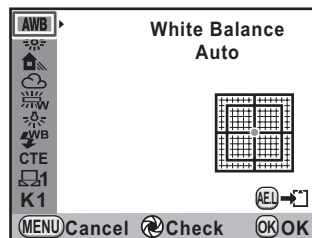

Available operations

Main switch (↻)	Uses Digital Preview to preview the background image with the setting applied. (Not available during Live View.)
AE-L button	Saves the background image. (Not available during Live View.)

3 Press the four-way controller (▶).

The fine-tuning screen appears.

4 Fine-tune the white balance.

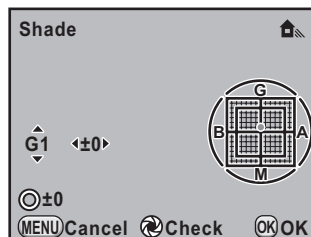

Available operations

Four-way controller (▲▼)	Adjusts the tone of the colors between green (G) and magenta (M).
Four-way controller (◀▶)	Adjusts the tone of the colors between blue (B) and amber (A).
⊙ button	Resets the adjustment value.

5 Press the OK button.

The screen that was displayed in Step 2 appears again.

6 Press the OK button.

The camera is ready to take a picture.



- The camera automatically performs fine-tuning even when the light source is specified. The color temperature of the light source is fixed when [10. WB Adjustable Range] is set to [Fixed] in the [C Custom Setting 2] menu.
- Because the light source changes when a flash discharges, you can set the white balance for when the flash discharges. Select [Auto White Balance], [Unchanged] or [Flash] in [11. WB When Using Flash] of the [C Custom Setting 2] menu.

Adjusting the White Balance Manually

You can adjust the white balance depending on the light source when taking pictures. Up to three settings can be saved.

1 Select in Step 2 on p.184 and press the four-way controller (▶).

2 Use the four-way controller (▲▼) to select 1 to 3 and press the four-way controller (▶).

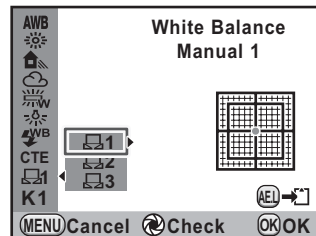

3 Under the light to measure the white balance, fully display a white sheet of paper in the viewfinder or select a white area as the subject.

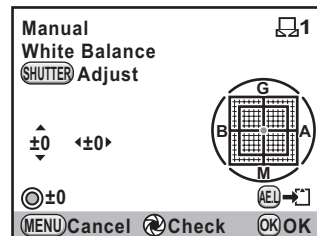

4 Press the shutter release button fully.

Set the focus mode to **MF** when the shutter cannot be released.
The screen to select the measuring range is displayed.

5 Use the rear e-dial (☀️) to select the entire screen or spot area for the measuring range.

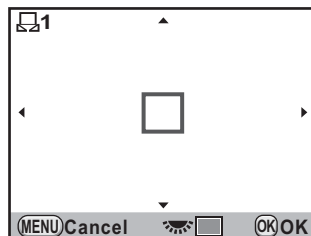

6 When a spot area is selected, use the four-way controller (▲▼◀▶) to move the frame to the position you want to measure.

7 Press the OK button.

The white balance is measured, and the screen that was displayed in Step 3 appears again.

Adjust the white balance as necessary.

The message [The operation could not be completed correctly] appears when measuring is unsuccessful. Press the **OK** button to remeasure the white balance.

8 Press the OK button twice.

The camera is ready to take a picture.



- If a picture is extremely overexposed or underexposed, the white balance may not be adjusted. In this case, adjust exposure to the correct amount level before adjusting the white balance.
- When the mode dial is set to 🎥 (Movie), the white balance cannot be measured. Adjust the white balance in any exposure mode other than 🎥 before recording a movie.

Saving the White Balance Settings of a Captured Image

You can copy the white balance settings of a captured image and save it as Manual White Balance.



Only the white balance settings of still pictures captured with this camera can be copied. The following images cannot be selected.

- Multi-exposure image
- Index image
- Still pictures captured from a movie

1 In Playback mode, display the image with the white balance settings you want to copy.

2 Press the four-way controller (▼).

The playback mode palette appears.

3 Use the four-way controller (▲▼◀▶) to select (Save as Manual WB) and press the OK button.

The save confirmation screen appears.

You can turn the front e-dial () to select a different image.

4 Use the four-way controller (▲▼) to select a number and press the OK button.

The white balance settings of the selected image is saved to Manual White Balance and the camera switches to Capture mode. The white balance setting is (Manual).

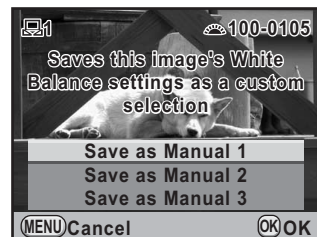

Adjusting the White Balance with Color Temperature

Use figures to set the color temperature. Up to three settings can be saved.

- 1 Select **K** in Step 2 on p.184 and press the four-way controller (▶).
- 2 Use the four-way controller (▲▼) to select **K1** to **K3** and press the four-way controller (▶).

The [Color Temperature] screen appears.

- 3 Adjust the color temperature with the front or rear e-dial.

You can set the color temperature value within the range from 2500K to 10000K.

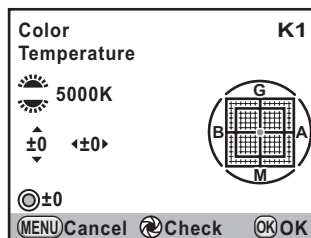

Color temperature steps vary depending on the e-dial.

E-dial	Kelvin	Mired ^{*1}
Front (☀️)	1 Step (100K)	1 Step (20M)
Rear (🌑)	10 Steps (1,000K)	5 Steps (100M)

*1 The default setting for Color Temperature step units is [Kelvin]. You can change the step units to [Mired] in [13. Color Temperature Steps] of the [C Custom Setting 2] menu. However, figures are converted to Kelvin and displayed.

- 4 Press the **OK** button.

The camera returns to the [White Balance] screen.

- 5 Press the **OK** button.

The camera is ready to take a picture.

Setting the Color Space

You can select a color space to use.

sRGB	Sets to sRGB color space. (default setting)
AdobeRGB	Sets to AdobeRGB color space.

Set in [Color Space] of the [📷 Rec. Mode 3] menu.

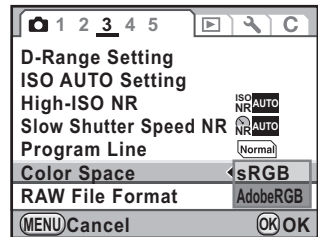

The file naming system changes depending on the color space setting as shown below.

For sRGB: IMGpxxxx.JPG

For AdobeRGB: _IGPxxxx.JPG

“xxxx” indicates the file number. This is displayed as a four-digit sequential number. (p.264)

The camera and lens properties can be automatically adjusted for when taking pictures.

Adjusting Brightness

Adjusts the brightness and reduces the occurrence of overexposed and underexposed areas.

D-Range Setting

Expands the dynamic range and enables a more ample gradation expression by the CMOS sensor and reduces the occurrence of overexposed and underexposed areas.

6

Shooting Settings

- 1 Select [D-Range Setting] in the [📷 Rec. Mode 3] menu and press the four-way controller (▶).

The [D-Range Setting] screen appears.

- 2 Use the four-way controller (▲▼) to select [Highlight Correction] and press the four-way controller (▶).

- 3 Use the four-way controller (▲▼) to select [Off] or [On] and press the OK button.

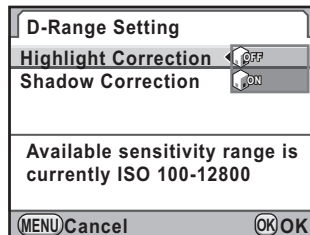

- 4 Use the four-way controller (▲▼) to select [Shadow Correction] and press the four-way controller (▶).

- 5** Use the four-way controller (▲▼) to select [Off], [Low], [Medium] or [High] and press the OK button.

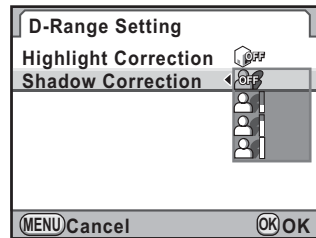

- 6** Press the MENU button twice.

The camera is ready to take a picture.



When [Highlight Correction] is set to [On], the minimum sensitivity is set to ISO 200. When [3. Expanded Sensitivity] is set to [On] in the [C Custom Setting 1] menu, the minimum sensitivity is set to ISO 160.

HDR Capture

Enables capturing images with high dynamic range. Takes three images (-3 EV underexposed, standard (proper exposure) and +3 EV overexposed) to create a single composite image with them.



- HDR Capture is not available in the following situations.
 - when the file format is set to [RAW] or [RAW+] (fixed to [JPEG])
 - when the exposure mode is set to **B** (Bulb Exposure) or **X** (Flash X-sync Speed)
- When HDR Capture is set, the following functions are not available.
 - Flash discharge
 - Drive modes other than □ (Single Frame Shooting), ☺ (Self-timer (12 sec.)), ☺ (Self-timer (2 sec.)), 📡 (Remote Control) or 📡 (Remote Control (3s delay))
 - Interval Shooting or Multi-exposure
 - Extended Bracketing, Digital Filter or Cross Processing (The function selected last is used.)
- During HDR Capture, multiple images are combined together to create a single image, so it will take time to save an image.

- 1** Select [HDR Capture] in the [📷 Rec. Mode 2] menu and press the four-way controller (▶).

The [HDR Capture] screen appears.

- 2** Press the four-way controller (▶) and use the four-way controller (▲▼) to select [Off], [Auto], [Standard], [Strong 1], [Strong 2] or [Strong 3].

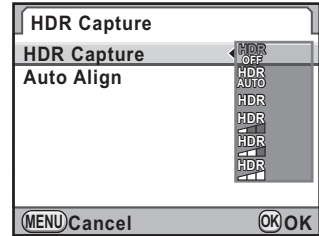

- 3** Press the OK button.

- 4** Use the four-way controller (▲▼) to select [Auto Align] and use the four-way controller (◀▶) to select or .

<input type="checkbox"/>	[Shake Reduction] is fixed to (Off). Use a tripod to prevent camera shake when taking pictures. (default setting)
<input checked="" type="checkbox"/>	The Shake Reduction function operates according to the Shake Reduction setting at that point. HDR Capture can be used without a tripod. [Program Line] (p.89) is fixed to (Hi-speed Priority) and [AUTO ISO Parameters] (p.84) is fixed to (Fast).

- 5** Press the MENU button twice.

The camera is ready to take a picture.



- During HDR Capture, pressing the **MENU** button while an image is being saved cancels the process and saves the image as a standard image.
- When both [Shake Reduction] and [Auto Align] are set to on, be careful of the following points.
 - Make sure to hold the camera firmly so that the composition of the picture does not change while the three images are taken. If there is a great difference of the composition between three images, [Auto Align] may not be possible.
 - Images taken with HDR Capture are susceptible to camera shake and blur. Be sure to set a higher shutter speed and a higher ISO sensitivity.
 - When the exposure mode is set to **P** (Program Automatic Exposure), [Program Line] is set to (Hi-speed Priority).
 - When the ISO sensitivity is set to [ISO AUTO], the sensitivity can be raised more easily than normal.
 - [Auto Align] may not be possible for lenses that have a focal length exceeding 100 mm.
 - When the entire subject is checkered or has a uniform surface, [Auto Align] may not be possible.

Lens Correction

Reduces distortions and lateral chromatic aberrations occurring due to lens properties.

● Distortion

Distortion is the phenomenon in which the center of the image appears inflated (barrel distortion) or the center of the image appears pinched (pincushion distortion). Distortion occurs more easily when using a zoom lens or a small diameter lens, and straight walls or the horizon in the image appear curved.

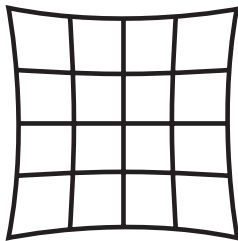

Pincushion distortion

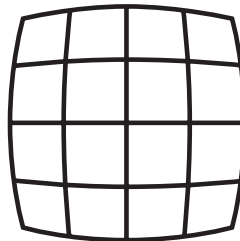

Barrel distortion

● Lateral chromatic aberration

Lateral chromatic aberration is the phenomenon in which the magnification of the image varies according to the colors (wavelengths of light) when a picture was taken, and may cause a blurred image. Lateral chromatic aberration occurs more easily at shorter focal lengths.

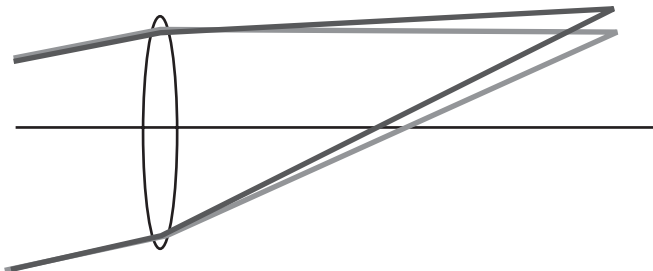



- Corrections can only be made when using DA, DA L, D FA or some FA lenses. [Lens Correction] cannot be selected when an incompatible lens is attached. (p.297)
- The Lens Correction function is disabled when using an accessory such as a close-up ring or rear converter that is attached between the camera and the lens.
- When the Lens Correction function is activated, it may take longer to display Instant Review and the shooting speed for continuous shooting may be slower.
- The effect of the Lens Correction function may be barely noticeable in some cases due to the shooting conditions or other factors.

1 Select [Lens Correction] in the [📷 Rec. Mode 1] menu and press the four-way controller (▶).

The [Lens Correction] screen appears.

2 Use the four-way controller (▲▼) to select [Distortion Correction] or [Lat-Chromatic-Ab Adj].

3 Press the four-way controller (▶) and use the four-way controller (▲▼) to select [OFF] or [ON].

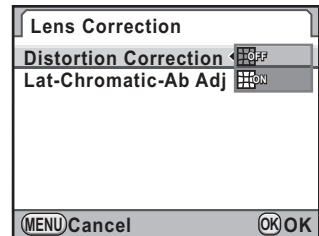

4 Press the OK button.

5 Press the MENU button twice.

The camera is ready to take a picture.



When a compatible lens is attached and the file format is set to [RAW] or [RAW+], the correction information is saved as a RAW file parameter and you can select [On] or [Off] when developing the RAW images. (p.238)

Adjusting the Composition

Adjusts the Shake Reduction unit in the X-Y direction or rotation direction for a better composition position and a more level camera. Use this when you want to adjust the composition, such as when using a tripod.

1 Select [Composition Adjust.] in the [📷 Rec. Mode 2] menu and press the four-way controller (▶).

The [Composition Adjust.] screen appears.

2 Select [Start Adjustment] and press the OK button.

To start adjusting the composition from the previous position, use the four-way controller (▲▼) to select [Recall Previous Position] and use the four-way controller (◀▶) to switch to .

Live View is displayed and the composition can be adjusted.

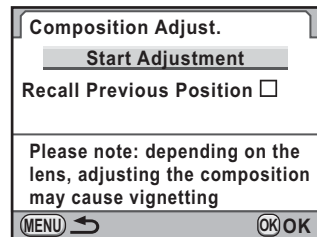

3 Adjust the composition.

The amount of compensation (the number of steps) is displayed at the top right of the screen.



Available operations

Four-way controller (▲▼◀▶)	Moves the composition up, down, left or right. Adjust up to 24 steps (approximately ± 1.5 mm) on the image sensor.
Rear e-dial (🔍)	Adjusts the level of the composition when the amount of adjustment is less than 16 steps (± 1.0 mm) up or down, or to the left or right. Up to 8 steps (approximately $\pm 1^\circ$) can be adjusted.
⊙ button	Resets the adjustment value.

4 Press the OK button.

The camera returns to normal Live View and is ready to take a picture.



- Shake Reduction and Horizon Correction are not available.
- The saved adjustment value is reset when Live View is ended.
- When using the composition adjustment function frequently, you can assign the function to the **RAW/Fx** button. (p.249)

Take pictures with settings to suit for your creative photographic vision.

Setting Custom Image

Select the desired picture style from the following modes and enjoy taking pictures with a creative finishing tone.

Image Tone	Image
Bright	Saturation, hue and contrast are set relatively high to create a bright sharp image. (default setting)
Natural	Creates a natural look that is close to the actual color.
Portrait	Reproduces a healthy and bright skin tone.
Landscape	Increases color saturation, highlights shapes, and produces a vivid color image.
Vibrant	Changes the color slightly to create an antique look.
Muted	Reduces the saturation to create a soft look.
Bleach Bypass	Reduces the saturation and increases the contrast to create the look of an old picture.
Reversal Film	Creates a picture with strong image contrast as if taken with reversal film.
Monochrome	Takes pictures using a monochrome color filter.



Image finishing tone is fixed to [Bright] and the parameters cannot be changed in the following conditions.

- when the exposure mode is set to  (Green)
- when Cross Processing is set

1

Press the four-way controller (▶) in Capture mode.

The screen to select a custom image appears.

The last image taken after the camera was turned on is displayed in the background.

- 2 Use the four-way controller (◀▶) to select an image finishing tone.

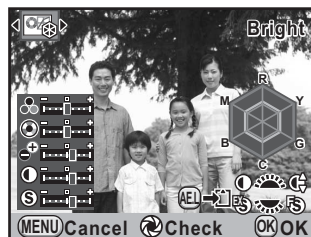

- 3 Use the four-way controller (▲▼) to choose a parameter you want to change.

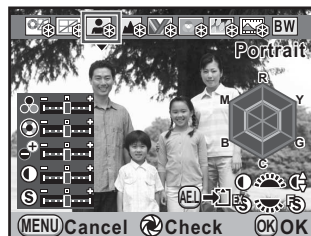

The following parameters can be changed according to the selected image finishing tone.

6

Image Tone	Parameter
Bright/ Natural/ Portrait/ Landscape/ Vibrant	Saturation: -4 to +4
	Hue: -4 to +4
	High/Low Key Adj: -4 to +4
	Contrast: -4 to +4
	Sharpness: -4 to +4
Muted/ Bleach Bypass	Saturation: -4 to +4
	Toning: Off/Green/Yellow/Orange/Red/Magenta/Purple/ Blue/Cyan
	High/Low Key Adj: -4 to +4
	Contrast: -4 to +4
Reversal Film	Sharpness: -4 to +4

Image Tone	Parameter
Monochrome	Filter Effect: None/Green/Yellow/Orange/Red/Magenta/Blue/Cyan/Infrared Filter
	Toning: Off/Green/Yellow/Orange/Red/Magenta/Purple/Blue/Cyan
	High/Low Key Adj: -4 to +4
	Contrast: -4 to +4
	Sharpness: -4 to +4

4 Use the four-way controller (◀▶) to change the setting.

The background image changes according to the settings.

You can visually check the saturation and hue with the radar chart.

Available operations

Front e-dial (☀)	Switches between enabling and disabling contrast settings.
Rear e-dial (☀)	Switches between [Sharpness], [Fine Sharpness] and [Extra Sharpness]. When set to [Fine Sharpness] or [Extra Sharpness], image outlines can be captured with more detail.
⊙ button	Resets the set value.
Main switch (↻)	Uses Digital Preview to preview the background image with the setting applied. (Not available during Live View.)
AE-L button	Saves the background image. (Not available during Live View.)

5 Press the OK button.

The camera is ready to take a picture.

Setting Cross Processing

Cross processing is the procedure of deliberately processing a film in the wrong type of chemicals to create an image with different colors and contrast. This camera features digital cross processing, which is done internally.



- When Cross Processing is set, the file format is fixed to [JPEG] and cannot be changed. You cannot use Cross Processing when the file format is set to [RAW] or [RAW+].
- When Cross Processing is set, the following functions and operation are not available.
 - Multi-exposure
 - Extended Bracketing or HDR Capture (The function selected last is used.)
 - Changing the settings of White Balance and Custom Image

1 Select [Cross Processing] in the [Rec. Mode 2] menu and press the four-way controller (▶).

When the exposure mode is set to (Movie), select from [Movie] in the [Rec. Mode 4] menu. (p.152)

The [Cross Processing] screen appears.

2 Press the four-way controller (▶) and use the four-way controller (▲▼) to select an item and press the OK button.

Select from [Off], [Random], [Preset 1-3] and [Favorite 1-3].

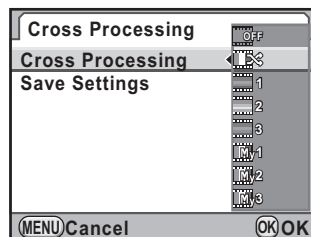

3 Press the MENU button twice.

The camera is ready to take a picture.

Saving the Cross Processing Setting of a Captured Image

The outcome of cross processing varies each time a picture is taken. If you are able to take a cross processed image that you like, you can save the Cross Processing settings used in that image. A total of 3 Cross Processing settings can be saved for still pictures and movies.



To save Cross Processing setting for movies, set from [Movie] in the [📷 Rec. Mode 4] menu with the mode dial set to 🎬 (Movie).

1 Select [Save Settings] in Step 2 on p.200 and press the four-way controller (▶).

The camera will search for cross processed images starting from the most recent image taken. (An hourglass icon is displayed while searching.) When a cross processed image is found, the screen to save the settings appears.

If there are no cross processed images, the message [No cross processed image] appears.

2 Turn the front e-dial (☀️) to select a cross processed image.

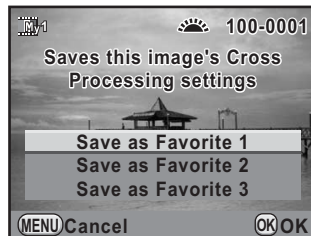



3 Use the four-way controller (▲▼) to select a number and press the OK button.

The setting of the selected image is saved to [Favorite 1 - 3].



4 Press the MENU button twice to finish saving.

You can save the current camera settings in the **USER** mode and easily retrieve them.

The following settings can be stored.

- Exposure Mode (other than  and )
- Drive Mode
- Flash Mode/Flash Exposure Compensation
- White Balance
- Sensitivity/ISO AUTO Setting
- EV compensation value
- Program Line
- Extended Bracketing
- JPEG Recorded Pixels
- JPEG Quality
- File Format
- RAW File Format
- AF Settings
- High-ISO NR
- Slow Shutter Speed NR
- D-Range Setting
- HDR Capture
- Custom Image
- Cross Processing
- Digital Filter
- Shake Reduction/
Horizon Correction
- Lens Correction
- Color Space
- E-Dial Programming/
Button Customization
- [**C** Custom Setting 1-4]
menu settings



The **USER** mode cannot be set when the mode dial is set to  (Green) or  (Movie) mode.

Saving the Settings

Saves the settings as **USER** mode. Up to five different settings can be saved.

- 1 **Make the necessary settings.**
- 2 **Select [Save USER Mode] in the [ Rec. Mode 5] menu and press the four-way controller (▶).**

The [Save USER Mode] screen appears.

- 3** Press the four-way controller (▶).

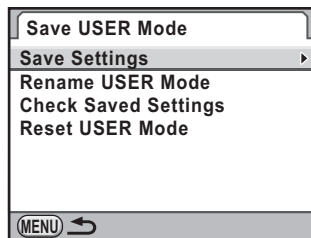

- 4** Use the four-way controller (▲▼) to select [USER 1] to [USER 5] and press the four-way controller (▶).

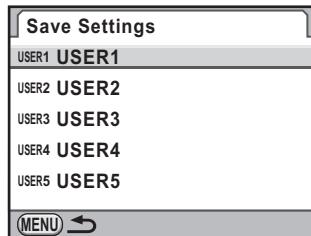

- 5** Press the four-way controller (▲) to select [Save] and press the OK button.

The settings are saved and the screen that was displayed in Step 3 appears again.

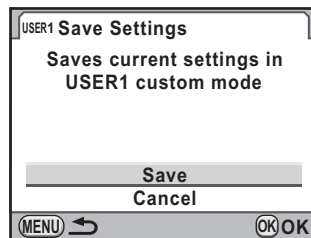

Editing a Setting Name

You can change the name of the **USER** mode in which you saved settings.

- 1** Select [Rename USER Mode] in Step 3 of “Saving the Settings” and press the four-way controller (▶).

The [Rename USER Mode] screen appears.

- 2** Use the four-way controller (▲▼) to select [USER 1] to [USER 5] and press the four-way controller (▶).

The text-entry screen appears.

3

Enter the text.

Up to 18 single-byte alphanumeric characters and symbols can be entered.

Text selection cursor

Text input cursor

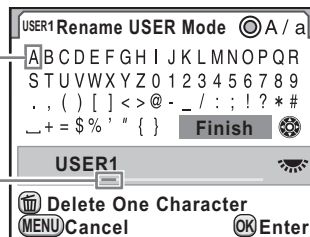
**Available operations**

Four-way controller (▲▼◀▶)	Moves the text selection cursor.
Rear e-dial (☀)	Moves the text input cursor.
⊙ button	Switches between upper and lower case letters.
OK button	Enters a character selected with the text selection cursor at the position of the text input cursor.
🗑 button	Deletes a character at the position of the text input cursor.

6

4

After entering the text, move the text selection cursor to [Finish] and press the OK button.

The name is changed.

Repeat Steps 2 to 4 to change the names of other USER modes.

5

Press the MENU button.

The camera returns to the [Save USER Mode] screen.

Checking the Saved USER Settings

1

Select [Check Saved Settings] in Step 3 of p.203 and press the four-way controller (▶).

The [Check Saved Settings] screen appears.

2 Use the four-way controller (▲▼) to select [USER1] to [USER5] and press the four-way controller (▶).

The current settings saved in the selected **USER** mode are displayed.

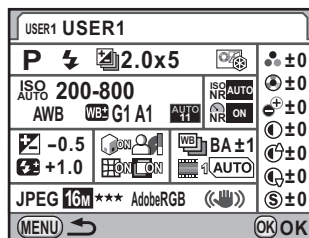

3 Press the OK button.

The camera returns to the [Save USER Mode] screen.

Using Saved USER Settings

You can easily retrieve saved settings.

1 Set the mode dial to **USER**.

The **USER** mode guide appears.

2 Use the four-way controller (◀▶) or the rear e-dial (☀) to select [USER1] to [USER5].

Use the four-way controller (▲▼) to check the saved settings.

The saved settings are retrieved.

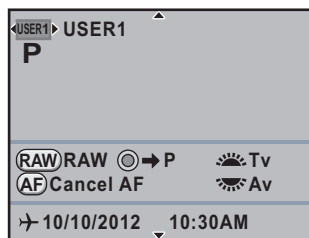

3 Change the settings as necessary.

The exposure mode can be changed in [Exposure Mode] of the [Rec. Mode 1] menu.

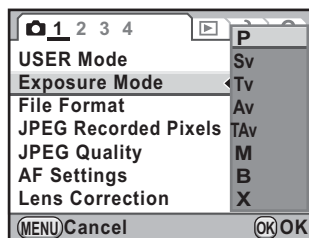



- The **USER** mode guide appears for 30 seconds regardless of the [Guide Display] setting in the [Set-up 1] menu.
- [USER 1] to [USER 5] can also be selected from [USER Mode] in the [Rec. Mode 1] menu.
- [USER Mode] and [Exposure Mode] are displayed in the [Rec. Mode 1] menu only when the mode dial is set to **USER**.
- The settings changed in Step 3 are not saved as **USER** mode settings. When the camera is turned off, settings return to the original saved settings.

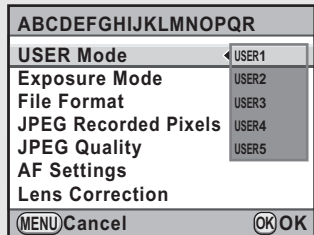

Resetting to Default Settings

Resets the settings saved in **USER1** to **USER5** to the default settings.

1

Select [Reset USER Mode] in Step 3 of p.203 and press the four-way controller (▶).

The [Reset USER Mode] screen appears.

2

Use the four-way controller (▲ ▼) to select [USER1] to [USER5] and press the four-way controller (▶).

3

Press the four-way controller (▲) to select [Reset] and press the **OK** button.

The **USER** mode settings return to the default values.

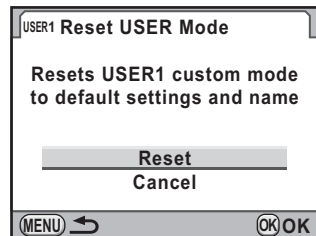

7 Playback Functions

This chapter describes how to use the various playback functions in Playback mode.

Playback Functions Operation	208
Setting the Playback Display Method	210
Enlarging Images	211
Displaying Multiple Images	212
Rotating Images	219
Deleting Multiple Images	220
Connecting the Camera to an AV Device	224

Make settings related to playing back images in the playback mode palette or [▶ Playback] menu.



Refer to “Using the Menus” (p.42) for details on how to use the menus.



Playback Mode Palette Setting Items

Press the four-way controller (▼) in Playback mode to display the playback mode palette.

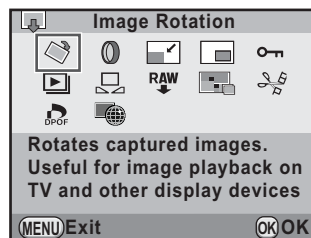
You can display the playback mode palette even when a movie is paused.



Item	Function	Page
Image Rotation *1	Rotates images.	p.219
Digital Filter *1	Changes the color tone of images, or adds softening and slimming effects.	p.233
Resize *1 *2	Changes the number of recorded pixels and quality level of the captured image and saves it as a new file.	p.230
Cropping *1	Cuts out only the desired area of the picture and saves it as a new image.	p.231
Protect	Protects images from being accidentally erased.	p.222
Slideshow	Plays back the images one after another.	p.218
Save as Manual WB *1	You can copy the white balance settings of a captured image and save it as Manual White Balance.	p.187
RAW Development *3	Converts RAW images to JPEG or TIFF format.	p.238
Index *1	Joins a number of images together and creates a new image with them.	p.215

Item	Function	Page
 Movie Editing *4	Divides a movie and deletes unwanted segments.	p.159
 DPOF *1 *2	Sets the number of prints and whether to print the date on images saved on the SD Memory Card.	p.271
 Save Destination *5	Saves the GPS location information stored in the image as the destination for Simple Navigation.	p.306

*1 This cannot be performed when a movie is displayed.

*2 This cannot be performed when a RAW image is displayed.

*3 This can be performed only when RAW images are saved.

*4 This can be performed only when a movie is displayed.

*5 This can be performed only when an image with the GPS location information is saved.

Playback Menu Setting Items

You can perform the following settings in the [ Playback] menu.

Press the **MENU** button in Playback mode to display the [ Playback 1] menu.

Menu	Item	Function	Page
	Slideshow	Plays back the images one after another. You can set how images will be displayed in the slideshow.	p.217
	Quick Zoom	Sets the initial magnification when enlarging images.	p.210
	Bright/Dark Area	Sets whether or not to display the Bright/Dark Area warning during playback.	
	Auto Image Rotation	Sets whether to rotate images shot with the camera held vertically when playing back.	
	Delete All Images	You can delete all saved images at once.	p.222

Setting the Playback Display Method

You can set the initial magnification when enlarging images, whether to display the Bright/Dark Area warning, and whether to automatically rotate images that are shot with the camera held vertically in Playback mode.

1 Select [Quick Zoom] in the [1] Playback 1] menu and press the four-way controller (▶).

2 Use the four-way controller (▲▼) to select the magnification and press the OK button.

Select from [Off] (default setting), [×2], [×4], [×8], [×16] or [×32].

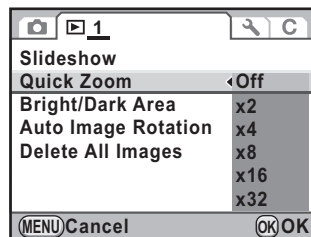

3 Use the four-way controller (▲▼) to select [Bright/Dark Area] and use the four-way controller (◀▶) to select or .

4 Use the four-way controller (▲▼) to select [Auto Image Rotation] and use the four-way controller (◀▶) to select or .

<input checked="" type="checkbox"/>	During playback, the image is automatically rotated based on the rotation information when [23. Saving Rotation Info] in the [Custom Setting 3] menu is set to [On] or image rotation information is saved in [Image Rotation] (p.219). (default setting)
<input type="checkbox"/>	The image is not automatically rotated during playback.

5 Press the MENU button.

The screen that was displayed before selecting the menu appears again.



The Bright/Dark Area warning is not displayed in Detailed information display and RGB histogram display.

Images can be magnified up to 32 times in Playback mode.

1 Use the four-way controller (◀▶) to select an image in Playback mode.

2 Turn the rear e-dial (☀) to the right (toward Q).

The image enlarges at each click (1.2 times to 32 times).



Available operations

Rear e-dial (☀) to the right (Q) / [Q] button	Enlarges the image (up to 32 times).
Rear e-dial (☀) to the left (Q) / [Q] button	Reduces the image (up to 1.2 times).
Four-way controller (▲▼◀▶)	Changes the area to display.
OK button	Returns to the original size.
Front e-dial (☀)	Retains the magnification and the position of the magnified area and shows the previous/next image.
INFO button	Switches information display on/off.



- The default setting for the first click (minimum magnification) is 1.2 times. You can change this in [Quick Zoom] of the [▶ Playback 1] menu. (p.210)
- The initial full display of vertical images is displayed with a magnification of 0.675 times that of horizontal images, therefore, magnification at the first click starts at 1.0 times.

Multi-image Display Screen

You can display 4, 9, 16, 36 or 81 thumbnail images on the monitor at the same time. The default setting is nine-image display.

1 Turn the rear e-dial () to the left (toward) in Playback mode.

The multi-image display screen appears.

Up to nine thumbnail images are displayed at once.

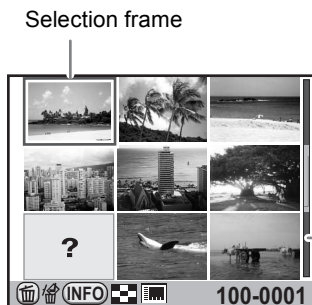

Scroll bar

Available operations

Four-way controller () Moves the selection frame.

INFO button Displays the [Multi-Img Display Setting] screen. Use the four-way controller () to select the number of images to display at the same time.

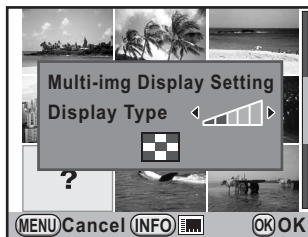

(Display Type cannot be selected when developing multiple RAW images (p.240).)

 button Selects multiple images and deletes them. (p.220)

2 Press the OK button.

A full screen display of the selected image appears.



Icons such as and are not displayed with thumbnail images for 81-image display.

Displaying Images by Folder

Images will be grouped and displayed by folder in which they are saved.

1 In the multi-image display screen, turn the rear e-dial () to the left (toward) again.

The folder display screen appears.

2 Select the folder you want to display.

The number of images saved in the selected folder appears at the top right of the screen.

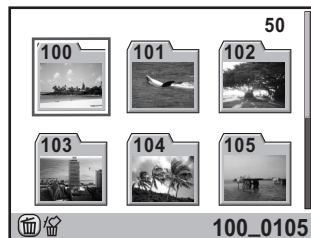

Available operations

Four-way controller Moves the selection frame.
()

button Deletes the selected folder and all the images in it. (p.221)

3 Press the OK button.

The multi-image display screen for the selected folder appears.

Displaying Images by the Shooting Date (Calendar Display)

Images will be grouped and displayed by the shooting date.

1 In the multi-image display screen, press the INFO button.

The [Multi-Img Display Setting] screen appears.

2 Press the INFO button again.

The calendar display screen appears.

Only the dates when pictures were taken are displayed.

Number of images shot on this date

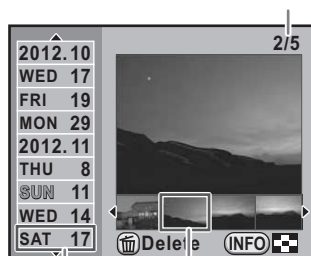

Shooting
date

Thumbnail

Available operations

Four-way controller (▲▼)	Selects a shooting date.
Four-way controller (◀▶)	Selects an image taken on the selected shooting date.
Rear e-dial (☀) to the right (Q)	Displays the selected image. Turn to the left (☀) to return to the calendar display.
INFO button	The camera returns to the multi-image display screen.
🗑 button	Deletes selected images.

3 Press the OK button.

A full screen display of the selected image appears.

Joining Multiple Images (Index)

Join a number of images together and display them as an index print. You can select the images to include in the index print or have them randomly arranged.









This function is not available for movies.

- 1 Press the four-way controller (▼) in Playback mode.**
The playback mode palette appears.
- 2 Use the four-way controller (▲▼◀▶) to select  (Index) and press the OK button.**
The [Index] screen appears.

- 3 Press the four-way controller (▶).**

- 4 Use the four-way controller (▲▼) to select a layout and press the OK button.**

You can select  (Thumbnail),  (Square),  (Random1),  (Random2),  (Random3) or  (Bubble).

Images are displayed according to the file number (from the smallest number) for , and are displayed in random order for other layouts.

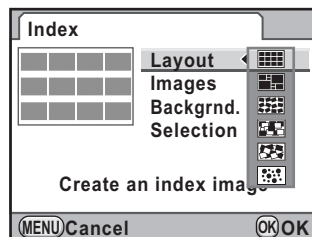



- 5 Use the four-way controller (▲▼) to select [Images] and press the four-way controller (▶).**

- 6 Use the four-way controller (▲▼) to select the number of images and press the OK button.**

You can select 12, 24 or 36 images.

When the number of saved images is smaller than the number selected, empty spaces will appear when [Layout] is set to  (Thumbnail) and some images may be duplicated for other layouts.



- 7** Use the four-way controller (▲▼) to select [Backgrnd.] and press the four-way controller (▶).
- 8** Use the four-way controller (▲▼) to select the background color and press the OK button.
You can select a white or black background.
- 9** Use the four-way controller (▲▼) to select [Selection] and press the four-way controller (▶).
- 10** Use the four-way controller (▲▼) to select a type of image selection and press the OK button.

 Auto	Picks images automatically from all of the images saved.
 Manual	Individually select images you want to include in the index. Continue by selecting [Select image(s)] and select the individual images.
 Folder name	Picks images automatically from the folder selected. Continue by selecting [Select a folder] and select the folder.

- 11** Use the four-way controller (▲▼) to select [Create an index image] and press the OK button.

The index image is created and a confirmation screen appears.

- 12** Use the four-way controller (▲▼) to select [Save] or [Reshuffle] and press the OK button.

Save	The index image is saved as a  and ★★★ file.
Reshuffle	Reselects the images to be included in the index and displays a new index image. However, if  (Thumbnail) is selected for [Layout], this item is not displayed.

After the index image is saved, the camera returns to Playback mode and the index image is displayed.



Processing may take a while when creating an index image.

Playing Back Images Continuously

You can play back all images saved on your SD Memory Card successively in the slideshow.

Setting the Slideshow Display

Sets how images will be displayed during the Slideshow.

- 1** Select [Slideshow] in the [▶ Playback 1] menu and press the four-way controller (▶).

The screen to make the slideshow settings appears.

- 2** Use the four-way controller (▲▼) to select an item you want to change.

The following items can be changed.

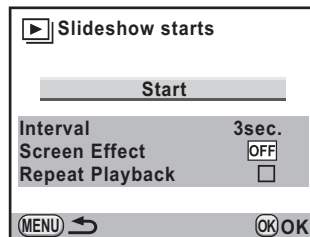

Item	Description	Setting
Interval	Select an image display interval.	3sec. (default setting)/5sec./10sec./30sec.
Screen Effect	Select a transition effect when the next image is displayed.	Off (default setting)/Fade/Wipe/Stripe
Repeat Playback	Set whether to start the slideshow again from the beginning after the last image is displayed.	<input type="checkbox"/> (default setting)/ <input checked="" type="checkbox"/>

- 3** Press the four-way controller (▶) and use the four-way controller (▲▼) to change the setting and press the OK button.

Starting the Slideshow

- 1 Select [Start] in Step 2 on p.217 and press the **OK** button. Or, select  (Slideshow) in the playback mode palette and press the **OK** button.

The start screen is displayed and the slideshow begins.

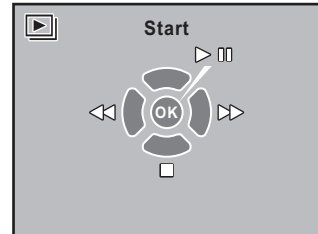

Available operations

OK button	Pauses playback. Press again to resume playback.
Four-way controller (◀)	Shows the previous image.
Four-way controller (▶)	Shows the next image.

- 2 Press the four-way controller (▼).

Slideshow stops and the single image display reappears.

After slideshow ends, the camera returns to the single image display even if you do not press the four-way controller (▼).



For movies, only the first frame is displayed and then the next image is displayed after the set interval has elapsed. To play back a movie during a slideshow, press the **OK** button while the first frame is displayed. When the movie playback is finished, the slideshow will resume.

When pictures are taken with this camera held vertically, the vertical position sensor activates and rotation information is added to the image to enable playback with the correct image orientation. You can change the rotation information and save the image using the following procedure.



- When [23. Saving Rotation Info] in the [C Custom Setting 4] menu is set to [Off], the image rotation information is not saved when shooting.
- When [Auto Image Rotation] (p.210) in the [▶ Playback 1] menu is set to (On), an image with rotation information is automatically rotated during playback.



- You cannot change the image rotation information in the following conditions.
 - when the image is protected
 - when the image rotation information tag is not saved with the image
 - when [Auto Image Rotation] (p.210) in the [▶ Playback 1] menu is set to (Off)
- Movie files cannot be rotated.

1 Select the image you want to rotate in Playback mode.

2 Press the four-way controller (▼).

The playback mode palette appears.

3 Use the four-way controller (▲▼◀▶) to select  (Image Rotation) and press the OK button.

The selected image is rotated in 90° increments and the four thumbnail images are displayed.

4 Use the four-way controller (▲▼◀▶) to select a desired rotation direction and press the OK button.

The image rotation information is saved.

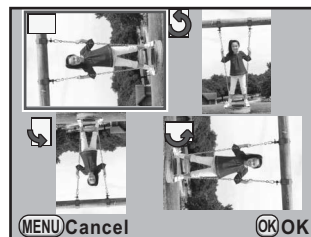

Deleting Multiple Images

You can delete multiple images at once. Be aware that deleted images cannot be restored.

☞ Protecting Images from Deletion (Protect) (p.222)

Deleting Selected Images

You can delete multiple images in the multi-image display at once.



- Protected images cannot be deleted.
- You can select up to 100 images at a time.

1 Turn the rear e-dial (🔍) to the left (toward ☒) in Playback mode.

The multi-image display screen appears.

2 Press the 🗑️ button.

The screen to select the images to delete is displayed.

The screen temporarily changes to 36-image display when [Multi-Image Display Setting] (p.212) is set to 81-image display.

3 Select the images to delete.



Available operations

Four-way controller (▲▼◀▶) Moves the selection frame.

OK button Adds ☑ and selects an image. Press again to return to ☐. Protected images (🔒) cannot be selected.

Rear e-dial (🔍) Displays a full screen display of the image selected with the selection frame. When the image is displayed full screen, press the four-way controller (◀▶) to display the previous or next image.

4 Press the button.

The delete confirmation screen appears.

5 Press the four-way controller () to select [Select & Delete] and press the **OK** button.

The selected images are deleted.

Deleting a Folder

You can delete a selected folder and all the images in it.

1 Turn the rear e-dial () two clicks to the left (toward) in Playback mode.

The folder display screen appears.

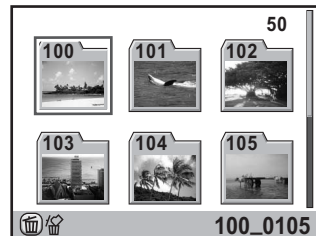

2 Use the four-way controller (, , ,) to select a folder to delete and press the button.

The delete folder confirmation screen appears.



3 Press the four-way controller () to select [Delete] and press the **OK** button.

The selected folder and all images in it are deleted.

The confirmation screen appears when there are protected images. Use the four-way controller (, ) to select [Delete All] or [Leave All] and press the **OK** button.

When [Delete All] is selected, protected images are also deleted.

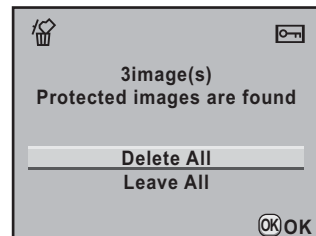

Deleting All Images

You can delete all saved images at once.

- 1 **Select [Delete All Images] in the [▶ Playback 1] menu and press the four-way controller (▶).**

The confirmation screen for deleting all images is displayed.

- 2 **Press the four-way controller (▲) to select [Delete All Images] and press the OK button.**

All images are deleted.

The confirmation screen appears when there are protected images. Use the four-way controller (▲▼) to select [Delete All] or [Leave All] and press the **OK** button.

When [Delete All] is selected, protected images are also deleted.

Protecting Images from Deletion (Protect)

You can protect images from being accidentally deleted.



Even protected images are deleted if the inserted SD Memory Card is formatted.

- 1 **Press the four-way controller (▼) in Playback mode.**

The playback mode palette appears.

- 2 **Use the four-way controller (▲▼◀▶) to select  (Protect) and press the OK button.**

The screen to select the protection setting method is displayed.

- 3 Use the four-way controller (▲▼) to select [Single Image] or [All Images] and press the OK button.**

If you selected [All Images], proceed to Step 5.



- 4 Use the four-way controller (◀▶) to select an image to protect.**

- 5 Press the four-way controller (▲) to select [Protect] and press the OK button.**

Select [Unprotect] to cancel the protection of the image.

The image is protected and the  icon appears at the top right of the screen.

Repeat Steps 4 and 5 to protect other images.

If you selected [All Images] in Step 3, the camera returns to the playback mode.



- 6 Press the MENU button.**

The camera returns to Playback mode.

Connecting the Camera to an AV Device

You can connect the camera to a TV or other device with a video input terminal or HDMI terminal and play back images.



- If you intend to use the camera continuously for a long period, use of the AC adapter kit (optional) is recommended. (p.52)
- For an AV device with multiple video input terminals, check the operating manual of the AV device, and select a suitable video input terminal for connecting the camera.
- You cannot output both composite and HDMI video signals at the same time.
- You cannot adjust the volume on the camera while the camera is connected to the AV device. Adjust the volume on the AV device.
- If you want to view a movie on an external monitor while recording it, connect the camera to an AV device with a mini HDMI terminal. You cannot output a movie using the video input terminal while recording.

Connecting the Camera to a Video Input Terminal

Use the provided AV cable I-AVC7 to connect the camera to a device with a video input terminal.

7

Playback Functions

- 1 Turn the AV device and camera off.
- 2 Open the terminal cover, face the arrow on the AV cable toward the ▲ mark on the camera, and connect the cable to the PC/AV terminal.

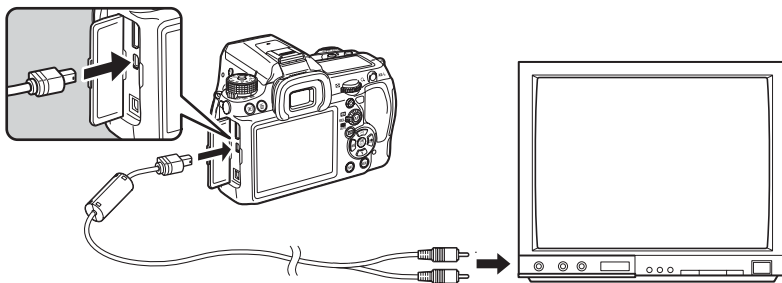

- 3 Connect the other end of the AV cable to the video input terminal on the AV device.

4 Turn the AV device and camera on.

The camera turns on in video mode, and the camera information is displayed on the screen of the connected AV device.



Even if you used an external microphone to record movie sound in stereo, monaural sound is played back.

Selecting the Video Output Format

When the hometown is set at the time of initial setting (p.60), the video output format is set in accordance with that region. Depending on the country or region, images may fail to be played back with the set video output format. If this happens, change the video output format setting.

1 Select [Video Out] in the [Set-up 2] menu and press the four-way controller (▶).

2 Use the four-way controller (▲▼) to select [NTSC] or [PAL] and press the OK button.

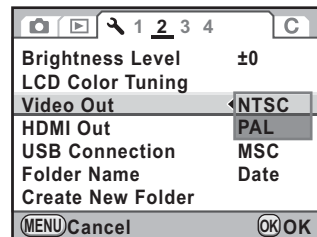

3 Press the MENU button.

The screen that was displayed before selecting the menu appears again.



The video output format differs depending on the region. When you set [Setting the Time] in the World Time setting (p.253) to → (Destination), the video output setting changes to the video output format for that city. Refer to "List of World Time Cities" (p.255) for cities that can be selected as a hometown or destination.

Connecting the Camera to an HDMI Terminal

Use a commercially available HDMI cable to connect the camera to a device with an HDMI terminal.

- 1 Turn the AV device and camera off.
- 2 Open the terminal cover and connect the HDMI cable to the mini HDMI terminal.

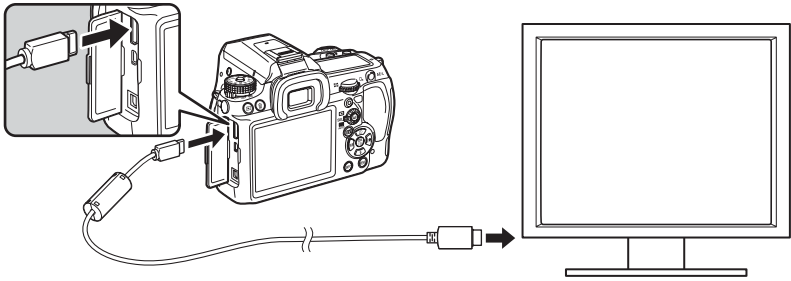

- 3 Connect the other end of the HDMI cable to the HDMI input terminal on the AV device.
- 4 Turn the AV device and camera on.

The camera turns on in HDMI mode, and the camera information is displayed on the screen of the connected AV device.



- The camera has a mini HDMI terminal (Type C). Use a commercially available HDMI cable that matches your AV device.
- Nothing is displayed on the camera monitor during HDMI output.
- If you used an external microphone to record movie sound in stereo, the sound is played back in stereo.

Selecting the HDMI Output Format

By default, the maximum resolution is automatically selected to suit the AV device and camera. However, if it fails to play back images properly, change the HDMI output format setting.

1 Select [HDMI Out] in the [Set-up 2] menu and press the four-way controller ().

2 Use the four-way controller () to select the HDMI output format.

Auto	The maximum resolution that the AV device and camera support is automatically selected. (default setting)
1080i	1920×1080i
720p	1280×720p
480p *1	720×480p

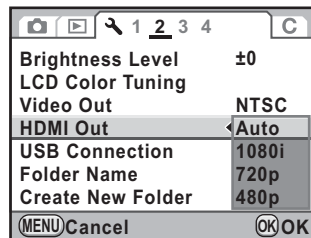

*1 This depends on the selected video output format; [480p] for NTSC and [576p] (720×576p) for PAL.

3 Press the **OK** button.

4 Press the **MENU** button.

The screen that was displayed before selecting the menu appears again.



- When the HDMI output format is set to [1080i] or [720p], the display of the AV device may appear with a screen design that differs from that displayed on the camera.
- The Bright/Dark Area warning is not displayed during Live View.
- When the exposure mode is set to (Movie), the output format is fixed to [480p] regardless of the HDMI output format setting.

Memo

8 Processing Images

This chapter describes how to process pictures taken and edit RAW images.

Changing the Image Size	230
Processing Images with Digital Filters	233
Developing RAW Images	238

Changing the Image Size

Changes the number of recorded pixels and quality level of the image, and saves the image as a new file.

Changing the Number of Recorded Pixels and Quality Level (Resize)

Changes the number of recorded pixels and quality level of the selected image and saves it as a new image.



- Only JPEG images captured with this camera can be resized.
- Images already resized to **0.2M** or **0.3M** with this camera cannot be resized.

1 Select an image to resize in Playback mode.

2 Press the four-way controller (▼).

The playback mode palette appears.

3 Use the four-way controller (▲▼◀▶) to select (Resize) and press the OK button.

The screen to select the recorded pixels and quality level appears.

4 Use the four-way controller (◀▶) to select the desired image size.

You can select one of the image sizes starting from one size smaller than that of the original image. The selectable sizes vary according to the original image size.



5 Press the four-way controller (▼) and use the four-way controller (◀▶) to select the quality level.

You can select **☆☆☆☆**, **☆☆☆**, **☆☆** or **☆**.

6 Press the OK button.

The save confirmation screen appears.

7 Use the four-way controller (▲▼) to select [Save as] and press the OK button.

The resized image is saved as a new image.

Cutting Out Part of the Image (Cropping)

Cuts out only the desired area of the selected image and saves it as a new image. The aspect ratio can also be changed.



- Only JPEG and RAW images captured with this camera can be cropped.
- Images already resized to 0.2M or 0.3M with this camera cannot be cropped.

1 Select an image to crop in Playback mode.

2 Press the four-way controller (▼).

The playback mode palette appears.

3 Use the four-way controller (▲▼◀▶) to select (Cropping) and press the OK button.

The cropping frame to specify the size and position of the area to crop appears on the screen.

4 Specify the size and position of the area to crop by using the cropping frame.



Available operations

Rear e-dial (☺☺)	Changes the size of the cropping frame.
Four-way controller (▲▼◀▶)	Moves the cropping frame.
INFO button	Changes the aspect ratio. Select from [3:2], [4:3], [16:9] or [1:1]. The image can also be rotated from -45° to +45° in increments of 1°.

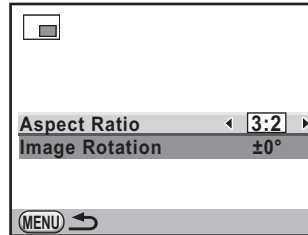

- | | |
|----------|---|
| ⊙ button | Rotates the cropping frame in 90° increments.
⊙ appears only when the cropping frame can be rotated. |
|----------|---|

5 Press the **OK** button.

The save confirmation screen appears.

6 Use the four-way controller (▲▼) to select [**Save as**] and press the **OK** button.

The cropped image is saved as a new image.

You can edit captured images using digital filters. The following filters are available.

Filter Name	Effect	Parameter
Toy Camera	Creates an image that looks as though it was shot with a toy camera.	Shading Level: Low/Medium/High
		Blur: Low/Medium/High
		Tone Break: Red/Green/Blue/Yellow
Retro	Creates an image with the look of an old photo.	Toning (B-A): 7 levels
		Frame Composite: None/Thin/Medium/Thick
High Contrast	Enhances the contrast in the image.	+1 to +5
Sketch Filter	Creates an image that looks as though it was drawn with a pencil.	Contrast: Low/Medium/High
		Scratch Effect: OFF/ON
Water Color	Creates an image that looks as though it was painted.	Intensity: Low/Medium/High
		Saturation: OFF/Low/Medium/High
Pastel	Creates an image that looks as though it was drawn with a crayon.	Low/Medium/High
Posterization	Lessens the tone of the image to create an image that looks as though it was hand-drawn.	+1 to +5
Miniature	Blurs part of the image to create a fake miniature scene.	In-Focus Plane: -3 to +3
		In-Focus Width: Narrow/Middle/Wide
		In-Focus Plane Angle: Horizon/Vertical/Positive Slope/Negative Slope
		Blur: Low/Medium/High
Base Parameter Adj	Adjusts the parameters to create the desired image.	Brightness: -8 to +8
		Saturation: -3 to +3
		Hue: -3 to +3
		Contrast: -3 to +3
		Sharpness: -3 to +3
Monochrome	Creates a monochrome image such as a black-and-white photo.	Filter Effect: OFF/Red/Green/Blue/Infrared Filter
		Toning (B-A): 7 levels

Filter Name	Effect	Parameter
Color	Adds a color filter to the image.	Color: Red/Magenta/Blue/Cyan/ Green/Yellow
		Color Density: Light/Standard/Dark
Extract Color	Extracts one or two specific colors and makes the rest of the image black and white.	Extracted Color 1: Red/Magenta/ Blue/Cyan/Green/Yellow
		Extractable Range of Color 1: +1 to +5
		Extracted Color 2: OFF/Red/ Magenta/Blue/Cyan/Green/Yellow
		Extractable Range of Color 2: +1 to +5
Soft	Creates an image with a soft focus throughout the image.	Soft Focus: Low/Medium/High
		Shadow Blur: OFF/ON
Starburst	For taking pictures of night scenes or lights reflected on water with a special sparkling look by adding extra glitter to the highlights.	Shape: Cross/Star/Snow Crystal/ Heart/Musical Note
		Effect Density: Small/Medium/Large
		Size: Small/Medium/Large
		Angle: 0°/30°/45°/60°
Fish-eye	Creates an image that looks as though it was shot with a fish-eye lens.	Low/Medium/High
Slim	Changes the horizontal and vertical ratio of images.	-8 to +8
HDR	Creates an image that looks like a high dynamic range image.	Low/Medium/High
Custom Filter	Customize and save a filter to your own preferences.	High Contrast: OFF/+1 to +5
		Soft Focus: OFF/+1 to +3
		Tone Break: OFF/Red/Green/Blue/ Yellow
		Shading Type: 6 types
		Shading Level: -3 to +3
		Distortion Type: 3 types
		Distortion Level: OFF/Low/Medium/ High
Invert Color: OFF/ON		



Only JPEG and RAW images captured with this camera can be edited using the Digital Filter.

Applying the Digital Filter

- 1 Select an image for applying the digital filter in Playback mode.
- 2 Press the four-way controller (▼).
The playback mode palette appears.
- 3 Use the four-way controller (▲▼◀▶) to select **0** (Digital Filter) and press the OK button.

The screen to select a filter appears.

- 4 Use the four-way controller (▲▼◀▶) to select a filter and press the OK button.

After selecting a filter, you can check the effect on the screen.

You can turn the front e-dial (☀️) to select a different image.



- 5 Use the four-way controller (▲▼) to select a parameter and the four-way controller (◀▶) to adjust the value.

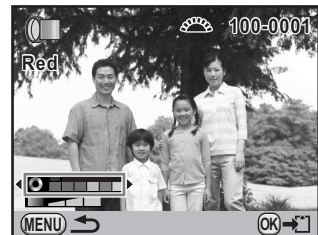

- 6 Press the OK button.

The save confirmation screen appears.

7 Use the four-way controller (▲▼) to select [Use filters in combination] or [Save as].

Select [Use filters in combination] when you want to apply additional filters to the same image.



8 Press the OK button.

If [Use filters in combination] was selected, the screen that was displayed in Step 4 appears again.

If [Save as] was selected, the filter-processed image is saved as a new image.



Up to 20 filters, including a digital filter used during shooting (p.143), can be combined to the same image.

Recreating Filter Effects

Retrieves the setting of an image with filter effects and applies the same filter effects to other images.

1 Select a filter-processed image in Playback mode.

2 Select (Digital Filter) in the playback mode palette and press the OK button.

3 Use the four-way controller (▲▼) to select [Recreating filter effects] and press the OK button.

The history of the filter usage for the selected image appears.



4 To check the parameter details, press the **INFO** button.

You can check the filter parameters.

Press the **INFO** button again to return to the previous screen.

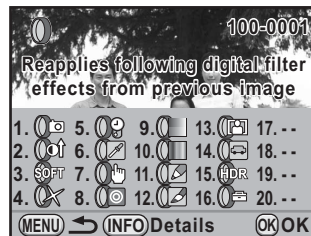

5 Press the **OK** button.

The image selection screen appears.

6 Use the four-way controller (◀▶) to select an image for applying the same filter effects and press the **OK** button.

You can only select an image that has not been processed with a filter.

The save confirmation screen appears.



7 Use the four-way controller (▲▼) to select [Save as] and press the **OK** button.

The filter-processed image is saved as a new image.



If [Searching for the original image] is selected in Step 3, the original image prior to digital filter application can be retrieved. If the original image is no longer stored on the SD Memory Card, the message [Original image, prior to digital filter application, is not found] appears.

You can convert captured RAW images into JPEG or TIFF images.



Only RAW images captured with this camera can be edited. RAW images and JPEG images captured with other cameras cannot be edited on this camera.

Developing One RAW Image

- 1 Press the four-way controller (▼) in Playback mode.**

The playback mode palette appears.

- 2 Use the four-way controller (▲▼◀▶) to select ^{RAW} (RAW Development) and press the OK button.**

The screen to select a development method is displayed.

- 3 Use the four-way controller (▲▼) to select [Developing a Single Image] and press the OK button.**

The parameters recorded in the image file appear.

Proceed to Step 6 if you do not need to change the parameters.

If there are no images that can be processed, [No image can be processed] appears.



4 Use the four-way controller (▲▼) to choose a parameter you want to change.

You can turn the front e-dial (☀️) to select a different image.

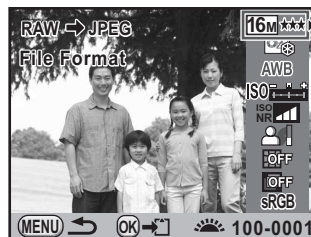

The following parameters can be changed.

Parameter	Value	Page
File Format	JPEG/TIFF	-
Recorded Pixels *1	16M (4928×3264)/ 10M (3936×2624)/ 6M (3072×2048)/ 2M (1728×1152)	p.178
Quality Level *1	★★★★ (Premium) / ★★★ (Best) / ★★ (Better) / ★ (Good)	p.179
Custom Image	Bright/Natural/Portrait/Landscape/Vibrant/Muted/Bleach Bypass/Reversal Film/Monochrome	p.197
White Balance *2	AWB (Auto)/☀️ (Daylight)/☁️ (Shade)/☁️ (Cloudy)/☀️ D (Fluorescent Light Daylight Color)/☀️ N (Fluorescent Light Daylight White)/☀️ W (Fluorescent Light Cool White)/☀️ L (Fluorescent Light Warm White)/☀️ (Tungsten Light)/⚡ WB (Flash)/ CTE /☒ (Manual)/ K (Color Temperature)	p.183
Sensitivity	-2.0 to +2.0	-
High-ISO NR	Auto/Off/Low/Medium/High	p.85
Shadow Correction	Off/Low/Medium/High	p.190
Distortion Correction *3	Off/On	p.193
Lat-Chromatic-Ab Adj *3	Off/On	p.193
Color Space	sRGB/AdobeRGB	p.189

*1 This cannot be set when [File Format] is set to [TIFF]. (The setting is fixed to **16M**.)

*2 This cannot be set for RAW images taken in Multi-exposure mode.

*3 This can be selected only when a compatible lens is attached. (p.297)

5 Use the four-way controller (◀▶) to change the value.

For File Format, Recorded Pixels, and Quality Level, press the four-way controller (▶) and use the four-way controller (▲▼) to select an item.

For Custom Image and White Balance, press the four-way controller (▶) to display the setting screen.

6 Press the OK button.

The save confirmation screen appears.

7 Use the four-way controller (▲▼) to select [Save as] and press the OK button.

The RAW image is developed and saved as a new image.

8 Use the four-way controller (▲▼) to select [Continue] or [Exit].

Select [Continue] to edit other images.

9 Press the OK button.

If you select [Continue] in Step 8, the screen for selecting the parameters in Step 4 appears again.

Developing Multiple RAW Images

You can develop multiple RAW images with the same settings.

1 Select [Developing Multiple Images] in Step 3 on p.238 and press the OK button.

The multi-image display screen appears.

Refer to p.212 for details on operations during the multi-image display.

2 Use the four-way controller (▲▼◀▶) to select the RAW images to be developed and press the OK button.

3 Press the AE-L button.

The development confirmation screen appears.

4 Use the four-way controller (▲▼) to select [Develop images as shot] or [Develop images with modified settings].

To change parameters, select [Develop images with modified settings].



5 Use the four-way controller (▲▼◀▶) to set [File Format], [Recorded Pixels] and [Quality Level].

If [TIFF] is selected, the [Recorded Pixels] and [Quality Level] settings are not available.

When [Develop images with modified settings] is selected, refer to p.239 to change other parameters. All images are developed with the same settings.

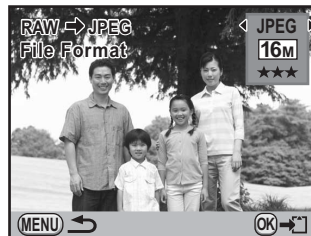

6 Press the OK button.

The save confirmation screen appears.

7 Use the four-way controller (▲▼) to select [Save as] and press the OK button.

The selected RAW images are developed and saved as new images.

Memo

9 Changing Additional Settings

This chapter describes how to change additional settings.

How to Operate the Set-up Menu	244
Formatting the SD Memory Card	246
Customizing Buttons and Dials	247
Setting the Beep, Date and Time, and Display Language	252
Adjusting the Monitor and the Menu Display	257
Setting the Folder/File Number	263
Selecting the Power Settings	266
Setting the Photographer Information	269
Setting the DPOF Settings	271
Correcting Defective Pixels in the CMOS Sensor (Pixel Mapping)	273
Selecting Settings to Save in the Camera (Memory)	274

How to Operate the Set-up Menu

Perform general settings related to the camera in the [ Set-up] menu.



Refer to “Using the Menus” (p.42) for details on how to use the menus.

Set-up Menu Setting Items

Perform the following settings in the [ Set-up 1-4] menus.

Press the **MENU** button in Capture/Playback mode and use the four-way controller (◀▶) to display the [ Set-up 1-4] menus.

Menu	Item	Function	Page
 1	Language/言語	Changes the language in which menus and messages appear.	p.256
	Date Adjustment	Sets the date format and time.	p.253
	World Time	Sets the display of the local date and time of the specified city so they can be displayed on the monitor in addition to the present location when traveling overseas.	p.253
	Text Size	Sets the text size of an item selected on the respective menu screens.	p.257
	Beep	Switches the beep tone on/off.	p.252
	Guide Display	Sets whether to display indicators on the monitor.	p.257
	Status Screen	Sets the display color of the status screen and control panel.	p.258

Menu	Item	Function	Page
2	Brightness Level	Changes the brightness of the monitor.	p.260
	LCD Color Tuning	Adjusts the color of the monitor.	p.261
	Video Out	Sets the output format when connecting to an AV device with a video input terminal.	p.225
	HDMI Out	Sets the HDMI output format when connecting to an AV device with an HDMI terminal.	p.227
	USB Connection	Sets the USB connection mode when connecting to a computer.	p.279
	Folder Name	Sets the naming system of the folder for storing images.	p.263
	Create New Folder	Creates a new folder on the SD Memory Card.	p.263
3	File Name	Sets the method used to assign file names for images.	p.264
	Copyright Information	Sets the photographer and copyright information embedded in Exif.	p.269
	Auto Power Off	Sets the time until the camera turns off automatically.	p.266
	Select Battery	Sets the battery to use when the optional battery grip is attached.	p.267
	Reset	Resets all settings.	p.296
4	Pixel Mapping	Maps out and corrects any defective pixels in the CMOS sensor.	p.273
	Dust Alert	Detects dust adhering to the CMOS sensor.	p.301
	Dust Removal	Cleans the CMOS sensor using ultrasonic vibrations.	p.300
	Sensor Cleaning	Locks the mirror in the up position for cleaning the CMOS sensor with a blower.	p.303
	Format	Formats an SD Memory Card.	p.246

Formatting the SD Memory Card

Use this camera to format (initialize) an SD Memory Card that is unused or has been used on other cameras or digital devices.

Formatting deletes all the data saved on the SD Memory Card.



- Do not remove the SD Memory Card while formatting. The card may be damaged and become unusable.
- Formatting deletes all data, both protected and unprotected. Be aware.

1 Select [Format] in the [Set-up 4] menu and press the four-way controller (▶).

The [Format] screen appears.

2 Press the four-way controller (▲) to select [Format].

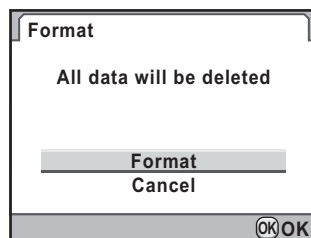

3 Press the OK button.

Formatting starts.

When formatting is completed, the screen that was displayed before selecting the menu appears again.



When an SD Memory Card is formatted, the volume label assigned to the card is "K-5 II". When this camera is connected to a computer, the SD Memory Card is recognized as a removable disk with the name "K-5 II". (p.280)

You can set the functions for when the e-dials are turned, when the **RAW/Fx** button, **AF** button or Preview dial is operated, and when the shutter release button is pressed halfway.

The current functions assigned to the buttons/dials can be checked with guide display. (p.25)

Setting the Functions for the E-dials

For each exposure mode, you can set the functions for when the front and rear e-dials and  button are operated.

- 1 Select [E-Dial Programming] in the [Rec. Mode 5] menu and press the four-way controller (▶).**

The [E-Dial Programming 1] screen appears.

- 2 Use the four-way controller (▲▼) to select an exposure mode.**

Turn the rear e-dial () to display the [E-Dial Programming 2] screen.

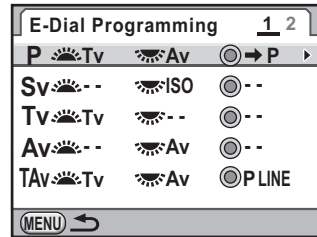









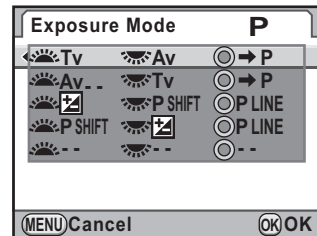



- 3 Press the four-way controller (▶).**







The screen for the selected exposure mode appears.

- 4 Press the four-way controller (▶) and use the four-way controller (▲▼) to select a function.**

You can perform the following settings for each exposure mode.



Exposure Mode	 Front E-dial	 Rear E-dial	 Button	
P	Tv	Av	➔ P	
	Av	Tv	➔ P	
		P SHIFT	P LINE	
	P SHIFT		P LINE	
	–	–	–	
Sv	–	ISO	–	
	ISO	–	–	
	P SHIFT	ISO	P LINE	
	ISO	P SHIFT	P LINE	
		ISO	–	
	ISO		–	
Tv	Tv	–	–	
	–	Tv	–	
	Tv		–	
		Tv	–	
	Tv	ISO	ISO AUTO	
	ISO	Tv	ISO AUTO	
Av	–	Av	–	
	Av	–	–	
		Av	–	
	Av		–	
	ISO	Av	ISO AUTO	
	Av	ISO	ISO AUTO	
TA_v/M	Tv	Av	/	
	Av	Tv		
				P LINE
				Tv SHIFT
		Av SHIFT		
		–		
B	–	Av	–	
	Av	–	–	
	ISO	Av	–	
	Av	ISO	–	

Exposure Mode	 Front E-dial	 Rear E-dial	 Button
X	–	Av	/
	Av	–	
	ISO	Av	
	Av	ISO	
			–
	–	Av	/
	Av	–	
		Av	
	Av		
			–

Tv: Change shutter speed **Av**: Change aperture value **ISO**: Change sensitivity
: Adjust EV compensation value ➡ **P**: Return to **P** **P LINE**: Program line
P SHIFT: Program shift –: Not available

5 Press the **OK** button.

6 Press the **MENU** button.

The screen that was displayed in Step 2 appears again.

Repeat Steps 2 to 6 to change the settings of other exposure modes.

7 Press the **MENU** button twice.

The camera is ready to take a picture.

Setting the Functions for the Buttons

You can set the functions for when the **RAW/Fx** button, **AF** button, or Preview dial (main switch ) is operated, and when the shutter release button is pressed halfway.

1 Select [**Button Customization**] in the [**Rec. Mode 5**] menu and press the four-way controller (**▶**).

The [**Button Customization**] screen appears.

2 Use the four-way controller (▲▼) to select an item to set a function to and press the four-way controller (▶).

The screen to set the function for the selected item is displayed.

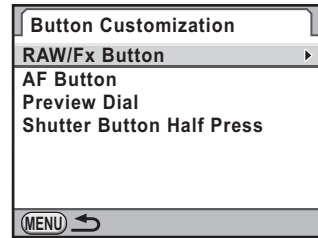

3 Press the four-way controller (▶) and use the four-way controller (▲▼) to select a function.

The following functions can be assigned to each button.

Button	Setting	Function	Page
RAW/Fx button	One Push File Format	Temporarily changes the file format.	p.181
	Exposure Bracketing	Sets the Exposure Bracketing.	p.138
	Digital Preview	Displays the Digital Preview.	p.120
	Electronic Level	Displays the Electronic Level on the monitor.	p.29
	Composition Adjust.	Displays the [Composition Adjust.] screen.	p.195
	GPS	Displays the Electronic Compass, Simple Navigation, or ASTROTRACER screen when the optional GPS unit is attached to the camera.	p.305
AF button	Enable AF	The autofocus system operates.	p.110
	Cancel AF	Disables autofocus with the shutter release button while the button is pressed.	
Preview Dial	Optical Preview	Displays the Optical Preview when the main switch is turned to the preview position (⌚).	p.118
	Digital Preview	Displays the Digital Preview when the main switch is turned to the preview position (⌚).	

Button	Setting	Function	Page
Shutter release button pressed halfway	Enable AF	The autofocus system operates.	-
	Off	The autofocus system does not operate when the shutter release button is pressed halfway.	
	Off (Live View only)	Only during Live View, the autofocus system does not operate when the shutter release button is pressed halfway.	

4 Press the **OK** button.

5 Press the **MENU** button three times.

The camera is ready to take a picture.

Setting the Beep, Date and Time, and Display Language

Setting the Beep

You can turn the camera operation beep on or off, or change its volume. By default, all available items are set to (On), and the volume level is set to [3].

The following items can be set.

- In-focus
- AE-L (AE Lock operation sound)
- Self-timer
- Remote Control
- Mirror Up
- One Push File Format (operation sound when [One Push File Format] is assigned to the **RAW/Fx** button)
- Press OK for 1 sec. (operation sound when Change AF point is enabled or disabled)

1 Select [Beep] in the [Set-up 1] menu and press the four-way controller (▶).

The [Beep 1] screen appears.

2 Press the four-way controller (▼) and use the four-way controller (◀▶) to adjust the volume.

Select from six levels. When set to (0), you can turn all the beeps off.

3 Use the four-way controller (▲▼) to choose an item.

Turn the rear e-dial () to display the [Beep 2] screen.

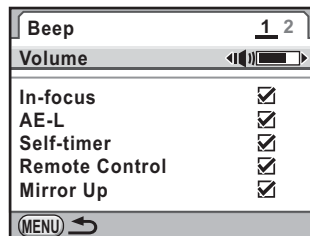

4 Use the four-way controller (◀▶) to select or .

5 Press the **MENU** button twice.

The screen that was displayed before selecting the menu appears again.

Changing the Date and Time Display

You can change the initial date and time settings, and set their display formats. Choose [mm/dd/yy], [dd/mm/yy] or [yy/mm/dd] for the date display format, and [12h] (12-hour display) or [24h] (24-hour display) for the time display format.

Set in [Date Adjustment] in the [ Set-up 1] menu.

-  Setting the Date and Time (p.62)

Setting the World Time

The date and time selected in “Initial Settings” (p.60) serve as the date and time of your present location.

Setting the destination in [World Time] enables you to display the local date and time on the monitor when traveling overseas.

1 Select [World Time] in the [Set-up 1] menu and press the four-way controller ().

The [World Time] screen appears.

2 Use the four-way controller () to select (Destination) or (Hometown) for [Setting the Time].

This setting is reflected on the date and time that appear in the guide display and control panel.

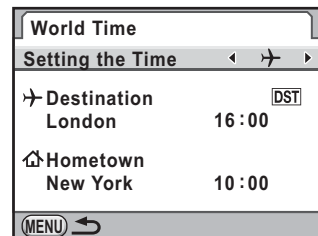

3 Press the four-way controller ().

The selection frame moves to [ Destination].

4 Press the four-way controller (▶).

The [→ Destination] screen appears.

5 Use the four-way controller (◀▶) to select a destination city.

Turn the rear e-dial (☀) to change the region.

The location, time difference and current time of the selected city appear.

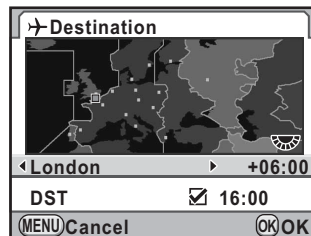

6 Press the four-way controller (▲▼) to select [DST].

7 Use the four-way controller (◀▶) to select or .

Select if the destination city uses daylight saving time (DST).

8 Press the OK button.

The settings are saved and the screen that was displayed in Step 2 appears again.

9 Press the MENU button twice.

The screen that was displayed before selecting the menu appears again.

9



- Refer to “List of World Time Cities” (p.255) for cities that can be selected as a destination.
- Select [🏠 Hometown] in Step 2 to change the city and DST setting.
- → appears in the guide display if [Setting the Time] is set to → (Destination). (p.25) Also, the video output setting (p.225) changes to the video output format for that city.

List of World Time Cities

Region	City	Video Output Format	Region	City	Video Output Format
North America	Honolulu	NTSC	Africa/ West Asia	Istanbul	PAL
	Anchorage	NTSC		Cairo	PAL
	Vancouver	NTSC		Jerusalem	PAL
	San Francisco	NTSC		Nairobi	PAL
	Los Angeles	NTSC		Jeddah	PAL
	Calgary	NTSC		Tehran	PAL
	Denver	NTSC		Dubai	PAL
	Chicago	NTSC		Karachi	PAL
	Miami	NTSC		Kabul	PAL
	Toronto	NTSC		Male	PAL
	New York	NTSC		Delhi	PAL
Halifax	NTSC	Colombo		PAL	
Central and South America	Mexico City	NTSC		Kathmandu	PAL
	Lima	NTSC	Dacca	PAL	
	Santiago	NTSC	East Asia	Yangon	NTSC
	Caracas	NTSC		Bangkok	PAL
	Buenos Aires	PAL		Kuala Lumpur	PAL
	Sao Paulo	PAL		Vientiane	PAL
Rio de Janeiro	NTSC	Singapore		PAL	
Europe	Lisbon	PAL		Phnom Penh	PAL
	Madrid	PAL		Ho chi Minh	PAL
	London	PAL		Jakarta	PAL
	Paris	PAL		Hong Kong	PAL
	Amsterdam	PAL		Beijing	PAL
	Milan	PAL		Shanghai	PAL
	Rome	PAL		Manila	NTSC
	Copenhagen	PAL		Taipei	NTSC
	Berlin	PAL	Seoul	NTSC	
	Prague	PAL	Tokyo	NTSC	
	Stockholm	PAL	Guam	NTSC	
	Budapest	PAL	Oceania	Perth	PAL
	Warsaw	PAL		Adelaide	PAL
	Athens	PAL		Sydney	PAL
	Helsinki	PAL		Noumea	PAL
Moscow	PAL	Wellington		PAL	
Africa/ West Asia	Dakar	PAL		Auckland	PAL
	Algiers	PAL		Pago Pago	NTSC
	Johannesburg	PAL			

Setting the Display Language

You can change the language in which the menus, error messages, etc. are displayed.

Set in [Language/言語] of the [ Set-up 1] menu.

-  Setting the Display Language (p.60)

Setting the Text Size

You can set the text size of an item selected on the respective menu screens to [Standard] (normal display) or [Large] (magnified display).

Set in [Text Size] of the [🔍 Set-up 1] menu.

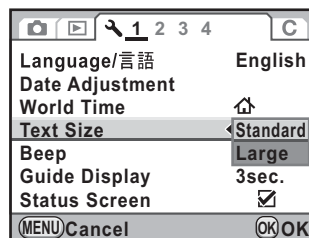

Setting the Guide Display Time

Set the length of time that the guides are displayed on the monitor when the camera is turned on or the exposure mode is changed. (p.25)

Select from [3 sec.] (default setting), [10 sec.], [30 sec.] and [Off].

Set in [Guide Display] of the [🔍 Set-up 1] menu.

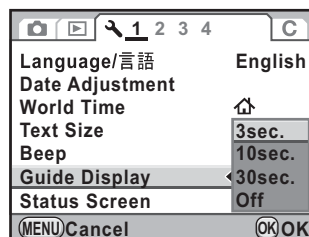

Setting the Initial Menu Tab Displayed

Set the initial menu tab displayed on the monitor when the **MENU** button is pressed.

- 1 Select [24. Save Menu Location] in the [C Custom Setting 4] menu and press the four-way controller (▶).

The [24. Save Menu Location] screen appears.

- 2 Use the four-way controller (▲ ▼) to select [Reset Menu Location] or [Save Menu Location] and press the **OK** button.

1	Reset Menu Location	The [📷 Rec. Mode 1] menu ([📷 Rec. Mode 4] menu when the exposure mode is set to 🎬 (Movie), and [▶ Playback 1] menu when in Playback mode) is always displayed first. (default setting)
2	Save Menu Location	The menu tab last selected is displayed first.

- 3 Press the **MENU** button.

The screen that was displayed before selecting the menu appears again.

Setting the Status Screen Display

You can set whether to display the status screen on the monitor and set the display color of the status screen and control panel.

- 1 Select [Status Screen] in the [🔧 Set-up 1] menu and press the four-way controller (▶).

The [Status Screen] screen appears.

2 Use the four-way controller (◀▶) to select or .

<input checked="" type="checkbox"/>	Displays the status screen. (default setting)
<input type="checkbox"/>	Does not display the status screen.

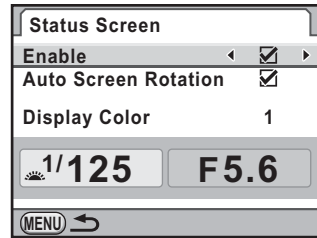

3 Use the four-way controller (▲▼) to select [Auto Screen Rotation] and use the four-way controller (◀▶) to select or .

<input checked="" type="checkbox"/>	If the camera is held vertically while measuring the brightness, the status screen and control panel are displayed vertically. (default setting)
<input type="checkbox"/>	The status screen and control panel are always displayed horizontally.

4 Use the four-way controller (▲▼) to select [Display Color] and use the four-way controller (◀▶) to select from six display colors.

5 Press the MENU button twice.

The screen that was displayed before selecting the menu appears again.

Setting the Display for Instant Review

You can set the Instant Review display settings.

1 Select [Instant Review] in the [📷 Rec. Mode 5] menu and press the four-way controller (▶).

The [Instant Review] screen appears.

- 2** Press the four-way controller (▶) and use the four-way controller (▲▼) to select a display time.

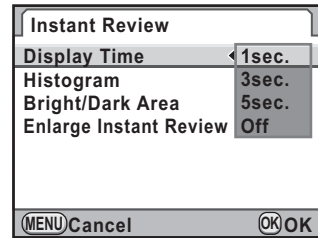

- 3** Press the OK button.

- 4** Use the four-way controller (▲▼) to select [Histogram], [Bright/Dark Area] or [Enlarge Instant Review].

- 5** Use the four-way controller (◀▶) to select or .

When [Enlarge Instant Review] is set to (default setting), you can magnify the image with the rear e-dial (☀). (p.211)

- 6** Press the MENU button twice.

The screen that was displayed before selecting the menu appears again.

Adjusting the Brightness of the Monitor

You can adjust the brightness of the monitor.

- 1** Select [Brightness Level] in the [↖ Set-up 2] menu and press the four-way controller (▶).

The [Brightness Level] screen appears.

- 2** Use the four-way controller (◀▶) to adjust the brightness.

You can select from 15 brightness levels. The value is reset to ±0 when the Ⓞ button is pressed.

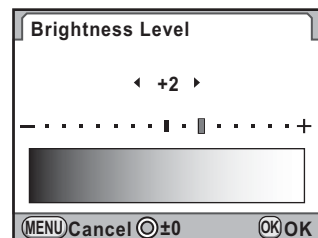

3 Press the **OK** button.

4 Press the **MENU** button.

The screen that was displayed before selecting the menu appears again.

Adjusting the Color of the Monitor

You can adjust the color of the monitor.

1 Select **[LCD Color Tuning]** in the [**↶ Set-up 2**] menu and press the four-way controller (**▶**).

The [LCD Color Tuning] screen appears.

2 Adjust the color.

Seven levels are available on the G-M and B-A axes.

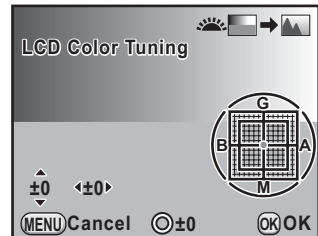

Available operations

Four-way controller (**▲ ▼**) Adjusts the tone of the colors between green (G) and magenta (M).

Four-way controller (**◀ ▶**) Adjusts the tone of the colors between blue (B) and amber (A).

⊙ button Resets the adjustment value.

Front e-dial (**☀**) Displays a saved image in the background so you can adjust the color while viewing the image. This is useful for matching the color of the monitor with that of a computer.

3 Press the **OK** button.

4 Press the **MENU** button.

The screen that was displayed before selecting the menu appears again.

Setting the Electronic Level Display

This camera is equipped with an electronic level for detecting whether the camera is level, as indicated on the bar graph in the viewfinder and on the LCD panel and monitor. Select whether to display the bar graph.

1 Select **[Electronic Level]** in the **[📷 Rec. Mode 4]** menu.

2 Use the four-way controller (◀▶) to select or .

<input checked="" type="checkbox"/>	Displays the bar graph of the electronic level.
<input type="checkbox"/>	Does not display the bar graph of the electronic level. (default setting)

3 Press the **MENU** button.

The screen that was displayed before selecting the menu appears again.



The bar graph can be displayed on the monitor when the **INFO** button is pressed in the control panel. (p.26) When **[Electronic Level]** is assigned to the **RAW/Fx** button (p.249), press the **RAW/Fx** button while the status screen or Live View is displayed to display the electronic level. (p.149)

Changing the Naming System of the Folder

You can select a naming system of the folder for storing images. Set in [Folder Name] in the [ Set-up 2] menu.

Date	The two digits of the month and day on which the picture was taken are assigned as the folder name in the form of [xxx_MMDD]. [xxx] is a sequential number from 100 to 999. [MMDD] (month and day) appears according to the display style set in [Date Adjustment] (p.253). (default setting) Example) 101_0125: Folder for images taken on January 25th
PENTX	The folder name is assigned in the form of [xxxPENTX]. Example) 101PENTX



When the number of storable images exceeds 500, captured images are divided into folders of 500 images each. However, in Auto Bracketing shooting, images will be stored in the same folder until shooting is completed, even if the number of images exceeds 500.

Creating New Folders

Creates a new folder on an SD Memory Card. A folder is created with the number following the number of the folder currently being used.

- 1** Select [Create New Folder] in the [ Set-up 2] menu and press the four-way controller (▶).

The [Create New Folder] screen appears.

- 2** Press the four-way controller (▲) to select [Create folder] and press the OK button.

A folder with a new number is created.





Only one folder can be created using this operation. Multiple empty folders cannot be created consecutively.

Setting the File Name

You can change the file names of images.

The default naming conventions are as follows depending on the [Color Space] (p.189) setting in the [📷 Rec. Mode 3] menu.

“xxxx” indicates the file number. This is displayed as a four-digit sequential number.

Color Space	File Name
sRGB	IMG Pxxxx.JPG
AdobeRGB	_IG Pxxxx.JPG

For sRGB, you can change [IMG P] (4 characters) to the desired characters.

For AdobeRGB, of the 4 characters you selected, the first 3 are assigned in place of [IG P].

Example: When set to [ABCDxxxx.JPG], files are named
[_ABCxxxx.JPG] for AdobeRGB.

- 1** Select [File Name] in the [🔍 Set-up 3] menu and press the four-way controller (▶).

The [File Name] screen appears.

- 2** Use the four-way controller (▲▼) to select [Change] and press the four-way controller (▶).

The text-entry screen appears.

Select [Reset File Name] to reset a changed file name to its default setting.

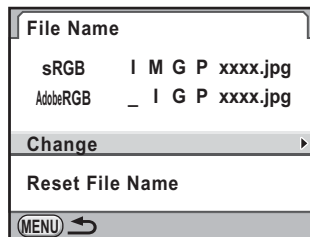

3

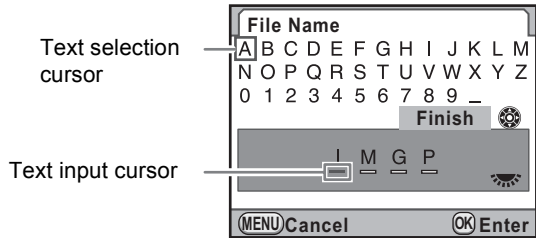
Change the text.**Available operations**

Four-way controller (▲▼◀▶)	Moves the text selection cursor.
Rear e-dial (🔍)	Moves the text input cursor.
OK button	Enters a character selected with the text selection cursor at the position of the text input cursor.

4

After entering the text, move the text selection cursor to [Finish] and press the OK button.

The file name is changed.

5

Press the MENU button twice.

The screen that was displayed before selecting the menu appears again.

Selecting the File Number Setting

You can select a method for assigning the file number of an image when saved to a new folder. Set in [File No.] of [Memory] (p.274) in the [📷 Rec. Mode 4] menu.

<input checked="" type="checkbox"/>	The file number of the last image saved to the previous folder is saved and subsequent images are assigned sequential file numbers even if a new folder is created.
<input type="checkbox"/>	The file number of the first image saved to a folder returns to 0001 each time a new folder is created for saving images.

9

Setting the Auto Power Off Function

You can set the camera to turn off automatically if unused after a certain length of time. Select from [1min.] (default setting), [3min.], [5min.], [10min.], [30min.] or [Off].

Set in [Auto Power Off] of the [ Set-up 3] menu.

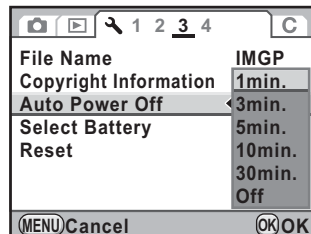

- The Auto Power Off function does not work in the following situations.
 - when the Live View image is displayed
 - when the slideshow is played back
 - when the camera is connected to a computer with a USB cable
- If the camera turns off after the set length of time, perform one of the following operations to reactivate it.
 - Turn on the camera again.
 - Press the shutter release button halfway.
 - Press the  button, **MENU** button or **INFO** button.

Selecting a Battery

You can set the battery priority to the camera or the battery grip when the optional battery grip D-BG4 is attached.

- 1 Select **[Select Battery]** in the **[Set-up 3]** menu and press the four-way controller (▶).

The **[Select Battery]** screen appears.

- 2 Press the four-way controller (▶).

- 3 Use the four-way controller (▲▼) to select a battery to be prioritized and press the **OK** button.

Auto Select	Priority is given to the battery with more power remaining. (default setting)
Body First/ Grip First	Priority is given to the selected battery.

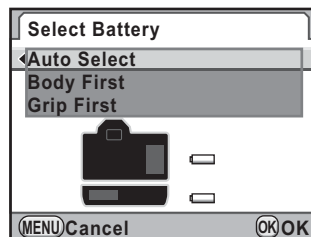

- 4 When using AA batteries in the battery grip, use the four-way controller (▲▼) to select **[AA Battery Type]** and press the four-way controller (▶).

- 5 Use the four-way controller (▲▼) to select the AA battery type and press the **OK** button.

When set to **[Auto-detect]**, the camera will automatically detect the type of batteries being used.

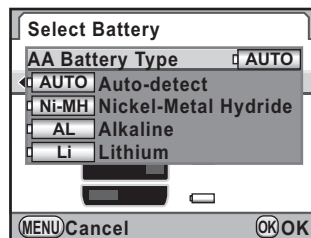

- 6 Press the **MENU** button twice.

The screen that was displayed before selecting the menu appears again.



- If a battery is inserted into both the body and grip, the battery levels of both are checked when the power is turned on. Regardless of the [Select Battery] setting, both batteries are slightly used.
- When the currently selected battery runs out as a result of the check, the message [Battery depleted] appears on the monitor. Turn the camera off and on again, and the camera will switch to the remaining battery.
- You can check the battery usage condition on the status screen and LCD panel. (p.51)



When the type of AA batteries inserted in the battery grip differs from the battery type setting in Step 5, the battery level will not be correctly determined. Please set the correct battery type. Usually, there is no problem using [Auto-detect]. However in low temperatures and when using batteries that were stored for long periods of time, set the appropriate battery type so the camera can correctly determine the remaining battery level.

The camera type, shooting conditions and other information are automatically embedded in captured images in the Exif data format. You can embed photographer information in this Exif.



Use the provided software (p.283) to check the Exif information.

1 Select [Copyright Information] in the [↖ Set-up 3] menu and press the four-way controller (▶).

The [Copyright Information] screen appears.

2 Use the four-way controller (◀▶) to select or .

<input checked="" type="checkbox"/>	Embeds copyright information in the Exif.
<input type="checkbox"/>	Does not embed copyright information in the Exif. (default setting)

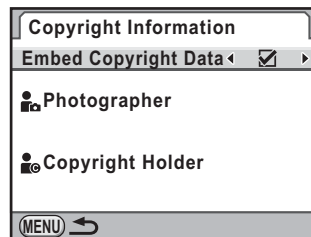

3 Use the four-way controller (▲▼) to select [Photographer] and press the four-way controller (▶).

The text-entry screen appears.

4 Enter the text.

Up to 32 single-byte alphanumeric characters and symbols can be entered.

Text selection cursor

Text input cursor

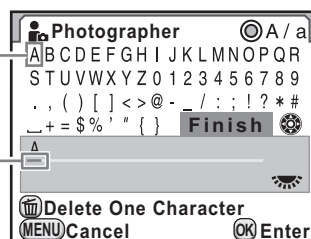

Available operations

Four-way controller (▲▼◀▶)	Moves the text selection cursor.
Rear e-dial (🌀)	Moves the text input cursor.
⊙ button	Switches between upper and lower case letters.
OK button	Enters a character selected with the text selection cursor at the position of the text input cursor.
🗑 button	Deletes a character at the position of the text input cursor.

5 After entering the text, move the text selection cursor to [Finish] and press the **OK** button.

The camera returns to the [Copyright Information] screen.

6 Use the four-way controller (▲▼) to select [Copyright Holder] and enter the text in the same way as [Photographer].

7 Press the **MENU** button twice.

The screen that was displayed before selecting the menu appears again.

By adding DPOF (Digital Print Order Format) settings to stored images on the SD Memory Card, you can specify the number of copies and whether to imprint the date on the images in advance and order conventional photograph prints by taking this SD Memory Card to a store for printing.



- DPOF settings cannot be applied to RAW images and movies.
- You can make DPOF settings for up to 999 images.

1 Press the four-way controller (▼) in Playback mode.

The playback mode palette appears.

2 Use the four-way controller (▲▼◀▶) to select (DPOF) and press the OK button.

The screen to select how to change the settings is displayed.

3 Use the four-way controller (▲▼) to select [Single Image] or [All Images] and press the OK button.

If you selected [All Images], proceed to Step 5.



4 Use the four-way controller (◀▶) to select an Image.

5 Use the four-way controller (▲▼) to select the number of copies.

You can set up to 99 copies.

 appears at the top right of the screen for images with DPOF settings.

To cancel the DPOF settings, set the number of copies to [00].



6 Turn the rear e-dial () to select or for printing the date.

<input checked="" type="checkbox"/>	The date will be printed.
<input type="checkbox"/>	The date will not be printed.

Repeat Steps 4 to 6 to make DPOF settings for other images.

7 Press the **OK** button.

The DPOF settings for the selected image is saved and the camera returns to Playback mode.



- Depending on the printer or printing equipment at the photo processing lab, the date may not be printed on the pictures.
- The number of copies specified for all images is applied to all the images, and that specified for a single image is canceled.

Correcting Defective Pixels in the CMOS Sensor (Pixel Mapping)

Pixel Mapping is a function for mapping out and correcting defective pixels in the CMOS sensor.

- 1 Select [Pixel Mapping] in the [ Set-up 4] menu and press the four-way controller (▶).**

The [Pixel Mapping] screen appears.

- 2 Press the four-way controller (▲) to select [Pixel Mapping] and press the OK button.**

Defective pixels are mapped out and corrected, and the screen that was displayed before selecting the menu appears again.



When the battery level is low, the message [Not enough battery power remaining to activate Pixel Mapping] is displayed on the monitor. Use the AC adapter kit (optional) or change to the battery with ample power remaining.

Selecting Settings to Save in the Camera (Memory)

You can select which function settings to save when the camera is turned off. The following function settings can be saved.

Function	Default Setting
Flash Mode	<input checked="" type="checkbox"/>
Drive Mode	<input checked="" type="checkbox"/>
White Balance	<input checked="" type="checkbox"/>
Custom Image	<input checked="" type="checkbox"/>
Sensitivity	<input checked="" type="checkbox"/>
EV Compensation	<input checked="" type="checkbox"/>
Flash Exposure Comp.	<input checked="" type="checkbox"/>

Function	Default Setting
Cross Processing	<input type="checkbox"/>
Extended Bracketing	<input checked="" type="checkbox"/>
Digital Filter	<input type="checkbox"/>
HDR Capture	<input type="checkbox"/>
Playback Info Display	<input checked="" type="checkbox"/>
File No.	<input checked="" type="checkbox"/>



[Memory] cannot be selected when the mode dial is set to **USER**.

1 Select [Memory] in the [CAMERA Rec. Mode 5] menu and press the four-way controller (▶).

The [Memory 1] screen appears.

2 Use the four-way controller (▲▼) to choose an item.

Turn the rear e-dial (📷) to display the [Memory 2] screen.

Memory	1 2
Flash Mode	<input checked="" type="checkbox"/>
Drive Mode	<input checked="" type="checkbox"/>
White Balance	<input checked="" type="checkbox"/>
Custom Image	<input checked="" type="checkbox"/>
Sensitivity	<input checked="" type="checkbox"/>
EV Compensation	<input checked="" type="checkbox"/>
Flash Exposure Comp.	<input checked="" type="checkbox"/>
(MENU) ↶	

3 Use the four-way controller (◀▶) to select or .

<input checked="" type="checkbox"/>	Settings are saved even when the camera is turned off.
<input type="checkbox"/>	Settings are cleared and returned to their default values when the camera is turned off.

4 Press the **MENU** button twice.

The screen that was displayed before selecting the menu appears again.



- Set [File No.] to (On) to continue the sequential numbering for the file name even if a new folder is created. Refer to "Selecting the File Number Setting" (p.265).
- When the [Set-up] menu is reset (p.296), all Memory settings return to the default values.

Memo

10 Connecting to a Computer

This chapter explains how to connect the camera to your computer, install the supplied CD-ROM, etc.

Manipulating Captured Images on a Computer	278
Saving Images on Your Computer	279
Using the Provided Software	281

Manipulating Captured Images on a Computer

The captured still pictures and movies can be transferred to a computer by connecting this camera using a USB cable and can be managed using the provided software.

We recommend the following system requirements to connect your camera to a computer or to use the software “PENTAX Digital Camera Utility 4” included on the CD-ROM (S-SW132).

● Windows

OS	Windows XP (SP3 or later), Windows Vista, or Windows 7 (can be run as a 32-bit application on any x64 Edition of Windows.)
CPU	Pentium D 3.0 GHz equivalent or higher (Intel Core 2 Duo processor 2.0 GHz equivalent or higher recommended)
RAM	2.0 GB or more (3.0 GB or more recommended)
Free Disk Space	1 GB or more (8 GB or more recommended)
Monitor	1280×800 pixels or more (1920×1200 or more recommended) with 24-bit full color (approximately 16.77 million colors)
Others	USB 2.0 port must be standard equipment

● Macintosh

OS	Mac OS X 10.4.11, 10.5, 10.6, or 10.7
CPU	PowerPC G5 Dual-core 2.0 GHz or higher (Intel Core 2 Duo processor 2.0 GHz or higher recommended. Universal Binary format.)
RAM	2.0 GB minimum (4.0 GB or more recommended)
Free Disk Space	1 GB minimum (8 GB or more recommended)
Monitor	1280×800 pixels or more (1920×1200 or more recommended) with 24-bit full color (approximately 16.77 million colors)
Others	USB 2.0 port must be standard equipment

Setting the USB Connection Mode

Set the USB connection mode when connecting the camera to a computer.

- 1** Select **[USB Connection]** in the [ **Set-up 2]** menu and press the four-way controller (**▶**).
- 2** Use the four-way controller (**▲ ▼**) to select **[MSC]** or **[PTP]**.

MSC	Mass Storage Class (default setting) A general-purpose driver program that handles devices connected to a computer via USB as a memory device.
PTP	Picture Transfer Protocol A protocol that allows transfer of digital images and control of digital cameras via USB.

Unless otherwise specified, select **[MSC]**.

- 3** Press the **OK** button.
- 4** Press the **MENU** button.

The screen that was displayed before selecting the menu appears again.

Connecting the Camera and a Computer

Connect the camera to a computer using the provided USB cable I-USB7.

- 1 Turn your computer on.**
- 2 Turn the camera off, and use the USB cable to connect the PC/AV terminal of the camera and the computer.**

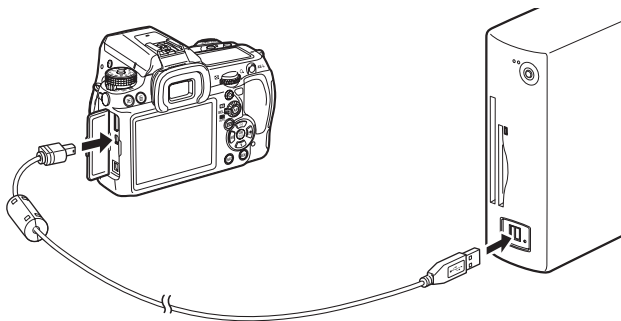

- 3 Turn your camera on.**

The camera is recognized as a removable disk or an SD Memory Card with a volume label "K-5 II".

If the "K-5 II" dialog appears when the camera is turned on, select [Open folder to view files using Windows Explorer] and click the OK button.

- 4 Save the captured images to your computer.**

Copy the image file(s) or folder(s) to the hard disk of the computer.

- 5 Disconnect your camera from your computer.**



The camera cannot be operated while it is connected to the computer. To operate the camera, terminate the USB connection on the computer, then turn off the camera and remove the USB cable.

“PENTAX Digital Camera Utility 4” is included on the CD-ROM (S-SW132). Using the PENTAX Digital Camera Utility 4, you can manage images saved on your computer, and develop RAW files taken with this camera and adjust the color of the images.

Compatible file formats: .bmp (BMP)/.jpg (JPEG)/.pef (files recorded in PENTAX’s original RAW format)/.png (PNG)/.tif (TIFF)/.dng (DNG format RAW file)

Installing the Software

You can install the software from the provided CD-ROM. When multiple accounts have been setup on your computer, log on with an account that has administrative rights before installing the software.

1 Turn your computer on.

Make sure no other software is running.

2 Place the CD-ROM into the CD/DVD drive on the computer.

The [PENTAX Software Installer] screen appears.

If the [PENTAX Software Installer] screen does not appear

• For Windows

- 1 Click [My Computer] from the Start menu.
- 2 Double-click the [CD/DVD drive (S-SW132)] icon.
- 3 Double-click the [Setup.exe] icon.

• For Macintosh

- 1 Double-click the CD/DVD (S-SW132) icon on the desktop.
- 2 Double-click the [PENTAX Installer] icon.

3 Click [PENTAX Digital Camera Utility 4].

For Macintosh, follow the instructions on the screen to perform subsequent steps.

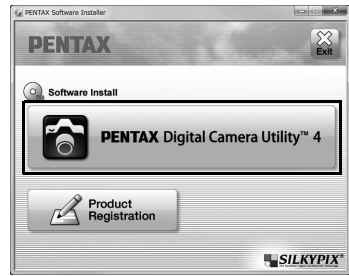

4 Select the desired language in the [Choose Setup Language] screen and click [OK].



5 When the [InstallShield Wizard] screen appears in the selected language, click [Next].

Follow the instructions on the screen to perform subsequent steps.

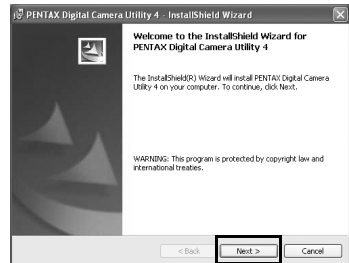

Screens of the PENTAX Digital Camera Utility 4

When PENTAX Digital Camera Utility 4 is launched, the following screen (browser) appears.



The screenshots used in this explanation are for Windows.

● Browser tab set (default setting)

You can perform the file management functions such as viewing and organizing the images.

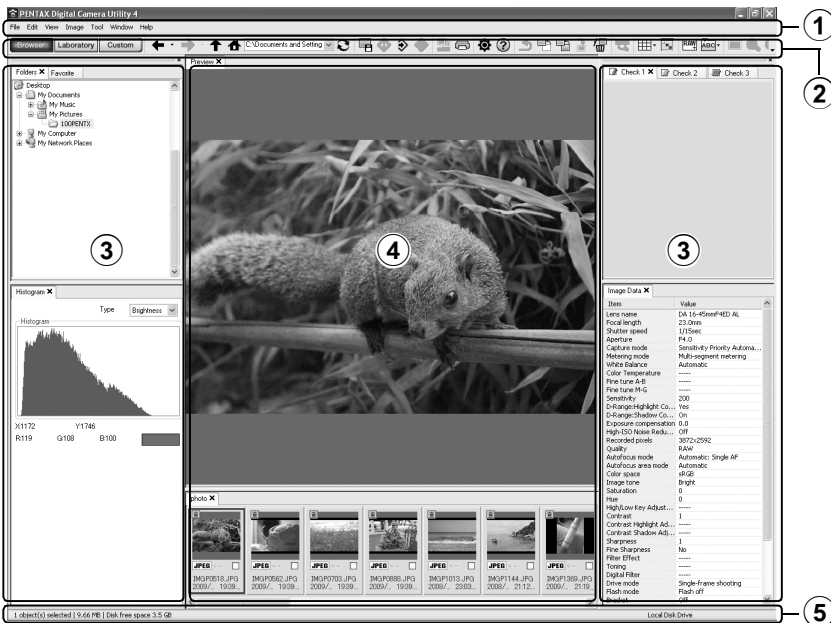

① Menu Bar

This executes functions or makes various settings.
For Macintosh, the Menu bar appears at the top of the desktop.

② Tool Bar

Frequently used functions are provided as Tool bar buttons.

③ Control Panel

Shooting information and settings of the selected image appear in this panel. The set of tab pages displayed in Control Panel can be changed by pressing the Browser, Laboratory and Custom buttons on the Tool bar.

④ File Display Pane

The file list and the images in the selected folder appear here.

⑤ Status Bar

Information on the selected item appears.

● Laboratory tab set (default setting)

The control panel for adjusting the image appears here.

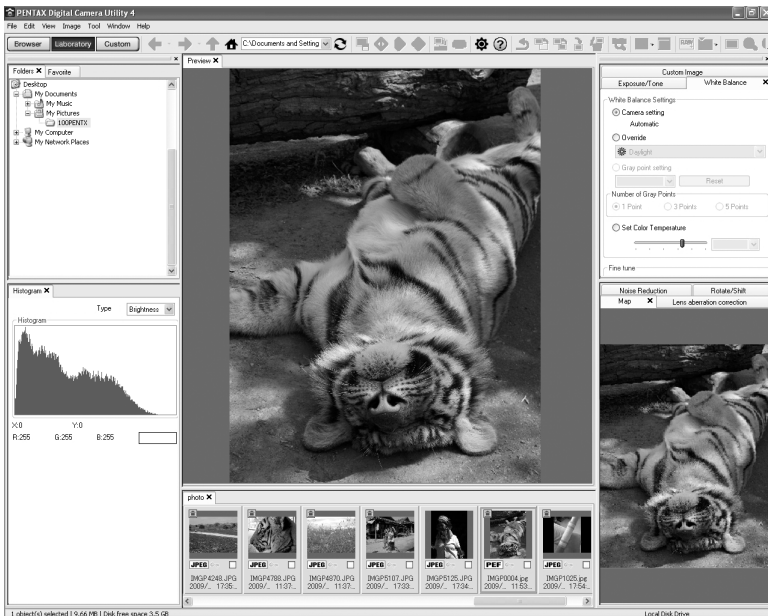

● Custom tab set (default setting)

The screen display can be customized here.

The Custom tab pages enable you to customize whether to show/hide the various tab pages in accordance with your needs. By default, all tab pages are displayed.

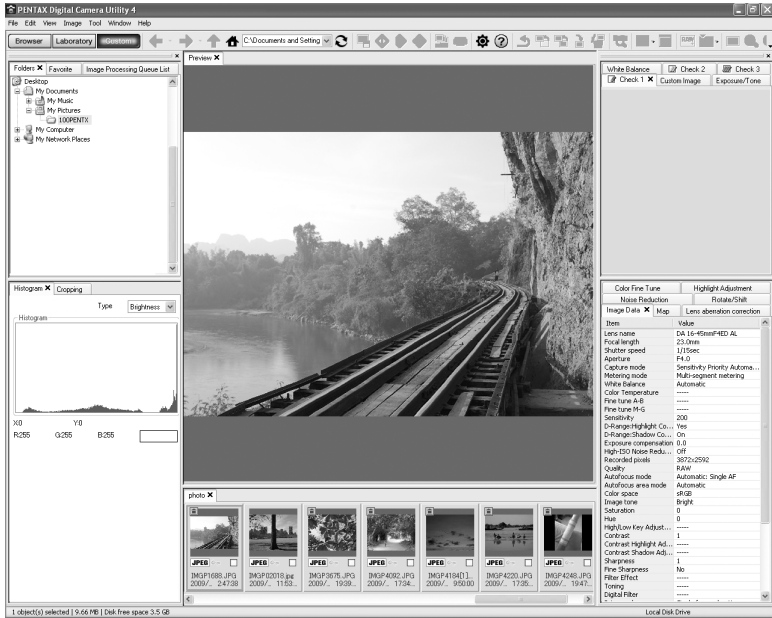

Viewing Detailed Information on the Software

Refer to Help for details on using the software program.

1 Click the button on the Tool bar.

Or, select [PENTAX Digital Camera Utility Help] from the [Help] menu.

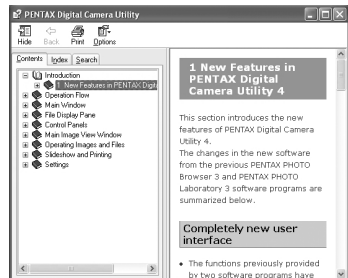

Regarding Product Registration

To better serve you, please take a moment to register your software.

Click [Product Registration] on the screen in Step 3 on p.282.



A world map for Internet Product Registration is displayed. If your computer is connected to the Internet, click the displayed country or region and then follow the instructions to register your software.

Note that you can only register online if your country or area is shown.

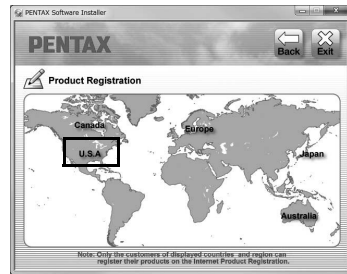

11 Appendix

Default Settings	288
Resetting the Menus	296
Functions Available with Various Lens	
Combinations	297
Cleaning the CMOS Sensor	300
Using the GPS Unit	305
Error Messages	310
Troubleshooting	313
Main Specifications	315
Index	321
WARRANTY POLICY	327

Default Settings

The table below shows the factory default settings.

The functions set in Memory (p.274) are saved even when the camera is turned off.

Reset Setting

Yes: The setting returns to the default setting with the reset function (p.296).

No : The setting is saved even after reset.





Direct Keys

Item	Default Setting	Reset Setting	Page
Drive Mode	<input type="checkbox"/> (Single Frame Shooting)	Yes	p.132 p.125 p.127 p.138 p.130
Flash Mode	Depends on the capture mode	Yes	p.69
White Balance	AWB (Auto)	Yes	p.183
Custom Image	Bright	Yes	p.197

[Rec. Mode] Menu

Item	Default Setting	Reset Setting	Page
USER Mode *1	USER1	Yes	p.206
Exposure Mode *1	P (Program Automatic Exposure)	Yes	p.205
File Format	JPEG	Yes	p.180
JPEG Recorded Pixels	16M (4928×3264)	Yes	p.178
JPEG Quality	★★★ (Best)	Yes	p.179
AF Settings	AUTO AF Point Setting	11 AF Points	Yes p.113
	Expanded Area AF	<input type="checkbox"/> (Off)	Yes p.115

Item		Default Setting	Reset Setting	Page
Lens Correction	Distortion Correction	Off	Yes	p.193
	Lat-Chromatic-Ab Adj	Off	Yes	
Cross Processing		Off	Yes	p.200
Extended Bracketing	Type	Off	Yes	p.141
	Bracketing Amount	BA±1 (White Balance)/ ±1 (other than White Balance)	Yes	
Digital Filter		Not use any filters	Yes	p.143
HDR Capture	HDR Capture	Off	Yes	p.191
	Auto Align	<input type="checkbox"/> (Off)	Yes	
Multi-exposure	Number of Shots	2 times	Yes	p.136
	Auto EV Adjustment	<input type="checkbox"/> (Off)	Yes	
Interval Shooting	Interval	00:00'01"	Yes	p.133
	Number of Shots	2 images	Yes	
	Start Interval	Now	Yes	
	Start Time	12:00AM / 00:00	Yes	
Composition Adjust.	X-Y direction	Center	Yes	p.195
	Rotation	±0°	Yes	
	Recall Previous Position	<input type="checkbox"/> (Off)	Yes	
D-Range Setting	Highlight Correction	Off	Yes	p.190
	Shadow Correction	Off	Yes	
ISO AUTO Setting	Sensitivity limit	100 – 3200	Yes	p.84
	AUTO ISO Parameters	<input checked="" type="checkbox"/> (Standard)	Yes	
High-ISO NR		Auto	Yes	p.85
Slow Shutter Speed NR		Auto	Yes	p.87
Program Line		<input checked="" type="checkbox"/> (Normal) (Normal)	Yes	p.89
Color Space		sRGB	Yes	p.189
RAW File Format		PEF	Yes	p.181

Item		Default Setting	Reset Setting	Page	
Movie	Recorded Pixels	 (1280×720, 16:9, 30 fps)	Yes	p.152	
	Quality Level	★★★ (Best)	Yes		
	Sound	 (On)	Yes		
	Cross Processing	Off	Yes		
	Digital Filter	Not use any filters	Yes		
	Movie Aperture Control	Fixed	Yes		
	Shake Reduction	 (Off)	Yes		
Live View	Autofocus Method	 (Face Detection AF)	Yes	p.147	
	Show Grid	Off	Yes		
	Info Overlay	<input checked="" type="checkbox"/> (On)	Yes		
	Histogram	<input type="checkbox"/> (Off)	Yes		
	Bright/Dark Area	<input type="checkbox"/> (Off)	Yes		
Electronic Level		<input type="checkbox"/> (Off)	Yes	p.262	
Horizon Correction		<input type="checkbox"/> (Off)	Yes	p.123	
Shake Reduction		 (On)	Yes	p.122	
Input Focal Length		35 mm	Yes	p.124	
GPS	Electronic Compass		—	—	p.305
	Simple Navigation		—	—	
	ASTRO-TRACER (Bulb)	Timed Exposure	<input type="checkbox"/> (Off)	Yes	
		Exposure Time Preset	5'00"	Yes	
		Precise Calibration	—	—	
	Calibration		—	—	
	Positioning Interval		1min.	Yes	
	Auto Time Synch.		On	Yes	
Instant Review	Display Time	1 sec.	Yes	p.259	
	Histogram	<input type="checkbox"/> (Off)	Yes		
	Bright/Dark Area	<input type="checkbox"/> (Off)	Yes		
	Enlarge Instant Review	<input checked="" type="checkbox"/> (On)	Yes		

Item		Default Setting	Reset Setting	Page
Digital Preview	Histogram	<input type="checkbox"/> (Off)	Yes	p.119
	Bright/Dark Area	<input type="checkbox"/> (Off)	Yes	
	Enlarge Instant Review	<input checked="" type="checkbox"/> (On)	Yes	
E-Dial Programming	P	Tv, Av, P	Yes	p.247
	Sv	-, ISO, -		
	Tv	Tv, -, -		
	Av	-, Av, -		
	TAv/M	Tv, Av, P LINE		
	B	-, Av, -		
	X	-, Av, -		
	-, Av, AvSHIFT			
Button Customization	RAW/Fx Button	One Push File Format	Yes	p.249
	AF Button	Enable AF		
	Preview Dial	Optical Preview		
	Shutter Button Half Press	Enable AF		
Memory	Cross Processing, Digital Filter, HDR Capture	<input type="checkbox"/> (Off)	Yes	p.274
	Other than the above functions	<input checked="" type="checkbox"/> (On)	Yes	
Save USER Mode		-	Yes* ²	p.202

*1 Appears only when the mode dial is set to **USER**.

*2 The saved settings are reset only with [Reset USER Mode] in the [Save USER Mode] screen.

Playback Mode Palette

Item	Default Setting	Reset Setting	Page
Image Rotation	–	–	p.219
Digital Filter	Toy Camera	Yes	p.233
Resize	Maximum size according to the setting	–	p.230
Cropping	Maximum size according to the setting	–	p.231
Protect	–	No	p.222
Slideshow	–	–	p.217
Save as Manual WB	–	–	p.187
RAW Development	File Format: JPEG Recorded Pixels: 16M Quality Level: ★★★	Yes	p.238
Index	–	–	p.215
Movie Editing	–	–	p.159
DPOF	–	No	p.271
Save Destination	–	–	p.306

[▶ Playback] Menu

Item		Default Setting	Reset Setting	Page
Slideshow	Interval	3 sec.	Yes	p.217
	Screen Effect	Off	Yes	
	Repeat Playback	<input type="checkbox"/> (Off)	Yes	
Quick Zoom		Off	Yes	p.210
Bright/Dark Area		<input type="checkbox"/> (Off)	Yes	
Auto Image Rotation		<input checked="" type="checkbox"/> (On)	Yes	
Delete All Images		–	–	p.222

[ Set-up] Menu

Item		Default Setting	Reset Setting	Page
Language/言語		English	No	p.256
Date Adjustment		01/01/2012	No	p.253
World Time	Setting the Time	 (Hometown)	Yes	p.253
	Destination (City)	Same as Hometown	No	
	Destination (DST)	Same as Hometown	No	
	Hometown (City)	According to initial setting	No	
	Hometown (DST)	According to initial setting	No	
Text Size		According to initial setting	No	p.257
Beep	Volume	3	Yes	p.252
	Setting	All <input checked="" type="checkbox"/> (On)		
Guide Display		3 sec.	Yes	p.257
Status Screen	Status Screen	<input checked="" type="checkbox"/> (On)	Yes	p.258
	Auto Screen Rotation	<input checked="" type="checkbox"/> (On)	Yes	
	Display Color	1	Yes	
Brightness Level		±0	Yes	p.260
LCD Color Tuning		±0	Yes	p.261
Video Out		According to initial setting	No	p.225
HDMI Out		Auto	Yes	p.227
USB Connection		MSC	Yes	p.279
Folder Name		Date	Yes	p.263
Create New Folder		–	–	p.263
File Name		IMGP/_JGP	No*3	p.264
Copyright Information	Embed Copyright Data	<input type="checkbox"/> (Off)	No	p.269
	Photographer	–		
	Copyright Holder	–		
Auto Power Off		1 min.	Yes	p.266
Select Battery	Select Battery	Auto Select	Yes	p.267
	AA Battery Type	Auto-detect	Yes	
Reset		–	–	p.296
Pixel Mapping		–	–	p.273
Dust Alert		–	–	p.301

Item		Default Setting	Reset Setting	Page
Dust Removal	Dust Removal	–	–	p.300
	Start-up Action	<input checked="" type="checkbox"/> (On)	Yes	
Sensor Cleaning		–	–	p.303
Format		–	–	p.246

*3 The setting can be reset only with [Reset File Name] in the [File Name] screen.

[C Custom Setting] Menu

Item	Default Setting	Reset Setting	Page
1. EV Steps	1/3 EV Steps	Yes	p.106
2. Sensitivity Steps	1 EV Step	Yes	p.84
3. Expanded Sensitivity	Off	Yes	p.84
4. Meter Operating Time	10 sec.	Yes	p.104
5. AE-L with AF Locked	Off	Yes	p.115
6. Link AE to AF Point	Off	Yes	p.104
7. Auto EV Compensation	Off	Yes	–
8. Auto Bracketing Order	0 - +	Yes	p.138
9. One-Push Bracketing	Off	Yes	p.140
10. WB Adjustable Range	Auto Adjustment	Yes	p.185
11. WB When Using Flash	Auto White Balance	Yes	p.185
12. AWB in Tungsten Light	Subtle Correction	Yes	–
13. Color Temperature Steps	Kelvin	Yes	p.188
14. Superimpose AF Area	On	Yes	p.113
15. AF.S Setting	Focus-priority	Yes	p.109
16. AF.C Setting	Focus-priority	Yes	p.109
17. AF Assist Light	On	Yes	p.109
18. AF with Remote Control	Off	Yes	p.129
19. Remote Control in Bulb	Mode1	Yes	p.102
20. Release While Charging	Off	Yes	p.71
21. Flash in Wireless Mode	On	Yes	p.172
22. LCD Panel Illumination	High	Yes	p.38
23. Saving Rotation Info	On	Yes	p.219
24. Save Menu Location	Reset Menu Location	Yes	p.258

Item	Default Setting	Reset Setting	Page
25. Catch-in Focus	Off	Yes	p.117
26. AF Fine Adjustment	Off	Yes *4	p.111
27. Using Aperture Ring	Prohibited	Yes	p.299
Reset Custom Functions	–	–	p.296

*4 The saved adjustment value is reset only with [Reset] in the [26. AF Fine Adjustment] screen.

Resetting the Rec. Mode/Playback/Set-up Menus

Settings in the [📷 Rec. Mode] menu, [▶ Playback] menu, [⚙ Set-up] menu, direct keys and playback mode palette can be reset to default settings.



Language/言語, Date Adjustment, the city and DST settings for World Time, Text Size, Video Output, Copyright Information and [C Custom Setting] menu settings are not reset.



[Reset] cannot be selected when the mode dial is set to USER.

- 1 Select [Reset] in the [⚙ Set-up 3] menu and press the four-way controller (▶).**

The [Reset] screen appears.

- 2 Press the four-way controller (▲) to select [Reset] and press the OK button.**

The settings are reset, and the screen that was displayed before selecting the menu appears again.

Resetting the Custom Menu

Reset settings in [C Custom Setting] menu to default values.

- 1 Select [Reset Custom Functions] in the [C Custom Setting 4] menu and press the four-way controller (▶).**

The [Reset Custom Functions] screen appears.

- 2 Press the four-way controller (▲) to select [Reset] and press the OK button.**

The settings are reset, and the screen that was displayed before selecting the menu appears again.

Functions Available with Various Lens Combinations

All camera capture modes are available when DA, DA L, or FA J lens is used, or when a lens with an **A** (Auto) position is used with the aperture ring set to the **A** position.

When they are used in a position other than **A**, or other lenses are used, the following restrictions apply.

- ✓ : Functions are available when the aperture ring is set to the **A** position.
- # : Some functions are restricted.
- × : Functions are unavailable.

Function	Lens [Mount type]	DA DA L D FA	FA J FA *6	F *6	A	M P
		[KAF] [KAF2] [KAF3]	[KAF] [KAF2]	[KAF]	[KA]	[K]
Autofocus (Lens only) (With AF adapter 1.7×)*1		✓ —	✓ —	✓ —	— #*9	— #*9
Manual focus (With the focus indicator)*2 (With matte field)		✓ ✓	✓ ✓	✓ ✓	✓ ✓	✓ ✓
Quick-Shift Focus System		#*4	×	×	×	×
Eleven AF points/Five AF points		✓	✓	✓	#*9	×
Multi-segment metering		✓	✓	✓	✓	×
P/Sv/Tv/Av/TA v mode		✓	✓	✓	✓	#*10
M mode		✓	✓	✓	✓	#
P-TTL Auto Flash *3		✓	✓	✓	✓	×
Power Zoom		—	✓*7	—	—	—
Automatically obtaining the lens focal length information when using the Shake Reduction function		✓	✓	✓	×	×
Lens Correction function		✓*5	×*8	×	×	×

*1 Lenses with a maximum aperture of F2.8 or faster. Only available at the **A** position.

*2 Lenses with a maximum aperture of F5.6 or faster.

*3 When using the built-in flash, AF540FGZ, AF360FGZ, AF200FG and/or AF160FC.

*4 Only available with compatible lenses.

- *5 The [Distortion Correction] setting is disabled when using the DA 10-17mm FISH-EYE lens.
- *6 To use an FA SOFT 28mm F2.8 lens, FA SOFT 85mm F2.8 lens, or F SOFT 85mm F2.8 lens, set [27. Using Aperture Ring] to [Permitted] in the [**C** Custom Setting 4] menu. Pictures can be taken with the aperture you set, but only within manual aperture range.
- *7 Only available with KAF2 mount FA lenses.
- *8 Only available with an FA 31mm F1.8 Limited, FA 43mm F1.9 Limited, or FA 77mm F1.8 Limited lens.
- *9 The focusing area is fixed to  (Center).
- *10 **Av** (Aperture Priority Automatic Exposure) mode with the aperture set wide open. (Adjusting the aperture ring has no effect on the actual aperture value.)

Lens Names and Mount Names

DA lenses with a motor and FA zoom lenses with a power zoom function use the KAF2 mount. DA lenses with a motor and no AF coupler use the KAF3 mount.

FA single focal length lenses (non-zoom lenses), DA or DA L lenses without a motor and D FA, FA J and F lenses use the KAF mount. Refer to respective lens manuals for details.

Lenses and Accessories that Cannot be Used with this Camera

When the aperture ring is set to other than the **A** (Auto) position or a lens without an **A** position or accessories such as an auto extension tube or auto bellows are used, the camera will not operate unless [27. Using Aperture Ring] is set to [Permitted] in the [**C** Custom Setting 4] menu. Refer to “Using the Aperture Ring” (p.299) for restrictions that apply.

Lens and Built-in Flash

The built-in flash cannot be regulated and fully discharges when the aperture ring is set to other than the **A** (Auto) position, pre A lenses or soft focus lenses are used.

Note that the built-in flash cannot be used as an Auto Flash.

Using the Aperture Ring

The shutter can be released even if the aperture ring of the D FA, FA, F or A lens is not set to the **A** position or a lens without an **A** position is attached.

Select [Permitted] in [27. Using Aperture Ring] of the [C Custom Setting 4] menu.

The following restrictions apply depending on the lens being used.

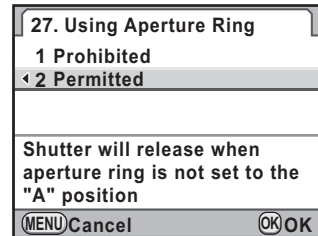

Lens Used	Exposure Mode	Restriction
D FA, FA, F, A, M (lens only or with auto diaphragm accessories such as auto extension tube K)	Av	The aperture remains open regardless of the aperture ring position. The shutter speed changes in relation to the open aperture but an exposure deviation may occur. [F--] appears for the aperture indicator.
D FA, FA, F, A, M, S (with diaphragm accessories such as extension tube K)	Av	Pictures can be taken with a set aperture value but an exposure deviation may occur. [F--] appears for the aperture indicator.
Manual diaphragm lens such as reflex lens (lens only)	Av	
FA SOFT 28mm, FA SOFT 85mm, F SOFT 85mm (lens only)	Av	Pictures can be taken with a set aperture value in the manual aperture range. [F--] appears for the aperture indicator. The exposure can be checked with Optical Preview.
All lenses	M	Pictures can be taken with a set aperture value and shutter speed. [F--] appears for the aperture indicator. The exposure can be checked with Optical Preview.



The camera operates in **Av** (Aperture Priority Automatic Exposure) mode even if the mode dial is at **M**, **P**, **Sv**, **Tv** or **TAv** when the aperture ring is set to other than the **A** position.

If the CMOS sensor becomes dirty or dusty, shadows may appear in the image in certain situations such as when shooting against a white background. This indicates that the CMOS sensor must be cleaned.

Removing Dust with Ultrasonic Vibrations (Dust Removal)

Dust adhering to the CMOS sensor is removed by applying ultrasonic vibrations to the filter on the front surface of the CMOS sensor.

- 1 Select [Dust Removal] in the [ Set-up 4] menu and press the four-way controller (▶).**

The [Dust Removal] screen appears.

- 2 Press the OK button.**

The Dust Removal function is activated. Set [Start-up Action] to (On) to turn the Dust Removal function on every time the camera is turned on.

When Dust Removal is completed, the camera returns to the [ Set-up 4] menu.

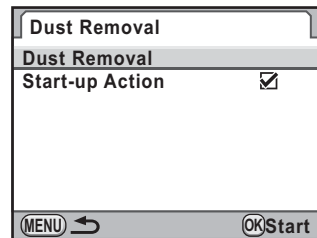

Detecting Dust on the CMOS Sensor (Dust Alert)

Dust Alert is a function that detects dust adhering to the CMOS sensor and visually displays the location of the dust.

You can save an image indicating the dust location and display it when performing sensor cleaning (p.303).

The following conditions must be met before using the Dust Alert function:

- A DA, DA L, FA J lens or a D FA, FA or F lens that has an **A** (Auto) position is attached.
- The aperture is set to the **A** position when using a lens with an aperture ring.
- The mode dial is set to any mode other than  (Movie).
- The focus mode switch is set to **AF.S** or **C**.



- The exposure time may be extremely long when using the Dust Alert function. Note that if the direction of the lens is changed before processing is complete, dust will not be detected properly.
- Depending on the subject conditions or temperature, dust may not be detected properly.
- The Dust Alert image can only be displayed during sensor cleaning within 30 minutes from the time the image is saved. If more than 30 minutes elapse, save a new Dust Alert image and then perform sensor cleaning.
- The saved Dust Alert image cannot be displayed in Playback mode.
- The Dust Alert image is saved only when an SD Memory Card is inserted.

1

Select [Dust Alert] in the [ Set-up 4] menu and press the four-way controller (▶).

The [Dust Alert] screen appears.

2 Fully display a white wall or other bright subject with no detail in the viewfinder and press the shutter release button fully.

After image processing is performed, the Dust Alert image appears.

If the message [The operation could not be completed correctly] is displayed, press the **OK** button and take another picture.

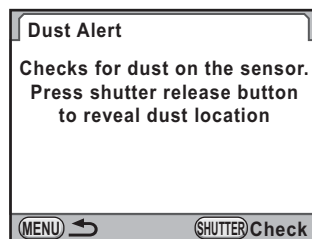

3 Check the sensor for dust.

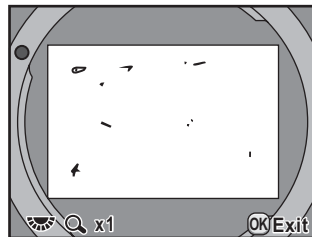

Available operations

Rear e-dial ()	Displays the Dust Alert image at full screen display.
---	---

4 Press the OK button.

The Dust Alert image is saved and the camera returns to the [ Set-up 4] menu.



Regardless of the camera settings, the Dust Alert image will be taken with specific shooting conditions.

Removing Dust with a Blower

Raise the mirror up and open the shutter when cleaning the CMOS sensor with a blower.

Please contact a PENTAX Service Center for professional cleaning because the CMOS sensor is a precision part. Cleaning services involve a fee.

You can use the optional Imagesensor Cleaning kit O-ICK1 when cleaning the CMOS sensor.



- Do not use a spray type blower.
- Do not perform Sensor Cleaning during Bulb shooting. The shutter may accidentally close and may cause damage to the camera's internal parts.
- To prevent dirt and dust from accumulating on the CMOS sensor, keep the lens mount cap on the camera when a lens is not attached.
- When the battery level is low, the message [Not enough battery power remaining to clean sensor] is displayed on the monitor.
- It is recommended to use the AC adapter kit (optional) when cleaning the sensor. If you are not using the AC adapter kit, please install the battery with ample capacity remaining. If the battery capacity becomes low during cleaning, a warning beep will sound. In this case, stop cleaning immediately.
- Do not put the tip of the blower inside the lens mount area. If the power is turned off, this may cause damage to the shutter, CMOS sensor and the mirror.



- The self-timer lamp blinks, and [MUP] and [CIn] appear on the LCD panel while cleaning the sensor.
- This camera may generate a vibration sound while cleaning the CMOS sensor. It is not a malfunction.

1 Turn the camera off and remove the lens.

2 Turn the camera on.

3 Select [Sensor Cleaning] in the [Set-up 4] menu and press the four-way controller (▶).

The [Sensor Cleaning] screen appears.

4 Press the four-way controller (▲) to select [Mirror Up] and press the OK button.

The mirror is locked in the up position. If you used Dust Alert to detect dust on the sensor within the last 30 minutes, the Dust Alert image appears on the monitor. Clean the sensor while checking the location of the dust.

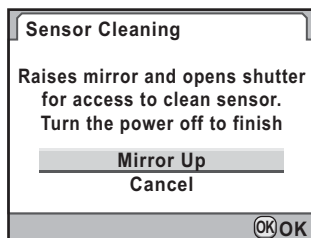

5 Clean the CMOS sensor.

Use a brush-less blower to remove dirt and dust from the CMOS sensor. Using a blower with a brush may scratch the CMOS sensor. Do not wipe the CMOS sensor with a cloth.

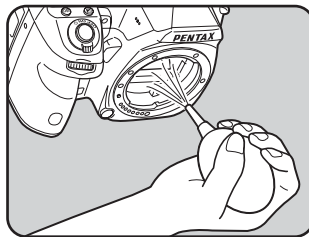



6 Turn off the camera.

The mirror automatically returns to its original position.

7 Attach the lens or body mount cover.

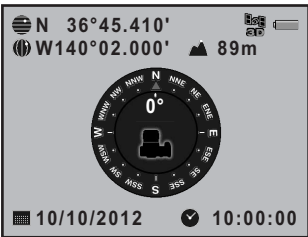
The following functions are available when the optional GPS unit O-GPS1 is attached to this camera.

Electronic Compass	Displays the latitude, longitude, altitude of the current location, lens direction and Coordinated Universal Time (UTC).	
Simple Navigation	Displays the direction and distance from the current location, based on the latitude and longitude of the set destination. You can save the GPS location information stored in a captured image as the destination or load the destination from a location information file created on a computer. (p.306)	
ASTROTRACER	Tracks and captures celestial bodies. By matching the movement of the camera's built-in shake reduction unit with the movement of celestial bodies, celestial bodies can be captured as individual points even when shooting with a long exposure setting. (p.308)	
Auto Time Synchron.	Automatically adjusts the camera's date and time settings using information acquired from GPS satellites.	



- Refer to the manual of the GPS unit for details on how to attach the unit and information on the unit's functions.
- If [GPS] is assigned to the **RAW/Fx** button, you can display the Electronic Compass, Simple Navigation, or ASTROTRACER screen by pressing the **RAW/Fx** button. (p.249)

Displaying the Distance and Direction to the Destination (Simple Navigation)

Saving the Destination

You can save the GPS location information stored in an image as the destination for Simple Navigation. Up to 38 destinations can be saved.

1 Press the four-way controller (▼) in Playback mode.

The playback mode palette appears.

2 Use the four-way controller (▲▼◀▶) to select (Save Destination) and press the OK button.

The screen to select an image appears and the GPS location information stored in the image is displayed.

If there are no images that have GPS location information stored, [No image can be processed] appears.

3 Use the four-way controller (◀▶) to select the image with the GPS location information you want to set as a destination, and press the OK button.

The [Destination Name] screen appears.



4 Enter the name of the destination to save.

Enter the name in the same way as [Copyright Information]. Refer to Step 4 on p.269.

Up to 18 single-byte characters can be entered.

When the name is set, the screen to save the destination data in the destination list appears.

5 Use the four-way controller (▲▼) to select the desired position in the destination list to save.

Turn the rear e-dial (🌀) to switch between pages.

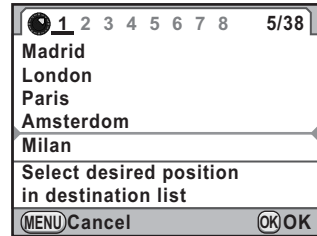

6 Press the OK button.

The save confirmation screen appears.

7 Use the four-way controller (▲▼) to select [Save] and press the OK button.

The screen that was displayed in Step 3 appears again.
Repeat Steps 3 to 7 to save other images.

8 Press the MENU button twice.



Destination list data can be stored on an SD Memory Card. The stored destination list files can also be edited on a computer. Refer to the manual of the GPS unit for details.

Starting the Navigation

1 Select [GPS] in the [📷 Rec. Mode 4] menu and press the four-way controller (▶).

The [GPS] screen appears.

2 Use the four-way controller (▲▼) to select [Simple Navigation] and press the four-way controller (▶).

The [Simple Navigation] screen appears.

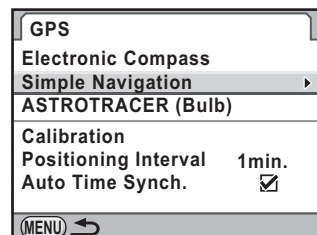

- 3** Use the four-way controller (▲▼) to select [Select Destination] and press the four-way controller (▶).

The destination selection screen appears.

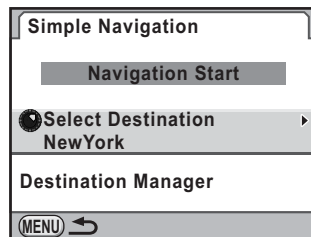

- 4** Use the four-way controller (▲▼) to select a destination.

Turn the rear e-dial (☀) to switch between pages.

- 5** Press the OK button.

The screen that was displayed in Step 3 appears again.

- 6** Use the four-way controller (▲▼) to select [Navigation Start] and press the OK button.

The current latitude, longitude, altitude, direction of the destination, distance to the destination, and Coordinated Universal Time (UTC) are displayed.

Press the shutter release button halfway to switch the camera to Capture mode.

Shooting Celestial Bodies (ASTROTRACER)

- 1** Set the mode dial to **B**.

- 2** Select [GPS] in the [📷 Rec. Mode 4] menu and press the four-way controller (▶).

The [GPS] screen appears.

- 3** Select [ASTROTRACER (Bulb)] and press the four-way controller (▶).

The [ASTROTRACER (Bulb)] screen appears.

- 4 To set the desired exposure time, first set [Timed Exposure] to (On).**

You can set the exposure time between 0'01" and 5'00" in [Exposure Time Preset].

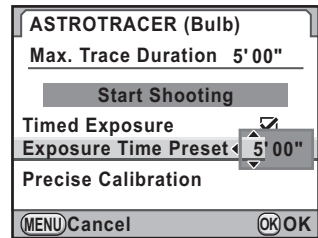

- 5 Use the four-way controller (▲▼) to select [Start Shooting] and press the OK button.**

- 6 Press the shutter release button fully.**

Shooting starts.



- 7 Press the shutter release button fully again.**

Exposure ends.

When [Timed Exposure] is enabled, shooting ends automatically after the set time has elapsed.

Error message	Description
Memory card full	The SD Memory Card is full and no more images can be saved. Insert a new SD Memory Card or delete unwanted images. (p.54, p.74) Data may be saved when you perform the following operations. <ul style="list-style-type: none"> • Change the file format to JPEG. (p.180) • Change the JPEG Recorded Pixels or JPEG Quality setting. (p.178, p.179)
No image	There are no images that can be played back on the SD Memory Card.
This image cannot be displayed	You are trying to play back an image in a format not supported by this camera. You may be able to play it back on another brand of camera or your computer.
No card in the camera	The SD Memory Card is not inserted in the camera. (p.54)
Cannot use this card	The inserted SD Memory Card is not compatible with this camera.
Memory card error	The SD Memory Card has a problem, and image capture and playback are impossible. It may be viewable on a computer but not with this camera.
Card is not formatted	The SD Memory Card you have inserted is unformatted or has been formatted on another device and is not compatible with this camera. Use the card after formatting it with this camera. (p.246)
Card is locked	The write-protect switch on an SD Memory Card you have inserted is locked. Unlock the SD Memory Card. (p.6)
The card is electronically locked	Data is protected by an SD Memory Card security feature.
This image cannot be enlarged	You are trying to enlarge an image that cannot be enlarged.
This image is protected	You are trying to delete an image that is protected. Remove protection from the image. (p.222)











Error message	Description
Battery depleted	The battery is exhausted. Install a fully charged battery in the camera. (p.49)
Not enough battery power remaining to clean sensor	Appears during sensor cleaning if the battery level is insufficient. Install a fully charged battery or use an AC adapter kit (optional). (p.52)
Not enough battery power remaining to activate Pixel Mapping	Appears during pixel mapping if the battery level is insufficient. Install a fully charged battery or use an AC adapter kit (optional). (p.52)
Image folder cannot be created	The maximum folder number (999) and file number (9999) are being used, and no more images can be saved. Insert a new SD Memory Card or format the card. (p.246)
Unable to store image	The image could not be saved because of an SD Memory Card error.
Settings not stored	The DPOF settings could not be saved because the SD Memory Card is full. Delete unwanted images and perform DPOF setting again. (p.74)
The operation could not be completed correctly	The camera was unable to measure the manual white balance (p.185) or detect dust on the sensor (p.301). Try the operation again.
No more images can be selected	You cannot select more than the maximum number of images for Index (p.215), Select & Delete (p.220), Developing Multiple RAW Images (p.240) and DPOF (p.271).
No image can be processed	There are no images that can be processed using Digital Filter (p.233) or RAW Development (p.238).
This image cannot be processed	Appears when you try to perform Save as Manual WB (p.187), Resize (p.230), Cropping (p.231), Digital Filter (p.233), or RAW Development (p.238) for images captured with other cameras, or when you try to perform Resize or Cropping for minimum file size images.
The camera failed to create an image	The creation of an index print image failed. (p.215)
Camera overheated. Disabling Live View temporarily to protect circuitry	Live View cannot be used because the camera's internal temperature is too high. Press the OK button and try using Live View again when the camera has cooled down.

Error message	Description
Cannot start Live View	Appears if Live View is started when [27. Using Aperture Ring] is set to [Prohibited] in the [C Custom Setting 4] menu and the lens aperture ring is set to a position other than A , or a lens without an A position is being used.
This function is not available in the current mode	You are trying to set a function that is not available when the exposure mode is set to  (Green) or  (Movie).

In rare cases, the camera may not operate correctly due to static electricity. This can be remedied by taking the battery out and putting it back in again. When the mirror remains in the up position, take the battery out and put it back in again. Then, the mirror will retract when the camera is turned on again. After these procedures are done, if the camera operates correctly, it does not require any repairs.

We recommend checking the following items before contacting a service center.

Problem	Cause	Remedy
The camera does not turn on	The battery is not installed	Check if a battery is installed. If not, install a fully charged battery.
	The battery power is low	Replace with a fully charged battery or use the AC adapter kit (optional). (p.52)
The shutter cannot be released	The lens aperture ring is set to other than the A position	Set the lens aperture ring to the A position or select [Permitted] in [27. Using Aperture Ring] of the [C Custom Setting 4] menu. (p.89, p.299)
	The built-in flash is charging	Wait until charging is finished.
	There is no available space on the SD Memory Card	Insert an SD Memory Card with available space or delete unwanted images. (p.54, p.74)
	Recording	Wait until recording is finished.
Autofocus does not work	The subject is difficult to focus on	Autofocus cannot focus well on subjects that have low contrast (the sky, white walls, etc.), dark colors, intricate designs, rapidly-moving objects or scenery shot through a window or a net-like pattern. Lock focus on another object located at the same distance as your subject, then aim at the target and press the shutter release button fully. Alternatively, use manual focus. (p.116)
	The subject is not in the focusing area	Position the subject in the focus frame in the middle of the viewfinder. If the subject is outside the focusing area, aim the camera at the subject and lock the focus, then compose a picture and press the shutter release button fully.
	The subject is too close	Move away from the subject and take a picture.

Problem	Cause	Remedy
Autofocus does not work	The focus mode is set to MF	Set the focus mode switch to A.F.S or C . (p.108)
The focus cannot be locked	The focus mode is set to A.F.C	Autofocus is not locked (focus lock) when the focus mode is set to A.F.C (C) . The camera will continue focusing on the subject while the shutter release button is pressed halfway. If there is a subject that you wish to focus on, slide the focus mode switch to A.F.S and use the focus lock. (p.108)
The AE Lock function does not operate	The exposure mode is set to  , B or X mode	Set the exposure mode to any mode other than  (Green), B (Bulb Exposure) or X (Flash X-sync Speed).
The built-in flash does not discharge	The exposure mode is set to  mode	Only  (Auto Flash Discharge) and  (Auto Flash+Red-eye Reduction) are available for the flash mode when the exposure mode is  (Green). The flash will not discharge when the subject is bright in these modes. In the exposure modes other than  , only the flash mode that discharges every time the flash recharges is available. Try different exposure modes.
The USB connection with a computer does not work properly	The USB connection mode is set to [PTP]	Set [USB Connection] to [MSC] in the [ Set-up 2] menu. (p.279)
Shake Reduction does not work	The Shake Reduction function is off	Set [Shake Reduction] to () (On) in the [ Rec. Mode 4] menu. (p.122)
	The Shake Reduction function is not set properly	If a lens for which the focal length information cannot be obtained is used, set the focal length in the [Input Focal Length] screen. (p.124)
	Shutter speed is too low for the Shake Reduction function to be effective when panning or shooting night scenes, etc.	Turn off the Shake Reduction function and use a tripod.
	The subject is too close	Move away from the subject, or turn off the Shake Reduction function and use a tripod.

Model Description

Type	TTL autofocus, auto-exposure SLR digital-still camera with built-in retractable P-TTL flash
Lens Mount	PENTAX KAF2 bayonet mount (AF coupler, lens information contacts, K-mount with power contacts)
Compatible Lens	KAF3, KAF2 (power zoom compatible), KAF, KA mount lenses

Image Capture Unit

Image Sensor	Primary color filter, CMOS, Size: 23.7 x 15.7 (mm)
Effective Pixels	Approx. 16.28 megapixels
Total Pixels	Approx. 16.93 megapixels
Dust Removal	Image sensor cleaning using ultrasonic vibrations "DR II" with the Dust Alert function
Sensitivity (Standard Output)	AUTO: 100 to 12800 (EV steps can be set to 1 EV, 1/2 EV or 1/3 EV), expandable to ISO 80 - 51200.
Image Stabilizer	Sensor-shift Shake Reduction

File Formats

File Formats	RAW (PEF/DNG), JPEG (Exif 2.30), DCF 2.0 compliant
Recorded Pixels	JPEG: 16M (4928×3264 pixels), 10M (3936×2624 pixels), 6M (3072×2048 pixels), 2M (1728×1152 pixels) RAW: 16M (4928×3264 pixels)
Quality Level	RAW (14bit): PEF, DNG JPEG: ★★★★★ (Premium), ★★★★★ (Best), ★★ (Better), ★ (Good), RAW + JPEG simultaneous capturing compatible
Color Space	sRGB, AdobeRGB
Storage Medium	SD, SDHC, and SDXC Memory Cards
Storage Folder	Date (100_1018,101_1019...)/ PENTX (100PENTX, 101PENTX...)

Viewfinder

Type	Pentaprism Finder
Coverage (FOV)	Approx. 100%
Magnification	Approx. 0.92× (50 mm F1.4 • ∞)
Eye-Relief Length	Approx. 21.7 mm (from the view window), Approx. 24.5 mm (from the center of lens)
Diopter Adjustment	Approx. -2.5 to +1.5m ⁻¹
Focusing Screen	Interchangeable Natural-Bright-Matte III focusing screen

Live View

Type	TTL method using CMOS image sensor
Focusing Mechanism	Contrast detection + Face detection, Contrast detection, Phase matching
Display	Field of View approx. 100%, Magnified view (AF mode: 2×, 4×, 6×/ MF mode: 2×, 4×, 6×, 8×, 10×), Grid display (4×4 Grid, Golden Section, Scale display), Bright/dark area warning, Histogram

LCD Monitor

Type	Wide viewing angle TFT color LCD with AR coating and air gapless glass
Size	3.0 inches
Dots	Approx. 921,000 dots
Adjustment	Brightness and colors adjustable

Preview

Type	Optical preview, digital preview
------	----------------------------------

White Balance

Auto	Method using a combination of the CMOS sensor and the light-source detection sensor
Preset	Daylight, Shade, Cloudy, Fluorescent Light (D : Daylight Color, N : Daylight White, W : Cool White, L : Warm White), Tungsten Light, Flash, CTE , Manual, Color Temperature
Manual	Configuration using the display screen (up to 3 settings can be saved), Color Temperature settings (up to 3 settings can be saved), Copying the white balance settings of a captured image
Fine Adjustment	Adjustable ± 7 steps on A-B axis and/or G-M axis

Autofocus System

Type	TTL: phase-matching autofocus
Focus Sensor	SAFOX X, 11 points (9 cross type focus points in the center)
Brightness Range	EV -3 to 18 (ISO100, at normal temperature)
AF Mode	Single AF (A.F.S), Continuous AF (A.F.C) Focus priority or shutter priority mode for A.F.S Focus priority or FPS priority mode for A.F.C
AF Point Selection	Auto: 5 points, Auto: 11 points, Select (Expanded Area AF is available), Center
AF Assist Light	Dedicated LED AF assist light

Exposure Control

Type	TTL open aperture, 77 segmented metering, center-weighted and spot metering
Metering Range	EV 0 to 22 (ISO100 50mm F1.4)

Exposure Mode	Green, Program, Sensitivity Priority, Shutter Priority, Aperture Priority, Shutter & Aperture Priority, Manual, Bulb, Flash X-sync Speed
EV Compensation	±5 EV (1/2 EV steps or 1/3 EV steps can be selected)
AE Lock	Available via dedicated AE Lock button (timer type: two times the meter operating time set in Custom Setting); Continuous as long as the shutter button is halfway pressed.

Shutter

Type	Electronically controlled vertical-run focal-plane shutter
Shutter Speed	Auto: 1/8000 to 30 sec., Manual: 1/8000 to 30 sec. (1/3 EV steps or 1/2EV steps), Bulb

Drive Modes

Mode Selection	Single frame, Continuous (Hi, Lo), Self-timer (12s, 2s), Remote Control (immediately, 3 sec., continuous), Auto Bracketing (2, 3 or 5 frames), Auto Bracketing + Self-timer, Auto Bracketing + Remote Control, Mirror Lock-up, Mirror Lock-up + Remote Control
Continuous Shooting	Max. approx. 7.0 fps, JPEG (16M • ★★ ★ • Continuous Hi): up to approx. 30 frames, RAW: up to approx. 20 frames Max. approx. 1.6 fps, JPEG (16M • ★★ ★ • Continuous Lo): until SD Memory Card is full, RAW: up to approx. 40 frames

Flash

Built-in Flash	Built-in retractable P-TTL pop-up flash, GN: approx. 13 (ISO100/m) Angle of view: equivalent to angle of view of 28mm lens (35mm format equivalent)
Flash Mode	P-TTL, Red-eye Reduction, Slow-speed Sync, Trailing Curtain Sync; High-Speed Sync and Wireless Sync are available with PENTAX dedicated external flash.
Sync Speed	1/180 sec.
Flash Exposure Compensation	-2.0 to +1.0 EV

Capture Functions

Custom Image	Bright, Natural, Portrait, Landscape, Vibrant, Muted, Bleach Bypass, Reversal Film, Monochrome
Noise Reduction	Slow Shutter Speed NR, High-ISO NR
Dynamic Range Setting	Highlight Correction, Shadow Correction
Lens Correction	Distortion Correction, Lateral Chromatic Aberration Correction
Cross Processing	Random, Preset 1-3, Favorite 1-3
Digital Filter	Toy Camera, Retro, High Contrast, Extract Color, Soft, Starburst, Fish-eye, Custom Filter
HDR Capture	Auto, Standard, Strong 1, Strong 2, Strong 3 Auto Align (automatic composition correction)

Multi-exposure	Select the number of shots between 2 and 9. Exposure adjusted automatically. (Auto EV Adjustment)
Interval Shooting	Capture Interval setting (1 sec. to 24 hr.), Start Interval setting (immediate, designated time), Captures up to 999 images
Extended Bracketing	White Balance, Saturation, Hue, High/Low Key Adj, Contrast, Sharpness
Horizon Correction	SR On: adjusts up to 1 degree, SR Off: adjusts up to 2 degrees
Composition Adjustment	Adjustment range of ± 1.5 mm up, down, left or right (± 1 mm when rotated); rotating range of ± 1 degree
Electronic Level	Displayed on LCD panel or in viewfinder (horizontal direction only); displayed on monitor (horizontal direction and vertical direction)

Movie

File Format	Motion JPEG (AVI)
Recorded Pixels	FullHD (1920×1080, 16:9, 25 fps), HD (1280×720, 16:9, 30 fps/25 fps), VGA (640×480, 4:3, 30 fps/25 fps)
Quality Level	★★★ (Best), ★★ (Better), ★ (Good)
Sound	Built-in monaural microphone, external stereo microphone terminal
Recording Time	Up to 25 minutes; automatically stops recording if the internal temperature of the camera becomes high.
Custom Image	Bright, Natural, Portrait, Landscape, Vibrant, Muted, Bleach Bypass, Reversal Film, Monochrome
Cross Processing	Random, Preset 1-3, Favorite 1-3
Digital Filter	Toy Camera, Retro, High Contrast, Extract Color, Color

Playback Functions

Playback View	Single frame, multi-image display (4, 9, 16, 36, 81 segmentation), display magnification (up to 32x, scrolling and quick magnification available), rotating, histogram (Y histogram, RGB histogram), bright/dark area warning, auto image rotation, detailed information display, copyright information display (photographer, copyright holder), GPS data (latitude, longitude, altitude, direction, Coordinated Universal Time (UTC)), folder display, calendar display, slideshow
Delete	Delete single image, delete all, select & delete, delete folder, delete instant review image
Digital Filter	Toy Camera, Retro, High Contrast, Sketch Filter, Water Color, Pastel, Posterization, Miniature, Base Parameter Adjustment, Monochrome, Color, Extract Color, Soft, Starburst, Fish-eye, Slim, HDR, Custom Filter
RAW Development	File Format (JPEG, TIFF), Recorded Pixels, Quality Level, Custom Image, White Balance, Sensitivity, High-ISO NR, Shadow Correction, Distortion Correction, Lateral Chromatic Aberration Correction, Color Space

Edit	Resize, Cropping (aspect ratio can be changed, and tilt correction is available), Index, Movie Edit (Divide or delete selected frames), Capturing a JPEG still picture from a movie, Saving RAW data from JPEG (if available in buffer memory)
------	--

Customization

User Mode	Up to 5 settings can be saved.
Custom Functions	27 items
Mode Memory	13 items
E-Dial Programming	Electronic dials (front/rear): customizable to each exposure mode.
Custom Button	RAW/Fx button (One Push File Format, Exposure Bracketing, Digital Preview, Electronic Level, Composition Adjustment, GPS) AF button (Enable AF, Cancel AF)
Text Size	Standard, Large
World Time	World Time settings for 75 cities (28 time zones)
AF Fine Adjustment	±10 steps, adjustment for all lenses or individual lenses (up to 20 can be saved)
Copyright Information	Names of "Photographer" and "Copyright Holder" are embedded to the image file. Revision history can be checked using the provided software.

Power Supply

Battery Type	Rechargeable Lithium-ion Battery D-LI90
AC Adapter	AC Adapter kit K-AC132 (optional)
Battery Life	Number of recordable images (with 50% flash usage): approx. 740 images, (without flash usage): approx. 980 images Playback time: approx. 440 minutes * Tested in compliance with CIPA standard using a new rechargeable lithium-ion battery under the temperature of 23°C. Actual results may vary depending on the shooting conditions/circumstances.

Interfaces

Connection Port	USB 2.0 (high-speed compatible)/AV output, DC input, Cable switch, X-sync socket, HDMI output, Stereo microphone
USB Connection	MSC/PTP
Video Output Format	NTSC/PAL

Dimensions and Weight

Dimensions	Approx. 131 mm (W) × 97 mm (H) × 72.5 mm (D) (excluding protrusions)
Weight	Approx. 680 g (body only), Approx. 760 g (including dedicated battery and SD Memory Card)

Accessories

Package Contents	USB Cable I-USB7, AV Cable I-AVC7, Strap O-ST132, ME Viewfinder Cap, Rechargeable Lithium-ion Battery D-LI90, Battery Charger D-BC90, AC plug cord, Software (CD-ROM) S-SW132 <Mounted on the camera> Eyecup FR, Hot shoe cover Fk, Body mount cover, Sync socket 2P cap
Software	PENTAX Digital Camera Utility 4

● Approximate Image Storage Capacity and Playback Time

When using the fully charged battery

Battery (Temperature)	Normal Recording	Flash Photography		Playback Time
		50% Use	100% Use	
D-LI90 (23°C)	980	740	610	440 minutes
(0°C)	810	680	560	400 minutes

The image storage capacity (normal recording and flash use 50%) is based on measuring conditions in accordance with CIPA standards, while other data is based on our measuring conditions. Some deviation from the above figures may occur in actual use depending on the selected capture mode and shooting conditions.











● Approximate Image Storage Capacity by Size

When using a 2 GB SD Memory Card

Recorded Pixels	JPEG Quality				RAW
	★★★★	★★★	★★	★	
16M (4928×3264)	134	214	379	749	58
10M (3936×2624)	208	332	585	1138	—
6M (3072×2048)	339	543	945	1807	—
2M (1728×1152)	1041	1617	2793	5121	—

The number of storable images may vary depending on the subject, shooting conditions, selected capture mode and SD Memory Card, etc.

Symbols

-  (EV Compensation) button
..... 21, 24, 105
-  (Flash pop-up) button
..... 22, 72
-  (Playback) button
..... 22, 24, 73
-  (Green) button 22, 24
-  (Delete) button 24, 74
-  [Rec. Mode] Menu 79, 288
-  [Playback] Menu 209, 292
-  [Set-up] Menu 244, 293
-  [C Custom Setting] Menu
..... 81, 294
-  (Green) mode 66, 90
-  (Preview) 118

A

- AC adapter 52
- Adding the date 272
- AdobeRGB 189
- AE Lock 107, 115
- AE Metering 103
- AE-L** button 22, 24, 100, 107
- AF Assist Light 20, 67, 109
- AF** (Autofocus) 108
- AF** button 22, 110, 250
- AF coupler 20
- AF Fine Adjustment 111
- AF frame 67
- AF point switching dial ... 22, 113
- Aperture Priority Automatic
Exposure Mode **Av** 95
- Aperture ring 89
- Aspect Ratio 152, 231
- ASTROTRACER 308
- Auto Bracketing 138
- Auto Image Rotation 210



- Auto Power Off 266
- Auto Screen Rotation 259
- Auto Time Synch. 305
- AWB** (White Balance) 183
- Autofocus **AF** 108
- Autofocus Method 147
- Automatic sensitivity correction
..... 84
- Av** (Aperture Priority Automatic
Exposure) mode 95
- AV cable 224
- AV device 224

B

- B** (Bulb Exposure) mode 101
- Base Parameter Adj (Digital
Filter) 233
- Battery 49
- Battery grip contacts 20
- Beep 252
- Bleach Bypass (Custom Image)
..... 197
- Bright (Custom Image) 197
- Bright portions 190
- Bright/Dark Area warning
..... 148, 210, 260
- Brightness adjustment 190
- Brightness Level 260
- Brightness of the monitor 260
- Built-in flash 69
- Bulb Exposure mode **B** 101
- Button Customization 249

C

- Cable release terminal 20
- Cable switch 102
- Calendar display 214
- Card access lamp 20

Catch-in Focus	117	
Center-weighted metering	103	
Charging the battery	49	
City names	255	
Cloudy (White Balance)	183	
Color (Digital Filter)	144, 234	
Color of the monitor	261	
Color Space	189	
Color Temperature	188	
Composition Adjustment	195	
Computer	277	
Continuous mode	109	
Continuous Shooting	132	
Contrast (Custom Image)	198	
Contrast AF	147	
Contrast-Control-Sync mode (Flash)	174	
Control panel	28, 41	
Copyright Holder	269	
Creating folders	263	
Cropping	231	
Cross Processing	200	
CTE (White Balance)	183	
Custom Filter (Digital Filter)	144, 234	
Custom Image	197	
[C Custom Setting] Menu	81, 294	
Customizing buttons and dials	247	
D		
Dark portions	190	
Date Adjustment	62, 253	
Daylight (White Balance)	183	
DC input terminal	53	
Default settings	288	
Delete	74, 220	
Delete all images	222	
 (Delete) button	24, 74	
Delete folder	221	
Deleting a single image		74
Destination	253	
Detailed information display	31	
Developing RAW images	238	
Digital Filter	143, 233	
Digital Preview	120	
Diopter adjustment	58	
Direct keys	40, 78, 288	
Display Color	259	
Display language	256	
Displaying multiple images	212	
Distortion	193	
DNG	181	
DPOF	271	
D-Range Setting	190	
Drive Mode	78	
DST	254	
Dust Alert	301	
Dust Removal	300	
Dynamic Range	190	
E		
E-Dial Programming	247	
E-dials	247	
Electronic Compass	305	
Electronic Level	29, 39, 262	
Enlarge Instant Review	260	
Enlarging images	211	
Error message	310	
EV Compensation	105	
 (EV Compensation) button	21, 24, 105	
EV Steps	106	
Exif	269	
Expanded Area AF	115	
Exposure	83	
Exposure Bracketing	138	
Exposure Mode	45, 88	
Exposure warning	95, 96, 98	

- Extended Bracketing 141
- External flash 167
- Extract Color (Digital Filter)
 - 143, 234
- Eyecup 58
- F**
- Face Detection AF 147
- File Format 180
- File Name 264
- File number 265
- Filter 143, 233
- Filter Effect (Custom Image)
 - 199
- Fish-eye (Digital Filter)
 - 143, 234
- Flash 69, 161
- Flash (White Balance) 183
- Flash Exposure Compensation
 - 71
- ⚡ (Flash pop-up) button
 - 22, 72
- Flash X-sync Speed mode **X**
 - 102
- Fluorescent Light (White Balance) 183
- Focus indicator 67, 116
- Focus lock 67
- Focus Mode 108
- Focus mode switch 22, 108
- Focus point 113
- Focusing 108
- Folder display 213
- Folder Name 263
- Format 246
- Four-way controller (▲▼◀▶)
 - 23, 24
- Frame rate 152
- Front e-dial 21, 24
- G**
- GPS unit 305
- Green button 22, 24
- Green mode 66, 90
- Guide Display 25, 257
- Guide indicator 35
- Guide number 165
- H**
- HDMI Out 227
- HDMI terminal 226
- HDR (Digital Filter) 234
- HDR Capture 191
- Help 285
- High Contrast (Digital Filter)
 - 143, 233
- High dynamic range shooting
 - 191
- High/Low Key Adjustment (Custom Image) 198
- High-ISO NR 85
- Highlight Correction 190
- High-Speed Flash Sync mode (Flash) 169
- Histogram 33, 148, 260
- Hometown 60, 253
- Horizon Correction 123
- Hot shoe 20
- Hue (Custom Image) 198
- I**
- Image finishing tone 197
- Image plane indicator 20
- Image Rotation 219
- Image storage capacity 320
- Index 215
- INFO** button
 - 22, 24, 26, 30, 73
- Info Overlay 148
- Initial settings 60
- Initializing 246
- Input Focal Length 124
- Installing software 281
- Instant Review 67, 259

- Interval Shooting 133
- ISO** button 21, 83
- ISO sensitivity 83
- J**
- JPEG Quality 179
- JPEG Recorded Pixels 178
- K**
- Kelvin 188
- L**
- Landscape (Custom Image)
..... 197
- Language setting 60, 256
- Lateral chromatic aberration
..... 193
- LCD Color Tuning 261
- LCD panel 38
- Lens 56, 297
- Lens Correction 193
- Lens information contacts 20
- Lens mount index 20
- Lens unlock button 22, 57
- Live View 146
- Locking the exposure ... 107, 115
- LV** button 22, 149
- M**
- M** (Manual Exposure) mode
..... 98
- Macintosh 278
- Main switch 21, 24, 59
- Manual focus **MF** 116
- Matte field 117
- Memory 274
- Memory card 54
- MENU** button 23, 24, 42
- Menu operation 42
- Menu page display 258
- Meter Operating Time 104
- Metering mode switch
..... 22, 103
- MF** (Manual focus) 116
- Microphone 20, 154
- Miniature (Digital Filter) 233
- Mired 188
- Mirror 20
- Mirror Up 130, 304
- Mode dial 22, 45
- Mode dial lock button 22
- Monitor 25
- Monochrome (Custom Image)
..... 197
- Monochrome (Digital Filter)
..... 233
- Movie 152
- Movie Aperture Control 153
- Movie Editing 159
- Movie playback 157
- MSC 279
- Multi-exposure 136
- Multi-image display 212
- Multiple flash shooting 173
- Multi-segment metering 103
- Muted (Custom Image) 197
- N**
- Natural (Custom Image) 197
- Noise Reduction 85
- NTSC 225
- O**
- OK** button 22, 24
- One Push File Format 181
- Optical Preview 120
- P**
- P** (Program Automatic
Exposure) Mode 91
- PAL 225
- Pastel (Digital Filter) 233
- PC/AV terminal 224, 280

- PEF 181
- PENTAX Digital Camera
- Utility 4 281
- Phase Difference AF 147
- Photographer information 269
- Pixel Mapping 273
- Pixels 152, 178
- Playback 73
- ▶ (Playback) button
..... 22, 24, 73
- Playback display 30
- Playback mode palette
..... 208, 292
- Playback time 320
- Playing back images
continuously 217
- Portrait (Custom Image) 197
- Posterization (Digital Filter)
..... 233
- Power supply 59
- Preview 118
- Preview Dial 250
- Printing 271
- Product registration 286
- Program Automatic Exposure
mode **P** 91
- Program Line 89
- Protect 222
- Provided software 281
- PTP 279
- P-TTL (Flash) 168
- Q**
- Quality Level 152, 179
- Quick Zoom 210
- R**
- RAW 180
- RAW Development 238
- RAW File Format 181
- RAW/Fx** button 22, 181, 250
- Rear e-dial 22, 24
- Recorded Pixels 152, 178
- Remote Control 127
- Reset 296
- Resize 230
- Retro (Digital Filter) 143, 233
- Reversal Film (Custom Image)
..... 197
- Rotating images 219
- S**
- Saturation (Custom Image)
..... 198
- Save as Manual WB 187
- Save Destination 306
- Save RAW data 33, 74
- Save Settings as USER 202
- SD Memory Card 54
- Select & Delete 220
- Select Battery 267
- Self-timer 125
- Sensitivity 83
- Sensitivity Priority Automatic
Exposure mode **Sv** 92
- Sensor Cleaning 300, 303
- Shade (White Balance) 183
- Shadow Correction 190
- Shake Reduction 122, 153
- Sharpness (Custom Image)
..... 198
- Shooting celestial bodies 308
- Shooting information 26
- Show Grid 148
- Shutter & Aperture Priority
Automatic Exposure mode **TAv**
..... 97
- Shutter Button Half Press 251
- Shutter Priority Automatic
Exposure mode **Tv** 94
- Shutter release button
..... 21, 24
- Simple Navigation 306

Single mode	109	Video input terminal	224
Sketch Filter (Digital Filter) ...	233	Video output format	225
Slideshow	217	Viewfinder	36, 58
Slim (Digital Filter)	234	Vignetting	69
Slow Shutter Speed NR	87	W	
Slow-speed Sync	162	Water Color (Digital Filter) ...	233
Soft (Digital Filter)	143, 234	White Balance	183
Software	281	Windows	278
Sound	153, 252	Wireless Mode (Flash)	170
Speaker	20	World Time	253
Spot Metering	104	Write-protect	6
sRGB	189	X	
Starburst (Digital Filter)		X (Flash X-sync Speed) mode	
.....	143, 234	102
Status screen	27, 258	X-sync socket	175
Strap	48	Z	
Superimpose AF Area	37, 113	Zoom lens	68
Sv (Sensitivity Priority Automatic			
Exposure) mode	92		
T			
TAv (Shutter & Aperture Priority			
Automatic Exposure) mode	97		
Text Size	61, 257		
Toning (Custom Image)	198		
Toy Camera (Digital Filter)			
.....	143, 233		
Trailing Curtain Sync	164		
Tungsten Light (White Balance)			
.....	183		
TV	224		
Tv (Shutter Priority Automatic			
Exposure) mode	94		
U			
USB cable	280		
USB Connection	279		
USER Mode	202		
V			
Vertical position	30		
Vibrant (Custom Image)	197		

All PENTAX cameras purchased through authorized bona fide photographic distribution channels are guaranteed against defects of material or workmanship for a period of twelve months from date of purchase. Service will be rendered, and defective parts will be replaced without cost to you within that period, provided the equipment does not show evidence of impact, sand or liquid damage, mishandling, tampering, battery or chemical corrosion, operation contrary to operating instructions, or modification by an unauthorized repair shop. The manufacturer or its authorized representatives shall not be liable for any repair or alterations except those made with its written consent and shall not be liable for damages from delay or loss of use or from other indirect or consequential damages of any kind, whether caused by defective material or workmanship or otherwise; and it is expressly agreed that the liability of the manufacturer or its representatives under all guarantees or warranties, whether expressed or implied, is strictly limited to the replacement of parts as hereinbefore provided. No refunds will be made on repairs by non-authorized PENTAX service facilities.

Procedure During 12-month Warranty Period

Any PENTAX which proves defective during the 12-month warranty period should be returned to the dealer from whom you purchased the equipment or to the manufacturer. If there are no representatives of the manufacturer in your country, send the equipment to the manufacturer, with postage prepaid. In this case, it will take a considerable length of time before the equipment can be returned to you owing to the complicated customs procedures required. If the equipment is covered by warranty, repairs will be made and parts replaced free of charge, and the equipment will be returned to you upon completion of servicing. If the equipment is not covered by warranty, regular charges of the manufacturer or of its representatives will apply. Shipping charges are to be borne by the owner. If your PENTAX was purchased outside of the country where you wish to have it serviced during the warranty period, regular handling and servicing fees may be charged by the manufacturer's representatives in that country. Notwithstanding this, your PENTAX returned to the manufacturer will be serviced free of charge according to this procedure and warranty policy. In any case, however, shipping charges and customs clearance fees to be borne by the sender. To prove the date of your purchase when required, please keep the receipt or bills covering the purchase of your equipment for at least a year. Before sending your equipment for servicing, please make sure that you are sending it to the manufacturer's authorized

representatives or their approved repair shops, unless you are sending it directly to the manufacturer. Always obtain a quotation for the service charge, and only after you accept the quoted service charge, instruct the service station to proceed with the servicing.

- **This warranty policy does not affect the customer's statutory rights.**
- **The local warranty policies available from PENTAX distributors in some countries can supersede this warranty policy. Therefore, we recommend that you review the warranty card supplied with your product at the time of purchase, or contact the PENTAX distributor in your country for more information and to receive a copy of the warranty policy.**



The CE Mark is a Directive conformity mark of the European Union.

For customers in USA

STATEMENT OF FCC COMPLIANCE

This device complies with Part 15 of the FCC Rules. Operation is subject to the following two conditions: (1) This device may not cause harmful interference, and (2) this device must accept any interference received, including interference that may cause undesired operation.

Changes or modifications not approved by the party responsible for compliance could void the user's authority to operate the equipment.

This equipment has been tested and found to comply with the limits for a Class B digital device, pursuant to part 15 of the FCC Rules.

These limits are designed to provide reasonable protection against harmful interference in a residential installation. This equipment generates, uses and can radiate radio frequency energy and, if not installed and used in accordance with the instructions, may cause harmful interference to radio communications. However, there is no guarantee that interference will not occur in a particular installation.

If this equipment does cause harmful interference to radio or television reception, which can be determined by turning the equipment off and on, the user is encouraged to try to correct the interference by one or more of the following measures:

- Reorient or relocate the receiving antenna.
- Increase the separation between the equipment and receiver.
- Connect the equipment into an outlet on a circuit different from that to which the receiver is connected.
- * Consult the dealer or an experienced radio/TV technician for help.

For customers in Canada

This Class B digital apparatus complies with Canadian ICES-003.

Pour les utilisateurs au Canada

Cet appareil numérique de la classe B est conforme à la norme NMB-003 du Canada.

FOR CALIFORNIA, U.S.A. ONLY

Perchlorate Material-special handling may apply.

The lithium battery used in this camera contains perchlorate material, which may require special handling.

See www.dtsc.ca.gov/hazardouswaste/perchlorate

Declaration of Conformity

According to 47CFR, Parts 2 and 15 for Class B Personal Computers and Peripherals

We: PENTAX RICOH IMAGING AMERICAS
CORPORATION

Located at: 633 17th Street, Suite 2600
Denver, Colorado 80202 U.S.A.
Phone: 800-877-0155 FAX: 303-790-1131

Declare under sole responsibility that the product identified herein complies with 47CFR Parts 2 and 15 of the FCC rules as a Class B digital device. Each product marketed is identical to the representative unit tested and found to be compliant with the standards. Records maintained continue to reflect the equipment being produced can be expected to be within the variation accepted, due to quantity production and testing on the statistical basis as required by 47CFR §2.909. Operation is subject to the following two conditions: (1) This device may not cause harmful interference, and (2) This device must accept any interference received, including interference that may cause undesired operation. The above named party is responsible for ensuring that the equipment complies with the standards of 47CFR §15.101 to §15.109.

Product Name: Digital Single Lens Reflex Camera

Model Number: K-5 II/K-5 II s

Contact person: Customer Service Manager

Date and Place: September, 2012, Colorado

Information for Users on Collection and Disposal of Old Equipment and Used Batteries



1. In the European Union

These symbols on the products, packaging and/or accompanying documents mean that used electrical and electronic equipment and batteries should not be mixed with general household waste.

Used electrical/electronic equipment and batteries must be treated separately and in accordance with legislation that requires proper treatment, recovery and recycling of these products.



By disposing of these products correctly you will help ensure that the waste undergoes the necessary treatment, recovery and recycling and thus prevent potential negative effects on the environment and human health which could otherwise arise due to inappropriate waste handling.

If a chemical symbol is added beneath the symbol shown above, in accordance with the Battery Directive, this indicates that a heavy metal (Hg = Mercury, Cd = Cadmium, Pb = Lead) is present in the battery at a concentration above an applicable threshold specified in the Battery Directive.

For more information about collection and recycling of used products, please contact your local authorities, your waste disposal service or the point of sale where you purchased the products.

2. In other countries outside the EU

These symbols are only valid in the European Union. If you wish to discard used products, please contact your local authorities or dealer and ask for the correct method of disposal.

For Switzerland: Used electrical/electronic equipment can be returned free of charge to the dealer, even when you don't purchase a new product. Further collection facilities are listed on the home page of www.swico.ch or www.sens.ch.

Memo

Memo

PENTAX RICOH IMAGING CO., LTD.

2-35-7, Maeno-cho, Itabashi-ku, Tokyo 174-8639, JAPAN
(<http://www.pentax.jp>)

**PENTAX RICOH IMAGING
FRANCE S.A.S.
(European Headquarters)**

112 Quai de Bezons, B.P. 204, 95106 Argenteuil Cedex,
FRANCE
(HQ - <http://www.pentax.eu>)
(France - <http://www.pentax.fr>)

**PENTAX RICOH IMAGING
DEUTSCHLAND GmbH**

Julius-Vosseler-Strasse 104, 22527 Hamburg,
GERMANY
(<http://www.pentax.de>)

**PENTAX RICOH IMAGING
UK LTD.**

PENTAX House, Heron Drive, Langley, Slough, Berks
SL3 8PN, U.K.
(<http://www.pentax.co.uk>)

**PENTAX RICOH IMAGING
AMERICAS CORPORATION**

633 17th Street, Suite 2600, Denver, Colorado 80202,
U.S.A.
(<http://www.pentaximaging.com>)

**PENTAX RICOH IMAGING
CANADA INC.**

1770 Argentia Road Mississauga, Ontario L5N 3S7,
CANADA
(<http://www.pentax.ca>)

**PENTAX RICOH IMAGING
CHINA CO., LTD.**

23D, Jun Yao International Plaza, 789 Zhaojiabang Road,
Xu Hui District, Shanghai, 200032, CHINA
(<http://www.pentax.com.cn>)

<http://www.pentax.jp/english>

- Specifications and external dimensions are subject to change without notice.

Free Manuals Download Website

<http://myh66.com>

<http://usermanuals.us>

<http://www.somanuals.com>

<http://www.4manuals.cc>

<http://www.manual-lib.com>

<http://www.404manual.com>

<http://www.luxmanual.com>

<http://aubethermostatmanual.com>

Golf course search by state

<http://golfingnear.com>

Email search by domain

<http://emailbydomain.com>

Auto manuals search

<http://auto.somanuals.com>

TV manuals search

<http://tv.somanuals.com>