

PENTAX

EN

Digital Camera

K-01

Operating Manual

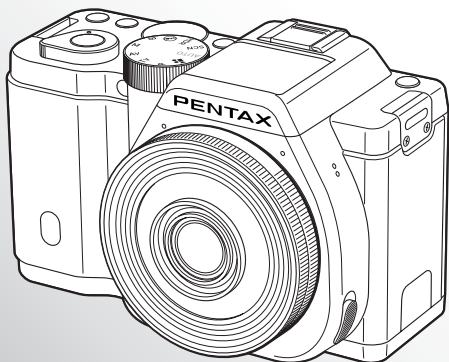

SILKYPIX[®]
The Excellent digital development technology



HDMI[™]
HIGH-DEFINITION MULTIMEDIA INTERFACE

To ensure the best performance from your camera, please read the Operating Manual before using the camera.

Download from www.Somanuals.com. All Manuals Search And Download.

Thank you for purchasing this PENTAX **JC-01** Digital Camera. Please read this manual before using the camera in order to get the most out of all the features and functions. Keep this manual safe, as it can be a valuable tool in helping you to understand all the camera's capabilities.

Lenses you can use

In general, lenses that can be used with this camera are DA, DA L, D FA and FA J lenses and lenses that have an **A** (Auto) position on the aperture ring. To use any other lens or accessory, see p.47 and p.232.

Regarding copyrights

Images taken with the **JC-01** that are for anything other than personal enjoyment cannot be used without permission according to the rights as specified in the Copyright Act. Please take care, as there are cases where limitations are placed on taking pictures even for personal enjoyment during demonstrations, performances or of items on display. Images taken with the purpose of obtaining copyrights also cannot be used outside the scope of use of the copyright as laid out in the Copyright Act, and care should be taken here also.

Regarding trademarks

Microsoft and Windows are registered trademarks of Microsoft Corporation in the United States and other countries. Windows Vista is either a registered trademark or trademark of Microsoft Corporation in the United States and/or other countries. Macintosh, Mac OS, and QuickTime are trademarks of Apple Inc., registered in the U.S. and other countries.

SDXC Logo is a trademark of SD-3C, LLC.

This product includes DNG technology under license by Adobe Systems Incorporated. The DNG logo is a either registered trademark or trademark of Adobe Systems Incorporated in the United States and/or other countries.

HDMI, the HDMI logo and High-Definition Multimedia Interface are trademarks or registered trademarks of HDMI Licensing, LLC in the United States and/or other countries.

All other brands or product names are trademarks or registered trademarks of their respective companies. However, the TM or ® marks are not used in all cases in this manual.

This product supports PRINT Image Matching III. PRINT Image Matching enabled digital still cameras, printers and software help photographers to produce images more faithful to their intentions. Some functions are not available on printers that are not PRINT Image Matching III compliant.

Copyright 2001 Seiko Epson Corporation. All Rights Reserved. PRINT Image Matching is a trademark of Seiko Epson Corporation. The PRINT Image Matching logo is a trademark of Seiko Epson Corporation.

This product is licensed under the AVC Patent Portfolio License for the personal use of a consumer or other uses in which it does not receive remuneration to (i) encode video in compliance with the AVC standard ("AVC video") and/or (ii) decode AVC video that was encoded by a consumer engaged in a personal activity and/or was obtained from a video provider licensed to provide AVC video. No license is granted or shall be implied for any other use. Additional information may be obtained from MPEG LA, L.L.C.

See <http://www.mpegla.com>

To users of this camera

- Do not use or store this camera in the vicinity of equipment that generates strong electromagnetic radiation or magnetic fields. Strong static charges or the magnetic fields produced by equipment such as radio transmitters could interfere with the monitor, damage the stored data, or affect the camera's internal circuitry and cause camera misoperation.
- The liquid crystal panel used for the monitor is manufactured using extremely high precision technology. Although the level of functioning pixels is 99.99% or better, you should be aware that 0.01% or fewer of the pixels may not illuminate or may illuminate when they should not. However, this has no effect on the recorded image.
- There is a possibility that the illustrations and the display screen of the monitor in this manual are different from the actual ones.
- In this manual, SD Memory Cards, SDHC Memory Cards and SDXC Memory Cards are referred to as SD Memory Cards.
- In this manual, the generic term "computer(s)" refers to either a Windows PC or a Macintosh hereafter.
- In this manual, the term "battery(ies)" refers to any type of batteries used for this camera and its accessories.

For Using Your Camera Safely

We have paid close attention to the safety of this camera. When using this camera, we request your special attention regarding items marked with the following symbols.



Warning

This symbol indicates that violating this item could cause serious personal injuries.



Caution

This symbol indicates that violating this item could cause minor or medium personal injuries, or loss of property.

About the Camera



Warning

- Do not disassemble or modify the camera. High voltage areas are present inside the camera, with the risk of electric shock.
- If the camera interior is exposed due to dropping or otherwise damaging the camera, never touch the exposed portion. There is a risk of electric shock.
- Do not aim the camera at the sun or other strong light sources when taking pictures or leave the camera sitting in direct sunlight with the lens cap off. Doing so may cause the camera to malfunction or cause a fire.
- Do not look at the sun or other strong light sources through the lens. Doing so may lead to a loss of eyesight or cause vision to be impaired.

- If any irregularities occur during use, such as smoke or a strange odor, stop use immediately, remove the battery or the AC adapter, and contact your nearest PENTAX Service Center. Continued use can cause a fire or electrical shock.



Caution

- Do not place your finger over the flash when discharging the flash. You may burn yourself.
- Do not cover the flash with clothes when discharging the flash. Discoloration may occur.
- Some portions of the camera heat up during use. There is a risk of low temperature burns when holding such portions for long periods.
- Should the monitor be damaged, be careful of glass fragments. Also, be careful not to allow the liquid crystal to get on your skin or in your eyes or mouth.
- Depending on your individual factors or physical condition, the use of the camera may cause itching, rashes or blisters. In case of any abnormality, stop using the camera and get medical attention immediately.

About the Battery Charger and AC Adapter



Warning

- Always use the battery charger and AC adapter exclusively developed for this camera, with the specified power and voltage. Using a battery charger or AC adapter not exclusive to this camera, or using the exclusive battery charger or AC adapter with an unspecified power or voltage can cause a fire, electric shock, or camera breakdown. The specified voltage is 100 - 240V AC.
- Do not disassemble or modify the product. This can cause a fire or electrical shock.
- If the generation of smoke or strange odor from the product or other abnormality occurs, immediately discontinue using and consult a PENTAX Service Center. Continued use can cause a fire or electrical shock.
- If water should happen to get inside the product, consult a PENTAX Service Center. Continued use can cause a fire or electrical shock.
- If you see a lightning flash or hear the thunder during use of the battery charger and AC adapter, unplug the power plug and discontinue use. Continued use can cause damage to the product, fire or electrical shock.
- Wipe off the power plug if it should become covered with dust. Accumulated dust may cause a fire.
- To reduce the risk of hazards, use only CSA/UL certified power supply cord set, cord is Type SPT-2 or heavier, minimum NO.18 AWG copper, one end with a molded-on male attachment plug cap (with a specified NEMA configuration), and the other is provided with a molded-on female connector body (with a specified IEC nonindustrial type configuration) or the equivalent.



Caution

- Do not place or drop heavy objects on or forcefully bend the AC plug cord. Doing so may damage the cord. Should the AC plug cord be damaged, consult a PENTAX Service Center.

- Do not touch or short-circuit the terminal area of the AC plug cord while the cord is plugged in.
- Do not handle the power plug with wet hands. This can cause an electric shock.
- Do not drop the product, or subject it to violent impact. This can cause the product breakdown.
- Do not use the battery charger D-BC90 to charge batteries other than the rechargeable lithium-ion battery D-LI90. Attempting to charge other types of batteries may cause an explosion or heating, or may damage the battery charger.

About the Rechargeable Lithium-ion Battery

Warning

- If any leakage from the battery should come in contact with your eyes, do not rub them. Flush your eyes with clean water and get medical attention immediately.

Caution

- Only use the specified battery with this camera. Use of other batteries may cause an explosion or fire.
- Do not disassemble the battery. Disassembling the battery may cause an explosion or leakage.
- Remove the battery from the camera immediately if it becomes hot or begins to smoke. Be careful not to burn yourself during removal.
- Keep wires, hairpins, and other metal objects away from the + and - contacts of the battery.
- Do not short the battery or dispose of the battery in fire. This can cause an explosion or fire.
- If any leakage from the battery should come in contact with skin or clothes, it may cause irritation to the skin. Wash the affected areas thoroughly with water.
- Precautions for D-LI90 Battery Usage:
USE SPECIFIED CHARGER ONLY.
 - DO NOT INCINERATE.
 - DO NOT DISASSEMBLE.
 - DO NOT SHORT CIRCUIT.
 - DO NOT EXPOSE TO HIGH TEMP. (140°F/60°C)

Keep the Camera and its Accessories out of the Reach of Small Children

Warning

- Do not place the camera and its accessories within the reach of small children.
 1. If the product falls or is operated accidentally, it may cause serious personal injuries.
 2. Wrapping the strap around a neck may cause suffocation.
 3. To avoid the risk of a small accessory such as the battery or SD Memory Cards from being swallowed by mistake, keep them out of the reach of small children. Seek medical attention immediately if an accessory is accidentally swallowed.

Care to be Taken During Handling

Before Using Your Camera

- When traveling, take the Worldwide Service Network listing that is included in the package. This will be useful if you experience problems abroad.
- When the camera has not been used for a long time, confirm that it is still working properly, particularly prior to taking important pictures (such as at a wedding or when traveling). Contents of the recording cannot be guaranteed if recording, playback or transferring your data to a computer, etc. is not possible due to a malfunction of your camera or recording media (SD Memory Card), etc.

About the Battery and Charger

- To keep the battery in optimal condition, avoid storing it in a fully charged state or in high temperatures.
- If the battery is left inserted and the camera is not used for a long time, the battery will over-discharge and shorten the battery's life.
- Charging the battery a day before use or on the day of use is recommended.
- The AC plug cord provided with this camera is developed exclusively for the battery charger D-BC90. Do not use it with other devices.

Precautions on Carrying and Using Your Camera

- Do not subject the camera to high temperatures or high humidity. Do not leave the camera in a vehicle, as the temperature can get very high.
- Do not subject the camera to strong vibrations, shocks, or pressure. Use a cushion to protect the camera from vibrations of motorcycles, automobiles, or ships.
- The temperature range for camera use is 0°C to 40°C (32°F to 104°F).
- The monitor may appear black at high temperatures, but will return to normal at normal temperatures.
- The monitor may respond more slowly at low temperatures. This is due to liquid crystal properties, and is not a malfunction.
- Sudden temperature changes will cause condensation on the inside and outside of the camera. Place the camera in your bag or a plastic bag, and remove it after temperature of the camera and surroundings are equalized.
- Avoid contact with garbage, mud, sand, dust, water, toxic gases, or salt. These could cause the camera to breakdown. Wipe the camera to dry off any rain or water drops.
- Do not press forcefully on the monitor. This could cause it to break or malfunction.
- Be careful not to overtighten the screw in the tripod socket when using a tripod.

Cleaning Your Camera

- Do not clean the product with organic solvents such as thinner, alcohol, or benzine.
- Use a lens brush to remove dust accumulated on the lens. Never use a spray blower for cleaning as it may damage the lens.
- Please contact a PENTAX Service Center for professional cleaning of the CMOS sensor. (This will involve a fee.)

Storing Your Camera

- Do not store the camera with preservatives or chemicals. Storage in high temperatures and high humidity can cause mold to grow on the camera. Remove the camera from its case and store it in a dry and well-ventilated place.
- Avoid using or storing the camera where it may be exposed to static electricity or electrical interference.
- Avoid using or storing the camera in direct sunlight or in locations where it may be exposed to rapid changes in temperature or to condensation.
- Periodic inspections are recommended every one to two years to maintain high performance.

Other Precautions

- The SD Memory Card is equipped with a write-protect switch. Setting the switch to LOCK prevents new data from being recorded on the card, the stored data from being deleted, and the card from being formatted by the camera or computer.
- The SD Memory Card may be hot when removing the card immediately after using the camera.
- Do not remove the SD Memory Card or turn off the power while the card is being accessed. This may cause the data to be lost or the card to be damaged.
- Do not bend the SD Memory Card or subject it to violent impact. Keep it away from water and store away from high temperatures.
- Do not remove the SD Memory Card while formatting. The card may be damaged and become unusable.
- Data on the SD Memory Card may be deleted in the following circumstances. We do not accept any liability for data that is deleted if
 1. the SD Memory Card is mishandled by the user.
 2. the SD Memory Card is exposed to static electricity or electrical interference.
 3. the SD Memory Card has not been used for a long time.
 4. the SD Memory Card or the battery is removed while the card is being accessed.
- If the SD Memory Card is not used for a long time, the data on the card may become unreadable. Be sure to regularly make a backup of important data on a computer.
- Format new SD Memory Cards. Also format SD Memory Cards previously used with other cameras.

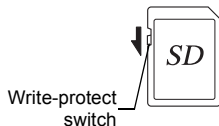

- Please note that deleting data stored on an SD Memory Card, or formatting an SD Memory Card does not completely erase the original data. Deleted data can sometimes be recovered using commercially available software. If you are going to discard, give away or sell your SD Memory Card, you should ensure that the data on the card is completely deleted or the card itself is destroyed if it contains any personal or sensitive information.
- The data on your SD Memory Card should be managed at your own risk.

Regarding Product Registration

In order to better serve you, we request that you complete the product registration, which can be found on the CD-ROM supplied with the camera or on the PENTAX website. Refer to p.213 for details. Thank you for your cooperation.

Contents

For Using Your Camera Safely	1
Care to be Taken During Handling	4
Contents	7
Composition of the Operating Manual	13

Before Using Your Camera **15**

Checking the Contents of the Package 16

Names and Functions of the Working Parts 17

Capture Mode	18
Playback Mode	20
Monitor Display	22

How to Change Function Settings 31

Using the Direct Keys	31
Using the Control Panel	32
Using the Menus	33

Getting Started **37**

Attaching the Strap 38

Inserting the Battery 39

Charging the Battery	39
Inserting/Removing the Battery	40
Battery Level Indicator	41
Approximate Image Storage Capacity and Playback Time (when Using a Fully Charged Battery)	42
Using the AC Adapter (Optional)	42

Inserting/Removing an SD Memory Card 45

Attaching a Lens 47

Turning the Camera On and Off 49

Initial Settings 50

Setting the Display Language	50
Setting the Date and Time	52

Basic Operations

55

Basic Shooting Operation	56
Letting the Camera Choose the Optimal Settings.....	56
Using the Built-in Flash	59
Setting the Flash Mode	59
Shooting with Auto Flash	62
Shooting with Manual Flash.....	63
Reviewing Images	64
Playing Back Images	64
Deleting a Single Image.....	65

Shooting Functions

67

How to Operate the Shooting Functions.....	68
Direct Keys Setting Items.....	68
Rec. Mode Menu Items.....	69
Movie Menu Items.....	71
Custom Setting Menu Items.....	72
Selecting the Appropriate Capture Mode.....	74
Auto Picture Modes.....	75
Scene Modes	76
Exposure Modes	78
Setting the Exposure.....	79
Setting the Sensitivity.....	79
Changing the Exposure Mode	81
Adjusting the Exposure	84
Locking the Exposure Before Shooting (AE Lock).....	87
Selecting the Metering Method	88
Reducing the Image Noise (Noise Reduction).....	89
Focusing.....	92
Setting the Focus Mode	92
Setting the Autofocus Method.....	93
Checking the Focus	95
Focusing Using the AF/AE-L Button	96
Locking the Focus (Focus Lock).....	97
Adjusting the Focus Manually (Manual Focus).....	98

Checking the Depth of Field (Preview)	99
Using the Shake Reduction Function to Prevent Camera Shake	100
Taking Pictures Using the Shake Reduction Function	100
Shooting with the Self-timer	102
Shooting with a Remote Control Unit (Optional)	104
Taking Pictures Continuously	106
Continuous Shooting	106
Interval Shooting	108
Multi-exposure	111
Recording Movies	113
Changing the Settings for Movie Recording	113
Connecting a Microphone	115
Recording Movies	116
Interval Movie	119
Playing Back Movies	121
Editing Movies	123

Shooting Settings **125**

Setting a File Format	126
Aspect Ratio	126
File Format	127
JPEG Recorded Pixels	128
JPEG Quality	129
Color Space	129
Setting the White Balance	130
Adjusting the White Balance Manually	132
Correcting Images	133
Brightness Adjustment	133
High Dynamic Range Image Capture	135
Lens Correction	138
Setting the Image Finishing Tone	140
Custom Image	140
Digital Filter	144
Customizing the Button Functions	147
Setting the ⊙ Button Operation	147
Setting the E-dial Operation in P Mode	150
Setting the Green Button Operation in M Mode	151
Setting the AF/AE-L Button Operation	152

Playback Functions and Image Editing 153

How to Operate the Playback/Editing Functions.....	154
Playback Mode Palette Items	154
Playback Menu Items.....	155
Setting the Playback Display Method.....	156
Magnifying Images	157
Selecting the Playback Functions	158
Displaying Multiple Images	158
Playing Back Images Continuously.....	160
Rotating Images.....	162
Deleting Multiple Images	163
Deleting Selected Images	163
Deleting All Images	164
Processing Images.....	165
Changing the Number of Recorded Pixels (Resize)	165
Cutting Out Part of the Image (Cropping)	166
Processing Images with Digital Filters	167
Joining Multiple Images (Index)	172
Developing RAW Images	174
Developing One RAW Image.....	174
Developing Multiple RAW Images	176
Connecting the Camera to an AV Device	178
Connecting the Camera to a Video Input Terminal or HDMI Input Terminal	178
Setting the Video/HDMI Output Format	179

Changing Additional Settings 183

How to Operate the Set-up Menu	184
Set-up Menu Items	184
Camera Settings	186
Setting the Sound Effects, Date and Time, and Display	
Language	186
Setting the Monitor and the Menu Display	190
Selecting Settings to Save in the Camera (Memory)	195
Resetting the Camera Settings	196
Checking the Camera Version Information	197
File Management Settings	199
Formatting an SD Memory Card	199
Protecting Images from Deletion (Protect)	200
Changing the Naming System for Folders	201
Creating New Folders	201
Setting the Photographer Information	202
Setting the DPOF Settings	204

Connecting to a Computer 207

Manipulating Captured Images on a Computer	208
Saving Images on a Computer	209
Setting the USB Connection Mode	209
Connecting the Camera and a Computer	210
Using the Provided Software	211
Installing the Software	211

Using the Flash 215

Using the Built-in Flash	216
Flash Characteristics in Each Exposure Mode	216
Using the Slow-speed Sync Flash	216
Using the Trailing Curtain Sync Flash	217
Distance and Aperture when Using the Built-in Flash	218
Lens Compatibility with the Built-in Flash	219

Using an External Flash (Optional)	220
Using the P-TTL Auto Flash.....	221
Using the High-speed Sync Flash.....	222
Connecting an External Flash with an Extension Cord.....	223

Appendix 225

Default Settings	226
Functions Available with Various Lens Combinations	232
Setting the Focal Length.....	234
Using the Aperture Ring.....	235
Cleaning the CMOS Sensor	237
Removing Dust by Shaking the CMOS Sensor (Dust Removal)	237
Removing Dust with a Blower	238
Optional Accessories	240
Using the GPS Unit.....	244
Error Messages	245
Troubleshooting	247
Main Specifications	250
Index	256
WARRANTY POLICY	263

Composition of the Operating Manual

This Operating Manual contains the following chapters.

1 Before Using Your Camera

Explains the provided accessories and the names and functions of the working parts.

2 Getting Started

Explains your first steps from purchasing the camera to taking pictures. Be sure to read this chapter and follow the instructions.

3 Basic Operations

Explains basic operations for taking and playing back pictures.

4 Shooting Functions

Explains shooting-related functions.

5 Shooting Settings

Explains procedures for changing the shooting settings, such as the file format.

6 Playback Functions and Image Editing

Explains various operations for playing back and editing images.

7 Changing Additional Settings

Explains general camera settings and file management settings such as the monitor display settings and the image folder naming system.

8 Connecting to a Computer

Explains how to connect the camera to a computer, and includes installation instructions and a general overview of the provided software.

9 Using the Flash

Explains how to use the built-in flash and external flashes.

10 Appendix

Explains troubleshooting, introduces optional accessories and provides various resources.

1

2

3

4

5

6



7

8

9

10

The symbols used in this Operating Manual are explained below.

	Indicates reference page numbers explaining a related operation.
	Indicates useful information.
	Indicates precautions to take when operating the camera.

1 Before Using Your Camera

Check the package contents and the names and functions of the working parts before use.

Checking the Contents of the Package	16
Names and Functions of the Working Parts	17
How to Change Function Settings	31

Checking the Contents of the Package

The following accessories are packaged with the camera. Check that all accessories are included.

1

Before Using Your Camera



Hot shoe cover Fk
(installed on camera)

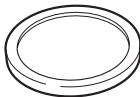

Body mount cover
(installed on camera)

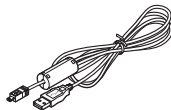

USB cable
I-USB7

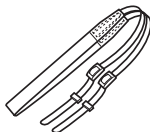

Strap
O-ST120



Rechargeable lithium-ion
battery D-LI90

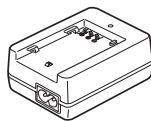

Battery charger
D-BC90



AC plug cord



Software (CD-ROM)
S-SW120



Operating Manual
(this manual)



Quick Guide



Refer to p.240 for information on optional accessories.

Names and Functions of the Working Parts

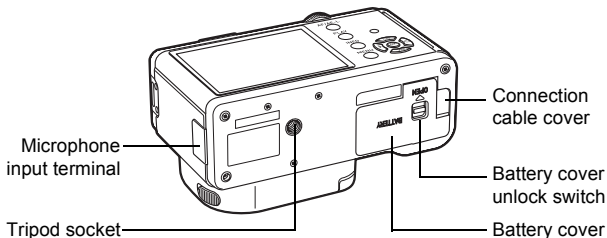
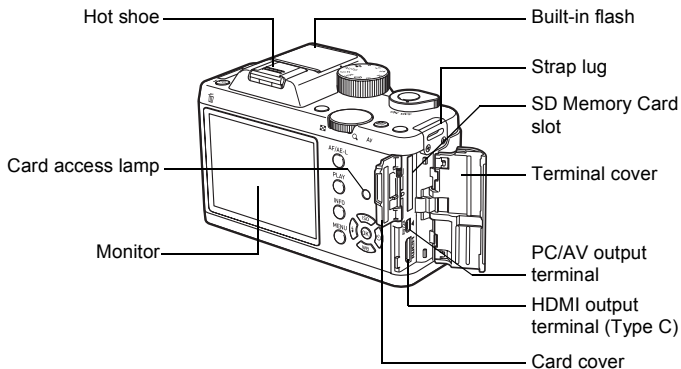
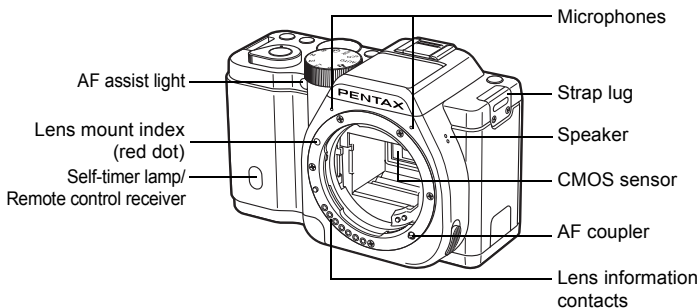

Capture Mode

Here, you can learn which parts are used and how they function when in capture mode.



The factory default setting of each part is explained here, but some parts have multiple functions and work differently depending on the selected setting.

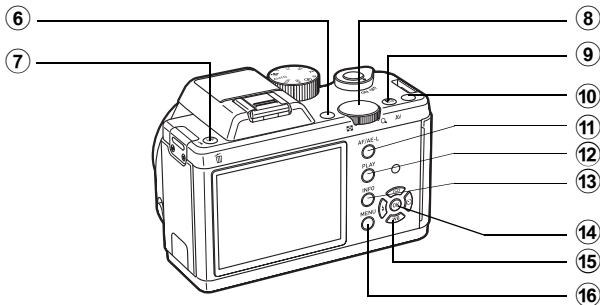
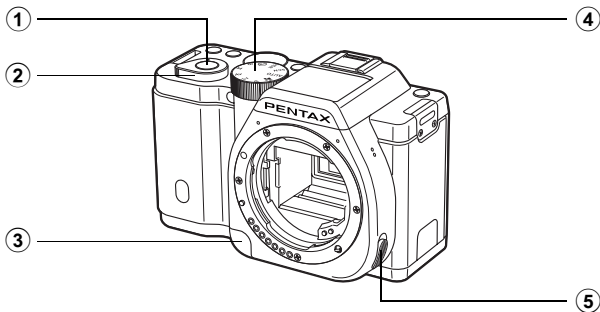

① Shutter release button

Press to capture images. (p.57)

② Main switch



Move to turn the camera on and off. (p.49)

③ Lens unlock button

Press to detach a lens. (p.48)

④ Mode dial

Changes the capture mode. (p.74)

- ⑤ **Focus mode switch**
Changes the focus mode.
(p.92)
- ⑥ **⦿ (Green) button**
You can assign a function to this button. (p.147)
In this manual, this button is referred to as the ⦿ (G) button.
- ⑦ **⚡UP/🗑️ (Flash pop-up) button**
Press to pop up the built-in flash. (p.63)
- ⑧ **E-dial**
Sets the shutter speed, aperture, and EV compensation values. (p.81)
You can change the menu when a menu screen is displayed. (p.34)
You can change the settings when the control panel is displayed. (p.33)
- ⑨ **📷/Av button**
Press to set the EV compensation and aperture values. (p.82, p.84)
Turn the e-dial after or while pressing the 📷/Av button to change the settings.
- ⑩ **⦿ (Red) button**
Press to record movies. You can also assign a function to this button. (p.118, p.147)
In this manual, this button is referred to as the ⦿ (R) button.
- ⑪ **AF/AE-L button**
You can select the function of this button either to focus on the target or to lock the exposure value. (p.87, p.96, p.152)
- ⑫ **PLAY button**
Switches to playback mode.
(p.64)
- ⑬ **INFO button**
Displays the control panel. Press again to change the type of information displayed in standby mode. (p.22)
- ⑭ **OK button**
When the control panel or a menu screen is displayed, press this button to confirm the selected item.
When [Autofocus Method] is set to  (Select), press this button to start and end selecting the autofocus (AF) area. (p.94)
When the camera is in **MF** mode or when the focus is locked, press this button to magnify the image on the monitor. (p.95)
- ⑮ **Four-way controller (▲▼◀▶)**
Displays the Sensitivity/White Balance/Flash Mode/Drive Mode setup menu. (p.68)
When the control panel or a menu screen is displayed, use this to move the cursor or change the item to set.
- ⑯ **MENU button**
Displays the [ Rec. Mode 1] menu (p.69). Press this button while the menu screen is displayed to return to the previous screen. (p.33)

Playback Mode

Here, you can learn which parts are used and how they function when in playback mode.

1

Before Using Your Camera

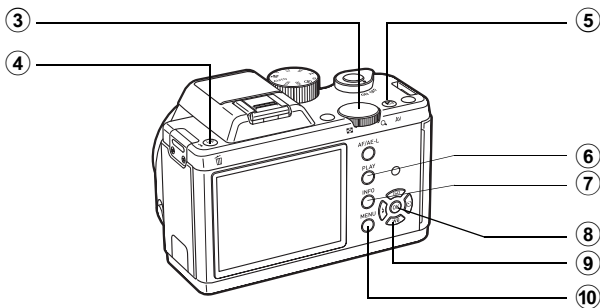
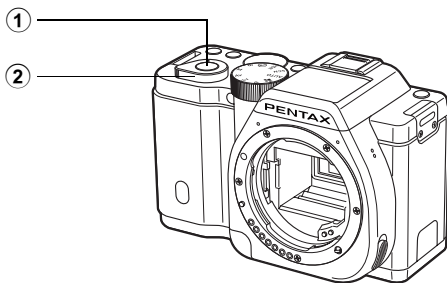

- ① **Shutter release button**
Press halfway to switch to capture mode.
- ② **Main switch**
Move to turn the camera on and off. (p.49)
- ③ **E-dial**
Use this to magnify an image (p.157) or display multiple images at the same time (p.158).
- ④ **↶UP/🗑️ (Delete) button**
Press to delete images. (p.65)
- ⑤ **📷/Av button**
When the file format of the last captured image is JPEG, and its data still remains in the buffer memory, press this button to save the image in RAW format. (p.64)
- ⑥ **PLAY button**
Switches to capture mode.
- ⑦ **INFO button**
Changes the type of information displayed in playback mode. (p.25)
- ⑧ **OK button**
Confirms the setting you selected in the menu or playback screen.
- ⑨ **Four-way controller (▲▼◀▶)**
Use this to move the cursor or change the item to set in the menu or playback screen. Press the four-way controller (▼) in the single image display to display the playback mode palette. (p.154)
- ⑩ **MENU button**
Displays the [▶ Playback 1] menu (p.155).

References to the Arrow Keys of the Four-way Controller

In this manual, the arrow keys of the four-way controller are referred to in the following way.

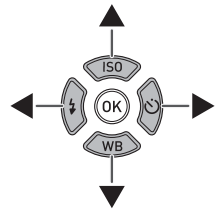

Monitor Display

Various information appears on the monitor depending on the status of the camera.



The brightness level and the color of the monitor can be adjusted. (p.192)

Capture Mode

In standby mode, the current settings for shooting are displayed on the monitor.

Press the **INFO** button to display the “control panel” and change settings. (p.24)

If you press the **INFO** button while the control panel is displayed, you can select the type of information displayed in standby mode. Use the four-way controller (▲▼◀▶) to select a display type, and press the **OK** button to set the standby mode screen.



Standby mode
(Standard Information Display)

INFO



Control panel

INFO

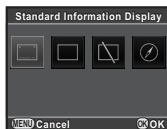

Standby mode
display selection

Screen Display	Displayed Information
Standard Information Display	The Live View image and the shooting function settings are displayed. (p.23)
No Information Display	Only the Live View image is displayed. Press the shutter release button halfway to display the shutter speed, aperture value, sensitivity and number of recordable images.
Display Off	Nothing is displayed on the monitor. The shutter speed, aperture value and sensitivity are displayed while the exposure is set with the e-dial. Not available when the mode dial is set to .
Electronic Compass	The current latitude, longitude, altitude, direction, and Coordinated Universal Time (UTC) are displayed. Press the shutter release button halfway to return to [Standard Information Display]. Available only when the optional GPS unit O-GPS1 (p.243) is attached to the camera and is operating.



- A grid, histogram, and bright/dark area warning can be displayed when [Standard Information Display] or [No Information Display] is selected. (p.190)
- If [Display Off] or [Electronic Compass] is selected, the display setting returns to [Standard Information Display] when the camera is turned off.

● Standard Information Display

(All items are displayed here for explanatory purposes. The actual display may differ.)

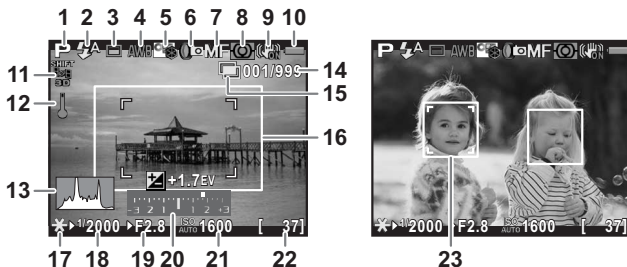

- | | | | |
|----|--|----|---|
| 1 | Capture mode (p.74) | 14 | Number of shots during Interval Shooting or Multi-exposure/ Exposure range during HDR mode |
| 2 | Flash Mode (p.59)/ Recording Sound Level (p.114) | 15 | Interval Shooting (p.108)/ Multi-exposure (p.111) |
| 3 | Drive Mode (p.68) | 16 | AF frame (p.57) |
| 4 | White Balance (p.130) | 17 | AE Lock (p.87) |
| 5 | Custom Image (p.140) | 18 | Shutter speed (p.82) |
| 6 | HDR mode (p.137)/ HDR Capture (p.135)/ Digital Filter (p.144) | 19 | Aperture value (p.82) |
| 7 | Focus mode (p.92) | 20 | EV bar scale (p.84) |
| 8 | AE Metering (p.88) | 21 | Sensitivity (p.79) |
| 9 | Shake Reduction (p.100)/ Movie SR (p.114) | 22 | Number of recordable still pictures/movie recordable time |
| 10 | Battery level (p.41) | 23 | Face detection frame (when [Autofocus Method] is set to [Face Detection]) (p.93) |
| 11 | GPS positioning status | | |
| 12 | Temperature warning | | |
| 13 | Histogram (p.29) | | |

- * Indicator 11 appears only when the optional GPS Unit O-GPS1 is attached to the camera and is operating. (p.244)
- * Indicator 16 is displayed in white. It turns green when the subject is in focus and turns red when the subject is not in focus. It is not displayed when the focus mode switch is set to **MF**.
- * For indicator 23, multiple face detection frames are displayed when [Autofocus Method] is set to (Face Detection). A main face detection frame is displayed in yellow and other frames in white.

● Control panel

Press the **INFO** button in standby mode to display the control panel and change settings. (p.32)

Still picture capture mode

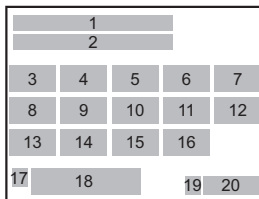

mode

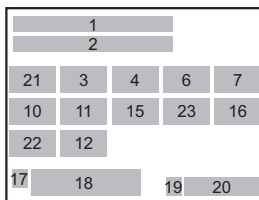

- | | |
|---|--|
| 1 Function name | 13 Aspect Ratio (p.126) |
| 2 Setting | 14 File Format (p.127) |
| 3 Custom Image (p.140)/
Scene Mode (p.76) | 15 JPEG Recorded Pixels (p.128)/
Movie Recorded Pixels (p.114) |
| 4 Digital Filter (p.144) | 16 JPEG Quality (p.129)/
Movie Quality Level (p.114) |
| 5 HDR Capture (p.135) | 17 Destination setting (p.187) |
| 6 AE Metering (p.88) | 18 Current date and time (p.52) |
| 7 Autofocus Method (p.93) | 19 SD Memory Card status |
| 8 Distortion Correction (p.138) | 20 Number of recordable still
pictures/movie recordable time |
| 9 Lateral Chromatic Aberration
Adjustment (p.138) | 21 Exposure Setting (p.113) |
| 10 Highlight Correction (p.133) | 22 Recording Sound Level (p.114) |
| 11 Shadow Correction (p.134) | 23 Framerate (p.114) |
| 12 Shake Reduction (p.100)/
Movie SR (p.114) | |



- Settings that cannot be changed due to the current camera setup cannot be selected.
- If no operations are made within 1 minute in the control panel, the camera returns to standby mode.

Playback Mode

The captured image and shooting information are displayed in the single image display of playback mode.

☞ Playing Back Images (p.64)

Press the **INFO** button to select the type of information displayed in the single image display. Use the four-way controller (▲▼◀▶) to select a display type and press the **OK** button to set the playback information display screen.



Single image display
(Standard Information Display)

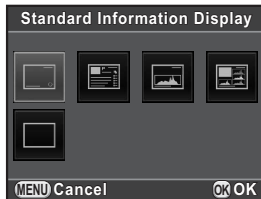

Playback information display
selection

Screen Display	Displayed Information
Standard Information Display	The captured image, file format and operation guide indicators are displayed.
Detailed Information Display	Detailed information on how and when the image was taken is displayed in two pages. (p.26)
Histogram Display	The captured image and brightness histogram are displayed. Not available during movie playback. (p.28)
RGB Histogram Display	The captured image and RGB histogram are displayed. Not available during movie playback. (p.28)
No Information Display	Only the captured image is displayed.

The information selected here is displayed the next time the camera is switched to playback mode.



If [Playback Info Display] is set to (Off) in [Memory] of the [Rec. Mode 3] menu, the Standard Information Display always appears first when the camera is turned on. (p.195)

● Detailed Information Display

Use the four-way controller (▲▼) to switch between pages.

(All items are displayed here for explanatory purposes. The actual display may differ.)

Page 1

Still picture

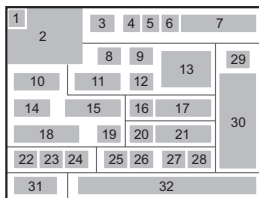

Movie

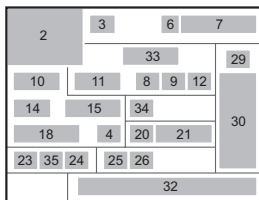

Page 2

Still picture/Movie

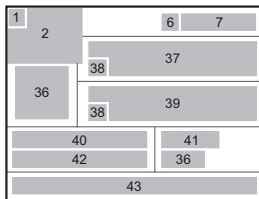
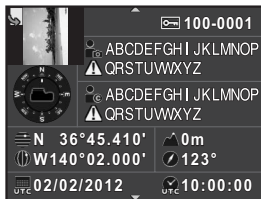

- | | |
|---|--|
| <ol style="list-style-type: none"> 1 Rotation information (p.162) 2 Captured image 3 Capture mode (p.74) 4 Digital Filter (p.144) 5 DPOF setting (p.204) | <ol style="list-style-type: none"> 6 Protect setting (p.200) 7 Folder number-File number (p.201) 8 Drive Mode (p.68) 9 AE Metering (p.88) 10 Shutter speed (p.82) |
|---|--|

- | | |
|--|--|
| 11 Lens focal length | 26 Shadow Correction (p.134) |
| 12 Shake Reduction (p.100)/
Movie SR (p.114) | 27 Distortion Correction (p.138) |
| 13 Focus mode (p.92) | 28 Lateral Chromatic Aberration
Adjustment (p.138) |
| 14 Aperture value (p.82) | 29 Custom Image (p.140) |
| 15 EV Compensation (p.84) | 30 Custom Image parameters (p.141) |
| 16 Flash Mode (p.59) | 31 Color Space (p.129) |
| 17 Flash Exposure Compensation
(p.61) | 32 Shooting date and time |
| 18 Sensitivity (p.79) | 33 Recording time |
| 19 HDR Capture (p.135)/
Multi-exposure (p.111) | 34 Recording Sound Level (p.114) |
| 20 White Balance (p.130) | 35 Framerate (p.114) |
| 21 White Balance fine-tuning (p.131) | 36 Lens direction |
| 22 File Format (p.127) | 37 Photographer (p.202) |
| 23 JPEG Recorded Pixels (p.128)/
Movie Recorded Pixels (p.114) | 38 Information tampering warning |
| 24 JPEG Quality (p.129)/
Movie Quality Level (p.114) | 39 Copyright Holder (p.203) |
| 25 Highlight Correction (p.133) | 40 Latitude |
| | 41 Altitude |
| | 42 Longitude |
| | 43 Universal Coordinated Time |

* Indicators 36 and 40 to 43 appear only for images in which GPS information is stored.

● Histogram Display/RGB Histogram Display

Use the four-way controller (▲▼) to switch between the Histogram Display and RGB Histogram Display.

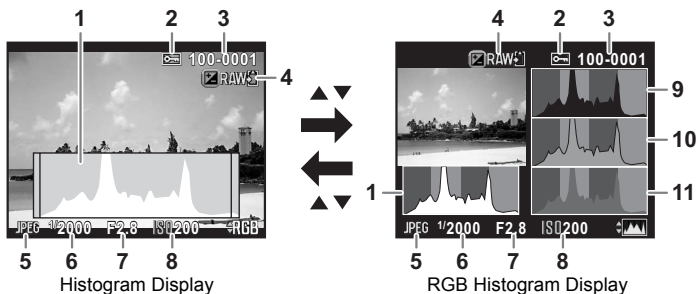

- | | |
|-----------------------------|------------------|
| 1 Histogram (Brightness) | 7 Aperture value |
| 2 Protect setting | 8 Sensitivity |
| 3 Folder number-File number | 9 Histogram (R) |
| 4 Save RAW Data | 10 Histogram (G) |
| 5 File Format | 11 Histogram (B) |
| 6 Shutter speed | |

* Indicator 4 appears only when the file format of the last captured image is JPEG, and the image can also be saved in RAW format. (p.64)



If [Bright/Dark Area] (p.156) of the [▶ Playback 1] menu is set to (On), bright (overexposed) portions blink red, while dark (underexposed) portions blink yellow. This information is not displayed in Detailed Information Display or RGB Histogram Display.

Using the Histogram

A histogram shows the brightness distribution of an image. The horizontal axis represents brightness (dark at the left and bright at the right) and the vertical axis represents the number of pixels.

The shape and the distribution of the histogram before and after shooting tell you whether the exposure level and contrast are correct or not, and let you decide if you need to adjust the exposure and take a picture again.

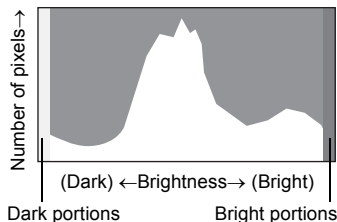

- ☞ Adjusting the Exposure (p.84)
- ☞ Brightness Adjustment (p.133)

Understanding Brightness

When the brightness is correct and there are no overexposed or underexposed areas, the graph peaks in the middle. If the image is underexposed, the peak is on the left side, and if it is overexposed, the peak is on the right side.



Dark (underexposed)
image



Image with few bright or
dark areas



Bright (overexposed)
image

When the image is underexposed, the part to the left is cut off (underexposed portions with no detail) and when the image is overexposed, the part to the right is cut off (overexposed portions with no detail).

This camera can be set so that it displays the Bright/Dark Area warning during capture or playback mode.

- ☞ Setting the Playback Display Method (p.156)
- ☞ Setting the Standby Mode Display Method (p.190)
- ☞ Setting the Display for Instant Review (p.191)

Understanding Color Balance

















Distribution of color intensity is displayed for each color in RGB Histogram Display. If a color is partially cut off on one side, it indicates that the color is under- or overexposed, that the light is very weak or strong in that color, or that the white balance is incorrect.

☞ Setting the White Balance (p.130)

Guide Indicators

The following indicators appear on the monitor to indicate the keys, buttons and e-dial that can be operated at that time.

Example:

	Four-way controller (▲)	 (Green)	 (G) button
	Four-way controller (▼)	 (Red)	 (R) button
	Four-way controller (◀)		INFO button
	Four-way controller (▶)		Av button
	MENU button		UP button
	OK button		AF/AE-L button
	E-dial		Shutter release button



- The image on the monitor may differ from the actual image captured if the brightness of the subject is low or high.
- If any changes occur in the light source during shooting, the image on the monitor may flicker. You can cut down on flicker by setting the power frequency in [Flicker Reduction] (p.184) of the [Set-up 1] menu to that used in your region.
- If the camera position is changed rapidly during shooting, the image may not be displayed with the appropriate brightness. Wait for the display to become stable before shooting.
- Noise may appear on the monitor image when used in dark locations.
- The higher the sensitivity, the more noise and color unevenness may occur in the monitor image and/or captured image.
- If you continue shooting for a prolonged period, the internal temperature of the camera may increase, resulting in lower quality images. It is recommended that you turn off the camera when not shooting. To prevent the image quality from degrading, allow enough time for the camera to cool down while shooting with long exposures or recording movies.
- If the internal temperature of the camera becomes high,  (temperature warning) will appear on the monitor. If this happens, stop shooting or turn off the monitor. If you continue shooting with the temperature warning displayed, the camera will turn off.

Function settings can be changed using the direct keys, control panel or menus.

This section explains the basic ways to change function settings.

Using the Direct Keys

In standby mode, you can set Sensitivity, White Balance, Flash Mode and Drive Mode by pressing the four-way controller (▲▼◀▶). (p.68)
Below, how to set [Flash Mode] is explained as an example.

- 1 Press the four-way controller (◀) in standby mode.**

The Flash Mode setting screen appears.

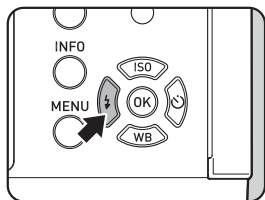

- 2 Use the four-way controller (◀▶) to select a flash mode.**



- 3 Press the OK button.**

The camera is ready to take a picture.

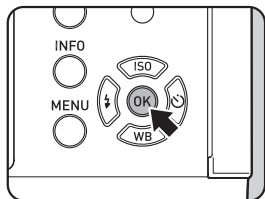

Using the Control Panel

In standby mode, you can switch to the control panel and change settings. Below, how to set [JPEG Quality] is explained as an example.

1 Press the INFO button in standby mode.

The control panel appears.

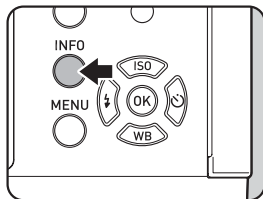

2 Use the four-way controller (▲▼◀▶) to select an item you want to change the setting for.

You cannot select items that cannot be changed as a result of current camera settings.



3 Press the OK button.

The setup screen of the selected item appears.



- 4 Use the four-way controller (◀▶) or e-dial to select a setting value.**



- 5 Press the OK button.**

The camera returns to the control panel.
Next, set other items.

- 6 Press the MENU button or the shutter release button halfway.**

The camera is ready to take a picture.



You can also change the setting by turning the e-dial after selecting the item you want to change in Step 2 ([Recording Sound Level] for mode can only be set using this operation). Detailed settings such as for Custom Image and Digital Filter can be changed after pressing the **OK** button.

Using the Menus

This section explains how to use the following menus: [Rec. Mode], [Movie], [Playback], [Set-up] and [Custom Setting].
Below, how to set [Slow Shutter Speed NR] in the [Rec. Mode 2] menu is explained as an example.

- 1 Press the MENU button in standby mode.**

The [Rec. Mode 1] menu appears on the monitor.

The menus listed below are displayed in the following situations.

When the mode dial is set to	[Movie 1] menu
In playback mode	[Playback 1] menu

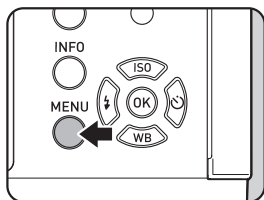

2 Press the four-way controller (▶).

Each time the four-way controller (▶) is pressed, the menu will change in the following sequence: [📷 Rec. Mode 2], [📷 Rec. Mode 3], [🎥 Movie 1], [▶ Playback 1] ... [📷 Rec. Mode 1].

You can also change the menu by turning the e-dial.

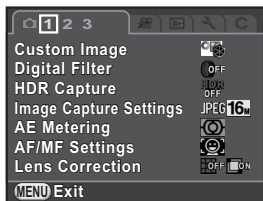

3 Use the four-way controller (▲ ▼) to select an item.

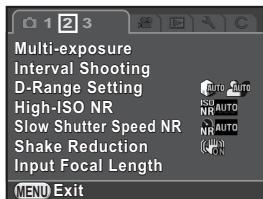

4 Press the four-way controller (▶).

Available settings are displayed in the pop-up menu or submenu.

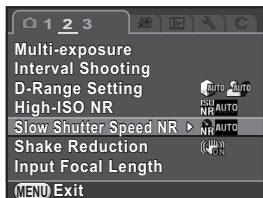

5 Use the four-way controller (▲ ▼) to select a setting.

Press the **MENU** button to cancel the pop-up menu, or return to the previous screen.



6 Press the OK button.

The setting is saved.

Press the **MENU** button if a submenu is displayed.

Next, set other items.

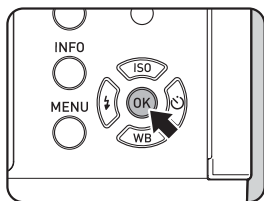

7 Press the MENU button.

The screen that was displayed before selecting the menu item appears again.

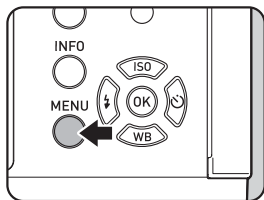

Even after you press the **MENU** button and close the menu screen, your settings will not be saved if the camera is turned off improperly (such as by removing the battery while the camera is on).



- You can select either to display the menu tab selected the last time first, or to always display the [📷 Rec. Mode 1] menu first. (p.193)
- Refer to the following pages for details on each menu.
 - [📷 Rec. Mode] menu 📖 p.69
 - [🎬 Movie] menu 📖 p.71
 - [▶ Playback] menu 📖 p.155
 - [⚙️ Set-up] menu 📖 p.184
 - [C Custom Setting] menu 📖 p.72

Memo

2 Getting Started

This chapter explains your first steps from purchasing the camera to taking pictures. Be sure to read this and follow the instructions.

Attaching the Strap	38
Inserting the Battery	39
Inserting/Removing an SD Memory Card	45
Attaching a Lens	47
Turning the Camera On and Off	49
Initial Settings	50

Attaching the Strap

- 1** Pass the end of the strap through the strap lug, then secure it on the inside of the clasp.

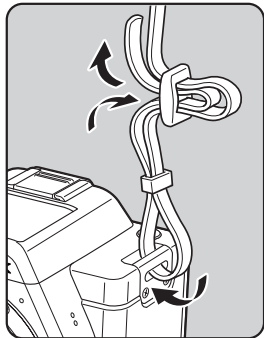

- 2** Attach the other end of the strap in the same manner as described above.

Insert the battery into the camera. Use the exclusive battery D-LI90.

Charging the Battery

When using the battery for the first time, or when the battery has not been used in a long time, or when [Battery depleted] appears, recharge the battery.

Note: AC plug cord “Listed, Type SPT-2 or NISPT-2, 18/2 flexible cord, rated 125 V, 7A, minimum 6ft (1.8m)”

- 1** Connect the AC plug cord to the battery charger.
- 2** Plug the AC plug cord into the power outlet.
- 3** Face the ▲ mark on the battery up, and insert the battery into the battery charger.

The indicator lamp lights up when charging and turns off when the battery is fully charged.

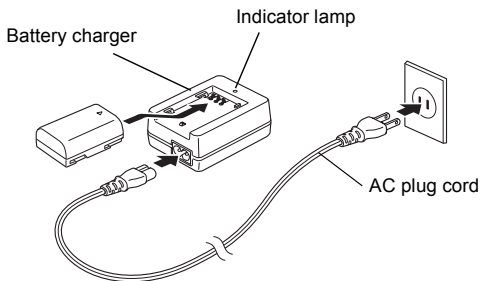

4 When the battery is fully charged, remove the battery from the battery charger.



- Do not use the provided Battery Charger D-BC90 to charge batteries other than the rechargeable lithium-ion battery D-LI90. Charging other batteries may cause damage or heating.
- Replace the battery with a new one in the following cases:
 - If the indicator lamp blinks or does not light after the battery is inserted correctly
 - If the battery starts to run down more quickly even after being charged (the battery may have reached the end of its service life)



The maximum charging time is approximately 320 minutes (depends on temperature and remaining battery power). Charge in a location where the temperature is between 0°C and 40°C.

Inserting/Removing the Battery



- Insert the battery correctly. If the battery is inserted incorrectly, it may not be removed. Wipe the electrodes of the battery with a soft dry cloth before inserting.
- Do not open the battery cover or remove the battery while the power is on.
- Be careful as the camera or battery may become hot when the camera is used continuously for a long period of time.
- Remove the battery when you will not use the camera for a long while. The battery may leak.
- The date and time may be reset if you leave the battery out of the camera for a long period of time. If this occurs, follow the procedure described in "Setting the Date and Time" (p.52) to set the current date and time.

1 Push the battery cover unlock switch towards OPEN (①) to unlock.

The battery cover opens (②).

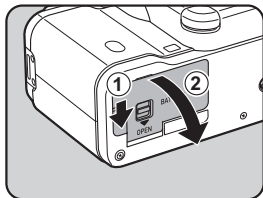

- 2** With the ▲ mark facing toward the lens, push the battery in until it locks into place.

To remove the battery, push the battery lock switch (③) in the direction of the arrow.

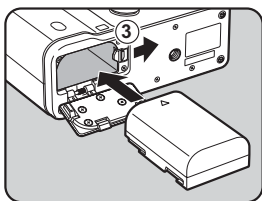

- 3** Close the battery cover.

The battery cover is locked.

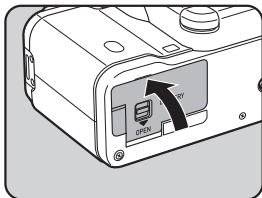

Battery Level Indicator

You can confirm the remaining battery level by checking the following symbols displayed on the monitor.

Monitor Display	Battery Level
(green)	Battery is full.
(green)	Battery is close to full.
(yellow)	Battery is running low.
(red)	Battery is almost empty.
[Battery depleted]	The camera turns off after displaying the message.



or (red) may appear even when the battery level is sufficient if the camera is used at low temperatures or for a long period of time. In this situation, turn the camera off and on again. If (green) appears, you can use the camera.

Approximate Image Storage Capacity and Playback Time (when Using a Fully Charged Battery)

Battery	Temperature	Normal Shooting	Flash Photography		Playback Time
			50% Use	100% Use	
D-LI90	23°C	540 images	500 images	440 images	320 minutes
	0°C	480 images	450 images	410 images	300 minutes

The image storage capacity (normal recording and flash use 50%) is based on measuring conditions in accordance with CIPA standards, while other data is based on our measuring conditions. Some deviation from the above figures may occur in actual use depending on the selected capture mode and shooting conditions.



- Battery performance temporarily decreases as the temperature decreases. When using the camera in cold climates, have extra batteries at hand and keep them warm in your pocket. Battery performance will return to normal when batteries return to room temperature.
- Have extra batteries ready when traveling overseas, taking pictures in cold climates, or taking a lot of pictures.

Using the AC Adapter (Optional)

We recommend the use of the AC Adapter kit K-AC1202 (optional) when using the monitor for a long time or when connecting the camera to a computer or AV device.

1 Make sure that the camera is turned off.

2 Open the battery cover.

Refer to Step 1 on p.40.

Remove the battery if it is inserted in the camera.

- 3** Pull down the connection cable cover (①) on the left of the battery cover, and insert the DC coupler into the battery chamber until it locks into place.

To remove the DC coupler, push the battery lock switch (②) in the direction of the arrow.

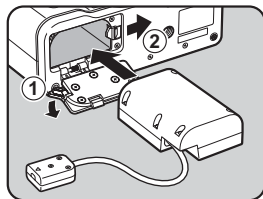

- 4** Close the battery cover.

The connection cable is pulled out from the connection cable cover section.

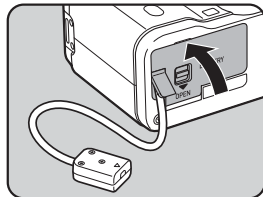

- 5** Connect the DC coupler and the AC adapter.

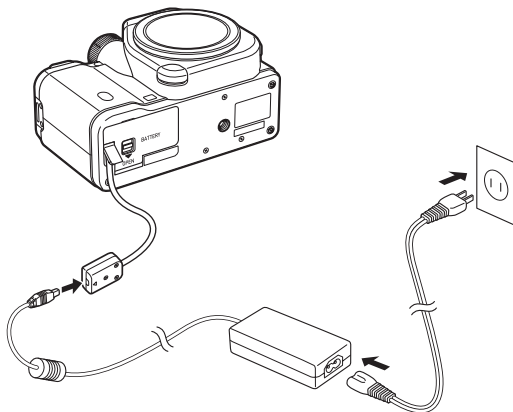

- 6** Connect the AC adapter to the AC plug cord.

7 Plug the AC plug cord into the power outlet.



- Make sure the camera is turned off before connecting or disconnecting the AC adapter.
- Make sure connections are secure between the terminals. SD Memory Card or data may be corrupted if the connection to the power supply is lost while the card is being accessed.
- While the AC adapter is in use, the connection cable is pulled out from the bottom side of the camera, so remember that you cannot stand the camera upright on a table, etc.
- After removing the DC coupler, return the connection cable cover to its original location.



- When the AC adapter is connected to the camera,  is displayed as the battery level.
- Be sure to read the manual of the AC Adapter kit K-AC1202 before using the AC adapter.

Inserting/Removing an SD Memory Card

This camera uses a commercially available SD Memory Card, SDHC Memory Card, or SDXC Memory Card.

Make sure the camera is turned off before inserting or removing the SD Memory Card.



- Do not remove the SD Memory Card while the card access lamp is lit.
- Do not open the terminal cover and card cover while the camera is in use.
- Use this camera to format (initialize) an SD Memory Card that is unused or has been used on other devices. Refer to "Formatting an SD Memory Card" (p.199) for details on formatting.
- Use a high-speed memory card when recording movies. If the writing speed cannot keep up with the recording speed, writing may stop during recording.

1 Make sure that the camera is turned off.

2 Open the terminal cover in the direction of the arrow.

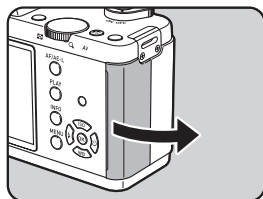

3 Open the card cover in the direction of the arrow.

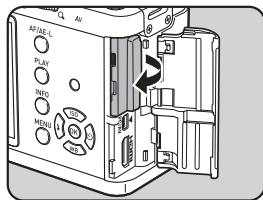

- 4** Insert the card all the way with the SD Memory Card label facing toward the monitor.

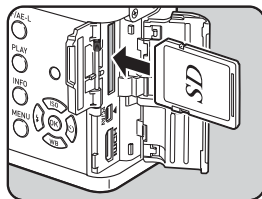

Push the SD Memory Card in once to remove.

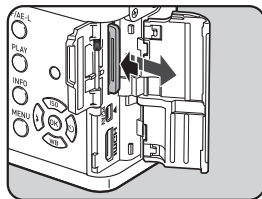

- 5** Close the card cover, and the terminal cover (①→②).

Close both covers properly.

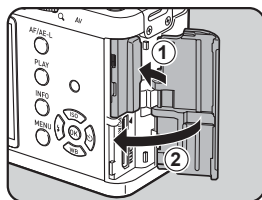

For details on the approximate number of still pictures and the amount of time of movies that can be recorded on an SD Memory Card, refer to "Approximate Image Storage Capacity" (p.255).

Attach a proper lens to the camera body.

When you use one of the following lenses with this camera, all the camera's capture modes are available.

- (a) DA, DA L, D FA, FA J lenses
- (b) Lenses with an **A** (Auto) position; when used in the **A** position

The steps are described here using a DA 40mm F2.8 XS lens.



- When attaching/removing a lens, choose an environment that is relatively free of dirt and dust.
- Keep the body mount cover on the camera when a lens is not attached.
- Be sure to attach the lens mount cover and lens cap to the lens after removing the lens from the camera.
- Do not insert any fingers into the camera mount or touch the shutter or CMOS sensor.
- The camera body and lens mount incorporate lens information contacts. Dirt, dust, or corrosion on the contacts may damage the electrical system. Please contact a PENTAX Service Center for professional cleaning.
- Some functions will be restricted when lenses described in (b) are used in a position other than **A**, or when lenses other than those listed above and/or other accessories are used. Refer to "Functions Available with Various Lens Combinations" (p.232) for details.
- If a lens for which the focal length information cannot be automatically obtained is used, the Input Focal Length setting screen appears when the camera is turned on. Refer to "Setting the Focal Length" (p.234) for details.
- We assume no responsibility nor liability for accidents, damages and malfunctions resulting from the use of lenses made by other manufacturers.

1 Make sure that the camera is turned off.

2 Remove the body mount cover (①) and lens mount cover (②).

Be sure to put the lens down with the lens mount side facing upward to protect the lens mount from damage when there is no lens mount cover on the lens.

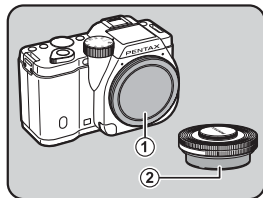

- 3** Align the lens mount index (red dots: ③) on the camera and the lens, and secure by turning the lens clockwise until it clicks.

After attaching, turn the lens counterclockwise to make sure that the lens is locked in place.

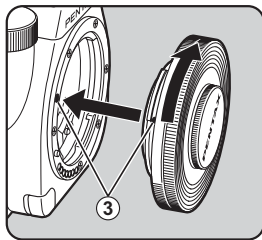

- 4** Remove the front lens cap.

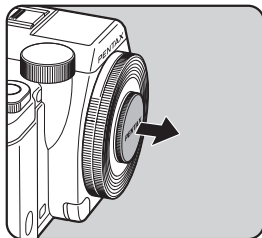

To remove the lens

Attach the lens cap first, and then turn the lens counterclockwise while holding down the lens unlock button (④).

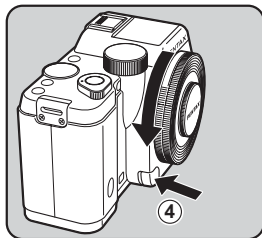

Do not remove the lens while the power is on.



The body mount cover (①) is for preventing scratches and blocking dust when shipped. Body Mount Cap K is sold separately and has a lock function.

1 Turn the main switch to [ON].

The camera turns on, and the startup screen appears.

Set the main switch to the position [OFF] to turn off the camera.

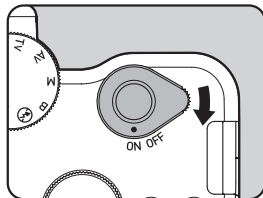

- Always turn the camera off when not in use.
- The power will automatically turn off when you do not perform any operations within a set period of time (Auto Power Off). To reactivate the camera, turn it on again or perform any of the following operations.
 - Press the shutter release button halfway.
 - Press the **MENU** button or **INFO** button.
- [Auto Power Off] is set to [1min.] by default. You can change the setting in [Auto Power Off] of the [↖ Set-up 2] menu. (p.194)
- To turn the camera on in playback mode, turn the main switch to [ON] while holding down the **PLAY** button.
- If you do not want to display the startup screen, you can change the setting in [LCD Display] of the [↖ Set-up 1] menu. (p.192)

The first time the camera is turned on, the [Language/言語] screen appears on the monitor. Follow the procedure below to set the language displayed on the monitor and the current date and time. Once these settings are made, you will not need to set them again next time you turn on your camera.

If the [Date Adjustment] screen appears, set the date and time by following the procedure in "Setting the Date and Time" (p.52).

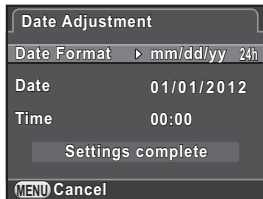

Setting the Display Language

You can set the language in which the menus, error messages, etc. are displayed.

- 1 Use the four-way controller (▲▼◀▶) to select the desired language, and press the OK button.**

The [Initial Setting] screen appears in the selected language.

Proceed to Step 6 if 🏠 (Hometown) does not have to be changed.



- 2 Press the four-way controller (▼) to move the frame to 🏠, and press the four-way controller (▶).**

The [🏠 Hometown] screen appears.

3 Use the four-way controller (◀▶) to select a city.

Turn the e-dial to change the region.

Refer to “List of World Time Cities” (p.189) for cities that can be selected as a hometown.



4 Press the four-way controller (▼) to select [DST], and use the four-way controller (◀▶) to select (On) or (Off).

5 Press the OK button.

The camera returns to the [Initial Setting] screen.

6 Press the four-way controller (▼) to select [Settings complete], and press the OK button.

The [Date Adjustment] screen appears.



If the hometown and the date and time are not set, the [Initial Setting] screen or [Date Adjustment] screen will be displayed again the next time the camera is turned on.

Setting the Date and Time

Set the current date and time and the display style.

- 1 Press the four-way controller (▶), and use the four-way controller (▲▼) to select the date format.

Choose [mm/dd/yy], [dd/mm/yy] or [yy/mm/dd].

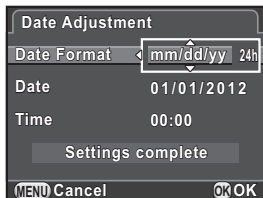

- 2 Press the four-way controller (▶), and use the four-way controller (▲▼) to select [24h] or [12h].

- 3 Press the OK button.

The frame returns to [Date Format].

- 4 Press the four-way controller (▼), and press the four-way controller (▶).

The frame moves to the month if the date format is set to [mm/dd/yy].

- 5 Use the four-way controller (▲▼) to set the month.

Set the day and year in the same manner. Next, set the time.

If you select [12h] in Step 2, the camera switches between am and pm depending on the time.

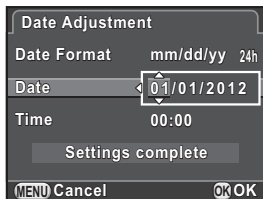

6 Press the four-way controller (▼) to select [Settings complete], and press the OK button.

The camera is ready to take a picture.

If you set the date and time from the menu, the [Set-up 1] menu reappears.

In this case, press the **MENU** button.

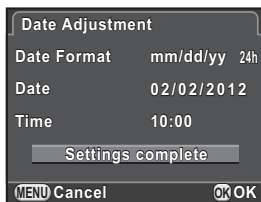

Pressing the **MENU** button while setting the date and time cancels the settings made up to that point and switches the camera to capture mode. After initial settings are complete, if the camera power is turned off before the date and time settings are complete, the [Date Adjustment] screen will appear the next time you turn the camera on. You can set the date and time from the menu later. (p.187)



- When you press the **OK** button in Step 6, the seconds value is set to 0. To set the exact time, press the **OK** button when the time signal (on the TV, radio, etc.) reaches 0 seconds.
- You can change the language and date and time settings from the menu. (p.187, p.190)

Memo

3 Basic Operations

This chapter explains basic operations for shooting by setting the mode dial to **AUTO** (Auto Picture) to have the camera select the optimum settings based on the subject. For information about advanced functions and settings for taking pictures, refer to chapter 4 and onward.

Basic Shooting Operation	56
Using the Built-in Flash	59
Reviewing Images	64

Letting the Camera Choose the Optimal Settings

This camera features various capture modes, focus modes, and drive modes. This section explains how to take pictures by simply pressing the shutter release button.

3

Basic Operations

1 Set the mode dial to **AUTO**.

The capture mode is set to **AUTO** mode.

- ☛ Selecting the Appropriate Capture Mode (p.74)

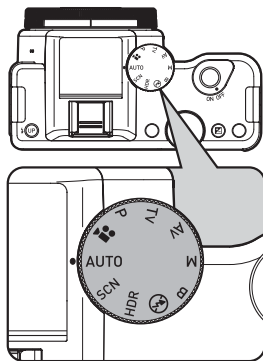

2 Set the focus mode switch to **AF**.

The focus mode changes to the autofocus mode.

- ☛ Setting the Focus Mode (p.92)

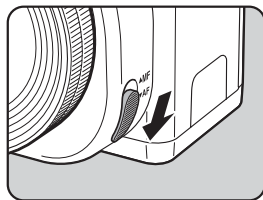

3 View the subject on the monitor.

When using a zoom lens, turn the zoom ring to the right or left to change the angle of view (focal length).

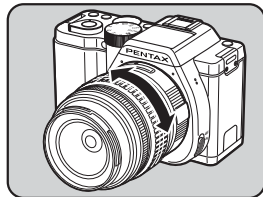

4 Position the subject inside the AF frame, and press the shutter release button halfway.

The autofocus system operates.

The AF frame turns green and you will hear a beep when the subject comes into focus (focus lock).

When set to **AUTO** mode, the optimal capture mode is automatically selected from ☺ (Standard), 🗿 (Portrait), ▲ (Landscape), * (Macro), 🏃 (Moving Object), 🌃 (Night Scene Portrait), 🌅 (Sunset), ☁ (Blue Sky) or 🌲 (Forest). (p.75)



AF frame

The built-in flash pops up automatically when necessary.

5 Press the shutter release button fully.

The picture is taken.

This action is referred to as “releasing the shutter” or “release”.

6 Review the captured image on the monitor.

The image appears for 1 second on the monitor shortly after it is captured (Instant Review).

☞ Setting the Display for Instant Review (p.191)

The following operations can be performed during Instant Review.

Available operations

E-dial	Magnifies the image. (p.157)
⏏/🗑️ button	Deletes the image. (p.65)
📷/Av button	Saves the image in RAW format. (p.64)



- You can enlarge the central area in focus by pressing the **OK** button while the focus is locked (except when [Autofocus Method] is set to **MF** (Tracking)). (p.95)
- The beep that sounds when the image is focused can be turned off. (p.186)
- You can set the camera so that it automatically focuses when the **AF/AE-L** button is pressed. (p.96)
- You can preview the image on the monitor and check the depth of field before shooting. (p.99)



Power Zoom functions (Image Size Tracking, Zoom Clip and Auto Zoom Effect) are not compatible with this camera.

Use a flash to take pictures in low light or backlit conditions. The built-in flash is optimum for a subject at a distance from 0.7 m to 5 m. Vignetting (darkening of the corners of the image due to a lack of light) may occur when used at a distance closer than 0.7 m (this distance varies slightly depending on the lens being used and the sensitivity setting. (p.218))









- When using the built-in flash, remove the lens hood before shooting. Vignetting may occur depending on the lens being used and the capture conditions. Refer to “Lens Compatibility with the Built-in Flash” (p.219) for details.
- The built-in flash fully discharges when using a lens without an **A** (Auto) position.



For details on the built-in flash and instructions on how to take pictures with an external flash, refer to “Using the Flash” (p.215).

Setting the Flash Mode

Flash Mode	Function
 Auto Flash Discharge	Automatically measures the ambient light and determines whether to use the flash.
 Auto Flash+ Red-eye Reduction	Discharges a pre-flash for red-eye reduction before the automatic flash.
 Manual Flash Discharge	Discharges the flash manually. Discharges when the flash is popped up, and does not discharge when it is retracted.
 Manual Flash+ Red-eye Reduction	Discharges the flash manually. Discharges a pre-flash for red-eye reduction before the main flash.
 Slow-speed Sync	Sets to a slow shutter speed depending on the brightness. When using this to shoot a portrait with the sunset in the background, both the person and the background are captured beautifully.
 Slow-speed Sync+ Red-eye	Discharges a pre-flash for red-eye reduction before the main flash is discharged with Slow-speed Sync.
 Trailing Curtain Sync	Discharges the flash immediately before closing the shutter. Captures moving objects as if they are leaving a trail behind. (p.217)

The flash modes that can be selected differ depending on the capture mode.

Capture Mode	Selectable Flash Mode
AUTO/SCN	⚡ ^A / ⚡ [Ⓜ] / ⚡ / ⚡ [Ⓜ]
P/Av	⚡ / ⚡ [Ⓜ] / ⚡ ^{SLOW} / ⚡ ^{SLOW} / ⚡ ^{SLOW} / ⚡ ^{SLOW}
Tv/M/B	⚡ / ⚡ [Ⓜ] / ⚡



The flash does not discharge in the following capture modes:

- **HDR**, , or mode
- (Sunset) or (Blue Sky) of **AUTO** mode
- (Sunset), (Blue Sky), (Night Scene), (Night Scene HDR), (Backlight Silhouette), (Candlelight), (Stage Lighting) or (Museum) of **SCN** mode

1 Press the four-way controller (◀) in standby mode.

The Flash Mode setting screen appears.

The flash modes that can be selected for the set capture mode appear.

2 Use the four-way controller (◀▶) to select a flash mode, and press the OK button.

The camera is ready to take a picture.



A red ⚡ blinks while the built-in flash is charging.

Compensating Flash Output

You can change the flash output in a range of -2.0 to +1.0. The following flash compensation values can be set according to the step interval set in [1. EV Steps] (p.72) of the [C Custom Setting 1] menu.

EV Steps	Selectable Flash Compensation Value
1/3 EV	-2.0, -1.7, -1.3, -1.0, -0.7, -0.3, 0.0, +0.3, +0.7, +1.0
1/2 EV	-2.0, -1.5, -1.0, -0.5, 0.0, +0.5, +1.0

1 Press the four-way controller (▼) in Step 2 on p.60.

2 Turn the e-dial.

The flash compensation value is set.

Press the  (G) button to reset the value to 0.0.













- When the flash output exceeds its maximum amount, the compensation will not be effective even if the compensation value is set to the plus (+) side.
- Compensating to the minus (-) side may have no effect if the subject is too close, the aperture is set to a large opening, or the set sensitivity is high.
- The flash output compensation is also effective for external flash units which support P-TTL auto flash mode.

Shooting with Auto Flash

The flash pops up and discharges automatically when necessary, such as when using a shutter speed which is likely to cause camera shake or in backlit conditions. The flash may pop up but may not discharge if the camera determines that the flash is not necessary.





The auto flash mode is available only when the mode dial is set to **AUTO** or **SCN** (except , , , , , , , or ).

1 Set the flash mode to  or .

2 Press the shutter release button halfway.

The flash mode icon changes according to the mode that the camera selects.

When  or  is selected, the built-in flash pops up and begins charging. If the camera determines that the flash is not necessary, the flash mode icon will not be shown.

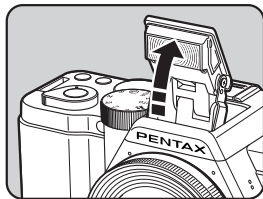



3 Press the shutter release button fully.

The picture is taken.

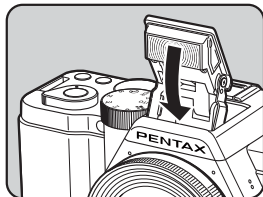
4 Push down on the top of the flash in the direction indicated in the illustration to retract the built-in flash.



Press the /  button while the built-in flash is popped up to switch between the auto flash and manual flash modes.

Shooting with Manual Flash

Discharges the flash for each picture.

1 Set the flash mode to **⚡** or **⚡Ⓞ**.

2 Press the **⚡UP/🗑** button.

The built-in flash pops up and begins charging.

When you do not want the flash to discharge, keep the built-in flash retracted.

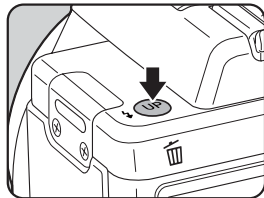

3 Press the shutter release button fully.

The flash discharges and the picture is taken.

4 Push down on the top of the flash in the direction indicated in the illustration to retract the built-in flash.

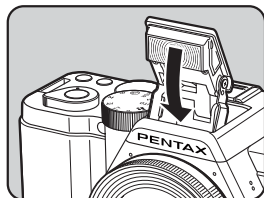

- When the mode dial is set to **Ⓞ** (Flash Off), the built-in flash will not pop up even if the **⚡UP/🗑** button is pressed.
- By default, you cannot take pictures while the built-in flash is being charged. If you want to take pictures while charging the built-in flash, set [12. Release While Charging] (p.72) to [On] in the [C Custom Setting 2] menu.

Playing Back Images

You can play back captured images with the camera.

1 Press the **PLAY** button.

The camera switches to the single image display of playback mode and the most recently captured image (image with the highest file number) is displayed on the monitor. (For movies, only the first frame is displayed on the monitor.)

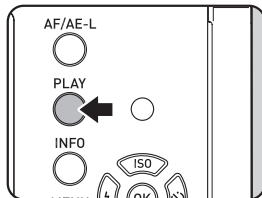

2 Press the four-way controller (**◀▶**).

◀: Displays the previous image.

▶: Displays the next image.

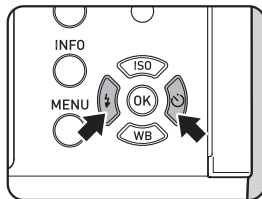

- Refer to “Playback Functions and Image Editing” (p.153) for details on the playback functions.
- When the file format of the last captured image is JPEG, and its RAW data still remains in the buffer memory, you can save the RAW image by pressing the **Av** button during Instant Review or playback (if [Save RAW Data] is set to (On) in [Instant Review] of the [Rec. Mode 3] menu (p.191)). If the image was captured using any of the following settings, the corresponding image listed is saved.
 - Multi-exposure RAW image with Multi-exposure
 - Interval Shooting RAW image for the last captured image
 Images captured with Continuous Shooting, Exposure Bracketing, HDR Capture or Digital Filter cannot be saved in RAW format.

Deleting a Single Image

You can delete images one by one.



- Deleted images cannot be restored.
- Protected images cannot be deleted. (p.200)

1 Press the **PLAY** button, and use the four-way controller (**◀▶**) to display an image to delete.

2 Press the **⚡UP/🗑️** button.

The delete confirmation screen appears.

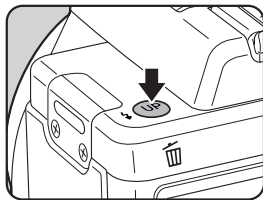

3 Press the four-way controller (**▲**) to select **[Delete]**.

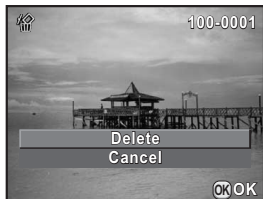

4 Press the **OK** button.

The image is deleted.



- You can delete multiple images at once. Refer to “Deleting Multiple Images” (p.163) for details.
- For the images captured with [File Format] (p.127) set to [RAW+], you can select the file format to delete in Step 3.

Memo

4 Shooting Functions

This chapter describes the various basic and advanced shooting functions available with this camera.

How to Operate the Shooting Functions	68
Selecting the Appropriate Capture Mode	74
Setting the Exposure	79
Focusing	92
Checking the Depth of Field (Preview)	99
Using the Shake Reduction Function to Prevent Camera Shake	100
Taking Pictures Continuously	106
Recording Movies	113

How to Operate the Shooting Functions

You can change capture-related settings using the direct keys, control panel, [📷 Rec. Mode] menu, [🎥 Movie] menu or [C Custom Setting] menu.



For details on how to use the menus, refer to "Using the Menus" (p.33).

Direct Keys Setting Items

Press the four-way controller (▲▼◀▶) in standby mode to set the following items.

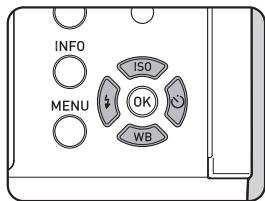

Key	Item	Function	Page
▲	Sensitivity	Sets the ISO sensitivity.	p.79
▼	White Balance	Adjusts the color balance to match the type of the light source illuminating the subject.	p.130
◀	Flash Mode	Sets the method of flash discharge.	p.59
▶	Drive Mode	Selects Single Frame Shooting, Continuous Shooting, Self-timer, Remote Control or Exposure Bracketing.	p.106 p.102 p.104 p.85

Rec. Mode Menu Items

The following items are available in the [📷 Rec. Mode 1-3] menus.

Press the **MENU** button in standby mode to display the [📷 Rec. Mode 1] menu.

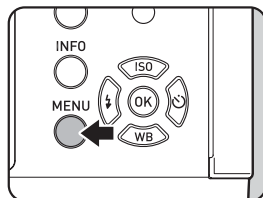



Menu	Item	Function	Page	
📷 1	Custom Image *1 *2	Sets the image finishing tone such as color and contrast before shooting an image.	p.140	
	Digital Filter *1	Applies a digital filter effect when taking pictures.	p.144	
	HDR Capture *1	Enables capturing images with high dynamic range.	p.135	
	Image Capture Settings	Aspect Ratio *1	Sets the horizontal and vertical ratio of images.	p.126
		File Format *1	Sets the file format.	
		JPEG Recorded Pixels *1	Sets the recording size of images saved in JPEG format.	
		JPEG Quality *1	Sets the quality of images saved in JPEG format.	
		Color Space	Sets the color space to use.	
	AE Metering *1	Selects the part of the sensor to use for measuring brightness and determining exposure.	p.88	
	AF/MF Settings	Autofocus Method *1	Selects the autofocus method in AF mode.	p.93
		AF Autozoom	Automatically magnifies the monitor image, centering on the area in focus, after the focus is locked.	p.95
		AF Assist Light	Sets whether to use the AF assist light when autofocusing in dark locations.	p.92
		Focus Peaking	Emphasizes the outline of the subject in focus and makes it easier to check the focus.	p.98
	Lens Correction *1	Reduces distortions and lateral chromatic aberrations occurring due to lens properties.	p.138	

Menu	Item	Function	Page
☑2	Multi-exposure	Creates a picture by taking multiple exposures and merging them into a single image.	p.111
	Interval Shooting	Takes pictures at a set interval from a set time.	p.108
	D-Range Setting *1	Expands the dynamic range and prevents bright and dark areas from occurring.	p.133 p.134
	High-ISO NR	Sets the Noise Reduction setting when shooting with a high ISO sensitivity.	p.89
	Slow Shutter Speed NR	Sets the Noise Reduction setting when shooting with a slow shutter speed.	p.91
	Shake Reduction *1	Activates the Shake Reduction function.	p.100
	Input Focal Length	Sets the focal length when using a lens for which focal length information cannot be obtained.	p.234
☑3	Live View	Sets the Live View display settings.	p.190
	Instant Review	Sets the Instant Review display settings.	p.191
	Button Customization	Sets the function of the  (G/R) button or AF/AE-L button.	p.147
	Memory	Determines which settings to save when the power is turned off.	p.195
	GPS	Sets the action for when the optional GPS unit is attached to the camera.	p.244

*1 Can be also set through the control panel.

*2 When the mode dial is set to **SCN**, [Scene Mode] appears instead.

Movie Menu Items

The following items are available in the [ Movie 1] menu. Press the **MENU** button when the mode dial is set to  to display the [ Movie 1] menu.

Menu	Item	Function	Page	
 1	Exposure Setting *1	Selects the movie exposure mode from P , Av , or M mode.	p.113	
	Movie Capture Settings	Recorded Pixels *1		Sets the number of recorded pixels and size of the movie.
		Framerate *1		Sets the number of frames shot per second.
		Quality Level *1		Sets the quality level of the movie.
	Recording Sound Level *1	Sets the microphone sensitivity.		
	Movie SR *1	Activates the Shake Reduction function.		
	Interval Movie	Takes still pictures at a set interval from a set time and saves it as a single movie file.	p.119	

*1 Can also be set through the control panel.

Custom Setting Menu Items



The following items of the [C Custom Setting 1-3] menus enable you to make the best use of the camera.

Menu	Item	Function	Page
C1	1. EV Steps	Sets the adjustment steps for exposure.	p.84
	2. Sensitivity Steps	Sets the adjustment steps for ISO sensitivity.	p.80
	3. Expanded Sensitivity	Expands the lower and upper sensitivity limits.	p.80
	4. AE-L with AF Locked	Sets whether to lock the exposure value when the focus is locked.	p.87
	5. Link AE to AF Point	Sets whether to link the exposure and AF point in the focusing area when [AE Metering] is set to  (Multi-segment).	p.88
	6. Auto Bracketing Order	Sets the order for Exposure Bracketing shooting.	p.85
	7. Bulb (B) Mode Options	Sets the operation when pressing the shutter release button in B mode.	p.83
C2	8. WB When Using Flash	Sets the white balance setting when using flash.	p.131
	9. AWB in Tungsten Light	Sets whether to adjust the tungsten light color tone when the white balance is set to AWB (Auto White Balance).	-
	10. AF Release Options	Sets the action priority for when the shutter release button is fully pressed in AF mode.	p.93
	11. AF with Remote Control	Sets whether to use autofocus when shooting with a remote control unit.	p.105
	12. Release While Charging	Sets whether to release the shutter while the built-in flash is charging.	p.63
	13. Save Rotation Info	Sets whether to save rotation information when shooting.	p.156
	14. Save Menu Location	Sets whether to save the last menu tab displayed on the monitor and to display it again the next time the MENU button is pressed.	p.193

Menu	Item	Function	Page
C3	15. Shake Reduction Options	Sets whether to use Shake Reduction during standby mode as well.	p.101
	16. Using Aperture Ring	Sets whether to enable shutter release when the lens aperture ring is set to a position other than A .	p.235
	Reset Custom Functions	Resets all the settings in the [C Custom Setting 1-3] menus to the defaults.	p.197

Selecting the Appropriate Capture Mode

This camera features various capture modes, enabling you to take pictures with settings suited for your photographic vision. In this manual, the capture modes are referred to as follows.

Capture Mode	Characteristics	Page
AUTO (Auto Picture) mode	Automatically selects the optimal capture mode for the subject.	p.75
SCN (Scene) mode	Lets you choose the capture mode from various scene styles.	p.76
HDR mode	Captures 3 images to generate a single HDR image and provides a wider dynamic range.	p.137
 (Flash Off) mode	Deactivates the flash.	—
Exposure modes (P/Tv/Av/M/B)	Changes the shutter speed and aperture value, and takes pictures.	p.78
 (Movie) mode	Records a movie.	p.116

- 1 Turn the mode dial to set the desired capture mode on the mode dial to the dial indicator.

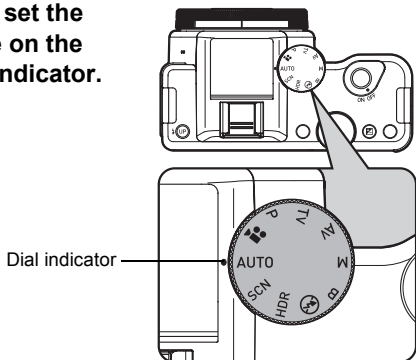

The selected capture mode is displayed on the monitor (guide display).



- You can set the camera to not display the guides in [LCD Display] of the [Set-up 1] menu. (p.192)
- The Scene Mode selection screen appears when the mode dial is set to **SCN**. (p.77)



















Auto Picture Modes





When set to **AUTO** (Auto Picture) mode, the camera automatically selects the optimal mode from the following capture modes for the subject.

Mode	Characteristics
Standard	This mode is selected when none of the following modes apply.
Portrait	For capturing portraits. Reproduces a healthy and bright skin tone.
Landscape	For capturing landscape views. Increases color saturation and produces a vivid color image.
Macro	For capturing tiny objects at close focus range like flowers, coins, jewelry, and more.
Moving Object	For capturing images of fast moving subjects, such as at sporting events.
Night Scene Portrait	For capturing images of people in low light conditions, such as dusk or at night. Even though the flash is used, the camera will use slow shutter speeds so the background areas beyond the flash reach will also appear correctly exposed in the picture (Slow-speed Sync (p.216)). To prevent camera shake, either set [Shake Reduction] (p.100) to (On) or mount the camera on a tripod.
Sunset	For capturing sunrises or sunsets in beautiful, vivid color.
Blue Sky	For capturing images of blue sky. Produces a more impressive deep blue.
Forest	Enhances colors of trees and sunbeams through foliage and produces a vivid color image.









Scene Modes

In **SCN** (Scene) mode, you can choose from the following shooting scenes.

Mode	Characteristics
 Portrait	For capturing portraits. Reproduces a healthy and bright skin tone.
 Landscape	For capturing landscape views. Increases color saturation and produces a vivid color image.
 Macro	For capturing tiny objects at close focus range like flowers, coins, jewelry, and more.
 Moving Object	For capturing images of fast moving subjects, such as at sporting events. The drive mode is fixed to  (Continuous Shooting (Hi)).
 Night Scene Portrait	For capturing images of people in low light conditions, such as dusk or at night. Even though the flash is used, the camera will use slow shutter speeds so the background areas beyond the flash reach will also appear correctly exposed in the picture (Slow-speed Sync (p.216)). To prevent camera shake, either set [Shake Reduction] (p.100) to  (On) or mount the camera on a tripod.
 Sunset	For capturing sunrises or sunsets in beautiful, vivid color.
 Blue Sky	For capturing images of blue sky. Produces a more impressive deep blue.
 Forest	Enhances colors of trees and sunbeams through foliage and produces a vivid color image.
 Night Scene	Used for shooting at night. Use a tripod or flat surface to prevent camera shake blur.
 Night Scene HDR	Generates a single HDR image with less noise from 3 images (-3 EV, Standard, and +3 EV) captured in dim lighting. The file format is fixed to [JPEG].
 Night Snap	For taking snapshots in poorly lit place.
 Food	For capturing images of food. Saturation will be rather high to make it look appetizing.
 Pet	For capturing moving pets. The drive mode is fixed to  (Continuous Shooting (Hi)).
 Kids	For capturing moving kids. Reproduces healthy and bright skin tone. The drive mode is fixed to  (Continuous Shooting (Hi)).

Mode	Characteristics
 Surf & Snow	For capturing images of dazzling backgrounds, such as snowy mountains.
 Backlight Silhouette	Produces a silhouette image of subject in backlight condition.
 Candlelight	For capturing scenes in candlelight.
 Stage Lighting	For capturing moving subjects in poorly lit place.
 Museum	For capturing images in places where a flash is prohibited.



The flash is deactivated in , , , , , , , and  modes. To prevent camera shake, either set [Shake Reduction] (p.100) to  (On) or mount the camera on a tripod.

Selecting a Scene Mode

1 Set the mode dial to SCN.

The camera switches to the **SCN** mode, and the screen to select a scene mode appears.

2 Use the four-way controller (▲▼◀▶) or e-dial to choose a scene mode, and press the OK button.

The camera is ready to take a picture.



- To change the scene mode, press the **INFO** button and select [Scene Mode] in the control panel.
- When the **MENU** button is pressed while the mode dial is set to **SCN**, the item [Scene Mode] appears on the [Rec. Mode 1] menu. Press the four-way controller (▶) to display the Scene Mode selection screen and you can select a scene mode in the same way as described in Step 2.



Exposure Modes

Use the following exposure modes to change the shutter speed and aperture value and take pictures.

Mode	Characteristics	Page
P Program Automatic Exposure	Automatically sets the shutter speed and aperture value to obtain a proper exposure according to the program line.	p.81
Tv Shutter Priority Automatic Exposure	Lets you set the desired shutter speed for expressing subject movement.	
Av Aperture Priority Automatic Exposure	Lets you set the desired aperture value for controlling the depth of field.	
M Manual Exposure	Lets you set the shutter speed and aperture value to match your photographic vision.	p.83
B Bulb Exposure	Lets you capture images that require slow shutter speeds such as fireworks and night scenes.	

Setting the Sensitivity

You can set the sensitivity to suit the brightness of the surroundings. The sensitivity can be set to [ISO AUTO] or within a sensitivity range equivalent to ISO 100 to 12800. The default setting is [ISO AUTO].

1 Press the four-way controller (▲) in standby mode.

The Sensitivity setting screen appears.

2 Use the four-way controller (▲▼) to select [ISO AUTO] or [ISO].

ISO AUTO	Sets the range to be adjusted automatically.
ISO	Sets the fixed value.



3 Use the e-dial to change the sensitivity value.

4 Press the OK button.

The camera is ready to take a picture.



- In (Night Scene HDR), (Night Snap) or (Stage Lighting) of **SCN** mode, the sensitivity is fixed to [ISO AUTO (up to ISO 6400)].
- In **B** mode, [ISO AUTO] is not displayed. If the mode dial is set to **B** when the sensitivity is set to [ISO AUTO], the sensitivity is fixed to the last set value.
- More noise may appear in captured images if a higher sensitivity is set. You can reduce image noise by using Noise Reduction. Set in [High-ISO NR] (p.70) of the Rec. Mode 2] menu.
- You can select whether to set the sensitivity in increments of 1 EV or in accordance with the EV step setting for exposure (p.84). This can be set in [2. Sensitivity Steps] (p.72) of the [**C** Custom Setting 1] menu.
- The sensitivity range can be expanded to a range of ISO 100 to 25600 when [3. Expanded Sensitivity] (p.72) in the [**C** Custom Setting 1] menu is set to [On].

Changing the Exposure Mode

This camera features the following exposure modes.

The settings available for each exposure mode are as follows.

✓: Available #: Restricted ×: Not available

Exposure Mode	Change Shutter Speed	Change Aperture Value	Change Sensitivity	EV Compensation
P Program Automatic Exposure	#*1	#*1	✓	✓
Tv Shutter Priority Automatic Exposure	✓	×	✓	✓
Av Aperture Priority Automatic Exposure	×	✓	✓	✓
M Manual Exposure	✓	✓	✓*2	×
B Bulb Exposure	×	✓	ISO AUTO: ×	×

*1 In [Button Customization] of the [Rec. Mode 3] menu, you can make the setting so that the shutter speed and/or aperture value can be changed by turning the e-dial. (p.150)

*2 When the sensitivity is set to [ISO AUTO], the camera switches to **TAv** (Shutter & Aperture Priority Automatic Exposure) mode and the sensitivity is automatically set so that a proper exposure is obtained from the set shutter speed and aperture value. When the sensitivity is set to a fixed value, images are captured with the set sensitivity.

- 1 Set the mode dial to **P**, **Tv**, **Av**, **M**, or **B**.

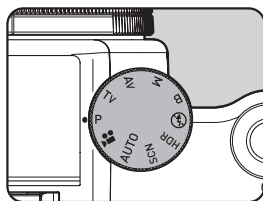

- 2 Turn the e-dial to adjust the value.

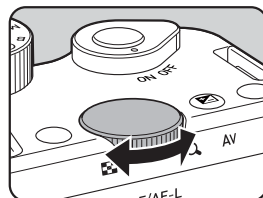

► appears on the monitor for the value that can be changed.

The following parameters can be changed depending on the selected exposure mode.



P	Item set in [Button Customization] of the [Rec. Mode 3] menu (p.150)
Tv/M/TA_v	Shutter speed
Av/B	Aperture value

4

3

When set to **M** or **TA_v** mode, press the **Av** button (1), and then turn the **e-dial** (2) to change the aperture value.

The exposure compensation value can be adjusted by this operation in **P**, **Tv**, or **Av** mode. (p.84)

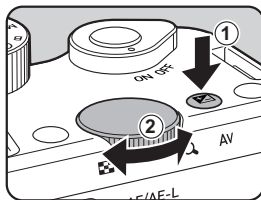

- The proper exposure may not be obtained with the selected shutter speed and aperture value when the sensitivity is set to a fixed value (p.79).
- In **M** mode, the difference from the proper exposure is displayed in a bar scale while the shutter speed or aperture value is adjusted. The exposure value blinks red when the difference from the proper exposure becomes ± 3.0 or larger.
- You can set the function of the **(G)** button when the exposure mode is set to **M** or **TA_v**. Set in [Button Customization] of the [Rec. Mode 3] menu. (p.151)

Bulb Shooting

This is useful when capturing images of night scenes and fireworks which require long exposures.

1 Set the mode dial to **B**.

2 Press the shutter release button.

The shutter remains open as long as the shutter release button is kept pressed.

3 Take your finger off the shutter release button.

Exposure ends.



- In **B** mode, the following functions are not available.
 - Continuous Shooting
 - Exposure Bracketing
 - EV Compensation
 - AE Lock
 - Interval Shooting
 - HDR Capture
 - Shake Reduction



- To operate the shutter release button in **B** mode, set in [7. Bulb (B) Mode Options] (p.72) of the [C Custom Setting 1] menu.

1	Mode1	Exposure continues while the shutter release button is pressed. (default setting)
2	Mode2	Exposure starts and ends when the shutter release button is pressed.

- More noise may appear in captured images if a slower shutter speed is set. You can reduce image noise by using Noise Reduction. Set in [Slow Shutter Speed NR] of the [Rec. Mode 2] menu. (p.91)
- Use a tripod to prevent camera shake during Bulb shooting.
- We recommend using the AC Adapter kit K-AC1202 (optional) as the battery drain is high during Bulb shooting. (p.42)

Adjusting the Exposure

This allows you to deliberately overexpose (brighten) or underexpose (darken) your picture.

The compensation value can be set between -3 and +3 EV (-2 and +2 EV in **M** mode). The value that can be set varies according to the step interval set in [1. EV Steps] (p.72) of the [C Custom Setting 1] menu.

EV Steps	Exposure Compensation Value
1/3 EV	$\pm 0.3, \pm 0.7, \pm 1.0, \pm 1.3, \pm 1.7, \pm 2.0, \pm 2.3, \pm 2.7, \pm 3.0$
1/2 EV	$\pm 0.5, \pm 1.0, \pm 1.5, \pm 2.0, \pm 2.5, \pm 3.0$

4

Shooting Functions

1 Press the **☒/Av** button (①), and then turn the e-dial (②).

The exposure is adjusted.

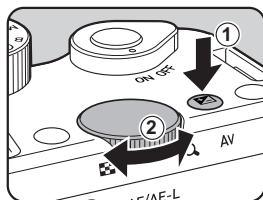

The EV bar scale and the compensation value are displayed on the monitor during adjustment.



EV bar scale

Available operations

☒/Av button	Starts/ends selecting the compensation value.
(G) button	Resets the compensation value.



- EV Compensation is not available in **M** or **B** mode.
- The set compensation value is not canceled by turning the camera off or by switching to another capture mode.

Changing the Exposure Automatically when Shooting (Exposure Bracketing)

You can take three consecutive images at three different exposure levels when the shutter release button is pressed. Three images are saved with each release.



Standard exposure



Underexposure



Overexposure

You can set the bracketing order in [6. Auto Bracketing Order] (p.72) of the [C Custom Setting 1] menu.

1	0 - +	Standard → Underexposed → Overexposed (default setting)
2	- 0 +	Underexposed → Standard → Overexposed
3	+ 0 -	Overexposed → Standard → Underexposed
4	0 + -	Standard → Overexposed → Underexposed



Exposure Bracketing is not available in the following situations.

- when **B** mode, **HDR** mode, or (Moving Object)/ (Night Scene HDR)/ (Pet)/ (Kids) of **SCN** mode is set
- when Interval Shooting, Multi-exposure or HDR Capture is set

1 Press the four-way controller (▶) in standby mode.

The Drive Mode setting screen appears.

2 Use the four-way controller (◀▶) to select .

3 Press the four-way controller (▼), and turn the e-dial to set the bracket value.

The value that can be set varies according to the step interval set in [1. EV Steps] (p.72) of the [C Custom Setting 1] menu.



EV Steps	Bracket Value
1/3 EV	±0.3, ±0.7, ±1.0, ±1.3, ±1.7, ±2.0, ±2.3, ±2.7, ±3.0
1/2 EV	±0.5, ±1.0, ±1.5, ±2.0, ±2.5, ±3.0

Available operations

/ Av button → E-dial	Adjusts the EV compensation value (when taking underexposed or overexposed images).
(G) button	Resets the compensation value.

4 Press the OK button.

The camera is ready to take a picture.



- The focus position is locked with the first image and is used for subsequent images.
- Select (Single Frame Shooting) in the Drive Mode setting screen to cancel Exposure Bracketing. The setting is canceled automatically when the camera is turned off if [Drive Mode] is set to (Off) in [Memory] of the [Rec. Mode 3] menu. (p.195)
- You can combine Exposure Bracketing with the built-in flash or an external flash (P-TTL auto only) to continuously change only the flash output. (p.221)

Locking the Exposure Before Shooting (AE Lock)

AE Lock is a function that locks the exposure (brightness) prior to taking a picture. Use this when the subject is too small or is backlit and a proper exposure setting cannot be obtained.

1 Assign [AE Lock] to the AF/AE-L button.

Refer to "Setting the AF/AE-L Button Operation" (p.152) for details.

2 Set the exposure, and press the AF/AE-L button.

The camera locks the exposure at that instant.

★ is displayed on the monitor while AE Lock is engaged.

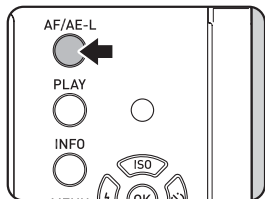

Press the AF/AE-L button again to cancel AE Lock.



- You will hear a beep when AE Lock is activated and deactivated. The beep can be turned off. (p.186)
- AE Lock is not available in **B** mode.
- If you want to also lock the exposure when the focus is locked, set [4. AE-L with AF Locked] (p.72) of the [**C** Custom Setting 1] menu to [On].
- When the shutter speed or aperture value is changed while AE Lock is engaged in **M** (Manual) mode, the combination of shutter speed and aperture value changes while the exposure remains the same. For example, when the shutter speed is 1/125 sec. and aperture value is F4 and these settings are locked, the aperture value automatically changes to F8 if the shutter speed is changed to 1/30 sec.
- When using a zoom lens whose maximum aperture varies depending on the focal length, the combination of shutter speed and aperture value changes depending on the zooming position even while AE Lock is engaged. However, the exposure value does not change and the picture is taken at the brightness level that was set when AE Lock was activated.

Selecting the Metering Method

Choose the part of the sensor to use for measuring brightness and determining exposure.

 Multi-segment	The sensor meters the brightness in multiple zones. (default setting) Even in backlit locations, this mode automatically determines what level of brightness is in which portion and automatically adjusts exposure.
 Center-weighted	Metering is weighted at the center of the sensor. The sensitivity increases at the center and no automatic adjustment is performed even during backlit scenes.
<input type="checkbox"/> Spot	The brightness is measured only within a limited area at the center of the sensor. You can use this in combination with the AE Lock function (p.87) when a subject is too small to obtain a correct exposure.

1 Press the INFO button in standby mode.

The control panel appears.

2 Use the four-way controller (▲▼◀▶) to select [AE Metering], and press the OK button.

The [AE Metering] screen appears.

3 Use the four-way controller (◀▶) to select a metering method, and press the OK button.

The camera returns to the control panel.

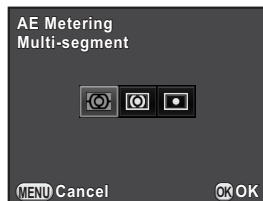

- You can also change the setting from the [Rec. Mode 1] menu.
- In [5. Link AE to AF Point] (p.72) of the [C Custom Setting 1] menu, you can link the exposure and AF point in the focusing area when  is selected.

1	Off	Exposure for multi-segment metering is determined regardless of the AF point. (default setting)
2	On	Exposure for multi-segment metering is adjusted according to the AF point.

Reducing the Image Noise (Noise Reduction)

When shooting with a digital camera, image noise (image roughness or unevenness) becomes noticeable in the following situations.

- when shooting with a high sensitivity setting
- when shooting with long exposures
- when the temperature of the CMOS sensor is high

You can reduce image noise by using Noise Reduction.



Pictures cannot be taken while Noise Reduction is being processed. In particular, if you use Slow Shutter Speed NR, it may take more time to process.

High-ISO NR

Reduces noise at high sensitivity (ISO) settings.

- 1** Select [High-ISO NR] in the [📷 Rec. Mode 2] menu, and press the four-way controller (▶).

The [High-ISO NR] screen appears.

- 2** Press the four-way controller (▶), and use the four-way controller (▲▼) to select a setting.

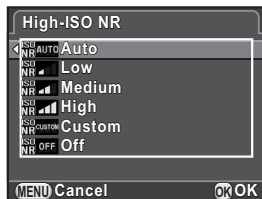

Auto	Applies Noise Reduction at optimally calculated levels throughout ISO range. (default setting)
Low/ Medium/ High	Applies Noise Reduction at constant chosen level throughout ISO range.
Custom	Applies Noise Reduction at user-defined levels for each ISO setting.
Off	Does not apply Noise Reduction at any ISO setting.

3 Press the OK button.

If you select [Auto], [Off], [Low], [Medium] or [High], proceed to Step 7.

4 Use the four-way controller (▲▼) to select [Setting], and press the four-way controller (▶).

The screen to set the noise reduction level according to the sensitivity appears.

5 Use the four-way controller (▲▼) to select a sensitivity value, and use the four-way controller (◀▶) to set the level of noise reduction which is applied to the selected sensitivity.

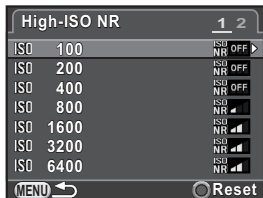

The sensitivity values displayed vary according to the [1. EV Steps] and [2.

Sensitivity Steps] (p.72) settings made in the [C Custom Setting 1] menu.

Available operations

E-dial	Switches between [High-ISO NR 1] and [High-ISO NR 2].
⊙ (G) button	Resets the set value.

6 Press the MENU button.

The screen that was displayed in Step 2 appears again.

7 Press the MENU button twice.

The camera is ready to take a picture.

Slow Shutter Speed NR

Reduces noise during long exposures.

1 Select [Slow Shutter Speed NR] in the [📷 Rec. Mode 2] menu, and press the four-way controller (▶).

2 Use the four-way controller (▲▼) to select [Auto], [On] or [Off], and press the OK button.



Auto	Determines conditions such as shutter speed, sensitivity, and internal temperature, and automatically applies Noise Reduction as necessary. (default setting)
On	Applies Noise Reduction when the shutter speed exceeds 1 second.
Off	Does not apply Noise Reduction.

3 Press the MENU button.

The camera is ready to take a picture.

Setting the Focus Mode

AF Autofocus	The camera automatically focuses on the subject when the shutter release button is pressed halfway.
MF Manual focus	The focus can be adjusted manually.

1 Set the focus mode switch to either **AF** or **MF**.

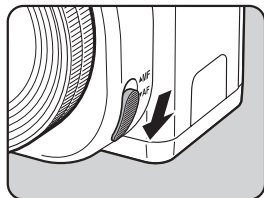

Refer to “Letting the Camera Choose the Optimal Settings” (p.56) for information on how to take pictures in **AF** mode.





Refer to “Adjusting the Focus Manually (Manual Focus)” (p.98) for information on how to take pictures in **MF** mode.



In **AF** mode, when the subject is in a dark location, the AF assist light is used when the shutter release button is pressed halfway. If you do not want to use the AF assist light, set [AF Assist Light] (p.69) to (Off) in [AF/MF Settings] of the [📷 Rec. Mode 1] menu.

Setting the Autofocus Method

Selects the autofocus method in **AF** mode.

 Face Detection	Detects and tracks faces of people. (default setting) The main face detection frame for autofocus and auto exposure is displayed in yellow.
 Tracking	Tracks the subject in focus when the shutter release button is pressed halfway.
 Select	Focuses on a desired area. The sensor is divided into 100 areas (10 horizontal by 10 vertical), and you can select a wider or narrower focusing area by using 4, 16, or 36 of those 100 areas available. (p.94)
 Spot	Focuses on a limited area at the center.

1 Press the INFO button in standby mode.

The control panel appears.





2 Use the four-way controller (▲▼◀▶) to select [Autofocus Method], and press the OK button.

The [Autofocus Method] screen appears.

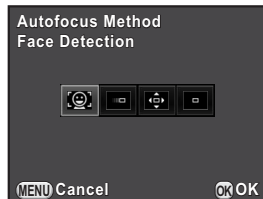
3 Use the four-way controller (◀▶) to select an autofocus method, and press the OK button.

The camera returns to the control panel.



- You can also change the setting from [Autofocus Method] (p.69) in [AF/MF Settings] of the [Rec. Mode 1] menu.
- [Autofocus Method] is fixed to  in **AUTO** mode, or  (Portrait)/ (Night Scene Portrait)/ (Kids) of **SCN** mode.
- To take pictures when the subject is not in focus, set [10. AF Release Options] (p.72) to [Release-priority] in the [C Custom Setting 2] menu.

Selecting the Desired Focusing Area

You can set the range of the autofocusing area (AF area).

- 1 Select  in Step 3 on p.93, and press the OK button.**

The camera returns to the control panel.

- 2 Press the MENU button or the shutter release button halfway.**

The camera is ready to take a picture.

- 3 Press the OK button.**

The range of the selectable area is displayed with broken lines and a white rectangle appears on it. You can set the AF area by changing the position and size of this rectangle.

- 4 Select the AF area.**

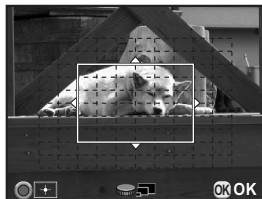

Available operations

Four-way controller (▲▼◀▶)	Changes the position of the AF area.
E-dial	Changes the size of the AF area.
⊙ (G) button	Returns the AF area to the center.

- 5 Press the OK button or the shutter release button halfway.**

The AF area is set.



The set AF area is saved in the memory even if the autofocus method is changed or the camera is turned off.

Checking the Focus

You can check the focus lock position (AF point) by magnifying the image on the monitor, centering around the area in focus.

1 View the subject on the monitor, and press the shutter release button halfway.

The autofocus system operates.

2 Press the OK button while keeping the shutter release button pressed halfway.

While the shutter release button is pressed halfway, the image on the monitor is magnified centering around the AF point.

3 Use the e-dial to change the magnification.

Magnification can be selected from 2 to 6 times.



4 Press the OK button or stop pressing the shutter release button halfway.

The camera returns to standby mode.



- When [AF Autozoom] is set to (On) in [AF/MF Settings] of the [Rec. Mode 1] menu, the camera automatically magnifies the image 1 second after the focus is locked.
- In **MF** mode, an image can be magnified by simply pressing the **OK** button. (p.98)



An image cannot be magnified when [Autofocus Method] is set to **TRK** (Tracking).

Focusing Using the AF/AE-L Button

You can set the camera so that pressing the **AF/AE-L** button focuses automatically, in the same way as pressing the shutter release button halfway.

1 Assign [Enable AF1] or [Enable AF2] to the AF/AE-L button.

Refer to "Setting the **AF/AE-L** Button Operation" (p.152) for details. By default, autofocus can be performed by either pressing the shutter release button halfway or using the **AF/AE-L** button.

2 While viewing the subject on the monitor, press the AF/AE-L button.

The autofocus system operates.

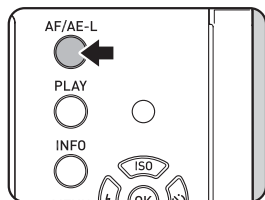

Locking the Focus (Focus Lock)

When the subject is in focus in **AF** mode, the focus is locked while the shutter release button is pressed halfway and the picture can be recomposed (except when [Autofocus Method] is set to ).

Below is an example of how to capture an image using the focus lock function when [Autofocus Method] is set to .

1 Set the focus mode to **AF**, and [Autofocus Method] to .

2 Frame the desired composition for your picture on the monitor.

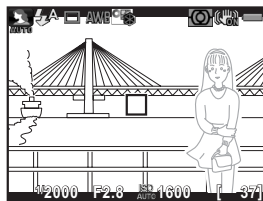

3 Center the subject to focus on the monitor, and press the shutter release button halfway.

The AF frame turns green when focused. The focus is locked while the AF frame is green.

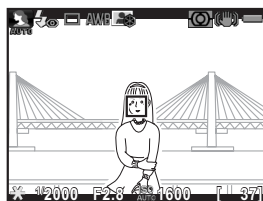

4 Recompose the picture while keeping the shutter release button pressed halfway.

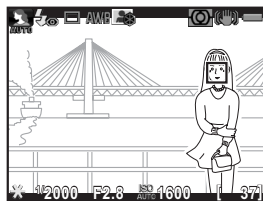

Turning the zoom ring with the focus locked may cause the subject to be out of focus.

Adjusting the Focus Manually (Manual Focus)

Manually adjust the focus.

1 Set the focus mode to MF.

2 While viewing the monitor, turn the focusing ring.

The shutter can be released by pressing the shutter release button fully even if the subject is not in focus.

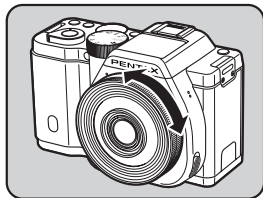

3 When it is difficult to check the focus, press the OK button.

The image on the monitor is magnified.

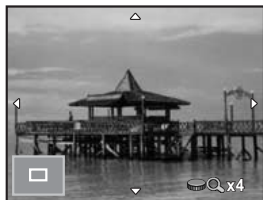

Available operations

Four-way controller (▲▼◀▶)	Moves the display area.
⊙ (G) button	Changes the display area to the center.

4 Press the OK button or the shutter release button halfway.

The camera returns to standby mode.



When [Focus Peaking] is enabled in [AF/MF Settings] of the [Rec. Mode 1] menu, the outline of the subject in focus is emphasized and makes it easier to check the focus. When [Focus Peaking] is assigned to the ⊙ (G/R) button, the Focus Peaking function can be turned on or off by pressing the ⊙ (G/R) button. (p.147)

You can check the depth of field by stopping down the aperture of the lens to the actual set value.

1 Assign [Preview] to the \odot (G/R) button.

Assign [Preview] to one of the two buttons.

Refer to "Setting the \odot Button Operation" (p.147) for details.

2 View the subject on the monitor, and press the shutter release button halfway.

The autofocus system operates.

3 Press the \odot (G/R) button.

Press the button that you assigned [Preview] to in Step 1.

You can check the depth of field on the monitor while the button is pressed.

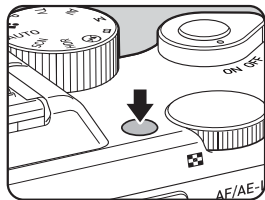

4 Take your finger off the \odot (G/R) button.

Preview is ended and the camera returns to standby mode.

Using the Shake Reduction Function to Prevent Camera Shake

Taking Pictures Using the Shake Reduction Function

The Shake Reduction function reduces camera shake that occurs when the shutter release button is pressed. This is useful for taking pictures in situations where camera shake is likely to occur.

The Shake Reduction function works effectively when taking pictures in the following situations.

- when taking pictures in dimly lit locations, such as indoors, at night, on cloudy days and in the shade
- when taking telephoto pictures



- The Shake Reduction function does not compensate for blurring caused by subject movement. To take pictures of a moving subject, increase the shutter speed.
- The Shake Reduction function may not fully reduce camera shake when taking close-up shots. In this case, it is recommended to deactivate the Shake Reduction function and use the camera with a tripod.
- The Shake Reduction function will not fully work when shooting with a very slow shutter speed, for example when panning or capturing images of night scenes. In this case, it is recommended to deactivate the Shake Reduction function and use the camera with a tripod.
- The Shake Reduction function is available with any PENTAX lens compatible with this camera. However, be sure to set the focal length when using a lens for which focal length information cannot be automatically obtained. Refer to "Functions Available with Various Lens Combinations" (p.232) for details.

1 Press the INFO button in standby mode.

The control panel appears.



2 Use the four-way controller (▲▼◀▶) to select [Shake Reduction], and press the OK button.

The [Shake Reduction] screen appears.

3 Use the four-way controller (◀▶) to select or , and press the OK button.

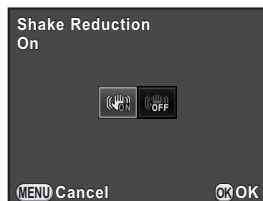
The camera returns to the control panel.



 On	Uses Shake Reduction. (default setting)
 Off	Does not use Shake Reduction.



4 Press the shutter release button halfway.

 appears on the monitor and the Shake Reduction function is activated.





Be sure to set to  when using the camera with a tripod.





- You can also change the settings from the [Rec. Mode 2] menu (p.70).
- [Shake Reduction] is fixed to  in the following situations.
 - Self-timer shooting
 - Remote Control shooting
 - when **B** mode is set
 - when HDR Capture is set, and [Auto Align] is set to □ (Off)
- [Shake Reduction] is fixed to  in  (Night Scene HDR) of **SCN** mode.
- You can select whether to use the Shake Reduction function only when taking pictures or during standby mode as well with [15. Shake Reduction Options] (p.73) from the [C Custom Setting 3] menu. To extend the battery life, set this to not operate during standby mode.
- The Shake Reduction function will not fully work (for about 2 seconds) immediately after the camera is turned on or is restored from Auto Power Off. Wait for the Shake Reduction function to work stably and properly before shooting.

Shooting with the Self-timer



 Self-timer (12 sec.)	The shutter is released after about 12 seconds. Use this mode to include the photographer in the picture.
 Self-timer (2 sec.)	The shutter is released about 2 seconds after the shutter release button is pressed. Use this mode to avoid camera shake when the shutter release button is pressed.



Shooting with the self-timer is not available in  (Moving Object)/ (Pet)/ (Kids) of SCN mode.

4

Shooting Functions

- 1** Mount the camera onto a tripod.
- 2** Press the four-way controller (▶) in standby mode.
The Drive Mode setting screen appears.
- 3** Use the four-way controller (◀▶) to select .
- 4** Press the four-way controller (▼), use the four-way controller (◀▶) to select  or , and press the OK button.

The camera is ready to take a picture.





- 5** Press the shutter release button halfway.

The autofocus system operates.



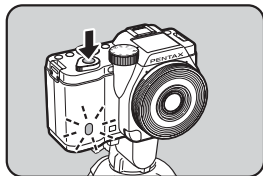

6 Press the shutter release button fully.

For , the self-timer lamp starts blinking slowly and then blinks rapidly 2 seconds before the shutter is released. A beep is heard and the rate increases. The shutter will be released about 12 seconds after the shutter release button is pressed fully.





For , the shutter will be released about 2 seconds after the shutter release button is pressed fully.



- Select  (Single Frame Shooting) in the Drive Mode setting screen to cancel shooting with the self-timer. The setting is canceled automatically when the camera is turned off if [Drive Mode] is set to  (Off) in [Memory] of the  [Rec. Mode 3] menu. (p.195)
- The Shake Reduction function is fixed to  (Off).
- You can set the camera so that the beep does not sound. (p.186)



Shooting with a Remote Control Unit (Optional)

The shutter can be released from a distance by using an optional remote control unit (p.242).



 Remote Control	The shutter is released immediately after the shutter release button on the remote control unit is pressed.
 Remote Control (3 sec. delay)	The shutter is released about 3 seconds after the shutter release button on the remote control unit is pressed.



Shooting with a remote control unit is not available in the following situations.

- when **B** mode, or  (Moving Object)/ (Pet)/ (Kids) of **SCN** mode is set
- when Interval Shooting is set

4

- 1 Mount the camera onto a tripod.**
- 2 Press the four-way controller (▶) in standby mode.**
The Drive Mode setting screen appears.
- 3 Use the four-way controller (◀▶) to select .**
- 4 Press the four-way controller (▼), use the four-way controller (◀▶) to select  or , and press the OK button.**

The remote control receiver on the front of the camera will blink and the camera is in a standby status.



- 5 Press the shutter release button halfway.**

The autofocus system operates.

- 6** Point the remote control unit towards the remote control receiver on the front of the camera, and press the shutter release button on the remote control unit.

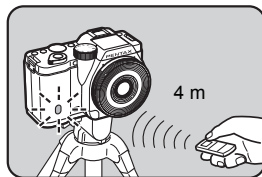

The maximum operating distance of the remote control unit is about 4 m from the front of the camera.



After a picture is taken, the remote control receiver lights for 2 seconds and then returns to blinking.





- By default, you cannot adjust the focus with the remote control unit. Focus on the subject first with the camera before operating with the remote control unit. When [11. AF with Remote Control] (p.72) is set to [On] in the [C Custom Setting 2] menu, you can use the remote control unit to adjust the focus.
- Select (Single Frame Shooting) in the Drive Mode setting screen to cancel shooting with a remote control unit. The setting is canceled automatically when the camera is turned off if [Drive Mode] is set to (Off) in [Memory] of the [Rec. Mode 3] menu. (p.195)
- The Shake Reduction function is fixed to (Off).
- Shooting with a remote control unit may not be available in backlit conditions.
- When using the Remote Control Waterproof O-RC1, the autofocus system can be operated with the $\frac{1}{4}$ button. The Fn button cannot be used.
- The Remote Control F can send a remote control signal about 30,000 times. Contact a PENTAX Service Center to replace the battery (this will involve a fee).

Continuous Shooting

Pictures can be taken continuously while the shutter release button is fully pressed.

	Continuous Shooting (Hi)	Up to approximately 6 frames per second can be taken continuously (for JPEG images). Not available when the file format is set to [RAW] or [RAW+].
	Continuous Shooting (Lo)	Up to approximately 3 frames per second can be taken continuously (for JPEG images).



- Continuous Shooting is not available in the following situations.
 - when  (Night Scene HDR) of **SCN** mode, **B** mode, or **HDR** mode is set
 - when Interval Shooting or HDR Capture is set
- You cannot save RAW images during Instant Review or playback when  or  is selected.

1 Press the four-way controller (▶) in standby mode.

The Drive Mode setting screen appears.

2 Use the four-way controller (◀▶) to select .

3 Press the four-way controller (▼), use the four-way controller (◀▶) to select or , and press the OK button.

The camera is ready to take pictures continuously.



4 Press the shutter release button halfway.

The autofocus system operates.

5

Press the shutter release button fully.

Pictures are taken continuously while the shutter release button is fully pressed. Take your finger off the shutter release button to stop.



- The shooting mode is fixed to in (Moving Object)/ (Pet)/ (Kids) of **SCN** mode.
- The focus position is locked with the first image and is used for subsequent images.
- If the file format is changed to [RAW] or [RAW+] while is selected, the shooting mode is temporarily changed to .
- The shutter cannot be released until charging is complete when using the built-in flash. Set [12. Release While Charging] to [On] in the [C Custom Setting 2] menu to enable shutter release before the built-in flash is ready. (p.63)
- Select (Single Frame Shooting) in the Drive Mode setting screen to cancel Continuous Shooting. The setting is canceled automatically when the camera is turned off if [Drive Mode] is set to (Off) in [Memory] of the [Rec. Mode 3] menu. (p.195)

Interval Shooting

Takes pictures at a set interval from a set time.

The following items can be set.

Interval	Set the time interval between shots from 1 second to 24 hours.
Number of Shots	Set from 2 to 999. The number of images that can be set varies depending on the shooting conditions such as the amount of available space on the SD Memory Card.
Start Interval	Select whether to take the first picture now or at a set time. Selecting [Now] starts recording immediately. When [Set Time] is selected, set [Start Time].
Start Time	Set the time at which to start shooting.



Interval Shooting is not available in the following situations.

- when **B** mode or mode is set
- when Multi-exposure is set

4

Shooting Functions

- 1** Select [Interval Shooting] in the [Rec. Mode 2] menu, and press the four-way controller (▶).

The [Interval Shooting] screen appears.

- 2** Use the four-way controller (▲▼) to select [Interval], and press the four-way controller (▶).

- 3** Use the four-way controller (◀▶) to select hours, minutes, or seconds, and use the four-way controller (▲▼) to set the time.

Press the **OK** button to complete the setting.

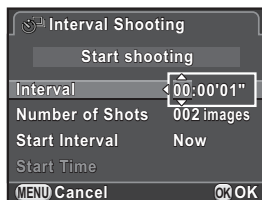

- 4** Use the four-way controller (▲▼) to select [Number of Shots], and press the four-way controller (▶).

- 5** Press the four-way controller (◀▶), and use the four-way controller (▲▼) to select the number of shots to be taken.

Press the **OK** button to complete the setting.

6 Use the four-way controller (▲▼) to select [Start Interval], and press the four-way controller (▶).

7 Use the four-way controller (▲▼) to select [Now] or [Set Time], and press the **OK** button.

If you selected [Now], proceed to Step 10.

8 Use the four-way controller (▲▼) to select [Start Time], and press the four-way controller (▶).

9 Use the four-way controller (◀▶) to select hours or minutes, and use the four-way controller (▲▼) to set the time.

Press the **OK** button to complete the setting.

10 Use the four-way controller (▲▼) to select [Start shooting], and press the **OK** button.

The camera is ready to take a series of interval pictures.

11 Press the shutter release button halfway.

The autofocus system operates.

The focus during Interval Shooting is locked at this position.

12 Press the shutter release button fully.

When [Start Interval] is set to [Now], the first picture is taken. When set to [Set Time], shooting starts at the set time.

For shooting multiple pictures, pictures are taken at the interval set in Step 3.

To cancel Interval Shooting, press the **MENU** button.

After the set number of pictures are taken, [Interval shooting complete] is displayed, and the camera returns to normal standby mode.

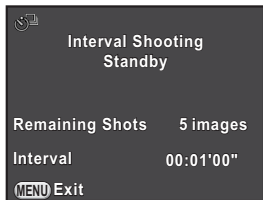



- Refer to "Interval Movie" (p.119) for information on how to perform Interval Shooting in  mode.
- If the mode dial or the main switch is turned while shooting, the pictures that have been already taken are saved and Interval Shooting is ended.
- (Single Frame Shooting) is used regardless of the current drive mode setting.
- Although each shot taken is displayed on the monitor with Instant Review, they cannot be magnified, deleted, or saved in RAW format.
- The monitor turns off during the intervals between shots.
- If the Auto Power Off function turns the camera off before starting Interval Shooting, the camera automatically turns on again when the shooting time approaches.



When using Interval Shooting, use the AC Adapter kit K-AC1202 (optional) or install a fully charged battery. If the battery is not sufficiently charged, it may become depleted during Interval Shooting, and cause recording to stop.

Multi-exposure

You can create a picture by taking multiple exposures and merging them into a single image.



- Multi-exposure is not available in the following situations.
 - when (Night Scene HDR) of SCN mode, HDR mode, or mode is set
 - when Exposure Bracketing, Interval Shooting, Distortion Correction, Lat-Chromatic-Ab Adj, Digital Filter or HDR Capture is set

- 1** Select [Multi-exposure] in the [Rec. Mode 2] menu, and press the four-way controller (▶).

The [Multi-exposure] screen appears.

- 2** Use the four-way controller (▲▼) to select [Number of Shots], and press the four-way controller (▶).

- 3** Use the four-way controller (▲▼) to select the number of shots, and press the OK button.

Select from 2 to 9 shots.

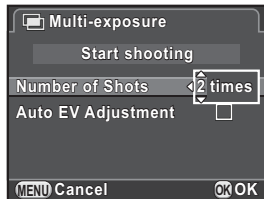

- 4** Use the four-way controller (▲▼) to select [Auto EV Adjustment], and use the four-way controller (◀▶) to select (On) or (Off).

When set to , the exposure is adjusted according to the number of shots.

- 5** Use the four-way controller (▲▼) to select [Start shooting], and press the OK button.

The camera is ready to take a series of pictures.

6 Take the picture.

The composite picture is displayed in Instant Review each time the shutter release button is pressed. Press the **UP** /  button during Instant Review to discard pictures taken up to that point and take pictures again from the first frame.

To cancel shooting, press the **MENU** button.

The picture is saved when the set number of shots are taken, and then the screen in Step 3 appears again.

This camera enables you to record movies with the following format.

- Sound Stereo
- File format MPEG-4 AVC/H.264 (File extension: .MOV)

Changing the Settings for Movie Recording

Settings for recording movies can be changed using the [Movie] menu or the control panel.

Below, how to change the settings from the [Movie 1] menu is explained as an example.

1 Set the mode dial to , and press the MENU button.

The [Movie 1] menu appears.

Press the four-way controller () once if you pressed the **MENU** button in any other capture mode.

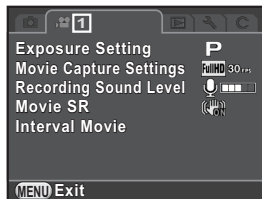

2 Use the four-way controller () to select [Exposure Setting], and press the four-way controller ().

3 Use the four-way controller () to select **P**, **Av**, or **M**, and press the **OK** button.

P	Sets the exposure automatically. Allows you to adjust the EV compensation value. (default setting)
Av	Allows you to set the aperture and EV compensation values.
M	Allows you to set the shutter speed, aperture value, and sensitivity.

4 Use the four-way controller () to select [Movie Capture Settings], and press the four-way controller ().

The [Movie Capture Settings] screen appears.

5 Select [Recorded Pixels].

Recorded Pixels	Display Resolution	Aspect Ratio	Frame Rate (fps)
FullHD (default setting)	1920×1080	16:9	30/25/24
HD	1280×720	16:9	60/50/30/25/24
VGA	640×480	4:3	30/25/24

When the setting is changed, the amount of recordable time for that setting appears at the top right of the screen.

6 Select [Framerate].

The frame rates that can be selected vary depending on the recorded pixels.

7 Set [Quality Level] to [★★★], [★★], or [★].

8 Press the MENU button.

The [Movie 1] menu appears.

9 Use the four-way controller (▲▼) to select [Recording Sound Level], and press the four-way controller (▶).

The [Recording Sound Level] screen appears.

10 Use the four-way controller (▲▼) to select [Internal Microphone] or [External Microphone], and use the four-way controller (◀▶) to select the recording sound level.

The sound level for recording can be set in the range from 0 to 5 for [Internal Microphone] and from 0 to 10 for [External Microphone]. Sound is not recorded when (0) is selected.

11 Use the four-way controller (▲▼) to select [Movie SR], and press the four-way controller (▶).

12 Use the four-way controller (▲▼) to select or , and press the OK button.

On	Uses Shake Reduction. (default setting)
Off	Does not use Shake Reduction.

13 Press the MENU button.

The camera is ready to record a movie.



The settings described in this section can also be set through the control panel.

Connecting a Microphone

You can connect a commercially available stereo microphone to the microphone input terminal. Using an external microphone may reduce noise, such as camera operation sounds, that is recorded.



The following specifications are recommended for external microphones.

- Plug: Stereo mini-plug (Ø3.5mm)
- Type: Stereo electret condenser
- Power supply: Plug-in-power system (operating voltage of 2.0V or less)
- Impedance: 2.2kΩ

1 Turn the camera off.

2 Open the cover of the microphone input terminal and connect the microphone plug to the microphone input terminal.

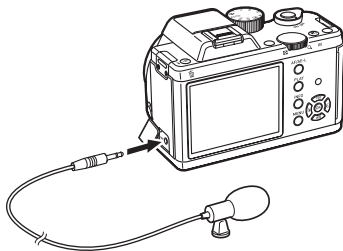

3 Turn the camera on.





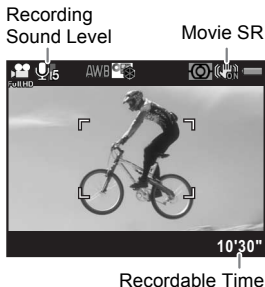

Note that if the external microphone is disconnected during recording, the movie recording will be terminated.

Recording Movies

- 1 **Set the mode dial to .**
The movie recording screen appears.
- 2 **View the subject on the monitor.**
Change the exposure setting as necessary.



Available operations





E-dial	(Exposure Setting Av) Adjusts the aperture value. (Exposure Setting M) Adjusts the shutter speed.
 / Av button → E-dial	(Exposure Setting P/Av) Adjusts the EV compensation value. (Exposure Setting M) Adjusts the aperture value.
Four-way controller ()	(Exposure Setting M) Adjusts the sensitivity setting.
 (G/R) button	Calls the function set in [Button Customization] of the [ Rec. Mode 3] menu (p.147). Resets the exposure setting when [Green Button] is assigned to the  (G/R) button.

- 3 **Press the shutter release button halfway.**
The autofocus system operates.
When the focus mode is set to **MF**, turn the focusing ring until the subject is clearly visible on the focusing screen.
- 4 **Press the shutter release button fully.**
Movie recording starts.
A red  displayed at the top right of the screen blinks during movie recording.
- 5 **Press the shutter release button again.**
Movie recording stops.

Caution

- When [Recording Sound Level] is set to a value other than 0 (0), the camera operation sounds are also recorded. When recording a movie, mount the camera onto a tripod or use an external microphone, and do not operate the camera while recording.
- The flash is not available.
- When recording a movie using an image processing function such as Digital Filter, some frames may be omitted from the recorded movie.
- If the internal temperature of the camera becomes high during movie recording, the recording may be terminated to protect the camera circuitry.

memo

- When recording a movie, regardless of the focus mode setting, recording starts when the shutter release button is pressed fully even if the subject is not in focus.
- You can record a movie continuously up to 4 GB or 25 minutes. When the SD Memory Card is full, recording stops and the movie is saved.
- The screen display in  mode is set according to the [Live View] setting made in the [Rec. Mode 3] menu. (p.190)
- You can set the **AF/AE-L** button operation in  mode. Refer to “Setting the **AF/AE-L** Button Operation” (p.152) for details.
- If you intend to record movies continuously for a long period, use of the AC Adapter kit K-AC1202 (optional) is recommended. (p.42)
- You can also use an optional remote control unit to record a movie. (p.104) Press the four-way controller () in  mode to display the screen for setting whether to use the remote control instead of the normal Drive Mode setting screen.

Recording Movies Using the **Ⓜ** Button

If you use the **Ⓜ** (R) button, you can start recording a movie immediately, regardless of the mode dial setting.



- [Exposure Setting] is fixed to **P**.
- HDR Capture and Digital Filter are not available during movie recording.
- In standby mode during Interval Shooting or Multi-exposure, movies cannot be recorded.

1 Assign [Movie Recording] to the **Ⓜ** (R) button.

Refer to “Setting the **Ⓜ** Button Operation” (p.147) for details. The default setting is [Movie Recording].

2 View the subject on the monitor.

3 Press the shutter release button halfway.

The autofocus system operates.

4 Press the **Ⓜ** (R) button.

Movie recording starts.

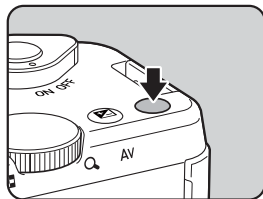

5 Press the **Ⓜ** (R) button again.

Movie recording stops.

Interval Movie

Takes still pictures at a set interval from a set time and records them as a single movie file (Motion JPEG, file extension: .AVI).

The following items can be set.

Interval	Set the shooting interval to 1 sec., 5 sec., 10 sec., 30 sec., 1 min., 5 min., 10 min., 30 min., or 1 hour.
Recording Time	Set the time at which to start and stop recording from 4 seconds to 99 hours. The time that can be set varies depending on the [Interval] setting.
Start Interval	Select whether to take the first picture now or at a set time. Selecting [Now] starts recording immediately. When [Set Time] is selected, set [Start Time].
Start Time	Set the time at which to start shooting.



This mode is available only when the mode dial is set to .

1 Select [Interval Movie] in the [ Movie 1] menu, and press the four-way controller (▶).

The [Interval Movie] screen appears.

2 Use the four-way controller (▲▼) to select [Interval], and press the four-way controller (▶).

3 Use the four-way controller (▲▼) to select the shooting interval, and press the OK button.

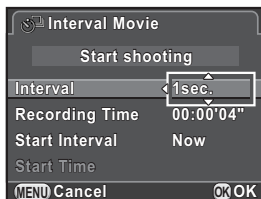

4 Use the four-way controller (▲▼) to select [Recording Time], and press the four-way controller (▶).

-
- 5** Use the four-way controller (◀▶) to select hours, minutes, or seconds, and use the four-way controller (▲▼) to set the time.
Press the **OK** button to complete the setting.
-
- 6** Use the four-way controller (▲▼) to select [Start Interval], and press the four-way controller (▶).
-
- 7** Use the four-way controller (▲▼) to select [Now] or [Set Time], and press the **OK** button.
If you selected [Now], proceed to Step 10.
-
- 8** Use the four-way controller (▲▼) to select [Start Time], and press the four-way controller (▶).
-
- 9** Use the four-way controller (◀▶) to select hours or minutes, and use the four-way controller (▲▼) to set the time.
Press the **OK** button to complete the setting.
-
- 10** Use the four-way controller (▲▼) to select [Start shooting], and press the **OK** button.
After the message [Press the shutter release button to start interval shooting] appears, the monitor turns off.
-
- 11** Press the shutter release button halfway.
The autofocus system operates.
-
- 12** Press the shutter release button fully.
When [Start Interval] is set to [Now], a picture is taken immediately, Instant Review is displayed, and then the monitor display turns off. After the shooting ends, [Interval shooting complete] is displayed, and then the camera turns off.



When recording with Interval Movie, use the AC Adapter kit K-AC1202 (optional) or install a fully charged battery. If the battery is not sufficiently charged, it may become depleted during recording and cause recording of the movie to stop.

Playing Back Movies

Recorded movies can be played back in playback mode in the same manner as saved still pictures.

1 In the single image display of playback mode, use the four-way controller (◀▶) to select a movie to play back.

The first frame of the movie is displayed on the monitor.

2 Press the four-way controller (▲).

Movie playback starts.



Available operations

Four-way controller (▲)	Pauses/resumes playback.
Four-way controller (▶)	Forwards a frame (when paused).
Press and hold four-way controller (▶)	Fast-forwards playback.
Four-way controller (◀)	Reverses a frame (when paused).
Press and hold four-way controller (◀)	Fast-reverses playback.
Four-way controller (▼)	Stops playback. Displays the playback mode palette (when stopped). (p.154)
E-dial	Adjusts the volume (6 levels).
INFO button	Switches between [Standard Information Display] and [No Information Display].
 /Av button	Saves the displayed image as a JPEG file (when paused) (p.122).

When the movie ends, playback stops and the first frame is displayed again.



- You can use the optional Video Cable I-VC28, AV Cable I-AVC7, or a commercially available HDMI cable to play back recorded movies on a TV screen or other AV devices. (p.178) The sound when playing back movies is monaural with video output and stereo with HDMI output.
- QuickTime is required to play back movies transferred to a computer. (p.208)

Capturing a Still Picture from a Movie

You can capture a single frame from a movie and save it as a JPEG still picture.

1 Press the four-way controller (▲) in Step 2 on p.121 to pause the movie.

2 Use the four-way controller (◀▶) to display the frame to save as a still picture.

Frame number/
Total number of frames



3 Press the /Av button.

The save confirmation screen appears.

4 Use the four-way controller (▲▼) to select [Save as], and press the OK button.

The captured image is saved in JPEG format.

Editing Movies

Movies can be divided and unwanted segments can be deleted.

- 1 **In the single image display, use the four-way controller (◀▶) to select a movie to edit.**
The first frame of the movie is displayed on the monitor.
- 2 **Press the four-way controller (▼).**
The playback mode palette appears.
- 3 **Use the four-way controller (▲▼◀▶) to select $\frac{S}{B}$ (Movie Editing), and press the OK button.**
The movie editing screen appears.
- 4 **Select a point where you want to divide the movie.**

The first frame at the dividing point is displayed at the top of the screen.

Up to four points can be selected (divided into five segments).

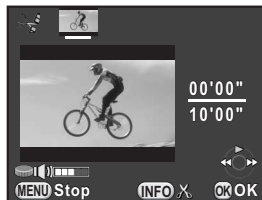

Available operations

Four-way controller (▲)	Plays back/pauses a movie.
Four-way controller (▶)	Forwards a frame (when paused).
Press and hold four-way controller (▶)	Fast-forwards playback.
Four-way controller (◀)	Reverses a frame (when paused).
Press and hold four-way controller (◀)	Fast-reverses playback.
E-dial	Adjusts the volume (6 levels).
INFO button	Confirms/cancels a dividing point.

Proceed to Step 8 if you do not want to delete any segment.

- 5 **Press the $\frac{4}{UP}$ /🗑️ button.**

The screen to select the segment(s) to delete is displayed.

Download from [Www.Somanuals.com](http://www.Somanuals.com). All Manuals Search And Download.

6 Use the four-way controller (◀▶) to move the selection frame, and press the OK button.

The segment(s) to delete are specified. Multiple segments can be specified.

Press the **OK** button again to cancel the selection.



7 Press the MENU button.

The screen that was displayed in Step 4 appears again.

8 Press the OK button.

The save confirmation screen appears.

9 Use the four-way controller (▲▼) to select [Save as], and press the OK button.

The movie is divided at the specified points and the unwanted segments are deleted from it. The divided movie is then saved as separate files and the single image display reappears.



- Select dividing points in chronological order from the beginning of the movie. When canceling the selected dividing points, cancel each of them in reverse order (from the end of the movie to the beginning). In an order other than specified, you can neither select frames as a dividing point nor cancel the selections of the dividing points. You cannot, for example, select the frames prior to the last selected frame as a dividing point while selecting a dividing point.
- Movies with a short recording time cannot be divided.

5 Shooting Settings

This chapter describes image file formats and camera operating settings in capture mode.

Setting a File Format	126
Setting the White Balance	130
Correcting Images	133
Setting the Image Finishing Tone	140
Customizing the Button Functions	147

Setting a File Format

Set the aspect ratio, file format, number of recorded pixels, quality level, and color space of still pictures.

- 1 **Select [Image Capture Settings] in the [Rec. Mode 1] menu, and press the four-way controller (▶).**

The [Image Capture Settings] screen appears.

- 2 **Use the four-way controller (▲▼) to select [Aspect Ratio], [File Format], [JPEG Recorded Pixels], [JPEG Quality] or [Color Space], and press the four-way controller (▶).**

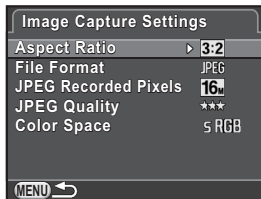

Refer to p.127 to p.129 for details about each of these settings.

- 3 **Use the four-way controller (▲▼) to change the settings, and press the OK button.**

- 4 **Press the MENU button twice.**

The screen that was displayed before selecting the menu item appears again.





- Aspect Ratio, File Format, JPEG Recorded Pixels, and JPEG Quality can also be set through the control panel.
- When File Format, JPEG Recorded Pixels, or JPEG Quality is changed, the number of images that can be recorded for that setting appears on the monitor.

Aspect Ratio

Select the horizontal and vertical ratio of images from 16:9, 3:2 (default setting), 4:3 or 1:1.

File Format

You can set the format of image files.

JPEG	Captures images in JPEG format. (default setting) You can change the number of recorded pixels in [JPEG Recorded Pixels], and the image quality level in [JPEG Quality].
RAW	The RAW format is a CMOS sensor output format saved without processing. RAW files are recorded with the general-purpose DNG (Digital Negative) format designed by Adobe Systems. Effects of White Balance, Custom Image and Color Space are not applied to the captured images, but they are saved as actual original information. When you perform the development process by using the [RAW Development] function (p.174), or using the provided software (p.211), you can create JPEG images with these effects.
RAW+	Captures images in both JPEG and RAW formats. When [One Push File Format] is assigned to the  (G/R) button, you can press the  (G/R) button to temporarily change the file format and save an image in both file formats. (p.149)



- When Digital Filter or HDR Capture is set, the file format is fixed to [JPEG] and cannot be changed. To change the file format, deactivate these functions.
- In  (Night Scene HDR) of **SCN** mode, or **HDR** mode, the image is saved in JPEG format, regardless of the [File Format] setting.

JPEG Recorded Pixels

Sets the recording size of images when the file format is set to [JPEG]. The selectable sizes vary according to the [Aspect Ratio] setting.

Aspect Ratio	Recorded Pixels	Pixels
16:9	13M	4928×2776
	10M	4224×2376
	6M	3456×1944
	4M	2688×1512
3:2	16M	4928×3264 (default setting)
	12M	4224×2816
	8M	3456×2304
	5M	2688×1792
4:3	14M	4352×3264
	11M	3840×2880
	7M	3072×2304
	4M	2304×1728
1:1	10M	3264×3264
	8M	2880×2880
	5M	2304×2304
	3M	1728×1728



- The more pixels there are, the bigger the file size. The file size will also vary according to the [JPEG Quality] setting.
- The quality of a captured image depends on the exposure control, resolution of the printer and a variety of other factors.

JPEG Quality

You can set the image quality level (compression ratio). The default setting is ★★★ (Best).

★★★ Best	↑	Quality: clearer File size: larger
★★ Better		
★ Good		

Color Space

You can select a color space to use.

sRGB	Mainly used for devices such as a computer. (default setting)
AdobeRGB	Covers a wider range of color than sRGB and is used for commercial uses such as industrial printing.









The file naming system changes depending on the color space setting as shown below. ("xxxx" is a four-digit sequential number.)

For sRGB: IMGpxxxx.JPG

For AdobeRGB: _IGPxxxx.JPG

Setting the White Balance

White Balance is a function for adjusting the color of an image so that white objects appear white. Set the white balance if you are not satisfied with the color balance of pictures taken with white balance set to **AWB** (Auto), or to intentionally apply a creative effect to your images.

Item	Setting	Color Temperature *1
AWB Auto	Automatically adjusts the white balance. (default setting)	Approx. 4,000 to 8,000K
 Daylight	For use when taking pictures in sunlight.	Approx. 5,200K
 Shade	For use when taking pictures in the shade. It reduces the bluish color tones in a picture.	Approx. 8,000K
 Cloudy	For use when taking pictures on cloudy days.	Approx. 6,000K
 Fluorescent Light	For use when taking pictures under fluorescent lighting. Select the type of fluorescent light. D Fluorescent - Daylight Color N Fluorescent - Daylight White W Fluorescent - Cool White L Fluorescent - Warm White	Approx. 6,500K Approx. 5,000K Approx. 4,200K Approx. 3,000K
 Tungsten	For use when taking pictures under light bulbs or other tungsten light. It reduces the reddish color tones in a picture.	Approx. 2,850K
 Flash	For use when taking pictures using the built-in flash.	Approx. 5,400K
CTE *2	Use this to keep and strengthen the color tone of the light source in the image.	—
 Manual	Use this to manually adjust the white balance according to the lighting when taking pictures.	—

*1 The color temperatures (K) shown above are all estimates. These do not indicate precise colors.

*2 CTE = Color Temperature Enhancement



The white balance is fixed to **AWB** in **AUTO** or **SCN** mode.

1 Press the four-way controller (▼) in standby mode.

The White Balance setting screen appears.

2 Use the four-way controller (◀▶) to select the white balance.

When  is selected, press the four-way controller (▼) and use the four-way controller (◀▶) to select **D**, **N**, **W**, or **L**. The background image changes according to the settings.

Proceed to Step 6 if you do not need to change the parameters.



3 Press the INFO button.

The fine-tuning screen appears.

4 Fine-tune the white balance.

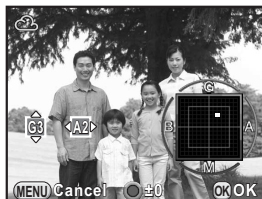

Available operations

Four-way controller (▲▼)	Adjusts the tone of the colors between green (G) and magenta (M).
Four-way controller (◀▶)	Adjusts the tone of the colors between blue (B) and amber (A).
⊙ (G) button	Resets the adjustment value.

5 Press the OK button.

The screen that was displayed in Step 2 appears again.

6 Press the OK button.

The camera is ready to take a picture.



Because the light source changes when a flash discharges, you can set the white balance for when the flash discharges. Select [Auto White Balance], [Unchanged] or [Flash] in [8. WB When Using Flash] (p.72) of the [C Custom Setting 1] menu.

Adjusting the White Balance Manually

You can adjust the white balance depending on the light source when taking pictures. The camera can store delicate shades that cannot be precisely adjusted with the white balance preset values provided in the camera. This provides the optimum white balance for your surroundings.

- 1** Select  in Step 2 on p.131.

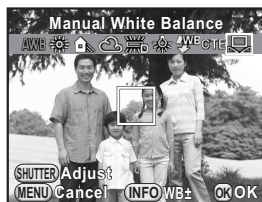

- 2** Under the light you wish to measure the white balance of, select a white area as the subject.

Or, fully display a white sheet of paper in the center of the monitor.

- 3** Press the **AF/AE-L** button.

The autofocus system operates.

- 4** Press the shutter release button fully.

The screen that was displayed in Step 1 appears again.

Adjust the white balance as necessary.

The message [The operation could not be completed correctly] appears when measuring is unsuccessful. Press the **OK** button to remeasure the white balance.

- 5** Press the **OK** button.

The camera is ready to take a picture.



If a picture is extremely overexposed or underexposed, the white balance may not be adjusted. In this case, adjust exposure to the correct exposure before adjusting the white balance.

The camera and lens properties can be automatically adjusted for when taking pictures.

Brightness Adjustment

Adjusts the brightness and reduces the occurrence of overexposed and underexposed areas.

Highlight Correction

Expands the dynamic range and enables a wider range of tones expressed by the CMOS sensor and reduces the occurrence of overexposed areas.

1 Press the INFO button in standby mode.

The control panel appears.

2 Use the four-way controller (▲▼◀▶) to select [Highlight Correction], and press the OK button.

The [Highlight Correction] screen appears.

3 Use the four-way controller (◀▶) to select [Auto], [On] or [Off], and press the OK button.

The camera returns to the control panel.

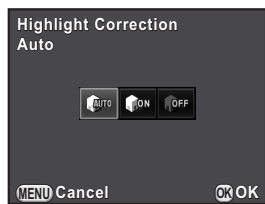

When [Highlight Correction] is set to [On], the minimum sensitivity is set to ISO 200.

Shadow Correction

Expands the dynamic range and enables a wider range of tones expressed by the CMOS sensor and reduces the occurrence of underexposed areas.

1 Press the INFO button in standby mode.

The control panel appears.

2 Use the four-way controller (▲▼◀▶) to select [Shadow Correction], and press the OK button.

The [Shadow Correction] screen appears.

3 Use the four-way controller (◀▶) to select [Auto], [Low], [Medium], [High] or [Off], and press the OK button.

The camera returns to the control panel.

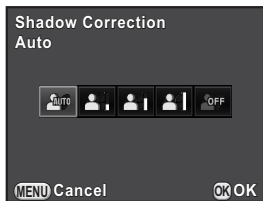

You can also set [Highlight Correction] and [Shadow Correction] in [D-Range Setting] (p.70) of the [Rec. Mode 2] menu.

High Dynamic Range Image Capture

High dynamic range photography is a way of expressing the entire range from dark to bright areas by capturing multiple images with different exposures (underexposed, properly exposed (standard), and overexposed), and combining them into a single image.

HDR Capture	Available by setting through the control panel or in the [📷 Rec. Mode 1] menu.
 (Night Scene HDR)	Available by selecting from SCN mode. (p.76)
HDR mode	Available by simply setting the mode dial to HDR . (p.137)

This section explains how to set HDR Capture and **HDR** mode.



- During HDR Capture or in **HDR** mode, the following functions are not available.
 - Continuous Shooting
 - Exposure Bracketing
 - Flash mode
 - Multi-exposure
 - Digital Filter
- During high dynamic range image capture, multiple images are combined together to create a single image, so it will take more time to save an image.

HDR Capture

HDR Capture is available regardless of the mode dial setting (except in some capture modes). It creates a single composite image from three different exposures (-3 EV, standard exposure, and +3 EV).



- HDR Capture is not available in the following situations.
 - when the file format is set to [RAW] or [RAW+]
 - when **B** mode is set
- If **HDR** mode or  (Night Scene HDR) of **SCN** mode is selected, settings for these modes override the settings for HDR Capture.

1 Press the **INFO** button in standby mode.

The control panel appears.

2 Use the four-way controller (▲▼◀▶) to select [HDR Capture], and press the **OK** button.

The [HDR Capture] screen appears.

3 Use the four-way controller (◀▶) to select [Auto], [HDR 1], [HDR 2], [HDR 3] or [Off], and press the OK button.

The camera returns to the control panel.

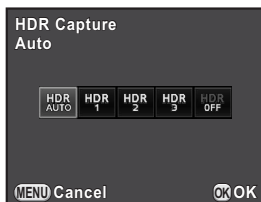

- You can also set the [Auto Align] setting from [HDR Capture] in the [Rec. Mode 1] menu.

<input type="checkbox"/>	Does not use Auto Align. Deactivates Shake Reduction. (default setting)
<input checked="" type="checkbox"/>	Uses Auto Align. Activates Shake Reduction according to the [Shake Reduction] setting.



- When both [Shake Reduction] and [Auto Align] are activated, take note of the following points.
 - Make sure to hold the camera firmly so that the composition of the picture does not change while the three images are captured. If there is a great difference of the composition between three images, Auto Align may not be possible.
 - Images captured with HDR Capture are susceptible to camera shake and blur. Be sure to set a higher shutter speed and a higher ISO sensitivity.
 - When the sensitivity is set to [ISO AUTO], the sensitivity can be raised more easily than normal.
 - Auto Align may not be possible when the lenses that have a focal length exceeding 100 mm is used, or when the entire subject is checkered or has a uniform surface.
- In (Night Scene HDR) of SCN mode, [HDR Capture] is fixed to [Auto] and [Auto Align] is fixed to (On).
- If [One Push File Format] is assigned to the (G/R) button, pressing the (G/R) button temporarily deactivates HDR Capture and saves captured images in RAW+.

HDR Mode

Enables capturing images with high dynamic range by simply turning the mode dial. You can specify the range in which the exposure is changed.



The file format is fixed to [JPEG]. One Push File Format is not available with the \odot (G/R) button.

1 Set the mode dial to HDR.

The camera switches to **HDR** mode and is ready to use high dynamic range image capture.

Proceed to Step 6 if you do not need to change the HDR type.

2 Select [HDR Capture] in the [📷 Rec. Mode 1] menu, and press the four-way controller (▶).

The [HDR Capture] screen for **HDR** mode appears.

3 Press the four-way controller (▶), use the four-way controller (▲▼) to select [Auto], [HDR 1], [HDR 2] or [HDR 3], and press the OK button.

4 Use the four-way controller (▲▼) to select [Auto Align], and use the four-way controller (◀▶) to select or .

Refer to p.136 for details on the setting.

5 Press the MENU button twice.

The camera is ready to take a series of pictures.

6 Use the e-dial to set the range in which to change the exposure.

Select from ± 1 , ± 2 (default setting) or ± 3 .



7 Take a picture.



Step 3 can also be performed through the control panel.

Lens Correction

Reduces distortions and lateral chromatic aberrations occurring due to lens properties.

● Distortion

Distortion is a phenomenon in which the center of the image appears inflated (barrel distortion) or the center of the image appears pinched (pincushion distortion). Distortion occurs more easily when using a zoom lens or a small diameter lens, and straight walls or the horizon in an image appear curved.

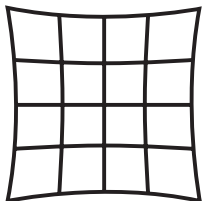

Pincushion distortion

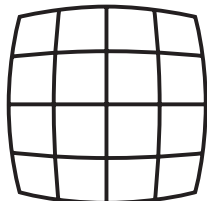

Barrel distortion

● Lateral chromatic aberration

Lateral chromatic aberration is a phenomenon in which the magnification of an image varies according to the colors (wavelengths of light) when a picture was taken, and may cause a blurred image. Chromatic aberration occurs more easily at shorter focal lengths.

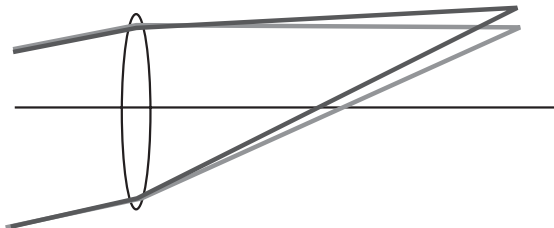



- Corrections can only be made when using DA, DA L, D FA or some FA lenses. [Distortion Correction] and [Lat-Chromatic-Ab Adj] cannot be selected when an incompatible lens is attached. (p.232)
- The Distortion Correction function is disabled when a DA FISH-EYE 10-17mm is used.
- The Lens Correction function is disabled when using an accessory such as a close-up ring or rear converter that is attached between the camera and the lens.
- The shooting speed for Continuous Shooting may be slower when using the Distortion Correction function.
- The effects of the Lens Correction function may be barely noticeable in some cases due to the shooting conditions or other factors.

1 Press the INFO button in standby mode.

The control panel appears.

2 Use the four-way controller (▲▼◀▶) to select [Distortion Correction] or [Lat-Chromatic-Ab Adj], and press the OK button.

The [Distortion Correction] or [Lat-Chromatic-Ab Adj] screen appears.

3 Use the four-way controller (◀▶) to select [Off] or [On].

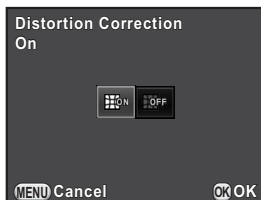

4 Press the OK button.

The camera returns to the control panel.



- When a compatible lens is attached and the file format is set to [RAW] or [RAW+], the correction information is saved as a RAW file parameter and you can select [On] or [Off] when developing the RAW images. (p.175)
- You can also set [Distortion Correction] and [Lat-Chromatic-Ab Adj] in [Lens Correction] (p.69) of the [Rec. Mode 1] menu.

Take pictures with settings to suit for your creative photographic vision.

Custom Image

Select the desired picture style from the following modes and enjoy taking pictures with a creative finishing tone.

Image Tone	Image
Bright	Saturation, hue and contrast are set relatively high to create a bright sharp image. (default setting)
Natural	Creates a natural look that is close to the actual color.
Portrait	Reproduces a healthy and bright skin tone.
Landscape	Increases color saturation, highlights shapes, and produces a vivid color image.
Vibrant	Changes the color slightly to create an antique look.
Radiant	Emphasizes glossiness to produce a spectacular finish.
Muted	Reduces the saturation to create a soft look.
Bleach Bypass	Reduces the saturation and increases the contrast to create the look of an old picture.
Reversal Film	Creates a picture with strong image contrast as if taken with reversal film.
Monochrome	Takes pictures using a monochrome color filter.
Cross Processing	Intentionally changes the hue and contrast. The outcome varies each time a picture is taken.



The image tone is automatically set according to the capture mode and the setting cannot be changed in **AUTO** or **SCN** mode.

1

Press the **INFO** button in standby mode.

The control panel appears.

- 2 Use the four-way controller (▲▼◀▶) to select [Custom Image], and press the OK button.**

The Custom Image setting screen appears.

- 3 Use the four-way controller (▲▼◀▶) to select an image finishing tone.**

The background image changes according to the selected image tone.

Proceed to Step 8 if you do not need to change the parameters.

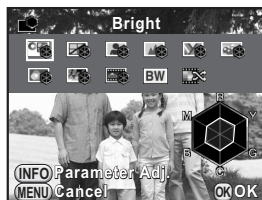

- 4 Press the INFO button.**

The screen to adjust the parameters appears.

- 5 Use the four-way controller (▲▼) to choose a parameter you want to change.**

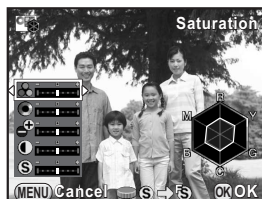

The following parameters can be changed according to the selected image finishing tone.

Image Tone	Parameter
Bright/Natural/Portrait/ Landscape/Vibrant/ Radiant	Saturation: -4 to +4
	Hue: -4 to +4
	High/Low Key Adj: -4 to +4
	Contrast: -4 to +4
	Sharpness: -4 to +4
Muted/Bleach Bypass	Saturation: -4 to +4
	Toning: Off/Green/Yellow/Orange/Red/Magenta/ Purple/Blue/Cyan
	High/Low Key Adj: -4 to +4
	Contrast: -4 to +4
	Sharpness: -4 to 4

Image Tone	Parameter
Reversal Film	Sharpness: -4 to +4
Monochrome	Filter Effect: None/Green/Yellow/Orange/Red/Magenta/Blue/Cyan/Infrared Filter
	Toning: Off/Green/Yellow/Orange/Red/Magenta/Purple/Blue/Cyan
	High/Low Key Adj: -4 to +4
	Contrast: -4 to +4
	Sharpness: -4 to +4
Cross Processing	Random/Preset 1-3/Favorite 1-3 ^{*1}

*1 For [Favorite 1-3], you can save the settings of a cross processed image as a favorite in advance through the playback mode palette. (p.143)

6 Use the four-way controller (◀▶) to adjust the parameter's value.

You can check the saturation and hue with the radar chart.

Available operations

E-dial	Switches between [Sharpness] and [Fine Sharpness].
⊙ (G) button	Resets the set value.

7 Press the OK button.

The screen that was displayed in Step 3 appears again.

8 Press the OK button.

The camera returns to the control panel.



You can also change the setting from the [📷 Rec. Mode 1] menu (p.69).

Saving the Cross Processing Settings of a Captured Image

The outcome of cross processing varies each time a picture is taken. If you take a cross processed image that you like, you can save the Cross Processing settings used in that image. A total of three Cross Processing settings can be saved.

- 1 Press the four-way controller (▼) in the single image display of playback mode.**

The playback mode palette appears.

- 2 Use the four-way controller (▲▼◀▶) to select  (Save Cross Processing), and press the OK button.**

The camera will search for cross processed images starting from the most recent image taken. (An hourglass icon is displayed while searching.) When a cross processed image is found, the screen to save the settings appears. If there are no cross processed images, the message [No cross processed image] appears.

- 3 Use the e-dial to select a cross processed image.**

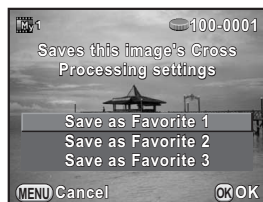



- 4 Use the four-way controller (▲▼) to select [Save as Favorite 1], [Save as Favorite 2] or [Save as Favorite 3], and press the OK button.**

The settings of the selected image are saved to [Favorite 1 - 3] and the last displayed image is displayed again.

Digital Filter

You can apply a filter effect when taking pictures.
The following filters can be selected.

Filter Name	Effect	Parameter
Extract Color	For extracting one or two specific colors and making the rest of the image black and white.	Extracted Color 1: Red/Magenta/Blue/Cyan/Green/Yellow
		Extractable Range of Color 1: 1 to 5
		Extracted Color 2: OFF/Red/Magenta/Blue/Cyan/Green/Yellow
		Extractable Range of Color 2: 1 to 5
Toy Camera	For taking pictures that look as if taken with a toy camera.	Shading Level: OFF/Low/Medium/High (Not available in  mode.)
		Blur: Low/Medium/High
		Tone Break: Red/Green/Blue/Yellow
Retro	For taking pictures with the look of old photos.	Toning (B-A): 7 levels
		Frame Composite: None/Thin/Medium/Thick (Not available in  mode.)
High Contrast	For taking pictures with high contrasts.	Intensity: 1 to 5
Shading *1	For taking pictures with the edge areas darkened.	Shading Type: 4 types
		Shading Level: -3 to +3
Invert Color	Inverts the colors in the image.	OFF/ON
Color	For taking pictures with the selected color filter.	Color: Red/Magenta/Blue/Cyan/Green/Yellow
		Color Density: Light/Medium/Dark

*1 Cannot be selected in  mode.



- Digital Filter is not available in the following situations.
 - when  (Night Scene HDR) of **SCN** mode, or **HDR** mode is set
 - when the file format is set to [RAW] or [RAW+]
- When Digital Filter is set, the following functions are not available.
 - Continuous Shooting
 - Multi-exposure
 - HDR Capture
- Depending on the filter used, it may take longer to save images.

1 Press the INFO button in standby mode.

The control panel appears.

2 Use the four-way controller (▲▼◀▶) to select [Digital Filter], and press the OK button.

The Digital Filter setting screen appears.

3 Use the four-way controller (▲▼◀▶) to select a filter.

The background image changes according to the selected filter. Proceed to Step 7 if you do not need to change the parameters.



4 Press the INFO button.

The screen to adjust the parameters appears.

5 Use the four-way controller (▲▼) to select a parameter, and use the four-way controller (◀▶) to adjust the value.



6 Press the OK button.

The screen that was displayed in Step 3 appears again.

7 Press the OK button.

The camera returns to the control panel.



- You can also change the settings from the [📷 Rec. Mode 1] menu (p.69).
- Select [No Filter] in Step 3 to finish shooting with a digital filter.
- After shooting, you can also apply digital filter effects to JPEG/RAW images in playback mode. (p.167)
- [Shading Level] for the Toy Camera filter and the Shading filter cannot be checked with Live View.

Functions can be assigned to the **⊙** (G/R) button and **AF/AE-L** button.



The current functions assigned to the **⊙** (G/R) button and **AF/AE-L** button can be checked with guide display (p.75).



Setting the **⊙** Button Operation

You can assign one of the following functions to the **⊙** (G/R) button.

Green Button	Resets the values being adjusted. (default setting for Green button) Only available for the ⊙ (G) button.
Movie Recording	Starts and ends movie recording. (p.118) (default setting for Red button) Only available for the ⊙ (R) button.
One Push File Format	Temporarily changes the file format. Simultaneously saves an image in both JPEG and RAW formats, regardless of the [File Format] setting. You can set whether or not to apply the setting to only one image, and select the file format when the ⊙ button is pressed. (p.149)
Preview	While the ⊙ button is pressed, you can check the depth of field by stopping down the aperture to the set value. (p.99)
Focus Peaking	Emphasizes the outline of the subject in focus and makes it easier to check the focus. (p.98)
Custom Image	Sets the Custom Image settings. (p.140) Selects a SCN mode when the mode dial is set to SCN . (p.77)
Digital Filter	Selects a digital filter and adjusts its parameters. (p.144)

- 1 Select **[Button Customization]** in the **[Rec. Mode 3]** menu, and press the four-way controller (▶).

The [Button Customization] screen appears.

- 2 Use the four-way controller (▲▼) to select the **⊙ (G/R) button icon**, and press the four-way controller (▶).

The screen to select a function for the ⊙ button appears.

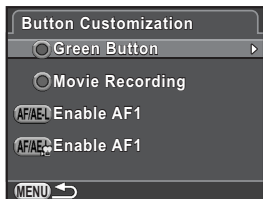

- 3 Press the four-way controller (▶), use the four-way controller (▲▼) to select a function, and press the OK button.

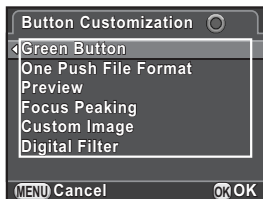

- 4 Press the **MENU** button three times.

The screen that was displayed before selecting the menu item appears again.

Setting the One Push File Format

When [One Push File Format] is assigned to the \odot (G/R) button, specify the function settings.

- 1 Select [One Push File Format] in Step 3 on p.148.
- 2 Use the four-way controller ($\blacktriangle \blacktriangledown$) to select [Cancel after 1 shot], and use the four-way controller ($\blacktriangleleft \blacktriangleright$) to select or .

<input checked="" type="checkbox"/>	The recording format returns to the original file format after a picture is taken. (default setting)
<input type="checkbox"/>	The setting is canceled when any of the following operations are performed. <ul style="list-style-type: none"> - the \odot (G/R) button is pressed again - the PLAY button or MENU button is pressed - the mode dial is turned

- 3 Use the four-way controller ($\blacktriangle \blacktriangledown$) to choose a file format.

The left side is the [File Format] (p.127) setting and the right side is the file format when the \odot (G/R) button is pressed.

- 4 Press the four-way controller (\blacktriangleright), use the four-way controller ($\blacktriangle \blacktriangledown$) to select a file format, and press the **OK** button.

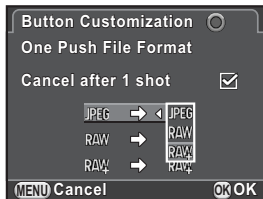

- 5 Press the **MENU** button three times.

The screen that was displayed before selecting the menu item appears again.

Setting the E-dial Operation in P Mode

Set the value to be changed with the e-dial in **P** mode.

- 1 Select [Green Button] in Step 3 on p.148 as the function to be assigned to the **⊙ (G)** button.
- 2 Use the four-way controller (**▲▼**) to select [E-dial in Program], and press the four-way controller (**▶**).
- 3 Use the four-way controller (**▲▼**) to select the e-dial operation, and press the **OK** button.

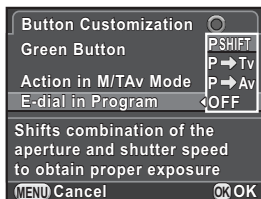

P SHIFT	Automatically adjusts the shutter speed and aperture value to obtain a proper exposure (Program shift). (default setting)
P → Tv	Switches to Shutter Priority Automatic Exposure mode. Turn the e-dial to adjust the shutter speed.
P → Av	Switches to Aperture Priority Automatic Exposure mode. Turn the e-dial to adjust the aperture value.
OFF	Disables the e-dial operation when turned in P mode.

- 4 Press the **MENU** button three times.

The screen that was displayed before selecting the menu item appears again.



If the **⊙ (G)** button is pressed after turning the e-dial in **P** mode, the setting returns to normal **P** mode.

Setting the Green Button Operation in M Mode

You can set the function of the \odot (G) button in **M** mode. The following settings are effective even in **TA_v** (Shutter & Aperture Priority Automatic Exposure) mode (when the sensitivity is set to [ISO AUTO] in **M** mode).

- 1 Select [Green Button] in Step 3 on p.148 as the function to be assigned to the \odot (G) button.
- 2 Use the four-way controller (\blacktriangle \blacktriangledown) to select [Action in M/TA_v Mode], and press the four-way controller (\blacktriangleright).
- 3 Use the four-way controller (\blacktriangle \blacktriangledown) to select a function to assign to the \odot (G) button, and press the OK button.

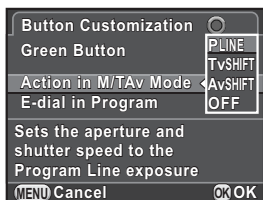

P LINE	Adjusts the aperture value and shutter speed to obtain a proper exposure according to the program line. (default setting)
Tv SHIFT	Adjusts the shutter speed while the aperture value remains fixed to obtain a proper exposure.
Av SHIFT	Adjusts the aperture value while the shutter speed remains fixed to obtain a proper exposure.
OFF	Disables the \odot (G) button operation when pressed in M or TA_v mode.

- 4 Press the **MENU** button three times.

The screen that was displayed before selecting the menu item appears again.

Setting the AF/AE-L Button Operation

You can assign one of the following functions to the **AF/AE-L** button. Separate settings can be made for still picture shooting and movie recording.

Enable AF1	Both the AF/AE-L button and shutter release button are available to perform autofocus. (p.96) (default setting)
Enable AF2	Autofocus is performed only when the AF/AE-L button is pressed and not when the shutter release button is pressed halfway.
Cancel AF	While the AF/AE-L button is pressed, autofocus is not performed even when the shutter release button is pressed. Take your finger off the AF/AE-L button to return to normal autofocus operation.
AE Lock	The exposure setting is locked when the AF/AE-L button is pressed. (p.87)

- 1** Select **[Button Customization]** in the **[Rec. Mode 3]** menu, and press the four-way controller (▶).

The [Button Customization] screen appears.

- 2** Use the four-way controller (▲▼) to select the **AF/AE-L** button icon, and press the four-way controller (▶).

The **AF/AE-L** button icon with  is the setting for movie recording. The screen to select a function for the **AF/AE-L** button appears.

- 3** Press the four-way controller (▶), use the four-way controller (▲▼) to select a function, and press the OK button.

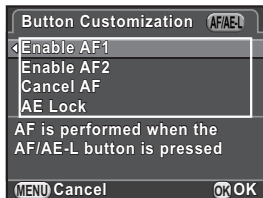

- 4** Press the **MENU** button three times.

The camera is ready to take a picture.

6 Playback Functions and Image Editing

This chapter describes how to use the various playback functions and how to edit the captured images.

How to Operate the Playback/Editing Functions	154
Setting the Playback Display Method	156
Magnifying Images	157
Selecting the Playback Functions	158
Deleting Multiple Images	163
Processing Images	165
Developing RAW Images	174
Connecting the Camera to an AV Device	178

How to Operate the Playback/Editing Functions

Make settings related to playing back and editing images in the playback mode palette or [▶ Playback] menu.



For details on how to use the menus, refer to "Using the Menus" (p.33).



Playback Mode Palette Items

Press the four-way controller (▼) in the single image display to call up the playback mode palette.

You can display the playback mode palette when a movie is paused.



Item	Function	Page
Image Rotation *1	Changes the rotation information of an image.	p.162
Digital Filter *1	Changes the color tone of images, adds softening and slimming effects.	p.167
Resize *1 *2	Changes the number of recorded pixels or size of the image, and saves the image as a new file.	p.165
Cropping *1	Crops out only the desired area of the picture and saves it as a new image.	p.166
Index *1	Joins a number of images together and creates a new image with them.	p.172
Protect	Protects images from being accidentally erased.	p.200
Slideshow	Plays back the images one after another.	p.161
Save Cross Processing	Saves the settings for an image captured in Cross Processing mode of Custom Image to Favorite.	p.143
RAW Development *1	Converts a RAW image to JPEG format and saves it as a new image.	p.174

Item	Function	Page
 Movie Editing *3	Divides a movie and deletes unwanted segments.	p.123
 DPOF *1 *2	Sets information such as the number of prints and the date to images saved on the SD Memory Card.	p.204

*1 This cannot be performed when a movie is displayed.

*2 This cannot be performed when a RAW image is displayed.

*3 This can be performed only when a movie is displayed.

Playback Menu Items

The following items are available in the [ Playback] menu.

Press the **MENU** button in playback mode to display the [ Playback 1] menu.

Menu	Item	Function	Page
 1	Slideshow	Plays back the images one after another. You can set how images will be displayed in the slideshow.	p.160
	Quick Zoom	Sets the initial magnification when magnifying images.	p.156
	Bright/Dark Area	Sets whether to display the Bright/Dark Area warning during playback.	
	Auto Image Rotation	Sets whether to rotate images when playing back images captured with the camera held vertically or images for which the rotation information was changed to the vertical position.	
	Delete All Images	Deletes all saved images at once.	p.164

Setting the Playback Display Method

You can set the initial magnification when magnifying images (p.157), whether to display the Bright/Dark Area warning, and whether to automatically rotate images that are captured with the camera held vertically in the single image display.

1 Select [Quick Zoom] in the [Playback 1] menu, and press the four-way controller (▶).

2 Use the four-way controller (▲▼) to select the magnification, and press the OK button.

Select from [×16], [×8], [×4], [×2] or [Off] (default setting).

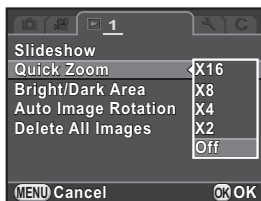

3 Use the four-way controller (▲▼) to select [Bright/Dark Area] or [Auto Image Rotation], and use the four-way controller (◀▶) to select (On) or (Off).

Bright/Dark Area	Bright (overexposed) portions blink red and dark (underexposed) portions blink yellow. (p.29)
Auto Image Rotation	During playback, the image is automatically rotated based on the rotation information when [13. Save Rotation Info] (p.72) in the [C Custom Setting 2] menu is set to [On].

4 Press the MENU button.

The screen that was displayed before selecting the menu item appears again.



The Bright/Dark Area warning is not displayed in Detailed Information Display and RGB Histogram Display. (p.25)

Images can be magnified up to 16 times in playback mode.



1 Use the four-way controller (◀▶) to select an image in the single image display.

2 Turn the e-dial to the right (toward ) .

The image is magnified with each click (1.2 to 16 times).



Available operations

E-dial to the right ()	Magnifies the image (up to 16 times).
E-dial to the left ()	Reduces the image (up to 1 times).
Four-way controller (▲▼◀▶)	Moves the magnified area.
 (G) button	Returns a position of the magnified display area to the center (when the magnified display area has been moved to the side).
INFO button	Switches between [Standard Information Display] and [No Information Display].
OK button	Returns to the single image display.



- You can magnify an image by following the same procedure during Instant Review (p.57).
- The default setting for the first click is 1.2 times. You can change this in [Quick Zoom] of the [ Playback 1] menu. (p.156)
- The initial full display of vertical images is displayed with a magnification of 0.75 times that of horizontal images, therefore, magnification at the first click starts at 0.75 times.

You can display images in a list or play back saved images successively.

Displaying Multiple Images





- 1 Turn the e-dial to the left (toward ) in the single image display.

The thumbnail display screen appears.

Proceed to Step 5 if you do not need to change the display style.

- 2 Press the INFO button.



The display style selection screen appears.

- 3 Use the four-way controller (   ) to select the display style.



4/9/16/36/81 Thumbnail Display

Images are displayed with the screen divided into multiple sections.

Icons such as  and  are displayed with images (except in 81 Thumbnail Display).



Folder Display

Images are grouped and displayed by folder in which they are saved.

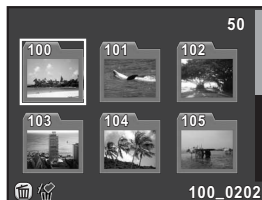

Calendar Filmstrip Display

Images are grouped and displayed by the shooting date.









4 Press the OK button.

The selected display style is confirmed.

The next time the e-dial is turned to the left (toward ) in the single image display, the screen selected in Step 3 will be displayed.

5 Select the image(s) to display.

Available operations

Four-way controller ()	Moves the selection frame.
Four-way controller ()	Selects a shooting date (in Calendar Filmstrip Display).
Four-way controller ()	Selects an image taken on the selected shooting date (in Calendar Filmstrip Display).
E-dial to the right ()	Displays the selected image in the single image display (in Calendar Filmstrip Display). Turn to the left () to return to the Calendar Filmstrip Display.
 UP/  button	Deletes the selected images.
OK button	Displays the selected image in the single image display. Displays the first image from the selected folder in the single image display (in Folder Display).

6 Turn the e-dial to the right (toward Q).

The camera returns to the single image display.

Playing Back Images Continuously

You can play back all images saved on your SD Memory Card successively in a slideshow.

Setting the Slideshow Display

Sets how images will be displayed during Slideshow.

1 Select [Slideshow] in the [▶ Playback 1] menu, and press the four-way controller (▶).

The Slideshow setting screen appears.

2 Use the four-way controller (▲▼) to select an item you want to change.

The following items can be changed.

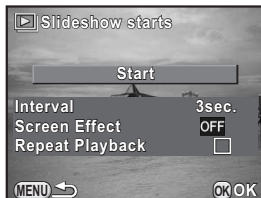

Item	Description	Setting
Interval	Select an image display interval.	3sec. (default setting)/ 5sec./10sec./30sec.
Screen Effect	Select a transition effect when the next image is displayed.	OFF (default setting)/ Fade/Wipe/Stripe
Repeat Playback	Set whether to start the slideshow again from the beginning after the last image is displayed.	<input type="checkbox"/> (default setting)/ <input checked="" type="checkbox"/>

3 Press the four-way controller (▶), use the four-way controller (▲▼) to change the setting, and press the OK button.

Starting the Slideshow

- 1 Select [Start] in Step 2 on p.160, and press the **OK** button. Or, select  (Slideshow) in the playback mode palette, and press the **OK** button.

The start screen is displayed and the slideshow starts.



Available operations

OK button	Pauses/resumes playback.
Four-way controller (◀)	Shows the previous image.
Four-way controller (▶)	Shows the next image.

- 2 Press the four-way controller (▼).

Slideshow ends and the single image display reappears.

After slideshow ends, the camera returns to the single image display even if you do not press the four-way controller (▼).



For movies, only the first frame is displayed and then the next image is displayed after the set interval has elapsed. To play a movie during a slideshow, press the **OK** button while the first frame is displayed. After the playback of the movie is finished, the slideshow will resume.

Rotating Images

You can change the rotation information of an image and save it. Images with changed image rotation information are displayed in the changed orientation during playback.



When [Auto Image Rotation] (p.156) in the [▶ Playback 1] menu is set to (On), images with rotation information are automatically rotated during playback.



- You cannot change the rotation information of protected images.
- Movie files cannot be rotated.

1 Select the image you want to rotate in the single image display, and press the four-way controller (▼).

The playback mode palette appears.

2 Use the four-way controller (▲▼◀▶) to select (Image Rotation), and press the OK button.

The selected image is rotated in 90° increments and the four thumbnail images are displayed.

3 Use the four-way controller (▲▼◀▶) to select the desired rotation direction, and press the OK button.

The image rotation information is saved.

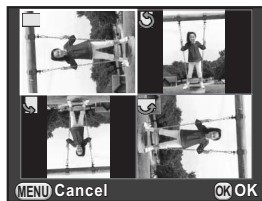

You can delete multiple images at once. Be aware that deleted images cannot be restored.

☞ Protecting Images from Deletion (Protect) (p.200)

Deleting Selected Images

You can delete multiple images at once.





- Protected images cannot be selected.
- You can select up to 100 images at a time.

1 Turn the e-dial to the left (toward ) in the single image display.

The thumbnail display screen appears.

2 Select thumbnail display for 4, 9, 16, or 36 images.

Refer to “Displaying Multiple Images” (p.158) for details.





3 Press the /  button.

The screen to select images to delete is displayed.



4 Select images to delete.



Available operations

Four-way controller Moves the selection frame.
(   )

OK button Confirms/cancels the image selection.

E-dial Displays the selected image in the single image display when turned to the right; returns to thumbnail display when turned to the left.
Use the four-way controller ( ) to display the previous or next image.

5 Press the **UP/** button.

The delete confirmation screen appears.

6 Use the four-way controller (**▲▼**) to select [**Select & Delete**], and press the **OK** button.

The selected images are deleted.



If [Folder Display] is selected in Step 2, the selected folder and all of the images in it can be deleted at the same time. The confirmation screen appears when there are protected images. Use the four-way controller (**▲▼**) to select [Delete all] or [Leave all] and press the **OK** button. When [Delete all] is selected, protected images are also deleted.

Deleting All Images

You can delete all images saved on an SD Memory Card at once.

1 Select [**Delete All Images**] in the [**▶ Playback 1**] menu, and press the four-way controller (**▶**).

The confirmation screen for deleting all images is displayed.

2 Press the four-way controller (**▲**) to select [**Delete All Images**], and press the **OK** button.

All images are deleted.

The confirmation screen appears when there are protected images. Use the four-way controller (**▲▼**) to select [Delete all] or [Leave all] and press the **OK** button.

When [Delete all] is selected, protected images are also deleted.

Changing the Number of Recorded Pixels (Resize)

Changes the number of recorded pixels of a selected image, and saves it as a new file.



- Only JPEG images captured with this camera can be resized.
- Images already resized to 0.3M or 0.2M with this camera cannot be resized.

1 Select an image to resize in the single image display, and press the four-way controller (▼).

The playback mode palette appears.

2 Use the four-way controller (▲▼◀▶) to select  (Resize), and press the OK button.

The screen to select the recorded pixels appears.

3 Use the four-way controller (◀▶) to select the number of recorded pixels, and press the OK button.

You can select one of the image sizes starting from one size smaller than that of the original image. The selectable sizes vary according to the original image size and aspect ratio.



4 Use the four-way controller (▲▼) to select [Save as], and press the OK button.

The resized image is saved as a new image.

Cutting Out Part of the Image (Cropping)

Crops out only the desired area of a selected image and saves it as a new image.



- Only JPEG images captured with this camera can be cropped.
- Images already resized to 0.3M or 0.2M with this camera cannot be cropped.

1 Select an image to crop in the single image display, and press the four-way controller (▼).

The playback mode palette appears.

2 Use the four-way controller (▲▼◀▶) to select (Cropping), and press the OK button.

The cropping frame to specify the size and position of the area to crop appears on the screen.

3 Specify the size and position of the area to crop by using the cropping frame.



Available operations

Four-way controller (▲▼◀▶)	Moves the cropping frame.
E-dial	Changes the size of the cropping frame.
INFO button	Changes the aspect ratio.
→ Four-way controller (▲▼◀▶)	Rotates the image from -45° to +45°.
 / Av button	Rotates the cropping frame (only when the cropping frame can be rotated).

4 Press the OK button.

The save confirmation screen appears.

5 Use the four-way controller (▲▼) to select [Save as], and press the OK button.

The cropped image is saved as a new image.

Processing Images with Digital Filters

You can edit captured images using digital filters.
The following filters are available.

Filter Name	Effect	Parameter
Monochrome	Creates a monochrome image.	Filter Effect: OFF/Red/Green/Blue/ Infrared Filter
		Toning (B-A): 7 levels
Extract Color	Extracts one or two specific colors and makes the rest of the image black and white.	Extracted Color 1: Red/Magenta/ Blue/Cyan/Green/Yellow
		Extractable Range of Color 1: 1 to 5
		Extracted Color 2: OFF/Red/ Magenta/Blue/Cyan/Green/Yellow
		Extractable Range of Color 2: 1 to 5
Toy Camera	Creates an image that looks as though it was shot with a toy camera.	Shading Level: OFF/Low/Medium/ High
		Blur: Low/Medium/High
		Tone Break: Red/Green/Blue/ Yellow
Retro	Creates an image with the look of an old photo.	Toning (B-A): 7 levels
		Frame Composite: None/Thin/ Medium/Thick
High Contrast	Enhances the contrast in the image.	Intensity: 1 to 5
Shading	Creates an image with darkened edges.	Shading Type: 4 types
		Shading Level: -3 to +3
Invert Color	Inverts image colors.	OFF/ON
Color	Adds a color filter to the image.	Color: Red/Magenta/Blue/Cyan/ Green/Yellow
		Color Density: Light/Medium/Dark
Tone Expansion	Creates an image with a unique contrast.	Low/Medium/High
Sketch Filter	Creates an image that looks as though it was drawn with a pencil.	Contrast: Low/Medium/High
		Scratch Effect: OFF/ON
Water Color	Creates an image that looks as though it was painted.	Intensity: Low/Medium/High
		Saturation: OFF/Low/Medium/High

Filter Name	Effect	Parameter
Pastel	Creates an image that looks as though it was drawn with a crayon.	Low/Medium/High
Posterization	Lessens the tone of the image to create an image that looks as though it was hand-drawn.	Intensity: 1 to 5
Miniature	Blurs part of the image to create a simulated miniature scene.	In-Focus Plane: -3 to +3
		In-Focus Width: Narrow/Middle/Wide
		In-Focus Plane Angle: Side/Vertical/Positive Slope/Negative Slope
		Blur: Low/Medium/High
Soft	Creates an image with a soft focus throughout the image.	Soft Focus: Low/Medium/High
		Shadow Blur: OFF/ON
Starburst	Creates an image with a special sparkling look by adding extra glitter to the highlights of night scenes or lights reflected on water.	Effect Density: Small/Medium/Large
		Size: Small/Medium/Large
		Angle: 0°/30°/45°/60°
Fish-eye	Creates an image that looks as though it was shot with a fish-eye lens.	Low/Medium/High
Slim	Changes the horizontal and vertical ratio of images.	-8 to +8
Base Parameter Adj	Adjusts the parameters to create the desired image.	Brightness: -8 to +8
		Saturation: -3 to +3
		Hue: -3 to +3
		Contrast: -3 to +3
		Sharpness: -3 to +3



Only JPEG and RAW images captured with this camera can be edited with digital filters.

- 1 Select an image for applying the digital filter in the single image display, and press the four-way controller (▼).**

The playback mode palette appears.

- 2 Use the four-way controller (▲▼◀▶) to select 0 (Digital Filter), and press the OK button.**

The screen to select a filter appears.

- 3 Use the four-way controller (▲▼◀▶) to select a filter.**

The background image changes according to the selected filter.

You can select a different image by turning the e-dial.

Proceed to Step 6 if you do not need to change the parameters.



- 4 Press the INFO button.**

The screen to adjust the parameters appears.

- 5 Use the four-way controller (▲▼) to select a parameter, and use the four-way controller (◀▶) to adjust the value.**



- 6 Press the OK button.**

The save confirmation screen appears.

7 Use the four-way controller (▲▼) to select [Apply additional filter(s)] or [Save as], and press the OK button.

Select [Apply additional filter(s)] when you want to apply additional filters to the same image. The screen that was displayed in Step 3 appears again.

If [Save as] is selected, the filter-processed image is saved as a new image.



Up to 20 filters, including a digital filter used during shooting (p.144), can be applied to the same image.

Recreating Filter Effects

Retrieves the filter effects of a selected image and applies the same filter effects to other images.

- 1 Select a filter-processed image in the single image display.
- 2 Select 0 (Digital Filter) in the playback mode palette, and press the OK button.
- 3 Use the four-way controller (▲▼) to select [Recreating filter effects], and press the OK button.

The filter effects used for the selected image appear.

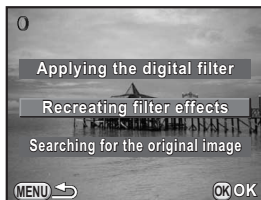

4 To check the parameter details, press the INFO button.

You can check the filter parameters.

Press the **MENU** button to return to the previous screen.

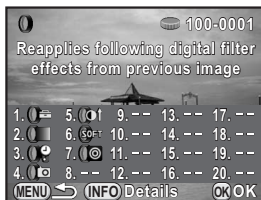

5 Press the OK button.

The image selection screen appears.

6 Use the e-dial to select an image to apply the same filter effects, and press the OK button.

You can only select an image that has not been processed with a filter.

The save confirmation screen appears.



7 Use the four-way controller (▲▼) to select [Save as], and press the OK button.

The filter-processed image is saved as a new image.



If [Searching for the original image] is selected in Step 3 on p.170, the original image prior to digital filter application can be retrieved. If the original image is no longer stored on the SD Memory Card, the message [Original image, prior to digital filter application, is not found] appears.

Joining Multiple Images (Index)

Join a number of images together and display them as an index print. You can also save the displayed index print as a new image. You can have the camera select the images to include in the index print or you can select them yourself. The images will be randomly arranged or displayed by file number depending on the layout selected.







1 Press the four-way controller (▼) in the single image display.

The playback mode palette appears.

2 Use the four-way controller (▲▼◀▶) to select (Index), and press the OK button.

The Index setting screen appears.

3 Press the four-way controller (▶), use the four-way controller (▲▼) to select a layout, and press the OK button.

You can select  (Thumbnail),  (Square),  (Random1),  (Random2),  (Random3) or  (Bubble).

Images are displayed according to the file number (from the smallest number) for , and are displayed in random order for other layouts.

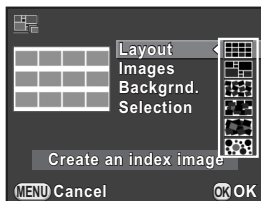

4 Use the four-way controller (▲▼) to select [Images], and press the four-way controller (▶).

5 Use the four-way controller (▲▼) to select the number of images, and press the OK button.

You can select 12, 24 or 36 images.

When the number of saved images is smaller than the number selected, empty spaces will appear when [Layout] is set to  and some images may be duplicated for other layouts.





6 Use the four-way controller (▲▼) to select [Backgrnd.], and press the four-way controller (▶).

- 7** Use the four-way controller (▲▼) to select the background color, and press the OK button.

You can select a white or black background.

- 8** Use the four-way controller (▲▼) to select [Selection], and press the four-way controller (▶).



- 9** Use the four-way controller (▲▼) to select a type of image selection, and press the OK button.

 All images	Picks images automatically from all of the images saved.
 Manual	Lets you select images you want to include in the index image. If  is selected, [Select image(s)] appears and leads you to the image selection screen.
 Folder name	Picks images automatically from the folder selected. If  is selected, [Select a folder] appears and leads you to the folder selection screen.

- 10** Use the four-way controller (▲▼) to select [Create an index image], and press the OK button.

The index image is created and a confirmation screen appears.

- 11** Use the four-way controller (▲▼) to select [Save] or [Reshuffle], and press the OK button.

Save	Saves the index image as a  ,  (3072×2048) and ★★★ file.
Reshuffle	Reselects the images to be included in the index image and displays a new index image. However, if  (Thumbnail) is selected for [Layout], this item is not displayed.

After the index image is saved, the camera returns to playback mode and the index image is displayed.



Processing may take a while when creating an index image.

You can convert captured RAW images into JPEG images, and save them as new files.



Only RAW images captured with this camera can be edited. RAW images and JPEG images captured with other cameras cannot be edited on this camera.

Developing One RAW Image

- 1 **Select a RAW image in the single image display, and press the four-way controller (▼).**

The playback mode palette appears.

- 2 **Use the four-way controller (▲▼◀▶) to select ^{RAW} (RAW Development), and press the OK button.**

The screen to select a development method is displayed.

- 3 **Use the four-way controller (▲▼) to select [Developing a single image], and press the OK button.**

The parameters saved in the image file appear.

Proceed to Step 6 if you do not need to change the parameters.



- 4 **Use the four-way controller (▲▼) to choose a parameter you want to change.**

You can select a different image by turning the e-dial.



The following parameters can be changed.

Parameter	Value	Page
Aspect Ratio	$\overline{16:9}$ / $\overline{3:2}$ / $\overline{4:3}$ / $\overline{1:1}$	p.126
JPEG Recorded Pixels *1	JPEG recorded pixels corresponding to the aspect ratio	p.128
JPEG Quality	★★★/★★/★	p.129
Color Space	sRGB/AdobeRGB	p.129
Distortion Correction *2	Off/On	p.138
Lat-Chromatic-Ab Adj *2	Off/On	
Custom Image	Bright/Natural/Portrait/Landscape/ Vibrant/Radiant/Muted/Bleach Bypass/ Reversal Film/Monochrome/Cross Processing	p.140
White Balance	AWB/ $\overline{\text{A}}$ / $\overline{\text{B}}$ / $\overline{\text{C}}$ / $\overline{\text{D}}$ / $\overline{\text{N}}$ / $\overline{\text{W}}$ / $\overline{\text{L}}$ / $\overline{\text{WB}}$ / $\overline{\text{CTE}}$ / $\overline{\text{M}}$	p.130
Sensitivity	-2.0 to +2.0	—
High-ISO NR	Off/Auto/Low/Medium/High	p.89
Shadow Correction	Off/Auto/Low/Medium/High	p.134

*1 When developing multiple images, select from $\overline{\text{L}}$, $\overline{\text{L}}$, $\overline{\text{M}}$, or $\overline{\text{S}}$. (p.176)

*2 This can be selected only for images taken with a compatible lens. (p.232)

5 Use the four-way controller (◀▶) to change the value.

Press the four-way controller (▶) to display the setting screen for Custom Image and White Balance.

6 Press the OK button.

The save confirmation screen appears.

7 Use the four-way controller (▲▼) to select [Save as], and press the OK button.

The RAW image is developed and saved as a new JPEG image.

8 Use the four-way controller (▲▼) to select [Continue] or [Exit], and press the OK button.

Select [Continue] to edit other images. The screen that was displayed in Step 4 appears again.

Developing Multiple RAW Images

You can develop multiple RAW images with the same settings.

1 Select [Developing multiple images] in Step 3 on p.174, and press the OK button.

Images are displayed in [4 Thumbnail Display], [9 Thumbnail Display], [16 Thumbnail Display] or [36 Thumbnail Display] (the display style that was set immediately before).

2 Select the RAW images to be developed.

Available operations

Four-way controller Moves the selection frame.
(▲▼◀▶)

OK button Confirms/cancels the image selection.

E-dial Displays the selected image in the single image display.
Use the four-way controller (◀▶) to display the previous or next image.

3 Press the /Av button.

The development confirmation screen appears.

4 Use the four-way controller (▲▼) to select [Develop images as shot] or [Develop images with modified settings], and press the OK button.

To change parameters, select [Develop images with modified settings].



5 Use the four-way controller (▲▼◀▶) to set [JPEG Recorded Pixels] and [JPEG Quality].

For JPEG Recorded Pixels, select from [LL], [L], [M], or [S].

When [Develop images with modified settings] is selected in Step 4, refer to p.175 to change other parameters. All images are developed with the same settings.

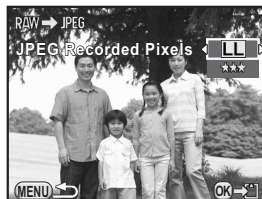

6 Press the OK button.

The save confirmation screen appears.

7 Use the four-way controller (▲▼) to select [Save as], and press the OK button.

The selected RAW images are developed and saved as new JPEG images.

Connecting the Camera to an AV Device

You can connect the camera to a TV or other device with a video input terminal or HDMI input terminal and play back images.



- For an AV device with multiple video input terminals, check the operating manual of the device, and select a suitable video input terminal for connecting the camera.
- If you intend to use the camera continuously for a long period, use of the AC Adapter kit K-AC1202 (optional) is recommended. (p.42)

Connecting the Camera to a Video Input Terminal or HDMI Input Terminal

Use a cable according to the terminal of the device to which you connect.

Terminal of AV Device	Cable Used
Video terminal	Video Cable I-VC28 (optional)/AV Cable I-AVC7 (optional)
HDMI terminal	HDMI cable with an HDMI terminal (Type C) (commercially available)

- 1 Turn the AV device and camera off.**
- 2 Open the terminal cover of the camera, and connect the cable to either the PC/AV output terminal or the HDMI output terminal.**

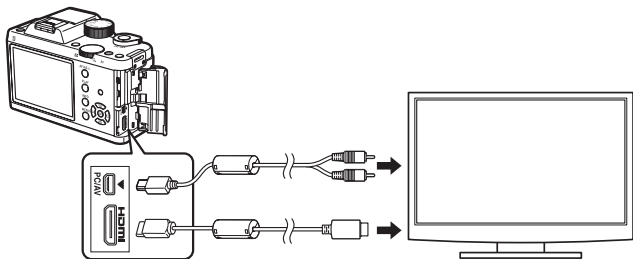

3 Connect the other end of the cable to the input terminal on the AV device.

4 Turn the AV device and camera on.

The camera turns on in video mode or HDMI mode, and the camera information is displayed on the screen of the connected AV device.



- You cannot output composite and HDMI video signals at the same time.
- You cannot adjust the volume on the camera while the camera is connected to an AV device. Adjust the volume on the AV device.
- When using the video output, movies are played back with monaural sound.
- When using the video output, images are output at normal resolution regardless of the resolution supported by the AV device. To output HD video, use the HDMI output or transfer to and play back on a computer.

Setting the Video/HDMI Output Format

Set the video/HDMI output format according to the connected terminal. Normally, the output format initially set does not have to be changed. However, if it fails to play back images properly, change the setting.

Selecting the Video Output Format

When the hometown is set at the time of initial setting (p.50), the video output format is set in accordance with that region. Depending on the country or region, images may fail to be played back with the set video output format. If this happens, change the setting.

1 Select [Interface Options] in the [Set-up 2] menu, and press the four-way controller (▶).

The [Interface Options] screen appears.

2 Use the four-way controller (▲▼) to select [Video Out], and press the four-way controller (▶).

3 Use the four-way controller (▲▼) to select [NTSC] or [PAL], and press the OK button.

4 Press the MENU button twice.

The screen that was displayed before selecting the menu item appears again.



The video output format differs depending on the region. When you set [Setting the Time] in the World Time setting (p.187) to → (Destination), the video output setting changes to the video output format for that city. Refer to "List of World Time Cities" (p.189) for cities that can be selected as a hometown or destination.

Selecting the HDMI Output Format

By default, the maximum resolution is automatically selected to suit the AV device and camera. However, if it fails to play back images properly, change the setting.

1 Select [Interface Options] in the [↖ Set-up 2] menu, and press the four-way controller (▶).

The [Interface Options] screen appears.

2 Use the four-way controller (▲▼) to select [HDMI Out], and press the four-way controller (▶).

3 Use the four-way controller (▲▼) to select the HDMI output format, and press the OK button.

Auto	The maximum resolution corresponding to the AV device and camera is automatically selected. (default setting)
1080i	1920×1080i
720p	1280×720p
480p	720×480p (when [Video Out] is set to [NTSC])
576p	720×576p (when [Video Out] is set to [PAL])

4 Press the MENU button twice.

The screen that was displayed before selecting the menu item appears again.



- When the HDMI output format is set to [1080i] or [720p], some items displayed on the screen of the AV device may have a different design from those on the camera monitor.
- If the **MENU** button is pressed during HDMI output, the [HDMI] menu is displayed and the following settings can be changed.
 - HDMI Out
 - Slideshow (p.160)
 - Bright/Dark Area (p.156)
 - Auto Image Rotation (p.156)



The camera stays in playback mode while the HDMI cable is connected to it. Remove the HDMI cable to enable shooting.

Memo

7 Changing Additional Settings

This chapter describes how to change additional settings.

How to Operate the Set-up Menu	184
Camera Settings	186
File Management Settings	199



How to Operate the Set-up Menu



The [ Set-up] menu offers you general settings related to the camera.



For details on how to use the menus, refer to "Using the Menus" (p.33).

Set-up Menu Items

The following items are available in the [ Set-up 1-3] menus. Press the **MENU** button in capture/playback mode and use the four-way controller (◀▶) or e-dial to display the [ Set-up 1-3] menus.

Menu	Item	Function	Page	
 1	Language/言語	Changes the language in which menus and messages appear.	p.190	
	Date Adjustment	Sets the date format and time.	p.187	
	World Time	Sets the display of the local date and time of the specified city so they can be displayed on the monitor in addition to the present location.	p.187	
	Sound Effects	Switches the operation sound on/off and changes its volume.	p.186	
	LCD Display	Switches the startup screen and guide display on/off.	p.192	
	LCD Display Settings	Adjusts the brightness and the color of the monitor.	p.192	
	Flicker Reduction	Cuts down on screen flicker by setting the power frequency to that used in your region.	p.30	
 2	Interface Options	Video Out	Sets the output format when connecting to an AV device with a video input terminal.	p.179
		HDMI Out	Sets the HDMI output format when connecting to an AV device with an HDMI terminal.	p.180
		USB Connection	Sets the USB connection mode when connecting to a computer.	p.209

Menu	Item	Function	Page
2	Folder Name	Sets the naming system for folders to store images.	p.201
	Create New Folder	Creates a new folder on the SD Memory Card.	p.201
	Copyright Information	Sets the photographer and copyright information embedded in Exif.	p.202
	Power Saving	Enables saving battery power by setting the display to dim automatically when no operation is performed for 10 seconds.	p.194
	Auto Power Off	Sets the time until the camera turns off automatically.	
	Reset	Resets all settings.	p.196
3	Pixel Mapping	Maps out and corrects any defective pixels in the CMOS sensor.	p.194
	Dust Removal	Cleans the CMOS sensor by shaking it.	p.237
	Sensor Cleaning	Keeps the shutter open when cleaning the CMOS sensor with a blower.	p.238
	Format	Formats an SD Memory Card.	p.199
	Firmware Info/Options	Displays the camera's firmware version.	p.197

Setting the Sound Effects, Date and Time, and Display Language

Setting the Sound Effects

You can turn the camera operation sound on or off, or change its volume. The sound for the following items can be set.

- In-focus
- AE-L (AE Lock operation sound)
- Self-timer
- Remote Control
- One Push File Format (operation sound when [One Push File Format] is assigned to the  (G/R) button)

1 Select [Sound Effects] in the [Set-up 1] menu, and press the four-way controller ().

The [Sound Effects] screen appears.

2 Use the four-way controller () to adjust the volume.

Select from six levels. When set to  (0), you can turn all the sound effects off.

3 Use the four-way controller () to select an item, and use the four-way controller () to select (On) or (Off).

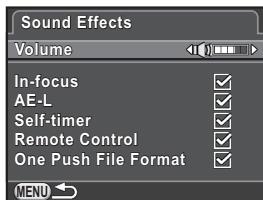

4 Press the MENU button twice.

The screen that was displayed before selecting the menu item appears again.

Changing the Date and Time Display

You can change the initial date and time settings, and their display formats.

Set in [Date Adjustment] of the [↖ Set-up 1] menu.

☞ Setting the Date and Time (p.52)

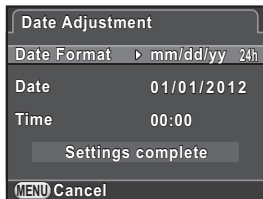

Setting the World Time

The date and time set in “Initial Settings” (p.50) serve as the date and time of your present location.

Setting the destination in [World Time] enables you to display the local date and time on the monitor when traveling overseas.

- 1** Select [World Time] in the [↖ Set-up 1] menu, and press the four-way controller (▶).

The [World Time] screen appears.

- 2** Use the four-way controller (◀▶) to select → (Destination) or ↶ (Hometown) for [Setting the Time].

This setting is reflected in the date and time that appear in the control panel.



- 3** Press the four-way controller (▼) to move the frame to → (Destination), and press the four-way controller (▶).

The [→ Destination] screen appears.

4 Use the four-way controller (◀▶) to select a destination city.

Turn the e-dial to change the region.

The location, time difference and current time of the selected city appear.



5 Press the four-way controller (▼) to select [DST], and use the four-way controller (◀▶) to select (On) or (Off).

Select if the destination city uses daylight saving time (DST).

6 Press the OK button.

The destination setting is saved and the screen that was displayed in Step 2 appears again.

7 Press the MENU button twice.

The screen that was displayed before selecting the menu item appears again.

7



- Refer to "List of World Time Cities" (p.189) for cities that can be selected as a destination.
- Select (Hometown) in Step 3 to change the city and DST setting.
- appears in the control panel if [Setting the Time] is set to (Destination). Also, the video output setting (p.179) changes to the video output format for that city.

● List of World Time Cities

Region	City	Video Output Format	Region	City	Video Output Format
North America	Honolulu	NTSC	Africa/ West Asia	Istanbul	PAL
	Anchorage	NTSC		Cairo	PAL
	Vancouver	NTSC		Jerusalem	PAL
	San Francisco	NTSC		Nairobi	PAL
	Los Angeles	NTSC		Jeddah	PAL
	Calgary	NTSC		Tehran	PAL
	Denver	NTSC		Dubai	PAL
	Chicago	NTSC		Karachi	PAL
	Miami	NTSC		Kabul	PAL
	Toronto	NTSC		Male	PAL
	New York	NTSC		Delhi	PAL
	Halifax	NTSC		Colombo	PAL
Central and South America	Mexico City	NTSC	Kathmandu	PAL	
	Lima	NTSC	Dacca	PAL	
	Santiago	NTSC	East Asia	Yangon	NTSC
	Caracas	NTSC		Bangkok	PAL
	Buenos Aires	PAL		Kuala Lumpur	PAL
	Sao Paulo	PAL		Vientiane	PAL
Rio de Janeiro	NTSC	Singapore		PAL	
Europe	Lisbon	PAL		Phnom Penh	PAL
	Madrid	PAL		Ho chi Minh	PAL
	London	PAL		Jakarta	PAL
	Paris	PAL		Hong Kong	PAL
	Amsterdam	PAL		Beijing	PAL
	Milan	PAL		Shanghai	PAL
	Rome	PAL		Manila	NTSC
	Copenhagen	PAL	Taipei	NTSC	
	Berlin	PAL	Seoul	NTSC	
	Prague	PAL	Tokyo	NTSC	
	Stockholm	PAL	Guam	NTSC	
	Budapest	PAL	Oceania	Perth	PAL
	Warsaw	PAL		Adelaide	PAL
	Athens	PAL		Sydney	PAL
	Helsinki	PAL		Noumea	PAL
	Moscow	PAL		Wellington	PAL
Africa/ West Asia	Dakar	PAL		Auckland	PAL
	Algiers	PAL	Pago Pago	NTSC	
	Johannesburg	PAL			

Setting the Display Language

You can change the language in which the menus, error messages, etc. are displayed.

Set in [Language/言語] of the [Set-up 1] menu.

Setting the Display Language (p.50)

Setting the Monitor and the Menu Display

Setting the Standby Mode Display Method

Sets the monitor display when the standby mode display is set to [Standard Information Display] or [No Information Display].

- 1 Select [Live View] in the [Rec. Mode 3] menu, and press the four-way controller (▶).

The [Live View] screen appears.

- 2 Press the four-way controller (▶), use the four-way controller (▲▼) to select a grid display type, and press the OK button.

Select from (4x4 Grid), (Golden Section), (Scale) or (default setting).

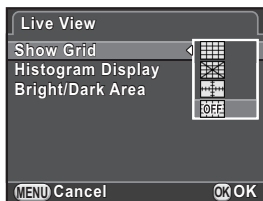

- 3 Press the four-way controller (▲▼) to select [Histogram Display] or [Bright/Dark Area], and use the four-way controller (◀▶) to select (On) or (Off).

Histogram Display	Shows the brightness distribution of an image. (p.28)
Bright/Dark Area	Bright (overexposed) portions blink red and dark (underexposed) portions blink yellow. (p.29)

- 4 Press the MENU button twice.

The screen that was displayed before selecting the menu item appears again.

Setting the Display for Instant Review

You can set the Instant Review (p.57) display settings.

- 1** Select [Instant Review] in the [📷 Rec. Mode 3] menu, and press the four-way controller (▶).

The [Instant Review] screen appears.

- 2** Press the four-way controller (▶), use the four-way controller (▲▼) to select a display time, and press the OK button.



- 3** Use the four-way controller (▲▼) to select [Enlarge Instant Review], [Save RAW Data], [Histogram Display] or [Bright/Dark Area], and use the four-way controller (◀▶) to select (On) or (Off).

Enlarge Instant Review	You can magnify the image with the e-dial. (p.157)
Save RAW Data	Sets whether to save the RAW image by pressing the /Av button when the file format of the last captured image is JPEG and its RAW data still remains in the buffer memory. (p.64)
Histogram Display	Shows the brightness distribution of an image. (p.28)
Bright/Dark Area	Bright (overexposed) portions blink red and dark (underexposed) portions blink yellow. (p.29)

- 4** Press the MENU button twice.

The screen that was displayed before selecting the menu item appears again.

Setting the Startup Screen and Guide Display

You can set whether or not to display the startup screen, and the guide display (p.75) which appears when the mode dial is turned in standby mode. Set in [LCD Display] of the [↖ Set-up 1] menu.

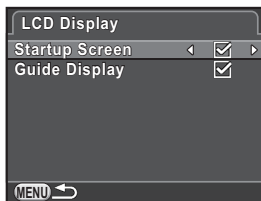

Adjusting the Brightness and the Color of the Monitor

Adjusts the brightness and the color of the monitor.

- 1** Select [LCD Display Settings] in the [↖ Set-up 1] menu, and press the four-way controller (▶).

The [LCD Display Settings] screen appears.

- 2** Use the four-way controller (▲▼) to select [Brightness Level], [Adjust: Blue-Amber], or [Adjust: Green-Magenta].

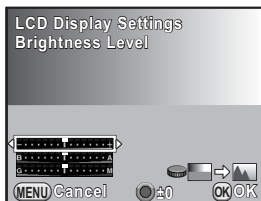

Brightness Level	Changes the brightness of the monitor (-7 to +7).
Adjust: Blue-Amber	Adjusts the tone of the colors between blue (B7) and amber (A7).
Adjust: Green-Magenta	Adjusts the tone of the colors between green (G7) and magenta (M7).

3 Use the four-way controller (◀▶) to adjust the value.

Available operations

⊙ (G) button	Resets the adjustment value.
E-dial	Displays a captured image in the background.

4 Press the OK button.

5 Press the MENU button.

The screen that was displayed before selecting the menu item appears again.

Setting the Initial Menu Tab to be Displayed

Set the initial menu tab displayed on the monitor when the **MENU** button is pressed.

1 Select [14. Save Menu Location] in the [C Custom Setting 2] menu, and press the four-way controller (▶).

The [14. Save Menu Location] screen appears.

2 Use the four-way controller (▲▼) to select [Reset Menu Location] or [Save Menu Location], and press the OK button.

1	Reset Menu Location	The [📷 Rec. Mode 1] menu ([🎞️ Movie 1] menu in 🎞️ mode, and [▶ Playback 1] menu in playback mode) is always displayed first. (default setting)
2	Save Menu Location	The menu tab last selected is displayed first.

3 Press the MENU button.

The screen that was displayed before selecting the menu item appears again.

Minimizing Battery Consumption

You can set the monitor to dim and the camera to turn off automatically if unused for a certain length of time.

Set in [Power Saving] and [Auto Power Off] of the [ Set-up 2] menu.

Power Saving	The monitor brightness goes dim if the camera is unused for a while in standby mode. The default setting is  (On). Press any button to return it to the normal brightness.
Auto Power Off	The power turns off automatically. Select from [1min.] (default setting), [3min.], [5min.], or [Off]. Perform any of the following operations to reactivate the camera. - Turn the camera off and on again. - Press the shutter release button halfway. - Press the PLAY button, MENU button, or INFO button.



- The Power Saving function does not work while a movie is being recorded or while the AC adapter is connected to the camera.
- The Auto Power Off function does not work when a slideshow is played back, or when the camera is connected to a computer with an USB cable.

Correcting Defective Pixels in the CMOS Sensor (Pixel Mapping)

Pixel Mapping is a function for mapping out and correcting defective pixels in the CMOS sensor.

Attach a proper lens to the camera before performing pixel mapping.

1 Select [Pixel Mapping] in the [Set-up 3] menu, and press the four-way controller (▶).

The [Pixel Mapping] screen appears.

2 Press the four-way controller (▲) to select [Pixel Mapping], and press the OK button.

Defective pixels are mapped and corrected, and the screen that was displayed before selecting the menu item appears again.



- It takes about 30 seconds to map out and correct the defective pixels.
- When the battery level is low, [Not enough battery power remaining to activate Pixel Mapping] is displayed on the monitor. Use the AC Adapter kit K-AC1202 (optional) or install a fully charged battery.

Selecting Settings to Save in the Camera (Memory)

You can select which function settings to save when the camera is turned off. The following function settings can be saved.

Function	Default Setting
Flash Mode	<input checked="" type="checkbox"/>
Drive Mode	<input checked="" type="checkbox"/>
White Balance	<input checked="" type="checkbox"/>
Custom Image	<input checked="" type="checkbox"/>
Sensitivity	<input checked="" type="checkbox"/>
EV Compensation	<input checked="" type="checkbox"/>

Function	Default Setting
Flash Exposure Comp.	<input checked="" type="checkbox"/>
Digital Filter	<input type="checkbox"/>
HDR Capture	<input type="checkbox"/>
Playback Info Display	<input checked="" type="checkbox"/>
File No.	<input checked="" type="checkbox"/>

- 1** Select **[Memory]** in the **[Rec. Mode 3]** menu, and press the four-way controller (▶).

The [Memory 1] screen appears.

- 2** Use the four-way controller (▲▼) to select an item, and use the four-way controller (◀▶) to select (On) or (Off).

Turn the e-dial to display the [Memory 2] screen.

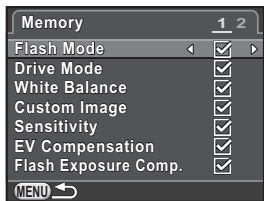

<input checked="" type="checkbox"/>	Settings are saved even when the camera is turned off.
<input type="checkbox"/>	Settings are returned to their default values when the camera is turned off.

- 3** Press the **MENU** button twice.

The screen that was displayed before selecting the menu item appears again.



- Set [File No.] to (On) to continue the sequential numbering (four digits) for the file name even if a new folder is created.

<input checked="" type="checkbox"/>	The file number of the last image saved to the previous folder is saved and subsequent images are assigned sequential file numbers even if a new folder is created.
<input type="checkbox"/>	The file number of the first image saved to a folder returns to 0001 each time a new folder is created for saving images.

- When [Reset] of the [Set-up 2] menu is performed, all Memory settings return to the default values. (p.196)

Resetting the Camera Settings

Resetting the Rec. Mode/Movie/Playback/Set-up Menus

Settings of the direct keys and for the items of the [Rec. Mode] menu, [Movie] menu, [Playback] menu, [Set-up] menu, and playback mode palette can be reset to default values.

1 Select [Reset] in the [Set-up 2] menu, and press the four-way controller (▶).

The [Reset] screen appears.

2 Press the four-way controller (▲) to select [Reset], and press the OK button.

The settings are reset, and the screen that was displayed before selecting the menu item appears again.



The following settings are not reset.

- | | |
|--|--------------------------------|
| - Language/言語 | - Flicker Reduction |
| - Date Adjustment | - Video Out |
| - The city and DST settings for World Time | - [Custom Setting] menu items |

Resetting the Custom Menu

Settings for the items of the [C Custom Setting] menu can be reset to default values.

- 1 **Select [Reset Custom Functions] in the [C Custom Setting 3] menu, and press the four-way controller (▶).**

The [Reset Custom Functions] screen appears.

- 2 **Press the four-way controller (▲) to select [Reset], and press the OK button.**

The settings are reset, and the screen that was displayed before selecting the menu item appears again.

Checking the Camera Version Information

You can check the version information for software (firmware) in the camera. If an update file for the firmware is released, you can update the camera to the latest firmware version.



Refer to the PENTAX website for more information and procedural details regarding updates.

- 1 **Select [Firmware Info/Options] in the [↖ Set-up 3] menu, and press the four-way controller (▶).**

The firmware version for the camera is displayed on the [Firmware Info/Options] screen.

At this point, if an update file is saved on your SD Memory Card, you can run the update.



- 2 **Press the MENU button twice.**

The screen that was displayed before selecting the menu item appears again.

Caution

- You cannot restore a camera to its previous firmware version after updating it.
- Before running the update, be sure to save the data on your SD Memory Card to a computer or other location.
- When the battery level is low, [Not enough battery power remaining to update the firmware] is displayed on the monitor. Use the AC Adapter kit K-AC1202 (optional) or install a fully charged battery.

Formatting an SD Memory Card

Use this camera to format (initialize) an SD Memory Card that is unused or has been used on other devices.

Formatting deletes all the data saved on the SD Memory Card.



- Do not remove the SD Memory Card while formatting. The card may be damaged and become unusable.
- Formatting deletes all data, either protected or unprotected. Be aware.

1 Select [Format] in the [↖ Set-up 3] menu, and press the four-way controller (▶).

The [Format] screen appears.

2 Press the four-way controller (▲) to select [Format], and press the OK button.

Formatting starts.

When formatting is completed, the screen that was displayed before selecting the menu item appears again.

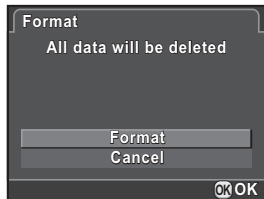

When an SD Memory Card is formatted, the volume label assigned to the card is "K-01". When this camera is connected to a computer, the SD Memory Card is recognized as a removable disk with the name "K-01".

Protecting Images from Deletion (Protect)

You can protect images from being accidentally deleted.



Even protected images are deleted if the inserted SD Memory Card is formatted.

1 Press the four-way controller (▼) in the single image display of playback mode.

The playback mode palette appears.

2 Use the four-way controller (▲▼◀▶) to select (Protect), and press the OK button.

The screen to select how to change the settings is displayed.

3 Use the four-way controller (▲▼) to select [Single image] or [All images], and press the OK button.

If you selected [All images], proceed to Step 5.



4 Use the e-dial to select an image to protect.

5 Press the four-way controller (▲) to select [Protect], and press the OK button.

Select [Unprotect] to cancel the protection of the image.

The image is protected and the  icon appears at the top right of the screen.

Repeat Steps 4 and 5 to protect other images.

If you selected [All images] in Step 3, the camera returns to playback mode.

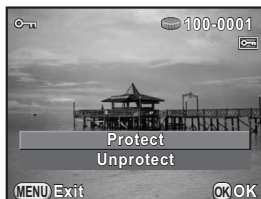

6 Press the MENU button.

The camera returns to the single image display.

Changing the Naming System for Folders

When images are captured with this camera, a folder is automatically created and the captured images are stored in the new folder. Each folder name consists of a sequential number from 100 to 999 and a string of 5 characters. You can change the folder name in [Folder Name] of the [Setup 2] menu.

Date	The two digits of the month and day on which the picture was taken are assigned as the folder name in the form of [xxx_MMDD]. (default setting) [MMDD] (month and day) appears according to the display format set in [Date Adjustment] (p.52). Example: 101_0125: Folder for images taken on January 25th
PENTX	The folder name is assigned in the form of [xxxPENTX]. Example: 101PENTX



A maximum of 500 images can be stored in a single folder. When the number of captured images exceeds 500, a new folder is created to store the additional images. However, in Exposure Bracketing shooting, images will be stored in the same folder until shooting is completed, even if the number of images exceeds 500.

Creating New Folders

You can create a new folder on an SD Memory Card. A folder is created with the number following the number of the folder currently being used. The newly created folder is used to store images starting with the next captured image.

- 1 Select [Create New Folder] in the [Setup 2] menu, and press the four-way controller (▶).**

The [Create New Folder] screen appears.

- 2 Press the four-way controller (▲) to select [Create folder], and press the OK button.**

A folder with a new number is created.





Only one folder can be created using this operation. Multiple empty folders cannot be created consecutively.

Setting the Photographer Information

The camera type, shooting conditions and other information are automatically embedded in captured images in Exif data format. You can embed photographer information in this Exif.



Use the provided software (p.211) to check the Exif information.

- 1 Select [Copyright Information] in the [Set-up 2] menu, and press the four-way controller (▶).**

The [Copyright Information] screen appears.

- 2 Use the four-way controller (◀▶) to select or .**

<input checked="" type="checkbox"/>	Embeds copyright information in the Exif.
<input type="checkbox"/>	Does not embed copyright information in the Exif. (default setting)



- 3 Use the four-way controller (▲▼) to select [Photographer], and press the four-way controller (▶).**

The text-entry screen appears.

4 Enter the text.

Up to 32 single-byte alphanumeric characters and symbols can be entered.

Text selection cursor

Text input cursor



Available operations

Four-way controller (▲▼◀▶)	Moves the text selection cursor.
E-dial	Moves the text input cursor.
⊞/Av button	Switches between upper and lower case letters.
OK button	Enters a character selected with the text selection cursor at the position of the text input cursor.
⏪UP/⏩ button	Deletes a character at the position of the text input cursor.

5 After entering the text, move the text selection cursor to [Finish], and press the OK button.

The camera returns to the [Copyright Information] screen.

6 Use the four-way controller (▲▼) to select [Copyright Holder], and enter the text in the same way as [Photographer].

7 Press the MENU button twice.

The screen that was displayed before selecting the menu item appears again.

Setting the DPOF Settings

By adding DPOF (Digital Print Order Format) settings to stored images on the SD Memory Card, you can specify the number of copies and whether to imprint the date on the images in advance and order conventional photograph prints by taking this SD Memory Card to a store for printing.



- DPOF settings cannot be applied to RAW images and movies.
- You can make DPOF settings for up to 999 images.

1 Press the four-way controller (▼) in the single image display of playback mode.

The playback mode palette appears.

2 Use the four-way controller (▲▼◀▶) to select (DPOF), and press the OK button.

The screen to select how to change the settings is displayed.

3 Use the four-way controller (▲▼) to select [Single image] or [All images], and press the OK button.

If you selected [All images], proceed to Step 5.



4 Use the e-dial to select an image to set DPOF settings.



5 Use the four-way controller (▲▼) to select the number of copies.

You can set up to 99 copies.

-  appears at the top right of the screen for images with DPOF settings.
- To cancel the DPOF settings, set the number of copies to [00].

6 Press the INFO button to select or for printing the date.

<input checked="" type="checkbox"/>	The date is printed.
<input type="checkbox"/>	The date is not printed.

Repeat Steps 4 to 6 to make DPOF settings for other images.

7 Press the OK button.

The DPOF settings for the selected image or all images are saved and the camera returns to playback mode.



- Depending on the printer or printing equipment at the photo processing lab, the date may not be printed on the pictures even if the date for DPOF setting is set to .
- The number of copies specified for all images is applied to all the images, and that specified for a single image is canceled. Before printing, check that the specified number is correct.

Memo

8 Connecting to a Computer

This chapter explains how to connect the camera to a computer, install the supplied CD-ROM, etc.

Manipulating Captured Images on a Computer	208
Saving Images on a Computer	209
Using the Provided Software	211

Manipulating Captured Images on a Computer

The captured still pictures and movies can be transferred to a computer by connecting the camera using a USB cable, and RAW images can be developed using the provided software “SILKYPIX Developer Studio”. When connecting the camera to a computer and using the software, we recommend using a computer with the following system requirements.

● Windows

OS	Windows XP (SP3 or later, 32-bit Home/Pro), Windows Vista (32-bit, 64-bit), Windows 7 (32-bit, 64-bit) <ul style="list-style-type: none"> • Installation requires administrator rights • Can be run as a 32-bit application on any 64-bit Edition of Windows
CPU	Intel Pentium-compatible processor (Pentium 4, Athlon XP or higher recommended) <ul style="list-style-type: none"> • Supports multi-core processors (Intel Core i5, i7; Core 2 Quad, Duo; AMD Phenom II X4, X6; Athlon II X2, X4; and other)
RAM	1 GB minimum (2 GB or more recommended)
HDD	For installing and starting up the program: 100 MB minimum of free space For saving image files: Approx. 10 MB/file
Monitor	1024×768 dots, 24-bit full color or higher
Others	Input devices such as a keyboard and mouse

● Macintosh

OS	Mac OS X 10.5, 10.6, or 10.7
CPU	Intel processor-compatible, Power PC
RAM	1 GB minimum (2 GB or more recommended)
HDD	For installing and starting up the program: 100 MB minimum of free space For saving image files: Approx. 10 MB/file
Monitor	1024×768 dots, 24-bit full color or higher
Others	Input devices such as a keyboard and mouse



- Use the provided software to develop RAW images captured with this camera.
- QuickTime is required to play back movies transferred to a computer. You can download it from the following site: <http://www.apple.com/quicktime/>

Setting the USB Connection Mode

Set the USB connection mode when connecting the camera to a computer.

- 1** Select [Interface Options] in the [ Set-up 2] menu, and press the four-way controller (▶).

The [Interface Options] screen appears.

- 2** Use the four-way controller (▲ ▼) to select [USB Connection], and press the four-way controller (▶).

- 3** Use the four-way controller (▲ ▼) to select [MSC] or [PTP], and press the OK button.

MSC	Mass Storage Class (default setting) A general-purpose driver program that handles devices connected to a computer via USB as a memory device.
PTP	Picture Transfer Protocol A protocol that allows transfer of digital images and control of digital cameras via USB.

Unless otherwise specified, select [MSC].

- 4** Press the MENU button twice.

The screen that was displayed before selecting the menu item appears again.

Connecting the Camera and a Computer

Connect the camera to a computer using the provided USB cable I-USB7.

- 1 Turn the computer on.**
- 2 Turn the camera off, and use the USB cable to connect the PC/AV terminal of the camera and the computer.**

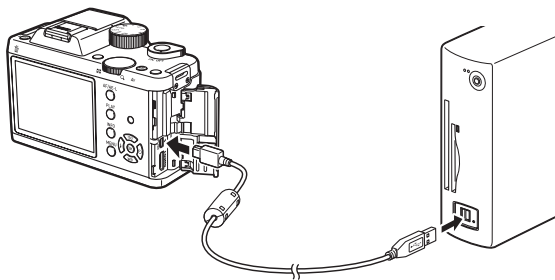

- 3 Turn the camera on.**

The camera is recognized as a removable disk or an SD Memory Card with a volume label "K-01".

If the "K-01" dialog appears when the camera is turned on, select [Open folder to view files using Windows Explorer] and click the OK button.

- 4 Save the captured images to the computer.**

Copy the image file(s) or folder(s) to the hard disk of the computer.

- 5 Disconnect the camera from the computer.**



The camera cannot be operated while the USB cable is connected to it. Remove the USB cable to enable shooting.

“SILKYPIX Developer Studio 3.0 for PENTAX” is included on the CD-ROM (S-SW120). With the SILKYPIX Developer Studio, you can develop RAW files, adjust the color of the images and other settings, and save the new images in JPEG or TIFF format.

Installing the Software

You can install the software from the provided CD-ROM. When multiple accounts have been set up on a computer, log on with an account that has administrative rights before installing the software.

1 Turn the computer on.

Make sure no other software is running.

2 Place the CD-ROM into the CD/DVD drive on the computer.

The [PENTAX Software Installer] screen appears.

If the [PENTAX Software Installer] screen does not appear

- **For Windows**

- 1 Click [My Computer] from the Start menu.
- 2 Double-click the [CD/DVD drive (S-SW120)] icon.
- 3 Double-click the [Setup.exe] icon.

- **For Macintosh**

- 1 Double-click the CD/DVD (S-SW120) icon on the desktop.
- 2 Double-click the [PENTAX Installer] icon.

3 Click [SILKYPIX Developer Studio 3.0 for PENTAX].

For Macintosh, follow the instructions on the screen to perform subsequent steps.

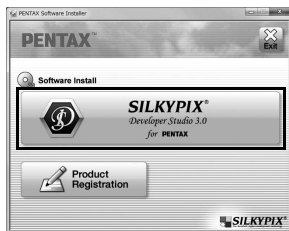

4 Select the desired language in the [Choose Setup Language] screen, and click [OK].

5 When the [InstallShield Wizard] screen appears in the selected language, click [Next].

Follow the instructions on the screen to perform subsequent steps.



Start SILKYPIX Developer Studio and see the help menu for details on using the software program.

Regarding Product Registration

To better serve you, please take a moment to register your software.

Click [Product Registration] on the screen in Step 3 on p.212.

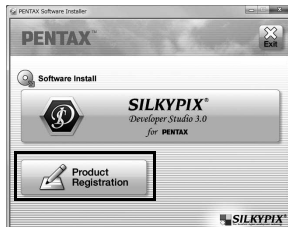

A world map for Internet Product Registration is displayed. If the computer is connected to the Internet, click the displayed country or area and then follow the instructions to register your software.

Note that you can only register online if your country or area is shown.

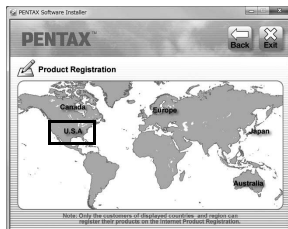

Memo

9 Using the Flash

This chapter provides details on the built-in flash and describes how to take pictures with an external flash.

Using the Built-in Flash	216
Using an External Flash (Optional)	220

Flash Characteristics in Each Exposure Mode



Using the Flash in Tv Mode

- When taking a moving subject, you can use the flash to change the blur effect.
- The aperture value automatically changes according to the ambient brightness.
- Any desired shutter speed of 1/180 sec. or slower can be set for taking a flash photograph.



Using the Flash in Av Mode

- You can set the desired aperture value to take a flash photograph when you want to change the depth of field or shoot a subject farther away.
- The shutter speed automatically changes with the ambient brightness.
- The shutter speed automatically changes over a range from 1/180 sec. to a slow shutter speed that reduces camera shake (the slowest shutter speed depends on the focal length of the lens in use).
The shutter speed is locked at 1/180 sec. when a lens other than a DA, DA L, D FA, FA J, FA or F lens is used.

Using the Slow-speed Sync Flash

You can use Slow-speed Sync in  (Night Scene Portrait) of **SCN** mode or **Tv** mode when shooting portraits with the sunset in the background. Both the portrait and the background are captured beautifully.  and  can be used in **P** or **Av** mode.



- Slow-speed Sync slows down the shutter speed. To avoid camera shake, either set [Shake Reduction] to  (On), or set it to  (Off) and use a tripod. Note that the picture will also blur if the subject moves.
- Slow-speed Sync can also be performed with an external flash.

Using the Trailing Curtain Sync Flash

Trailing Curtain Sync discharges a flash immediately before the shutter closes. When shooting moving objects with a slow shutter speed, Trailing Curtain Sync and Slow-speed Sync produce different effects depending on when the flash is discharged.

For example, when shooting a moving car with Trailing Curtain Sync, trailing light is captured while the shutter is open and the flash captures the car immediately before the shutter is closed. Therefore, the picture will include a sharp, well-lit car with trailing light behind it.

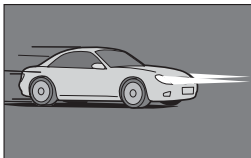

Slow-speed Sync
(Leading Curtain Sync)

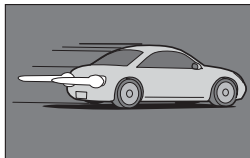

Trailing Curtain Sync



Trailing Curtain Sync slows down the shutter speed. To avoid camera shake, either set [Shake Reduction] to (On), or set it to (Off) and use a tripod.

Distance and Aperture when Using the Built-in Flash

Relationships among the guide number, aperture and distance must be considered when shooting with the flash to obtain a correct exposure. Calculate the shooting distance or aperture value in the following way, and adjust the shooting conditions if the flash output is not sufficient.

Sensitivity	Built-in Flash Guide Number	Sensitivity	Built-in Flash Guide Number
ISO 100	Approx. 12	ISO 1600	Approx. 48
ISO 200	Approx. 17	ISO 3200	Approx. 68
ISO 400	Approx. 24	ISO 6400	Approx. 96
ISO 800	Approx. 34	ISO 12800	Approx. 136

Calculating Shooting Distance from Aperture Value

The following equation calculates the effective distance of the flash for aperture values.

Maximum flash distance $L1 = \text{Guide number} \div \text{Aperture value}$

Minimum flash distance $L2 = \text{Maximum flash distance} \div 5^*$

* The value 5 used in the formula above is a fixed value which applies only when using the built-in flash alone.

Example:

When the sensitivity is ISO 200 and the aperture value is F5.6:

$$L1 = 17 \div 5.6 = \text{approx. } 3 \text{ (m)}$$

$$L2 = 3 \div 5 = \text{approx. } 0.6 \text{ (m)}$$

Therefore, the flash can be used in a range of about 0.6 m to 3 m. However, the built-in flash in this camera cannot be used when the distance is 0.7 m or less. When the flash is used at distances closer than 0.7 m, it causes vignetting in the picture corners, light is distributed unevenly and the picture may be overexposed.

Calculating Aperture Value from Shooting Distance

The following equation calculates the aperture value for shooting distances.

Aperture value $F = \text{Guide number} \div \text{Shooting distance}$

Example:

When the sensitivity is ISO 200 and the shooting distance is 4 m, the aperture value is:

$$F = 17 \div 4 = \text{approx. } 4.2$$

If the resulting number (4.2, in the above example) is not available as a lens aperture, a smaller number that is closest (4.0, in the above example) is generally used.

Lens Compatibility with the Built-in Flash

Depending on the lens used with this camera, even if a lens without a hood is attached, the use of the built-in flash may not be available or may be limited due to vignetting.

DA, DA L, D FA, FA J, and FA lenses not listed below can be used without problems.

* The following lenses were evaluated without a hood.

Unavailable due to vignetting

Lens Name
DA FISH-EYE 10-17mm F3.5-4.5ED (IF)
DA12-24mm F4ED AL
DA14mm F2.8ED (IF)
FA★300mm F2.8ED (IF)
FA★600mm F4ED (IF)
FA★250-600mm F5.6ED (IF)

Available with some restrictions

Lens Name	Restrictions
F FISH-EYE 17-28mm F3.5-4.5	Vignetting may occur if the focal length is less than 20 mm.
DA16-45mm F4ED AL	When the focal length is less than 28 mm, or when the focal length is 28 mm and the shooting distance is 1 m or less, vignetting may occur.
DA★16-50mm F2.8ED AL (IF) SDM	When the focal length is 35 mm or less or when the focal length is 50 mm and the shooting distance is less than 1.5 m, vignetting may occur.
DA17-70mm F4AL (IF) SDM	When the focal length is less than 24 mm or when the focal length is 35 mm and the shooting distance is 1 m or less, vignetting may occur.
DA18-250mm F3.5-6.3ED AL (IF)	Vignetting may occur if the focal length is less than 35 mm.
FA★28-70mm F2.8AL	Vignetting may occur if the focal length is 28 mm and the shooting distance is less than 1 m.
FA SOFT 28mm F2.8	Built-in flash always discharges fully.
FA SOFT 85mm F2.8	Built-in flash always discharges fully.

Using an External Flash (Optional)

Using an optional external flash AF540FGZ, AF360FGZ, AF200FG or AF160FC enables a variety of flash modes, such as P-TTL auto flash mode, depending on the external flash being used.

✓ : Available

× : Functions are unavailable.

Camera Function \ Flash	Built-in Flash	AF540FGZ AF360FGZ	AF200FG AF160FC
Red-eye reduction flash	✓	✓	✓
Auto flash discharge	✓	✓	✓
Automatically switching to the flash sync speed	✓	✓	✓
Aperture value is automatically set in P mode and Tv mode	✓	✓	✓
P-TTL auto flash	✓ ^{*1}	✓ ^{*1}	✓ ^{*1}
Slow-speed Sync	✓	✓	✓
Flash exposure compensation	✓	✓	✓
AF assist light of external flash	×	✓	×
Trailing Curtain Sync ^{*2}	✓	✓	×
High-speed sync	×	✓	×

*1 Available only when using a DA, DA L, D FA, FA J, FA, F or A lens.

*2 Shutter speed of 1/90 sec. or slower.



Flashes with reversed polarity (the center contact on the hot shoe is minus) cannot be used due to the risk of damaging the camera and/or flash.

Using the P-TTL Auto Flash

You can use the P-TTL auto flash with an AF540FGZ, AF360FGZ, AF200FG or AF160FC flash unit.

- 1 Remove the cover of the hot shoe, and attach the external flash.**
- 2 Turn on the camera and the external flash.**
- 3 Set the external flash mode to [P-TTL].**
- 4 Make sure that the external flash is fully charged, and then take a picture.**



- The P-TTL auto flash is only available with an AF540FGZ, AF360FGZ, AF200FG or AF160FC flash unit.
- For details such as operation method and effective distance, refer to the external flash manual.
- The flash does not discharge if the subject is bright enough when the flash mode is set to ⚡^{A} or $\text{⚡}^{\text{A}}_{\text{Ⓢ}}$. Therefore, these modes may not be suitable for daylight-sync shooting.
- Even if the ⚡UP / Ⓢ button is pressed, the built-in flash does not pop up when an accessory is attached to the hot shoe of the camera.

Using the High-speed Sync Flash

With an AF540FGZ or AF360FGZ flash unit, you can discharge a flash to take a picture at a shutter speed faster than 1/180 second.

- 1** Remove the cover of the hot shoe, and attach the external flash.
- 2** Set the mode dial to **Tv** or **M**.
- 3** Turn on the camera and the external flash.
- 4** Set the external flash sync mode to **HS** \downarrow (high-speed sync).
- 5** Make sure that the external flash is fully charged, and then take a picture.



- High-speed sync is available only when the shutter speed is set faster than 1/180 sec.
- High-speed sync is not available in **B** mode.
- High-speed sync is not available with the built-in flash.

Connecting an External Flash with an Extension Cord

When using an external flash away from the camera, attach the Hot Shoe Adapter F_G (optional) to the camera hot shoe and an Off-Camera Shoe Adapter F (optional) to the bottom of the external flash, and then connect these with the Extension Cord F5P (optional) as shown in the illustration below. The Off-Camera Shoe Adapter F can be mounted to your tripod using the tripod screw.

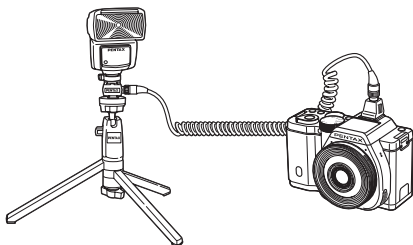

- Do not combine with accessories that have a different number of contacts, such as a Hot Shoe Grip, as a malfunction may occur.
- Combining with flashes from other manufacturers may cause equipment breakdown. We recommend using the AF540FGZ, AF360FGZ or AF200FG.

Memo

10 Appendix

Default Settings	226
Functions Available with Various Lens Combinations	232
Cleaning the CMOS Sensor	237
Optional Accessories	240
Error Messages	245
Troubleshooting	247
Main Specifications	250
Index	256
WARRANTY POLICY	263

Default Settings

The table below shows the factory default settings.

The functions set in Memory (p.195) are saved even when the camera is turned off.

Reset Setting

Yes: The setting returns to the default setting with the reset function (p.196).





No: The setting is saved even after reset.

Direct Keys

Item	Default Setting	Reset Setting	Page
Sensitivity	ISO AUTO (ISO 100 to 3200)	Yes	p.79
White Balance	AWB (Auto)	Yes	p.130
Flash Mode	Depends on capture mode	Yes	p.59
Drive Mode	<input type="checkbox"/> (Single Frame Shooting)	Yes	p.85 p.102 p.104 p.106



[Rec. Mode] Menu

Item		Default Setting	Reset Setting	Page
Custom Image		Bright	Yes	p.140
Digital Filter		No Filter	Yes	p.144
HDR Capture	HDR Capture	Off	Yes	p.135
	Auto Align	<input checked="" type="checkbox"/> (On)	Yes	
Image Capture Settings	Aspect Ratio	3:2	Yes	p.126
	File Format	JPEG	Yes	p.127
	JPEG Recorded Pixels	16M (4928×3264)	Yes	p.128
	JPEG Quality	★★★ (Best)	Yes	p.129
	Color Space	sRGB	Yes	p.129
AE Metering		 (Multi-segment)	Yes	p.88

Item		Default Setting	Reset Setting	Page
AF/MF Settings	Autofocus Method	 (Face Detection)	Yes	p.93
	AF Autozoom	<input type="checkbox"/> (Off)	Yes	p.95
	AF Assist Light	<input checked="" type="checkbox"/> (On)	Yes	p.92
	Focus Peaking	Off	Yes	p.98
Lens Correction	Distortion Correction	Off	Yes	p.138
	Lat-Chromatic-Ab Adj	On	Yes	
Multi-exposure	Number of Shots	2 times	Yes	p.111
	Auto EV Adjustment	<input type="checkbox"/> (Off)	Yes	
Interval Shooting	Interval	00:00'01"	Yes	p.108
	Number of Shots	2 images	Yes	
	Start Interval	Now	Yes	
	Start Time	12:00 AM/00:00	Yes	
D-Range Setting	Highlight Correction	Auto	Yes	p.133
	Shadow Correction	Auto	Yes	p.134
High-ISO NR		Auto	Yes	p.89
Slow Shutter Speed NR		Auto	Yes	p.91
Shake Reduction		 (On)	Yes	p.100
Input Focal Length		35 mm	Yes	p.234
Live View	Show Grid	 (Off)	Yes	p.190
	Histogram Display	<input type="checkbox"/> (Off)	Yes	
	Bright/Dark Area	<input type="checkbox"/> (Off)	Yes	
Instant Review	Display Time	1 sec.	Yes	p.191
	Enlarge Instant Review	<input checked="" type="checkbox"/> (On)	Yes	
	Save RAW Data	<input checked="" type="checkbox"/> (On)	Yes	
	Histogram Display	<input type="checkbox"/> (Off)	Yes	
	Bright/Dark Area	<input type="checkbox"/> (Off)	Yes	
Button Customization	 (Green)	Green Button	Yes	p.147
	 (Red)	Movie Recording	Yes	
	AF/AE-L (still picture)	Enable AF1	Yes	p.152
	AF/AE-L (movie)	Enable AF1	Yes	
	Action in M/TA v Mode	P LINE	Yes	p.151
	E-dial in Program	P SHIFT	Yes	p.150

Item		Default Setting	Reset Setting	Page
Button Customization	One Push File Format	Cancel after 1 shot	<input checked="" type="checkbox"/> (On)	p.149
		JPEG/RAW/RAW+ File Format	All RAW+	
Memory	Digital Filter, HDR Capture		<input type="checkbox"/> (Off)	p.195
	Other than the above functions		<input checked="" type="checkbox"/> (On)	
GPS	Calibration		—	p.244
	GPS Time Sync		<input checked="" type="checkbox"/> (On)	

[Movie] Menu

Item		Default Setting	Reset Setting	Page
Exposure Setting		P	Yes	p.113
Movie Capture Settings	Recorded Pixels	 (1920×1080, 16:9)	Yes	
	Framerate	30 fps	Yes	
	Quality Level	★★★	Yes	
Recording Sound Level	Internal Microphone	3	Yes	
	External Microphone	5	Yes	
Movie SR		 (On)	Yes	p.119
Interval Movie	Interval	1 sec.	Yes	
	Recording Time	00:00'04"	Yes	
	Start Interval	Now	Yes	
	Start Time	12:00 AM/00:00	Yes	

Playback Mode Palette

Item	Default Setting	Reset Setting	Page
Image Rotation	—	—	p.162
Digital Filter	Monochrome	Yes	p.167
Resize	Maximum size according to the setting	—	p.165
Cropping	Maximum size according to the setting	—	p.166
Index	—	—	p.172
Protect	—	No	p.200
Slideshow	—	Yes	p.161
Save Cross Processing	—	Yes	p.143
RAW Development	Recorded Pixels: 16M Quality Level: ★★★	Yes	p.174
Movie Editing	—	—	p.123
DPOF	—	No	p.204

[▶ Playback] Menu

Item	Default Setting	Reset Setting	Page
Slideshow	Interval	3 sec.	p.160
	Screen Effect	OFF	
	Repeat Playback	<input type="checkbox"/> (Off)	
Quick Zoom	Off	Yes	p.156
Bright/Dark Area	<input type="checkbox"/> (Off)	Yes	
Auto Image Rotation	<input checked="" type="checkbox"/> (On)	Yes	
Delete All Images	—	—	p.164

[ Set-up] Menu

Item		Default Setting	Reset Setting	Page
Language/言語		English	No	p.190
Date Adjustment		01/01/2012	No	p.187
World Time	World Time setting	 (Hometown)	Yes	p.187
	Hometown (City)	According to initial setting	No	
	Hometown (DST)	According to initial setting	No	
	Destination (City)	Same as Hometown	No	
	Destination (DST)	Same as Hometown	No	
Sound Effects	Volume	3	Yes	p.186
	Setting	All <input checked="" type="checkbox"/> (On)		
LCD Display	Startup Screen	<input checked="" type="checkbox"/> (On)	Yes	p.192
	Guide Display	<input checked="" type="checkbox"/> (On)	Yes	
LCD Display Settings		±0	Yes	p.192
Flicker Reduction		50 Hz	No	p.30
Interface Options	Video Out	According to initial setting	No	p.179
	HDMI Out	Auto	Yes	p.180
	USB Connection	MSC	Yes	p.209
Folder Name		Date	Yes	p.201
Create New Folder		—	—	p.201
Copyright Information	Embed Copyright Data	<input type="checkbox"/> (Off)	Yes	p.202
	Photographer	—	No	
	Copyright Holder	—	No	
Power Saving		<input checked="" type="checkbox"/> (On)	Yes	p.194
Auto Power Off		1 min.	Yes	
Reset		—	—	p.196
Pixel Mapping		—	—	p.194
Dust Removal	Dust Removal	—	—	p.237
	Startup Action/ Shutdown Action	<input type="checkbox"/> (Off)	Yes	
Sensor Cleaning		—	—	p.238
Format		—	—	p.199
Firmware Info/Options		—	—	p.197

[C Custom Setting] Menu

Item	Default Setting	Reset Setting	Page
1. EV Steps	1/3 EV Steps	Yes	p.84
2. Sensitivity Steps	1 EV Step	Yes	p.80
3. Expanded Sensitivity	Off	Yes	p.80
4. AE-L with AF Locked	Off	Yes	p.87
5. Link AE to AF Point	Off	Yes	p.88
6. Auto Bracketing Order	0 - +	Yes	p.85
7. Bulb (B) Mode Options	Mode1	Yes	p.83
8. WB When Using Flash	Auto White Balance	Yes	p.131
9. AWB in Tungsten Light	Subtle Correction	Yes	—
10. AF Release Options	Focus-priority	Yes	p.93
11. AF with Remote Control	Off	Yes	p.105
12. Release While Charging	Off	Yes	p.63
13. Save Rotation Info	On	Yes	p.156
14. Save Menu Location	Reset Menu Location	Yes	p.193
15. Shake Reduction Options	Mode1	Yes	p.101
16. Using Aperture Ring	Disable	Yes	p.235
Reset Custom Functions	—	—	p.197

Functions Available with Various Lens Combinations

All camera capture modes are available when using DA/DA L/FA J or lenses with an aperture **A** position set to the **A** position. When they are used in a position other than **A**, or other lenses are used, the following restrictions apply.

- ✓ : Functions are available when the aperture ring is set to the **A** position.
- # : Some functions are restricted.
- × : Functions are unavailable.

Function	Lens [Mount type]	DA DA L D FA	FA J FA *6	F *6	A	M P
		[KAF] [KAF2] [KAF3]	[KAF] [KAF2]	[KAF]	[KA]	[K]
Autofocus (Lens only) (With AF adapter 1.7x) *1		✓ —	✓ —	✓ —	— #	— #
Manual focus (With the focus indicator)*2		✓	✓	✓	✓	✓
Quick-shift focus		#*5	×	×	×	×
AE Metering  (Multi-segment)		✓	✓	✓	✓	×
P mode		✓	✓	✓	✓	#*8
Tv mode		✓	✓	✓	✓	#*8
Av mode		✓	✓	✓	✓	#*8
M mode		✓	✓	✓	✓	#
P-TTL auto flash *3		✓	✓	✓	✓	×
Power Zoom		—	×	—	—	—
Automatically obtaining the lens focal length information		✓	✓	✓	×	×
Lens Correction function *4		✓	×*7	×	×	×

*1 Lenses with a maximum aperture of F2.8 or faster. Only available at the **A** position.

*2 Lenses with a maximum aperture of F5.6 or faster.

*3 When using the built-in flash, AF540FGZ, AF360FGZ, AF200FG or AF160FC.

- *4 Aberration correction is available using the Lens Correction function of the [📷 Rec. Mode 1] menu. The [Distortion Correction] setting is disabled when a DA FISH-EYE 10-17mm lens is used.
- *5 Only available with compatible lenses.
- *6 To use an FA lens, F SOFT 85 mm F2.8 lens or FA SOFT 28 mm F2.8 lens, set [16. Using Aperture Ring] in the [C Custom Setting 3] menu to [Enable]. Pictures can be taken with the aperture you set, but only within manual aperture range.
- *7 Only available with compatible lenses (FA 31mm F1.8 Limited, FA 43mm F1.9 Limited, or FA 77mm F1.8 Limited).
- *8 **Av** Automatic Exposure with the aperture open. (The aperture ring has no effect on the actual aperture value.)

Lens names and mount names

DA lenses with an ultrasonic motor and FA zoom lenses with power zoom use the K_{AF2} mount. DA lenses with an ultrasonic motor and no AF coupler use the K_{AF3} mount.

FA single focal length lenses (non-zoom lenses), DA or DA L lenses without an ultrasonic motor, and D FA, FA J and F lenses use the K_{AF} mount.

Refer to respective lens manuals for details. Note that this camera is not equipped with a power zoom function.

Lenses and accessories that cannot be used with this camera

When the aperture ring is set to a position other than **A** (Auto) or a lens without an **A** position or accessories such as an auto extension tube or auto bellows are used, the camera will not operate unless [16. Using Aperture Ring] is set to [Enable] in the [C Custom Setting 3] menu. Refer to “Using the Aperture Ring” (p.235) for details.

Lens and Built-in Flash

The built-in flash cannot be regulated and fully discharges when A lenses not set to the **A** (Auto) position, pre A lenses or soft focus lenses are used. Note that the built-in flash cannot be used as an auto flash.

Setting the Focal Length

The Shake Reduction function operates by obtaining the lens information such as focal length. Set the focal length when using a lens for which focal length information cannot be automatically obtained.

1 Make sure that [Shake Reduction] is set to (On), and turn the camera off.

Refer to "Taking Pictures Using the Shake Reduction Function" (p.100) for details.

2 Attach a lens, and turn the camera on.

The [Input Focal Length] screen appears.

3 Use the e-dial to set the focal length.

Select from the following focal length values. (The default setting is 35 mm.)

8	10	12	15	18	20	24	28	30	35
40	45	50	55	65	70	75	85	100	120
135	150	180	200	250	300	350	400	450	500
550	600	700	800						

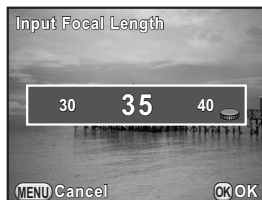

- If the focal length for your lens is not listed above, select the value closest to the actual focal length (example: [18] for 17 mm and [100] for 105 mm).
- When using a zoom lens, select the actual focal length at the zoom setting being used in the same manner.

4 Press the OK button.

The camera is ready to take a picture.



- To change the focal length setting, use [Input Focal Length] in the [📷 Rec. Mode 2] menu.
- When using a lens without an **A** position on the aperture or with the aperture set to a position other than **A**, set [16. Using Aperture Ring] in the [C Custom Setting 3] menu to [Enable]. (p.235)

Using the Aperture Ring

The shutter can be released even if the aperture ring of the D FA, FA, F or A lens is not set to the **A** (Auto) position or a lens without an **A** position is attached.

1 Select [Enable] in [16. Using Aperture Ring] of the [C Custom Setting 3] menu.

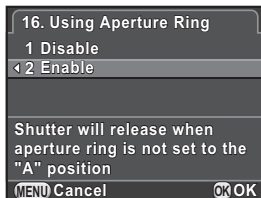

The following restrictions apply depending on the lens being used.

Lens Used	Capture Mode	Restriction
D FA, FA, F, A, M (lens only or with auto diaphragm accessories such as auto extension tube K)	Av	The aperture remains open regardless of the aperture ring position. The shutter speed changes in relation to the open aperture but an exposure error may occur. [F--] appears for the aperture indicator.
D FA, FA, F, A, M, S (with diaphragm accessories such as extension tube K)	Av	Pictures can be taken with a specified aperture value but an exposure error may occur. [F--] appears for the aperture indicator.
Manual diaphragm lens such as reflex lens (lens only)	Av	
FA, F SOFT 85mm, FA SOFT 28mm (lens only)	Av	Pictures can be taken with a specified aperture value in the manual aperture range. [F--] appears for the aperture indicator. When the depth of field is checked (Optical Preview), the exposure can be checked.
All lenses	M	Pictures can be taken with a set aperture value and shutter speed. [F--] appears for the aperture indicator. When the depth of field is checked (Optical Preview), the exposure can be checked.



If the aperture is set to a position other than **A**, the camera operates in **Av** mode regardless of the mode dial setting except when set to **M** or  mode.

If the CMOS sensor becomes dirty or dusty, shadows may appear in the image in certain situations such as when shooting against a white background. This indicates that the CMOS sensor must be cleaned.

Removing Dust by Shaking the CMOS Sensor (Dust Removal)

Shaking the CMOS sensor removes dust that has collected.

- 1** Select **[Dust Removal]** in the **[ Set-up 3]** menu, and press the four-way controller (**▶**).

The [Dust Removal] screen appears.

- 2** Press the **OK** button.

The Dust Removal function is activated by shaking the CMOS sensor.

To activate the Dust Removal function every time the camera is turned on and off, set [Startup Action] and [Shutdown Action] to .

When Dust Removal is completed, the camera returns to the **[ Set-up 3]** menu.

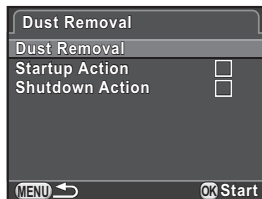

Use a brush-less blower to remove dirt and dust from the CMOS sensor. Using a blower with a brush may scratch the CMOS sensor. Do not wipe the CMOS sensor with a cloth.

Removing Dust with a Blower

Keep the shutter open when cleaning the CMOS sensor with a blower. Please contact a PENTAX Service Center for professional cleaning as the CMOS sensor is a precision part. Cleaning services involve a fee.



- The self-timer lamp blinks while cleaning the sensor.
- This camera features a CMOS sensor corresponding to the Shake Reduction system, and it may generate a vibration sound while cleaning the CMOS sensor. It is not a malfunction.



- Do not use a spray type blower.
- Do not clean the sensor when the mode dial is set to **B**.
- To prevent dirt and dust from accumulating on the CMOS sensor, keep the body mount cover on the camera when a lens is not attached.
- When the battery level is low, [Not enough battery power remaining to clean sensor] is displayed on the monitor.
- It is recommended to use the AC Adapter kit K-AC1202 (optional) when cleaning the sensor. If you do not use the AC adapter kit, install the battery with ample power remaining. If the battery capacity becomes low during cleaning, the self-timer lamp blinks rapidly. In this case, stop cleaning immediately.
- Do not put the tip of the blower inside the lens mount area. If the power is turned off, this may cause damage to the shutter and CMOS sensor.

1 Turn the camera off, and remove the lens.

2 Turn the camera on.

3 Select [Sensor Cleaning] in the [↖ Set-up 3] menu, and press the four-way controller (▶).

The [Sensor Cleaning] screen appears.

- 4 Press the four-way controller (▲) to select [Start cleaning], and press the OK button.**

The shutter is locked open.

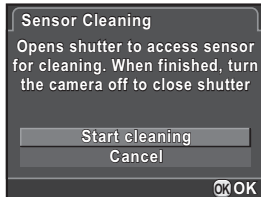

- 5 Clean the CMOS sensor.**

Use a brush-less blower to remove dirt and dust from the CMOS sensor. Using a blower with a brush may scratch the CMOS sensor. Do not wipe the CMOS sensor with a cloth.

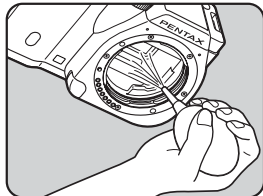

- 6 Turn the camera off.**

The shutter is closed.

- 7 Attach the lens or body mount cover.**

A number of dedicated accessories are available for this camera. Contact a PENTAX Service Center for details regarding accessories. Products marked with an asterisk (*) are the same as those supplied with the camera.

Power Supply Accessories

Battery Charger kit K-BC90 (*)

(Kit includes Battery Charger D-BC90 and AC plug cord.)

Rechargeable Lithium-ion Battery D-LI90 (*)

AC Adapter kit K-AC1202

(Kit includes AC Adapter D-AC120, DC Coupler D-DC120 and AC plug cord.)

Lets you power your camera from an AC outlet.



The AC adapter and battery charger are both only sold as a kit.

Flash Accessories

Auto Flash AF540FGZ/Auto Flash AF360FGZ

The AF540FGZ and AF360FGZ are P-TTL auto flash units with a maximum guide number of about 54 and about 36 (ISO 100/m), respectively.



AF540FGZ



AF360FGZ

Auto Flash AF200FG

The AF200FG is a P-TTL auto flash unit with a maximum guide number of about 20 (ISO 100/m).



AF200FG

Auto Macro Flash AF160FC

The AF160FC is a flash system especially designed for macro photography to take close, shadowless pictures of small objects. It is compatible with existing TTL auto flash functions and it can be used with a wide range of PENTAX cameras by using provided adapter rings.



AF160FC

Hot Shoe Adapter F_G**Extension Cord F5P**Hot Shoe Adapter F_G**Off-camera Shoe Adapter F**

Use the adapters and cords to use the external flash away from the camera.



Off-camera Shoe Adapter F

Off-camera Shoe Clip CL-10

This large clip is used for setting the AF540FGZ or AF360FGZ on a desk or table.



Off-camera Shoe Clip CL-10

Remote Control

Used in Remote Control shooting.

Operating range of the remote control

From the front of the camera: approx. 4 m

Remote Control F**Remote Control Waterproof O-RC1**

GPS Unit O-GPS1

Attach this unit to the camera's hot shoe to record information such as the latitude, longitude, altitude, direction, and Coordinated Universal Time (UTC). (p.244)



Camera Case/Strap

Camera Case O-CC120

Camera Strap O-ST120 (*)

Hand Strap O-ST991

Free Length Strap O-ST842

Others

Body Mount Cap K

Hot Shoe Cover Fk (*)

USB Cable I-USB7 (*)

Video Cable I-VC28

AV Cable I-AVC7

Using the GPS Unit

The following functions are available when the GPS Unit O-GPS1 is attached to the this camera.

Electronic Compass	Displays the latitude, longitude, altitude of the current location, and lens direction in standby mode.	
GPS Time Sync	Automatically adjusts the camera's date and time settings using information acquired from GPS satellites.	



- Refer to the manual of the GPS unit for details on how to attach the unit and information on the unit's functions.
- To display the electronic compass, press the **INFO** button twice and select [Electronic Compass] in the screen to select the type of information displayed. The setting returns to [Standard Information Display] when the shutter release button is pressed halfway. Press the **INFO** button and reselect the setting to display it again. (p.22)



Simple Navigation and ASTROTRACER cannot be used with the **JK-01**.























Error Message	Description
Memory card full	The SD Memory Card is full and no more images can be saved. Insert a new SD Memory Card or delete unwanted files. (p.45, p.163) You may be able to save more images if you change the image capture settings. (p.126)
No image	There are no images that can be played back on the SD Memory Card.
This image cannot be displayed	You are trying to play back an image in a format not supported by this camera. You may be able to play it back on another brand of camera or a computer.
No card in the camera	There is no SD Memory Card inserted in the camera. (p.45)
Memory card error	There is a problem with the SD Memory Card and image capture and playback are not possible. It may be viewable on a computer but not with this camera.
Card is not formatted	The SD Memory Card you have inserted is unformatted or has been formatted on another device and is not compatible with this camera. Use the card after formatting it with this camera. (p.199)
Card is locked	The write-protect switch on an SD Memory Card you have inserted is locked. Unlock the SD Memory Card.
This image cannot be magnified	You are trying to magnify an image that cannot be magnified.
This image is protected	You are trying to delete an image that is protected. Remove protection from the image. (p.200)
Not enough battery power remaining to activate Pixel Mapping	Appears during Pixel Mapping if the battery level is insufficient. Install a fully charged battery, or use the AC Adapter kit K-AC1202 (optional). (p.42)
Not enough battery power remaining to clean sensor	Appears during sensor cleaning if the battery level is insufficient. Install a fully charged battery, or use the AC Adapter kit K-AC1202 (optional). (p.42)



Error Message	Description
Not enough battery power remaining to update the firmware	Appears when trying to update the firmware if the battery level is insufficient. Install a fully charged battery, or use the AC Adapter kit K-AC1202 (optional). (p.42)
Unable to update firmware. There is a problem with the firmware update file	Unable to update the firmware. The update file is damaged. Try downloading the update file again. (p.197)
Image folder cannot be created	The maximum folder number (999) and file number (9999) are being used, and no more images can be saved. Insert a new SD Memory Card or format the card. (p.199)
Unable to store image	The image could not be saved because of an SD Memory Card error.
Settings not stored	The DPOF settings could not be saved because the SD Memory Card is full. Delete unwanted images and perform the DPOF setting again. (p.163)
The operation could not be completed correctly	The camera was unable to measure the manual white balance (p.132) or use HDR Capture (p.135). Try the operation again.
No more images can be selected	You cannot select 100 or more images at a time for Index (p.172) and Select & Delete (p.163).
No image can be processed	There are no images that can be processed using the Digital Filter (p.167) or RAW Development (p.174) function.
This image cannot be processed	Appears when you try to perform Resize (p.165), Cropping (p.166), Digital Filter (p.167), or RAW Development (p.174) for images captured with other cameras, or when you try to perform Resize or Cropping for minimum file size images.
The camera failed to create an image	The creation of an index print image failed. (p.172)
This function is not available in the current mode	You are trying to set a function that is not available in AUTO , SCN or  mode.
The camera will turn off to prevent damage from overheating	The camera will turn off because its internal temperature gets too hot. Leave the camera turned off and give it enough time to cool down. Turn it on again after a while.

In rare cases, the camera may not operate correctly due to static electricity. This can be remedied by taking the battery out and putting it back in again. After these procedures are done, if the camera operates correctly, it does not require any repairs.

We recommend checking the following items before contacting a service center.

Problem	Cause	Remedy
The camera does not turn on	Battery is not installed	Check if a battery is installed. If not, install a fully charged battery.
	The battery power is low	Install a fully charged battery, or use the AC Adapter kit K-AC1202 (optional). (p.42)
The shutter cannot be released	The built-in flash is charging	⚡ blinks red while the built-in flash is charging. Wait until charging is finished.
	There is no available space on the SD Memory Card	Insert an SD Memory Card with available space or delete unwanted images. (p.45, p.163)
	Recording	Wait until recording is finished.
	The lens aperture ring is set to a position other than A	Set the lens aperture ring to the A position or select [Enable] in [16. Using Aperture Ring] of the [C Custom Setting 3] menu. (p.235)
Autofocus does not work	The subject is difficult to focus on	Autofocus cannot work well for subjects that have low contrast (the sky, white walls, etc.), dark colors, intricate designs, rapidly-moving objects or scenery shot through a window or a net-like pattern. Lock focus on another object located at the same distance as your subject, then aim at the target and press the shutter release button fully. Alternatively, use manual focus. (p.98)

Problem	Cause	Remedy
Autofocus does not work	The subject is not in the AF area	Position the subject in the AF area on the monitor. If the subject is outside the AF area, aim the camera at the subject and lock the focus, then compose a picture and press the shutter release button fully. (p.97)
	The subject is too close	Move away from the subject and take a picture.
	The focus mode is set to MF	Set the focus mode switch to AF . (p.92)
The AE Lock function does not operate	B mode is set	AE Lock is not available in B mode.
The built-in flash does not discharge	When the flash mode is set to  or  , the flash will not discharge if the subject is bright	Set the flash mode to  (Manual Flash Discharge) or  (Manual Flash+Red-eye Reduction). (p.59)
	 mode is set	Set the mode dial to any mode other than  (Flash Off).
	 ,  ,  ,  ,  ,  , or  of SCN mode is set	Set SCN mode to any mode other than  (Sunset),  (Blue Sky),  (Night Scene),  (Night Scene HDR),  (Backlight Silhouette),  (Candlelight),  (Stage Lighting) or  (Museum). (p.77)
The power zoom system does not work	The camera does not have a power zoom function	Use manual zoom.
The USB connection with a computer does not work properly	The USB connection mode is set to [PTP]	Set [USB Connection] to [MSC] in [Interface Options] of the [ Set-up 2] menu. (p.209)

Problem	Cause	Remedy
Shake Reduction does not work	The Shake Reduction function is off	Set [Shake Reduction] to  (On). (p.100)
	The focal length is not set	If a lens for which the focal length information cannot be obtained is used, set the focal length in the [Input Focal Length] screen. (p.234)
	Shutter speed is too low for the Shake Reduction function to be effective when panning or shooting night scenes, etc.	Set [Shake Reduction] to  (Off) and use a tripod.
	The subject is too close	Move away from the subject, or set [Shake Reduction] to  and use a tripod.

Model Description

Type	Lens-interchangeable SL digital camera
Lens Mount	PENTAX KAF2 bayonet mount (AF coupler, lens information contacts, K-mount with power contacts)
Compatible Lens	KAF3, KAF2 (power zoom not compatible), KAF, KA mount lenses

Image Capture Unit

Image Sensor	Primary color filter, CMOS, Size: 23.7 x 15.7 (mm)
Effective Pixels	Approx. 16.28 megapixels
Total Pixels	Approx. 16.49 megapixels
Dust Removal	SP coating and CMOS sensor operations
Sensitivity (Standard Output)	ISO AUTO: 100 to 12800 (EV steps can be set to 1 EV, 1/2 EV, or 1/3 EV), expandable from ISO 100 to ISO 25600.
Image Stabilizer	Sensor shift Shake Reduction

File Formats

File Format	RAW (DNG), JPEG (Exif 2.3), DCF2.0 compliant
Recorded Pixels	JPEG: 3:2 16M (4928x3264) 12M (4224x2816) 8M (3456x2304) 5M (2688x1792) 4:3 14M (4352x3264) 11M (3840x2880) 7M (3072x2304) 4M (2304x1728) 16:9 13M (4928x2776) 10M (4224x2376) 6M (3456x1944) 4M (2688x1512) 1:1 10M (3264x3264) 8M (2880x2880) 5M (2304x2304) 3M (1728x1728) RAW: 3:2 16M (4928x3264)
Quality Level	RAW: DNG (12 bit) JPEG: ★★★ (Best), ★★ (Better), ★ (Good) RAW and JPEG simultaneously recordable
Color Space	sRGB, AdobeRGB
Storage Medium	SD, SDHC, and SDXC Memory Cards
Storage Folder	Date (100_1018, 100_1019...)/ PENTX (100PENTX, 101PENTX...)

LCD Monitor

Type	TFT color LCD monitor, wide angle viewing
Size	3.0 inches
Dots	Approx. 921,000 dots
Adjustment	Brightness and colors adjustable
Display	Field of view: approx. 100%, Grid display (4 × 4 Grid, Golden Section, Scale), Bright/dark area warning, Histogram

White Balance

Auto	TTL by CMOS image sensor
Preset	Daylight, Shade, Cloudy, Fluorescent Light (D : Daylight Color, N : Daylight White, W : Cool White, L : Warm White), Tungsten, Flash, CTE , Manual
Manual	Configuration on monitor
Fine Adjustment	Adjustable ±7 steps on A-B axis and G-M axis

Focusing Mechanism

Type	Contrast detection AF
Brightness Range	EV 1 to 18 (ISO 100 50mm, F 1.4 lens)
Focus Mode	Can be switched between AF and MF modes.
Autofocus Method	Face Detection, Tracking, Select, Spot
AF Assist Light	Dedicated LED AF assist light
Focus Assist	AF Autozoom (Off/×2/×4/×6), Focus Peaking When set to MF , an image can be magnified by pressing the OK button.

Metering

Type	TTL image sensor metering, multi-segment metering, center-weighted metering, and spot metering
Metering Range	EV -1 to 21 (ISO 100 50mm, F 1.4 lens)
Exposure Modes	Auto Picture modes: automatically selects from Standard, Portrait, Landscape, Macro, Moving Object, Night Scene Portrait, Night Scene, Blue Sky, Forest Scene modes: Portrait, Landscape, Macro, Moving Object, Night Scene Portrait, Sunset, Blue Sky, Forest, Night Scene, Night Scene HDR, Night Snap, Food, Pet, Kids, Surf & Snow, Backlight Silhouette, Candlelight, Stage Lighting, Museum Program, Shutter Priority, Aperture Priority, Manual, Bulb, HDR (can be switched between ±1EV, ±2EV and ±3EV) * Fixed to JPEG in Night Scene HDR and Night Scene modes.
EV Compensation	±3 EV
AE Lock	Can be assigned to the AF/AE-L button from the menu.
Shutter	Auto: 1/4000 to 30 seconds, Manual: 1/4000 to 30 seconds, Bulb

Drive Modes

Mode Selection	Single frame, Continuous (Hi, Lo), Self-timer (12 sec., 2 sec.), Remote Control (immediately, 3 sec.), Auto Bracketing (3 frames)
Continuous Shooting	Approx. 6 fps (JPEG/Hi) Approx. 3 fps (JPEG/Lo)

Flash

Type	Built-in retractable P-TTL auto pop-up flash Guide number: approx. 12 (ISO100/m) Angle of view coverage: equivalent to 28 mm in 35 mm format
Flash Modes	P-TTL, Red-eye Reduction, Slow-speed Sync, Trailing Curtain Sync; High-speed sync is also available with PENTAX dedicated external flash.
Sync Speed	1/180 sec.
Flash Exposure Compensation	-2.0 to +1.0 EV

Capture Functions

Custom Image	Bright, Natural, Portrait, Landscape, Vibrant, Radiant, Muted, Bleach Bypass, Reversal Film, Monochrome, Cross Processing
Noise Reduction	High-ISO NR, Slow Shutter Speed NR
Dynamic Range Setting	Highlight Correction, Shadow Correction
Lens Correction	Distortion Correction, Lateral Chromatic Aberration Correction
Digital Filter	Extract Color, Toy Camera, Retro, High Contrast, Shading, Invert Color, Color
HDR Capture	Auto, HDR 1, HDR 2, HDR 3, Auto Align (automatic composition correction)
Multi-exposure	Number of shots: 2-9, Exposure adjusted automatically.
Interval Shooting	Shooting interval: 1 sec. to 24 hr.; Start Interval setting: immediately, from the set time; Number of shots: up to 999 images

Movie

File Format	MPEG-4 AVC/H.264
Recorded Pixels	Full HD (1920×1080, 16:9 , 30 fps/25 fps/24 fps), HD (1280×720, 16:9 , 60 fps/50 fps/30 fps/25 fps/24 fps), VGA (640×480, 4:3 , 30 fps/25 fps/24 fps)
Quality Level	★★★ (Best), ★★ (Better), ★ (Good)
Sound	Built-in stereo microphone, external stereo microphone terminal, Recording Sound Level
Recording Time	Up to 25 minutes; automatically stops recording if the internal temperature of the camera becomes high.
Custom Image	Bright, Natural, Portrait, Landscape, Vibrant, Radiant, Muted, Bleach Bypass, Reversal Film, Monochrome, Cross Processing
Digital Filter	Extract Color, Toy Camera, Retro, High Contrast, Invert Color, Color

Interval Movie	Recording interval: 1 sec., 5 sec., 10 sec., 30 sec., 1 min., 5 min., 10 min., 30 min., 1 hr.; Recording time: 4 sec. to 99 hr.; Start Interval setting: immediately, from the set time *The file format is Motion JPEG (AVI).
----------------	---

Playback Functions

Playback View	Single frame, multi-image display (4, 9, 16, 36, and 81 segmentation), display magnification (up to 16 \times , scrolling and quick magnification available), image rotation, histogram display (Y histogram, RGB histogram), bright/dark area warning, auto image rotation, detailed information display, copyright information display (photographer, copyright holder), GPS data (latitude, longitude, altitude, direction, Coordinated Universal Time (UTC)), folder display, calendar filmstrip display, slideshow
Delete	Delete single image, delete all images, select & delete, delete folder, delete instant review image
Digital Filter	Monochrome, Extract Color, Toy Camera, Retro, High Contrast, Shading, Invert Color, Color, Tone Expansion, Sketch Filter, Water Color, Pastel, Posterization, Miniature, Soft, Starburst, Fish-eye, Slim, Base Parameter Adj
RAW Development	File Format (JPEG), Image Capture Settings (Aspect Ratio, Recorded Pixels, Quality Level, Color Space), Distortion Correction, Lat-Chromatic-Ab Adj, Custom Image, White Balance, Sensitivity, High-ISO NR, Shadow Correction
Edit	Resize, Cropping (aspect ratio can be changed and tilt correction is available), Index, Movie Edit (divide or delete selected frames), Capturing a JPEG still picture from a movie, Saving the RAW file data in the buffer memory

Customization

Custom Functions	16 items
Mode Memory	11 items
Button/Dial Customization	<ul style="list-style-type: none"> ⦿ (G) button: Green Button, One Push File Format, Preview, Focus Peaking, Custom Image, Digital Filter ⦿ (R) button: Movie Recording, One Push File Format, Preview, Focus Peaking, Custom Image, Digital Filter AF/AE-L button: Enable AF1, Enable AF2, Cancel AF, AE Lock
World Time	World Time settings for 75 cities (28 time zones)
Copyright Information	Names of "Photographer" and "Copyright Holder" are embedded to the image file.

Power Supply

Battery Type	Rechargeable lithium-ion battery D-LI90
AC Adapter	AC Adapter kit K-AC1202 (optional)
Battery Life	Number of recordable images (with 50% flash usage): approx. 500 images, (without flash usage): approx. 540 images Playback time: approx. 320 minutes * Tested in compliance with CIPA standard. Actual results may vary depending on the shooting conditions/ circumstances.

Interfaces

Connection Port	USB 2.0 (high-speed compatible)/AV output terminal, HDMI output terminal (Type C), stereo microphone input terminal
USB Connection	MSC/PTP
Video Output Format	NTSC/PAL

Dimensions and Weight

Dimensions	Approx. 121 mm (W) × 79 mm (H) × 59 mm (D) (excluding the operation parts and protrusion)
Weight	Approx. 560 g (loaded and ready with the dedicated battery and SD Memory Card), Approx. 480 g (body only)

Accessories

Package Contents	USB Cable I-USB7, Strap O-ST120, Rechargeable Lithium-ion Battery D-LI90, Battery Charger D-BC90, Software (CD-ROM) S-SW120 <Mounted on the camera> Hot shoe cover Fk, Body mount cover
Software	SILKYPIX Developer Studio 3 for PENTAX

Approximate Image Storage Capacity

(When using a 2 GB SD Memory Card)

Aspect Ratio	Recorded Pixels	JPEG Quality			RAW
		★★★	★★	★	
16:9	13M (4928×2776)	251	445	878	76
	10M (4224×2376)	343	602	1181	—
	6M (3456×1944)	507	890	1707	—
	4M (2688×1512)	830	1429	2672	—
3:2	16M (4928×3264)	214	379	749	76
	12M (4224×2816)	289	512	1007	—
	8M (3456×2304)	429	758	1463	—
	5M (2688×1792)	706	1229	2363	—
4:3	14M (4352×3264)	242	429	841	76
	11M (3840×2880)	311	548	1078	—
	7M (3072×2304)	483	841	1617	—
	4M (2304×1728)	841	1463	2793	—
1:1	10M (3264×3264)	323	569	1117	76
	8M (2880×2880)	412	723	1396	—
	5M (2304×2304)	640	1117	2119	—
	3M (1728×1728)	1117	1920	3615	—

* The number of storable images may vary depending on the subject, shooting conditions, selected capture mode and SD Memory Card, etc.

Symbols

[Rec. Mode] menu 69, 226
[Movie] menu 71, 113, 228
[Playback] menu 155, 229
[Set-up] menu 184, 230
[C Custom Setting] menu 72, 231
(Green/Red) button	... 19, 147
UP / (Flash pop-up/Delete)	button
 19, 21, 63, 65
Av (EV Compensation) button 19, 21, 84
Standard 75
Portrait 75, 76
Landscape 75, 76
Macro 75, 76
Moving Object 75, 76
Night Scene Portrait	... 75, 76
Sunset 75, 76
Blue Sky 75, 76
Forest 75, 76
Night Scene 76
Night Scene HDR 76
Night Snap 76
Food 76
Pet 76
Kids 76
Surf & Snow 77
Backlight Silhouette 77
Candlelight 77
Stage Lighting 77
Museum 77
Movie 116
Flash Off 74

A

AC adapter 42
AC plug cord 39

Accessories 16, 240
Action in M/TAv Mode 151
Adding the date (DPOF) 205
AdobeRGB 129
AE Lock 87
AE Metering 88
AF area 94
AF Assist Light 17, 92
AF (Autofocus) 92
AF coupler 17
AF frame 57
AF point 95
AF/AE-L button 19, 96, 152
Aperture Priority Automatic	
Exposure mode Av 81
Aspect Ratio 114, 126
AWB (White Balance) 130
AUTO (Auto Picture) mode	
 56, 75
Auto Bracketing 85
Auto Flash Discharge 59, 62
Auto Image Rotation 156
Auto Power Off 194
Autofocus AF 92
Autofocus Method 93
Av (Aperture Priority Automatic	
Exposure) mode 81
AV device 178

B

B (Bulb Exposure) mode 83
Backlight Silhouette 77
Base Parameter Adj (Digital	
Filter) 168
Battery 39
Battery level 41
Bleach Bypass (Custom Image)	
 140

Blue Sky  75, 76
 Body mount cover 47
 Bracketing shooting 85
 Bright (Custom Image) 140
 Bright areas 133
 Bright/Dark Area warning
 156, 190, 191
 Brightness adjustment 133
 Built-in flash 59
 Bulb shooting 83
 Button Customization 147

C

Calendar Filmstrip Display ... 159
 Camera shake 100, 114
 Candlelight  77
 Capture mode 74
 Card access lamp 17
 CD-ROM 211
 Center-weighted metering 88
 Charging the battery 39
 City 189
 Cleaning the sensor 237
 Cloudy (White Balance) 130
 CMOS sensor 17
 Color (Digital Filter) 144, 167
 Color Space 129
 Compression ratio 129
 Computer 207
 Connection cable cover 17
 Continuous playback 160
 Continuous Shooting 106
 Contrast (Custom Image) ... 141
 Control panel 24, 32
 Copyright Holder 202
 Correcting distortion 138
 Creating New Folders 201
 Cropping images 166
 Cross Processing (Custom Image) 140
CTE (White Balance) 130

Custom Image 140
[C Custom Setting] menu
 72, 231

D



Dark areas 134
 Date Adjustment 52
 Date change 187
 Daylight (White Balance) 130
 DC coupler 43
 Default settings 226
⏪/UP/⏩ (Delete) button ... 21, 65
 Deleting 65, 163
 Deleting a single image 65
 Deleting all images 164
 Depth of field 99
 Destination 187
 Detailed Information Display
 26
 Developing RAW images
 174, 211
 Digital Filter 144, 167
 Direct keys 31, 68, 226
 Display language 50, 190
 Distortion 138
 DPOF 204
 D-Range Setting 134
 Drive Mode 68
 DST 51, 188
 Dust Removal 237
 Dynamic Range 133







E

E-dial 19, 21
 E-dial in Program 150
 Electronic Compass 244
 Enlarge Instant Review
 95, 157, 191
 Error messages 245
 EV Compensation 84
⏪/Av (EV Compensation) button
 19, 21, 84

Exif	202
Exposure	79
Exposure Bracketing	85
Exposure modes	81
Exposure setting for movies	113
External flash	220
External microphone	115
Extract Color (Digital Filter)	144, 167

F

Face Detection (Autofocus Method)	93
File Format	127
File naming system	129
File No.	196
Filter	144
Filter Effect (Custom Image)	142
Fine Sharpness (Custom Image)	142
Firmware Info/Options	197
Fish-eye (Digital Filter)	168
Flash	59, 215
Flash (White Balance)	130
Flash exposure compensation	61
Flash Off 	74
 UP/  (Delete) button ...	19, 63
Flicker Reduction	30
Fluorescent Light (White Balance)	130
Focus lock	57, 97
Focus mode	92
Focus mode switch	19
Focus Peaking	98, 147
Focusing	92
Focusing ring	98
Folder Display	159
Folder Name	201

Food 	76
Forest 	75, 76
Format	199
Four-way controller (   )	19, 21, 31, 68
Framerate	114

G





Ⓞ (G) button	19, 147
GPS	23, 244
GPS Time Sync	244
Green button	19, 147
Guide Display	75, 147, 192
Guide indicators	30
Guide number	218

H

HDMI output format	180
HDMI output terminal	178
HDR Capture	135
HDR mode	137
High Contrast (Digital Filter)	144, 167
High Dynamic Range Image Capture	135
High/Low Key Adjustment (Custom Image)	141
High-ISO NR	89
Highlight Correction	133
High-speed Sync mode (flash)	222
Histogram Display	25, 28, 29, 190, 191
Hometown	187
Hot shoe	17
Hue (Custom Image)	141





I

Image Capture Settings	126
Image finishing tone	140
Image Rotation	162

- Image storage capacity 42, 255
- Index 172
- INFO** button 19, 21, 22, 25
- Initial settings 50
- Initializing a memory card 199
- Input Focal Length 234
- Installing software 211
- Instant Review 57, 191
- Interface Options 179, 209
- Interval Movie 119
- Interval Shooting 108
- Invert Color (Digital Filter)
..... 144, 167
- ISO sensitivity 79
- J**
- JPEG 127
- JPEG Quality 129
- JPEG Recorded Pixels 128
- K**
- Kids  76
- L**
- Landscape  75, 76
- Landscape (Custom Image)
..... 140
- Language setting 50, 190
- Lateral chromatic aberration
..... 138
- LCD Display 192
- LCD Display Settings 192
- Leading Curtain Sync mode
(flash) 217
- Lens 47, 232
- Lens Correction 138
- Lens information contacts 17
- Lens mount cover 47
- Lens mount index 17, 48
- Lens unlock button 18
- Lens with aperture ring 235
- Live View 190
- Locking the exposure 87
- Locking the focus 97
- Long exposure 83
- M**
- INFO** button 158
- M** (Manual Exposure) mode ...81
- Macintosh208
- Macro 75, 76
- Main switch18, 21, 49
- Manual Exposure mode **M**81
- Manual Flash Discharge ...59, 63
- Manual focus **MF**92, 98
- Manual White Balance132
- Memory195
- Memory Card45
- MENU** button19, 21, 33
- Menu display193
- Menu operation33
- MF** (Manual focus)92, 98
- Microphone input terminal17
- Microphones17, 115
- Miniature (Digital Filter)168
- Mode dial18, 74
- Monitor22
- Monochrome (Custom Image)
.....140
- Monochrome (Digital Filter)
.....167
- Movie113
- Movie button19, 118, 147
- Movie Capture Settings113
- Movie Editing123
- [ Movie] menu71, 113, 228
- Movie Recording118, 147
- Movie SR114
- Moving Object 75, 76
- MSC209
- Multi-exposure111
- Multi-segment metering88

Museum  77
 Muted (Custom Image) 140



N

Natural (Custom Image) 140
 Night Scene  76
 Night Scene HDR  76
 Night Scene Portrait  ... 75, 76
 Night Snap  76
 Noise Reduction 89
 NTSC 179

O

OK button 19, 21
 One Push File Format 149
 Optional accessories 240
 Output Format 179

P



P (Program Automatic Exposure) mode 81
 PAL 179
 Pastel (Digital Filter) 168
 PC/AV output terminal
 178, 210
 Pet  76
 Photographer information 202
 Pixel Mapping 194
 Pixels 114, 128
 Playback 64
PLAY button 19, 21, 64
 Playback information display
 selection 25
 [ Playback] menu 155, 229
 Playback mode palette
 154, 229
 Playback time 42
 Playing back images
 continuously 160
 Playing back movies 121
 Portrait  75, 76
 Portrait (Custom Image) 140

Posterization (Digital Filter)
 168
 Power 49
 Power Saving 194
 Preview 99, 147
 Printing 204
 Product registration 213
 Program Automatic Exposure
 mode **P** 81
 Protect setting 200
 Provided software 211
 PTP 209
 P-TTL (Flash) 221

Q





Quality Level 114, 129
 Quick Zoom 156

R

 (R) button 19, 147
 Radiant (Custom Image) 140
 RAW 127
 RAW Development 174, 211
 [ Rec. Mode] menu 69, 226
 Recorded Pixels 114, 128
 Recording Sound Level 114
 Red-eye reduction 59
 Release 57
 Release-priority 93
 Remote Control 104
 Remote control receiver
 17, 105
 Reset 196
 Resize 165
 Retro (Digital Filter) 144, 167
 Reversal Film (Custom Image)
 140
 RGB Histogram Display 25
 Rotation 162

S

Saturation (Custom Image)	141
Save Cross Processing	143
Save RAW Data	64, 191
SCN (Scene) mode	76
SD Memory Card	45, 199
Select & Delete	163
Select (Autofocus Method)	93
Self-timer	102
Self-timer lamp	17, 103
Sensitivity	79, 175
[ Set-up] menu	184, 230
Shade (White Balance)	130
Shading (Digital Filter)	144, 167
Shadow Correction	134
Shake Reduction	100
Sharpness (Custom Image)	141
Shooting information	22
Show Grid	190
Shutter & Aperture Priority Automatic Exposure mode TAv	81
Shutter Priority Automatic Exposure mode Tv	81
Shutter release button	18, 21, 57
SILKYPIX Developer Studio	211
Sketch Filter (Digital Filter)	167
Slideshow	160
Slim (Digital Filter)	168
Slow Shutter Speed NR	91
Slow-speed Sync	59, 216
Soft (Digital Filter)	168
Software	197, 211
Sound Effects	186
Speaker	17

Specifications	250
Spot (Autofocus Method)	93
Spot metering	88
sRGB	129
Stage Lighting 	77
Standard 	75
Standard Information Display	23, 25
Standby mode display selection	22
Starburst (Digital Filter)	168
Startup screen	49, 192
Strap	38
Sunset 	75, 76
Surf & Snow 	77

T

TAv (Shutter & Aperture Priority Automatic Exposure) mode	81
Temperature warning	30
Thumbnail display	158
Tone Expansion (Digital Filter)	167
Toning (Custom Image)	141
Toy Camera (Digital Filter)	144, 167
Tracking (Autofocus Method)	93
Trailing Curtain Sync	59, 217
Tripod socket	17
Tungsten (White Balance)	130
Tv (Shutter Priority Automatic Exposure) mode	81

U

Updating software	197
USB Connection mode	209

V

Vibrant (Custom Image)	140
Video output format	179
Video terminal	178

Volume 114, 186

W

Water Color (Digital Filter)

..... 167

White Balance 130

Windows 208

World Time 187

Write-protect 5

Z

Zoom lens 57

All PENTAX cameras purchased through authorized bona fide photographic distribution channels are guaranteed against defects of material or workmanship for a period of twelve months from date of purchase. Service will be rendered, and defective parts will be replaced without cost to you within that period, provided the equipment does not show evidence of impact, sand or liquid damage, mishandling, tampering, battery or chemical corrosion, operation contrary to operating instructions, or modification by an unauthorized repair shop. The manufacturer or its authorized representatives shall not be liable for any repair or alterations except those made with its written consent and shall not be liable for damages from delay or loss of use or from other indirect or consequential damages of any kind, whether caused by defective material or workmanship or otherwise; and it is expressly agreed that the liability of the manufacturer or its representatives under all guarantees or warranties, whether expressed or implied, is strictly limited to the replacement of parts as hereinbefore provided. No refunds will be made on repairs by non-authorized PENTAX service facilities.

Procedure During 12-month Warranty Period

Any PENTAX which proves defective during the 12-month warranty period should be returned to the dealer from whom you purchased the equipment or to the manufacturer. If there are no representatives of the manufacturer in your country, send the equipment to the manufacturer, with postage prepaid. In this case, it will take a considerable length of time before the equipment can be returned to you owing to the complicated customs procedures required. If the equipment is covered by warranty, repairs will be made and parts replaced free of charge, and the equipment will be returned to you upon completion of servicing. If the equipment is not covered by warranty, regular charges of the manufacturer or of its representatives will apply. Shipping charges are to be borne by the owner. If your PENTAX was purchased outside of the country where you wish to have it serviced during the warranty period, regular handling and servicing fees may be charged by the manufacturer's representatives in that country. Notwithstanding this, your PENTAX returned to the manufacturer will be serviced free of charge according to this procedure and warranty policy. In any case, however, shipping charges and customs clearance fees to be borne by the sender. To prove the date of your purchase when

required, please keep the receipt or bills covering the purchase of your equipment for at least a year. Before sending your equipment for servicing, please make sure that you are sending it to the manufacturer's authorized representatives or their approved repair shops, unless you are sending it directly to the manufacturer. Always obtain a quotation for the service charge, and only after you accept the quoted service charge, instruct the service station to proceed with the servicing.

- **This warranty policy does not affect the customer's statutory rights.**
- **The local warranty policies available from PENTAX distributors in some countries can supersede this warranty policy. Therefore, we recommend that you review the warranty card supplied with your product at the time of purchase, or contact the PENTAX distributor in your country for more information and to receive a copy of the warranty policy.**



The CE Mark is a Directive conformity mark of the European Union.

For customers in USA

STATEMENT OF FCC COMPLIANCE

This device complies with Part 15 of the FCC Rules. Operation is subject to the following two conditions: (1) This device may not cause harmful interference, and (2) this device must accept any interference received, including interference that may cause undesired operation.

Changes or modifications not approved by the party responsible for compliance could void the user's authority to operate the equipment.

This equipment has been tested and found to comply with the limits for a Class B digital device, pursuant to part 15 of the FCC Rules.

These limits are designed to provide reasonable protection against harmful interference in a residential installation. This equipment generates, uses and can radiate radio frequency energy and, if not installed and used in accordance with the instructions, may cause harmful interference to radio communications. However, there is no guarantee that interference will not occur in a particular installation.

If this equipment does cause harmful interference to radio or television reception, which can be determined by turning the equipment off and on, the user is encouraged to try to correct the interference by one or more of the following measures:

- Reorient or relocate the receiving antenna.
- Increase the separation between the equipment and receiver.
- Connect the equipment into an outlet on a circuit different from that to which the receiver is connected.

* Consult the dealer or an experienced radio/TV technician for help.

For customers in Canada

This Class B digital apparatus complies with Canadian ICES-003.

Pour les utilisateurs au Canada

Cet appareil numérique de la classe B est conforme à la norme NMB-003 du Canada.

FOR CALIFORNIA, U.S.A. ONLY

Perchlorate Material-special handling may apply.

The lithium battery used in this camera contains perchlorate material, which may require special handling.

See www.dtsc.ca.gov/hazardouswaste/perchlorate

Declaration of Conformity
According to 47CFR, Parts 2 and 15 for
Class B Personal Computers and Peripherals

We: PENTAX RICOH IMAGING AMERICAS
CORPORATION

Located at: 633 17th Street, Suite 2600
Denver, Colorado 80202 U.S.A.
Phone: 800-877-0155 FAX: 303-790-1131

Declare under sole responsibility that the product identified herein complies with 47CFR Parts 2 and 15 of the FCC rules as a Class B digital device. Each product marketed is identical to the representative unit tested and found to be compliant with the standards. Records maintained continue to reflect the equipment being produced can be expected to be within the variation accepted, due to quantity production and testing on the statistical basis as required by 47CFR §2.909. Operation is subject to the following two conditions: (1) This device may not cause harmful interference, and (2) This device must accept any interference received, including interference that may cause undesired operation. The above named party is responsible for ensuring that the equipment complies with the standards of 47CFR §15.101 to §15.109.

Product Name: Digital Single Lens Camera

Model Number: K-01

Contact person: Customer Service Manager

Date and Place: February, 2012, Colorado

Information for Users on Collection and Disposal of Old Equipment and Used Batteries



1. In the European Union

These symbols on the products, packaging and/or accompanying documents mean that used electrical and electronic equipment and batteries should not be mixed with general household waste.

Used electrical/electronic equipment and batteries must be treated separately and in accordance with legislation that requires proper treatment, recovery and recycling of these products.



By disposing of these products correctly you will help ensure that the waste undergoes the necessary treatment, recovery and recycling and thus prevent potential negative effects on the environment and human health which could otherwise arise due to inappropriate waste handling.

If a chemical symbol is added beneath the symbol shown above, in accordance with the Battery Directive, this indicates that a heavy metal (Hg = Mercury, Cd = Cadmium, Pb = Lead) is present in the battery at a concentration above an applicable threshold specified in the Battery Directive.

For more information about collection and recycling of used products, please contact your local authorities, your waste disposal service or the point of sale where you purchased the products.

2. In other countries outside the EU

These symbols are only valid in the European Union. If you wish to discard used products, please contact your local authorities or dealer and ask for the correct method of disposal.

For Switzerland: Used electrical/electronic equipment can be returned free of charge to the dealer, even when you don't purchase a new product. Further collection facilities are listed on the home page of www.swico.ch or www.sens.ch.

Memo

Memo

PENTAX RICOH IMAGING CO., LTD.

2-35-7, Maeno-cho, Itabashi-ku, Tokyo 174-8639, JAPAN
(<http://www.pentax.jp>)

PENTAX RICOH IMAGING FRANCE S.A.S. 112 Quai de Bezons, B.P. 204, 95106 Argenteuil Cedex, FRANCE
(European Headquarters) (HQ - <http://www.pentax.eu>)
(France - <http://www.pentax.fr>)

PENTAX RICOH IMAGING DEUTSCHLAND GmbH Julius-Vosseler-Strasse 104, 22527 Hamburg, GERMANY
(<http://www.pentax.de>)

PENTAX RICOH IMAGING UK LTD. PENTAX House, Heron Drive, Langley, Slough, Berks SL3 8PN, U.K.
(<http://www.pentax.co.uk>)

PENTAX RICOH IMAGING AMERICAS CORPORATION 633 17th Street, Suite 2600, Denver, Colorado 80202, U.S.A.
(<http://www.pentaximaging.com>)

PENTAX RICOH IMAGING CANADA INC. 1770 Argentia Road Mississauga, Ontario L5N 3S7, CANADA
(<http://www.pentax.ca>)

<http://www.pentax.jp/english>

- Specifications and external dimensions are subject to change without notice.

Free Manuals Download Website

<http://myh66.com>

<http://usermanuals.us>

<http://www.somanuals.com>

<http://www.4manuals.cc>

<http://www.manual-lib.com>

<http://www.404manual.com>

<http://www.luxmanual.com>

<http://aubethermostatmanual.com>

Golf course search by state

<http://golfingnear.com>

Email search by domain

<http://emailbydomain.com>

Auto manuals search

<http://auto.somanuals.com>

TV manuals search

<http://tv.somanuals.com>