

# PENTAX®

## OPERATING MANUAL

***IQZoom160***

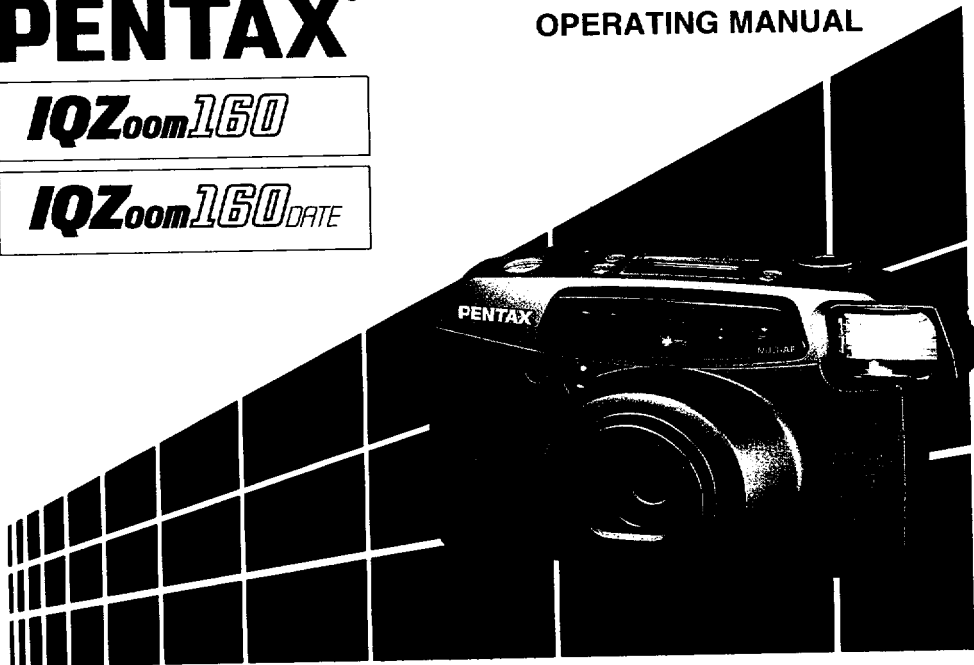





***IQZoom160DATE***



Congratulations on your purchase of the PENTAX IQ Zoom 160 and welcome to the world of Pentax zoom compact photography! Your compact, light weight camera is a great companion to preserve your favorite memories. Its built-in 38-160mm lens gives you the freedom to frame everything from breathtaking landscapes to family portraits, even detailed close-ups. The built-in auto flash helps you capture subjects in dimly-lit places or photograph indoor scenes with clarity and brilliance. Also included are panorama standard format mid-roll switching capability and a wireless remote control feature. Multi (6)-segment metering system ensures very precise metering for optimum exposure under any given lighting conditions. Since most of the operation - including film loading, film speed setting, winding, rewinding, focus and exposure control - are automatic, you can take great pictures effortlessly. The DATE model makes it easy to remember the dates when you took pictures.

- Please read this manual carefully before operating the camera to take consistently superior pictures.
- Pay special attention to the cautions and notes in this Operating Manual. Pictures and illustrations shown herein may differ from the camera's actual appearance.

#### Icon indications used in this manual

Operation direction	
Automatic operation	
Attention	
Lamp lighted	
Lamp blinking	
Correct	
Incorrect	

The name of the camera's working parts are listed on the front and back flaps of this manual. Keep the flaps unfolded for quick reference while reading the manual.

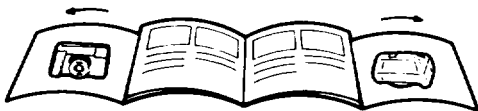

## NAMES OF WORKING PARTS I

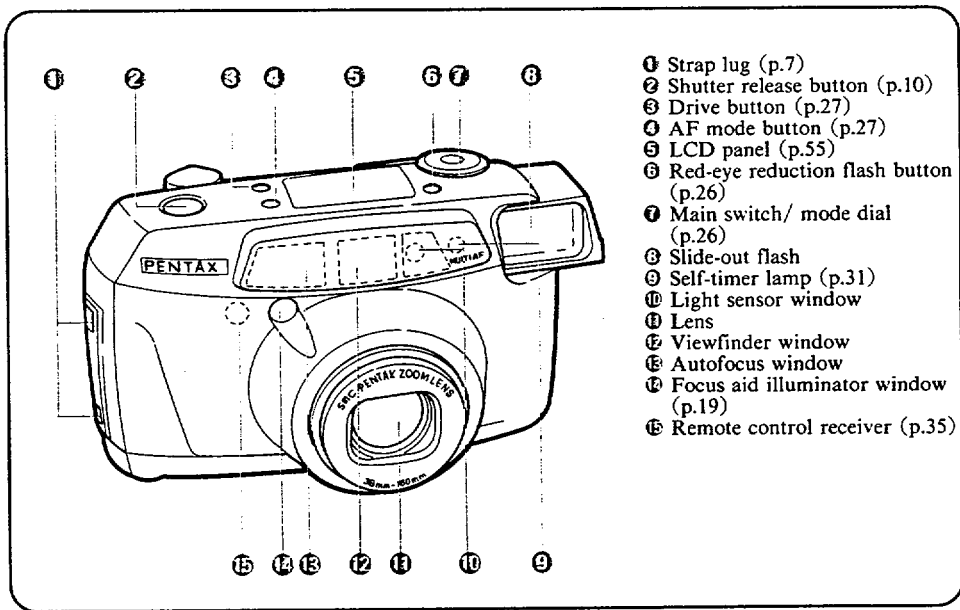

## OUTLINE OF BASIC OPERATIONS

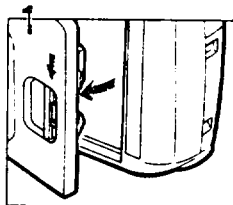

1 Open the back cover (see page 12).

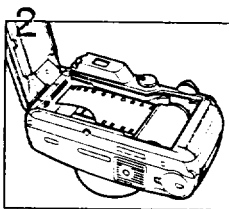

2 Load the film and close the back cover (see page 13).

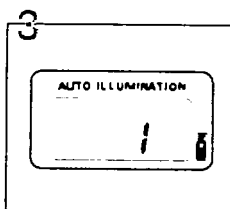

3 The film will automatically advance to the first frame (see page 14).

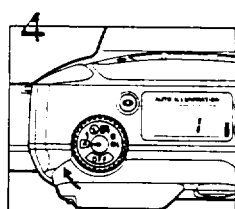

4 Switch on power by the main switch mode dial (see page 8).

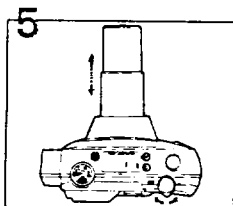

5 Frame your subject and operate the zoom lever to compose the shot (see page 11).



6 Focus on your subject (see page 20).



7 Depress the shutter release button. In dark conditions, the flash will discharge automatically (see page 23).

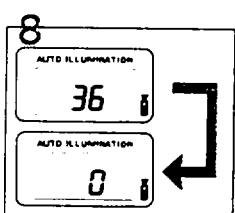

8 When the film is finished, the camera will automatically rewind it (see page 24).

## FOR SAFE USE OF YOUR CAMERA

Although we have carefully designed this camera for safe operation, please be sure to follow precautions given in this page.



### **WARNING**

This mark indicates precautions that if not followed, could result in serious injury to the operator.



### **CAUTION**

This mark indicates precautions that, if not followed, could result in minor or medium injury to the operator or damage to the equipment.



### **WARNING**

- The electric circuits inside the camera contain high voltage working parts. Never attempt to disassemble the camera yourself.
- Never touch internal parts of the camera if they become exposed from dropping the camera or for some other reason, as there is danger of electric shock.
- Wrapping the strap around your neck is dangerous. Make sure that small children do not get the strap caught around their neck.
- Be sure to store battery out of the reach of children. Seek medical assistance immediately if accidentally swallowed.



### **CAUTION**

- Do not use the flash near anyone's eyes, as it may hurt them. Be particularly careful with the flash around infants.
- Never try to disassemble, short or recharge the battery. Also, do not dispose of the battery in fire, as it may explode.
- Remove the battery from the camera immediately if it becomes hot or begin to smoke. Be careful not to burn yourself during removal.

## PRECAUTIONS FOR YOUR CAMERA

### Precautions when taking pictures

- Do not use the camera where it may come in contact with rain, water or any other liquid, because the camera is not weather, water, or liquid resistant. Should the camera get wet from rain, splashing water, or any other liquid, wipe it off immediately with a dry soft cloth.
- Do not drop the camera or allow it to hit a solid object. If the camera suffers a severe shock or impact, take it to a Pentax service center for inspection.
- Be careful not to subject the camera to strong vibrations, shock or pressure. Use a cushion to protect the camera when carrying it in a motorcycle, car, boat, etc.
- Condensation on the interior or the exterior of the camera may be extremely harmful to the camera mechanism as it may cause rust. Furthermore, if the camera is taken from warm temperature to a subfreezing one or vice versa, the formation of icelets may cause damage. In such a case, put the camera into a case or plastic bag so that any changes in temperature difference is minimized. Do not remove it from the bag until temperature has stabilized.

### Precautions for storage

- Avoid leaving the camera for extended periods in places where temperature and humidity are high such as in a car.
- Do not store the camera in a closet with moth balls or in a case where chemicals are handled. Store it in a place with good air circulation to prevent fungus growth.

### Precautions for proper care

- Use a blower and lens brush to remove dust accumulated on the lens or the viewfinder window.
- Never use solvents such as paint thinner, alcohol or benzene to clean the camera. To clean the external camera surfaces, - but not glass surfaces; using a dry or silicone-treated cloth is recommended.

## PRECAUTIONS FOR BATTERY

### Other precautions

- The temperature range at which this camera functions properly is 50°C to -10°C (122°F to 14°F).
- To maintain optimum performance, it is recommended that the camera be inspected every one or two years. If the camera has not been used for an extended period, or is being prepared for an important photographic session, it is recommended that you have the camera inspected or test shoot with it.
- The PENTAX warranty provided only for the repair of defects in materials or workmanship. Damage of any kind cannot be repaired at no charge under the term of the warranty. If the difficulty is caused as a direct result of the product being used in conditions as outlined in the other operation contrary to the instructions outlined in this manual, charges will be assessed or a repair quotation will be provided.

### LCD (Liquid-crystal display)

- When the LCD is exposed to high temperatures over about 60°C, it may blacken, but when the temperature normalizes, it will return to normal.
- The LCD may also slow down in response to lower temperatures, but this is a normal characteristic of an LCD.

- Misuse of a battery can cause hazards such as leakage, overheating, explosions, etc. The battery should be inserted with the “+” and “-” sides facing correctly.
- Never try to disassemble, short or recharge the battery. Also do not dispose of the battery in a fire, as it may explode.
- Battery performance may be temporarily hindered in low temperatures, but will recover in normal temperatures.
- Keep a spare battery on hand for replacement convenience when shooting outdoors or while traveling.
- When the camera is in a bag, make sure the main switch/mode dial is set at the OFF position. Otherwise, battery power may be wasted if the shutter release button is accidentally pushed.

## PRACTICAL SHOOTING GUIDE



### Focusing

- Taking a picture through a window. ....p.37  
Focusing on a particular spot. ....p.38



### Flash photography

- Taking a picture in low light situations. ....p.23  
Minimizing the red-eye effect. ....p.26,27  
Taking a portrait when the subject is in the shade. ....p.28  
Taking a picture of people with sunset scenery in the background. ....p.29  
Taking a picture of people with night scenery in the background. ....p.30



### Zooming

- Making a subject larger or smaller. ....p.11





### Taking pictures of people in various situations

- Taking a portrait when the subject is in the shade. ....p.28
- Taking a picture of people with sunset scenery in the background. ....p.29
- Taking a picture of people with night scenery in the background. ....p.30
- Putting yourself into a picture. ....p.31



### Landscape photography

- Taking a picture of people with sunset scenery in the background. ....p.29
- Taking a picture of night scenery. ....p.30
- Taking a picture of people with night scenery in the background. ....p.30



### Others

- Taking more than 2 pictures on the same frame. ....p.36
- Taking a picture with the (optional) Wireless Remote Control. ....p.33
- Imprinting date on a picture. ....p.44

## TABLE OF CONTENTS

• Names of working parts .....	Flaps
• Introduction .....	Front fold out
• Outline of basic operations .....	Inside cover
• For safe use of your camera .....	1
• Precautions for your camera .....	2
• Precautions for battery .....	3
• Practical shooting guide .....	4
• Table of contents .....	6

### PREPARATIONS BEFORE TAKING PHOTOGRAPHS

1. Strap attachment .....	7
2. Turning on the power .....	8
3. Battery check .....	9
4. How to hold the camera .....	10
5. Operating the 38-160mm zoom lens .....	11

### TAKING PHOTOGRAPHS

1. Film loading .....	12
2. Diopter adjustment .....	15
3. Automatic LCD illuminator .....	15
4. Viewfinder displays .....	16
5. Lamp indications .....	19
6. Ordinary photography .....	20
7. Unloading film .....	24

### TAKING BETTER PHOTOGRAPHS

How to select modes	
Red-eye reduction flash mode .....	26
Daylight-sync shooting .....	28
Taking a picture at a slow shutter speed .....	29
Slow-speed sync photography .....	29
Bulb shooting .....	30
Bulb-sync shooting .....	30
Self-timer photography .....	31
Using wireless remote control (option) .....	33
Multi-exposure shooting .....	36
Infinity-landscape shooting .....	37
Spot AF shooting .....	38
Focus lock shooting .....	39
Taking Panorama format picture .....	41
DATE MODEL .....	44

### MAINTENANCE CONSIDERATIONS

Battery exhaustion warning .....	46
Installing/Replacing the battery .....	47
Troubleshooting .....	48
Flash effective range with films other than ISO 100,200, or 400 .....	49
Specifications .....	50
Warranty policy .....	52
LCD panel .....	55



## STRAP ATTACHMENT

### PREPARATIONS BEFORE TAKING PHOTOGRAPHS

For optimum performance you should familiarize yourself with certain fundamentals before taking any photographs.

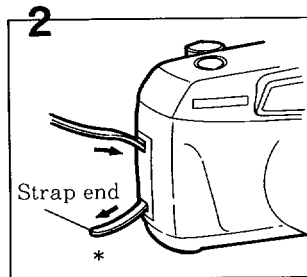
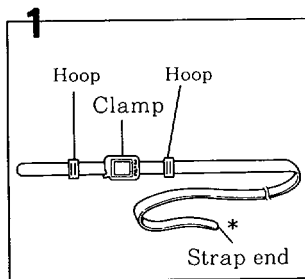

Fit the strap on the camera using the following procedures.

- 1 Pass the strap through the hoops and the clamp as shown in illustration 1.
- 2 Pass the \* marked strap end through the camera's strap lug as shown in illustration 2.

## 2

## TURNING ON THE POWER

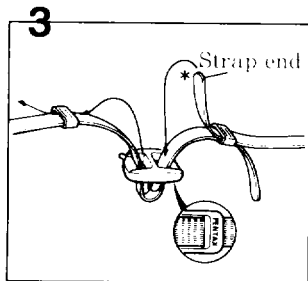

3 Pass the \* marked strap end through the hoops and the clamp as shown in illustration 3.

- Use the illustrated part of the strap for open the battery chamber cover, adjusting the data on the Date model, or pushing the mid-roll rewind button to rewind a roll of film before exposing all the frames.



8

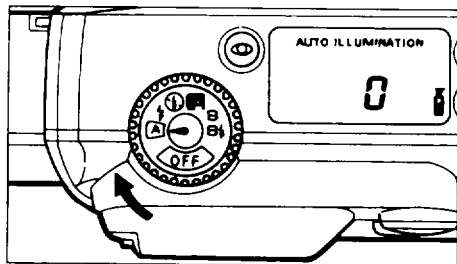

When the main switch/mode dial is set to a position other than OFF position, the power turns ON. To turn the power OFF, set the main switch/mode dial to the ( OFF ) position.

- When the camera is not in use, ensure that the main switch/mode dial is set to the ( OFF ) position.
- If the camera is ON and left unused for over 3 minutes, the lens automatically retracts.



## BATTERY CHECK

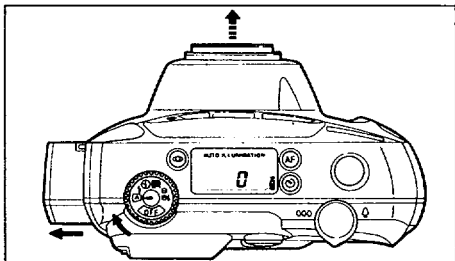

When the power turns ON, the lens extends slightly for opening the lens cover and the flash slides out.

- When the power turns OFF, the lens and flash retract.
- When the flash is pushed into the camera manually, the shutter cannot be released even if the power is ON.
- The lens cover automatically opens and closes when the main switch/mode dial is set to the ON and OFF position. Never attempt to open the lens cover manually.

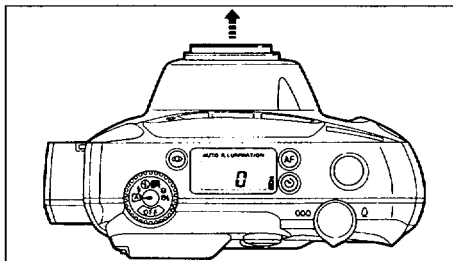

### Battery check

After you set the main switch/mode dial to the position other than OFF, the lens slightly extends and the lens cover opens. You are now ready to shoot.

- See page 46 when the battery exhaustion symbol (  ) appears on the LCD panel.
- Battery performance may be temporarily hindered in low temperature, but will recover in normal temperatures.



## HOW TO HOLD THE CAMERA

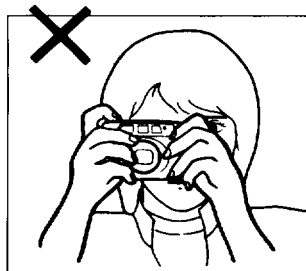
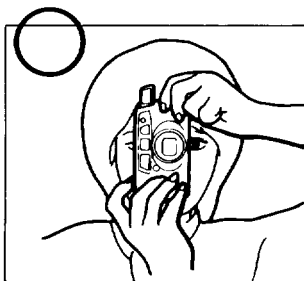
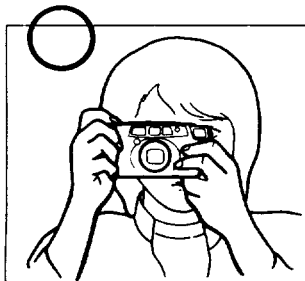

Hold the camera as still as possible and steady it against your face. Depress the shutter release button gently. (If too much force is applied, the camera is likely to shake, and the picture will be blurred.) If possible, brace your body against a stable, stationary object such as a wall. When using the flash with the camera positioned vertically, hold the camera so that the flash is above the lens.

### Notes:

- Do not hold the zoom lens because it moves back and forth while in operation.
- Make sure not to obstruct the autofocus window, lens, light sensor window or the slide-out flash with your fingers, hair or other object.



## OPERATING 38-160mm ZOOM LENS

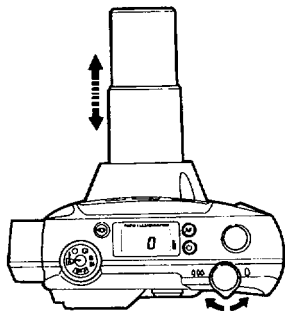
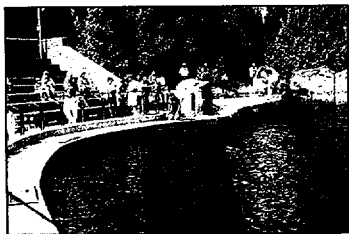
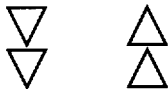

When you move the zoom lever to the right (◆), the lens moves towards the 160mm telephoto setting and frames the subject more closely. When you move the zoom lever to the left (◆◆◆), the lens moves towards the wide-angle 38mm setting. When the lens zooms to the desired setting, release the zoom lever and depress the shutter release button fully to take pictures.



## FILM LOADING (Ensure the power is off before inserting the film.)

### TAKING PHOTOGRAPHS

After reading this instruction manual you should be familiar with the functions available on the camera, and you're ready to insert the film.

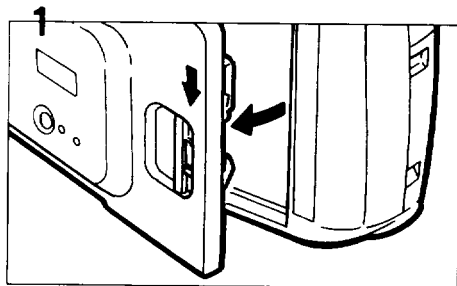

- 1 Slide the back cover release lever down in the direction of the arrow to open the back as illustrated.



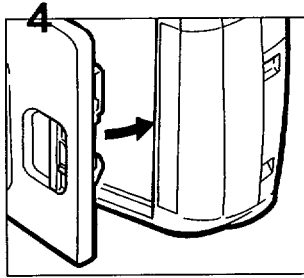
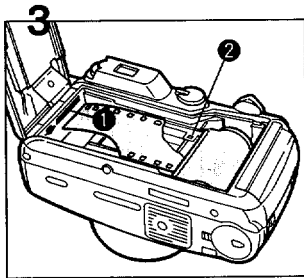
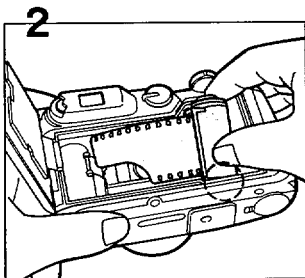

- 2 Place the film cartridge in the film chamber by fitting its flat side on the top of the rewind shaft first and then slide the top end of the film cartridge into the camera.
- 3 Pull the film leader out far enough from the cartridge to reach the take-up spool. Align the tip of the film with the film leader end mark ①.
- 4 After the back cover is closed, the film automatically advances to the first frame.

**Notes:**

- If there is dirt on the film detector ②, film cannot be wound properly.
- Ensure the film is taut as illustrated on the illustration. Take up any slack in the film by pushing it back into the cartridge.
- If the end of the film leader is extremely bent, straighten it or cut off the bent portion.

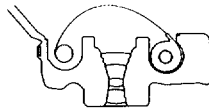

× Slack No!

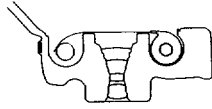

○ Flat Yes!

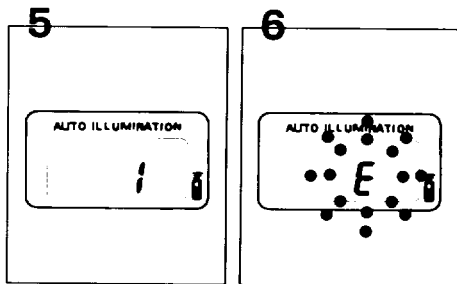

- 5 When ( | ) appears in the exposure counter on the LCD panel, the film automatically stops winding. The indication appears as shown above.
  - 6 If ( E ) blinks on the LCD panel, it means the film is not properly loaded. Reload the film.
- The exposure counter indication will remain on even if the main switch is turned off.

#### Automatic film speed setting

This camera is designed to use DX-coded films with ISO rating from 25 to 3200. When any of these films are loaded, the proper film speed is automatically set for the camera.

#### Notes:

- Non-DX coded film cannot be used. If non-DX coded film is used, the camera automatically sets the film speed to ISO 25.
- A film with ISO400 film speed is recommended to get less image blur and to cover more photographic situations.
- Use high-speed films with ISO 800 or higher mainly for shooting indoors or in dimly-lit conditions.



## DIOPETER ADJUSTMENT

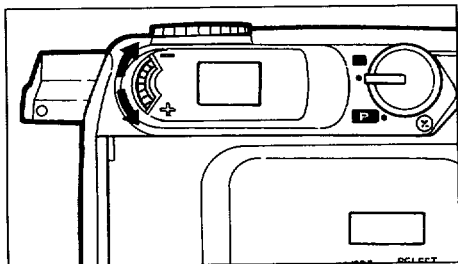

Turn ON the power. Aim the camera toward a bright subject. While looking through the viewfinder, rotate the diopter adjustment dial to the right or left until the AF frame appears in the sharpest focus.

- Be sure to adjust the diopter before use.



## AUTOMATIC LCD ILLUMINATOR

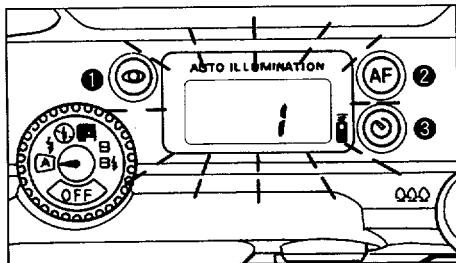

In low light situations, the illuminator of the LCD panel lights up when any one of the button ①, ②, or ③ is depressed or the main switch/mode dial is turned. If you wish to use the LCD panel illuminator any other time, depress any of these buttons for longer than 2 seconds.

# VIEWFINDER DISPLAYS

## Standard format

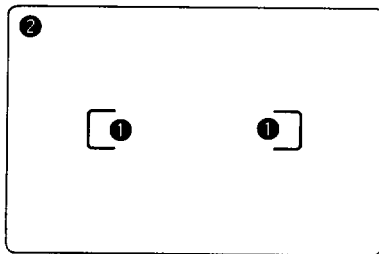

## Panorama format

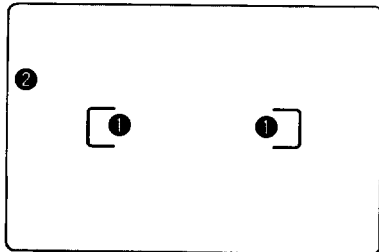

16

Turn the power ON by setting the main switch/mode dial to the position other than the OFF position. When the autofocus frame in the viewfinder is not clearly seen, rotate the diopter adjustment dial until the AF frame appears in the sharpest focus. See page 15 for adjusting the diopter. The autofocus frame and the picture area in the viewfinder automatically vary in accordance with the distance of the subject and focal length of the zoom lens you have set. See page 17 and 18.

### Standard format

① Autofocus frame

Focus on the subject with this frame

② Picture area

When taking a normal picture, compose the scene within this frame.

### Panorama format

① Autofocus frame

Focus on the subject with this frame.

② Picture area

When taking panorama pictures, compose the scene within this frame.

- Regular size color prints may cut off what appear on the extreme edge of the film frame. Compose your picture with a margin of safety at the edge.

**Close distance compensation frame**

When the distance to the subject becomes closer, the picture area is automatically changed and compensated. Compose the scene within this frame.

**Standard format**

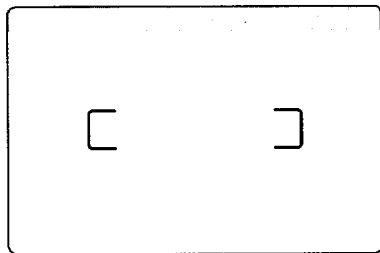

**Panorama format**

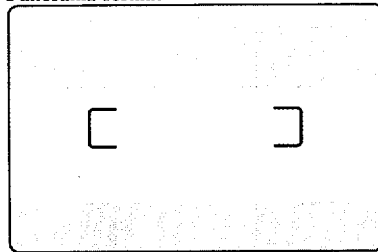

### Autofocus frame

The autofocus frame varies in three steps according to the focal length you have set. Focus the subject within the autofocus frame. The autofocus frame becomes wider when the lens is zoomed toward the telephoto 160mm side.

#### Five-point AF

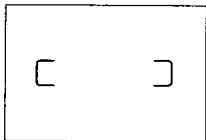
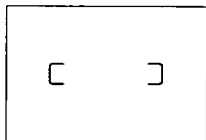
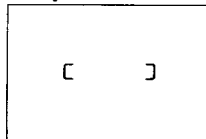

38mm



160mm

#### Spot AF

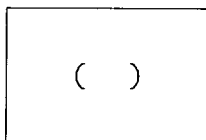
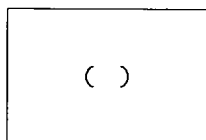
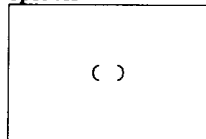



## LAMP INDICATIONS

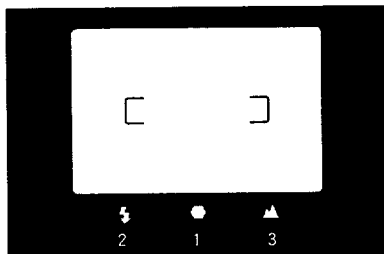

When you depress the shutter release button half-way down, the lamp ①, ② and/or ③ lights up or blinks as shown above.

**① Green lamp (Focus status) :**

When the subject is in focus, it will light up to indicate that you can take the picture; when the subject is not in focus, it will blink, indicating that you cannot take the picture because the camera-to-subject distance is too close or is a hard-to-autofocus subject. See page 40.

- The autofocus frame also blinks when the subject is difficult to autofocus.

**② Red lamp (Flash status) :**

When the flash is ready to discharge, it will light up. When the flash is being charged, it will blink.

**③ Infinity-landscape lamp:**

When the Infinity-Landscape Mode is set, it will light up.

**Shooting range for standard and panorama format pictures**

160mm	1.2m(3.9ft) to infinity
38mm	0.8m(2.6ft) to infinity

**Focus aid illuminator**

In low light situations and/or hard-to-autofocus subjects, the red light is automatically projected to assist the autofocus system when the shutter release button is depressed halfway down.

# 6

## ORDINARY PHOTOGRAPHY

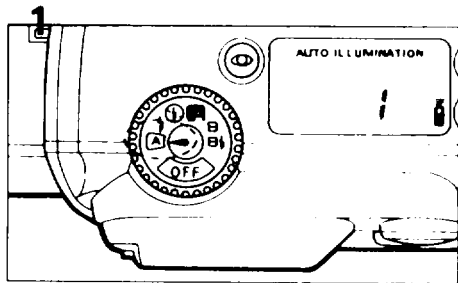

1 Set the main switch mode mode dial to the **A** position.



2 After zooming the lens and composing your scene, focus on the subject with autofocus frame.



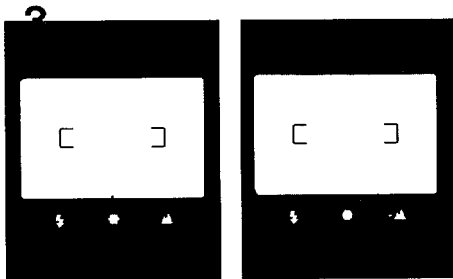

### 3 Checking the lamp indication

Depress the shutter release button halfway down. When the subject is infocus, the green lamp will light up. The green lamp blinks when the camera is not able to obtain proper focus for one of the following reasons.

- ❶ The subject is too close. Extend the camera-to-subject-distance until the green lamp is lit continuously.
  - ❷ The subject is difficult to autofocus. See page 40.
- This camera uses the five-point AF system to focus on the subject. Even if the subject is slightly off the center of the AF frame, the subject will easily be brought into focus.
  - To focus on a particular spot in the AF frame, select the Spot AF Mode. See page 38.
  - If the autofocus window is dirty, the autofocus may not function properly.
  - If you wish to focus on another subject, lift your finger from the shutter release button and depress the shutter button halfway down again.

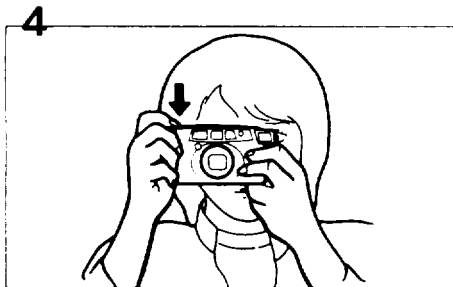

#### 4 Shooting

Depress the shutter release button fully, and the shutter will be released. The film automatically advances to the next frame.

#### Notes:

- When the shutter is released, the self-timer lamp momentarily lights up to indicate that a picture has been taken.
- The shutter cannot be released while the lens is zooming.

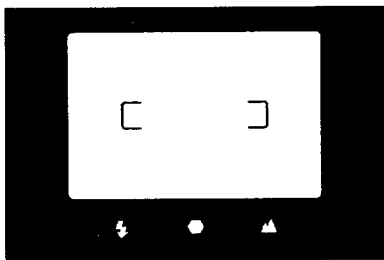

#### Automatic Flash Emission

The flash will automatically discharge in low light or in a backlit situation. When the shutter release button is depressed halfway down in low light, the red lamp will light up, indicating the flash is ready to discharge. If the red lamp blinks, this indicates that the flash is being charged and the shutter cannot be released. Therefore, make sure that the red lamp glows continuously before taking pictures.

#### Red-eye

Shooting portraits with the flash may result in "red-eye", an effect where the subjects eyes appear red in the print. This camera includes a red-eye reduction flash function, which reduces the red-eye phenomenon by using pre-flash. See page 26 and 27 for details.

#### Flash effective ranges (Nega-color film used)

Lens \ ISO	100	200	400
38 m m (◆◆◆)	0.80~4.5m (2.6-14.8ft)	0.80~6.5m (2.6-21.3ft)	0.80~9.0m (2.6-29.5ft)
160 m m (◆)	1.2~2.5m (3.9-8.2ft)	1.2~3.5m (3.9-11.5)	1.2~5.0m (3.9-16.4ft)

See page 49 when any other ISO films are loaded.



## UNLOADING FILM (Remove the film from the camera in the shade or by using your body to shade the camera)

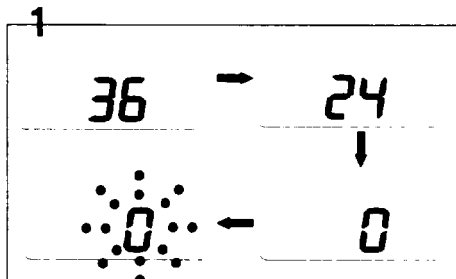

### 1 Rewinding the film

After you have exposed the last frame of the roll, the lens retracts and the film rewinds automatically. Then, the motor stops, and ( 0 ) blinks as shown to indicate that the film has been rewound.

- A 24-exposure roll of film takes about 25 seconds to be rewound.
- During rewinding, the exposure counter counts frame numbers in reverse.
- The entire roll of film including the film leader is always rewound into the cartridge to prevent any part of the film being exposed to light.

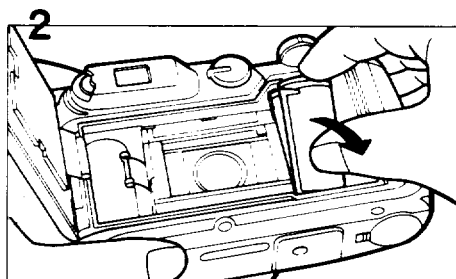

### 2 Unloading the film

To unload the film, open the back cover, and remove the cartridge from the chamber by pulling the top of the film cartridge out with your finger.

#### Notes:

- The shutter may be released a frame or two even after the specified number of frames have been used up as indicated by the number of shots shown on the film cartridge. If this occurs, these extra frames may be lost in the processing.
- Never open the back cover until the whole film roll is rewound.

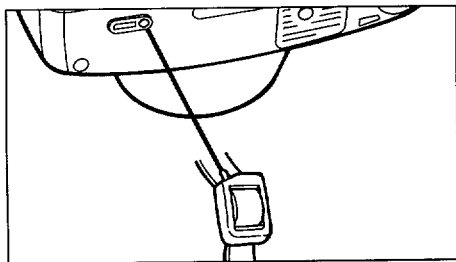

### **Rewinding a film in mid-roll**

If you wish to unload a film before exposing all the frames, push the mid-roll rewind button with the protrusion part of the strap clamp; the lens retracts and then film rewinding starts. When rewind is completed, the motor stops, and (  ) blinks, indicating that the back cover may be opened safely.

## HOW TO SELECT FLASH, AF AND DRIVE MODES

### TAKING BETTER PHOTOGRAPHS

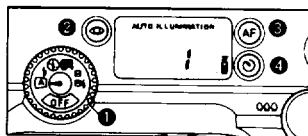

To set various flash modes, turn the main switch/mode dial ①.

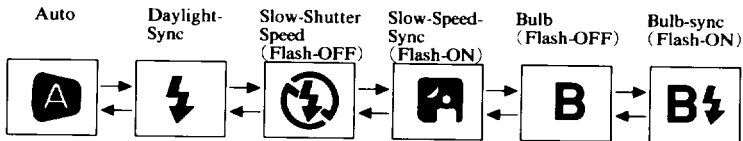

- For normal use, set the main switch/mode dial to the (  ) position.

#### Red-Eye Reduction Flash Function

To reduce the red-eye phenomenon in the picture, depress the red-eye reduction flash button (  ) ②. With this mode, the flash discharges two consecutive times, reducing the appearance of the red-eye effect. To cancel this mode, depress the red-eye reduction button again.

To set various shooting modes, depress the drive button ④.

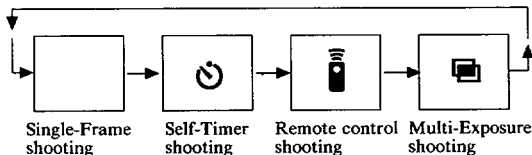

- For normal use, use the Single-Frame Shooting Mode.
- In any exposure and/or shooting mode, if the button ④ is depressed after the shutter is released, the normal shooting mode is returned automatically.

To set various focusing modes, depress the AF mode button ⑤.

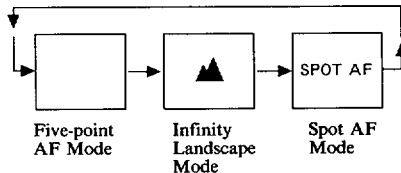

- For normal use, use the Five-point AF Mode.

#### Red-eye phenomenon in flash photography

When a picture is taken using a flash, a subject's eyes may appear red in the print. This phenomenon is caused by the reflection of the electronic flash in the retina. It can be reduced when the surrounding of the subjects are brightened, or shooting distance is shortened or by employing the red-eye reduction flash feature.

## DAYLIGHT-SYNC SHOOTING

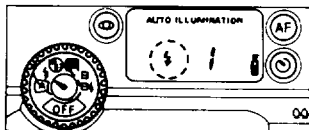

Set the main switch / mode dial at the (ON) position. (ON) appears on the LCD panel. In this

mode, the flash will discharge in both dark and bright conditions. When a portrait is taken with the subject in a backlight situation, the front of the subject may be cast in shadow. In such a case, use the Daylight-Sync Shooting Mode (Flash-ON mode) within the flash-effective range to take pictures. This will ensure that a picture is well exposed without any shadow. When you wish to discharge the flash, use this mode. In this mode, the flash will always discharge.

### Notes:

- Make sure that the red lamp in the viewfinder is lit when the shutter release button is depressed halfway down before shooting. The red lamp blinking indicates that the flash is being charged.
- Make sure you're within the flash effective range even when you use the built-in flash as a fill-in flash in daylight. See page 23.



Without Daylight-Sync



With Daylight-Sync



## TAKING PICTURES AT A SLOW SHUTTER SPEED

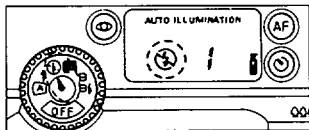

### Slow Shutter Speed (Flash-Off)

Set the main switch / mode dial to the ( S ) position.

( S ) appears on the LCD panel. In this mode, the flash does not discharge, and a picture is taken at a slow shutter speed up to approx 2 seconds. Use it in places where flash photography is prohibited, such as in theaters and museums. Furthermore, this mode is also useful for a natural existing light effect in low ambient photography.



With Slow-Speed-Synchro

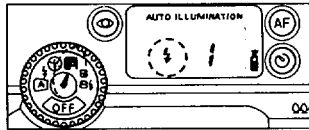

### Slow-Speed-Sync Shooting (Flash-On)

Set the main switch / mode dial to the ( A ) position.

( A ) appear on the LCD panel. It is possible to photograph subjects and background in a balanced way (as shown in the photo) by using the flash to properly expose the foreground subject and a slow-speed to expose the low light background.

### Notes:

- When shooting in low light, the shutter speed gets slower, and camera shake is likely to blur your picture. Use of a tripod is recommended.
- Make sure you are within the flash effective range even when you use the flash as a fill-in flash in daylight. See page 23.

## BULB, BULB-SYNC SHOOTING

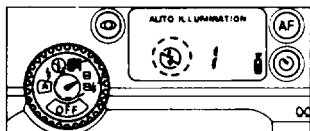

### Bulb Mode (B)

This mode is useful for long exposures required for shooting fire-

works and night scenes, for example. When using this mode, the camera should be mounted on a tripod so that the camera will be steady.

Set the main switch/mode dial to the (B) position. (⚡) appears on the LCD panel.

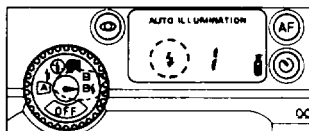

### Bulb-Synch Mode (B ⚡)

This lets you use the flash in addition to the Bulb Mode, so you

can take a portrait photograph with a night scene in the background, for example.

Set the main switch/mode dial to the (B ⚡) position. (⚡) appears on the LCD panel and the Bulb-Sync Mode is set.

- Make sure you're within the flash effective range even when the Bulb-Sync Mode in use. See page 23.

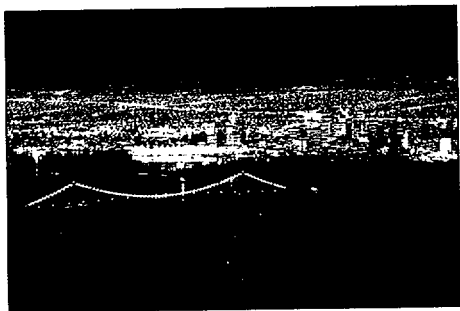

Bulb mode, approx. 3-sec. (ISO 400)

The shutter remains open as long as the shutter release button held down.

- Use of a tripod is recommended.

## SELF-TIMER PHOTOGRAPHY

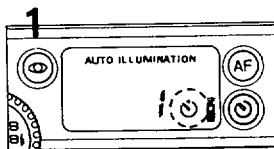

### Self-Timer

Use the self-timer if you wish to get in the picture. Use of a tripod is recommended.

- 1 Depress the drive button until (🕒) appears on the LCD panel.

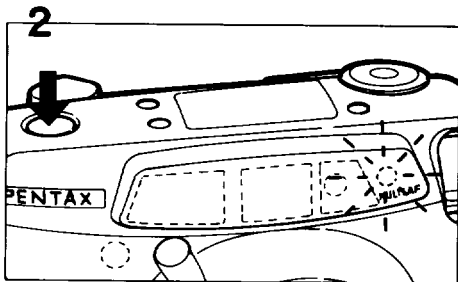

Focus on the subjects first by depressing the shutter release button fully. The shutter will be released in about 10 seconds. When the Self-Timer is working, the Self-Timer symbol (⊙) blinks on the LCD panel, and the Self-Timer lamp lights up. The lamp starts blinking 3 seconds before the shutter is released, letting you know when to smile.

#### Notes on the self-timer shooting

- If you are standing directly in front of the camera when starting the Self-Timer, the camera will be focused in you, not the main subjects. Be sure that you are behind, or next to the camera when starting the Self-Timer.
- To cancel the self-timer at any time after it's been activated, push the drive button or turn the main switch / mode dial.
- When you want to use the flash with the self-timer, ensure that the red lamp is lit indicating the flash has been charged before operating the self-timer.
- When the Bulb Mode is used in combination with the self-timer, a shutter speed of approx. 1/2 sec. is automatically selected.

## USING WIRELESS REMOTE CONTROL (OPTION)

If you have purchased the optional wireless remote control, read this section. The wireless remote control allows you to trip the shutter at a distance. The shutter will be released 3 seconds after the shutter release button on the Remote Control is pressed.

- Use a tripod when shooting with the wireless remote control.
- When the remote control is used to take pictures, the Single-Frame Mode can be used in combination with any of the exposure modes. The Self-Timer shooting mode cannot be used in this case.
- Use the remote control to take pictures in the Bulb Mode to avoid camera shake. While the remote control's shutter release button is held down, the shutter remains open up to a max. of 5 minutes.

Name of parts

Shutter release button

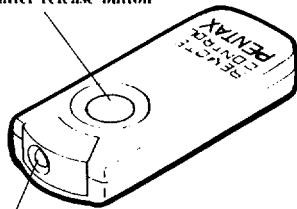

Remote control transmitter

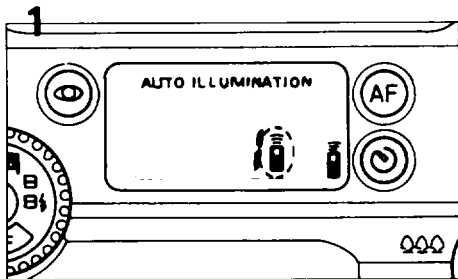

### Remote Control Shooting Mode

1 Depress the camera's drive button each time until (  ) symbol appears on the LCD panel.

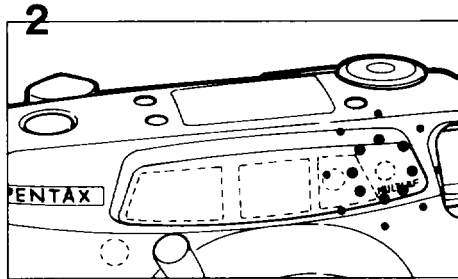

2 When the Remote Control Shooting Mode is set on the camera, the self-timer lamp on the front of the camera blinks slowly, indicating that you can take pictures with the aid of a remote control.

- If the shutter is released by the camera's release button, the picture will be taken in the ordinary shooting mode.
- When the camera is set in the Remote Control Shooting Mode and left unused for 5 minutes, the lens automatically retracts and Single-frame will be set.

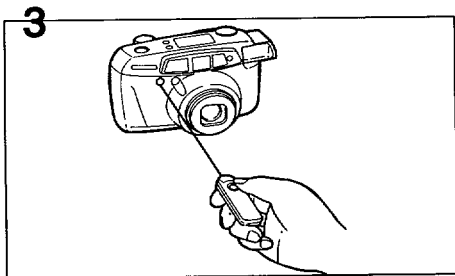

3 Compose the scene and frame the subject with the AF frame. Aim the remote control transmitter towards the remote control receiver on the camera, and then depress the remote control's shutter release button fully to release the shutter.

- The self-timer lamp blinks rapidly for 3 seconds and then the shutter is released.
- Focus cannot be locked when the remote control is in use. The subject framed in the AF frame will be in focus when the remote control's shutter release button is depressed.

**Operating Distance of the Wireless Remote Control from the camera's front: within approx. 5m(16.5ft) straight in front of the camera**

- The remote control may not work in a backlight situation. In this case, use the camera's shutter release button in the Self-Timer Mode to take pictures.
- The remote control does not work while the flash is being charged.

#### **Battery life on the Remote Control**

About 30,000 commands can be issued using the Remote Control. If the battery is exhausted, please have it replaced at your local Pentax Service center (there is a charge for this service).

## MULTI-EXPOSURE SHOOTING





Multi-Exposure Mode will disengage the film advance, letting you superimpose images on a single frame for fantastic illusions. Your imagination can produce striking creative effects.



36

### Procedure

- 1 Depress the drive button until the symbol (  ) appears on the LCD panel.
- 2 Depress the shutter release button to shoot an initial exposure. The film will not advance, the frame counter indication and (  ) blink on the LCD panel to indicate that you are in the Multi-Exposure Mode.
- 3 Recompose the frame, and depress the shutter release button to shoot the second shot, the film will advance and the Single Frame shooting will be restored.

### Notes:

- To exposure two or more, depress the drive button until the (  ) remains lit after the step 2 above, and then depress the shutter release button.
- The date will be exposed in step 3 above on the DATE model.



## INFINITY-LANDSCAPE SHOOTING



When you wish to take a sharp picture of a distant landscape or a distant subject through a window, the Infinity-Land Mode allows you to capture distant scenery with clarity.

Depress the AF mode button and (▲) appears on the LCD panel.

- (▲) will light up in the viewfinder when the shutter release button is depressed halfway down.
- (◉) will not light up in the viewfinder when the shutter release button is depressed halfway down.
- After the picture is taken by fully depressing the shutter release button, this mode is canceled.
- In this mode, the flash will not discharge when the main switch/mode dial is set at the (A) position even in dark light situations.

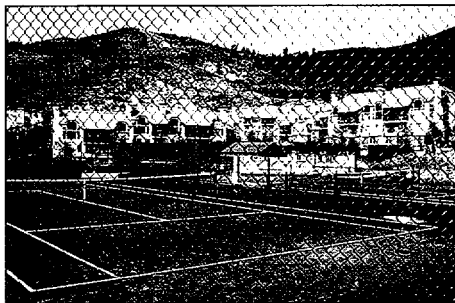

## SPOT AF SHOOTING

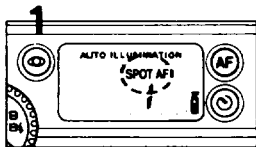

Select the Spot AF Mode to focus on a particular spot in the frame.

### 1 Switch the Spot AF Mode

Depress the AF mode button until (SPOT AF) appears on the LCD panel.



### 2 Focus on the subject

Focus on the subject with the Spot AF frame in the center of the viewfinder.

- When the main subject is off the Spot AF frame, use the focus lock technique. See page 39.

## FOCUS-LOCK SHOOTING

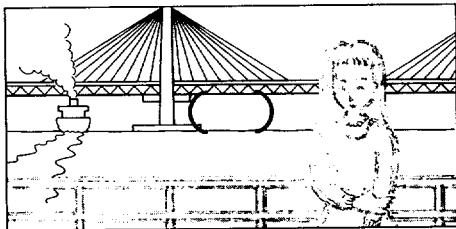

If you shoot without positioning the autofocus frame ( ( ) ) on the main subject as shown above, only the background will be in focus. When the main subject is off the autofocus frame in the center of the viewfinder, use the focus-lock technique. (Focus lock is the function to lock focus.)

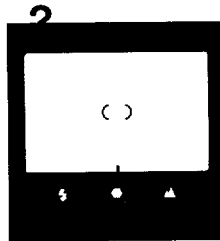
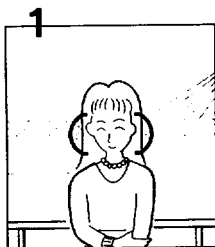

- 1 Focus on the subject with the autofocus frame ( ( ) ).
- 2 When the shutter release button is depressed halfway down, the green lamp in the viewfinder lights up and the exposure and focus are temporarily locked.

## HARD-TO-AUTOFOCUS-SUBJECTS

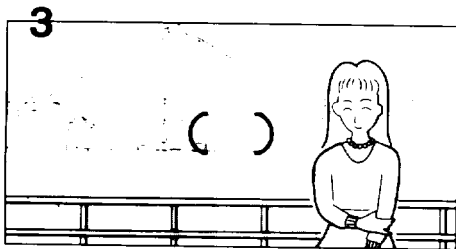

3 While depressing the shutter release button halfway, re-aim the camera or recompose the picture, then release the shutter.

**Note:**

- You can release focus lock simply by lifting your finger from the shutter release button.

The autofocus system is highly precise, but not perfect. Some subjects may not focus as you wish. In this case, use the focus-lock technique on another subject near the actual one and equidistant from the lens. Subjects which may fool the autofocus system include:

- a) Extremely low-contrast subjects such as a white wall or blue sky in the autofocus frame.
- b) Subjects which don't reflect much light in the autofocus frame.
- c) Subjects with horizontal lines or with finely complex or detailed patterns in the autofocus frame.
- d) Subjects which are moving too fast.
- e) Multiple subjects in foreground of the autofocus frame.
- f) Subjects positioned against reflected light or strong backlight or with extremely bright background.

## TAKING PANORAMA FORMAT PICTURE

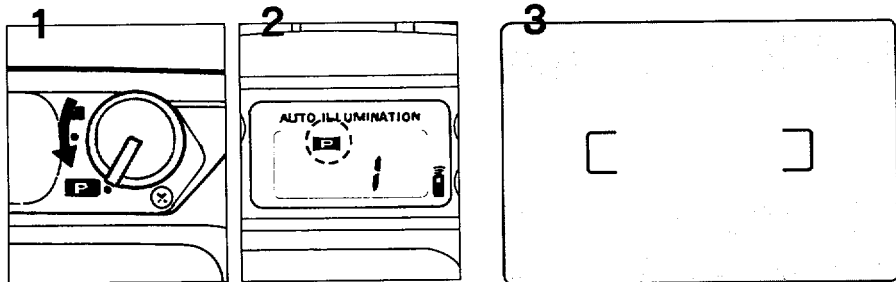

You can switch between the panorama format and standard format picture taking mode in the middle of the roll by moving the panorama lever. The panorama format picture allows horizontally positioned dynamic pictures to be taken (13x36mm on film).

### 1 Switching to the panorama format

Move the panorama lever to (P) to select the panorama format mode.

- When the picture frame is switched to panorama, the viewfinder switches to the horizontal panorama format frame.

2 (P) appears on the LCD panel.

### 3 Taking a panorama format picture

Compose the scene within the panorama format frame, and then fully depress the shutter release button to take a panorama format picture.

- When taking panorama format pictures in the close distance, the picture area in the viewfinder is automatically changed and compensated. Make sure to compose the scene within the compensated panorama format frame.



The mark “ ” indicates the position where the data and time are imprinted.

The **DATA MODEL** allows you to record **DATE** information in the panoramic mode in a similar manner to the standard picture taking mode. See “**DATE MODEL**” on page 44 for details. The dating unit automatically switches the **DATE** position between the standard and panorama according to the format mode selected.

## NOTES ON THE DEVELOPMENT OF PANORAMA FORMAT PICTURES

- With panorama format pictures, only the middle area of the frame is exposed. The number of exposures available in the panorama format is equivalent to that of the standard photo size.



- When developing the film, if you have taken only panorama format pictures on the entire roll of film, tell the clerk at the processing lab to develop the film with only the panorama format. If there are both panorama and standard format photographs on the film, ask the clerk to develop the film with both standard and panorama format.
- The development of panorama format pictures is a more time-consuming and expensive process than that of standard pictures. Please consult the processing lab for more details.
- Panorama format processing facilities differ depending on the area and requirements. Your local film processor or camera dealers will advise you on all the options to you.
- When the panorama format picture is printed with a standard size format, the black cropped areas will appear on the top and bottom of the picture.

## DATE MODEL

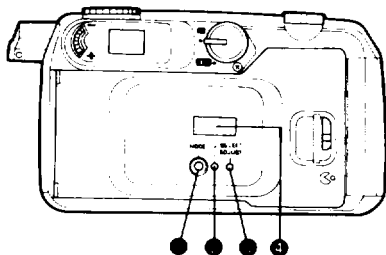

If you purchased the DATE model, read this section. The DATE model records dates up to the year 2019 on pictures.

### Switching the Mode

Press the MODE button ① with your finger, the mode on the LCD panel switches as shown in the chart.

### Notes:

- The data on the LCD panel ④ will be imprinted on the film.
- "----" indicates no data will be imprinted.
- "M" on the LCD panel indicates "Month".

Year Month Day

Day Hour Minute

Month Day Year

Day Month Year



\* The date in the picture above is simulated.



### Correcting the date

Use the strap clamp's protrusion to depress the SELECT and ADJUST buttons.



1. Depress the SELECT button ② to select the category of digits on the LCD panel you want to change blink.
  2. Depress the ADJUST button ③ to change digits of the specified category you chose with the SELECT button ②. Digits increase by one each time you depress the ADJUST button ③. Holding down the button will advance digits continuously.
  3. After the data has been adjusted, depress the SELECT button ②. The bar mark (—) appears on the LCD panel, indicating that data imprinting choices are possible.
- The blinking “:” allows precise fine-tuning of the internal clock to the beginning of a specified minute. To do so, depress the mode button ① until “Day-Hour-Minute” digits appear and then depress the SELECT button ② to make the “:” blink. Then depress the adjust button ③ in sync with a time signal.
  - If you release the shutter while the blinking data is being corrected, the data cannot be imprinted.

### Operational precautions

- The data on the LCD panel is imprinted on each frame you expose.
- “Year-Month-Day” and “Day-Hour-Minute” cannot be imprinted at the same time.
- As you release the shutter, the bar (—) mark on the display blinks for a few seconds, indicating the data has been imprinted.
- Move the panorama lever to the right or left to switch the imprint mode between panorama and standard.
- The dating unit automatically switches the imprint mode between the standard and panorama according to the format mode selected.
- If there is bright colored object in the corner of the picture where the data is imprinted, the data may be difficult to read. When composing your photographs, try to avoid brightly-colored subjects in that corner.

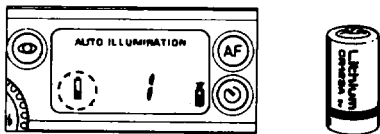
## BATTERY EXHAUSTION WARNING



When the battery is nearly exhausted, the battery symbol (  ) appears on the LCD panel to warn you. Replace the battery as soon as possible. When (  ) starts blinking, no operations can be performed.

### **Battery life (using 24-exposure film rolls):**

Approx. 10 rolls using flash 50% of the time (using the CR123A battery and under Pentax testing conditions). Actual battery life/performance may vary drastically depending on usage of Power Zoom, Flash and external conditions such as temperature and freshness of the battery.

### **Notes on replacing the battery:**

- Ensure that the power is off before replacing the battery.
- The battery is used by both the camera body and the data function on the DATE model to keep constant track of time. After the battery is replaced, correct the time and date. See page 45.
- The no. of exposed frames are memorized and unchanged even if the battery is replaced.

## INSTALLING / REPLACING BATTERY

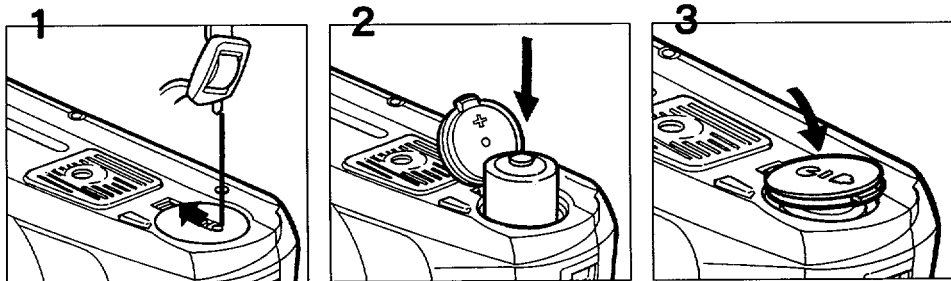

Ensure that the power is off before replacing the battery.

- 1 Open the battery chamber cover by pulling the cover lock in the direction of the arrow with the strap clamp's protrusion.
- 2 Insert one lithium battery with the plus/minus (+/-) sides matching the indications in the battery compartment.

3 Close the battery chamber cover. Ensure that the cover is locked with a click.

- If the battery is correctly loaded, the zoom lens moves slightly and the motor operates for a few seconds.
- On the DATE MODEL, the data is initialized when the battery chamber cover is opened. See page 45 for correcting the time and date.
- Use one 3V lithium battery CR-123A, DL-123A or the equivalent.

## TROUBLESHOOTING

What appears troublesome may be easily remedied. Here are some problems that may occur and their remedies.

Symptoms	Causes and Remedies
1. The shutter cannot be released.	<ul style="list-style-type: none"><li>• Is the main switch turned off? If so, turn it on. See page 8.</li><li>• Is the battery exhausted? Replace it or insert new battery if it is exhausted. See page 47.</li><li>• Is (L) blinking on the LCD panel? If so, the film has been used up. Insert a new roll. (See page 24.)</li></ul>
2. My printed pictures don't look very clear.	<ul style="list-style-type: none"><li>• Did you position the autofocus frame on your subject? See page 20.</li><li>• Did you obstruct the autofocus window with your fingers, hair or other object when you depress the shutter release button? See page 10.</li><li>• Is the autofocus window dirty? Wipe it off. See page 21.</li></ul>
3. Zoom lens retracted automatically.	<ul style="list-style-type: none"><li>• Did you leave the camera unused for over 3 minutes after the main switch was turned on? See page 8.</li><li>• When the camera is on and left unused for more than 5 minutes in the Remote Control shooting mode, the lens automatically retracts. See page 34.</li></ul>

Symptoms	Causes and Remedies
4. The Remote Control does not operate.	<ul style="list-style-type: none"> <li>The operable distance of the Remote Control is approx. 5m from the front. See page 35.</li> <li>The Remote Control may not operate in a backlit situation. See page 35.</li> <li>The flash is being charged. Wait until it fully charges. See page 35.</li> <li>Is the battery for the remote control exhausted? See page 35.</li> </ul>
5. The flash discharges, though it is not dark.	<ul style="list-style-type: none"> <li>The flash discharges automatically in a backlit situation. See page 23.</li> <li>Daylight sync mode has been set. See page 28.</li> </ul>
6. The (H) or (U) mark is displayed on the LCD panel.	<ul style="list-style-type: none"> <li>If either mark disappears when the zoom lever is moved, the camera is ready for use. The camera may be defective if either mark appears often.</li> </ul>



**Flash effective ranges other than ISO 100, 200 or 400 (Nega-color film used)**

ISO \ Lens	25	50	800	1600	3200
38mm (◆◆◆)	0.80-2.3m (2.6-7.5ft)	0.80-3.2m (2.6-10.5ft)	0.90*-13.0m (3.0*-42.6ft)	1.3*-18.0m (4.3*-59.0ft)	1.9*-26.0m (6.2*-85.3ft)
160mm (◆)	1.2-1.3m (3.9-4.3ft)	1.2-1.8m (3.9-5.9ft)	1.2-7.0m (3.9-23.0ft)	1.2-10.0m (3.9-32.8ft)	1.2-14.0m (3.9-45.9ft)

\* With high speed film, overexposure may occur at close range due to the film's high sensitivity.

## SPECIFICATIONS

<b>Type:</b>	35mm fully automatic lens-shutter with built-in zoom lens and auto flash
<b>Film:</b>	Auto film speed setting with 35mm perforated DX-coded film with ISO rating from 25-3200 (1EV step). Non-DX coded films are automatically set to ISO25
<b>Format:</b>	24x36mm (Approx. 13x36 in panorama format)
<b>Film loading:</b>	Auto film loading. Closing the back cover will automatically wind the film to first exposure.
<b>Film winding:</b>	Auto film winding (single-frame)
<b>Film rewinding:</b>	Auto film rewinding at the end of roll. Auto stop upon completion of rewinding. Rewinding time: approx. 25 sec. with 24-exposure film. Rewinding in mid-roll provided.
<b>Frame number:</b>	Automatic readout of successive frame numbers in ascending order when shooting, and descending order when rewinding.
<b>Lens:</b>	Pentax power zoom 38-160mm f/4.5-12.0 11 elements in 7 groups. Angle of view: 59° - 15.5°
<b>Focusing system:</b>	Pentax phase-matching passive five-point autofocus system. Autofocusing range: 1.2m (3.9ft) - infinity at Tele 160mm, 0.80m (2.6ft) - infinity at wide-angle 38mm. Maximum magnification: approx. 1/7.1X. Focus lock is provided. Infinity-landscape mode (focus is fixed to infinity). Focus aid illuminator is automatically illuminated in low light/ or hard-to-autofocus subject.
<b>Zooming:</b>	Electronic zoom
<b>Shutter:</b>	Programmed AE electronic shutter with speed approx. 1/400 - 2 sec. Bulb: 1/2 sec.-5 min. Electromagnetic release.
<b>Self-timer:</b>	Electronic red lamp indication. Approx. 10 sec. Cancellation after activation is possible.
<b>Viewfinder:</b>	Actual image zoom viewfinder with LCD indication, 83% of field of view ratio. Magnification: 0.41X (38mm WIDE) - 1.59X (160mm TELE), Diopter -3 to +1D, AF frame varies in accordance with focal length (blinking when subject is too close and/or hard-to-autofocus subject), Picture frame, Close distance compensation frame, Panorama format picture area, Green lamp lighting (○): in-focus signal Green lamp blinking: When subject is too close and/or hard-to-autofocus subject, Red lamp lighting (◐): Flash-ready status, Red lamp blinking: Flash being charged, (▲) lighting: Infinity-Landscape shooting.

<b>Exposure control:</b>	Programmed auto-exposure control with multi(6)-segment metering system. Range: EV10 - EV17 at 38mm WIDE, EV14.5 - EV19.5 at 160mm TELE in Auto or Daylight-Sync mode (ISO 400), EV5.0 - EV17 at 38mm, EV6.0 - EV19.5 at 160mm in Slow-Shutter-Speed mode (ISO 400), Automatic exposure compensation in a backlit situation.
<b>Multi-Exposure:</b>	Multiple exposure function provided.
<b>Flash:</b>	Slide-out flash with red-eye reduction mode, Automatic flash emission in low-luminance or a backlit situation, Flash ON = Day-light Sync/Slow-Shutter-Speed Sync (up to 2 sec.), Flash-OFF = Flash override, Bulb-Sync 1/2 sec. - 5min.
<b>Flash effective range:</b>	0.8 - 9.0m (38mm WIDE), 1.2-5.0m (160mm TELE) (ISO 400 film used).
<b>Flash recycling time:</b>	Approx. 5 sec. under Pentax testing conditions.
<b>Power source:</b>	One 3V lithium battery (CR-123A or the equivalent)
<b>Battery life:</b>	Approx. 10 rolls of 24 exposure film when 50% of shooting uses flash (under Pentax testing conditions)
<b>Battery exhaustion warning:</b>	(  ) appears on the LCD panel, Shutter is locked when (  ) is blinking.
<b>Size &amp; Weight:</b>	127.5(W) x 73(H) x 68(D)mm (5" x 2.9" x 2.7") 320g(11.3oz) without battery
<b>DATE MODEL</b>	
<b>Date mechanism:</b>	Crystal quartz controlled; LCD with digital clock, auto calendar up to 2019. Possible to imprint both standard and panoramic format frames.
<b>Imprinting mode:</b>	"Year, Month and Day", "Day, Hour and Minutes", "---- blank", "Month, Day and Year" or "Day, Month and Year".
<b>Size &amp; Weight:</b>	127.5 (W) x 73(H) x 71(D)mm (5" x 2.9" x 2.8") 330g(11.6oz) without battery
<b>REMOTE CONTROLL</b>	
<b>Remote control:</b>	Infrared wireless remote control, 3-seconds delay shutter release, Effective range: Closer than 5m when projected from the camera's front.
<b>Power source for Remote Control:</b>	One lithium battery CR1620 (replaced by Pentax Service facility)
<b>Size &amp; weight for Remote Control:</b>	22.0(W) x 50.0(L) x 9.5(D)mm (0.9" x 2.0" x 0.4"), 9g(0.3oz) including battery
<b>SPECIFICATIONS ARE SUBJECT TO CHANGE AT ANY TIME WITHOUT NOTIFICATION OR ANY OBLIGATION ON THE PART OF THE MANUFACTURER.</b>	

## WARRANTY POLICY

All Pentax cameras purchased through authorized bona fide photographic distribution channels are guaranteed against defects of material or workmanship for a period of twelve months from date of purchase. Service will be rendered, and defective parts will be replaced without cost to you within that period, provided the equipment does not show evidence of impact, sand or liquid damage, mishandling, tampering, battery or chemical corrosion, operation contrary to operating instructions, or modification by an unauthorized repair shop. The manufacturer or its authorized representatives shall not be liable for any repair or alterations except those made with its written consent and shall not be liable for damages from delay or loss of use or from other indirect or consequential damages of any kind, whether caused by defective material or workmanship or otherwise; and it is expressly agreed that the liability of the manufacturer or its representatives under all guarantees or warranties, whether expressed or implied, is strictly limited to the replacement of parts as herein before provided. No refunds will be made on repairs performed by non-authorized Pentad service facilities.

### **Procedure During 12-month Warranty Period**

Any Pentad which proves defective during the 12 month warranty period should be returned to the dealer from whom you purchased the equipment or to the manufacturer. If there is no representative of the manufacturer in your country, send the equipment to the manufacturer with postage prepaid. In this case, it will take a considerable length of time before the equipment can be returned to you owing to the complicated customs procedures required. If the equipment is covered by warranty, repairs will be made and parts replaced free of charge, and the equipment will be returned to you upon completion of servicing. If the equipment is not covered by warranty, regular charges of the manufacturer or of its representatives will apply. Shipping charges are to be borne by the owner. If your Pentax was purchased outside of the country where you wish to have it serviced during the warranty period, regular handling and servicing fees may be charged by the manufacturer's representatives in that country. Notwithstanding this, your Pentax returned to the manufacturer will be serviced free of charge according to this procedure and warranty policy.



In any case, however, shipping charges and customs clearance fees are to be borne by the sender. To prove the date of your purchase when required, please keep the receipts or bills covering the purchase of your equipment for at least a year. Before sending your equipment for servicing, please make sure that you are sending it to the manufacturer's authorized representatives or their approved repair shops, unless you are sending it directly to the manufacturer. Always obtain a quotation for the service charge, and only after you accept the quoted service charge, instruct the service station to proceed with the servicing.

The local warranty policies available from Pentax distributors in some countries can supersede this warranty policy. Therefore, we recommend that you review the warranty card supplied with your product at the time of purchase, or contact the PENTAX distributor in your country for more information and to receive a copy of the warranty policy.

#### STATEMENT OF FCC COMPLIANCE

This device complies with Part 15 of the FCC Rules. Operation is subject to the following two conditions : (1) This device may not cause harmful interference, and (2) this device must accept any interference received, including interference that may cause undesired operation.

Changes or modifications not approved by the party responsible for compliance could void the user's authority to operate the equipment. This equipment has been tested and found to comply with the limits for a Class B digital device, pursuant to part 15 of the FCC Rules. These limits are designed to provide reasonable protection against harmful interference in a residential installation. This equipment generates, uses and can radiate radio frequency energy and, if not installed and used in accordance with the instructions, may cause harmful interference to radio communications. However, there is no guarantee that interference will not occur in a particular installation. If this equipment does cause harmful interference to radio or television reception, which can be determined by turning the equipment off and on, the user is encouraged to try to correct the interference by one or more of the following measures :

- Reorient or relocate the receiving antenna.
- Increase the separation between the equipment and receiver.
- Consult the dealer or an experienced radio/TV technician for help.

This Class B digital apparatus meets all requirements of the Canadian Interference-Causing Equipment Regulations.

## NAMES OF WORKING PARTS II

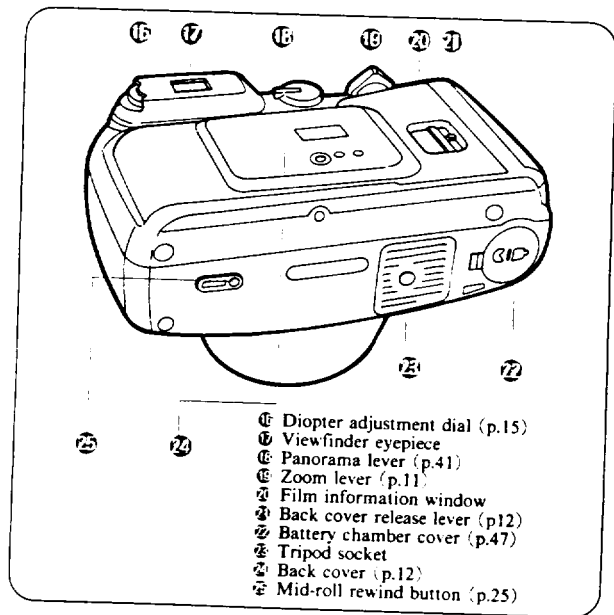

54

FOR YOUR REFERENCE, KEEP THIS CARD WITH THE CAMERA.

## PENTAX IQ Zoom 160

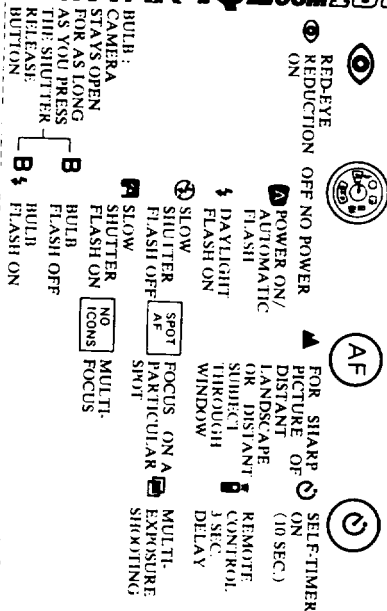

FOR YOUR REFERENCE, KEEP  
THIS CARD WITH THE CAMERA.

## PENTAX® IQZ<sup>zoom</sup>160

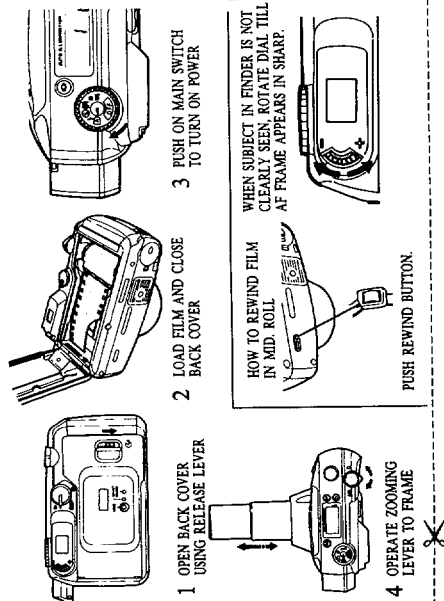

## LCD PANEL

All indications will not actually appear simultaneously as shown.

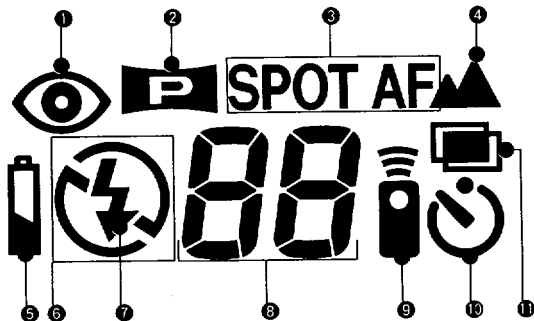

- 1** Red-eye Reduction
- 2** Panorama Mode (p.41)
- 3** Spot AF Mode (p.37)
- 4** Infinity-Landscape Mode (p.37)
- 5** Battery Exhaustion Warning (p.46)
- 6** Flash OFF (p.29,30)
- 7** Flash ON (p.28,29,30)
- 8** Exposure Counter (p.14)
- 9** Remote Control Shooting Mode (p.34)
- 10** Self-Timer (p.31)
- 11** Multi-Exposure Mode (p.36)



**Asahi Optical Co., Ltd.** 11-1, Nagata-cho 1-chome, Chiyoda-ku, Tokyo 100, JAPAN

**Pentax Europe n.v.** Weiveldlaan 3-5, 1930 Zaventem, BELGIUM

**Pentax GmbH.** Julius-Mosseler-Strasse, 104, D-22527 Hamburg, GERMANY

**Pentax U.K. Limited** Pentax House, Heron Drive, Langley Slough SL3 8PN, U.K.

**Pentax France S.A.** 12/14, rue Jean Poulmarch, 95106 Argenteuil Cedex, FRANCE

**Pentax Benelux B.V.** (for Netherlands) Spinveld 25, 4815 HR Breda, NETHERLANDS

(for Belgium & Luxemburg) Weiveldlaan 3-5, 1930 Zaventem, BELGIUM

**Pentax (Schweiz) AG** Industriestrasse 2, 8305 Dietlikon, SWITZERLAND

**Pentax Scandinavia AB** P.O. Box 650, 75127 Uppsala, SWEDEN

**Pentax Corporation** 35 Inverness Drive East, Englewood, Colorado 80112, U.S.A.

**Pentax Canada Inc.** 3131 Universal Drive, Mississauga, Ontario L4X 2E5, CANADA

## Free Manuals Download Website

<http://myh66.com>

<http://usermanuals.us>

<http://www.somanuals.com>

<http://www.4manuals.cc>

<http://www.manual-lib.com>

<http://www.404manual.com>

<http://www.luxmanual.com>

<http://aubethermostatmanual.com>

Golf course search by state

<http://golfingnear.com>

Email search by domain

<http://emailbydomain.com>

Auto manuals search

<http://auto.somanuals.com>

TV manuals search

<http://tv.somanuals.com>