

**PENTAX™**

Digital Camera

# Optio 430RS Optio 330RS Operating Manual

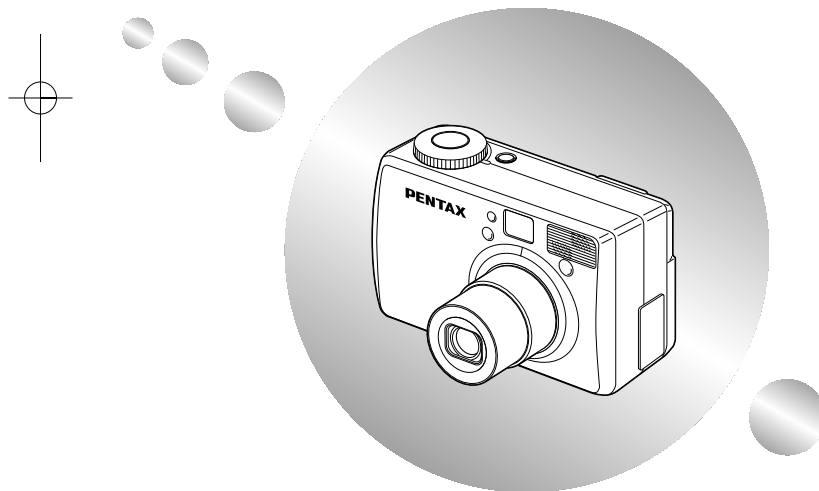

To ensure the best performance  
from your camera, please read  
the Operating Manual before  
using the camera.

Thank you for buying the Pentax Digital Camera. Please read this manual before using the camera in order to get the most out of all the features and functions. Keep this manual safe, as it can be a valuable tool in helping you to understand the camera's capabilities.

#### Regarding copyrights

Images taken using the Optio 430RS/330RS that are for anything other than personal enjoyment cannot be used without permission according to the rights as specified in the Copyright Act. Please take care, as there are even cases where limitations are placed on taking pictures even for personal enjoyment during demonstrations, industrial enterprise or as items for display. Images taken with the purpose of obtaining copyrights also cannot be used outside the scope of use of the copyright as laid out in the Copyright Act, and care should be taken here also.

#### Regarding trademarks

- CompactFlash and CF are trademarks of SanDisk Corporation.
- PENTAX is a trademark of Asahi Optical Co., Ltd.
- Optio is a trademark of Asahi Optical Co., Ltd.
- All other brands or product names are trademarks or registered trademarks of their respective companies.
- The USB driver uses software developed by inSilicon Corporation.
- This product supports PRINT Image Matching II. When used in combination, PRINT Image Matching II enabled printers and software, help photographers to produce images more faithful to their intentions. PRINT Image Matching is a trademark of Seiko Epson Corporation.

This manual is common to Optio 430RS and Optio 330RS. In this manual the features specific to Optio 430RS and Optio 330RS are indicated as "430RS" and "330RS" respectively.

The illustrations and the display screen of the LCD monitor in this manual may be different from the actual product.

**To customers who already have Optio 430/330**  
**Please read page 87 before connecting the Optio 430RS/330RS to your PC.**

### FOR SAFE USE OF YOUR CAMERA

Sufficient attention has been paid to the safety of this product but please pay particular attention to the warnings indicated by the following symbols during use.

 **Warning** These symbols indicate that it is possible that the user may experience serious difficulties if the warnings are not heeded.

 **Caution** These symbols indicate that it is possible that the user may experience minor or middling difficulties or physical difficulties if the warnings are not heeded.

 **Warning:**

- Do not attempt to take the camera apart or remodel the camera. High voltages are present within the camera, and there is therefore a danger of electric shocks.
- If the inside of the camera should become exposed as a result of, for example, the camera being dropped, please do not under any circumstances touch such exposed portions, as there is a danger of receiving an electric shock.
- Wrapping the strap of the camera around your neck is also dangerous, please take care that small children do not hang the strap around their necks.
- Use an AC adapter that are of the power and voltage specified for exclusive use with this product. The use of an AC adapter other than that specified exclusively for use with this product may cause fire or electric shocks.
- If the camera emits smoke or a strange smell, or in the event of any other irregularity, stop using the camera immediately, remove the battery or disconnect the AC adapter and contact your nearest Pentax service center. Continued use of the camera may result in fire or electric shock.
- Discontinue use of the AC adapter during thunderstorms. This can cause a fire or electrical shock.

 **Caution:**

- Never try to disassemble, short or recharge the battery. Also, do not dispose of the battery in fire, as it may explode.
- Remove the battery from the camera immediately if it becomes hot or begin to smoke. Be careful not to burn yourself during removal.
- Some portions of the camera heat up during use, so please take care, as there is a risk of low temperature burns if such portions are held for long periods of time.
- If the batteries become old and begin to leak, handle with extreme care.
- If any of the battery leakage should come in contact with your eyes, do not rub them. Flush your eyes with clean water and get medical attention immediately.
- If any of the battery leakage should come in contact with skin or clothes, wash the affected areas thoroughly with water.

## Care to be Taken During Handling

- Do not clean the product with organic solvents such as thinner or alcohol benzene.
- Places of high temperature and humidity should be avoided. Particular care should be taken regarding vehicles, which can become very hot inside.
- Storing the camera where pesticides and chemicals are handled should be avoided. Remove from case and store in a well-ventilated place to prevent the camera from becoming moldy during storage.
- Do not use the camera where it may come in contact with rain, water or any other liquid, because the camera is not weather, water, or liquid resistant. Should the camera get wet from rain, splashing water, or any other liquid, wipe it off immediately with a dry soft cloth.
- Ensure that the camera is not subjected to substantial vibrations, shocks or pressure. Place the camera on a cushion for protection when the camera is subjected to the vibrations of a motorbike, car, or ship, etc.
- The liquid crystal display will become black at temperatures of approximately 60°C (140°F) but will return to normal when normal temperatures are returned to.
- The response speed of the liquid crystal display becomes slow at low temperatures. This is due to the properties of the liquid crystal and is not a fault.
- Remove dust from the lens and viewfinder using a blower or clean off dust using a lens brush.
- Periodic checks are recommended every 1 to 2 years in order to maintain high-performance.
- When the camera has not been used for a long time, confirm that it is still working properly, particularly prior to taking important pictures (such as at a wedding or during travelling). Pentax is not responsible for consequential damages (costs incurred as a result of taking pictures, loss of benefits that were to be obtained through taking pictures) arising from failure of this product.
- If the camera is subjected to rapid temperature changes, condensation may form on the inside and outside of the camera. Therefore put the camera in a bag or plastic bag, and take the camera out when the difference in temperature has subsided.
- The temperature range in which the camera can be used is 0°C to 40°C (32°F to 104°F).
- Avoid contact with garbage, dirt, sand, dust, water, toxic gases, salt, etc. as this may cause damage to the camera. If rain or drops of water get onto the camera, please wipe dry.
- Please refer to "Precautions When Using a CF Card" (p.15) regarding the CompactFlash (CF) card.
- Be sure to use the D-Li2 rechargeable lithium ion battery provided for this camera. If you use any other battery the camera may be damaged or malfunction.

### To users of this camera

- There is a possibility that recorded data may be erased or that the camera may not function correctly when used in surroundings such as installations generating strong electromagnetic radiation or magnetic fields.
- The liquid crystal panel used in the LCD display is manufactured using extremely high precision technology. Although the level of functioning pixels is 99.99% or better, you should be aware that 0.01% or fewer of the pixels may not illuminate or may illuminate when they should not. However, this has no effect on the recorded image.

2

## Contents

FOR SAFE USE OF YOUR CAMERA .....	1
Care to be Taken During Handling .....	2
Contents .....	3
Contents of the Operating Manual .....	5
Checking the Contents of the Package .....	6
Names of Parts .....	7
Names of Operating Parts .....	8
<b>Getting Started .....</b>	<b>9</b>
Attaching the Strap .....	9
Powering the Camera .....	10
Charging the Battery .....	10
Installing the Battery .....	11
Using the AC Adapter (optional) .....	13
Installing or removing the CF Card .....	14
Initial Settings .....	16
Setting the Display Language .....	16
Setting the Home Town .....	17
Setting the D.S.T. Mode .....	17
Setting the Date and Time .....	18
<b>Quick Start .....</b>	<b>20</b>
Taking Still Pictures .....	20
Playing Back Still Pictures .....	22
Playing Back Images .....	22
Playing Back Previous or Next Images .....	23
How to Use the CF Card .....	24
<b>Common Operations .....</b>	<b>26</b>
Turning the Camera On and Off .....	26
Changing the Mode .....	27
Using the Button Functions .....	28
Capture Mode .....	28
Playback Mode .....	29
Using the Menus .....	30
How to Use the Menus .....	30
Menu List .....	32
<b>Taking Pictures .....</b>	<b>34</b>
Displaying Shooting Information (Display Mode) .....	34
Taking Pictures .....	35
Taking Still Pictures in Auto Mode (Auto Mode) .....	35
Taking Pictures Manually (Manual Exposure Mode) .....	36
Taking Dark Scenes (Night-Scene Mode) .....	38
Continuous Shooting .....	39
Using the Remote Control Unit (optional) .....	40
Taking Movie Pictures (Movie Picture Mode) .....	42
Using the Zoom .....	44
Using the Self-Timer .....	46
Taking Stereo Pictures (3D Image Mode) .....	47
Taking Pictures with Digital Filters (Digital Filter Mode) .....	52
Taking Pictures at a Specified Interval (Interval Shooting) .....	54
Shooting Time-lapse Movies (Time-lapse Movie) .....	56
Setting the Shooting Functions .....	57
Adjusting the Viewfinder .....	57
Selecting a Focus Mode .....	58
EV Compensation .....	61
Changing the Shutter Speed/Aperture Setting .....	61
Selecting the Flash Mode .....	62
Selecting the Recorded Pixels .....	63
Selecting the Quality Levels .....	64

3

Adjusting the Color Balance according to Lighting (White Balance).....65  
 Changing the AF Area (Focusing Area) .....67  
 Setting the Light Metering Range to Determine the Exposure (AE Metering) .....68  
 Setting the ISO Speed (ISO Speed).....69  
 Setting the Instant Review Time (Instant Review) .....70  
 Setting the Image Sharpness (Sharpness) .....71  
 Setting the Color Saturation (Saturation) .....72  
 Setting the Image Contrast (Contrast) .....73  
 Saving the Settings (Memory).....74  
 Saving the Menu Items (Mode Memory) .....74

**Playback/Erasing .....76**  
 Playing Back Images .....76  
 Playing Back Still Pictures .....76  
 Zoom Display .....76  
 Playing Back Movie Pictures .....78  
 Displaying Shooting Information (Display Mode) .....79  
 Nine-image Display .....80  
 Erasing Images .....81  
 Erasing a Single Image .....81  
 Erasing All Images .....82  
 Protecting Images from Deletion (Protect) .....83  
 Setting the Printing Service .....84  
 Printing Single Image .....84  
 Printing All Images .....86  
 Viewing Images with Windows PC .....87  
 About the included software .....87  
 System environment .....87  
 Installing the software .....88  
 Connecting the camera and PC .....98  
 Viewing images on your PC .....99  
 Disconnecting the camera from your PC .....100  
 Viewing Images with Macintosh .....102  
 About the included software .....102  
 System environment .....102  
 Installing the software .....103  
 Connecting the camera and your Macintosh .....104  
 Viewing images on your Macintosh .....105  
 Disconnecting the camera from your Macintosh .....105

**Editing Images/Settings .....106**  
 Editing Images .....106  
 Copying the Image .....106  
 Trimming Images .....108  
 Changing the Image Size (Resize) .....110  
 Camera Settings .....112  
 Formatting .....112  
 Sounding the Alarm at a Set Time .....113  
 Setting the Beep .....115  
 Changing the Start-up Screen .....116  
 Setting the Date Style .....117  
 Changing the Date/Time .....117  
 Setting the World Time .....118  
 Changing the Display Language .....119  
 Powersaving Function (Sleep Timeout) .....120  
 Auto Power Off Function .....120  
 Quick Delete .....121  
 Quick Enlargement .....121  
 Resetting to Default Settings (Reset) .....122



**Appendix .....124**  
 List of City Names .....124  
 Messages .....125  
 Troubleshooting .....127  
 Main Specifications .....130  
 Optional Accessories .....132  
 WARRANTY POLICY .....133

## Contents of the Operating Manual

This Operating manual contains the following chapters.

- **Getting Started** .....  
 This chapter explains what you need to do after purchasing the camera and before you start taking pictures. Be sure to read it and follow the instructions.
- **Quick Start** .....  
 This chapter explains the simplest way to take pictures and play back images. Use it if you want to start taking pictures straightaway. It also tells you how to use the CF card.
- **Common Operations** .....  
 This chapter explains common operations such as the functions of the mode dial and buttons, and how to use the menus. For more details, refer to the respective [Taking Pictures], [Playback/Erasing] and [Editing Images/Settings] chapters.
- **Taking Pictures** .....  
 This chapter explains the various ways of capturing images and how to set the relevant functions.
- **Playback/Erasing** .....  
 This chapter explains how to play back images and how to delete images.
- **Editing Images/Settings** .....  
 This chapter explains how to edit captured images and how to set the camera-related functions.
- **Appendix** .....  
 This tells you about the messages displayed on the LCD monitor and what to do in the event of trouble.

The meanings of the symbols used in this Operating manual are explained below.

	indicates the reference page number for an explanation of the related operation.
	indicates information that is useful to know.
	indicates precautions to be taken when operating the camera.

### Checking the Contents of the Package



Camera  
Optio 430RS  
or  
Optio 330RS



Rechargeable lithium-ion  
battery D-LI2

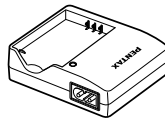

Battery charger  
D-BC2

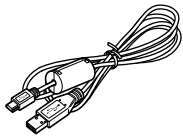

USB cable I-USB6

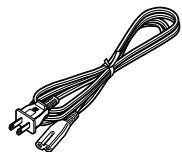

AC plug cord D-CO2\*

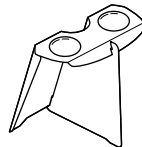

3D Image Viewer  
O-3DV1

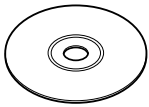

Software (CD-ROM)  
S-SW5

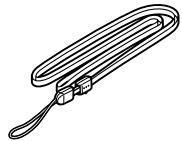

Strap  
O-ST5



Operating Manual  
this manual

**\* Type of AC plug cord**

D-CO2A Australia / D-CO2B United Kingdom / D-CO2E Europe / D-CO2H Hong Kong / D-CO2J Japan / D-CO2K Korea / D-CO2U North America, Canada

### Names of Parts

#### Front

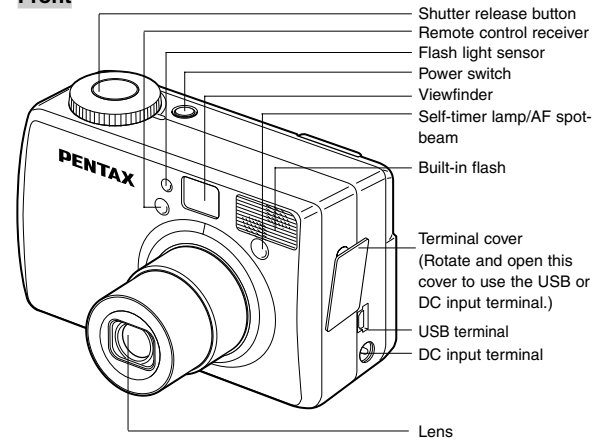

#### Back

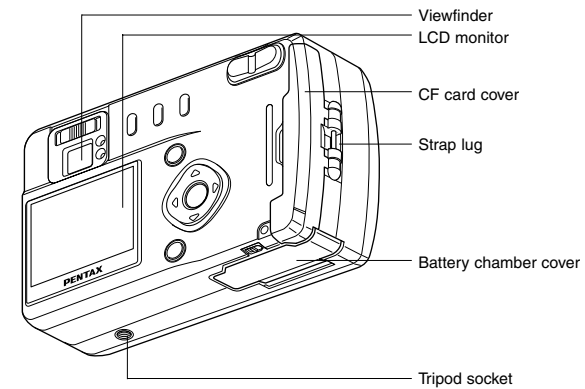

### Names of Operating Parts

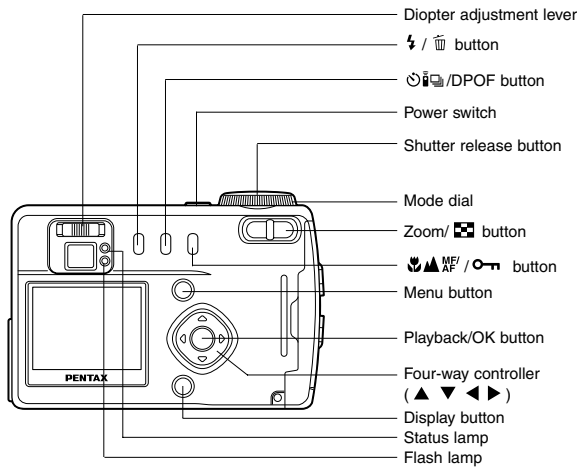

#### ● Guide indications

A guide to available button operation is displayed on the LCD monitor during operation. The buttons are indicated as shown below.

Four-way controller (▲)	▲	Zoom button	
Four-way controller (▼)	▼	Display button	 
Four-way controller (◀)	◀	DPOF button	
Four-way controller (▶)	▶	button	
Menu button		button	
Playback/OK button		Shutter release button	

### Getting Started Attaching the Strap

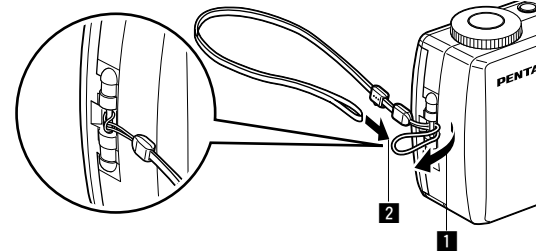

Pass the narrow end of the strap through the strap lug and pass the other end through the loop.

## Powering the Camera

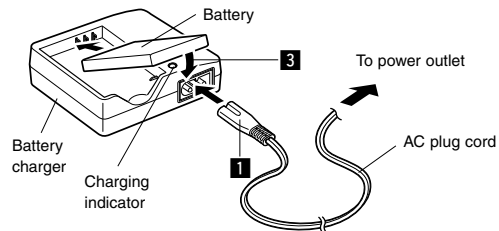

### Charging the Battery

When using the camera for the first time or when the [Battery depleted.] message is displayed, charge the battery.

- 1** Connect the AC plug cord to the battery charger.
- 2** Plug the AC plug cord into the power outlet.
- 3** Place the battery in the charger with the label facing down. The charging indicator lights red while the battery is charging and changes to green when charging is completed.
- 4** When charging is completed, remove the battery from the battery charger.



- The time required for full charge is about 120 minutes maximum. The appropriate ambient temperature range for charging the battery is 0°C-40°C.
- The charging time may vary depending on the ambient temperature and charging conditions.
- When the battery reaches the end of its service life, the time that the camera can be operated becomes shorter even when the battery is fully charged. In this event, replace the battery.



- Always charge the battery after purchasing or when it has not been used for a long time.
- Do not use the charger to charge batteries other than the D-LI2 rechargeable lithium ion battery as the charger may overheat or be damaged.
- If the battery is inserted correctly but the charging indicator fails to light, the battery may be faulty. Replace with a new battery.

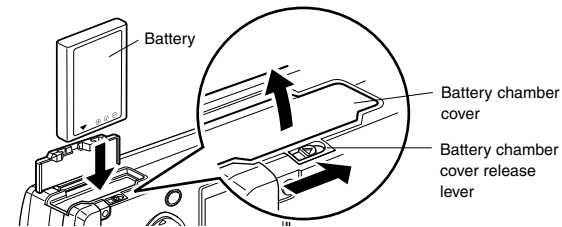

### Installing the Battery

Install the battery provided. When using the camera for the first time, charge the battery before installing.

- 1** Slide the battery chamber cover release lever in the direction indicated by the arrow to open the battery chamber cover.
- 2** Insert the battery with the label towards back of camera .
- 3** Close the battery chamber cover.



If you intend to use the camera continuously for a long period, use of the AC adapter D-AC2 (optional) is recommended. (p.13)



- Be sure to use the D-LI2 rechargeable lithium ion battery provided for this camera. If you use any other battery the camera may be damaged or malfunction.
- Do not open the battery chamber cover or remove the battery when the camera is turned on.
- If you do not intend to use the camera for a long time, remove the battery.
- If the camera is left without the battery for a long time, the date setting will be reset.
- Insert the battery correctly. If the battery is incorrectly oriented, it may cause malfunction.

### ● Approximate Operating Time (when fully charged)

Number of recordable images: Approx. 250 (with the flash fired for 50% of the shots. LCD monitor ON)

Playback time : Approx. 150 min.





\* The above table is based on Pentax measuring conditions and may vary depending on capture mode and shooting conditions.



Performance of the battery may deteriorate in low temperatures.

### ● Battery Level Indicator

You can check the battery level by the  symbol displayed on the LCD monitor.

- |                                                                                   |              |                                                             |
|-----------------------------------------------------------------------------------|--------------|-------------------------------------------------------------|
|  | (lit green)  | : Adequate power remains.                                   |
| ↓                                                                                 |              |                                                             |
|  | (lit green)  | : Battery is running low.                                   |
| ↓                                                                                 |              |                                                             |
|  | (lit yellow) | : Battery is running very low.                              |
| ↓                                                                                 |              |                                                             |
|  | (lit red)    | : Battery is exhausted.                                     |
| ↓                                                                                 |              |                                                             |
| [Battery depleted.]                                                               |              | : After the message is displayed, the camera will turn off. |

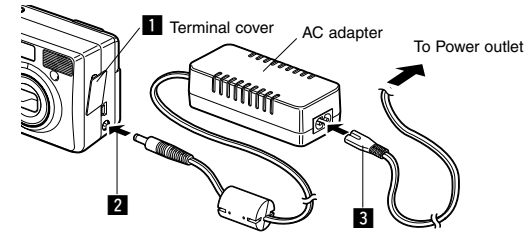
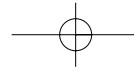

### Using the AC Adapter (optional)

If you intend to use the LCD monitor for a long time or connect the camera to a PC, use of the AC adapter D-AC2 (optional) is recommended.

- 1 Make sure that the camera is turned off before opening the terminal cover.**
- 2 Connect the DC terminal on the AC adapter to the DC input terminal on the camera.**
- 3 Connect the AC plug cord to the AC adapter.**
- 4 Plug the AC plug cord into the power outlet.**



- Make sure that the camera is turned off before connecting or disconnecting the AC adapter.
- Make sure that the AC plug cord and connecting cord are inserted securely. If the cord becomes disconnected while you are taking pictures, the data may be lost.
- When using the AC adapter D-AC2, be sure to read the operation manual accompanying the AC adapter.

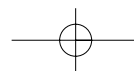



## Installing or removing the CF Card

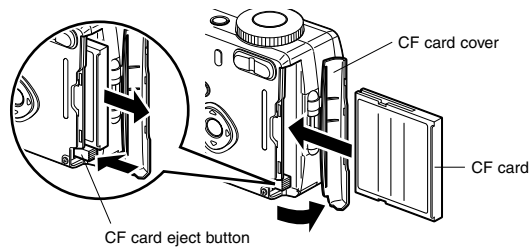

Captured images are recorded on the CompactFlash (CF) card. Make sure that the camera is turned off before inserting or removing the CF card (optional). When no card is inserted, the images are recorded in the camera's built-in memory (11MB).

### Installing the Card

- 1** Open the CF card cover.
- 2** Orient the card with the surface of the card having the ▲ symbol facing towards the lens and with the pin-connector edge of the card towards the slot and insert fully.
- 3** Close the CF card cover.

### Removing the Card

- 1** Open the CF card cover.
- 2** Press the CF card eject button and remove the card.
- 3** Close the CF card cover.



- If you open the CF card cover when the camera is turned on, a warning beep will sound and the camera will turn off automatically.
- If you open the CF card cover while recording an image on the CF card, the recording operation will be terminated (the image will not be saved).

### Precautions When Using a CF Card

- Make sure that the camera is turned off before opening the CF card cover.
- Care should be taken if you remove the CF card immediately after using the camera, as the card may be hot.
- Do not open the CF card cover or turn the camera off while data is being recorded on the card or transferred to another device as this may cause the data to be lost or the card to be damaged.
- Do not bend the CF card or subject it to violent impact. Keep it away from water and store away from high temperature.
- Be sure to format unused CF cards or CF cards that have been used on another camera. Refer to "Formatting" (p.112) for instructions on formatting.
- Never open the CF card cover during formatting as this may cause the card to be damaged and become unusable.
- Data recorded on a CF card with the Optio 430RS/330RS cannot be played back accurately on the Optio 430/330/230. Similarly, data recorded with the Optio 230 cannot be played back accurately on the Optio 430RS/330RS.
- The data on the CF card may be erased in the following circumstances. Pentax does not accept any liability for data that is erased
  - when the CF card is mishandled by the user.
  - when the CF card is exposed to static electricity or electrical interference.
  - when the card has not been used for a long time.
  - when the card is ejected, the AC adapter is disconnected or the battery is removed while the data on the card is being accessed (when the status lamp and flash lamp are blinking green and red).
- The CF card has a limited service life. If it is not used for a long time, the data on the card may become unreadable. Be sure to make a backup of important data on a PC.
- Avoid using or storing the card where it may be exposed to static electricity or electrical interference.
- Avoid using or storing the card in direct sunlight or where it may be exposed to rapid changes in temperature or to condensation.

## Initial Settings

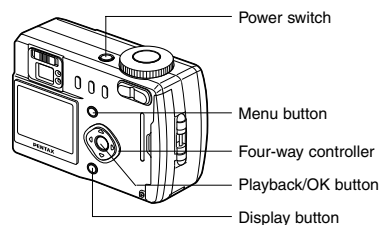

If the initial settings screen appears when you turn the camera on, follow the procedure below to set the display language, Home Town, DST, and current date and time. If the date and time appear at the bottom right of the LCD monitor when you turn the camera on for the first time, follow the instructions for "Changing the Date/Time" (p.117) to set the correct date and time.

### Setting the Display Language

You can choose the language in which the menus, error messages, etc. are displayed from the following: English, French, German, Spanish, Italian and Japanese.

- 1 Turn the camera on.
- 2 Use the four-way controller (◀ ▶) to select the display language. The default setting is English.
- 3 Press the four-way controller (▼). The screen for setting the next item will be displayed.

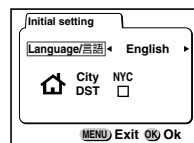

You can change the setting after it has been made. Refer to "Changing the Display Language" (p.119).

### Setting the Home Town

You can choose the city (Home Town) in which you will use the camera.

- 1 Press the four-way controller (◀ ▶) to select the desired city (Home Town).



- 2 Press the four-way controller (▼). The screen for setting the next item will be displayed.



- See p.124 for the list of cities and corresponding code names.
- You can change the setting after it has been made. Refer to "Setting the World Time" (p.118).

### Setting the D.S.T. Mode

You can choose whether or not to display the D.S.T (Daylight Saving Time) mode.

- 1 Use the four-way controller (◀ ▶) to select  (On) or  (Off). The default setting is  (Off).
- 2 Press the four-way controller (▼). The screen for setting the next item will be displayed.



You can change the setting after it has been made. Refer to "Setting the World Time" (p.118).

## Setting the Date and Time

Set the current date and time.

- 1** Use the four-way controller (▲ ▼) to change the month.

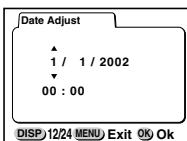

- 2** Press the four-way controller (▶).  
▲ and ▼ will be displayed above and below the day.

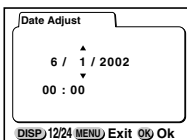

- 3** Use the four-way controller (▲ ▼) to change the day and press the four-way controller (▶).  
▲ and ▼ will be displayed above and below the year.

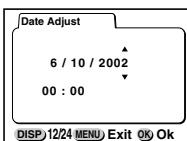

- 4** Repeat Step **3** to change the [year] [hour] and [minutes].

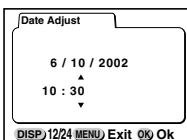

- 5** Use the Display button to select the 12-hour or 24-hour display format.

- 6** When you have finished the settings, press the Playback/OK button when the clock reaches 00 seconds. The screen confirming the settings will be displayed and the camera is ready to take a picture.



- When the initial settings screen is displayed, you can cancel the setting operation and switch to Capture mode by pressing the MENU button. If this is done, the initial settings screen will be displayed next time you turn the camera on.
- You can change the settings after they have been made. Refer to "Changing the Date/Time" (p.117).

**Quick Start**

**Taking Still Pictures**

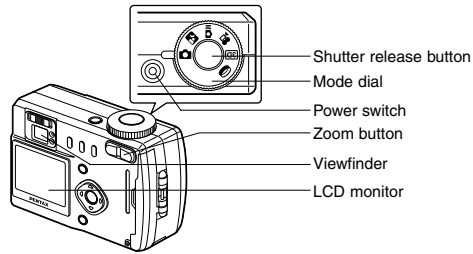

For the simplest procedure to take still pictures:  
The flash fires automatically depending on the light conditions.

**1 Press the power switch.**

The camera will turn on.

**2 Set the mode dial to .**

**3 Turn the LCD monitor on.**  
Press the Display button to display the shooting screen on the LCD monitor.

The focus frame in the middle of the LCD monitor indicates the zone of automatic focusing. You can change the size of the subject by pressing the Zoom button.

makes the subject bigger.

makes the subject smaller.

You can check the size of the subject by looking through the viewfinder.

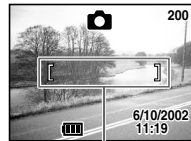

Focus frame

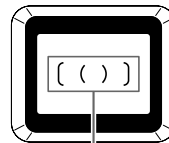

Focus frame

Changing the focus range and position p.58  
Stopping the flash firing automatically p.62  
Displaying shooting information p.34

**4 Press the shutter release button.**

The image will be displayed on the LCD monitor for 0.5 seconds (Instant Review) and recorded on the CF card or in the built-in memory when no card is inserted. (The green and red lamps on the right of the viewfinder blink alternately while the image is being recorded.)

**Using the Shutter Release Button**

The shutter release button works in a two-step action.

**● Press halfway**

When the shutter release button is pressed lightly (halfway), the focus, exposure and white balance are locked. The shutter speed and aperture settings are only displayed when the shutter release button is pressed lightly (halfway).

You can find the following information on the LCD monitor, the status lamp and the flash lamp.

**① Focusing area**

If the subject is in focus, the frame will light green. If the subject is not in focus, the frame will not appear.

**② Flash symbol**

The flash symbol indicates the status of the flash when the shutter release button is pressed.

**Status lamp & Flash lamp (on the right of the viewfinder)**

status	Status lamp (green)	Flash lamp (red)
lit	Subject is in focus	Flash is charged
blink	Subject is not in focus	Flash is charging

**● Pressed down fully**

The picture is taken.

**Instant Review**

The Instant Review default setting is 0.5 seconds. During this time you can delete the image by pressing the button (The Delete screen will be displayed.), and selecting [Delete].

Setting the Instant Review Time p.70

**Quick Start**

**Playing Back Still Pictures**

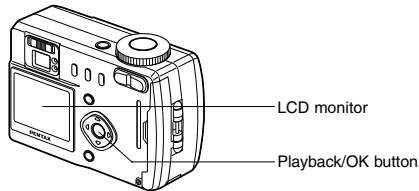

**Playing Back Images**

You can display the still picture.

**1 Press the Playback/OK button after taking a picture.**

The image taken will be displayed on the LCD monitor. During this time you can erase the image by pressing the button (The Delete screen will be displayed.), selecting [Delete], and then pressing the Playback/OK button.

Press the Playback/OK button again or press the shutter release button halfway to return to shooting status.



- You can enlarge the image displayed on the LCD monitor by pressing the zoom button.
- When the screen is changed to the playback screen, the image with the largest file number will be displayed first.

Playing Back Still Pictures p.76

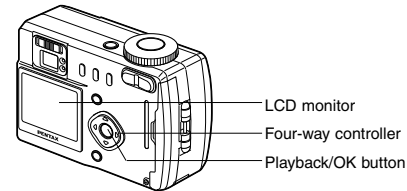

**Playing Back Previous or Next Images**

Still images can be played back one at a time, proceeding either forward or backward.

**1 Press the Playback/OK button after taking a picture.**

An image will be displayed on the LCD monitor.

**2 Press the four-way controller ( ).**

displays the previous image.

displays the next image.

During this time you can erase the image by pressing the button (The Delete screen will be displayed.), selecting [Delete], and then pressing the Playback/OK button. Press the Playback/OK button again or press the shutter release button halfway to return to shooting status.



- In the case of movie pictures, the first frame will be displayed.
- If there are no images stored, the [No image] message will be displayed.

## Quick Start

### How to Use the CF Card

When the CF card is inserted into the camera, images taken are recorded on the card. You can view the images recorded on the card on the camera itself, transfer them to your PC and print them out.



#### Viewing images on the camera

One of the advantages of a digital camera is that it enables you to view your pictures immediately after you have taken them. You can check the composition and brightness and take the picture again if you are not satisfied.



Playing Back Still Pictures  p.76

### Viewing images on a PC

You only need to install the USB driver the first time. After that, you can view recorded images and edit them on the PC just by connecting the camera to the PC with the USB cable and downloading the images. Or you can remove the CF card from the camera and transfer the data to your PC using a card reader. If you use a laptop computer, you can transfer the image data by fitting the CF card into the card adapter and inserting the card adapter into the card slot.

Viewing Images with Windows PC  p.87

Viewing Images with Macintosh  p.102



### Printing images by a printing service

Prints of images recorded on the CF card can be ordered in the same way as with conventional photographs by taking the CF card to a store that performs printing. The number of prints can be specified and dates can be included in the prints if DPOF (Digital Print Order Format) is set before taking the CF card to a **store that performs DPOF printing**.

Setting the Printing Service  p.84



## Common Operations

## Turning the Camera On and Off

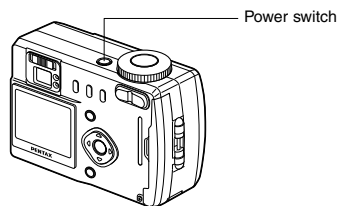

Use the power switch to turn the camera on and off.

**1 Press the power switch.**

The camera will turn on.  
When the camera is turned on, the lens cover opens and the lens extends.  
Press the power switch again to turn the camera off.

## Changing the Mode

Capture mode is for taking pictures and Playback mode is for playing back or erasing images. Press the Playback/OK button to change the mode between Capture mode and Playback mode. Pressing the Playback/OK button halfway during Playback mode also moves the camera to Capture mode.

## Capture Mode

	Auto mode	Most of the settings are made automatically by the camera when a picture is taken.	p.20, 35
	Night-scene mode	This mode is for taking dark scenes such as night views.	p.38
	Manual exposure mode	You can set the aperture and shutter speed manually.	p.36
	Movie picture mode	This mode is for taking moving images.	p.42
	3D image mode	This mode is for taking 3D pictures.	p.47
	Digital filter mode	Various color filters including red, blue and green can be used for taking pictures.	p.52

**1 Turn the mode dial so that the mark is on or .**

**2 Press the Playback/OK button or the shutter release button halfway in Playback mode.**

## Playback Mode

	Playback mode	This mode is for playing back recorded images.	p.76
--	---------------	------------------------------------------------	------

**1 Press the Playback/OK button in Capture mode.**

## Using the Button Functions

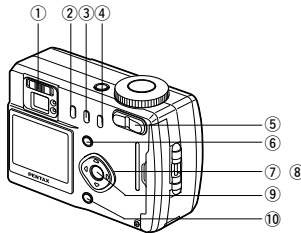

### Capture Mode

- ① **Diopter adjustment lever**  
Adjusts the viewfinder for optimum clarity. ( p.57)
- ② **Flash button**  
Changes the flash mode. ( p.62)
- ③ **Shooting mode button**  
Changes the shooting mode as follows.  
Using the Self-timer ( p.46), Using the Remote Control Unit ( p.40), Continuous Shooting ( p.39), Interval Shooting ( p.54)  
\* When the Capture mode is set on , Continuous Shooting mode will be skipped.
- ④ **M/AF button**  
Changes the focus mode. ( p.58)
- ⑤ **Zoom button**  
Changes the size of the subject. ( p.44)
- ⑥ **Menu button**  
Displays the active menus in Capture mode. ( p.32, p.33)
- ⑦ **Four-way controller (◀▶)**  
Changes the EV compensation in , , mode. ( p.61),  
Changes the shutter speed in mode. ( p.36), Changes the slim rate in mode. ( p.52)
- ⑧ **Four-way controller (▲▼)**  
Adjusts the focus in MF mode. ( p.59), Changes the aperture value in mode. ( p.36), Selects the type of filter in mode ( p.52).
- ⑨ **Playback/OK button**  
Changes the mode from Capture to Playback, or selects the menu item. ( p.27, p.30)
- ⑩ **Display button**  
Changes the information displayed on the LCD monitor. ( p.34)

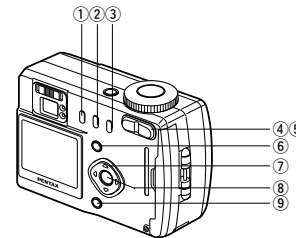

### Playback Mode

- ① **Delete button**  
Deletes the image. ( p.81)
- ② **DPOF button**  
Sets the print service. ( p.84)
- ③ **Erasure button**  
Protects the image from erasure. ( p.83)
- ④ **Zoom button**  
Changes the size of the image displayed on the LCD monitor. ( p.76)
- ⑤ **Nine-image button**  
Displays nine images at once. ( p.80)
- ⑥ **Menu button**  
Displays the active menus in Play mode. ( p.32, p.33)
- ⑦ **Four-way controller (◀▶)**  
Displays images one by one. ( p.23)
- ⑧ **Playback/OK button**  
Changes the mode from Playback to Capture, or selects the menu item. ( p.27, p.30)  
Ends zoom display or nine-image display. ( p.76, p.80)
- ⑨ **Display button**  
Changes the information displayed on the LCD monitor. ( p.79)



## Using the Menu

When you press the Menu button, the menus are displayed on the LCD monitor. You can set shooting functions, save the values set for shooting when the power is off, and change the camera settings on these menus.

### How to Use the Menu

When you are making settings from a menu, a guide to operation is displayed on the LCD monitor.

- 1 Press the Menu button.**  
The menu screen will be displayed. The selected area will be displayed in a green frame.
- 2 Press the four-way controller (◀ ▶).**  
Use the four-way controller (◀ ▶) to select the menu screen.
- 3 Use the four-way controller (▲ ▼) to select an item.**  
Use the four-way controller (▲ ▼) to move the frame up or down.
- 4 Use the four-way controller (◀ ▶) to change the setting.**
- 4' If there is a Select screen, use the four-way controller (▶) to move to the Select screen.**  
When you have finished making the settings, press the Playback/OK button to return to the menu.
- 5 Press the Playback/OK button.**  
The settings will be saved and the screen will return to capture or playback status.



- If you press the Menu button and leave the menu screen, any changes to setting will not be saved.
- Even if you press the Playback/OK button and leave the menu screen, if you remove the battery before turning off the camera or do not otherwise turn off the camera correctly, any changes to setting will not be saved.

### Example of menu operation

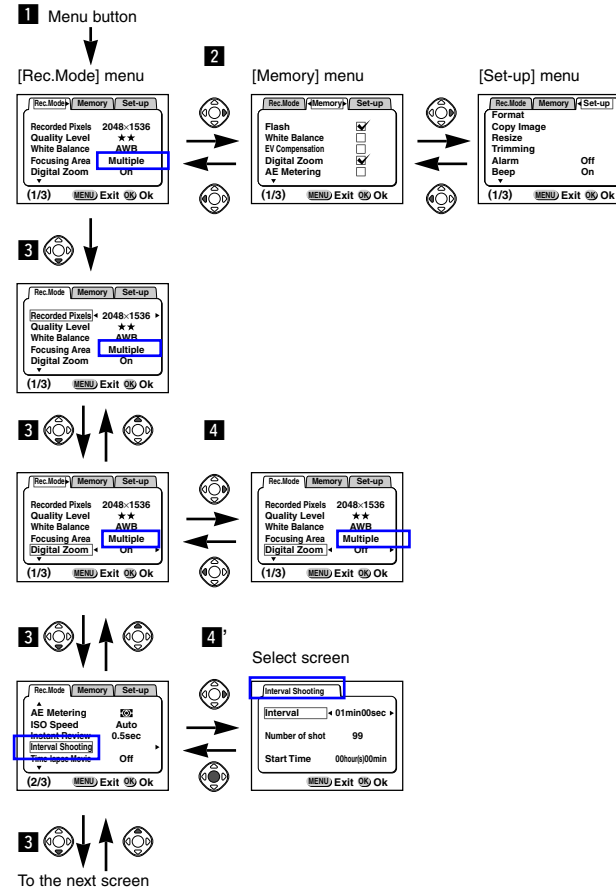

If you press the shutter release button halfway to leave the menu screen and move the camera to Capture mode, any changes to the setting will not be saved.

## Menu List

### ● [Rec.Mode] Menu

Item	Description	Default Setting	Reference
Recorded Pixels	For selecting the size of recorded pixels.	2240 × 1680 (430RS) 2048 × 1536 (330RS)	p.63
Quality Level	For selecting the image compression rate.	★★	p.64
White Balance	For adjusting the color balance according to lighting.	AWB	p.65
Focusing Area	For changing the Area of the autofocus.	Multiple	p.67
Digital Zoom	For taking digital zoom pictures.	On	p.45
AE Metering	For setting the metering method to determine the exposure.		p.68
ISO Speed	For setting the ISO speed.	Auto	p.69
Instant Review	For setting the instant review time.	0.5sec	p.70
Interval Shooting	For shooting at the specified interval of time.	Off	p.54
Time-lapse Movie	For shooting at a delayed frame rate (images are played back in an effect of fast forward).	Off	p.56
Applied Photo Mode	For setting the applied photo mode to take a 3D picture.	Parallel Mode	p.47
Sharpness	For setting the sharpness.	Normal	p.71
Saturation	For setting the saturation.	Normal	p.72
Contrast	For setting the contrast.	Normal	p.73

### ● [Memory] Menu

This menu is for selecting whether the settings are saved when the camera is turned off.

Refer to p.74 for the items that can be set.

## Active Menus in Capture/Playback Mode

### ● [Set-up] Menu

Item	Description	Default Setting	Reference
Format	For formatting the built-in memory or CF card	–	p.112
Copy Image	For copying images from the built-in memory to the CF card and vice versa.	–	p.106
Resize	For changing the image size.	–	p.110
Trimming	For trimming the image.	–	p.108
Alarm	For sounding an alarm at a specific time.	Off	p.113
Beep	For adjusting the beep sound when a button is pressed	On	p.115
Start-up Screen	For setting the screen appearing first when the power is turned on.	On	p.116
Date Style	For setting the date style	Set according to the Language default setting	p.117
Date Adjust	For adjusting the date and time	01/01/2002	p.117
World Time	For setting the world time	Off	p.118
Language	For changing the language in which menus and messages are displayed	English	p.119
Sleep Timeout	For setting the power-saving function	1min	p.120
Auto Power Off	For turning off the power automatically.	3min	p.120
Quick Delete	When this option is turned on, the Delete screen is displayed with [Delete] or [All Images] selected.	Off	p.121
Quick Enlargement	For playing back images at the maximum zoom size with the Zoom button pressed only once.	Off	p.121
Reset	For returning the camera settings to defaults	–	p.122

## Taking Pictures Displaying Shooting Information (Display Mode)

### Display On

Shooting information is displayed.

- ① Flash mode ② Shooting mode
- ③ Focus mode ④ Capture mode
- ⑤ AF frame ⑥ Remaining images
- ⑦ Date & time ⑧ Battery symbol

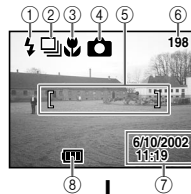

### Histogram Display

The brightness distribution is displayed.

The x-axis shows the brightness (darkest at the left end and brightest at the right end) and the y-axis shows the pixel numbers.

- ① Histogram ② Recorded pixels
- ③ Quality level ④ White balance
- ⑤ AE metering ⑥ ISO speed

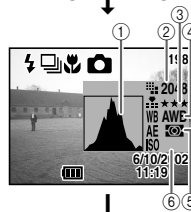

### Display Off

No shooting information is displayed.

- Only the AF frame is displayed in auto focus mode.
- If there is any change in the battery level, the battery symbol is displayed.
- If any of the modes are changed such as Flash mode, the mode you have changed is displayed for a few seconds.

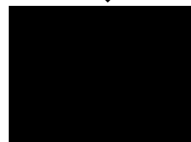

### LCD Monitor Off

The LCD monitor is turned off.

Saving the Display Mode p.74

Display On



When using the AC adapter, the battery level indicator is not displayed on the LCD monitor.



LCD Monitor Off cannot be set in Movie Picture, 3D Image and Digital Filter modes.  
When you turn off the LCD monitor, the digital zoom is turned off even if it has been enabled.

## Taking Pictures

When the CF card is installed, all images will be recorded on the CF card. When the CF card is not installed, the images will be recorded in the camera's built-in memory.

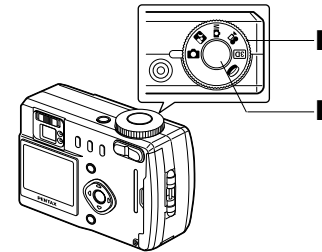

### Taking Still Pictures in Auto Mode (Auto Mode)

By setting the mode dial to , most of the settings will be made automatically by the camera when a picture is taken.

- 1** Set the mode dial to in Capture mode.
- 2** Press the shutter release button.  
The picture will be taken.

Using the Shutter Release Button p.21

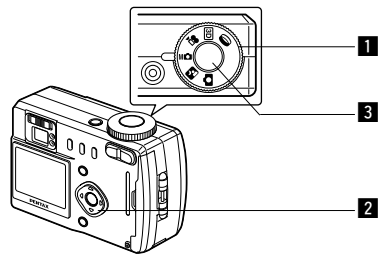

### Taking Pictures Manually (Manual Exposure Mode)

You can set the shutter speed and aperture manually.

**1** Set the mode dial to **M** in Capture mode.

**2** Use the four-way controller to change the shutter speed and aperture.

- Four-way controller (▶): Decrease the shutter speed
- Four-way controller (◀): Increase the shutter speed
- Four-way controller (▲): Decrease the aperture value
- Four-way controller (▼): Increase the aperture value



Aperture Shutter speed

If the combination of shutter speed and aperture do not give an appropriate exposure, a warning will be displayed.

(lit)	If the exposure difference from the appropriate exposure is between -2.0EV and -0.3EV,  will light, and if between +0.3EV and +2.0EV,  will light and the level will be displayed.
(blinking)	If the picture is underexposed,  will blink, and if overexposed,  will blink.
(blinking)	If the exposure cannot be measured,  will blink.

**3** Press the shutter release button.

The picture will be taken at the set shutter speed and aperture settings.

Playing Back Images p.76



The shutter speed and aperture settings will be saved when the camera is turned off.



- Exposure compensation is not available in this mode.
- When the focus mode is set to manual, the four-way controller (▲ ▼) becomes the manual focus button and the aperture setting cannot be changed.
- You cannot select [Auto] or [Auto + Red-eye reduction] flash mode.

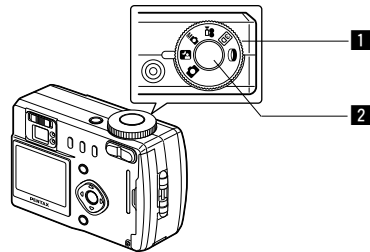

### Taking Dark Scenes (Night-Scene Mode)

The appropriate settings are made automatically for taking dark scenes such as night views.

- 1** Set the mode dial to  in Capture mode.
- 2** Press the shutter release button.  
The picture will be taken.

Using the Shutter Release Button  p.21  
Playing Back Images  p.22





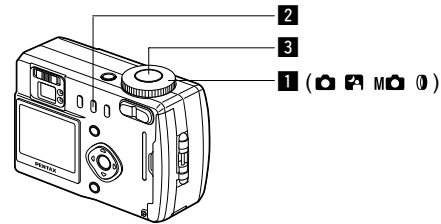
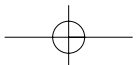
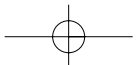



As the shutter speed becomes slow in night-scene mode, camera shake should be avoided.



### Continuous Shooting

Pictures are taken continuously while the shutter release button is pressed.

- 1** Set the mode dial to    or  in Capture mode.
- 2** Press the  button to display  on the LCD monitor.  
The mode will change to Continuous Shooting mode.



- 3** Press the shutter release button.  
Pictures will be taken continuously while the shutter release button is pressed. Shooting stops when you take a finger off from the shutter release button.

Playing Back Images  p.22



- You can continue shooting until the CF card or built-in memory is full.
- The interval will vary according to the [Recorded Pixels] and [Quality Level] setting.



- The flash will not fire in Continuous Shooting mode.
- Continuous shooting is not available for Movie Picture and 3D Image modes.



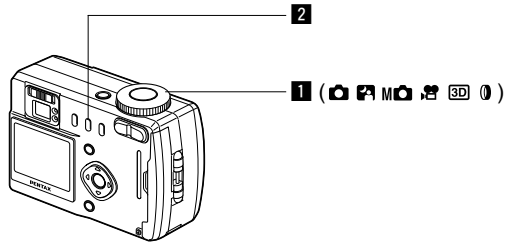

### Using the Remote Control Unit (optional)

You can take pictures using the remote control F (optional).

- 1** Set the mode dial to or in Capture mode.
- 2** Press the button to display on the LCD monitor.  
The self-timer lamp will blink and the camera is ready to take pictures.
- 3** Press the shutter release button on the remote control unit.  
The self-timer lamp will blink rapidly and the picture will be taken after approximately three seconds.

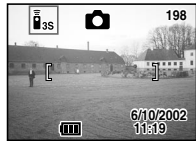

Playing Back Images p.76



- The buttons on the camera can be used in the same way.
- Please ensure that the remote control unit is no more than 5 meters away from the front of the camera.
- To take a picture immediately after pressing the shutter release button on the remote control unit, press the button in step 2 to display on the LCD monitor.
- When the digital zoom function is enabled, the digital zoom can not be operated with the remote control unit, but the digital zoom can be operated by pressing the Zoom button on the camera. However, the camera will revert to optical zoom mode by pressing the Zoom button on the remote control unit.
- The powersaving function can be operated (the self-timer lamp will also go off).

Taking Pictures

### Remote control unit battery service life

Up to approximately 30,000 signals can be sent to the camera from the remote control unit. Contact your nearest Pentax service center when battery replacement becomes necessary.

### Zoom on the remote controller

The zoom can be changed using the remote control E (optional). If you press the Zoom button on the remote control unit, the zoom will switch from [Wide] to [Tele] to [Middle].



[Wide] edge [Tele] edge

Taking Pictures

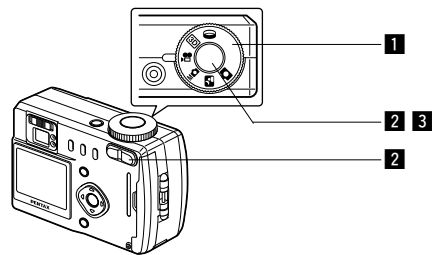

### Taking Movie Pictures (Movie Picture Mode)

This mode enables you to take moving images with no sound. The maximum length of one motion picture is 30 seconds.

**1 Set the mode dial to in Capture mode.**

The following information will be displayed on the LCD monitor.

- ① Flash Off
- ② Movie Picture mode
- ③ Remaining shooting time
- ④ Remaining number of sets

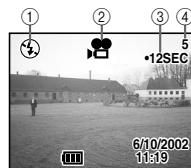

**2 Press the shutter release button.**

Shooting will start.

You can change the size of the image using the zoom button.

- makes the image bigger
- makes the image smaller

**3 Press the shutter release button.**

Shooting will end.

The remaining shooting time will be displayed.

### Keeping the shutter release button pressed

If you keep the shutter release button pressed for more than one second, pictures will be taken for as long as you keep the button pressed. Shooting stops when you take a finger off from the shutter release button.

Playing Back Movie Pictures p.78



- The flash will not fire in Movie Picture mode.
- Continuous shooting is not possible in Movie Picture mode.
- The LCD monitor cannot be turned off in Movie Picture mode.

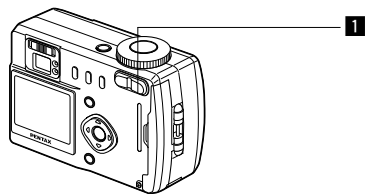

### Using the Zoom

You can use the zoom to take pictures in Tele or Wide mode.

- 1 Press the Zoom button in Capture mode.**

- ▲ makes the subject larger
- ▼▼▼ makes the subject smaller

When the digital zoom function is disabled, you can take pictures at up to 3x magnification using the optical zoom.

When the digital zoom is enabled, you can enlarge the subject to a maximum magnification equivalent to 6x.

Digital zoom symbol

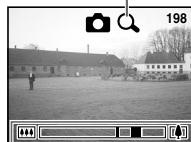

Zoom bar

Saving the zoom position p.74



When you turn off the LCD monitor, the digital zoom is turned off even if it has been enabled.

### Enabling/Disabling the Digital Zoom Function

- 1 Press the Menu button.**  
The [Rec.Mode] menu will be displayed.
- 2 Press the four-way controller (▼) to select [Digital Zoom].**
- 3 Use the four-way controller (◀ ▶) to select [On] or [Off].**
- 4 Press the Playback/OK button.**  
The camera is ready to take a picture.

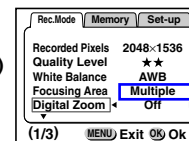

When you turn off the LCD monitor, the digital zoom is turned off even if it has been enabled.

Saving the Digital Zoom Function Setting p.74



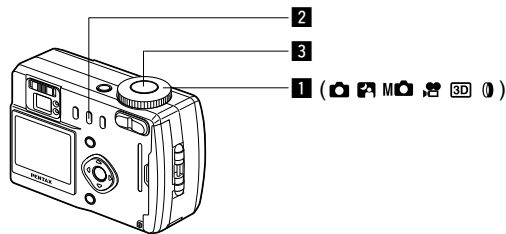

### Using the Self-Timer

The picture will be taken ten seconds after the shutter release button is pressed.

- 1** Set the mode dial to or in Capture mode.
- 2** Press the button to display on the LCD monitor.
- 3** Press the shutter release button. The self-timer is started and the self-timer lamp lights. The picture will be taken approximately three seconds after the self-timer lamp starts to blink.

If you turn the LCD monitor on, the second count will be displayed.

Playing Back Images p.22

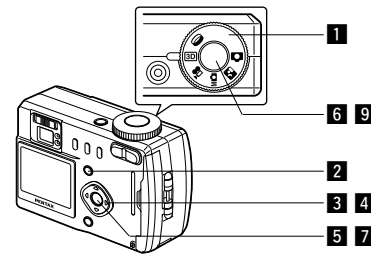
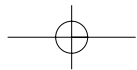
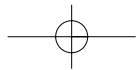

### Taking Stereo Pictures (3D Image Mode)

You can take 3D pictures using the LCD monitor and view them by the parallel method or cross method (p.49). If you print out the 3D pictures and look at them through the 3D image viewer provided, the image will appear in three dimensions.

- 1** Set the Mode dial to in Capture mode.
- 2** Press the Menu button. The [Rec. Mode] menu will be displayed.
- 3** Press the four-way controller () to select [Applied Photo Mode].
- 4** Use the four-way controller () to select [Parallel Mode] or [Cross Mode].

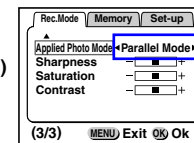

To view the picture with the 3D image viewer, select [Parallel Mode]. You can also view it without the image viewer.

- 5** Press the Playback/OK button. The LCD monitor screen is divided in two. The left half screen is for taking the first picture.
- 6** Take the first picture while watching the capture guide. Hold the camera so that the subject is in the center of the left half screen, and press the shutter release button.

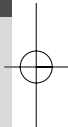
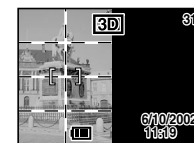

The image of the first picture is displayed to the left half screen of the LCD monitor, and the right half screen is for taking the second picture.

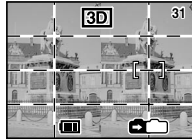

**7 Move the camera to the right without changing your stance.**

**8 Take the second picture while watching the capture guide.**

Hold the camera so that the subject is in the center of the right half screen, and press the shutter release button.

**9 Press the Playback/OK button.**

The first and second images are displayed to the left and right screens respectively.



- To cancel the 3D Image mode, change the 3D Image mode to another Capture mode.
- A clear three-dimensional effect will not be achieved if the two images are taken in widely different positions (heights) or are not straight. When taking a person, you are recommended to ask your model to stay as still as possible and to take the second picture as quickly as you can. It is easier to take the pictures if you use a tripod or appropriate base.
- As a guide, the camera should be moved about 1/40 of the distance between the camera and the subject. For example, if the subject is 3m away, the distance the camera should be moved will be  $3m \div 40 = 7.5cm$ .

However, as the way people see three-dimensional images differs from person to person, there is no need to be too concerned. Refer to the table below for a simple guide to how far to move the camera.

Distance to subject	0.1 m	0.3 m	0.5 m	1 m	3 m	5m
Camera movement	0.5 cm	1 cm	1.5 cm	2.5 cm	7.5 cm	13 cm

**● Viewing 3D pictures by the parallel method and cross method**

As our eyes are positioned about 6~7cm apart, there is a very slight deviation between what we see with our right eye and what we see with our left eye. The difference is processed by our brain to produce a three-dimensional image. This principle is applied to taking and viewing 3D pictures.

3D pictures can be viewed by the parallel method where the left and right lines of vision are virtually parallel, as when looking at a distant scene, or the cross method where the left and right lines of vision are crossed, as when you cross your eyes. A certain amount of practice may be necessary to view 3D pictures without using the viewer.

**● How to Assemble the 3D Image Viewer**

Assemble the 3D image viewer supplied with the camera as shown below.

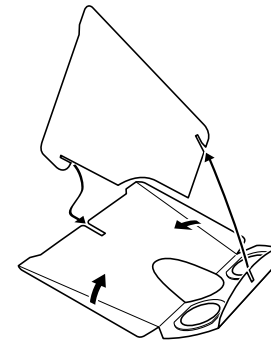

● How to view 3D pictures using the 3D image viewer

Print out the pictures so that they are about 11cm or 12cm wide and place the divider of the 3D image viewer in the middle of the two.

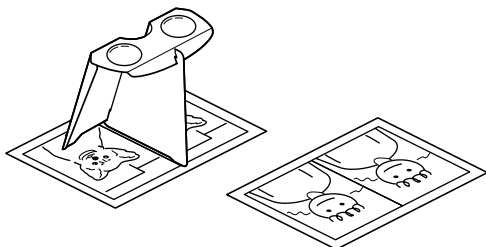

Transfer the images with a PC or Macintosh  p.87 or p.102



As the distance between the left and right eyes differs from person to person, some people may have difficulty obtaining a three-dimensional effect even when looking at prints that are the same size. It may be especially difficult if the pictures are very large or very small. Try different sizes until the right effect is achieved.



- Never look at the sun through the 3D image viewer.
- Do not leave the 3D image viewer where it is exposed to direct sunlight as this may lead to fire.

● Example of a 3D picture



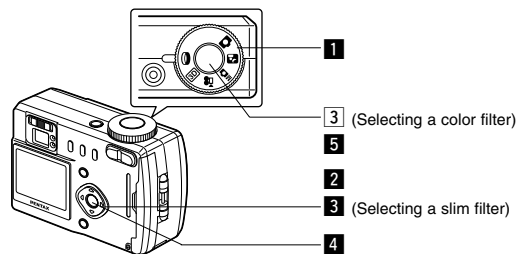

### Taking Pictures with Digital Filters (Digital Filter Mode)

Digital filters include the color filters and a slim filter which elongates the subject vertically or horizontally.

#### ● Color filters

Eight colors, black and white, sepia, red, pink, violet, blue, green and yellow, are provided for the color filters. When you select a color filter in the Digital Filter mode, the display on the LCD monitor is filtered with the selected color, and the pictures are taken in that color.

#### ● Slim filter

By selecting slim filter, subjects can be photographed elongated vertically or horizontally in 8 steps.

- 1** Set the Mode dial to **0** in Capture mode.
- 2** Use the four-way controller ( **◀ ▶** ) to select a digital filter you want to use.

#### When you selected a color filter:

- 3** Press the shutter release button.  
The picture will be taken.

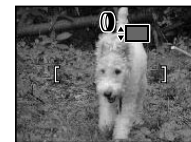

#### When you selected the slim filter:

- 3** Use the four-way controller ( **◀ ▶** ) to set the slim rate.  
Four-way controller ( **▶** ) :  
Elongates the subject vertically  
Four-way controller ( **◀** ) :  
Elongates the subject horizontally
- 4** Press the Playback/OK button.
- 5** Press the shutter release button.  
The picture will be taken.

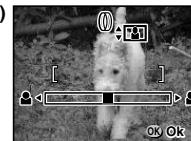

- Digital Zoom cannot be used while the slim filter is selected.
- To change the slim rate, select another filter once, and then select the slim filter again and set the slim rate.
- If you set a slim rate other than zero (0), only the picture zone displayed on the LCD monitor is recorded as an image.

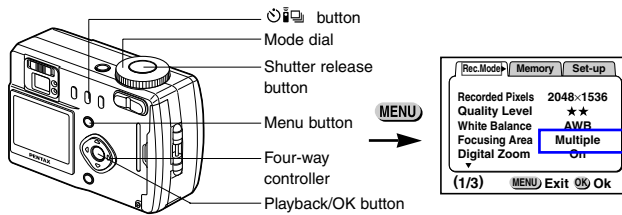

### Taking Pictures at a Specified Interval (Interval Shooting)

Still pictures can be taken automatically at a specified interval.

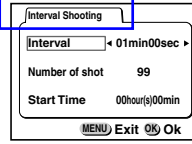
- 1 Set the Mode dial to or in Capture mode.**
- 2 Press the Menu button.**  
The [Rec. Mode] menu will be displayed.
- 3 Press the four-way controller (▼) to select [Interval shooting].**
- 4 Press the four-way controller (▶).**  
The [Interval Shooting] menu will be displayed.
 
- 5 Set the shooting interval.**
  - 1. Press the four-way controller (▶).**  
▲ and ▼ will be displayed above and below the minute.
  - 2. Use the four-way controller (▲ ▼) to set the minute and press the four-way controller (▶).**  
▲ and ▼ will be displayed above and below the second.
  - 3. Use the four-way controller (▲ ▼) to set the second and press the four-way controller (▶).**
  - 4. Press the four-way controller (▼).**  
The frame will move to [Number of shot].
- 6 Use the four-way controller (◀ ▶) to set the number of shot and press the four-way controller (▶).**  
The frame will move to [Start Time].

- 7 Set the start time.**
  - 1. Press the four-way controller (▶).**  
▲ and ▼ will be displayed above and below the hour.
  - 2. Use the four-way controller (▲ ▼) to set the hour and press the four-way controller (▶).**  
▲ and ▼ will be displayed above and below the minute.
  - 3. Use the four-way controller (▲ ▼) to set the minute.**
- 8 Press the Playback/OK button twice.**
- 9 Press the button to display on the LCD monitor.**
- 10 Press the shutter release button.**  
The interval shooting starts.



- The shooting interval can be set by one second for an interval between 30 seconds and 4 minutes, and by one minute for an interval between 4 minutes and 99 minutes.
- The number of pictures can be set between 2 and 99.
- The shooting start time can be set by one minute between 0 and 3 hours 59 seconds.
- When "0" second is set for the shooting start time, the first picture is taken immediately after you press the shutter release button.
- When the CF card or built-in memory space becomes insufficient, the interval shooting ends and the power of the camera is turned off automatically.

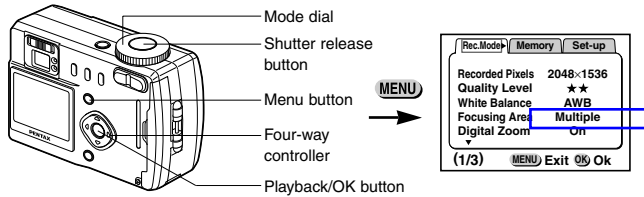

### Shooting Time-lapse Movies (Time-lapse Movie)

With the time-lapse movies, the frame rate (number of pictures taken for one second) is slowed down. When you play back these pictures, the subject appears to move much more quickly. This effect may be useful for taking blooming flowers, for example.

- 1** Set the mode dial to in Capture mode.
- 2** Press the Menu button.  
The [Rec. Mode] menu will be displayed.
- 3** Press the four-way controller (▼) to select [Time-lapse Movie].
- 4** Use the four-way controller (◀ ▶) to select [Off (x1)], [x2], [x5], [x10], [x20], [x50], or [x100].
- 5** Press the Playback/OK button.
- 6** Press the shutter release button.  
The time-lapse movie shooting starts.

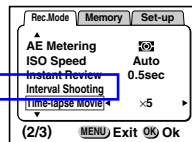

[Off (x1)] is the typical movie setting (15 frames/second). As you select [x2], [x5]..., the number of pictures taken for a second decreases from 1/2, 1/5...  
The images of movie pictures are always played back at the rate of 15 frames per second. This means those taken at x2 appear to be played back twice faster and those at x5 five times faster than x1.

## Setting the Shooting Functions

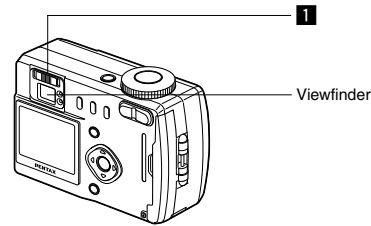

### Adjusting the Viewfinder

If the indicators in the viewfinder are hard to see, you can adjust the diopter in the range of -3m<sup>-1</sup>+1m<sup>-1</sup> (per meter).

- 1** Aim the camera towards the light and move the diopter adjustment lever to the left or right while looking through the viewfinder.  
Adjust the focus frame in the middle of the viewfinder to the optimum position.

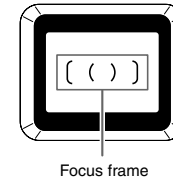

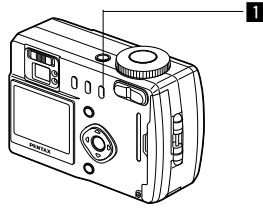

### Selecting a Focus Mode

#### ● Focus Mode

None	Auto	The camera is focused on the subject in the focusing area when the shutter release button is pressed halfway.
	Macro Mode	This mode is used when the distance to the subject is approx. 10cm-50cm (0.33ft-1.64ft). The camera is focused on the subject in the focusing area when the shutter release button is pressed halfway.
	Infinity-landscape mode	This mode is used for taking distant objects.
<b>MF</b>	Manual Focus Mode	The subject is brought into focus manually.
	AF area move mode	This mode is for changing the position of the autofocus (AF) area.

- 1** Press the **MF** button in Capture mode.  
 The focus mode changes each time the button is pressed and the setting is displayed on the LCD monitor.  
 The camera is ready to take the picture in the set focus mode.

Saving the Focus Mode p.74

- memo**
- When [Focus Mode] in the [Memory] menu (p.74) is not turned on, the focus mode goes back to [Auto] when you turn off the power.
  - The default setting of the focus mode is [Auto]. When the focus mode is [Auto], no icon is displayed on the LCD monitor.



If you take a picture while looking through the viewfinder when the focus mode is set on Macro, the range of the resulting picture may differ from what was seen in the viewfinder.

### Manual Focus

When the mode is set on **MF**, the center of the picture is enlarged to full screen on the LCD monitor. Adjust the focus with the four-way controller while looking at the image on the monitor.



increases the distance to the focusing position



decreases the distance to the focusing position

When you release the four-way controller, the focus position is set, and the screen returns to the normal display two seconds later.





Saving the Manual Focus Position p.74



When it is difficult to obtain the correct focus in Manual Focus mode for taking pictures in dark places, press the shutter release button halfway in Auto mode, and the AF spotbeam will be emitted, enabling the camera to focus more easily on the subject.

### Setting the position of the autofocus (AF) area

When the mode is set on  $\leftarrow$ AF $\rightarrow$ , the position of the autofocus (AF) area can be changed.

-  The AF area moves upward.
-  The AF area moves downward.
-  The AF area moves to the left.
-  The AF area moves to the right.

Press the Playback/OK button to determine the position of the AF area.



When the mode is set on  $\leftarrow$ AF $\rightarrow$ , the AF area is automatically set on spot. In this case, the AF spotbeam will not be emitted.

Changing the AF Area (Focusing Area)  p.67

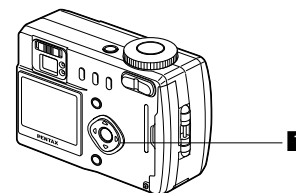

### EV Compensation

You can take pictures that are intentionally overexposed or underexposed.

#### 1 Press the four-way controller ( $\leftarrow$ $\rightarrow$ ) in Capture mode.

- Four-way controller ( $\rightarrow$ ) increases the EV compensation to a positive (+) level
- Four-way controller ( $\leftarrow$ ) decreases the EV compensation to a negative (-) level



EV compensation level

The set level is displayed on the LCD monitor.



- If you set to  $\pm 0$ , the set level displayed on the LCD monitor will go off after three seconds.
- When [EV Compensation] on the [Memory] menu (p.74) is not turned on, the set value goes back to  $\pm 0$  when you turn off the power.

Saving the EV Compensation  p.74



This function cannot be used in Manual Exposure mode.

### Changing the Shutter Speed/Aperture Setting

See "Taking Pictures Manually (Manual Exposure Mode)" (p.36).



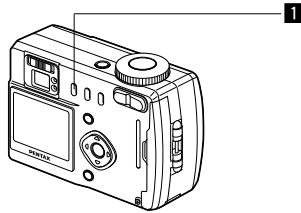

### Selecting the Flash Mode

None	Auto	The flash discharges automatically depending on the light conditions.
	Flash Off	The flash will not discharge.
	Flash On	The flash discharges regardless of the brightness.
	Auto + Red-eye Reduction	This mode reduces the phenomenon of red eyes caused by the light from the flash being reflected in the subject's eyes. The flash discharges automatically.
	Flash On + Red-eye Reduction	This mode reduces the phenomenon of red eyes caused by the light from the flash being reflected in the subject's eyes. The flash will discharge regardless of lighting conditions.



- The flash is off when the Capture mode is set to , continuous shooting, or infinity-landscape mode.
- [Auto] and [Auto + Red-eye Reduction] modes cannot be selected when the Capture mode is set to .
- In [Auto + Red-eye Reduction] and [Flash On + Red-eye Reduction] modes, the flash discharges once to make subject's pupil smaller. The picture will then be taken in the flash mode after a brief interval.

**1 Press the button in Capture mode.**

The flash mode changes each time the button is pressed and the set mode is displayed on the LCD monitor.

The flash lamp blinks red while the flash is charging. If the flash lamp lights red when you press the shutter release button halfway after charging is completed, the camera is ready to take the picture in the set flash mode.

Saving the Flash Mode p.74

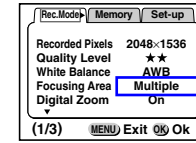
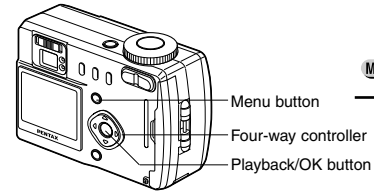
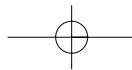
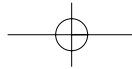

### Selecting the Recorded Pixels

You can choose the number of recorded pixels. These choices are for Optio 430RS and Optio 330RS respectively.

Optio 430RS [2304 × 1712], [2240 × 1680], [1600 × 1200], [1024 × 768], or [640 × 480]

Optio 330RS [2048 × 1536], [1600 × 1200], [1024 × 768], or [640 × 480].

**1 Select [Recorded Pixels] from the [Rec.Mode] menu.**

**2 Use the four-way controller ( ) to change the size.**

**3 Press the Playback/OK button.**

The camera is ready to take the picture.

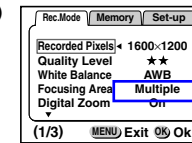

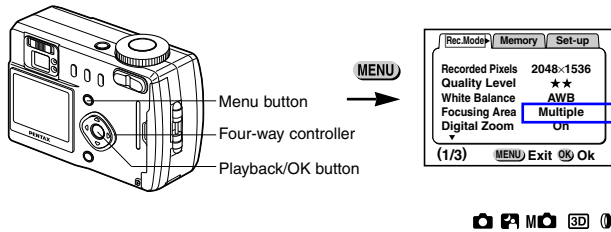

### Selecting the Quality Levels

You can choose the image compression rate.

★★★	BEST	The quality is better and there is a high volume of image data.
★★	BETTER	Standard level
★	GOOD	The quality is good and there is a low volume of image data.

- 1 Select [Quality Level] from the [Rec.Mode] menu.
- 2 Use the four-way controller (◀ ▶) to change the image quality.
- 3 Press the Playback/OK button. The camera is ready to take the picture.

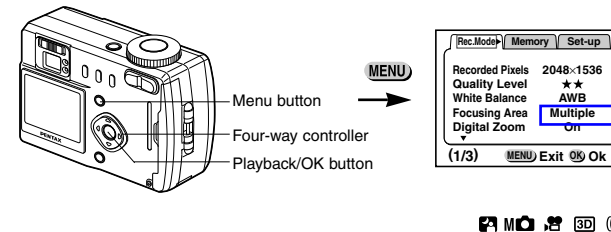
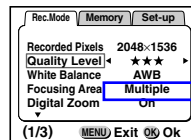

### Adjusting the Color Balance according to Lighting (White Balance)

You can take pictures in natural colors by adjusting the white balance according to the light conditions at the time of shooting.

AWB	Auto	The camera adjusts the white balance automatically.
☀	Daylight	Use this mode when taking pictures outside in sunlight.
🏠	Shade	Use this mode when taking pictures outside in the shade.
💡	Tungsten Light	Use this mode when taking pictures under electric or other tungsten light.
💡	Fluorescent Light	Use this mode when taking pictures under fluorescent light.
👤	Manual	Use this mode when taking pictures by adjusting the white balance manually.

- 1 Select [White Balance] from the [Rec.Mode] menu.
- 2 Press the four-way controller (▶). The white balance screen will be displayed.
- 3 Use the four-way controller (▲ ▼) to change the setting.
- 4 Press the Playback/OK button twice. The camera is ready to take the picture.



Saving the White Balance p.74

### Manual Setting

- 1 Select [ ] (manual) on the white balance screen.**
- 2 Point your camera at a blank sheet of paper so that it fills the screen.**
- 3 Press the Display button.**  
Adjustment will start and [Adjusting] will appear on the LCD monitor. When adjustment has been completed, [Complete] will appear on the LCD monitor and the screen will return to the menu screen.
- 4 Press the Playback/OK button.**  
The camera is ready to take the picture.

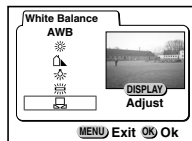

If the Display button is again pressed while [Adjusting] is displayed on the LCD monitor, the white balance adjustment will be repeated, starting from the beginning. Press the Playback/OK button to cancel adjustment while in progress.

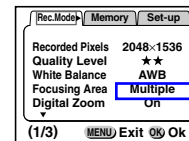
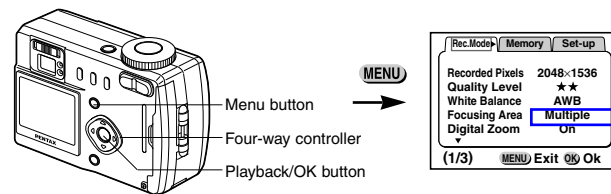

### Changing the AF Area (Focusing Area)

You can change the range of the autofocus area.

Multiple	Normal area
Spot	The area becomes narrower.

- 1 Select [Focusing Area] on the [Rec.Mode] menu.**
- 2 Use the four-way controller ( ◀ ▶ ) to change the setting.**
- 3 Press the Playback/OK button.**  
The camera is ready to take the picture.

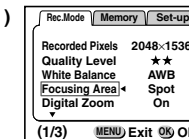

The AF area does not appear in the viewfinder. Always check the focusing area on the LCD monitor.

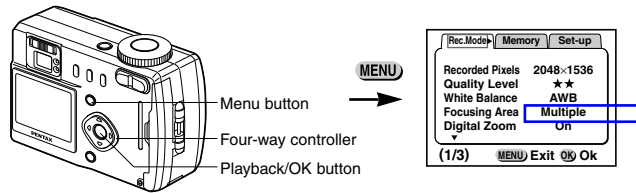

### Setting the Light Metering Range to Determine the Exposure (AE Metering)

You can choose which part of the screen to use to measure the brightness and determine the exposure.

	Multi segment	The exposure is determined by the entire screen.
	Center-weighted	The exposure is determined mainly by the center of the screen.
	Spot	The exposure is determined by the middle of the screen only.

- 1 Select [AE Metering] on the [Rec.Mode] menu.**
- 2 Use the four-way controller (◀ ▶) to change the metering mode.**
- 3 Press the Playback/OK button.**  
The camera is ready to take the picture.

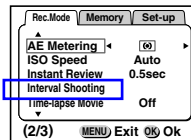

Saving the AE Metering Method p.74

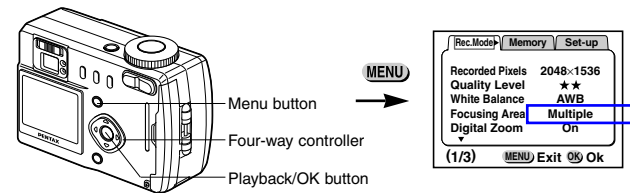

### Setting the ISO Speed (ISO Speed)

You can select the ISO speed to suit the brightness of the surroundings.

#### ● ISO Speed

Auto	The camera sets the speed automatically.
100 (430RS)	Produces sharp images with little or no noise. Decreases the shutter speed in low light conditions.
200 (430RS)	Increases the shutter speed in low light conditions but there is more risk of noise.

- 1 Select [ISO Speed] on the [Rec.Mode] menu.**
- 2 Use the four-way controller (◀ ▶) to change the ISO speed.**
- 3 Press the Playback/OK button.**  
The camera is ready to take the picture.

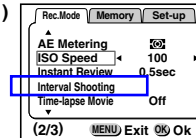

Saving the ISO Speed p.74

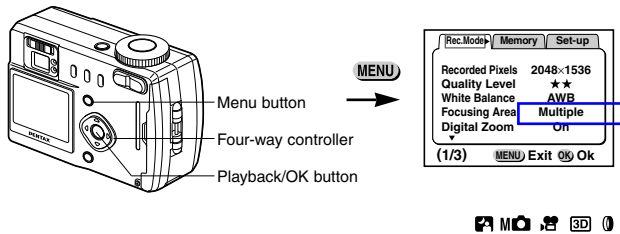

### Setting the Instant Review Time (Instant Review)

You can choose the Instant Review time from 0.5sec, 1sec, 2sec, 3sec, 4sec, 5sec or Off (no display).

- 1 Select [Instant Review] on the [Rec.Mode] menu.
- 2 Use the four-way controller (◀ ▶) to change the display time.
- 3 Press the Playback/OK button.

The camera is ready to take the picture.

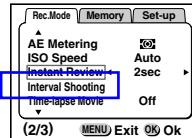

The Instant Review display setting is saved when the camera is turned off.

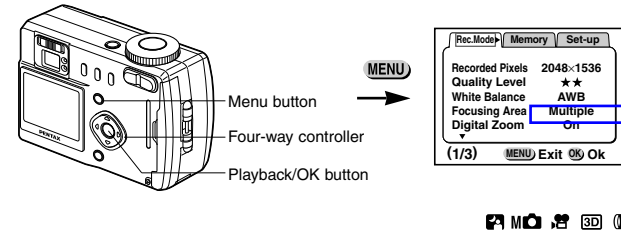

### Setting the Image Sharpness (Sharpness)

You can choose whether you want the image to have sharp or soft outlines.

- 1 Select [Sharpness] on the [Rec.Mode] menu.
- 2 Use the four-way controller (◀ ▶) to change the setting from [Normal] to [Hard (+)] or [Soft (-)].
- 3 Press the Playback/OK button.

The camera is ready to take the picture.

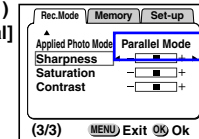

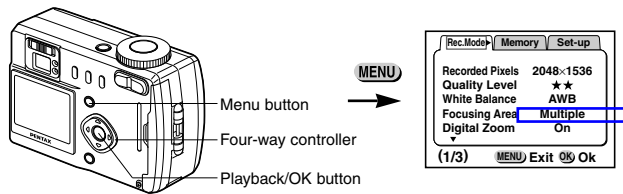

### Setting the Color Saturation (Saturation)

You can set the color saturation.

- 1** Select [Saturation] on the [Rec.Mode] menu.
- 2** Use the four-way controller (◀ ▶) to change the setting from [Normal] to [Hard (+)] or [Soft (-)].
- 3** Press the Playback/OK button.  
The camera is ready to take the picture.

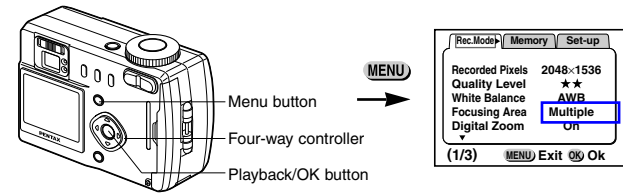
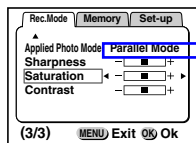

### Setting the Image Contrast (Contrast)

You can set the image contrast.

- 1** Select [Contrast] on the [Rec.Mode] menu.
- 2** Use the four-way controller (◀ ▶) to change the setting from [Normal] to [Hard (+)] or [Soft (-)].
- 3** Press the Playback/OK button.  
The camera is ready to take the picture.

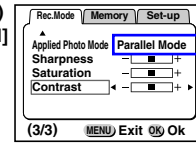

## Saving the Settings (Memory)

### Saving the Menu Items (Mode Memory)

You can choose whether you want the set values to be saved when the camera is turned off. If you select  (On), the settings will be saved in the status they were in immediately before the camera was turned off. If you select  (Off), the settings will be reset to the defaults when the camera is turned off.

Item	Description	Default Setting
Flash	The setting on the  button is saved.	<input checked="" type="checkbox"/>
White Balance	The [White Balance] setting on the [Rec.Mode] menu is saved.	<input type="checkbox"/>
EV Compensation	The set EV compensation value is saved.	<input type="checkbox"/>
Digital Zoom	The [Digital Zoom] setting on the [Rec.Mode] menu is saved.	<input checked="" type="checkbox"/>
AE Metering	The [AE Metering] setting on the [Rec.Mode] menu is saved.	<input type="checkbox"/>
ISO Speed	The [ISO Speed] setting on the [Rec.Mode] menu is saved.	<input type="checkbox"/>
Focus Mode	The focus mode setting is saved.	<input type="checkbox"/>
Zoom Position	The zoom position setting is saved.	<input type="checkbox"/>
MF	The manual focus position is saved.	<input type="checkbox"/>
DISPLAY	The LCD monitor display mode is saved.	<input type="checkbox"/>
File #	The file number is saved. If a new CF card is inserted, the sequential file number is assigned.	<input checked="" type="checkbox"/>



Menu items not included in [Memory] will also be saved in the settings selected on the menus for each function when the camera is turned off.

**1** Press the Menu button in Capture mode.

**2** Press the four-way controller (▶). [Memory] menu will be displayed.

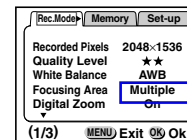

**3** Use the four-way controller (▲ ▼) to select the item.

**4** Use the four-way controller (◀ ▶) to switch  (On) and  (Off).

**5** Press the Playback/OK button. The camera is ready to take the picture.

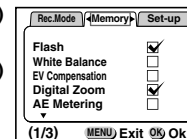

## Playback/Erasing Playing Back Images

When the CF card is installed, the images recorded on the CF card are played back. When the CF card is not installed, the images recorded in the built-in memory are played back. Press the Playback/OK button to enter the playback mode.

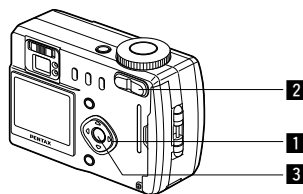

### Playing Back Still Pictures

See "Playing Back Previous or Next Images" (p.23).

### Zoom Display

You can display images magnified up to four times. A guide to operation is displayed on the LCD monitor during magnification.

**1** Enter the Playback mode and choose the image you want to magnify with the four-way controller (◀ ▶).

**2** Press ▲ on the Zoom button.  
The image will be magnified (1x to 4x).

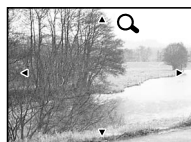

● The following operations can be performed while the magnified image is displayed.

Four-way controller (▲ ▼ ◀ ▶)

Moves the position to be magnified

Zoom button (▲) Makes the image larger

Zoom button (▼▼▼) Makes the image smaller

Display button Turns the guide marks on/off

**3** Press the Playback/OK button.  
Zoom playback will end.



When the [Quick Enlargement] on the [Set-up] menu is turned on, the images is displayed four times larger when you press ▲ on the zoom button in step **2**.



Movie pictures cannot be magnified.



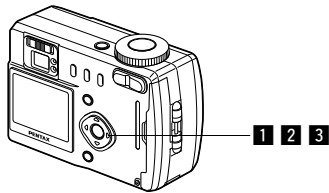

### Playing Back Movie Pictures

You can play back Movie pictures. A guide to operation is displayed on the LCD monitor during playback.

**1 Enter the Playback mode and choose the movie picture you want to play back with the four-way controller (◀ ▶).**

**2 Press the four-way controller (▲).**

Playback will start.

● The following operations can be performed during playback.

Four-way controller (◀) :

Reverse playback

Four-way controller (▶) :

Forward playback

Four-way controller (▲) : Pause

Display button : Changes the Display mode

● The following operations can be performed while Pause is engaged.

Four-way controller (◀) : Frame reverse

Four-way controller (▶) : Frame forward

Four-way controller (▲) : Releases the Pause function

Display button : Changes the Display mode

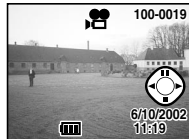

**3 Press the four-way controller (▼).**

Movie playback will end.

Playback/Erasing

### Displaying Shooting Information (Display Mode)

You can display information on the LCD monitor when shooting. The information displayed can be changed by pressing the Display button.

#### Display On

Information is displayed when shooting.

- ① Folder name
- ② File name
- ③ Protect symbol
- ④ Shooting date
- ⑤ Battery symbol

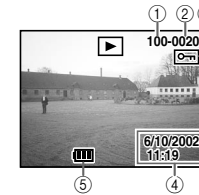

#### Histogram Display

The brightness distribution of the image is displayed. The x-axis shows the brightness (darkest at the left end and brightest at the right end) and the y-axis shows the pixel numbers.

- ① Histogram
- ② Recorded pixels
- ③ Quality level
- ④ White balance
- ⑤ AE metering
- ⑥ ISO speed
- ⑦ Aperture
- ⑧ Shutter speed

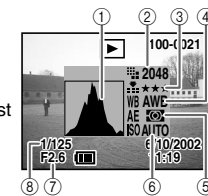

#### Display Off

No information is displayed when shooting.



Display On

Playback/Erasing

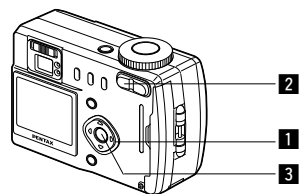

### Nine-image Display

You can display nine images at the same time.

**1** Enter the Playback mode and choose an image with the four-way controller (◀ ▶).

**2** Press the button.

Nine images will be displayed with the selected image in the center. Choose an image with the four-way controller (▲ ▼ ◀ ▶).

When 10 or more images have been recorded, the previous 9 images will be displayed if you press the four-way controller (◀) while an image on the left row is selected. If you press the four-way controller (▶) while an image on the right row is selected, next 9 images will be displayed.



Selected image

**3** Press the Playback/OK button.

The screen will return to single-image display of the selected image.



For movie pictures, the first frame will be displayed.

## Erasing Images

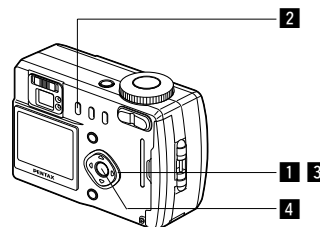

### Erasing a Single Image

**1** Enter the Playback mode and choose the image you want to erase with the four-way controller (◀ ▶).

**2** Press the button.

The Delete screen will be displayed.

**3** Select [Delete] with the four-way controller (▲).

**4** Press the Playback/OK button.



- You can also delete images from Instant Review (p.21).
- You cannot erase protected images (with the symbol).
- Step **3** can be omitted if you turn on the [Quick Delete] on the [Set-up] menu.

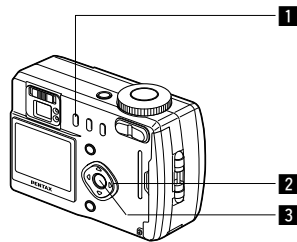

### Erasing All Images

You can erase all the images at once.



- Once erased, images cannot be restored.
- Protected images cannot be erased.
- If the CF card is installed, only the images recorded on the CF card will be deleted.

**1** Enter the Playback mode and press the button twice.

The Delete (All) screen will be displayed.

**2** Select [All Images] with the four-way controller ().

**3** Press the Playback/OK button.



Step **2** can be omitted if you turn on the [Quick Delete] on the [Set-up] menu.

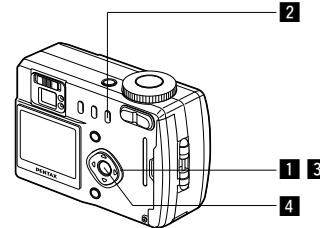

### Protecting Images from Deletion (Protect)

You can protect images from being accidentally erased.

**1** Enter the Playback mode and choose the image you want to protect with the four-way controller ( ).

**2** Press the button.

The Protect screen will be displayed.

**3** Select [Protect] with the four-way controller ().

**4** Press the Playback/OK button.



- Select [Unprotect] in step **3** above to release the Protect setting.
- If the image is protected, the symbol is displayed when the image is played back.

### Protecting All Images

You can protect all the images.

**1** Enter the Playback mode.

**2** Press the button twice.

The Protect (All) screen will be displayed.

**3** Select [Protect] with the four-way controller ().

**4** Press the Playback/OK button.



- Even protected images will be erased by formatting the CF card or the built-in memory.
- If the CF card is installed, only the images recorded on the CF card will be protected.

## Setting the Printing Service

You can print the images on the CF card using a DPOF (Digital Print Order Format) compatible printer or at a printing service.

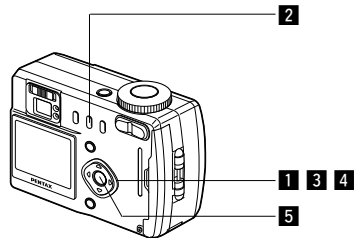

### Printing Single Image

Set the following items for each image.

● **Copies**

Set the number of prints up to a maximum of 99.

● **Date**

Specify whether you want the date imprinted on the picture or not.

**1** Enter the Playback mode and choose the image for which you want to specify the number of prints with the four-way controller (◀ ▶).

**2** Press the DPOF button.  
The DPOF screen will be displayed.



- 3** Use the four-way controller (◀ ▶) to select the number of prints and press the four-way controller (▼). The frame will move to [Date].
- 4** Use the four-way controller (◀ ▶) to select  (On) and  (Off).



- : The date will be imprinted  
 : The date will not be imprinted

- 5** Press the Playback/OK button.  
Prints can be made according to the settings.



If DPOF settings have already been made for an image, the previously set number of prints and On/Off date setting will be displayed.



- DPOF settings cannot be made on the images and movie pictures saved in the built-in memory. Copy them to the CF card (p.106) and make DPOF settings.
- Depending on the printer or printing equipment at the photo tab, the date may not be imprinted on the pictures even if the DPOF setting was made.

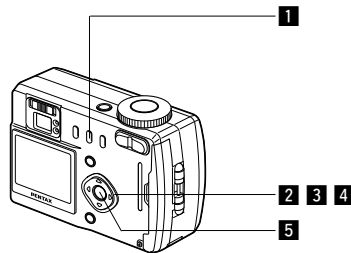

## Printing All Images

### 1 Enter the Playback mode and press the DPOF button twice.

The DPOF (ALL) screen will be displayed.

### 2 Use the four-way controller (◀ ▶) to select the number of prints.

You can specify up to 99 prints.

### 3 Press the four-way controller (▼).

The frame will move to [Date].

### 4 Use the four-way controller (◀ ▶) to select (On) and (Off).

- : The date will be imprinted
- : The date will not be imprinted

### 5 Press the Playback/OK button.

Prints can be made according to the settings.



- The setting for a single image will be cancelled.
- When you specify the number of prints in the DPOF setting, the number applies to all the images. Before printing, check that the number is correct.



DPOF settings cannot be made on the images and movie pictures saved in the built-in memory. Copy them to the CF card (p.106) and make DPOF settings.

## Viewing Images with Windows PC

By using the provided USB cable (I-USB6) or card reader and image-browser software, you can transfer images recorded with the camera to a PC and edit them or print them out. This section explains how to view images on a PC using the provided USB driver and software.

### About the included software

The included CD-ROM (S-SW5) contains the following software:

- USB driver
- Image viewing software (ACDSee™ 3.1)

### System environment

- OS: Windows 98/98SE/2000/Me  
Windows XP Home Edition/Professional
- CPU: Pentium or later recommended
- Memory: 64MB or more
- Hard disk space: 15MB or more
- Standard equipped USB port

To view movie pictures on your PC, Direct X 8.0 and Media Player pre-installed on system, or QuickTime 3.0 or later are required. For Windows Me/XP, Media Player pre-installed on system, QuickTime 3.0 or later is required.



- Not compatible with Windows 95.
- When you connect the camera to your PC, you are recommended to use the AC adapter. If the battery power runs out while image data is being transferred, the data may be lost.

### To customers who have already purchased Optio 430/330

If you have already installed the driver for Optio 430/330 on your PC Windows 98/98SE or Windows Me, do not connect the Optio 430RS/330RS to your PC. Otherwise your PC may freeze up. This phenomenon can be resolved by updating the driver installed on your PC. For more information, please refer to our web site.

<http://www.digital.pentax.co.jp/>

## Installing the software

The procedures for installing the necessary software are explained.



- The installation procedure varies depending on the version of Windows (98/98SE/Me/2000). Before starting installation, check which version of Windows you have on your PC. If you are using Windows XP, see "Installing the USB Driver (Windows XP)" (p.95) for installation instructions.
- If you are using Windows 2000 or Windows XP (Professional), log in by the administrator before starting installation. Refer to your PC's operation manual for instructions on how to log in.
- Either "430RS" or "330RS" will be displayed in the installation screen area where "xxxxx" is displayed.

### Installing the USB driver (Windows 98/98SE/Me/2000)

- 1 Turn on your PC.
- 2 Set the included CD-ROM (S-SW5) in the CD-ROM drive.
- 3 Turn the camera off, and connect the PC and camera using an USB cable.

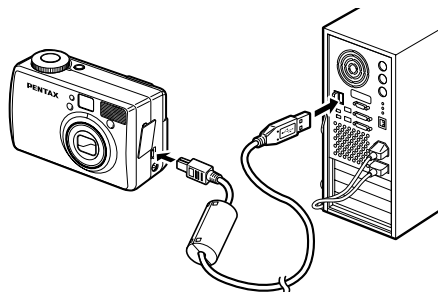

- 4 Turn the camera on.  
The PC recognizes the camera and the [Add New Hardware Wizard] screen is displayed.

If you are using Windows 98/98SE, follow the procedure below to install the software. For Windows Me, see p.91, and for Windows 2000, see p.93.

#### ● Windows 98/98SE

- 5 Click [Next].



- 6 Select [Search for the best driver for your device (Recommended)], and then click [Next].



- 7 Select [Specify a location], and then click [Browse].  
If any other item has been selected, click the check box to unselect it.



- 8 Specify the [Win] folder in the CD-ROM drive and click [OK].  
If you click the [+] symbol, the folder will open and display the files inside.

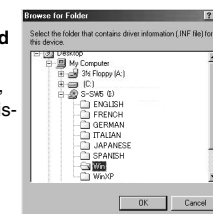

- 9** Make sure that the [Win] folder is selected and click [Next].



- 10** Make sure that [penusbp.inf] is selected, then click [Next]. Installation starts.



- 11** Click [Finish]. Installation is completed and the [Wizard] screen is closed.



- 12** Turn the camera off and restart your PC. When Windows is up and running, turn the camera on.

- 13** Double-click the [My Computer] icon on the desktop. When the camera is turned on, the Removable Disk icon appears in the window.

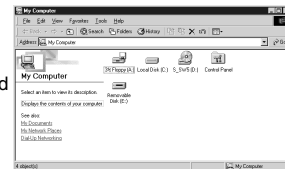

**memo** The CF card, if installed, is regarded as the removable disk. If the CF card is not installed, the built-in memory is regarded as the removable disk.

● Windows Me

- 5** Select [Specify the location of the driver (Advanced)], and then click [Next].



- 6** Select [Specify a location], and then click [Browse]. If [Removable Media] has been selected, click the check box to unselect it.



- 7** Specify the [Win] folder in the CD-ROM drive and click [OK]. If you click the [+] symbol, the folder will open and display the files inside.



- 8** Make sure that the [Win] folder is selected and click [Next].



- 9** Make sure that [penusbp.inf] is selected, then click [Next]. Installation starts.



- 10 Click [Finish].**  
Installation is completed and the [Wizard] screen is closed.



- 11 Turn the camera off and restart your PC.**  
When Windows is up and running, turn the camera on.

- 12 Double-click the [My Computer] icon on the desktop.**  
When the camera is turned on, the Removable Disk icon appears in the window.

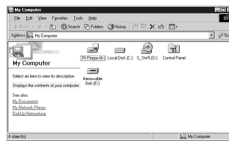

The CF card, if installed, is regarded as the removable disk. If the CF card is not installed, the built-in memory is regarded as the removable disk.

● Windows 2000

- 5 Click [Next].**
- 6 Select [Search for the best driver for your device], and then click [Next].**
- 7 Select [Specify a location], and then click [Next].**  
If any other item has been selected, click the check box to unselect it.
- 8 Click [Browse].**  
The [Files] screen is displayed.
- 9 Select the [Win] folder in the CD-ROM drive and make sure that [penusbp.inf] is displayed.**  
And then click [Open].

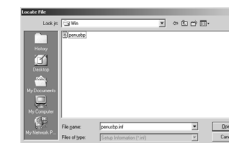
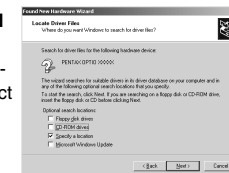
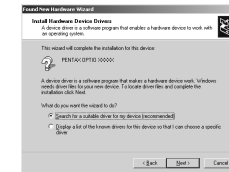



- 10** Make sure that the [Win] folder containing the files to be copied is selected, and click [OK].



- 11** Make sure that [penusbp.inf] is selected, then click [Next]. Installation starts.



- 12** Click [Finish]. Installation is completed and the [Wizard] screen is closed.



- 13** Double-click the [My Computer] icon on the desktop. When the camera is turned on, the Removable Disk icon appears in the window.



The CF card, if installed, is regarded as the removable disk. If the CF card is not installed, the built-in memory is regarded as the removable disk.

## Installing the USB driver (Windows XP)

- 1 Turn on your PC.
- 2 Set the CD-ROM (S-SW5) supplied with the camera in the CD-ROM drive.
- 3 Turn the camera off and connect the PC and camera using the USB cable.

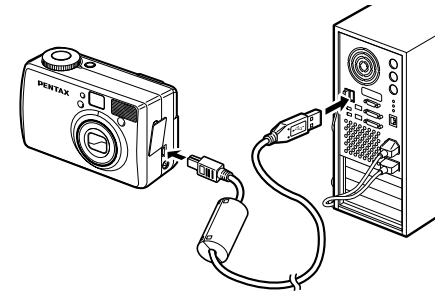

- 4** Turn the camera on. [New hardware has been located] will appear on the task bar and the [New Hardware Search Wizard] screen will be displayed.



- 5** Select [Install the software automatically (Recommended)] and click [Next].

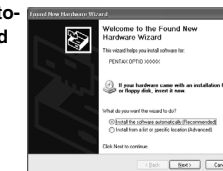

- 6** When [The software has been successfully installed] message appears, click [Finish].

Installation is completed and the [Wizard] screen is closed. If the screen for choosing an automatic Windows operation is displayed, click [Cancel].



- 7** Click [My Computer] from [Start] menu.

After installing the software, make sure that a Removable Disk has been added to [My Computer].

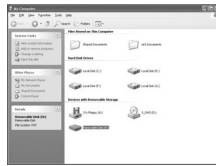

- The CF card, if installed, is regarded as the removable disk. If the CF card is not installed, the built-in memory is regarded as the removable disk.
- In the case of Windows XP, if the CF card has a volume label attached, the content of the volume label will be displayed instead of [Removable Disk]. If the CF card is new and has not been formatted, the manufacturer and capacity of the card will be displayed.

Playback/Erasing

96

## Installing ACDSee™

When installing ACDSee™, recorded images can be viewed on your PC.

- 1 Turn on your PC.**
- 2 Set the CD-ROM (S-SW5) in the CD-ROM drive.**
- 3 Double click [My Computer].**
- 4 Double click the [CD-ROM drive] icon.**
- 5 Double click your language choice.**  
You can choose the language from the following: English, French, German, Spanish, Italian and Japanese.
- 6 Double click [setup.exe].**  
The Setup screen will appear. Follow the on-screen guidance and enter the registration information.
- 7 When the installation is completed, restart Windows.**

Playback/Erasing

97

## Connecting the camera and PC

- 1 Turn on your PC.
- 2 Turn the camera off and connect the PC and camera using an USB cable.

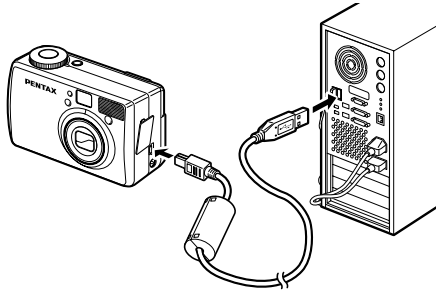

- 3 Turn on the camera. The camera will be detected as [Removable Disk] in [My Computer].

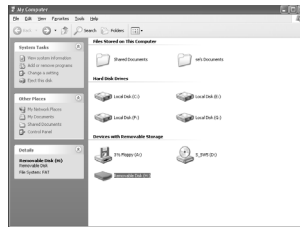

- The CF card, if installed, is regarded as the removable disk. If the CF card is not installed, the built-in memory is regarded as the removable disk.
- Although images can be viewed and printed, image data is in the built-in memory or on the CF card in the camera. To save the image data in the built-in memory or on the CF card to another medium, refer to the instruction manual of your PC and move or copy files using Explorer, etc. You can edit images on your PC after moving or copying files there.
- In the case of Windows XP, if the CF card has a volume label attached, the content of the volume label will be displayed instead of [Removable Disk]. If the CF card is new and has not been formatted, the manufacturer and capacity of the card will be displayed.

## Viewing images on your PC

- 1 Double click the [ACDSee™] icon on the desktop.
- 2 Select the image to view.

Camera images can be found in [My Computer] → [Removable Disk (or the name on the volume label on the CF card, if there is one)] → [DCIM] → [xxxPENTX] (xxx is a 3-digit numeral) folder.



You can also view movie pictures operating the above procedures.

## Disconnecting the camera from your PC

### Disconnecting the camera from your PC (Windows 2000)

- 1 Double click  (Hot Plug icon) on the lower right task bar tray of the desktop. The [Remove Hardware] screen will be displayed.



- 2 Make sure [PENTAX USB Disk Device] is selected and click [Stop]. [Stop Hardware Device] screen will be displayed.



- 3 Make sure [PENTAX USB Disk Device] is selected and click [OK]. A message will appear.



- 4 Click [OK].

- 5 Disconnect the USB cable from your PC and camera.



For Windows 98/98SE/Me, there is no Hot Plug icon. When removing the camera, turn off the camera and disconnect the USB cable.

Playback/Erasing

100

## Disconnecting your camera from your PC (Windows XP)

- 1 Click [Remove Hardware icon] on the task bar.
- 2 Make sure [PENTAX USB Disk Device] is selected and click [Stop].
- 3 Make sure [PENTAX USB Disk Device] is selected and click [OK].
- 4 A message confirming removal of the hardware will appear. Turn the camera off and disconnect your camera from your PC.

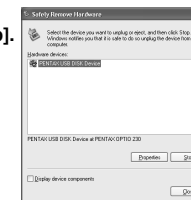

Playback/Erasing

101

## Viewing Images with Macintosh

By using the provided USB cable (I-USB6) or card reader and image-browser software, you can transfer images recorded with the camera to a PC and edit them or print them out.

This section explains how to view images on a PC using the provided USB driver and software.

### About the included software

The included CD-ROM (S-SW5) contains the following software:

- USB driver
- Image viewing software (ACDSee™)

### System environment

OS: Mac OS 8.6 or later (QuickTime 4.0 or later required)  
 CPU: Power PC 266MHz or higher  
 Memory: 8MB or more  
 Hard disk space: 6MB or more  
 Standard equipped USB port



To view movie pictures on your Macintosh, QuickTime 4.0 or later pre-installed on system is required.



When you connect the camera to your PC, you are recommended to use the AC adapter. If the battery power runs out while image data is being transferred, the data may be lost.

## Installing the software

The procedures for installing the necessary software are explained.

### Installing the USB driver (Only for Mac OS 8.6)

- 1 Turn on your Macintosh.**
- 2 Set the included CD-ROM (S-SW5) in the CD-ROM drive of your Macintosh.**
- 3 Copy the following 2 files to the [Extensions] folder within the System folder.**  
 PENTAX-USB Storage Driver  
 PENTAX-USB Storage Shim (E)
- 4 Restart your Macintosh.**



For MacOS 9.x or later, there is no need to install the USB driver.

### Installing ACDSee™

When installing ACDSee™, recorded images can be viewed on your Macintosh.

- 1 Turn on your Macintosh.**
- 2 Set the included CD-ROM (S-SW5) in the CD-ROM drive of your Macintosh.**
- 3 Double click your language choice.**  
 You can choose the language from the following: English, French, German, Spanish, Italian and Japanese.
- 4 Follow the on-screen guidance and enter the registration information and proceed with the installation.**

## Connecting the camera and your Macintosh

- 1 Turn on your Macintosh.
- 2 Turn off the camera and connect your Macintosh and camera using an USB cable.

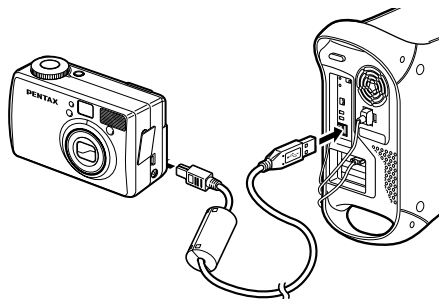

- 3 Turn on the camera.  
The camera will be detected as [untitled] on the desktop. The folder name can be changed as desired.



- The CF card, if installed, is regarded as "untitled." If the CF card is not installed, the built-in memory is regarded as "untitled."
- Although images can be viewed and printed, image data is in the built-in memory or on the CF card in the camera. To save the image data in the built-in memory or on the CF card to another medium, refer to the instruction manual of your Macintosh and move or copy files. You can edit images on your Macintosh after moving or copying files there.
- If the CF card has a volume label attached, the content of the volume label will be displayed instead of [Removable Disk]. If the CF card is new and has not been formatted, the manufacturer and capacity of the card will be displayed.

## Viewing images on your Macintosh

- 1 Double click the [ACDSee™] folder on the hard drive.
- 2 Double click the [ACDSee™] program icon.
- 3 Choose an image you wish to view.  
Camera images can be found in the [untitled] → [DCIM] → [xxxPENTX] (xxx is a 3-digit numeral) folder on the desktop.



- You can also view movie pictures operating the above procedures.
- If the CF card has a volume label attached, the content of the volume label will be displayed instead of [Removable Disk]. If the CF card is new and has not been formatted, the manufacturer and capacity of the card will be displayed.

## Disconnecting the camera from your Macintosh

- 1 Drag the [untitled (or the name on the volume label on the CF card, if there is one)] folder on the desktop to Trash.
- 2 Remove the USB cable from your Macintosh and camera.

## Editing Images/Settings Editing Images

### How to recall the [Set-up] menu

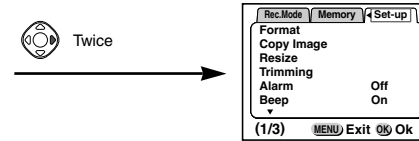
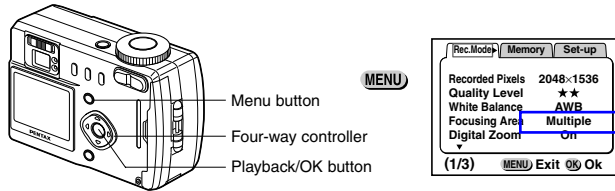

### Copying the Image

Images can be copied between the built-in memory and the CF card and vice versa.

#### Copying from built-in memory to CF card

All images saved in the built-in memory are copied to the CF card.

- 1** Select [Copy Image] on the [Set-up] menu.
- 2** Press the four-way controller (▶). The Copy Image screen will be displayed.
- 3** Press the Playback/OK button. Copying of images starts. When it is finished the Capture or Playback mode is enabled.

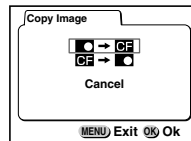

If the CF card memory is insufficient [Memory card full. Cannot Copy] appears on the LCD monitor. Replace the CF card with new one, or erase unnecessary images.

#### Copying from CF card to built-in memory

The images saved in the CF card are copied to the built-in memory one image at a time.

- 1** Select [Copy Image] on the [Set-up] menu.
- 2** Press the four-way controller (▶). The Copy Image screen will be displayed.
- 3** Press the four-way controller (▼) to select [CF → Built-in].
- 4** Press the Playback/OK button. The image that can be copied will be displayed.
- 5** Use the four-way controller (◀ ▶) to select the image to copy.
- 6** Press the Playback/OK button. Copy of the image starts. When it is finished, the screen will return to the previous screen.



When you want to copy images continuously, repeat steps **5** and **6**. To go back to the Capture mode, press the shutter release button half-way (or fully).

### How to recall the [Set-up] menu

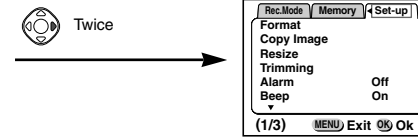
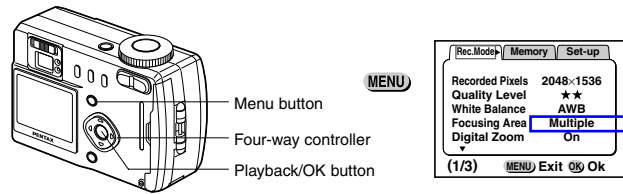

If the built-in memory space is insufficient, [Built-in Memory Full. Cannot Copy] appears on the LCD monitor. Format the built-in memory, or erase unnecessary images.

### Trimming Images

Part of the image can be trimmed and saved as another image.

- 1** Select [Trimming] on the [Set-up] menu.
- 2** Press the four-way controller (▶).  
The image that can be trimmed will be displayed.
- 3** Use the four-way controller (◀ ▶) to choose the image you want to trim.
- 4** Press the Playback/OK button.  
The Trimming screen will be displayed.
- 5** Trim the image.

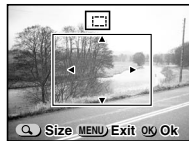

#### ● Operations available on the Trimming screen

- Zoom button Changes the size of image.
- Four-way controller Moves the trimming location up, down, right, or left.
- Menu button Returns to the Menu screen.

- 6** Press the Playback/OK button.
- 7** Use the four-way controller (◀ ▶) to choose the size.
- 8** Press the four-way controller (▼).  
The frame will move to [Quality Level].
- 9** Use the four-way controller (◀ ▶) to choose the image quality.
- 10** Press the Playback/OK button.  
The trimmed image will be saved as another image.





### How to recall the [Set-up] menu

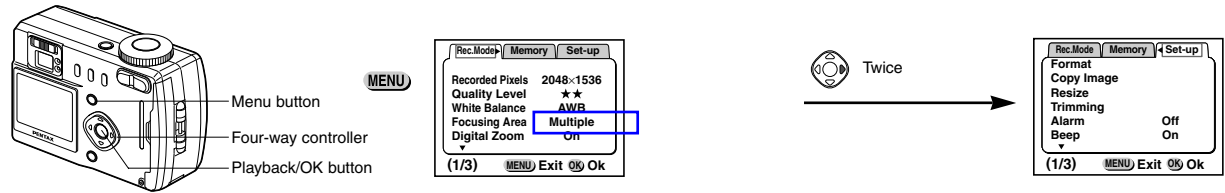

### Changing the Image Size (Resize)

The recorded pixels and quality of the selected image can be altered to change the file to a smaller size. The image whose size is changed can be overwritten on the original image, or saved as another image.

- 1** Select [Resize] on the [Set-up] menu.
- 2** Press the four-way controller (▶). The Resize screen will be displayed.



- 3** Use the four-way controller (◀ ▶) to select the image to resize.
- 4** Press the Playback/OK button.

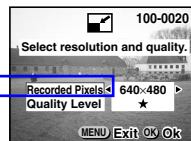

- 5** Use the four-way controller (◀ ▶) to select [Recorded Pixels].
- 6** Press the four-way controller (▼). The frame will move to [Quality Level].

- 7** Use the four-way controller (◀ ▶) to select [Quality Level].
- 8** Press the Playback/OK button.
- 9** Use the four-way controller (▲ ▼) to select [Overwrite] or [Save as].
- 10** Press the Playback/OK button. The image will be resized.



- The size of a movie picture cannot be changed.
- In Optio 430RS, part of the image is cut when the size of a still picture of 2304 × 1712 is resized.

## Camera Settings

### How to recall the [Set-up] menu

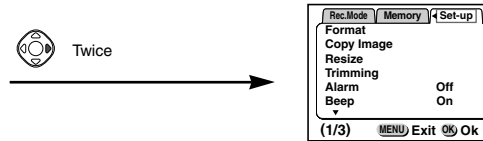
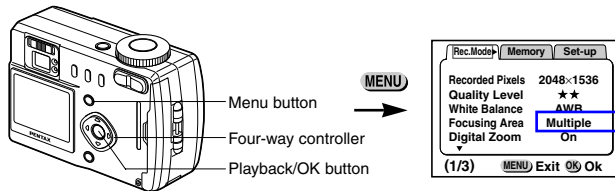

### Formatting

If the CF card is installed, all data stored on the CF card will be deleted and the CF card will be formatted. If the CF card is not installed, all data stored in the camera's built-in memory will be deleted and the built-in memory will be formatted.



- Do not open the CF card cover while the card is being formatted. The card may be damaged and become unusable.
- Formatting will delete protected data too.

- 1 Select [Format] on the [Set-up] menu.
- 2 Press the four-way controller (▶). The Format screen will be displayed.
- 3 Select [Format] with the four-way controller (▲).
- 4 Press the Playback/OK button.

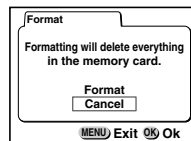

Formatting will start. When formatting is completed, the camera is ready to capture or play back images.

### Sounding the Alarm at a Set Time

You can sound the alarm at a specified time and display a selected image.

#### Checking the Alarm

- 1 Select [Alarm] on the [Set-up] menu.
- 2 Press the four-way controller (▶). The alarm list will be displayed. The alarms that are enabled will be indicated by .

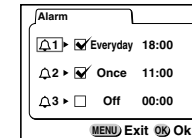

- 3 Press the Playback/OK button three times. If any alarms are enabled, the camera will be turned off and the alarms will be set.

### How to recall the [Set-up] menu

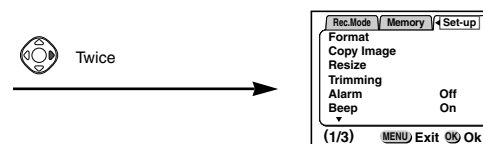
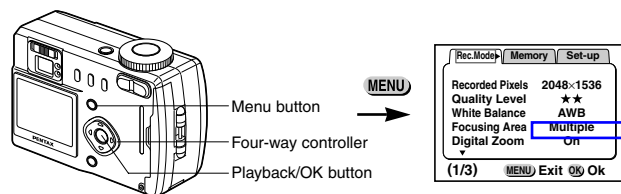

### Setting the Alarm

- 1 Select [Alarm] on the [Set-up] menu.
- 2 Press the four-way controller (▶). The alarm list will be displayed.

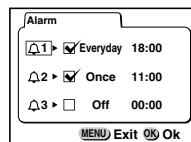

- 3 Use the four-way controller (▲ ▼) to select 1-3.

- 4 Press the four-way controller (▶). The screen for setting the operating mode and time will be displayed.

Four-way controller (◀ ▶):  
Selects the item  
Four-way controller (▲ ▼):  
Changes the settings

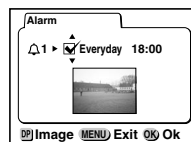

- 5 Press the DPOF button.
- 6 Select the image to be displayed when the alarm sounds with the four-way controller (◀ ▶).
- 7 Press the Playback/OK button.
- 8 Press the Playback/OK button 3 times. Setting is completed and the camera is turned off.

### Turning the Alarm Off

When the camera is turned off and the set time is reached, the alarm sounds for one minute. When it finishes sounding, the power is automatically turned off.



You can turn the alarm off by pressing any button (except the Zoom button).



The alarm does not sound when the camera is turned on.

### Setting the Beep

The beep sound can be turned on and off.

- 1 Select [Beep] on the [Set-up] menu.
- 2 Use the four-way controller (◀ ▶) to select [On] or [Off].
- 3 Press the Playback/OK button. The camera is ready to capture or play back images.

### How to recall the [Set-up] menu

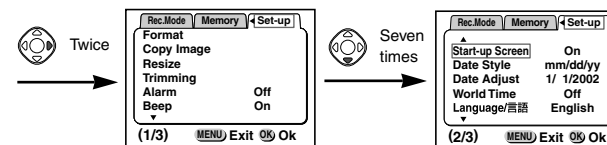
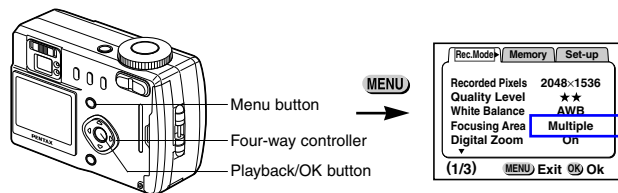

### Changing the Start-up Screen

Images recorded with the Optio 430RS/330RS can be displayed as the start-up screen when the camera is turned on.

- 1 Select [Start-up Screen] on the [Set-up] menu.
- 2 Press the four-way controller ( **▶** ).
- 3 Press the DPOF button.
- 4 Use the four-way controller ( **◀ ▶** ) to select the image you want to use as the start-up screen.
- 5 Press the Playback/OK button.
- 6 Use the four-way controller ( **◀ ▶** ) to select  (On) or  (Off).
- 7 Press the Playback/OK button twice.  
The camera is ready to capture or play back images.



Once set, the start-up screen is not deleted even if you erase the original image, or the format of the built-in memory or CF card.

### Setting the Date Style

You can set the style in which the date is displayed on the camera. Choose [mm/dd/yy], [dd/mm/yy] or [yy/mm/dd].

- 1 Select [Date Style] on the [Set-up] menu.
- 2 Use the four-way controller ( **◀ ▶** ) to change the date style.
- 3 Press the Playback/OK button.  
The camera is ready to capture or play back images with the selected date style.

### Changing the Date/Time

You can change the initial date and time settings.

- 1 Select [Date Adjust] on the [Set-up] menu.
- 2 Press the four-way controller ( **▶** ).  
The date screen will be displayed.

See "Initial Settings" (p.16) for the setting procedure.

### How to recall the [Set-up] menu

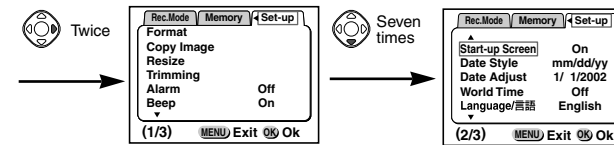
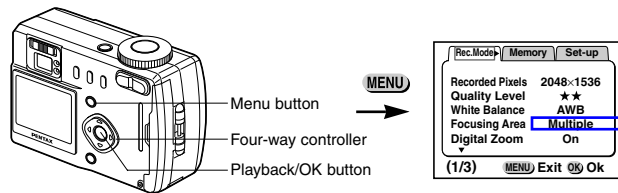

### Setting the World Time

The city and time selected in "Initial Settings" (p.16) serve as the World Time setting.

You can display the time in a city other than the Home Time city (World Time) when shooting or playing back.

- 1 Select [World Time] on the [Set-up] menu.

- 2 Press the four-way controller (▶). The World Time screen will be displayed.

- 3 Switch  (On) and  (Off) with the four-way controller (◀▶).

- : The time in the country selected in World Time will be displayed.
- : The time in the country selected in Home Time will be displayed.

- 4 Press the four-way controller (▼).

The frame will move to [→] (world time city).

- 5 Use the four-way controller (◀▶) to select the World Time city and press the four-way controller (▼).



- 6 Select [DST] On (☼) or Off (no display) with the four-way controller (◀▶) and press the four-way controller (▼).

The frame will move to [☼] (home time city).

Use the four-way controller (◀▶) to change the Home Time city and DST setting.

- 7 Press the Playback/OK button.

The camera is ready to capture or play back images with the time in the selected city.



See p.124 for the list of cities and code names.

### Changing the Display Language

You can change the language in which the menus, error messages, etc. are displayed.

- 1 Select [Language] on the [Set-up] menu.

- 2 Use the four-way controller (▲▼) to select the language.

- 3 Press the Playback/OK button.

The camera is ready to capture or play back images.

### How to recall the [Set-up] menu

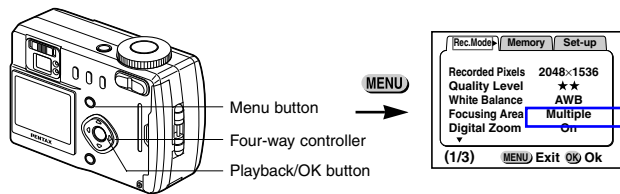

### Powersaving Function (Sleep Timeout)

You can set the LCD monitor to turn off automatically when no operation is performed for a fixed time.

- 1 Select [Sleep Timeout] on the [Set-up] menu.
- 2 Use the four-way controller (◀ ▶) to select [30sec], [1min], [2min] or [Off].
- 3 Press the Playback/OK button.  
The camera is ready to capture or play back images.

### Auto Power Off Function

You can set the camera to turn off automatically when no operation is performed for a fixed time.

- 1 Select [Auto Power Off] on the [Set-up] menu.
- 2 Use the four-way controller (◀ ▶) to select [3min], [5min] or [Off].
- 3 Press the Playback/OK button.  
The camera is ready to capture or play back images.



If you do not perform any operation for one minute after the menu is displayed, the menu will be closed.

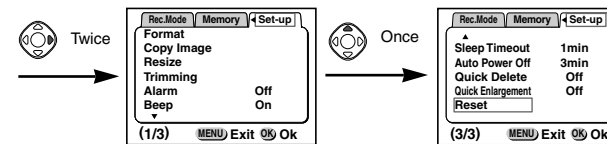

### Quick Delete

When you turn on the quick delete, the Delete screen is displayed with [Delete] and [All Images] selected.

- 1 Select [Quick Delete] on the [Set-up] menu.
- 2 Use the four-way controller (◀ ▶) to select [On] or [Off].
- 3 Press the Playback/OK button.  
The camera is ready to capture or play back images.

### Quick Enlargement

You can play back the image in the maximum enlargement only by pressing the Zoom button once.

- 1 Select [Quick Enlargement] on the [Set-up] menu.
- 2 Use the four-way controller (◀ ▶) to select [Off] or [On].
- 3 Press the Playback/OK button.  
The camera is ready to capture or play back images.

### How to recall the [Set-up] menu

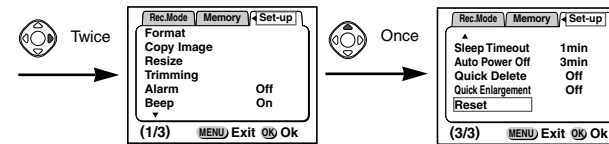
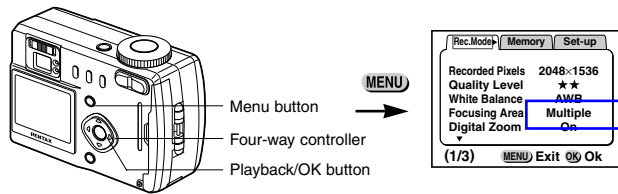

### Resetting to Default Settings (Reset)

You can reset all the settings other than the date and time, language, Home Time, alarm and date style.

- 1** Select [Reset] on the [Set-up] menu.
- 2** Press the four-way controller button (▶).  
The Reset screen will be displayed.
- 3** Use the four-way controller (▲) to select [Reset].
- 4** Press the Playback/OK button.  
The camera is ready to capture or play back images.

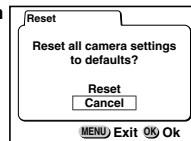

## Appendix List of City Names

Refer to the following list of city and code names for setting the world time.

Code	City Names	Code	City Names
PPG	Pagopago	THR	Tehran
HNL	Honolulu	DXB	Dubai
ANC	Anchorage	KHI	Karachi
YVR	Vancouver	KBL	Kabul
SFO	San Francisco	MLE	Male
LAX	Los Angeles	DEL	Delhi
YYC	Calgary	CMB	Colombo
DEN	Denver	KTM	Kathmandu
MEX	Mexico City	DAC	Dacca
CHI	Chicago	RGN	Rangoon
MIA	Miami	BKK	Bangkok
YTO	Toronto	KUL	Kuala Lumpur
NYC	New York	VTE	Vientiane
SCL	San Diego	SIN	Singapore
CCS	Caracas	PNH	Phnom Penh
YHZ	Halifax	SGN	Ho Chi Minh
BUE	Buenos Aires	JKT	Jakarta
SAO	Sao Paulo	HKG	Hong Kong
RIO	Rio de Janeiro	PER	Perth
MAD	Madrid	BJS	Beijing
LON	London	SHA	Shanghai
PAR	Paris	MNL	Manila
MIL	Milan	TPE	Taipei
ROM	Rome	SEL	Seoul
BER	Berlin	ADL	Adelaide
JNB	Johannesburg	TYO	Tokyo
IST	Istanbul	GUM	Guam
CAI	Cairo	SYD	Sydney
JRS	Jerusalem	NOU	Noumea
MOW	Moscow	WLG	Wellington
JED	Jeddah	AKL	Auckland

## Messages

Messages such as the following may be displayed on the LCD monitor during camera operation.





Compression error	Compression of the image you captured has failed. Change the recorded pixels or quality levels, and take a picture again.
Memory card full	The memory card is full and no more images can be saved. Insert a new CF card or delete unwanted images. (p.14, p.81) Change the quality/size and try again. (p.63, p.64)
Built-in Memory Full	The built-in memory is full and no more images can be saved. Delete unwanted images. (p.81) Change the quality/size and try again. (p.63, p.64)
No image	There are no images in the camera.
Camera can not display this image.	You are trying to play back an image in a format not supported by this camera. You may be able to display it on another brand of camera or PC.
This image is protected.	The image you are trying to delete is a protected image. (p.83)
Battery depleted.	The battery is exhausted. Charge the battery or replace with a charged battery. (p.10, p.11)
Battery depleted, the image is not stored.	The battery is exhausted. The image you just captured has not been saved. Charge the battery or replace with a charged battery. (p.10, p.11)
Memory card error.	Shooting and playback are impossible due to a problem with the CF card. Try displaying on a PC.





This card is not formatted.	The card you have inserted is unformatted or has been formatted on a PC or other device. (p.112)
Image recording...	The image is being recorded.
DPOF settings recording	The DPOF settings are being recorded on the CF card.
Movie recording...	The movie picture is being recorded.
(Un)Protecting...	The image is being protected or unprotected.
Formatting...	The built-in memory or CF card is being formatted.
Deleting	The image is being deleted.
Alarm was set.	The alarm has been enabled.
Image folder could not be created.	The largest file number is assigned to an image and no more images can be saved. Insert a new CF card or format the CF card. (p.112)
Memory card full. Cannot Copy.	The CF card memory is full. No more images can be copied. Set a new CF card, or delete unnecessary images (p.14, p.81). More images may be saved if you change the quality or record size (p.63, p.64).
Built-in Memory Full. Cannot Copy.	The built-in memory is full. No more images can be copied. Delete unnecessary images (p.81). More images may be saved if you change the quality or record size (p.63, p.64).

## Troubleshooting

Problem	Cause	Remedy
Power will not come on	Battery is not installed	Check battery is installed. If not, install battery.
	CF card cover is open	Close CF card cover.
	Battery is installed incorrectly	Check orientation of battery. Reinsert the battery with the label towards back of camera. (p.11)
	Battery power is low	Insert charged battery or use the AC adapter.
No image on the LCD monitor	LCD monitor is set to OFF	Press Display button to turn LCD monitor on. (p.34, p.79)
	Image is displayed but is hard to see	Image on LCD monitor may be hard to see when taking pictures outside in sunlight.
Shutter will not release	Camera is set to Playback mode	Press the Playback/OK button or the shutter release button halfway to set the camera to Capture mode.
	Flash is charging	When flash lamp blinks red, flash is charging and no pictures can be taken. Lamp lights red when charging is completed.
	No available space in built-in memory or on CF card	Insert CF card with available space or delete unwanted images. (p.14, p.81)
	Recording	Wait until recording is finished.

Problem	Cause	Remedy
Subject is not in focus	Subject difficult to focus on	Subjects difficult to focus on using autofocus: objects with little contrast (blue sky, white walls, etc.), dark objects, finely patterned objects, fast-moving objects, scenery through window or net, etc. Lock focus on another object located at same distance (press shutter release button halfway), then aim at target and press shutter release button fully.
	Subject is not in focusing area	Position subject in square frame (focusing area) in middle of LCD monitor. If the subject is outside the focusing area, aim the camera at the subject and lock focus (press shutter release button halfway), then compose picture and press the shutter release button fully.
	Subject is too close	Set focus mode on  . (p.58)
	Focus mode is set on 	Normal pictures will be out of focus if taken with focus mode set on  .
	Focus mode is set on manual	If using manual focus, adjust focus using four-way controller (   ). (p.59).
Subject is not clear in viewfinder	Diopter is not correctly adjusted	Camera viewfinder is not correctly adjusted for optimum clarity. Adjust with diopter adjustment lever. (p.57).

Problem	Cause	Remedy
Picture is dark	Subject is too far away	Picture becomes dark if subject is too far away. Take picture within range of flash.
	Background is dark	When taking a picture of a person against dark background, such as night scene, the person may appear dark if the flash does not reach background even with correct exposure. Set to  mode to ensure both person and background are clear. (p.38)
Flash does not fire	Flash mode is set to Off	Set to Auto or  . (p.35, p.62)
	The Capture mode is set to  , continuous shooting, or Infinity-landscape mode.	Flash will not fire in these modes.
Images cannot be recorded in the built-in memory, or images recorded in the built-in memory cannot be played back.	The CF card is installed.	If the CF card is installed, all images will be recorded on the CF card. Also, in the Playback mode, only images recorded on the CF card can be played back. To record images in the built-in memory or to playback images recorded in the built-in memory, the CF card must first be removed.

## Main Specifications

Type	Compact-type digital still camera with built-in zoom lens, autofocus, auto exposure and auto flash.
Effective pixels	4.0 megapixel (430RS), 3.2 megapixel (330RS)
Sensor	Total pixels – 4.13 megapixel (Optio 430RS), 3.34 megapixel (Optio 330RS) 1/1.8 inch interline transfer CCD with a primary color filter.
Color Depth	10 bit × 3 colors.
Recorded Pixels	Still – 2304 × 1712 pixels (430RS), 2240 × 1680 pixels (430RS), 2048 × 1536 pixels (330RS), 1600 × 1200 pixels, 1024 × 768 pixels, 640 × 480 pixels Movie – 320 × 240 pixels.
Sensitivity	Auto, fixed (equivalent to ISO 100, 200 (430RS); ISO 125, 250 (330RS)).
File Formats	Still – JPEG (Exif 2.2), DCF, DPOF. Movie – AVI (Open DML Motion JPEG), 15fps.
Quality Levels	“Good”, “Better”, “Best”.
Storage Media	Built-in memory (approx. 11MB), CompactFlash (CF) card Type I
Lens	Pentax power zoom 7.6 mm - 22.8 mm (Equivalent to 37.5mm - 112.5 mm in 35 mm format) F2.6 - F4.8, 7 elements in 6 groups (2 dual-sided aspherical elements).
Digital Zoom	1× – 2×.
Focusing System	
Type	TTL contrast detection autofocus system. Manual focus / Infinity-landscape mode available.
Focusing Areas	7-point autofocus and spot.
Focusing Range	Autofocus: Normal 0.4 m (1.31 ft) to infinity. Macro 0.14 m (0.46 ft) to 0.5 m (1.64 ft). Manual focus: 0.14 m (0.46 ft) to infinity.

Exposure Control	
Metering System	TTL metering. Choice of Multi-segment metering, Center-weighted metering and Spot metering.
Exposure Modes	Standard, Night Scene, Metered Manual, Movie, Multiple Exposure.
Exposure Compensation	±2 EV (1/3 steps).
Movie	Shooting time: approx. 1 sec. - 30 sec.
Shutter	Programmed AE electronic lens shutter with CCD electronic shutter. Shutter speed: approx. 1/2000 sec. to 4 sec.
Drive Modes	One shot, Continuous, Self-timer, Remote control and Interval.
Flash	Built-in series-control auto flash. Automatic discharge under low lighting condition in auto modes. Flash-on and flash-off modes. “Red-eye” reduction function employs a single discharge.
White Balance	Auto, Daylight, Shade, Tungsten Light, Fluorescent Light and Manual setting.
Optical Viewfinder	Actual-image zoom viewfinder with diopter adjustment from -3 m <sup>-1</sup> to +1 m <sup>-1</sup> .
LCD Monitor	1.6 inch. TFT color LCD. Field of view: 100%
LCD Functions	Nine-image and 1x – 4x magnification available in Playback mode.
Number of recordable images	Approx. 250 (with the flash fired for 50 % of the shots. LCD monitor ON) *In accordance with Pentax photographic conditions.
Interfaces	USB terminal and DC input terminal.
Power Sources	Lithium-ion (rechargeable) battery allows approx. 250 shots (with the flash fired for 50% of the shots and LCD monitor ON) to be taken with one charge*. Optional AC adapter is also available. *According to tests conducted in-house by Pentax. Maximum charge takes approximately 120 minutes.
Dimensions	92 (W) × 59 (H) × 32 (D) mm (D: max 34.5 mm) (3.6 × 2.3 × 1.3/1.4 inches).
Weight	200 g (7.1 oz.) without battery and CF card. 235 g (8.3 oz.) including battery and CF card.

## Optional Accessories

A number of dedicated accessories are available for this camera.

- AC adapter (D-AC2)
- Battery Charger (D-BC2)
- AC Plug Cord
  - D-CO2A Australia
  - D-CO2B United Kingdom
  - D-CO2E Europe
  - D-CO2H Hong Kong
  - D-CO2J Japan
  - D-CO2K Korea
  - D-CO2U North America, Canada
- Rechargeable lithium ion battery D-LI2
- Remote control F
- Remote control E
- USB Cable (I-USB6)
- Strap (O-ST5)
- Camera case (O-CC2)
- Waterproof case (O-WP1)

## WARRANTY POLICY

All Pentax cameras purchased through authorized bona fide photographic distribution channels are guaranteed against defects of material or workmanship for a period of twelve months from date of purchase. Service will be rendered, and defective parts will be replaced without cost to you within that period, provided the equipment does not show evidence of impact, sand or liquid damage, mishandling, tampering, battery or chemical corrosion, operation contrary to operating instructions, or modification by an unauthorized repair shop. The manufacturer or its authorized representatives shall not be liable for any repair or alterations except those made with its written consent and shall not be liable for damages from delay or loss of use or from other indirect or consequential damages of any kind, whether caused by defective material or workmanship or otherwise; and it is expressly agreed that the liability of the manufacturer or its representatives under all guarantees or warranties, whether expressed or implied, is strictly limited to the replacement of parts as hereinbefore provided. No refunds will be made on repairs by non-authorized Pentax service facilities.

### Procedure During 12-month Warranty Period

Any Pentax which proves defective during the 12-month warranty period should be returned to the dealer from whom you purchased the equipment or to the manufacturer. If there is no representatives of the manufacturer in your country, send the equipment to the manufacturer, with postage prepaid. In this case, it will take a considerable length of time before the equipment can be returned to you owing to the complicated customs procedures required. If the equipment is covered by warranty, repairs will be made and parts replaced free of charge, and the equipment will be returned to you upon completion of servicing. If the equipment is not covered by warranty, regular charges of the manufacturer or of its representatives will apply. Shipping charges are to be borne by the owner. If your Pentax was purchased outside of the country where you wish to have it serviced during the warranty period, regular handling and servicing fees may be charged by the manufacturer's representatives in that country. Notwithstanding this, your Pentax returned to the manufacturer will be serviced free of charge according to this procedure and warranty policy. In any case, however, shipping charges and customs clearance fees to be borne by the sender. To prove the date of your purchase when required, please keep the receipt or bills covering the purchase of your equipment for at least a year. Before sending your equipment for servicing, please make sure that you are sending it to the manufacturer's authorized representatives or their approved repair shops, unless you are sending it directly to the manufacturer. Always obtain a quotation for the service charge, and only after you accept the quoted service charge, instruct the service station to proceed with the servicing.

- **This warranty policy does not affect the customer's statutory rights.**
- **The local warranty policies available from Pentax distributors in some countries can supersede this warranty policy. Therefore, we recommend that you review the warranty card supplied with your product at the time of purchase, or contact the PENTAX distributor in your country for more information and to receive a copy of the warranty policy.**

**For customers in the USA****STATEMENT OF FCC COMPLIANCE**

This device complies with Part 15 of the FCC Rules. Operation is subject to the following two conditions: (1) This device may not cause harmful interference, and (2) this device must accept any interference received, including interference that may cause undesired operation.

Changes or modifications not approved by the party responsible for compliance could void the user's authority to operate the equipment.

This equipment has been tested and found comply with the limits for a Class B digital device, pursuant to part 15 of the FCC Rules. These limits are designed to provide reasonable protection against harmful interference in a residential installation. This equipment generates, uses and can radiate frequency energy and, if not installed and used in accordance with the instructions, may cause harmful interference to radio communications. However, there is no guarantee that interference will occur in a particular installation. If this equipment does cause harmful interference to radio or television reception, which can be determined by turning the equipment off and on, the user is encouraged to try to correct the interference by one or more of the following measures:

- Reorient or relocate the receiving antenna.
  - Increase the separation between the equipment and receiver.
  - Connect the equipment into an outlet on a circuit different from that to which the receiver is connected.
- \* Consult the dealer or an experienced radio/TV technician for help.

**For customers in Canada**

This Class B digital apparatus meets all requirements of the Canadian Interference - Causing Equipment Regulations.

**Pour les utilisateurs au Canada**

Cet appareil numérique de la classe B respecte toutes les exigences du Règlement sur le matériel brouilleur du Canada.



The CE Mark is a Directive conformity mark of the European Community.

Appendix

134

## Declaration of Conformity

According to 47CFR, Parts 2 and 15 for  
Class B Personal Computers and Peripherals

We: Pentax Corporation

Located at: 35 Inverness Drive East  
Englewood, Colorado 80112 USA  
Phone: 303-799-8000 Fax: 303-790-1131

Declare under sole responsibility that the product identified herein, complies with 47CFR Parts 2 and 15 of the FCC rules as a Class B digital device. Each product marketed, is identical to the representative unit tested and found to be compliant with the standards. Records maintained continue to reflect the equipment being produced can be expected to be within the variation accepted, due to quantity production and testing on the statistical basis as required by 47CFR §2.909. Operation is subject to the following two conditions: (1) This device may not cause harmful interference, and (2) This device must accept any interference received, including interference that may cause undesired operation. The above named party is responsible for ensuring that the equipment complies with the standards of 47CFR §15.101 to §15.109.

Product Name: PENTAX Digital Still Camera

Model Number: Optio 430RS/330RS

Contact person: Customer Service Manager

Date and Place: June, 2002, Colorado



**Asahi Optical Co., Ltd.** 2-36-9, Maeno-cho, Itabashi-ku, Tokyo 174-8639,  
JAPAN  
(<http://www.pentax.co.jp>)

**Pentax GmbH (European Headquarters)**  
Julius-Vosseler-Strasse 104, 22527 Hamburg,  
GERMANY  
(HQ - <http://www.pentaxeuropa.com>)  
(Germany - <http://www.pentax.de>)

**Pentax U.K. Limited** Pentax House, Heron drive, Langley, Slough, Berks  
SL3 8PN, U.K.  
(<http://www.pentax.co.uk>)

**Pentax France S.A.** 12/14, rue Jean Poulmarch, 95106 Argenteuil Cedex,  
FRANCE

**Pentax Benelux B.V.** (for Netherlands)  
Spinveld 25, 4815 HR Breda, NETHERLANDS  
(<http://www.pentax.nl>)  
(for Belgium & Luxembourg)  
Weiveldlaan 3-5, 1930 Zaventem, BELGIUM  
(<http://www.pentax.be>)

**Pentax (Schweiz) AG** Widenholzstrasse 1 Postfach 367 8305 Dietlikon,  
SWITZERLAND (<http://www.pentax.ch>)

**Pentax Scandinavia AB** P.O. Box 650, 75127 Uppsala, SWEDEN  
(<http://www.pentax.se>)

**Pentax Corporation** 35 Inverness Drive East, Englewood, Colorado 80112,  
U.S.A.  
(<http://www.pentax.com>)

**Pentax Canada Inc.** 3131 Universal Drive, Mississauga, Ontario L4X 2E5,  
CANADA  
(<http://www.pentaxcanada.ca>)

<http://www.digital.pentax.co.jp>

- Printed on recycled paper
- Specifications and external dimensions are subject to change without notice.

57219

Copyright © Asahi Optical Co.Ltd. 2002  
01-200204 Printed in Japan

## Free Manuals Download Website

<http://myh66.com>

<http://usermanuals.us>

<http://www.somanuals.com>

<http://www.4manuals.cc>

<http://www.manual-lib.com>

<http://www.404manual.com>

<http://www.luxmanual.com>

<http://aubethermostatmanual.com>

Golf course search by state

<http://golfingnear.com>

Email search by domain

<http://emailbydomain.com>

Auto manuals search

<http://auto.somanuals.com>

TV manuals search

<http://tv.somanuals.com>