

# PENTAX™

SLR Digital Camera

# *\*istDS2*

---

## Operating Manual



For optimum camera performance, please read the Operating Manual before using the camera.

Download from [Www.Somanuals.com](http://www.Somanuals.com). All Manuals Search And Download.

Thank you for purchasing the PENTAX *\*istDS2* Digital Camera. Please read this manual before using the camera in order to get the most out of all the features and functions. Keep this manual safe, as it can be a valuable tool in helping you to understand all the camera's capabilities.

### **Lenses you can use**

In general, lenses that can be used with this camera are DA, D FA and FA J lenses and lenses that have an Aperture **A** (Auto) position.

To use any other lens or accessory, see p.37 and p.182.

### **Regarding copyrights**

Images taken using the *\*istDS2* that are for anything other than personal enjoyment cannot be used without permission according to the rights as specified in the Copyright Act. Please take care, as there are even cases where limitations are placed on taking pictures even for personal enjoyment during demonstrations, performances or of items on display. Images taken with the purpose of obtaining copyrights also cannot be used outside the scope of use of the copyright as laid out in the Copyright Act, and care should be taken here also.

### **Regarding trademarks**

- PENTAX and smc PENTAX are trademarks of PENTAX Corporation.
- The SD logo  is a trademark.
- All other brands or product names are trademarks or registered trademarks of their respective owners.

### **To users of this camera**

- There is a possibility that recorded data may be erased or that the camera may not function correctly when used in surroundings such as installations generating strong electromagnetic radiation or magnetic fields.
- The liquid crystal panel used in the LCD display is manufactured using extremely high precision technology. Although the level of functioning pixels is 99.99% or better, you should be aware that 0.01% or fewer of the pixels may not illuminate or may illuminate when they should not. However, this has no effect on the recorded image.

This product supports PRINT Image Matching III. PRINT Image Matching enabled digital still cameras, printers and software help photographers to produce images more faithful to their intentions. Some functions are not available on printers that are not PRINT Image Matching III compliant.

Copyright 2001 Seiko Epson Corporation. All Rights Reserved.

PRINT Image Matching is a trademark of Seiko Epson Corporation.

The PRINT Image Matching logo is a trademark of Seiko Epson Corporation.

### **Regarding PictBridge**

PictBridge allows the user to connect the printer and digital camera directly, using the unified standard for the direct printout of images. You can print images directly from the camera through a few simple operations.

- There is a possibility that the illustrations and the display screen of the LCD monitor in this manual are different from the actual product.

## FOR SAFE USE OF YOUR CAMERA

We have paid close attention to the safety of this product. When using this product, we request your special attention regarding items marked with the following symbols.



### **Warning**

This symbol indicates that violating this item could cause serious personal injury.



### **Caution**

This symbol indicates that violating this item could cause minor or medium personal injury, or material loss.

## ABOUT THE CAMERA



### **Warning**

- Do not disassemble or modify the camera. High voltage areas are present inside the camera, with the risk of electric shock.
- If the camera interior is exposed due to dropping or otherwise damaging the camera, never touch the exposed portion. There is the risk of electric shock.
- To avoid the risk of it being swallowed by mistake, keep the SD Memory Card out of the reach of small children. Seek medical attention immediately if a memory card is accidentally swallowed.
- Wrapping the strap around your neck is dangerous. Take care that small children do not hang the strap over their necks.
- Do not look directly at the sun through the camera with the telephoto lens attached, as viewing the sun may damage your eyes. Viewing directly with the telephoto lens may lead to a loss of eyesight.
- Be sure to store batteries out of the reach of children. Seek medical assistance immediately if a battery is accidentally swallowed.
- Always use the AC adapter exclusively developed for this product, with the specified power and voltage. Using an AC adapter not exclusive to this product, or using the exclusive AC adapter with an unspecified power or voltage can cause a fire, electric shock, or camera breakdown.
- If any irregularities occur during use, such as smoke or a strange odor, stop use immediately, remove the batteries or the AC adapter, and contact your nearest PENTAX service center. Continued use could cause a fire or electric shock.
- During thunderstorms, unplug and discontinue use of the AC adapter. Continued use could cause equipment failure, a fire, or electric shock.



### **Caution**

- Do not short the batteries or dispose of the batteries in fire. Do not disassemble the batteries. The batteries could explode or catch fire.
- Do not charge any batteries other than rechargeable Ni-MH batteries. The batteries could explode or catch fire. Of the batteries that can be used in this camera, only the Ni-MH batteries can be recharged.
- Remove the batteries from the camera immediately if they become hot or begin to smoke. Be careful not to burn yourself during removal.
- Some portions of the camera heat up during use. There is the risk of low temperature burns when holding such portions for long periods.
- Do not place your finger or cover with clothing when discharging the flash. Fingers or clothing may be burned.

## **PRECAUTIONS FOR BATTERY USAGE**

- Only use specified batteries with this camera. Use of other batteries can cause a fire or explosion.
- Replace the batteries at the same time. Do not mix battery brands, type or an old battery with a new one. It may cause explosion or a fire.
- The batteries should be inserted correctly with regard to polarity (+ and -) marked on the batteries and the camera. Not inserting batteries correctly may cause explosion or a fire.
- AA lithium batteries, AA alkaline batteries and disposable CR-V3 are not rechargeable. Do not disassemble the batteries. Recharging and disassembling can cause explosion or leakage.

## **Care to be Taken During Handling**

- Take the Worldwide Service Network that is included in the package. This will be useful if you experience problems abroad.
- When the camera has not been used for a long time, confirm that it is still working properly, particularly prior to taking important pictures (such as at a wedding or during traveling). Pictures cannot be guaranteed if recording, playback or transferring your data to a computer, etc. is not possible due to a malfunction of your camera or recording media (SD Memory Card), etc.
- Do not clean the product with organic solvents such as thinner or alcohol benzene.
- Do not subject to high temperatures or high humidity. Do not leave the camera in a vehicle, as the temperature can get very high.

- Do not store the camera with preservatives and chemicals. Storage in high temperatures and high humidity can cause molding. Remove from case and store in a dry and well-ventilated location.
- This camera is not waterproof, and should not be used in the rain or where the camera could get wet.
- Do not subject the camera to strong vibrations, shocks, or pressure. Use a cushion to protect the camera from vibrations of motorcycles, automobiles, or ships.
- The temperature range for camera use is 0°C to 40°C (32°F to 104°F).
- The LCD display may appear black under high temperatures, but will return to normal as temperatures normalize.
- The LCD display may respond more slowly at low temperatures. This is due to liquid crystal properties, and is not a fault.
- Periodic inspections are recommended every one to two years to maintain high performance.
- Sudden temperature changes will cause condensation on the inside and outside of the camera. Place the camera in your bag or a plastic bag, removing the camera after temperature of the camera and surroundings are equalized.
- Avoid contact with garbage, mud, sand, dust, water, toxic gases, or salts. These could cause a camera breakdown. Wipe dry any rain or water drops on the camera.
- Refer to “Precautions When Using the SD Memory Card” (p.30) regarding the SD Memory Card.
- Use a lens brush to remove dust accumulated on the lens or viewfinder. Never use a spray blower for cleaning as it may damage the lens.
- Please do not press forcefully on the LCD monitor. This could cause breakage or malfunction.

#### **Regarding Product Registration**

In order to better service you, we request that you complete the product registration, which can be found on the CD-ROM supplied with the camera or the PENTAX website. Thank you for your cooperation.

Refer to the PENTAX PHOTO Browser 2.1/PENTAX PHOTO Laboratory 2.1 Operating Manual (Windows users: p.10, Mac OS users: p.12) for more information.

## Contents

FOR SAFE USE OF YOUR CAMERA.....	1
ABOUT THE CAMERA.....	1
PRECAUTIONS FOR BATTERY USAGE.....	2
Care to be Taken During Handling.....	2
Contents.....	4
Composition of the Operating Manual.....	9
<b>Before Using Your Camera</b> .....	<b>11</b>
<hr/>	
<b><i>*istDS2</i> Camera Characteristics</b> .....	<b>12</b>
<b>Checking the Contents of the Package</b> .....	<b>13</b>
<b>Names of Working Parts</b> .....	<b>14</b>
Camera.....	14
LCD Monitor Indications.....	16
Viewfinder Indications.....	20
LCD Panel Indications.....	22
<b>Getting Started</b> .....	<b>23</b>
<hr/>	
<b>Attaching the Strap</b> .....	<b>24</b>
<b>Inserting the Batteries</b> .....	<b>25</b>
Batteries.....	26
Battery Level Indicator.....	27
Approximate Image Storage Capacity and Playback Time (new batteries).....	27
Using the AC Adapter (Optional).....	28
<b>Inserting/Removing the SD Memory Card</b> .....	<b>29</b>
Recorded Pixels and Quality Level.....	31
<b>Turning the Camera On and Off</b> .....	<b>32</b>
<b>Initial Settings</b> .....	<b>33</b>
Setting the Display Language.....	33
Setting the Date and Time.....	35
<b>Attaching the Lens</b> .....	<b>37</b>
<b>Adjusting the Viewfinder Diopter</b> .....	<b>39</b>

# Basic Operations





41

<b>Basic Shooting Operation</b> .....	<b>42</b>
Holding the Camera .....	42
Letting the Camera Choose the Optimal Settings .....	43
<b>Selecting the Appropriate Capturing Mode for Scenes</b> .....	<b>47</b>
<b>Using the Zoom Lens</b> .....	<b>48</b>
<b>Using the Built-in Flash</b> .....	<b>49</b>
<b>Other Shooting Modes</b> .....	<b>53</b>
Continuous Shooting .....	53
Self-Timer Shooting .....	55
Remote Control Shooting (Remote Control F: Sold Separately) .....	59
Using Mirror Lock Up Function to Prevent Camera Shake .....	62
<b>Playing Back Still Pictures</b> .....	<b>63</b>
Playing Back Images .....	63
Enlarging Playback Images .....	65
Nine-Image Display .....	66
Slideshow .....	68
<b>Connecting the Camera to AV Equipment</b> .....	<b>70</b>
<b>Processing Images with Filters</b> .....	<b>71</b>
<b>Deleting Images</b> .....	<b>73</b>
Deleting a Single Image .....	73
Deleting All Images .....	74
Deleting Selected Images (from Nine-Image Display) .....	75
Protecting Images from Deletion (Protect) .....	77
<b>Setting the Printing Service (DPOF)</b> .....	<b>79</b>
Printing Single Images .....	79
Settings for All Images .....	81
<b>Printing Using PictBridge</b> .....	<b>83</b>
Setting [Transfer Mode] .....	84
Connecting the Camera to the Printer .....	85
Printing Single Images .....	86
Printing All Images .....	88
Printing Images Using the DPOF Settings .....	90
Disconnecting the Cable from the Printer .....	90

## Menu Reference

91

---

<b>Using the Button Functions .....</b>	<b>92</b>
Capture Mode .....	92
Playback Mode .....	94
<b>Using the Menu .....</b>	<b>96</b>
How to Operate the Menu.....	96
[  Rec. Mode] Menu Setting Items .....	98
[  Playback] Menu Setting Items .....	98
[  Set-up] Menu Setting Items .....	99
[  Custom Setting] Menu Setting Items .....	100
<b>Using the Fn Menu .....</b>	<b>102</b>
Capture Mode .....	102
Playback Mode .....	103
<b>Using the Mode Dial.....</b>	<b>104</b>

## Function Reference

107

---

<b>Setting the Recorded Pixels and Quality Level.....</b>	<b>108</b>
Setting the Image Tone .....	108
Setting the Recorded Pixels .....	109
Setting the Quality Level.....	110
Setting the Saturation/Sharpness/Contrast .....	111
Setting the White Balance .....	112
Setting the Sensitivity .....	115
Setting the Color Space.....	117
<b>Focusing .....</b>	<b>118</b>
Using the Autofocus.....	118
Setting the AF Mode .....	121
Selecting the Focusing Area (Focus Point) .....	122
Fixing the Focus (Focus Lock).....	124
Adjusting the Focus Manually (Manual Focus).....	126
<b>Setting the Exposure .....</b>	<b>128</b>
Effect of Aperture and Shutter Speed.....	128
Selecting the Metering Method.....	131
Changing the Exposure Mode .....	133
Setting the Exposure .....	142
Changing the Exposure and Shooting (Auto Bracket).....	144



<b>Using the Built-in Flash .....</b>	<b>147</b>
Compensating Flash Output .....	147
Allowing Shooting while Charging Flash.....	148
Flash Characteristics in Each Exposure Mode .....	148
Distance and Aperture when Using the Built-in Flash .....	150
DA, D FA , FA J, FA and F Lens Compatibility with the Built-in Flash .....	152
Using an External Flash (Optional).....	154
<b>Settings During Playback.....</b>	<b>161</b>
Changing Playback Display Method .....	161
Displaying Bright Portion Warning .....	161
Setting the Slideshow Display Interval.....	162
<b>Camera Settings.....</b>	<b>163</b>
Formatting the SD Memory Card .....	163
Turning the Beep On and Off.....	164
Changing the Date and Time and the Display Style .....	164
Setting the World Time .....	165
Setting the Display Language.....	168
Turning the Guide Display On and Off.....	168
Adjusting the Brightness of the LCD Monitor .....	169
Selecting the Video Output Format.....	169
Setting Auto Power Off .....	170
Resetting the File Number .....	170
Setting the Instant Review .....	171
<b>Resetting to Default Settings .....</b>	<b>172</b>
Resetting Rec. Mode/Playback/Set-up Menu .....	172
Resetting the Custom Function Menu .....	173

# Appendix

175

---

<b>Default Settings</b> .....	<b>176</b>
<b>Functions Available with Various Lens Combinations</b> .....	<b>180</b>
<b>Notes on [Using Aperture Ring]</b> .....	<b>182</b>
<b>Cleaning the CCD</b> .....	<b>183</b>
<b>Optional Accessories</b> .....	<b>185</b>
<b>Error Messages</b> .....	<b>188</b>
<b>Troubleshooting</b> .....	<b>190</b>
<b>Main Specifications</b> .....	<b>192</b>
Specifications for Remote Control F (Optional) .....	195
<b>Glossary</b> .....	<b>196</b>
<b>Index</b> .....	<b>200</b>
<b>WARRANTY POLICY</b> .....	<b>204</b>

# Composition of the Operating Manual

This operating manual contains the following chapters.

## 1 Before Using Your Camera

Explains camera characteristics, accessories and the names of various parts.

## 2 Getting Started

Explains your first steps from purchasing the camera to taking pictures. Be sure to read it and follow the instructions.

## 3 Basic Operations

Explains the procedures for taking, playing back, and printing still pictures. Read it to learn all of the basic operations about capturing, playing back, and printing.

## 4 Menu Reference

Explains the functions of *\*istDS2* by buttons and menus.



## 5 Function Reference

Introduces functions to further enhance your *\*istDS2* experience.

## 6 Appendix

Explains troubleshooting, introduces optional accessories and provides various resources.

The symbols used in this operating manual are explained below.

	Shows reference page number explaining a related operation.
	Shows useful information.
	Shows precautions to take when operating the camera.



# 1 Before Using Your Camera

---

Check the package contents and names of working parts before use.

<b><i>*istDS2</i> Camera Characteristics .....</b>	<b>12</b>
<b>Checking the Contents of the Package .....</b>	<b>13</b>
<b>Names of Working Parts .....</b>	<b>14</b>

- Features a 23.5×15.7 mm CCD with 6.1 million effective pixels for high precision and a wide dynamic range.
- Features an AF sensor with 11 focusing points. The central 9 are wide cross area sensors.
- Improved manual focusing using a viewfinder similar to a conventional 35 mm SLR camera, with 0.95× magnification. Also features a superimpose function in which the focus points on the viewfinder illuminate red.
- Uses CR-V3, AA lithium batteries, rechargeable AA Ni-MH batteries or AA alkaline batteries.
- Features a large 2.5-inch LCD monitor with 210,000 pixels and a brightness adjusting function for high-precision viewing performance.
- Concepts of Universal Design have been implemented to various parts of the camera. The large, high-resolution LCD monitor and easy-to-use menus make the camera easier to operate.

The captured area (view angle) will differ between the **\*istDS2** and 35 mm SLR cameras even if the same lens is used because the format size for 35 mm film and CCD are different.

Sizes for 35 mm film and CCD

35 mm film	:	36×24 mm
<b>*istDS2</b> CCD	:	23.5×15.7 mm

Angles of view being equal, the focal length of a lens used with a 35 mm camera must be approximately 1.5 times longer than that of **\*istDS2**. To obtain a focal length framing the same area, divide the focal length of the 35 mm lens by 1.5.

Example) To capture the same image as a 150 mm lens attached to a 35 mm camera

$$150 \div 1.5 = 100$$

Use a 100 mm lens with the **\*istDS2**.

Inversely, multiply the focal length of the lens used with **\*istDS2** by 1.5 to determine the focal length for 35 mm cameras.

Example) If 300 mm lens is used with **\*istDS2**

$$300 \times 1.5 = 450$$

Focal length is equivalent to 450 mm lens on a 35 mm camera.

The following accessories are packaged with your camera.  
Check that all accessories are included.



Hot shoe cover F<sub>k</sub>  
(Installed on camera)



Eyecup F<sub>l</sub>  
(Installed on camera)



ME Viewfinder cap

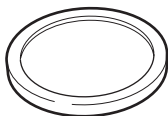

Body mount cover  
(Installed on camera)

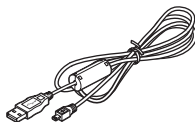

USB cable  
I-USB17

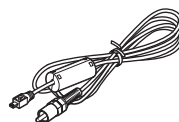

Video cable  
I-VC28



Software (CD-ROM)  
S-SW43

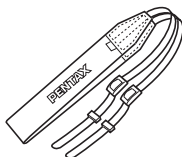

Strap  
O-ST10



AA Alkaline batteries\*  
(four)

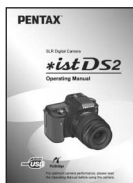

Operating Manual  
(this manual)

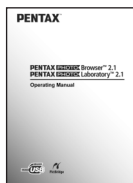

PENTAX PHOTO Browser 2.1/  
PENTAX PHOTO Laboratory 2.1  
Operating Manual

\* The batteries packaged with the camera are for checking the camera's functionality.

1

Before Using Your Camera

## Camera

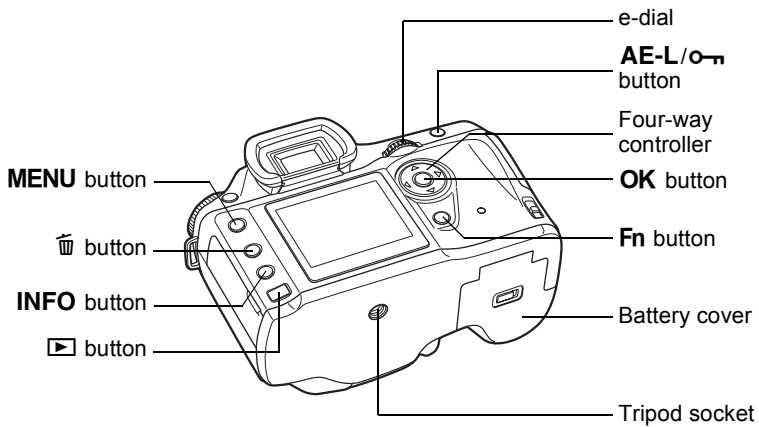
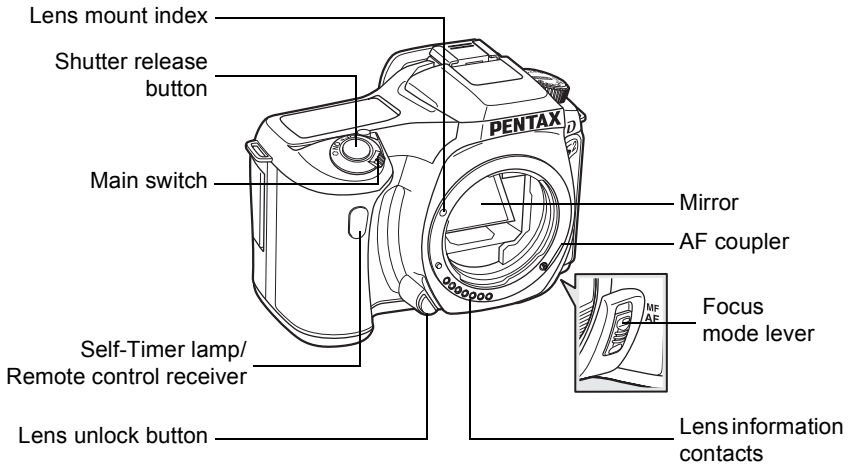



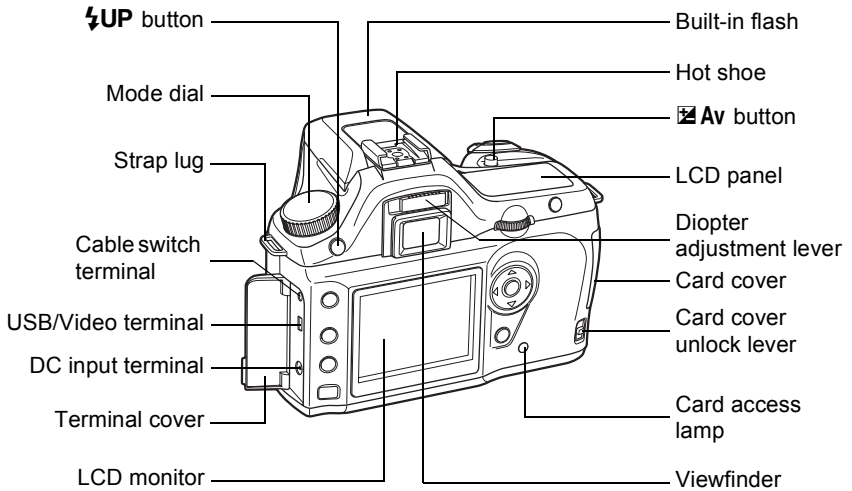

## LCD Monitor Indications

The following indicators appear on the LCD monitor depending on the status of the camera.

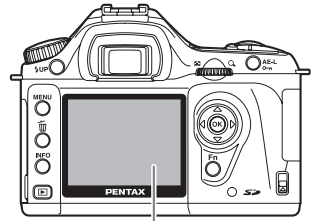

LCD monitor

### While Power is On or Operating Mode Dial

Guides appear on the LCD monitor for 3 seconds when powered on or setting dial mode.



Select [Off] for [Guide display] in [X↓ Set-up] memo to not show indicators. (p.99)

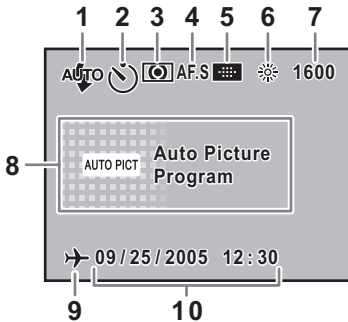

- 1 Flash mode  
(Active mode appears) (p.49)
- 2 Drive mode (p.102)
- 3 AE metering (p.131)
- 4 AF mode (p.121)
- 5 Switch focus point (p.122)
- 6 White balance (p.112)
- 7 Sensitivity (p.115)
- 8 Shooting mode  
(Mode dial position) (p.104)
- 9 World time warning display (p.165)
- 10 Date and time (p.164)

\* Indicators 3,4,5,6 and 7 only appear when the setting other than the default setting is selected. 9 only appears when World Time is On (☑).

1

Before Using Your Camera

## Capture Mode

Press the **INFO** button in capture mode to display the capture function settings on the LCD monitor for 15 seconds.

### ● Detailed Information

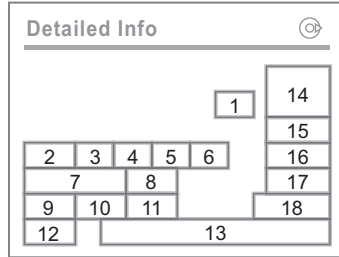
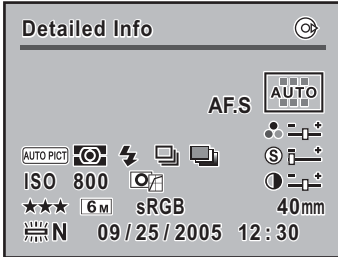

- |                           |                                 |
|---------------------------|---------------------------------|
| 1 AF mode (p.121)         | 10 Recorded pixels (p.109)      |
| 2 Shooting mode (p.104)   | 11 Color space (p.117)          |
| 3 AE metering (p.131)     | 12 White balance (p.112)        |
| 4 Flash mode (p.49)       | 13 Date and time (p.164)        |
| 5 Drive mode (p.102)      | 14 Focus point location (p.122) |
| 6 Auto bracket (p.146)    | 15 Saturation (p.111)           |
| 7 ISO sensitivity (p.115) | 16 Sharpness (p.111)            |
| 8 Image tone (p.108)      | 17 Contrast (p.111)             |
| 9 Quality level (p.110)   | 18 Lens focal length            |

Press the four-way controller (▶) to view explanation of set mode dial.

### ● Explanation of Set Mode Dial

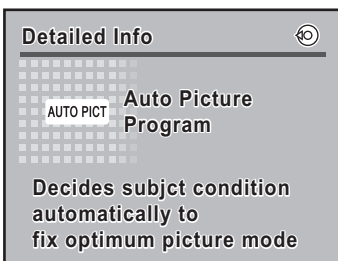

## Playback Mode

The camera switches screen displays every time you press **INFO** button during playback.



You can change the information initially displayed by pressing the **INFO** button. (p.161)

### ● Detailed Information

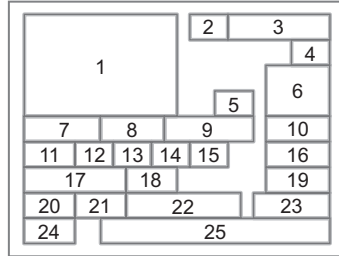
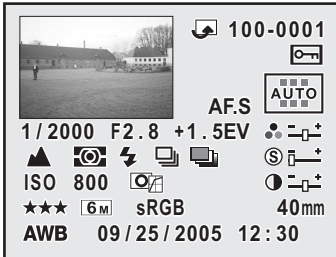

- |    |   |    |                                |
|----|---|----|--------------------------------|
| 1  | Captured images                             | 13 | Flash mode (p.49)              |
| 2  | Rotate icon (p.64)                          | 14 | Drive mode (p.102)             |
| 3  | Image folder number and file number (p.170) | 15 | Auto bracket (p.146)           |
| 4  | Protect icon (p.77)                         | 16 | Sharpness (p.111)              |
| 5  | AF mode (p.121)                             | 17 | ISO sensitivity (p.115)        |
| 6  | Focus point information (p.122)             | 18 | Image tone (p.108)             |
| 7  | Shutter speed (p.135)                       | 19 | Contrast (p.111)               |
| 8  | Aperture (p.137)                            | 20 | Quality level (p.110)          |
| 9  | EV compensation (p.142)                     | 21 | Recorded pixels (p.109)        |
| 10 | Saturation (p.111)                          | 22 | Color space (p.117)            |
| 11 | Shooting mode (p.104)                       | 23 | Lens focal length              |
| 12 | AE metering (p.131)                         | 24 | White balance (p.112)          |
|    |   | 25 | Captured date and time (p.164) |

## ● Histogram Display

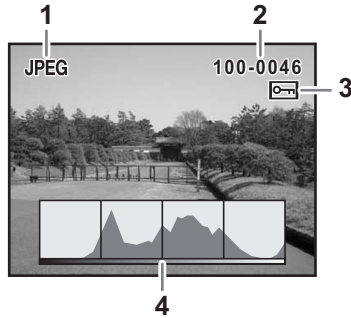

- 1 Capture quality (Image file type)
- 2 Image folder number and file number (p.170)
- 3 Protect icon (p.77)
- 4 Histogram



- Areas where blooming occurred blink if [Bright Portion] warning is on. (p.161)
- Press the four-way controller (▲▼) in the histogram display to move the Histogram display position up or down.

## Viewfinder Indications

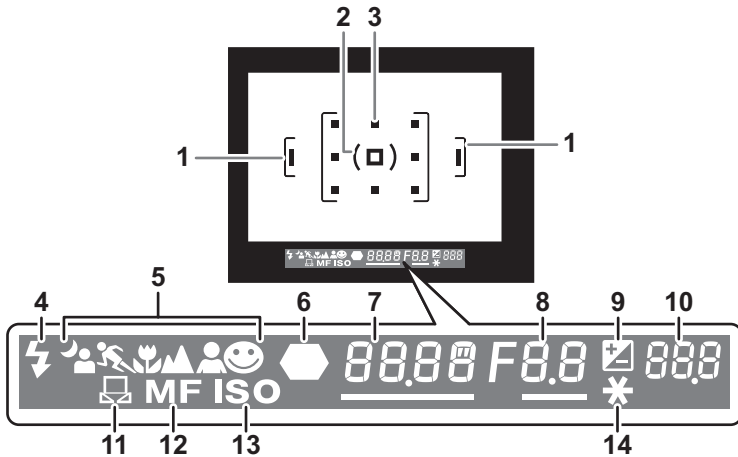

- 1 Autofocus frame (p.39)
- 2 Spot metering frame (p.131)
- 3 Focus point (p.122)
- 4 Flash status (p.49)  
Appears when flash is available and blinks when flash is recommended but not set.
- 5 Picture mode icon (p.47)  
Icon for Picture mode in use appears.  
🌃 Night Scene Portrait, 🚶 Moving Object, 🌸 Macro, 🏔 Landscape, 👤 Portrait, 😊 Normal
- 6 Focus indicator (p.44)  
Appears when image is focused. When blinking indicates an out of focus subject.
- 7 Shutter speed (p.135)  
Shutter speed when capturing or adjusting (underlined when shutter speed can be adjusted with e-dial).
- 8 Aperture (p.137)  
Aperture when capturing or adjusting (underlined when aperture can be adjusted with e-dial).

- 9 EV compensation (p.142)  
Appears when EV compensation is available or in use.  
Blinks slowly when compensating flash output.  
Blinks quickly when compensating exposure and flash output.  
Adjusted value appears where number of recordable images is shown.
- 10 Number of recordable images/EV compensation  
Show the number of recordable images with current quality and recorded pixel setting.  
Show the number of continuous shooting recordable images. (p.100)  
EV compensation value appears when EV compensation is being adjusted. (p.134)  
The difference with the appropriate exposure value appears if exposure mode is **M**. (p.139)
- 11 Manual white balance (p.113)  
Appears when manual white balance is in use and blinks while adjusting.
- 12 Manual focus (p.126)  
Appears when focus mode is **MF**.
- 13 ISO sensitivity warning (p.116)  
Appears when warning value is exceeded.
- 14 AE lock indicator (p.143)  
Appears during AE lock.



The red indication of the focus point used for autofocus lightens superimposed when the shutter release button is pressed halfway. (p.122)

## LCD Panel Indications

The following information appears in the LCD panel on top of the camera.

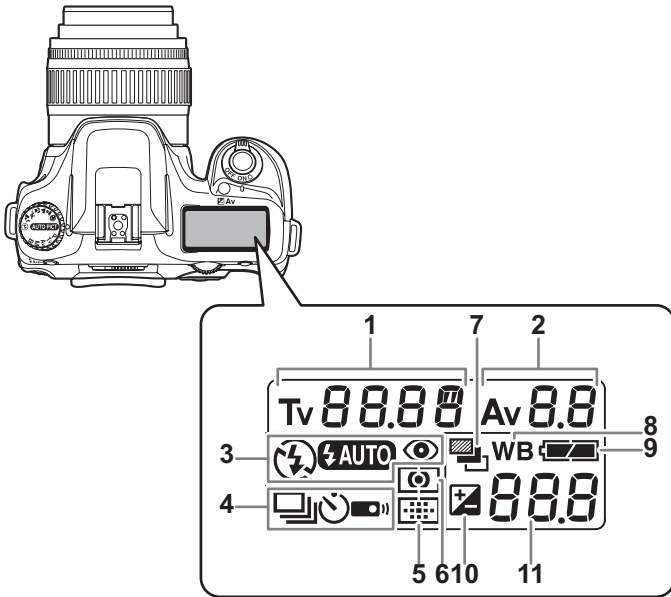

- |   |  |
|---|--|
| <p><b>1</b> Shutter speed (p.135)</p> <p><b>2</b> Aperture (p.137)</p> <p><b>3</b> Flash mode (p.49)</p> <p>⚡ : Built-in flash is ready<br/>(when blinking, flash should<br/>be used)</p> <p>Ⓞ : Flash off</p> <p>⚡AUTO : Auto discharge</p> <p>Ⓞ : Red-eye reduction flash on</p> <p><b>4</b> Drive mode (p.102)</p> <p>□ : Single frame shooting</p> <p>📄 : Continuous shooting</p> <p>⌚ : Self-Timer shooting</p> <p>📡 : Remote control shooting</p> <p><b>5</b> Focus point information (p.122)</p> <p>No indicator: Auto</p> <p>📄 : Select</p> <p>□ : Center</p> | <p><b>6</b> AE metering (p.131)</p> <p>No indicator:<br/>Multi-segment metering</p> <p>☉ : Center-weighted<br/>metering</p> <p>□ : Spot metering</p> <p><b>7</b> Auto bracketing (p.146)</p> <p><b>8</b> White balance (p.112)<br/>(Not displayed when set to Auto)</p> <p><b>9</b> Battery level</p> <p><b>10</b> EV compensation (p.142)</p> <p><b>11</b> Number of recordable images/<br/>EV compensation value/PC (Pb)<br/>(PC=Personal Computer (mass<br/>storage), Pb=PicBridge)</p> |
|---|--|



# 2 Getting Started

---

This chapter explains your first steps from purchasing the camera to taking pictures. Be sure to read it and follow the instructions.

<b>Attaching the Strap .....</b>	<b>24</b>
<b>Inserting the Batteries .....</b>	<b>25</b>
<b>Inserting/Removing the SD Memory Card .....</b>	<b>29</b>
<b>Turning the Camera On and Off .....</b>	<b>32</b>
<b>Initial Settings .....</b>	<b>33</b>
<b>Attaching the Lens .....</b>	<b>37</b>
<b>Adjusting the Viewfinder Diopter .....</b>	<b>39</b>

# Attaching the Strap

- 1** Pass the end of the strap through the strap lug, then secure on the inside of the clasp.

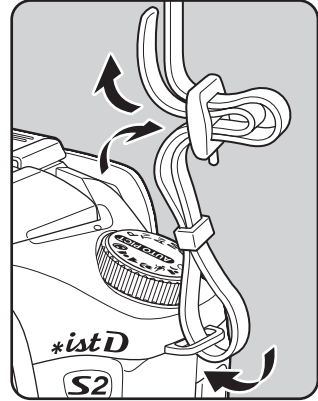

- 2** Pass the other end of the strap through the other strap lug on the camera, then secure on the inside of the clasp.

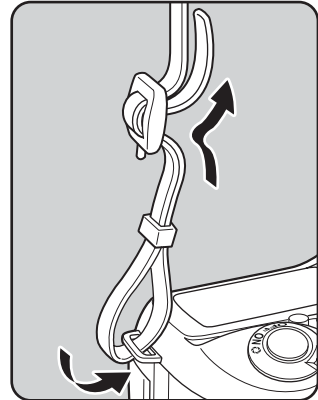

Insert batteries into the camera. Use two CR-V3 or four AA Ni-MH batteries, AA lithium batteries, or AA alkaline batteries.

This camera is packaged with AA alkaline batteries for checking the camera's functionality but some other kinds of batteries are also compatible. Refer to "Batteries" (p.26) for details on compatible batteries and when to use them.



- CR-V3, AA lithium batteries and AA alkaline batteries are not rechargeable.
- Do not open the battery cover or remove the batteries while the power is on.
- Remove the batteries when you will not use the camera for a long while. The batteries may leak.
- If the date and time settings have been reset when you insert new batteries after a long while, follow the procedure for "Setting the Date and Time". (p.35)
- Insert batteries correctly. Batteries inserted incorrectly may cause a camera breakdown. Wipe the electrodes of the batteries before inserting.
- Replace all the batteries at the same time. Do not mix battery type, brands or an old battery with a new one.

**1** Push and hold the battery cover unlock lever as shown in the illustration (①), and slide the battery cover toward the lens (②), and then flip open.

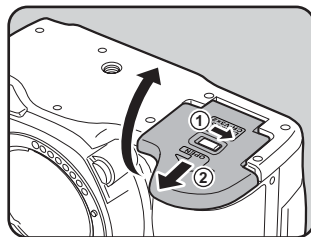

**2** Insert the batteries according to the +/– indicators in the battery chamber.

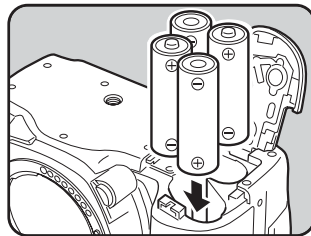

3

Press down on the batteries with the battery cover (①) and slide it as shown in the illustration (②) to close.

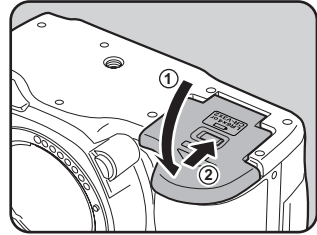

2

Getting Started



- Use the AC adapter (optional) when using the camera for a prolonged period. (p.28)
- Check the battery orientation if the camera does not operate properly after replacing the batteries.

## Batteries

You can use four kinds of batteries with your camera. Battery performance differs by type. Please choose the type that best suits your purpose.





CR-V3	The CR-V3 is a long-life battery and is convenient when traveling.
AA Ni-MH rechargeable batteries	These are rechargeable and are economical.
AA lithium batteries	Recommended in cold climates.
AA alkaline batteries	Provided with the camera. These are easily obtainable when your usual batteries run out but they may not support all the camera functions under certain conditions. We do not recommend their use except in emergencies and checking the camera's functionality.



Oxyride batteries and rechargeable CR-V3 batteries may cause malfunctions due to their voltage characteristics so their use is not recommended.

## Battery Level Indicator

You can confirm remaining battery level by checking the  displayed on the LCD panel.

	lit	: Battery is full.
↓		
	lit	: Battery is running low.
↓		
	lit	: Battery is almost empty.
↓		
	blink	: The camera turns off after displaying a message.

## Approximate Image Storage Capacity and Playback Time (new batteries)

Batteries	(Temperature)	Normal recording	Flash photography		Playback time
			50% use	100% use	
CR-V3	(23°C)	850	750	650	700 minutes
	( 0°C)	560	500	410	470 minutes
AA lithium batteries	(23°C)	750	650	550	470 minutes
	( 0°C)	670	570	470	400 minutes
AA rechargeable batteries (NiMH 2500mAh)	(23°C)	560	500	440	350 minutes
	( 0°C)	500	440	380	300 minutes
AA Alkaline Batteries	(23°C)	90	70	50	140 minutes
	( 0°C)	Not applicable	Not applicable	Not applicable	70 minutes

The still picture storage capacity is based on measuring conditions in accordance with CIPA standards and the playback time is based on PENTAX measuring conditions. Some deviation from the above figures may occur in actual use depending on shooting mode and shooting conditions.



- Battery performance temporarily decreases as the temperature decreases. When using the camera in cold climates, have extra batteries on hand and keep them warm in your pocket. Battery performance will return to normal when returned to room temperature.
- AA alkaline batteries may not support all the camera functions. We do not recommend their use except in emergencies and checking the camera's functionality.
- Have extra batteries ready when traveling overseas, taking pictures in cold climates, or when you will be taking a lot of pictures.

## Using the AC Adapter (Optional)

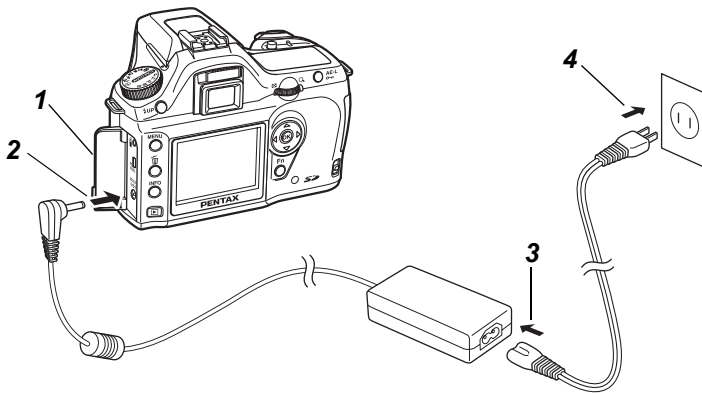

We recommend using the AC adapter D-AC10 (optional) when using the LCD monitor for a long time or when connecting to your PC.

- 1** Make sure the camera is turned off before opening the terminal cover.
- 2** Connect the DC terminal on the AC adapter to the DC input terminal on the camera.
- 3** Connect the AC plug cord to the AC adapter.
- 4** Plug the AC cord into the power outlet.



- Make sure the camera is turned off before connecting or disconnecting the AC adapter.
- Make sure connections are secure between the camera, AC adapter, AC plug cord terminal and the power outlet. SD Memory Card and data will be corrupted if disconnected while camera is recording or reading data.



- Be sure to read the AC adapter D-AC10 operating manual when using the AC adapter.
- The rechargeable batteries in your camera will not charge when connected to the AC adapter.

# Inserting/Removing the SD Memory Card

Captured images are recorded on the SD Memory Card. Make sure the camera is turned off before inserting or removing the SD Memory Card (market product).



- Do not remove the SD Memory Card while card access lamp is lit.
- Format new SD Memory Card. Also format SD Memory Card used with other cameras. Refer to "Formatting the SD Memory Card" (p.163) for details on formatting.

- 1 Press the card cover unlock lever in the indicated direction.**

Card cover opens.

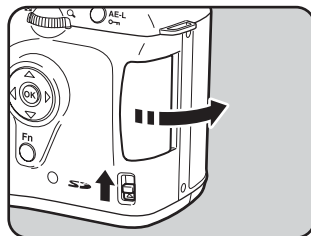

- 2 Insert the card all the way with the SD Memory Card label toward the LCD monitor.**

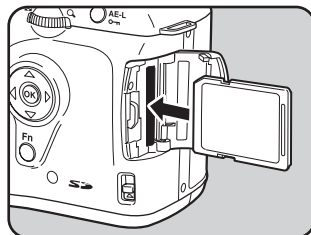

- 3 Close the card cover.**

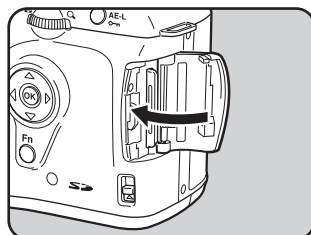

Push the SD Memory Card in once to remove.

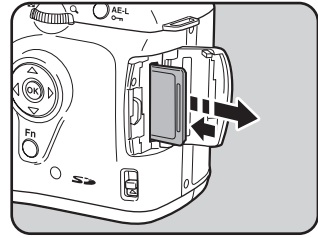

### Precautions When Using the SD Memory Card

- The SD Memory Card is equipped with a write-protect switch. Setting the switch to LOCK protects the existing data by prohibiting recording of new data, deletion of existing data or formatting of the card.
- Care should be taken when removing the SD Memory Card immediately after using the camera because the card may be hot.
- Do not remove the SD Memory Card or turn the camera off while data is being saved to the card, images are being played back, or the camera is connected to a computer with the USB cable. This may cause the data to be lost or the card to be damaged.
- Do not bend the SD Memory Card or subject it to violent impact. Keep it away from water and store away from high temperatures.
- Do not remove the SD Memory Card during formatting. The card may be damaged beyond use.
- Data on the SD Memory Card may be deleted in the following circumstances. PENTAX does not accept any liability for data that is deleted if
  - (1) the SD Memory Card is mishandled by the user.
  - (2) the SD Memory Card is exposed to static electricity or electrical interference.
  - (3) the card has not been used for a long time.
  - (4) the card is ejected or the battery is removed while the data on the card is being recorded or accessed.
- The SD Memory Card has a limited service life. If it is not used for a long time, the data on the card may become unreadable. Be sure to regularly make a backup of important data on a computer.
- Avoid using or storing the card where it may be exposed to static electricity or electrical interference.
- Avoid using or storing the card in direct sunlight or where it may be exposed to rapid changes in temperature or to condensation.
- For information on compatible SD Memory Card, visit the PENTAX website or contact your nearest PENTAX customer service center.
- Format new SD Memory Cards. Also format SD Memory Card used with other cameras.  Formatting the SD Memory Card (p.163)

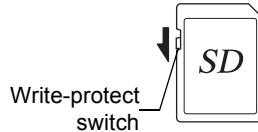



## Recorded Pixels and Quality Level

Choose the number of pixels (size) and quality level (data compression rate) of pictures according to how you intend to use the pictures you have taken.

Pictures with larger recorded size or the more ★ are clearer when printed. The number of pictures that can be taken (the number of pictures that can be recorded on an SD Memory Card) becomes less with larger file sizes. The quality of the captured photo or printed picture depends on the quality level, exposure control, resolution of the printer and a variety of other factors so you do not need to select more than the required number of pixels. For example, to print in postcard size, **1.5M** (1536×1024) is adequate. Set the appropriate recorded size and quality level depending on purpose.

Choose the appropriate number of recorded pixels and quality level for images on the [📷 Rec. Mode] menu.

- ☞ Setting the Recorded Pixels (p.109)
- ☞ Setting the Quality Level (p.110)

### ● Recorded Pixels, Quality Level and Approximate Image Storage Capacity

Quality Level Recorded Pixels		RAW	★★★ Best	★★ Better	★ Good
		<b>6M</b> (3008×2008)	11	—	—
(3008×2000)	—	34	70	117	
<b>4M</b> (2400×1600)	—	51	96	161	
<b>1.5M</b> (1536×1024)	—	106	173	271	

- The above table shows the approximate image storage capacity and recording time when using a 128 MB SD Memory Card.
- The above figures may vary depending on the subject, shooting conditions, shooting mode and SD Memory Card, etc.

## 1 Move the main switch to [ON] position.

The camera will turn on.

Move the main switch to [OFF] position to turn off the camera.

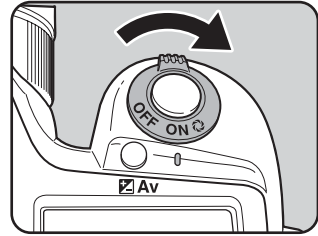

- Always turn the camera off when not in use.
- The power will automatically turn off when you do not perform any operations within a set period of time. (Default setting is 1 minute) (p.170)

The first time the camera is turned on after purchasing, the “Initial Settings” screen appears on the LCD monitor. Follow the procedure below to set the language displayed on the LCD monitor and the current date and time. Once setting is done, these will not need to be set again when turning your camera on.

## Setting the Display Language

You can choose the language in which the menus, error messages, etc. are displayed from the following: English, French, German, Spanish, Italian, Swedish, Dutch, Russian, Korean, Chinese (traditional/simplified) and Japanese.

- 1 Press the four-way controller (▶).**

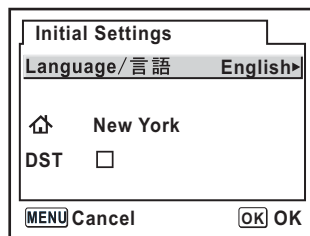

- 2 Use the four-way controller (▲▼◀▶) to select your applicable language.**

The default setting is English.

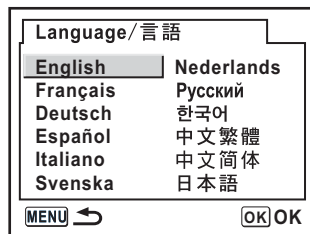

- 3 Press the OK button.**

---

**4 Press the four-way controller (▼).**

The cursor moves to [↕].

---

**5 Press the four-way controller (◀▶) to select the city.****6 Press the four-way controller (▼).**

The cursor moves to DST (daylight saving time).

---

**7 Use the four-way controller (◀▶) to select  (On) or  (Off).****8 Press the OK button.**

The screen for setting the date and time will be displayed.

**When an Incorrect Language is Set**

Follow the procedure below to display the screen for setting the language, and go to Step 2 on p.33 to set the language again.

**1 Turn the camera off and turn it on again.****2 Press the MENU button.****3 Press the four-way controller (▶) twice.****4 Press the four-way controller (▼) five times.****5 Press the four-way controller (▶) once.**

The screen for setting the language will be displayed.

## Setting the Date and Time

Set the current date and time and the display style.

- 1 **Press the four-way controller (▶).**

The frame moves to [mm/dd/yy].

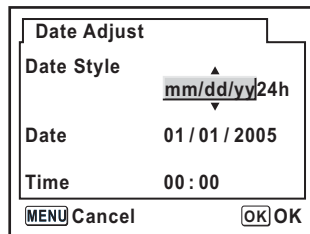

- 2 **Use the four-way controller (▲ ▼) to choose the date style.**

- 3 **Press the four-way controller (▶).**

The frame moves to [24h].

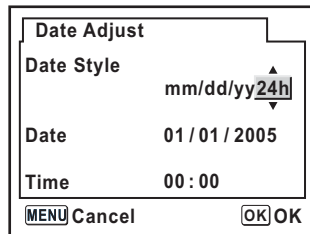

- 4 **Use the four-way controller (▲ ▼) to select 24h (24-hour display) or 12h (12-hour display).**

- 5 **Press the four-way controller (▶).**

The frame returns to [Date Style].

- 6 **Press the four-way controller (▼).**

The frame moves to [Date].

## 7 Press the four-way controller (▶).

The frame moves to the month.

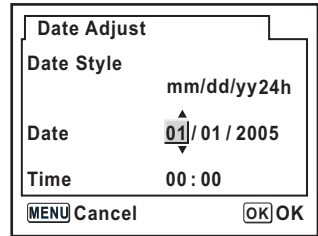

## 8 Use the four-way controller (▲ ▼) to set the month.

Set the day and year in the same manner.

Next, set the time.

If you select [12h] in Step 4, the setting switches between am and pm depending on the time.

## 9 Press the OK button.

The camera is ready to take pictures. If you set the date and time with the menu operations, the screen will return to the [X↓ Set-up] menu.

Press the **OK** button again.



You can cancel the setting operation and switch to Capture mode during initial settings by pressing the **MENU** button. In this case, the Initial Settings screen will appear again the next time you turn the camera on.



- When you finish the settings and press the **OK** button, the camera clock is reset to 00 seconds. To set the exact time, press the **OK** button when the time signal (on the TV, radio, etc.) reaches 00 seconds.
- You can change the language and date and time settings with the menu operations. (p.164, p.168)

All camera exposure modes are available when using DA, D FA, FA J or other lenses with Aperture **A** (Auto) position. Some functions are restricted when lenses are not set to Aperture **A** (Auto). Also see “Notes on [Using Aperture Ring]” (p.182). Other lenses and accessories will not be available with factory default settings. Allow shutter release when using aperture ring in custom function settings. (p.101)



Turn the camera off before attaching or removing the lens to prevent unexpected lens movement.

**1** Check that the camera is off.

**2** Remove the body mount cover (①) and lens mount cover (②).

Be sure to put the lens down with the lens mount side facing upward to protect from damage to the area around the lens mount after removal.

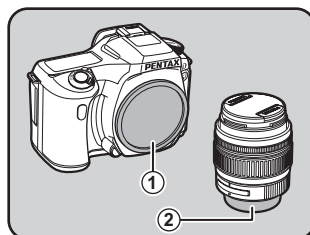

**3** Align the red dots on the camera and the lens, and secure by turning the lens clockwise until it clicks.

After attaching, check that the lens is secured. Also check that the red dots of the lens are on top and attachment portion does not move sideways.

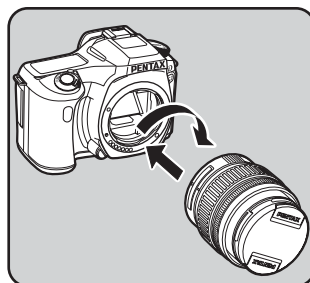

## 4 Remove the front lens cap by pushing the indicated portions inward.

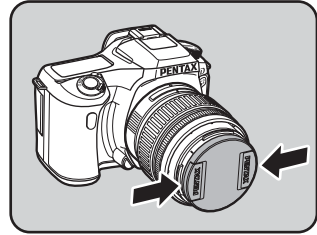

To detach the lens, hold down the lens unlock button (③) and turn the lens counterclockwise.

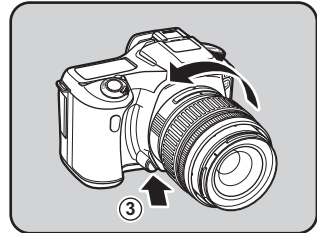

- The body mount cover (①) is a cover to prevent scratches and block dust when shipped. "Body Mount Cap K" is sold separately and has a lock function.
- We assume no responsibility nor liability for accidents, damages and malfunctions resulting from the use of lenses made by other manufacturers.
- The camera body and lens mount incorporate lens information contacts and an AF coupler. Dirt, dust, or corrosion may damage the electrical system. Clean the contacts with a soft dry cloth.



Adjust the viewfinder to suit your eyesight. If it is difficult to see the viewfinder image clearly, slide the diopter adjustment lever sideways.

You can slide the diopter from  $-2.5\text{m}^{-1}$  to  $+1.5\text{m}^{-1}$ .

## 1 Look through the viewfinder and point the camera at a well-lit scene. Slide the diopter adjustment lever left or right.

Adjust the lever until the AF frame in the viewfinder is focused.

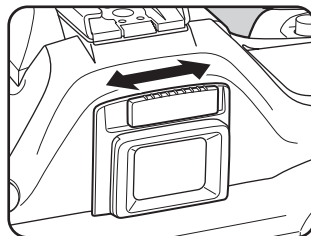

AF Frame



- Eyecup is attached to the viewfinder portion when camera leaves the factory. Diopter adjustment is available with the eyecup attached. However, adjustment is easier with the eyecup removed as shown above. To remove the eyecup, pull upward and remove as shown on the right.

- If it is difficult to see the viewfinder image clearly even if you set the diopter adjustment lever, use the diopter correction lens adapter M. However, the eyecup must be removed. (p.186)

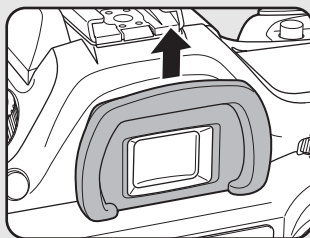



# 3 Basic Operations

---

This chapter explains basic operations for shooting by setting mode dial to Picture mode (Auto Picture or Normal mode - Flash OFF mode) to ensure successful capturing.

For information about advanced functions and settings for taking pictures, refer to chapter 4 and onward.

<b>Basic Shooting Operation .....</b>	<b>42</b>
<b>Selecting the Appropriate Capturing Mode for Scenes .....</b>	<b>47</b>
<b>Using the Zoom Lens .....</b>	<b>48</b>
<b>Using the Built-in Flash .....</b>	<b>49</b>
<b>Other Shooting Modes .....</b>	<b>53</b>
<b>Playing Back Still Pictures .....</b>	<b>63</b>
<b>Connecting the Camera to AV Equipment .....</b>	<b>70</b>
<b>Processing Images with Filters .....</b>	<b>71</b>
<b>Deleting Images .....</b>	<b>73</b>
<b>Setting the Printing Service (DPOF) .....</b>	<b>79</b>
<b>Printing Using PictBridge .....</b>	<b>83</b>

## Holding the Camera

How you hold the camera is important when taking pictures.

- Hold the camera firmly with both hands.
- Press the shutter release button gently when taking a picture.

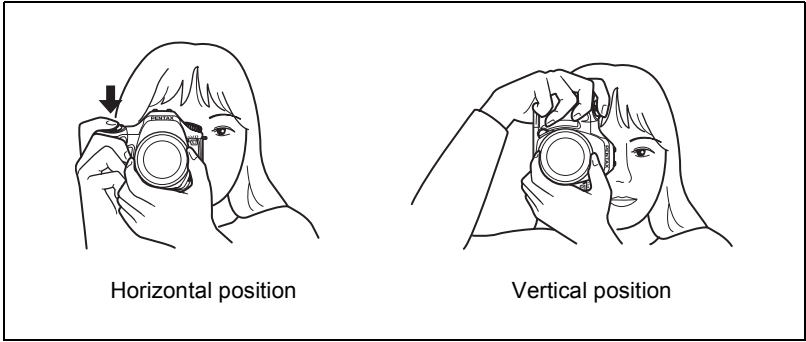

- To reduce camera shake, support your body or the camera on a solid object such as a table, tree, or wall.
- Although there are individual differences among photographers, the shutter speed for a handheld camera is generally  $1/(\text{focal length} \times 1.5)$ . For example, it is  $1/75$  of a second for a focal length of 50 mm and  $1/150$  of a second for 100 mm. A tripod should be used for shutter speeds slower than this.
- When using a telephoto lens, a tripod that is heavier than the total weight of the camera and lens is recommended to avoid camera shake.

## Letting the Camera Choose the Optimal Settings

How to set the camera so it will choose the optimum settings based on the subject lighting, distance and motion.

### 1 Set the mode dial to **AUTO PICT**.

The camera will select the optimal capturing mode for the subject.

☞ Selecting the Appropriate Capturing Mode for Scenes (p.47)

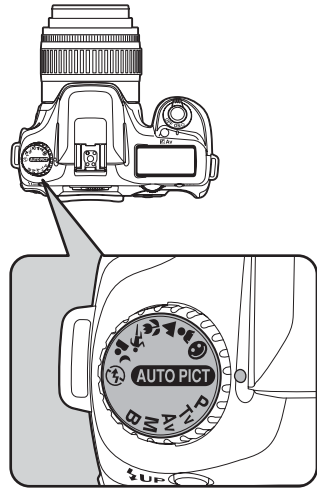

3

Basic Operations

### 2 Set the focus mode lever to **AF**.

Autofocus mode is set. (p.118)

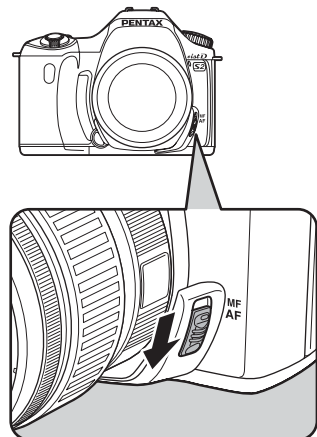

### 3 Turn the zoom ring to determine the size of the subject.

Determine the size of the subject.

☞ Using the Zoom Lens (p.48)

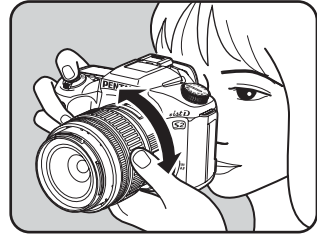

### 4 Position the subject inside the autofocus frame and press the shutter release button halfway.

The autofocus system operates. The focus indicator ● appears in the viewfinder when the subject is in focus. The flash pops up automatically when necessary (manually lift the flash when Flash mode is not set to [Auto]).

☞ Operating the shutter release button (p.45)

☞ Hard-to-Autofocus Subjects (p.46)

☞ Using the Built-in Flash (p.49)



Focus indicator

### 5 Press the shutter release button fully.

The picture is taken.



## 6 Review captured images on the LCD monitor.

Image displays for 1 second on the LCD monitor after capturing (Instant Review.)

You can delete the image during Instant Review by pressing the  button.

-  Setting the Display Time (p.171)
-  Deleting Images (p.73)
-  Displaying Bright Portion Warning (p.161)

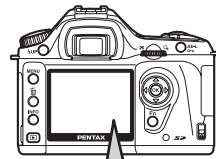

## Operating the shutter release button

The shutter release button has two positions.

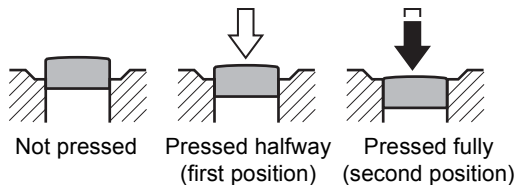

Pressing it down halfway (first position) turns on the viewfinder and LCD panel indicators and the autofocus system operates. Pressing it fully (second position) takes the picture.



- Press the shutter release button gently when taking a picture to prevent camera shake.
- Practice pressing the shutter release button halfway to learn where the first position is.
- The viewfinder indicators stay on while shutter release button is pressed. The indications stay on for about 10 seconds (default setting) after the button is released. (p.20)

## Hard-to-Autofocus Subjects

The autofocus mechanism is not perfect. Focusing may be difficult when taking pictures under the following conditions ((a) to (f) below). These also apply to manual focusing using the focus indicator  in the viewfinder. If the subject cannot be focused automatically, set the focus mode lever to **MF** and use the manual focus mode to focus on the subject with the aid of the matte field in the viewfinder. (p.127)

- (a) Extremely low-contrast subjects such as a white wall in the focus points range.
- (b) Subjects which do not reflect much light within the focus points range.
- (c) Fast moving objects.
- (d) Strongly reflected light or strong backlighting (bright background).
- (e) If vertical or horizontal line patterns appear within the focus points range.
- (f) Multiple subjects in the foreground and background within the focus points range.



Subject may not be focused even when  (focus indicator) is displayed when (f) above applies.



# Selecting the Appropriate Capturing Mode for Scenes

The camera selects and set the optimum mode when **AUTO PICT** (Auto Picture) on the mode dial is set to the dial indicator.

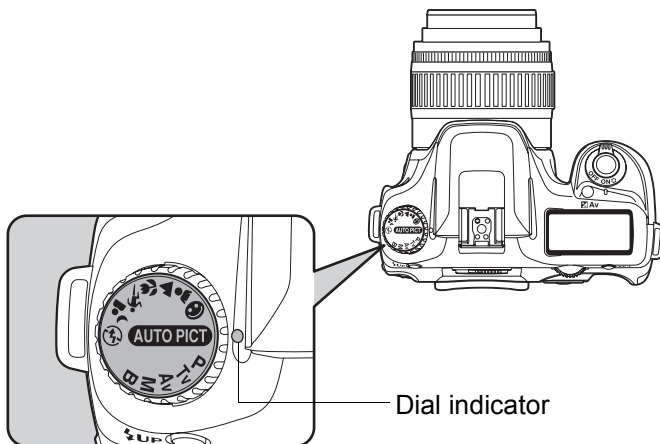

Select ☺ (Normal), 👤 (Portrait), ▲ (Landscape), 🌸 (Macro), 🏃 (Moving Object), 🌃 (Night Scene Portrait), ⚡ (Flash OFF) with the mode dial if desired image is not captured in Auto Picture mode.

The modes are as follows.

<b>AUTO PICT</b> (Auto Picture)	Selects automatically from Normal, Portrait, Landscape, Macro, and Moving Object modes.
☺ (Normal)	The basic picture-taking mode.
👤 (Portrait)	Optimal for capturing portraits.
▲ (Landscape)	Deepens the focus range, emphasizes contour and saturation of trees and the sky, and produces a bright image.
🌸 (Macro)	Lets you take vibrant pictures of flowers and other small subjects at short distances.
🏃 (Moving Object)	Lets you take sharp pictures of a quickly moving subject, such as at a sporting event.
🌃 (Night Scene Portrait)	Lets you capture people against a night view or dusk.
⚡ (Flash OFF)	The built-in flash is deactivated. Other settings are the same as ☺ (Normal).



For 🌃 (Night Scene Portrait), the shutter speed becomes slower in dark places, even if the built-in flash is used. Use a tripod to avoid camera shake.

# Using the Zoom Lens

Enlarge the subject (telephoto) or capture a wider area (wide angle) with a zoom lens. Adjust it to the desired size and take the picture.

## 1 Turn the zoom ring to the right or left.

Turn the zoom ring clockwise for telephoto and counterclockwise for wide angle.

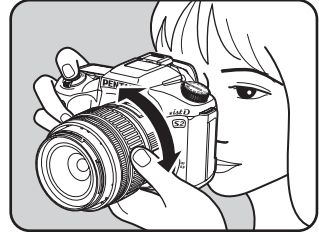

- The smaller the number of the displayed focal length, the wider the angle. The larger the number, the more magnified the image appears.
- Power Zoom functions (Image Size Tracking, Zoom Clip, and Auto Zoom Effect) are not compatible with this camera.

Wide Angle

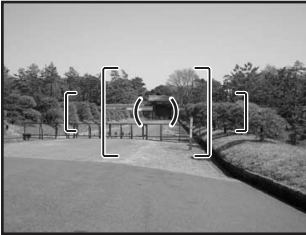

Telephoto

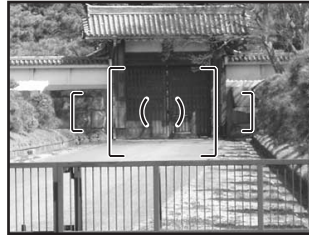

Use the following procedures to take a picture in low light or backlit conditions or when you want to manually use the built-in flash. The built-in flash is optimum at about 0.7 m to 4 m from the subject. Exposure will not be properly controlled and vignetting may occur when used at a distance closer than 0.7 m (this distance varies slightly depending on the lens being used and set sensitivity (p.150)).

## Compatibility of built-in flash and lens

Vignetting (darkening of the corners of the image due to a lack of light) may occur depending on the lens being used and the capture conditions. We recommend taking a test shot to confirm this.

☞ DA, D FA , FA J, FA and F Lens Compatibility with the Built-in Flash (p.152)



- When using the built-in flash, remove the lens hood before shooting.
- The built-in flash fully discharges for lenses without a function to set aperture lens ring to **A** (Auto).

Auto discharge	Camera automatically determines surrounding light and built-in flash pops up and discharges automatically when necessary (flash does not discharge even if it is popped up when not necessary).
Manual discharge	Discharges flash manually. Flash discharges when popped up, does not discharge when retracted.
Auto flash+Redeye reduct	Lights a red-eye reduction light before automatic flash.
Manl flash+Redeye reduct	Discharges flash manually. Lights a red-eye reduction light before manual flash.



Manual discharge mode (Flash ON) is used regardless of flash mode settings if the button is pressed to pop up the flash manually.

## Selecting Flash Mode

### 1 Press the Fn button.

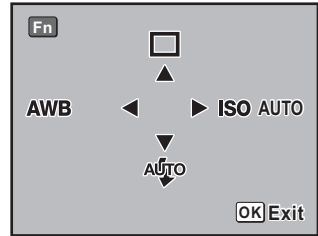

The Fn menu appears.



### 2 Press the four-way controller (▼).

The flash options screen appears.



When the mode dial is set to **P**, **Tv**, **Av**, **M** or **B**,  and  appear gray and cannot be selected.

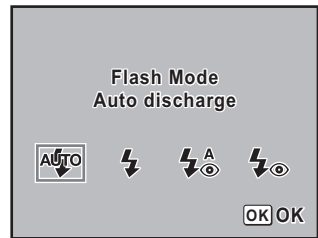

### 3 Use the four-way controller (◀▶) to choose a flash mode.

### 4 Press the OK button twice.

The camera is ready to take a picture.

## Using Auto Discharge , (Automatic Flash Popup)

### 1 Set the mode dial to , , , , or .

### 2 Press the shutter release button halfway.

The built-in flash pops up if necessary and begins charging. When the flash is fully charged,  appears in the LCD panel and viewfinder. (p.17, p.20, p.22)

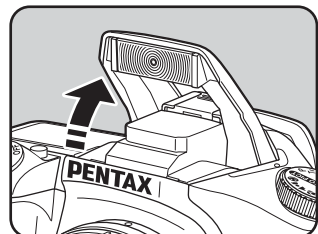



Switch between Auto discharge mode and Manual discharge mode (Flash ON) by pressing the **⚡UP** button while the built-in flash is popped up. If Auto discharge is set, **⚡AUTO** appears on the LCD panel.

### 3 Press the shutter release button fully.

The picture is taken.

### 4 Push down on the portion indicated in the illustration to retract the flash.

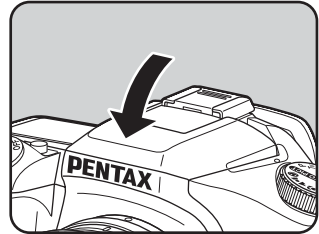





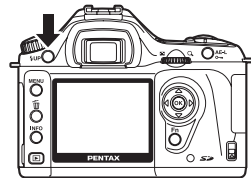

## Using Manual Discharge (Flash ON) ⚡ , ⚡👁

### 1 Press the **⚡UP** button.

The built-in flash pops up and begins charging. Manual discharge mode (Flash ON) is used regardless of flash mode settings. When the flash is fully charged, **⚡** appears in the LCD panel and viewfinder. (p.17, p.20, p.22)



Switch between Auto discharge mode and Manual discharge mode by pressing the **⚡UP** button while the built-in flash is popped up when shooting mode is set to **AUTO PICT**, , , , , , or .

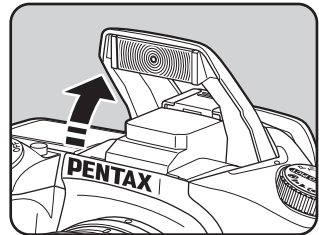

### 2 Press the shutter release button fully.

The flash discharges and the picture is taken.



### 3 Push the flash down to retract.

## Using Red-eye Reduction Flash

“Red-eye” is the phenomenon where eyes look reddish in photographs taken in dark environments with a flash. This is caused by the reflection of the electronic flash in the retina of the eye. Red-eye occurs because pupils are dilated in dark environments.

This phenomenon cannot be averted but the following measures can be used to combat it.

- Brighten the surroundings when shooting.
- Set to wide angle and shoot from closer if a zoom lens is in use.
- Use a flash that supports red-eye reduction.
- Position the flash as far away from the camera as possible when using an external flash.

The red-eye reduction function on this camera reduces red-eye by discharging the flash twice. With the red-eye reduction function, the pre-flash is discharged just before the shutter is released. This reduces pupil dilation. The main flash is then discharged while the pupils are smaller, reducing the red-eye effect. To use the red-eye reduction function, set  (Red-eye reduction auto flash) in Picture mode or  (Red-eye reduction manual flash) in other modes for Flash mode.

## Daylight-Sync Shooting

In daylight conditions, the flash will eliminate shadows when a portrait picture is taken with a person’s face cast in shadow. Use of the flash in this way is called Daylight-Sync Shooting. Flash is discharged manually when shooting with Daylight-Sync Shooting.

### ● Taking pictures (Auto Picture)

- 1 Confirm that the flash has popped up and the flash mode is set to  (Manual discharge). (p.51)
- 2 Confirm that the flash is fully charged.
- 3 Take the picture.



The picture may be over-exposed if the background is too bright.



Without Daylight-Sync



With Daylight-Sync

## Continuous Shooting

Pictures can be taken continuously while the shutter release button is held down.

### 1 Press the Fn button.

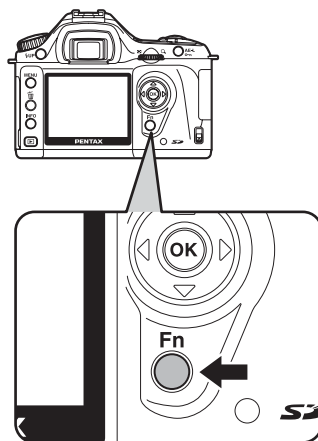

The Fn menu appears.

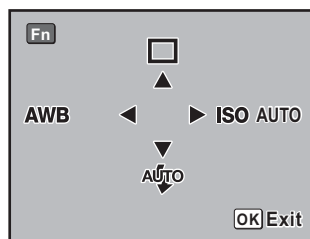

- 2** Press the four-way controller (▲).

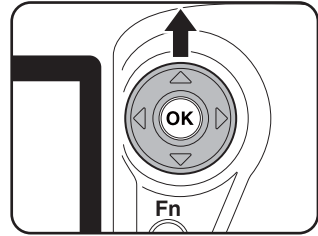

The Drive Mode options screen appears.

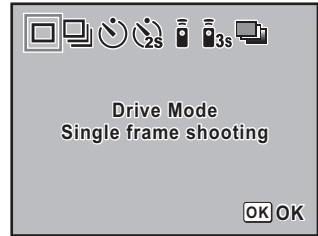

- 3** Use the four-way controller (◀▶) to select .

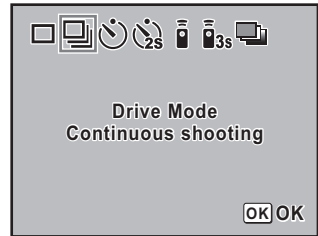

- 4** Press the OK button twice.

The camera is ready to take pictures.

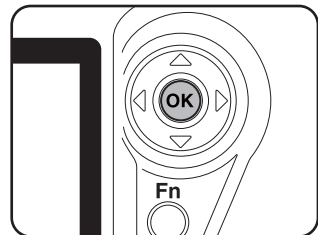

- 5** Press the shutter release button halfway.

The autofocus system operates. The focus indicator ● appears in the viewfinder when the subject is in focus.





Set [2 No. cnt shtng rcd im ] in [Recordable Image No.] of the [C Custom Setting] menu. The number of continuously recordable images (buffer space) appears when shutter is pressed halfway. (p.100)

## 6 Press the shutter release button fully.

Pictures are taken continuously while the shutter release button is fully pressed. Take your finger off the shutter release button to stop.

Continuous shooting settings are retained when the power is turned off. Display the Fn menu again and set to □ (Single frame shooting) to stop Continuous shooting.



- The focus is adjusted each time the shutter is released if the focus mode is set to **AFS** (Single mode). (p.121)
- Focusing is continuously active when the mode dial is set to **P**, **Tv**, **Av** or **M** and focus mode is set to **AFC** (Continuous mode), or when Picture mode is set to (Moving Object). Note that the shutter will release even if the focusing is not complete.
- The shutter cannot be released until charging is complete when using the built-in flash. Use a custom function to enable shutter release before the built-in flash is ready. (p.148)

## Self-Timer Shooting

This camera has two types of self-timers: and .

	Shutter will be released after about 12 seconds. Use this mode to include the photographer in the picture.
	A mirror pops up immediately after shutter release button is pressed. Shutter is released after about 2 seconds. Use this mode to avoid camera shake when the shutter release button is pressed.

## 1 Mount the camera to a tripod.

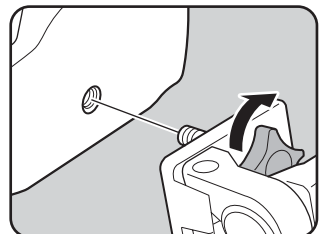

## 2 Press the Fn button.

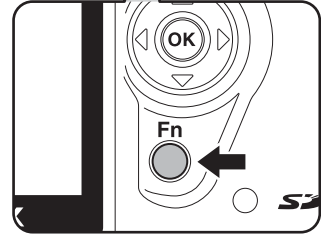
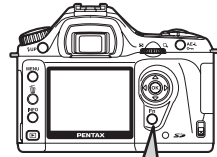

The Fn menu appears.

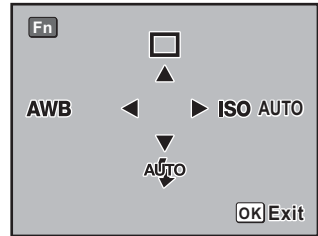

## 3 Press the four-way controller (▲).

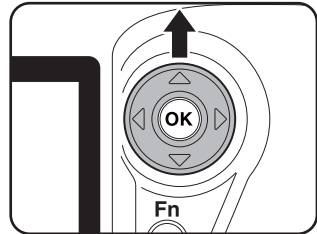

The Drive Mode options screen appears.

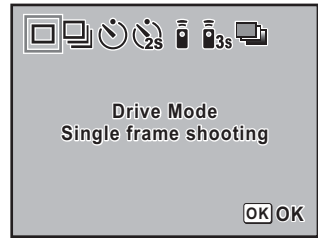

- 4** Use the four-way controller (◀▶) to select ⌚ or ⚡.



- 5** Press the **OK** button twice.

The camera is ready to take pictures.

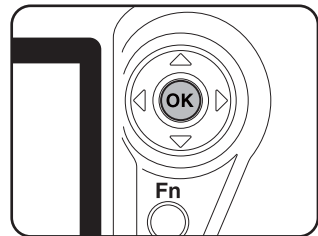

- 6** Confirm in the viewfinder that the subject you wish to shoot is in the display and press the shutter release button halfway.

The focus indicator  appears when the subject is in focus.



## 7

## Press the shutter release button fully.

For , the self-timer lamp starts blinking slowly and blinks rapidly 2 seconds before the shutter is released. The beep is heard and the rate increases. The shutter will be released about 12 seconds after the shutter release button is pressed fully.

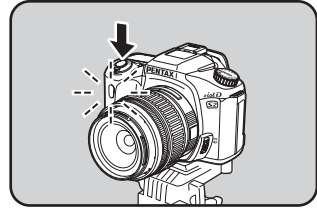

For , the shutter will be released about 2 seconds after the shutter release button is pressed fully.



- The beep can be turned off. (p.164)
- Exposure may be affected if light enters the viewfinder. Attach the provided ME viewfinder cap or use the AE lock function (p.143). (Ignore the light entering the viewfinder when the exposure mode is set to **M** (Manual) (p.139).)
- Remove the Eyecup F<sub>L</sub> by pulling one side upward when using accessories such as the ME viewfinder cap.

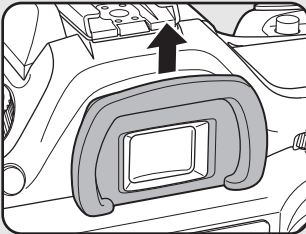

Removing the Eyecup F<sub>L</sub>

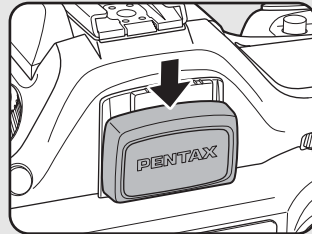

Attaching the ME Viewfinder cap



## 8

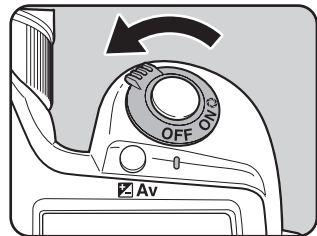

## Turn the camera off after shooting.

The next time the power is turned on, self-timer shooting is canceled and returns to single frame shooting.



## Remote Control Shooting (Remote Control F: Sold Separately)

The shutter can be released with the optional remote control unit. You can select from  (remote control) and  (three-second delay) for remote control shooting.

	The shutter will be released immediately after the shutter release button on the remote control unit is pressed.
	The shutter will be released 3 seconds after the shutter release button on the remote control unit is pressed.

### 1 Mount the camera to a tripod.

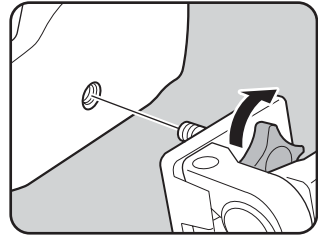

### 2 Press the Fn button.

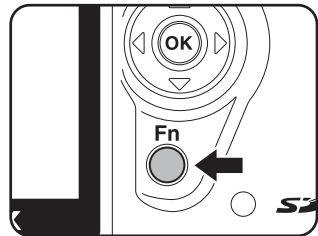

The Fn menu appears.

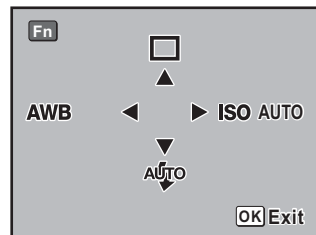

### 3 Press the four-way controller (▲).

The Drive Mode options screen appears.

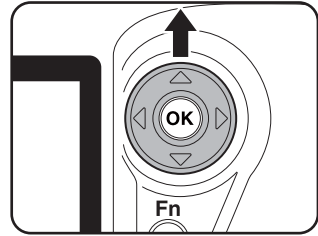

### 4 Use the four-way controller (◀▶) to select $\bar{i}$ or $\bar{i}_{ss}$ .

The self-timer lamp will blink to let you know that the camera is in remote control wait status.



### 5 Press the OK button twice.

The camera is ready to take pictures.

### 6 Press the shutter release button halfway.

The autofocus system operates. The focus indicator ● appears in the viewfinder when the subject is in focus.



- You cannot focus with the remote control unit in default settings. Focus on the subject first before operating with the remote control. You can set [AF in remote control] to [On] in the custom function. (p.100)
- When using the Remote Control Unit, flash does not pop up automatically even when set to  $\text{Auto}$  (Auto discharge). Pop up the flash manually beforehand. (p.51)

7

**Point the remote control unit towards the front of the camera and press the shutter release button on the remote control.**

The operating distance of the remote control unit is about 5 m from the front of the camera. The shutter will be released immediately or approximately 3 seconds after the shutter release button on the remote control unit is pressed depending on the drive mode selected.

When the picture is taken, the self-timer lamp lights for 2 seconds and will then resume blinking.

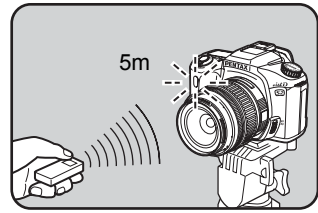

- Exposure may be affected if light enters the viewfinder. Attach the provided ME viewfinder cap or use the AE lock function (p.143) (ignore the light entering the viewfinder when the exposure mode is set to **M** (manual) (p.139)).
- Remove the Eyecup F<sub>N</sub> by pulling one side out and toward you when using accessories such as the ME viewfinder cap.

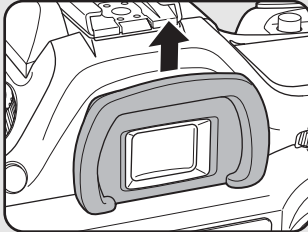

Removing the Eyecup F<sub>L</sub>

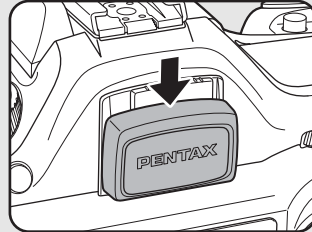

Attaching the ME Viewfinder cap

- Turn the power off to stop the remote control operation after it has been activated.
- The remote control may not operate in backlit conditions.
- The remote control does not work while the flash is being charged.
- When using the built-in flash, raise the flash into position first.
- The camera automatically returns to single frame shooting after the remote control shooting mode is left unused for 5 minutes.
- The remote control unit battery can send a remote control signal about 30,000 times. Contact PENTAX service center to replace the battery (this will involve a fee).

3

## Using Mirror Lock Up Function to Prevent Camera Shake

Use the Mirror Lock Up function if camera shake is evident even when Cable Switch (optional) or Remote Control Unit (optional) is used. When shutter release button is pressed, mirror pops up and shutter is released 2 seconds later if 2 sec. Self-Timer is used. Avoid camera shake when mirror pops up by using this method. Follow the procedure below to take a picture with the mirror lock up.

3

Basic Operations

- 1** Mount the camera to a tripod.
- 2** Use the Fn button and the four-way controller (▲) to select  (2 sec. Self-Timer). (p.55)
- 3** Focus on the subject.
- 4** Press the shutter release button fully.

The mirror pops up and the picture is taken 2 seconds later. AE lock is enabled with the exposure value set immediately before the mirror goes up.



## Playing Back Images

You can play back captured still pictures with the camera.



Use the included "PENTAX PHOTO Browser 2.1" software to play back using a PC. Refer to the "PENTAX PHOTO Browser 2.1/PENTAX PHOTO Laboratory 2.1 Operating Manual" for details.

### 1 Press the button after taking a picture.

The most recently captured image (image with the largest file number) is displayed on the LCD monitor.

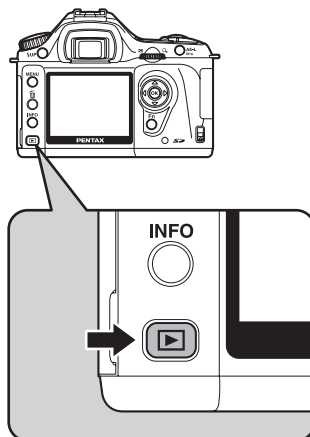

## 2 Press the four-way controller (◀▶).

- ◀ : The previous image appears.
- ▶ : The next image appears.

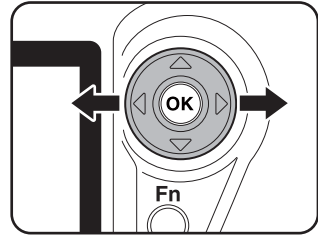

## Rotating Images

You can rotate images 90° counterclockwise at a time. Make images shot vertically easier to view.



## 1 Press the [▶] button after taking a picture.

The most recently captured image (image with the largest file number) is displayed on the LCD monitor.

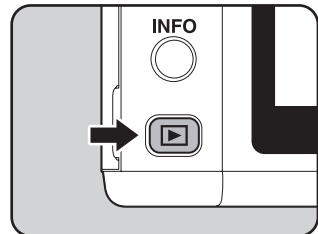

## 2 Press the four-way controller (▼).

The image is rotated 90° counterclockwise each time the button is pressed.

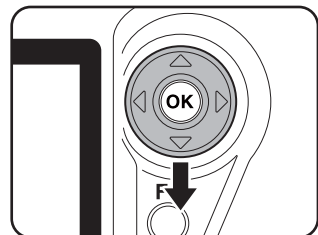

3

**Press the OK button.**

Image rotation information is saved.

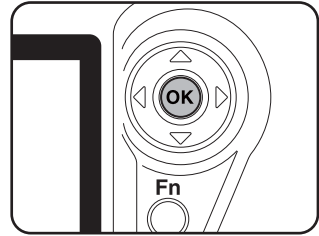
**Enlarging Playback Images**

You can magnify images up to 12 times when displaying.

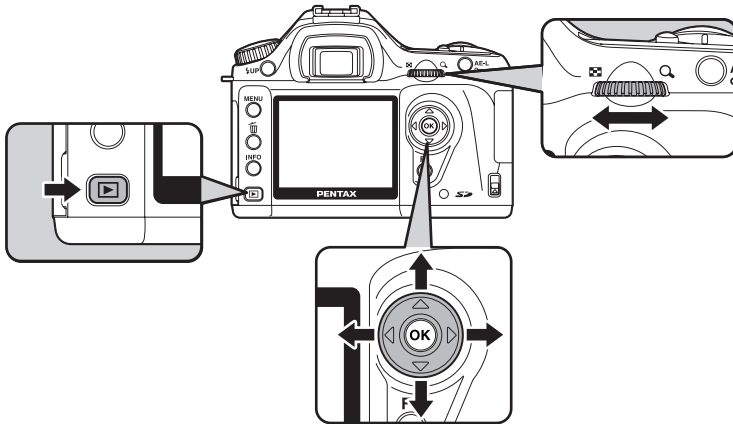

1

**Press the  button and use the four-way controller (◀▶) to select an image.**

The most recently captured image (image with the largest file number) is displayed first on the LCD monitor.







3

## 2 Turn the e-dial to the right (toward Q).

Image enlarges at each calibration and can be enlarged to 12 times the original. Turn to the left (toward ) to return.

Press the **OK** button to return to the original size.

Press four-way controller (   ) in zoom display to change the display area.



3



The first calibration on the e-dial is 1.2 times. You can change this in [Mag to Strt Zm Plybk] in [C Custom Setting] menu. (p.101)

## Nine-Image Display

You can display nine images on the LCD monitor at the same time.

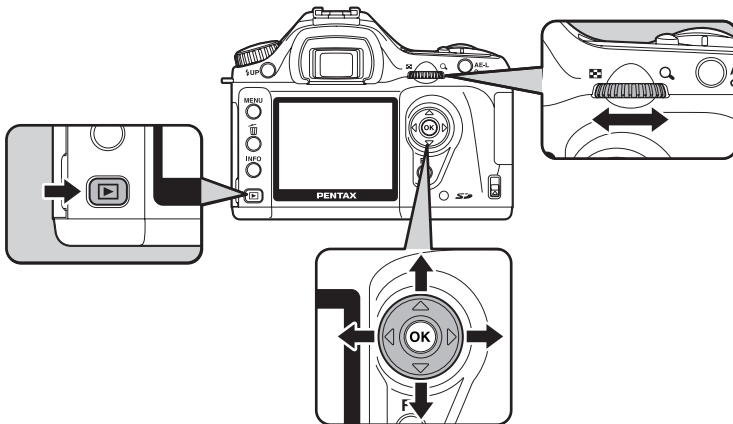





## 1 Press the button.

The most recently captured image (image with the largest file number) is displayed on the LCD monitor.



## 2 Turn the e-dial to the left (toward ).

Up to nine thumbnail images will be displayed at once. Use the four-way controller () to select an image. A scroll bar appears at the right of the screen. With an image selected in the bottom row, pressing the four-way controller () displays the next nine images.

[?] appears for an image that cannot be displayed.

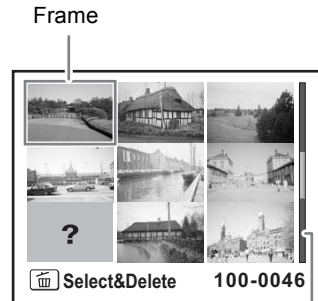

Scroll bar

## 3 Turn the e-dial to the right (towards ) or press the OK button.

A full screen display of the selected image appears.



## Slideshow

You can play back all images recorded on your SD Memory Card successively. To start continuous playback, use the menu screen displayed on the LCD monitor.

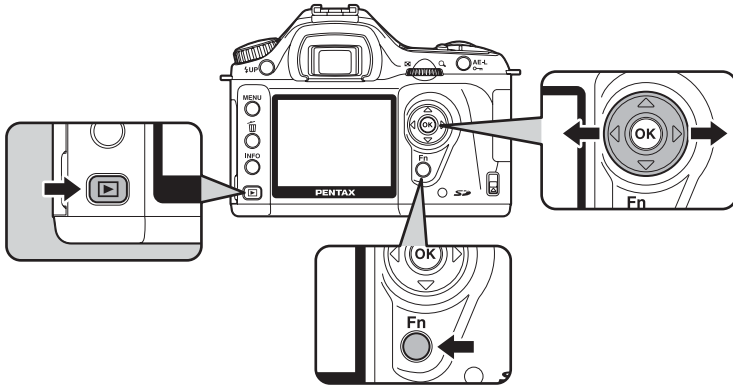

- 1 Press the  button and use the four-way controller ( ) to select an image to be displayed first.

The most recently captured image (image with the largest file number) is displayed first on the LCD monitor.



- 2 Press the Fn button.

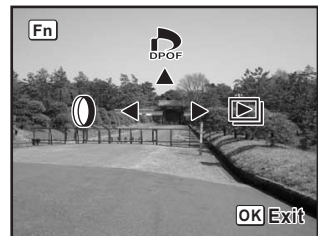

The Fn menu appears.





### 3 Press the four-way controller (▶).

Start screen is displayed and slideshow begins.

Press any button to end slideshow.

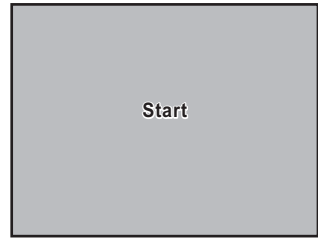
Press the shutter release button or the  button, slide the main switch to  (preview) or turn the mode dial to change to Capture mode.



Set the display time for slideshow in the [ Playback] menu. Alternatively, start the slideshow from the [ Playback] menu. (p.162)

# Connecting the Camera to AV Equipment

By using the video cable, you can play back images using a TV or other device with a video IN jack as your monitor. Make sure that both the TV and the camera are turned off before connecting the cable.

☞ Selecting the Video Output Format (p.169)

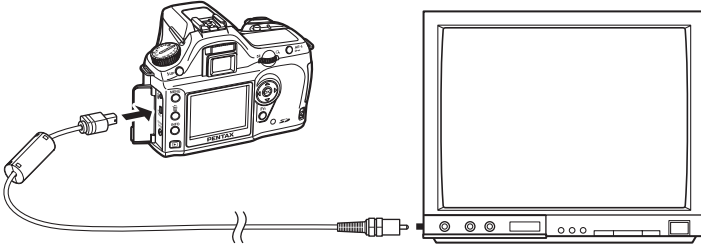

**1** Open the terminal cover and connect the video cable to the USB/Video terminal.

**2** Connect the other end of the video cable to the video IN jack on the AV device.

**3** Turn the AV device and camera on.



- If you intend to use the camera continuously for a long period, use of the AC adapter (optional) is recommended. (p.28)
- For AV equipment with multiple video IN jacks (such as TVs), check the operating manual of the AV device, and select the video IN jack to which the camera is connected.
- Depending on the country or region, images may fail to be played back if the video output format is set different from the one in use there. If this happens, change the video output format setting. (p.169)
- The camera LCD monitor turns off while the camera is connected to the AV device.



You can edit shot images using digital filters. Processed images are saved under a different name.



- RAW images cannot be processed using the digital filter.
- Additionally, set digital filters from the [▶ Playback] menu.

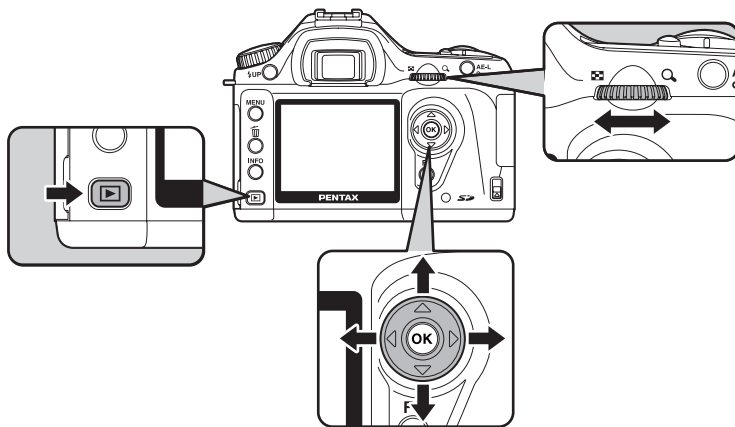

## Digital Filter

B&W	Convert to a black and white image.
Sepia	Add a vintage touch to photos by converting them to sepia color.
Soft	Create a soft image by lightly fading the entire image. Select from three levels.
Slim	Change the horizontal and vertical ratio of images. Adjust height or width up to two times the original size.

### 1 Press the Fn button in Playback mode.

The Fn menu appears.

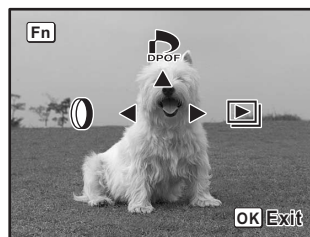

## 2 Press the four-way controller (◀).

The screen for selecting the filter appears.



## 3 Use the four-way controller (◀▶) to select an image.

## 4 Use the four-way controller (▲▼) to select a filter.

Select a filter and preview the effects on the image. Proceed to Step 6 if [B&W] or [Sepia] is selected.

## 5 Adjust slimness with e-dial if slim filter is selected and softness if soft filter is selected.

Turn counterclockwise for wider and clockwise for slimmer if slim filter is selected. Select softness from three levels if soft filter is selected. Use the four-way controller (◀▶) to select an image. The image appears in the set slimness or softness.

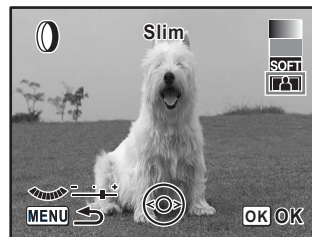

## 6 Press the OK button.

The save confirmation screen appears.

## 7 Use the four-way controller (▲) to select [Save as].

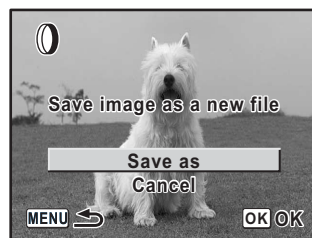

## 8 Press the OK button.

The filtered image is saved under a different name.

## Deleting a Single Image

You can delete one image at a time.



- Deleted images cannot be restored.
- Protected images cannot be deleted.

- 1** Press the button and use the four-way controller (◀▶) to select an image to delete.



- 2** Press the button.  
The Delete screen appears.

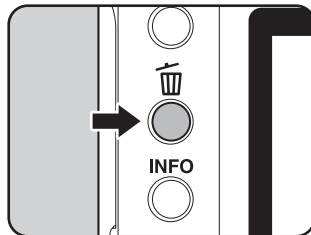

- 3** Use the four-way controller (▲) to select [Delete].

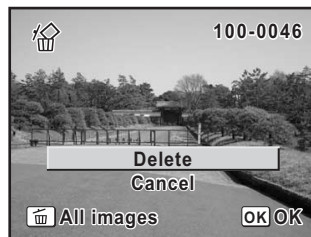

- 4** Press the **OK** button.

The image is deleted.

## Deleting All Images

You can delete all saved images at once.



- Deleted images cannot be restored.
- Protected images cannot be deleted.

**1** Press the button.

**2** Press the button twice.

The Delete All screen appears.

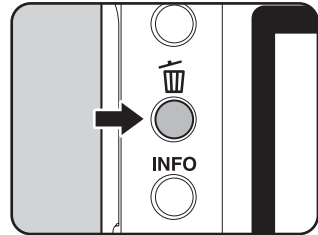

**3** Use the four-way controller () to select [Delete All].

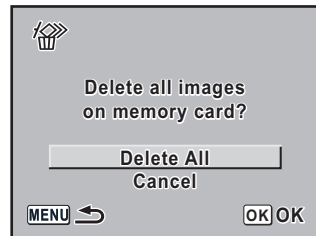

**4** Press the **OK** button.

All images are deleted.

## Deleting Selected Images (from Nine-Image Display)

You can delete multiple images from the nine-image display at once.



- Deleted images cannot be restored.
- Protected images cannot be deleted.
- Only files in the same folder can be selected at once.

### 1 Press the button.

The most recently captured image (image with the largest file number) is displayed first on the LCD monitor.



### 2 Turn the e-dial to the left (toward ).

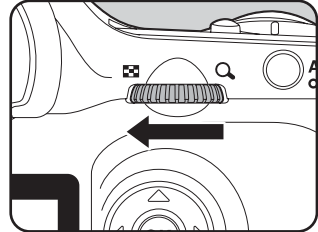

Nine thumbnail images appear.



### 3 Press the button.

appears above the images.

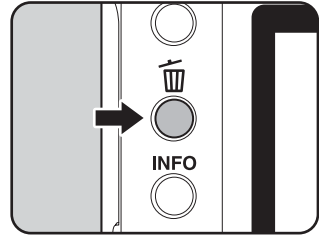

### 4 Use the four-way controller (, , , ) to move to the images to delete and press the OK button.

Image is selected and  appears.

Press **Fn** button to select all images (the selection of images may take time to complete depending on the number of images).

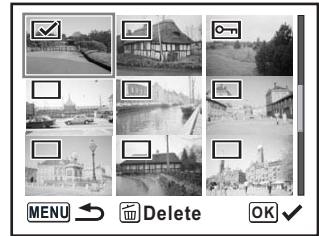

### 5 Press the button.

The Delete confirmation screen appears.

### 6 Use the four-way controller () to select [Select&Delete].

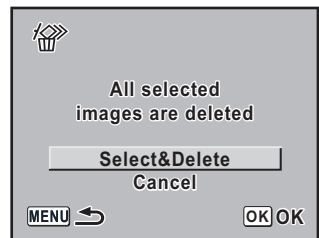

### 7 Press the OK button.

The selected images are deleted.

## Protecting Images from Deletion (Protect)

You can protect images from being accidentally deleted.



Even protected images are deleted if the SD Memory Card is formatted.

- 1 Press the button and use the four-way controller ( ) to select an image.

The most recently captured images (image with the largest file number) are displayed first on the LCD monitor.



- 2 Press the button.

The Protect screen appears.

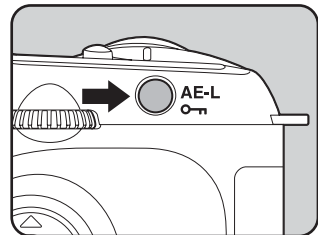

- 3 Use the four-way controller ( ) to select [Protect].

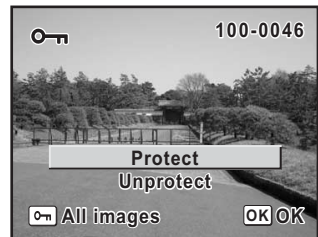



- 4 Press the **OK** button.

The selected image is protected.



- Select [Unprotect] in Step 3 to cancel the Protect setting.
- The symbol is displayed when playing back protected images. (p.19)

## Protecting All Images

- 1 Press the  button.
- 2 Press the  button twice.

The Protect all images screen appears.

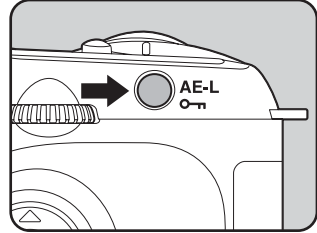

3

Basic Operations

- 3 Press the four-way controller () to select [Protect] and press the OK button.

All images saved in the SD Memory Card are protected.



Select [Unprotect] in Step 3 to cancel the Protect setting on all of the images.



You can order conventional photograph prints by taking the SD Memory Card with recorded images to a store for a printing service.

DPOF (Digital Print Order Format) settings allow you to specify the number of copies or to imprint the date.



DPOF settings cannot be applied to RAW images.

## Printing Single Images

Set the following items for each image.

Copies	Selects the number of copies. You can print up to 99 copies.
Date	Specifies whether you want the date inserted on the print or not.

**1** Press the button and use the four-way controller (◀▶) to select an image.

**2** Press the Fn button.

The Fn menu appears.

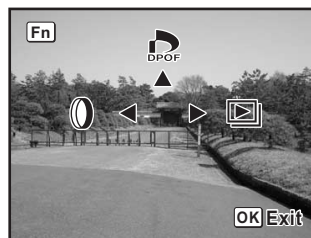

**3** Press the four-way controller (▲).

The DPOF screen appears.

If DPOF settings have already been made for an image, the previous number of prints and date setting ( (on) or  (off)) will be displayed.

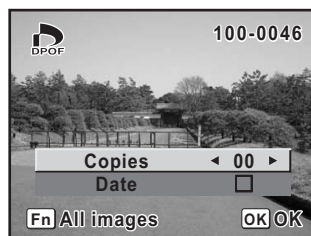

#### 4 Use the four-way controller (◀▶) to choose the number of copies and press the four-way controller (▼).

The frame moves to [Date].

#### 5 Use the four-way controller (◀▶) to choose whether to insert the date (☑) or not (☐).

☑ : The date will be imprinted.

☐ : The date will not be imprinted.

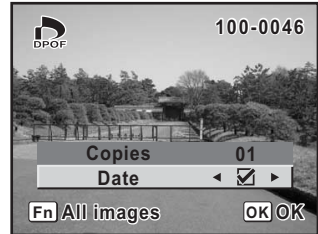

#### 6 Press the OK button.

The DPOF settings are saved and the camera returns to playback status.



Depending on the printer or printing equipment at the photo processing lab, the date may not be imprinted on the pictures even if the DPOF setting was made.



To cancel DPOF settings, set the number of copies to [00] in Step 4 and press the **OK** button.

## Settings for All Images

- 1** Press the Fn button in Playback mode.

The Fn menu appears.

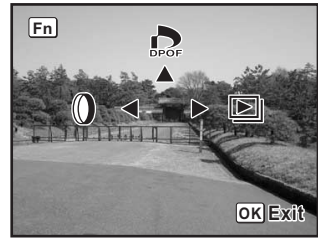

- 2** Press the four-way controller (▲).

The DPOF screen appears.



- 3** Press the Fn button.

The screen for making DPOF settings for all images appears.

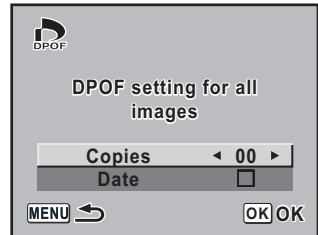

- 4** Use the four-way controller (◀▶) to choose the number of copies and whether to insert the date (☑) or not (☐).

Refer to Steps 4 and 5 in “Printing Single Images” (p.80) for details of how to make the settings.

## 5 Press the OK button.

The DPOF settings for all the images are saved and the camera returns to playback status.



The number of copies specified in settings for all images applies to all the images. Before printing, check that the number is correct.



Settings for single images are canceled when settings are made for all images.

This function lets you print images directly from the camera without using a PC (direct printing).

Connect the camera and PictBridge compatible printer with the included USB cable (I-USB17) to print directly.

Select the images you want to print, the number of copies and whether to insert the date or not on the camera after connecting to the printer.

Direct printing is performed in the following steps.

Set [Transfer Mode] on camera to [PictBridge] (p.84)



Connect the camera to the printer (p.85)



Set the printing options (p.79)

Print single images (p.86)

Print all images (p.88)

Print with DPOF settings (p.90)



Disconnect the camera from the printer (p.90)

3

Basic Operations



- Use of the AC adapter is recommended when connecting the camera to a printer. The printer may not work properly or the image data may be lost if the batteries run out of power while the camera is connected to the printer.
- Do not disconnect the USB cable during data transfer.
- Depending on the type of printer, not all the settings made on the camera (such as print settings and DPOF settings) may be valid.
- A printing error may occur if the selected number of copies exceeds 500.
- You cannot use the camera to select multiple images for printing on a single sheet. Make the settings on the printer. For details, refer to the operating manual for your printer.
- RAW images cannot be printed directly. Use a PC to print RAW images.
- See the “PENTAX PHOTO Browser 2.1/PENTAX PHOTO Laboratory 2.1 Operating Manual” when connecting to a PC.

## Setting [Transfer Mode]

### 1 Press the MENU button.

The [📷 Rec. Mode] menu appears.

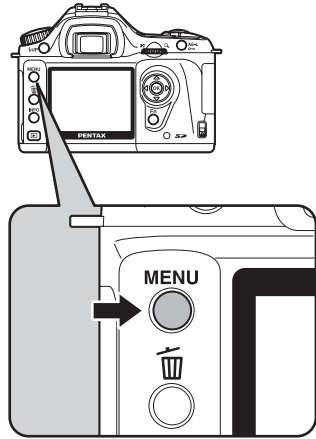

3

Basic Operations

### 2 Use the four-way controller (◀▶) to select the [📷 Set-up] menu.

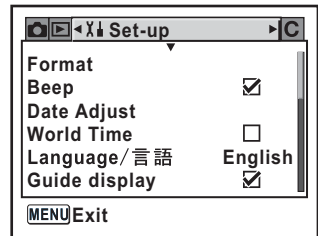

### 3 Use the four-way controller (▲▼) to select [Transfer Mode].

### 4 Press the four-way controller (▶).

A pop-up menu appears.

- 5** Use the four-way controller (▲▼) to select [PictBridge].

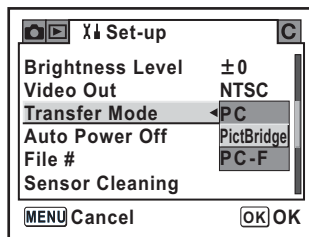

- 6** Press the **OK** button.

The setting is changed.

- 7** Press the **MENU** button.

## Connecting the Camera to the Printer

- 1** Turn the camera off.

- 2** Connect the camera and PictBridge compatible printer using the USB cable supplied with the camera.

The PictBridge logo is displayed on PictBridge compatible printers.

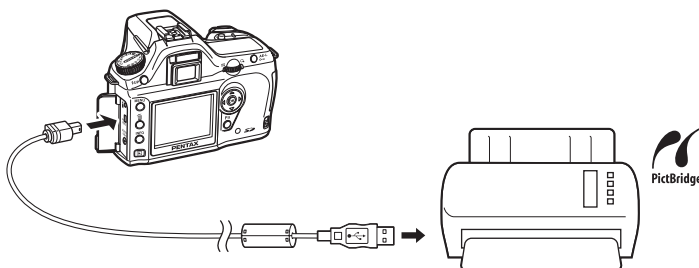

**3** Turn the printer on.

**4** After printer start-up is complete, turn the camera on.

The PictBridge menu appears.

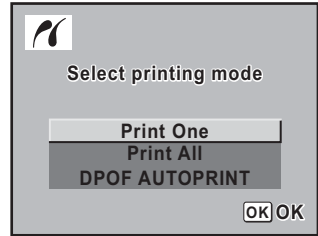

PictBridge menu is not displayed if [Transfer Mode] is set to [PC] or [PC-F].

3

Basic Operations

## Printing Single Images

**1** Use the four-way controller (▲▼) to select [Print One] on the PictBridge menu.

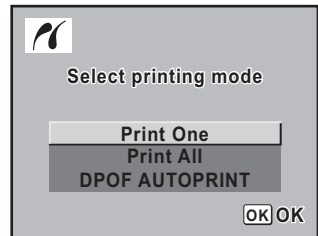

**2** Press the OK button.

The Print one screen appears.

**3** Use the four-way controller (◀▶) to choose an image to print.





#### 4 Use the four-way controller (▲▼) to choose the number of copies.

You can print up to 99 copies.

#### 5 Use the Fn button to choose whether to insert the date (☑) or not (☐).

☑ : The date will be printed.

☐ : The date will not be printed.

#### 6 Press the OK button.

The print settings confirmation screen appears.

Proceed to Step 12 to print the images by default.

To change the print settings, go to Step 7.

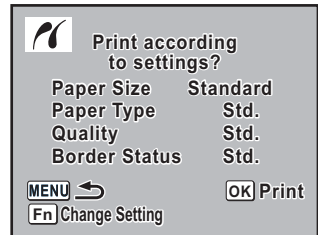

#### 7 Press the Fn button.

The screen for changing print settings appears.

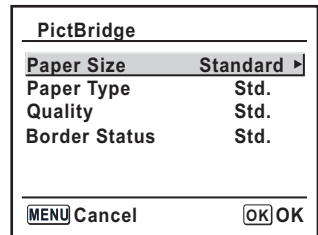

#### 8 Select [Paper Size] and press the four-way controller (▶).

The Paper Size screen appears.

#### 9 Use the four-way controller (▲▼◀▶) to choose the paper size.

You can only choose a size that is supported by your printer.

When the Paper Size is set to [Standard], images are printed according to the printer settings.

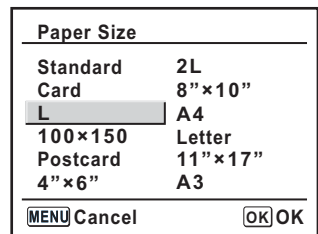

**10** Press the **OK** button.

**11** Repeat Steps 8 to 10 to set **[Paper Type]**, **[Quality]** and **[Border Status]**.

The print settings change screen appears after each item has been set. When the Paper Size is set to **[Standard]**, images are printed according to the printer settings.

**[Paper Type]** with more ★ supports higher quality paper.

**[Quality]** with more ★ indicates higher print quality.

**12** Press the **OK** button twice.

The image is printed according to the settings.

Press the **MENU** button to cancel printing.

## Printing All Images

**1** Use the four-way controller (▲▼) to select **[Print All]** on the **PictBridge** menu.

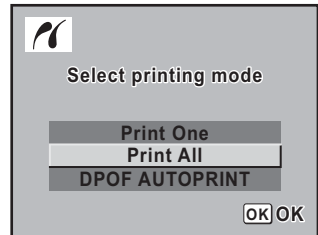

**2** Press the **OK** button.

The Print all images screen appears.

### 3 Choose the number of copies and whether to imprint the date or not.

The number of copies and the date setting that you choose apply to all of the images.

Refer to Steps 4 and 5 of “Printing Single Images” (p.87) for details on how to make the settings.

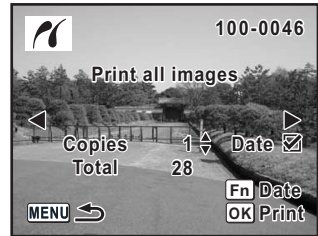

### 4 Press the OK button.

The print settings confirmation screen appears.

Refer to Steps 7 and 11 of “Printing Single Images” (p.87 and 88) for details on how to change the settings.

### 5 Press the OK button on the print settings confirmation screen.

All the images are printed according to the settings.

Press the **MENU** button to cancel printing.

## Printing Images Using the DPOF Settings

**1** Use the four-way controller (▲▼) to select [DPOF AUTOPRINT] on the PictBridge menu.

**2** Press the **OK** button.

The Print w/DPOF settings screen appears. Use the four-way controller (◀▶) to check the number of copies for each image, whether the date is imprinted or not, and total number of copies. Print settings are set with the Print Service. (p.79)

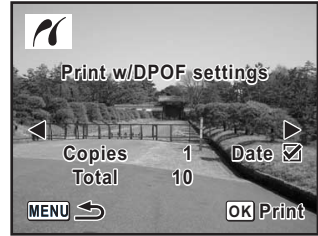

**3** Press the **OK** button.

The print settings confirmation screen appears.

Refer to Steps 7 and 11 of “Printing Single Images” (p.87 and 88) for details on how to change the settings.

**4** Press the **OK** button on the print settings confirmation screen.

The images are printed according to the settings.

Press the **MENU** button to cancel printing.

## Disconnecting the Cable from the Printer

Disconnect the cable from the printer when you have finished printing.

**1** Turn off the camera.

**2** Disconnect the USB cable from the camera and printer.

# 4 Menu Reference

---

Explains the functions of *\*istDS2* by buttons and menus.

<b>Using the Button Functions .....</b>	<b>92</b>
<b>Using the Menu .....</b>	<b>96</b>
<b>Using the Fn Menu .....</b>	<b>102</b>
<b>Using the Mode Dial .....</b>	<b>104</b>

When using menus and Fn menu, items which cannot be changed due to camera settings appear gray and cannot be selected.
--

## Capture Mode

Functions of buttons used during shooting are noted.

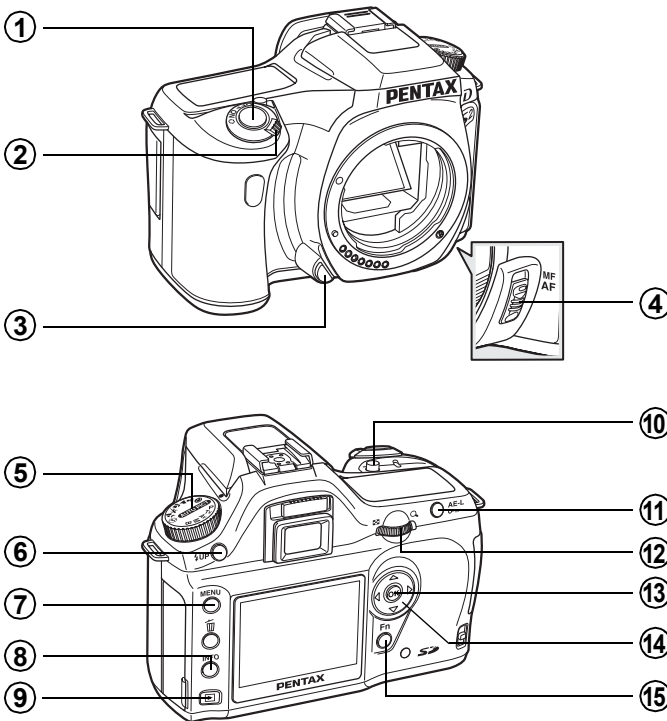

### ① Shutter release button

Press to capture images. (p.45)

### ② Main switch

Move to turn the power on/off (p.32) and confirm the depth of field (Preview) (p.130).

### ③ Lens unlock button

Press to detach lens. (p.38)

**④ Focus mode lever**

Switches between Autofocus mode (p.118) and Manual focus mode (p.126).





**⑤ Mode dial**

Changes the Shooting mode. (p.104)

**⑥  UP button**

Press to pop up the built-in flash. (p.49)

**⑦ MENU button**

Displays the [ Rec. Mode] menu (p.98). Next, press the four-way controller () to display [ Playback] menu (p.98), [ Set-up] menu (p.99) and [ Custom Setting] menu. (p.100)

**⑧ INFO button**

Press to show shooting information on the LCD monitor. (p.17)

**⑨  button**

Switches to the Playback mode. (p.63)

**⑩  Av button**

Press to set aperture and EV compensation values. (p.137, p.142)

**⑪ AE-L button**

Locks the exposure before shooting. (p.143)

Automatically adjusts the appropriate exposure in **M** (Manual) mode. (p.141)

**⑫ e-dial**

Sets shutter speed, aperture, and EV compensation values. (p.135, p.137, p.142)





**⑬ OK button**

Saves the setting you selected in the menu.

**⑭ Four-way controller (   )**

Uses it to move cursor or change items in menus and Fn menu.

**⑮ Fn button**

Press to display the Fn menu. Press the four-way controller (   ) to determine the following operation. (p.102)

## Playback Mode

Functions of buttons used during playback are noted.

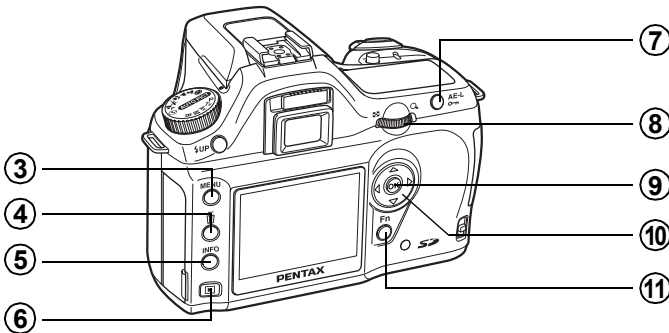
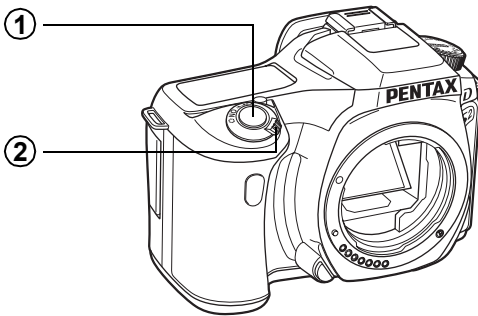

### ① Shutter release button

Press to switch to capture mode.

### ② Main switch

Move to turn the camera on and off. (p.32)

### ③ MENU button

Press to display the [▶ Playback] menu (p.98). Next, press the four-way controller (◀▶) to display [X Set-up] menu (p.99), [C Custom Setting] menu (p.100) and [Rec. Mode] menu (p.98).

### ④ button

Press to delete images. (p.73)



**⑤ INFO button**

Press to show shooting information on the LCD monitor. (p.18)

**⑥  button**

Press to switch to capture mode.

**⑦  button**

Press to protect images from being accidentally erased. (p.77)

**⑧ e-dial**

Uses it to enlarge an image (p.65) or display nine images at the same time (p.66).

**⑨ OK button**

Saves the setting you selected in the menu or playback screen.

**⑩ Four-way controller (▲ ▼ ◀ ▶)**

Uses it to move cursor or change items in menus, Fn menu and playback screen.

**⑪ Fn button**

Press to display the Fn menu. Press the four-way controller (▲ ◀ ▶) to determine the following operation. (p.102)

## How to Operate the Menu

This section explains operation methods for [📷 Rec. Mode] menu, [▶ Playback] menu, [⏏ Set-up] menu and [C Custom Setting] menu.

### Displaying the Menu screen

#### 1 Press the MENU button in Capture mode.

The [📷 Rec. Mode] menu appears on the LCD monitor.

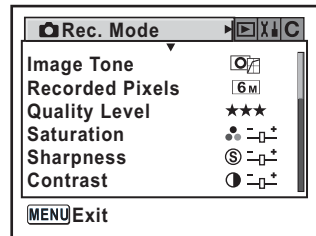
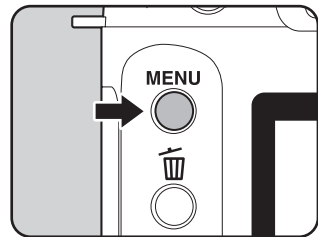

#### 2 Press the four-way controller (▶).

[▶ Playback] menu, [⏏ Set-up] menu and [C Custom Setting] menu appear in order each time the four-way controller is pressed.

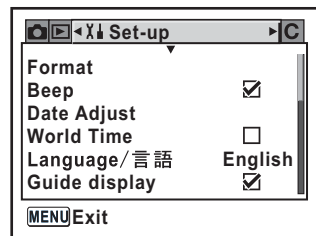

## Select a menu item and set

Procedure to set the [Quality Level] on the [📷 Rec. Mode] menu is explained as an example.

### 3 Use the four-way controller (▲▼) to choose an item.

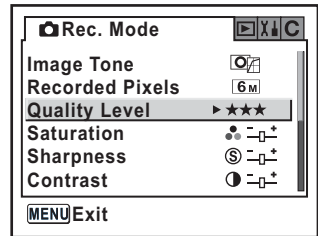

### 4 Press the four-way controller (▶).

Available [Quality Level] options appear.

Press the four-way controller (▶) to move to the pop-up menu if there is one.

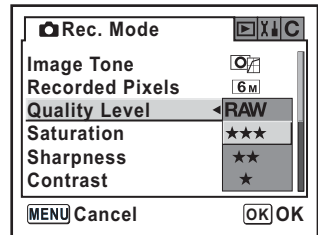

### 5 Use the four-way controller (▲▼) to select a setting.

### 6 Press the OK button.

The camera returns to the menu screen. Next, set other items. Press the **MENU** button to return to Capture or Playback mode.



Even after you press the **MENU** button and close the menu screen, your settings will not be saved if the camera is turned off improperly (such as by removing the batteries while the camera is on).



- You can use the e-dial to switch among the [📷 Rec. Mode] menu, the [▶ Playback] menu, [X↓ Set-up] menu, and [C Custom Setting] menu when no pop-up menu is displayed.
- If the **MENU** button is pressed in Capture mode, the [📷 Rec. Mode] menu appears. If the **MENU** button is pressed in Playback mode, the [▶ Playback] menu appears.

## [📷 Rec. Mode] Menu Setting Items

Perform settings related to capturing in the [📷 Rec. Mode] menu.

Item	Function	Page
Image Tone	Sets the color tone of pictures.	p.108
Recorded Pixels	Sets the recording size of images.	p.109
Quality Level	Sets the image quality.	p.110
Saturation	Sets the color saturation.	p.111
Sharpness	Makes the image outlines sharp or soft.	p.111
Contrast	Sets the image contrast.	p.111
Instant Review	Sets the Instant Review time.	p.171
Auto Bracket	Sets Auto Bracket shooting.	p.146
AE Metering	Selects the part of the screen to use for measuring brightness and determining exposure.	p.131
Swthc dst msr pt	Selects the part of the screen to set focus to.	p.122
AF Mode	Selects the autofocus mode.	p.121
Flash Exp. Comp.	Adjusts the flash exposure to brighten or darken the image.	p.147

## [▶ Playback] Menu Setting Items

Perform settings related to playback and editing images in the [▶ Playback] menu.

Item	Function	Page
Plybk dsply mthd	Sets capturing information to show during playback.	p.161
Bright Portion	Sets to display over exposed area warning during Instant Review or Playback.	p.161
Digital Filter	Edits captured images to black and white or sepia tint, or add softening and slimming effects.	p.71
Slideshow	Plays back recorded images one after another.	p.68

## [X] Set-up] Menu Setting Items

Perform various settings related to the camera in the [X] Set-up] menu.

Item	Function	Page
Format	Formats the SD Memory Card.	p.163
Beep	Switches the beep tone on/off.	p.164
Date Adjust	Sets the date format and time.	p.164
World Time	Sets to enable displaying of local time when traveling abroad.	p.165
Language/言語	Changes the language in which menus and messages appear.	p.168
Guide display	Sets to display indicators in LCD monitor.	p.168
Brightness Level	Changes the brightness of the LCD monitor.	p.169
Video Out	Sets the output format to the TV monitor.	p.169
Transfer Mode*	Sets the USB cable connection (PC or printer).	p.84
Auto Power Off	Sets the time to turn off automatically.	p.170
File #	Sets the method used to add file numbers.	p.170
Sensor Cleaning	Locks the mirror in the up position for cleaning the CCD.	p.183
Reset	Resets all settings other than Date Adjust, Language, Video Out and World Time.	p.172

- \* Refer to p.13 of the “PENTAX PHOTO Browser 2.1/PENTAX PHOTO Laboratory 2.1 Operating Manual” for details on connecting the camera to a PC.

## [C Custom Setting] Menu Setting Items

Set custom functions to fully use the functions of a SLR camera with the Custom Function Menu. The default setting does not use Custom Function.

[C Custom Setting] menu settings are activated when [Setting], the first item, is  (on).

Item	Function	Page
Setting	Sets to use the Custom Function Menu.	—
Noise Reduction	Sets to use Noise Reduction in slow speed shooting.	—
Expsr Setting Steps	Sets the adjustment steps for exposure.	p.143
ISO Corction in AUTO	Automatically corrects sensitivity range when Sensitivity is set to [AUTO].	p.115
ISO Snsvtvy Wrn Dspl	Sets the maximum sensitivity level. ISO Sensitivity Warning Display appears when set sensitivity is reached or exceeded.	p.116
Link AF Point and AE	Sets to link exposure and focus point during multi-segment metering.	p.132
Meter Operating Time	Sets the exposure metering time.	p.133
AE-L with AF locked	Sets to fix exposure value when focus is locked.	p.125
Recordable Image No.	Sets to switch number of recordable images in the LCD panel and viewfinder to number of continuous shooting recordable images when shutter release button is pressed halfway.	—
OK btn when shooting	Sets the action for the <b>OK</b> button when pressed during shooting.	p.120, p.122
AE-L btnn on M expsr	Selects the exposure adjustment method when the <b>AE-L</b> button is pressed in <b>M</b> (Manual) mode.	p.141
Superimpose AF Area	Sets to display superimposed AF area in the viewfinder.	p.122
AF in remote control	Sets to use Autofocus when shooting with remote control. Shutter releases after AF activates if shutter is released from remote control when [On]. Shutter cannot be released until in focus. AF does not activate at shutter release from remote control when [Off].	—

Item	Function	Page
FI with S lens used	Sets to enable focus indicator when screw mount lens is in use. Lens is recognized even when lens is not attached to the camera when enabled.	—
Using aperture ring	Sets to enable shutter release when lens aperture ring is set at other than <b>A</b> .	p.182
Release when Chrging	Sets to release shutter while the built-in flash is charging.	p.148
Instant Review Dsply	Sets to display histogram during Instant Review.	p.171
Mag to Strt Zm Plybk	Sets the initial magnification of the zoom playback. Choose from [1.2 times], [2 times], [4 times], [8 times] and [12 times]. The default setting is [1.2 times].	—
Man. WB Measurement	Sets to meter entire screen or Spot area when setting white balance to manual.	p.113
Color Space	Sets the color space to use.	p.117
Reset Custom Fncion	Resets all the settings in the Custom Function menu to the defaults.	p.173

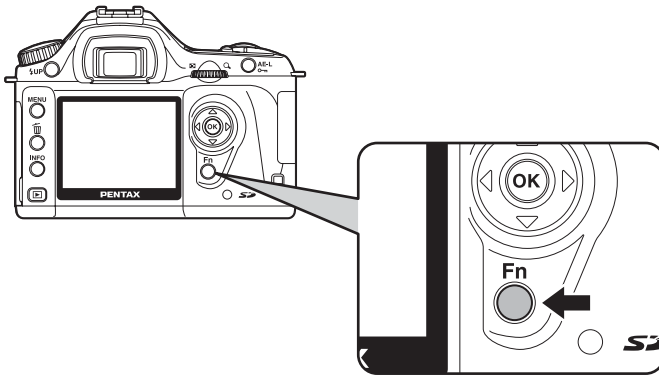

## Capture Mode

Press the **Fn** button while taking a picture.  
The Fn menu appears.

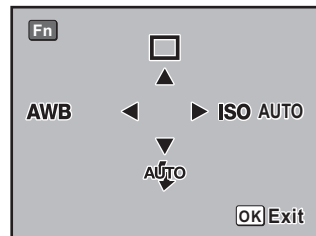

Press the four-way controller (▲▼◀▶) to set the operation.

Four-way controller	Item	Function	Page
▲	Drive Mode	Selects Continuous shooting, Self-Timer, Remote control or Auto bracket.	p.53, p.55, p.59, p.144
▼	Flash Mode	Adjusts the method of flash discharge.	p.49
◀	White Balance	Adjusts the color for the color of the light source illuminating the subject.	p.112
▶	Sensitivity	Sets the sensitivity.	p.115



## Playback Mode

Press the **Fn** button during playback. The Fn menu appears.

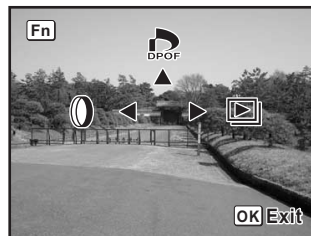

Press the four-way controller (▲◀▶) to set the operation.

Four-way controller	Item	Function	Page
▲	DPOF Settings	Sets the DPOF settings.	p.79
◀	Digital Filter	Edits captured images to black and white or sepia tint, or adds softening and slimming effects.	p.71
▶	Slideshow	Plays back recorded images one after another.	p.68

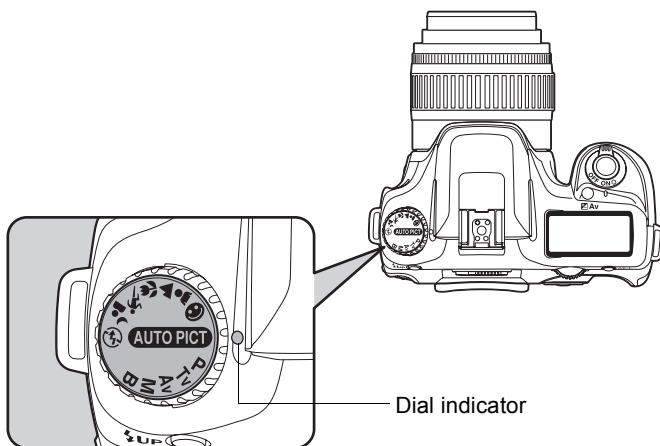

You can switch the Shooting mode by setting the icons on the mode dial to the dial indicator.

Item	Function	Page
(Auto Picture)	Selects automatically from Normal, Portrait, Landscape, Macro, and Moving Object Modes.	p.47
(Normal)	The basic picture-taking mode.	
(Portrait)	Optimal for capturing portraits.	
(Landscape)	Deepens the focus range, emphasizes contour and saturation of trees and the sky, and produces a bright image.	
(Macro)	Lets you take vibrant pictures of flowers or other small subjects at short distances.	
(Moving Object)	Lets you take sharp pictures of a quickly moving subject, such as a sporting event.	
(Night Scene Portrait)	Lets you capture people against a night view or dusk.	
(Flash OFF)	Deactivates the flash. Other settings are the same as  (Normal).	



For (Night Scene Portrait), the shutter speed becomes slower in dark places, even if the built-in flash is used. Use a tripod to avoid camera shake.

Item	Function	Page
<b>P</b> (Program)	Automatically sets shutter speed and aperture to the proper exposure when taking pictures.	p.134
<b>Tv</b> (Shutter Priority)	Lets you set the desired shutter speed for expressing the motion of moving subjects. Take pictures of fast moving subjects that look still or subjects that give a sense of movement.	p.135
<b>Av</b> (Aperture Priority)	Lets you set the desired aperture for controlling the depth of field. Use to blur or focus on the background.	p.137
<b>M</b> (Manual)	Lets you create the picture you have in mind by combining set shutter speed and aperture.	p.139
<b>B</b> (Bulb)	Lets you capture images that require slow shutter speeds such as fireworks and night scenes.	p.141



# 5 Function Reference

---



Introduces functions to further enhance your *\*istDS2* experience.

<b>Setting the Recorded Pixels and Quality Level ...</b>	<b>108</b>
<b>Focusing .....</b>	<b>118</b>
<b>Setting the Exposure .....</b>	<b>128</b>
<b>Using the Built-in Flash .....</b>	<b>147</b>
<b>Settings During Playback .....</b>	<b>161</b>
<b>Camera Settings .....</b>	<b>163</b>
<b>Resetting to Default Settings .....</b>	<b>172</b>

# Setting the Recorded Pixels and Quality Level

## Setting the Image Tone

Set the basic color tone of pictures. The default setting is  (Bright).

	Bright	Images are finished brightly, with high contrast and sharp.
	Natural	Images are finished naturally and suitable for retouching.

Set in [Image Tone] in the [ Rec. Mode] menu. (p.98)

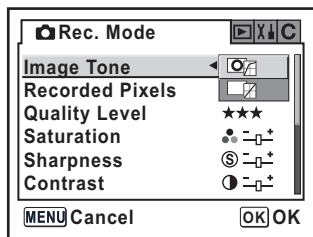

Settings cannot be changed in Picture mode (p.47). Setting is fixed to  (bright).

## Setting the Recorded Pixels

You can select the number of recorded pixels from **6M** (3008×2008/3008×2000), **4M** (2400×1600) and **1.5M** (1536×1024). The more pixels there are, the larger the picture and the bigger the file size. The file size will also differ according to quality level settings. The default setting is **6M** (3008×2000).

<b>6M</b>	3008×2008 (RAW) 3008×2000 (JPEG)	Suited for printing on A3 paper.
<b>4M</b>	2400×1600	Suited for printing on A4 paper.
<b>1.5M</b>	1536×1024	Suited for printing on A5 paper.

Set in [Recorded Pixels] in the [ Rec. Mode] menu. (p.98)

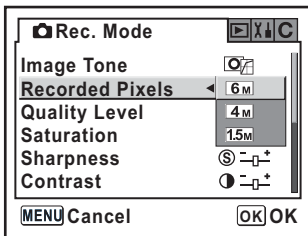

[Recorded Pixels] cannot be selected if the [Quality Level] is set to **RAW**. (Fixed at 3008×2008)

## Setting the Quality Level

You can set the image quality level. The file size will also differ according to the Recorded Pixels settings. The default setting is ★★★ (Best).

RAW	RAW	RAW data is CCD output data saved without processing. Effects such as White Balance, Contrast, Saturation and Sharpness are not applied to the image but such information is saved. Transfer to a PC, apply effects with the enclosed PENTAX PHOTO Laboratory 2.1 and create JPEG and TIFF images.
★★★	Best	Lowest compression rate, suited for printing large pictures such as A4 size. Image is saved in JPEG format.
★★	Better	Standard compression rate, suited for viewing as photographs or on your computer screen. Image is saved in JPEG format.
★	Good	Highest compression rate, suitable for attaching to e-mail or posting on websites. Image is saved in JPEG format.

Set in [Quality Level] in the [📷 Rec. Mode] menu. (p.98)

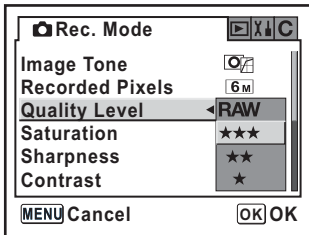



## Setting the Saturation/Sharpness/Contrast

Select from five levels of Saturation, Sharpness and Contrast. The default setting is [0 (Standard)] for all.

Saturation	Sets the color saturation.
Sharpness	Makes the image outlines sharp or soft.
Contrast	Sets the image contrast.

Set [Saturation], [Sharpness] and [Contrast] in the [📷 Rec. Mode] menu. (p.98)



Settings cannot be changed in Picture mode (p.47).

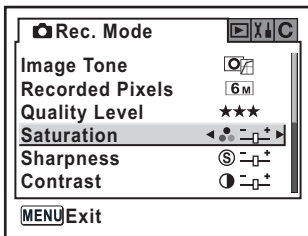

Towards + : Higher saturation

Towards - : Lower saturation

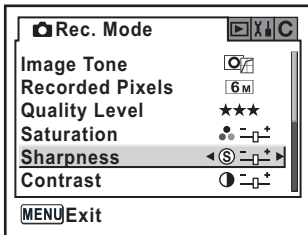

Towards + : Higher sharpness

Towards - : Lower sharpness

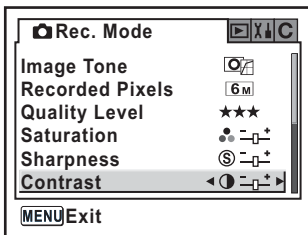







Towards + : Higher contrast

Towards - : Lower contrast

## Setting the White Balance

The color of the subject changes with the light source. For example, the same white object will be a different shade of white in daylight than under a light bulb. In cameras using film, this is adjusted by changing the film or using filters. In digital cameras, the whiteness is adjusted using white balance. The default setting is **AWB** (Auto).

<b>AWB</b>	Auto	Automatically adjusts the white balance. (About 4000 to 8000K)
	Daylight	For use when taking pictures in sunlight. (About 5200K)
	Shade	For use when taking pictures in the shade. (About 8000K)
	Cloudy	For use when taking pictures on cloudy days. (About 6000K)
	Fluorescent Light	For use this when taking pictures under fluorescent lighting. Select the type of fluorescent light, from W (white) (About 4200K), N (neutral white) (About 5000K), and D (daylight) (About 6500K).
	Tungsten Light	For use when taking pictures under light bulb or other tungsten light. (About 2850K)
	Flash	For use to take pictures using the built-in flash. (About 5400K)
	Manual	For use when taking pictures by manually adjusting the white balance.

The color temperature (K) is an estimate. This does not indicate precise colors.

Set [White Balance] in the Fn menu. (p.102)

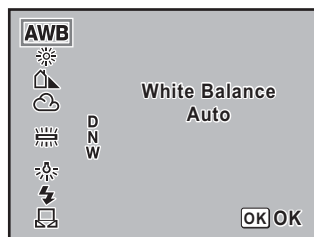

- Refer to p.113 for manual adjustment method.
- White balance cannot be adjusted in Picture mode (p.47).

## Color Temperature

The color of light shifts towards blue as the color temperature rises, and towards red as the color temperature falls. Color temperature describes this change in light color in terms of absolute temperature (K: Kelvin). This camera is capable of setting the white balance to enable taking pictures with natural coloring under a variety of lighting conditions.

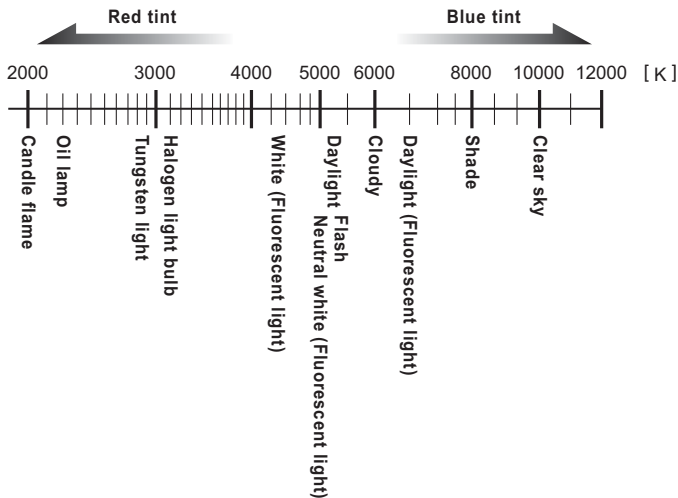

### Adjusting the White Balance Manually

You can adjust the white balance depending on the light source when taking pictures. With Manual White Balance, the camera can store delicate shades that cannot be precisely adjusted with the white balance preset values provided in the camera (p.112). This provides the optimum white balance for your surroundings.

**1** Set the mode dial to **P**, **Tv**, **Av**, or **M**.

**2** Press the **Fn** button.

The Fn menu appears.

**3** Press the four-way controller (◀).

The White Balance screen appears.

- 4** Use the four-way controller (▼) to select  (Manual).

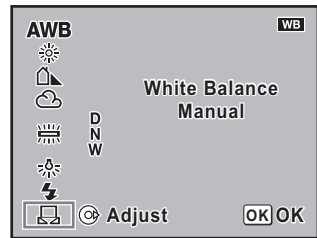

- 5** Press the four-way controller (▶).

The message screen appears.

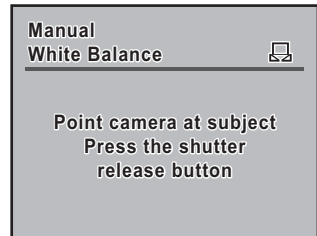

- 6** Fully display a white or gray sheet of paper in the viewfinder under the light to adjust white balance.

- 7** Press the shutter release button fully.

Slide the focus mode lever to **MF** when the shutter cannot be released. [OK] appears on the LCD monitor when setting is completed. [NG] appears when setting is not completed successfully.

- 8** Press the OK button.



- No image is recorded when the shutter release button is pressed to adjust the white balance.
- Press the **Fn** button when adjustment is unsuccessful to set again.
- You can set the range to measure white balance when setting manually. White balance is measured using the entire screen using multi-segment metering (p.131) if [Entire screen] is selected for [Man. WB Measurement] in [C Custom Setting] menu (p.101). White Balance is only adjusted in the spot metering area (p.132) if [Spot metering area] is selected.
- If picture is extremely overexposed or underexposed, white balance may not be adjusted. In this case, adjust appropriate exposure and adjust the white balance.

## Setting the Sensitivity

You can set the sensitivity to suit the brightness of the surroundings. The sensitivity can be set to [AUTO] or within a sensitivity range equivalent to ISO 200 to 3200. The default setting is [AUTO]. Set [Sensitivity] in the Fn menu. (p.102)

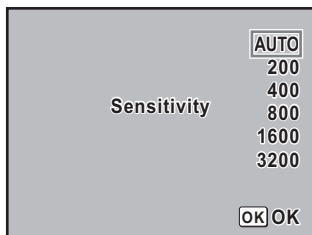

Captured images can show more noise if higher Sensitivity is set.

5

Function Reference

## Setting the Range of Automatic Correction in AUTO

Set range to automatically correct sensitivity when Sensitivity is set to [AUTO]. The sensitivity is automatically corrected in the range of [ISO 200-800] by default.

1	ISO 200-800	Corrects sensitivity automatically in the range of ISO 200 to 800.
2	ISO 200-400	Corrects sensitivity automatically in the range of ISO 200 to 400.
3	ISO 200-1600	Corrects sensitivity automatically in the range of ISO 200 to 1600.
4	ISO 200-3200	Corrects sensitivity automatically in the range of ISO 200 to 3200.

Set in [ISO Corction in AUTO] in the [C Custom Setting] menu. (p.100)

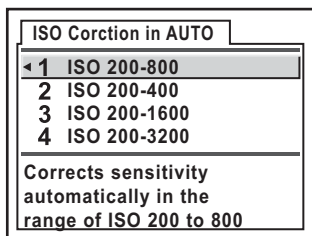



Sensitivity is not corrected in the following.

- Exposure mode is **M** (Manual) or **B** (Bulb) mode
- Flash is discharged
- Auto bracketing
- EV Compensation

## ISO Sensitivity Warning Display

ISO Sensitivity Warning appears in the viewfinder when a sensitivity value of your choice is reached or exceeded. Set a sensitivity that is not regularly used to avoid forgetting to reset when sensitivity is raised. ISO Sensitivity Warning is not displayed by default.

1	Off	ISO Sensitivity Warning is not displayed.
2	ISO 400	ISO Sensitivity Warning is displayed when ISO 400 is set or exceeded.
3	ISO 800	ISO Sensitivity Warning is displayed when ISO 800 is set or exceeded.
4	ISO 1600	ISO Sensitivity Warning is displayed when ISO 1600 is set or exceeded.
5	ISO 3200	ISO Sensitivity Warning is displayed when ISO 3200 is set.

Set in [ISO Snsvtv Wrn Dspl] in the [**C** Custom Setting] menu. (p.100)

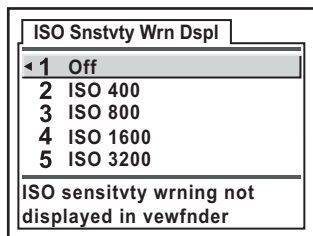

**ISO** (ISO Sensitivity Warning) appears in the viewfinder when the set sensitivity is set or exceeded.



ISO Sensitivity Warning is not displayed if sensitivity is automatically corrected (p.115).

## Setting the Color Space

You can set the color space to use. The default setting is [1 sRGB].

1	sRGB	Sets to sRGB color space.
2	AdobeRGB	Sets to AdobeRGB color space.

Set in [Color Space] in the [**C** Custom Setting] menu. (p.101)

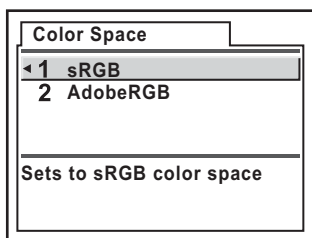

### Color Space

Color ranges for various input/output devices, such as digital cameras, monitors, and printers, differ.

This color range is called the Color Space.

To recreate different color spaces in different devices, standard color spaces have been proposed. This camera supports sRGB and AdobeRGB.

sRGB is mainly used for devices such as a PC.

AdobeRGB covers a wider area than sRGB and is used for occupational uses such as industrial printing.

An image created in AdobeRGB may appear lighter than an image created in sRGB when output from a sRGB compatible device.

You can focus with the following methods.

<b>AF</b>	Autofocus	The camera is focused when the shutter release button is pressed halfway.
<b>MF</b>	Manual focus	Manually adjust the focus.

Select the focusing area in the viewfinder (focus point) from [Auto], [Select] and [Center]. (p.122)

## Using the Autofocus

You can choose the autofocus mode from **A.F.S** (Single mode) where the shutter release button is pressed halfway to focus on the subject and the focus is locked at that position, and **A.F.C** (Continuous mode) where the subject is kept in focus by continuous adjustment while the shutter release button is pressed halfway. (p.121)

5

Function Reference

### 1 Set the focus mode lever to AF.

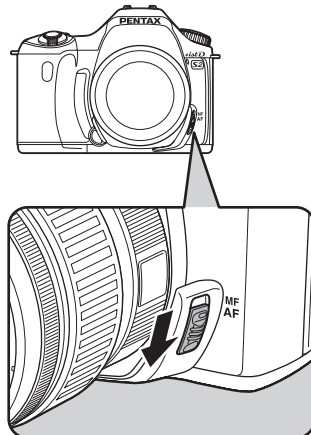



## 2 Look through the viewfinder and press the shutter release button halfway.



The focus indicator ● appears in the viewfinder when focused (if it is blinking, the subject is not in focus).

☞ Hard-to-Autofocus Subjects (p.46)

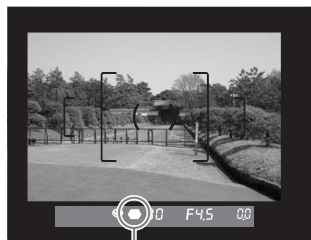

Focus indicator



- In **A.F.S** (Single mode), the focus is locked (focus lock) while ● is lit. To focus on another subject, take your finger off the shutter release button first.
- During  (Moving Object) mode or when the focus mode is set to **A.F.C** (Continuous mode) (p.121), focus is adjusted continuously, tracking the moving object as long as the shutter release button is kept pressed halfway.
- The shutter cannot be released until the subject is in focus in **A.F.S** (Single mode) (p.121). If the subject is too close to the camera, move back and take the picture. Adjust the focus manually if the subject is difficult to focus (p.46). (p.126)
- In **A.F.S** (Single mode), press the shutter release button halfway. The built-in flash will discharge automatically several times, enabling the autofocus to focus on the subject easier if the subject is in a dark area and the built-in flash is up.
- Regardless if the camera is set to **A.F.S** (Single mode) or **A.F.C** (Continuous mode), the camera automatically tracks the subject if it is determined to be a moving object.

## Use the OK Button to Focus on the Subject

You can set the camera so that the focusing is not performed when the shutter release button is pressed halfway and is performed when the **OK** button is pressed. This is useful when you wish to temporarily use autofocus while using manual focus.

Set [3 Enable AF] in [OK btn when shooting] in the [C Custom Setting] menu. (p.100)

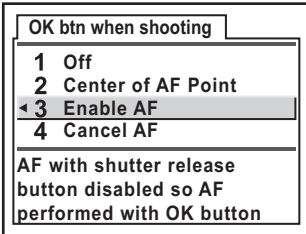

5



Only use this function with lenses that are compatible with Quick Shift Focus.



- Select [4 Cancel AF]. **MF** appears in the viewfinder while the **OK** button is pressed. Autofocus does not activate when the shutter release button is pressed. This is useful when you wish to temporarily use manual focus while using autofocus.
- You can focus using the focus ring and release the shutter while **OK** button is pressed when using a lens compatible with Quick Shift Focus (take your finger off the **OK** button to immediately return to AF mode).

## Setting the AF Mode

You can choose from the following two autofocus modes. The default setting is **A.F.S** (Single mode).

<b>A.F.S</b>	Single mode	When the shutter release button is pressed halfway to focus on the subject, the focus is locked at that position.
<b>A.F.C</b>	Continuous mode	The subject is kept in focus by continuous adjustment while the shutter release button is pressed halfway.

Set [AF Mode] in the [ Rec. Mode] menu (p.98).

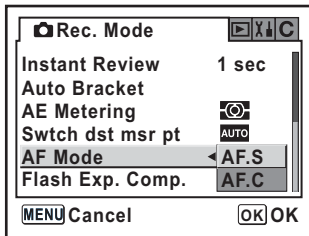



- Settings cannot be changed in Picture mode (p.47).
- **A.F.C** (Continuous mode) can be set when the mode dial is set to **P**, **Tv**, **Av**, **M** or **B**. The autofocus mode is set to **A.F.C** in  (Moving Object) Picture mode.

## Selecting the Focusing Area (Focus Point)

Choose the part of the viewfinder to set focus to. The default setting is **AUTO** (Auto).

The selected focus point lights red in the viewfinder.

	Auto	The camera selects the optimum focus point even if the subject is not centered.
	Select	Sets the focusing area to one of the eleven points in the AF area.
	Center	Sets the focusing area to the center of the viewfinder.

Set in [Swch dst msr pt] in the [ Rec. Mode] menu (p.98).

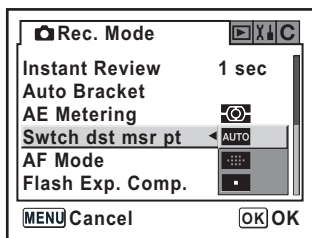

5

Function Reference



Focus point is not displayed in the viewfinder when [2 Off] is selected for [Superimpose AF Area] in the [**C** Custom Setting] menu. (p.100)

## Setting the Focus Position in the Viewfinder

- 1 Select  (Select) in [Swch dst msr pt] in the [📷 Rec. Mode] menu.
- 2 Look through the viewfinder and check the position of the subject.

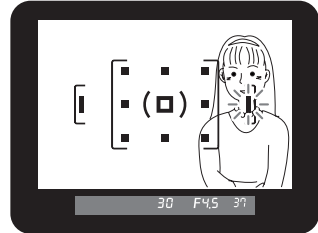

- 3 Use the four-way controller (▲ ▼ ◀ ▶) to select the desired focus point.

The focus point lights red in the viewfinder (Superimpose AF Area) and you can check where you set the focus point.



- When [OK btn when shooting] in the [C Custom Setting] menu is set to [2 Center of AF Point], press the **OK** button to set the focus point to the center if the focus point other than the center is selected for  (Select).
- The focus point is fixed to the center position regardless of this setting with lenses other than DA, D FA, FA J, FA or F lenses.

## Fixing the Focus (Focus Lock)

If the subject is outside the range of the focusing area, the camera cannot automatically focus on the subject. In this situation, you can aim the focusing area toward the subject, use focus lock and recompose the picture.

### 1 Frame the desired composition for your picture in the viewfinder.

Use the focus lock function when the subject you wish to focus on does not match any of the focus points.

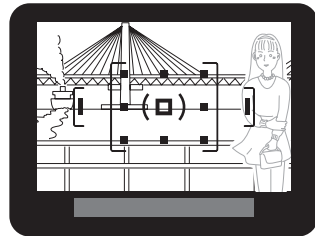

(Example)

The person is out of focus and the background is focused instead.

### 2 Center the subject to focus in the viewfinder and press the shutter release button halfway.

The focus indicator  appears and you will hear a beep when the subject comes into focus (if it is blinking, the subject is not in focus).

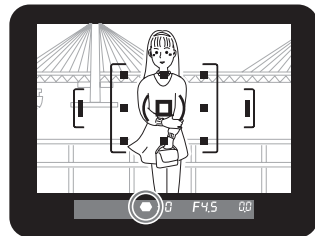



### 3 Lock the focus.

Keep the shutter release button pressed halfway. The focus will remain locked.

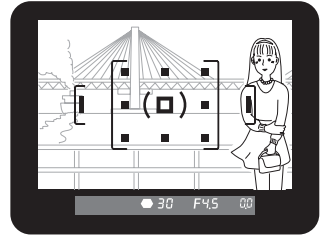
## 4 Re-compose the picture while keeping the shutter release button pressed halfway.



- The focus is locked while the focus indicator  is lit.
- Turning the zooming ring in focus lock mode may cause the subject to be out of focus.
- The beep can be turned off. (p.164)
- You cannot set focus lock when the focus mode is set to **AFC** (Continuous mode) or the capture mode is set to  (Moving Object). In **AFC** (Continuous mode) or  (Moving Object) mode, the autofocus continues to focus on the subject until the shutter is released. (Continuous Autofocus)

## 5

### Fixing Exposure when Focus is Locked

Set [AE-L with AF locked] in the [C Custom Setting] menu (p.100) to fix the exposure value while focus is locked. Exposure is not fixed by default during focus lock.

1	Off	Exposure is not fixed when focus is locked.
2	On	Exposure is fixed when focus is locked.

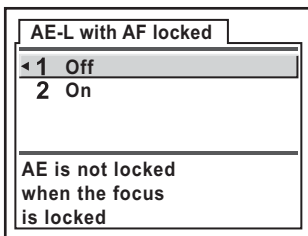

## Adjusting the Focus Manually (Manual Focus)

When you adjust the focus manually, you can either check with the focus indicator in the viewfinder or use the viewfinder matte field to adjust focus.

### Using the Focus Indicator

You can manually adjust the focus using the focus indicator .

- 1 **Set the focus mode lever to MF.**

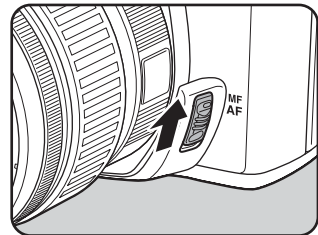

- 2 **Look through the viewfinder, press the shutter release button halfway and turn the focusing ring.**

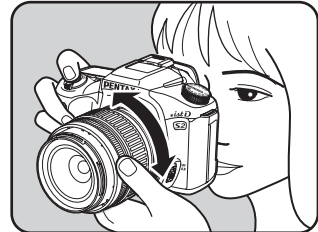

The focus indicator  appears and you will hear a beep when the subject comes into focus.

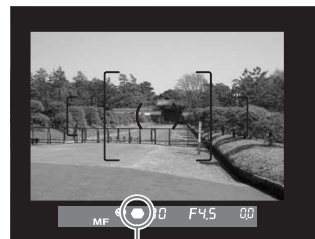

Focus indicator





- Use the matte field in the viewfinder when the subject is difficult to focus (p.46) and the focus indicator will not stay lit.
- The beep can be turned off. (p.164)

## Using the Viewfinder Matte Field

You can manually adjust the focus using the viewfinder matte field.

- 1 Set the focus mode lever to MF.**

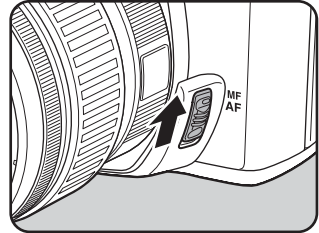

- 2 Look through the viewfinder and turn the focusing ring until the subject looks sharp on the screen.**

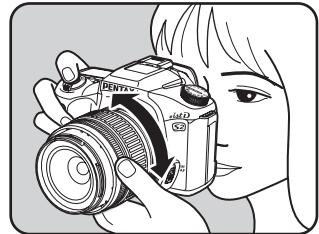

## Effect of Aperture and Shutter Speed

Correct exposure of the subject is determined by the combination of shutter speed and aperture setting. There are many correct combinations of shutter speed and aperture for a particular subject. Different combinations produce different effects.

### Effect of Shutter Speed

The shutter speed determines the length of time that light is allowed to strike the CCD. Adjust the amount of light striking the CCD.

#### ● Using slower shutter speed

If the subject is moving, the image will be blurred because the shutter is open longer.

It is possible to enhance the effect of motion (rivers, waterfalls, waves, etc.) by intentionally using a slower shutter speed.

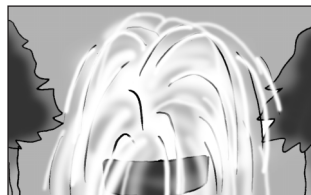

#### ● Using faster shutter speed

Choosing a faster shutter speed will allow freezing the action of a moving subject. A faster shutter speed also helps preventing camera shake.

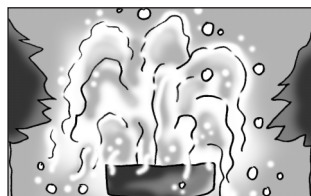

5

Function Reference

## Effect of Aperture

Adjust the amount of light hitting the CCD by changing the aperture.

### ● Opening the aperture (reduce the aperture value)

Objects closer and farther than the focused subject will be more out of focus. For instance, if you take a picture of flower against a landscape with the aperture open, the landscape in front and behind the flower will be blurred, emphasizing only the flower.

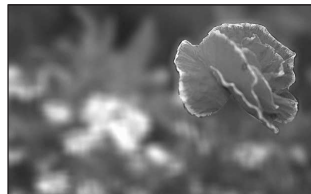

### ● Closing the aperture (increase the aperture value)

The range in focus expands forward and backward. For instance, if you take a picture of flower against a landscape with the aperture narrowed, the landscape in front and behind the flower will be in focus.



## Depth of Field

When you focus on a portion of the subject, there is a range in which object closer and farther will also be in focus. This focused range is called the depth of field.

- The depth of field for the *\*istDS2* differs depending on the lens but compared to a 35 mm camera, the value is roughly one aperture setting lower (the focused range becomes narrower).
- The wider the wide-angle lens, and the farther away the subject, the wider the depth of field is (some zoom lenses do not have a scale for depth of field because of their structure).

Depth of field	Shallow	←————→	Deep
Area of focus	Narrow	←————→	Wide
Aperture	Open (Smaller value)	←————→	Close (Larger value)
Lens focal length	Longer (Telephoto)	←————→	Shorter (Wider)
Distance to the subject	Near	←————→	Far

## How to Check Depth of Field

When you focus on a portion of the subject, there is a range in which object closer and farther will also be in focus. This focused range is called the depth of field. If you use Depth of Field confirmation, you can check the depth of field in the viewfinder before taking a picture.

### 1 Focus on the subject.

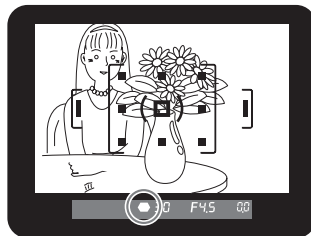



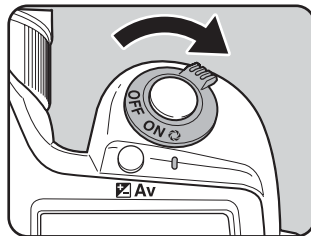

### 2 Turn the main switch to while looking through the viewfinder.



You can check the depth of field in the viewfinder while holding the main switch.



- No shooting information is displayed in the viewfinder, and the shutter cannot be released while the main switch is in the preview position (.
- You can check the depth of field in all exposure modes.

## Selecting the Metering Method

Choose the part of the screen to use for measuring brightness and determining exposure.  (Multi-segment metering),  (Center-weighted metering) or  (Spot metering) mode can be selected. The default setting is  (Multi-segment metering).

	Multi-segment metering	Segment the screen in 16 parts, meter each portion and determine the appropriate exposure.
	Center-weighted metering	Measure the entire screen with an emphasis on the center and determine the exposure.
	Spot metering	Measure only the center of the screen and determine exposure.

Set in [AE Metering] in the [ Rec. Mode] menu. (p.98)

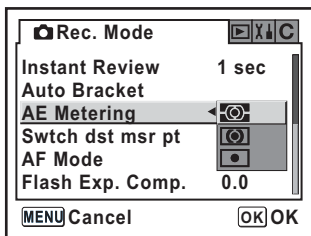

5

## Using the Multi-Segment Metering

The scene in the viewfinder is metered in 16 different zones as shown in the illustration when using the multi-segment metering. This mode automatically determines what level of brightness is in which portion.

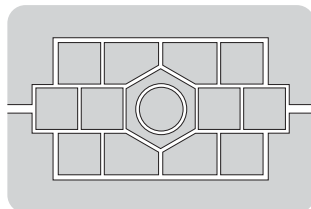

The center-weighted metering mode is automatically set even if you select the multi-segment metering mode when using a lens other than a DA, D FA, FA J, FA, F or A lens (can only be used if permission is set in [Using aperture ring] in the [ Custom Setting] menu (p.101)).

## Linking AF Point and AE During Multi-Segmented Metering

In [Link AF Point and AE] (p.100) of the [C Custom Setting] menu, you can link the exposure and focus point during multi-segment metering. The default setting is [1 Off].

1	Off	Exposure is set separately from focus point.
2	On	Exposure is set in accordance with focus point.

## Using the Center-Weighted Metering

Metering is weighted at the center of the screen. Use this metering when you want to compensate the exposure by experience, instead of leaving it to the camera. The illustration shows that sensitivity increases as the pattern height increases (center). This mode does not automatically compensate for backlit scenes.

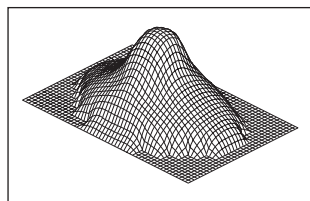

## Using the Spot Metering

With spot metering, brightness is measured only within a limited area at the center of the screen as shown in the illustration. You can use this in combination with the AE lock (p.143) when the subject is extremely small and proper exposure is difficult to obtain.

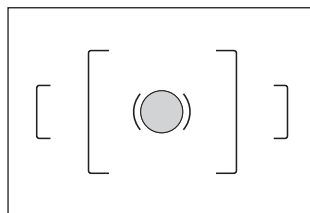

## Setting the Meter Operating Time

Set the metering time in [Meter Operating Time] in the [**C** Custom Setting] menu (p.100). The default setting is [1 10sec].

1	10sec	Metering time is set to 10 seconds.
2	3sec	Metering time is set to 3 seconds.
3	30sec	Metering time is set to 30 seconds.

## Changing the Exposure Mode

This camera features five exposure modes along with the picture modes. Use the mode dial (p.104) to change the exposure mode.

Exposure Mode	Description	Exposure Compensation	Change Shutter Speed	Change Aperture
<b>P</b> (Program)	Automatically sets shutter speed and aperture for taking pictures at the proper exposure.	Yes	No	No
<b>Tv</b> (Shutter Priority)	Lets you set a desired shutter speed for expressing moving subjects. Take pictures of fast moving subjects that look still or subjects that show movement.	Yes	Yes	No
<b>Av</b> (Aperture Priority)	Lets you set a desired aperture for controlling the depth of field. Use to blur the background or be sharp from front to back.	Yes	No	Yes
<b>M</b> (Manual)	Lets you set shutter speed and aperture to create the picture you have in mind.	No	Yes	Yes
<b>B</b> (Bulb)	Lets you capture images that require slow shutter speeds such as fireworks and night scenes.	No	No	Yes

## Using the P (Program) Mode

Shutter speed and aperture value are automatically set for taking pictures at the proper exposure.

Perform the following to adjust the exposure.

### 1 Set the mode dial to P .

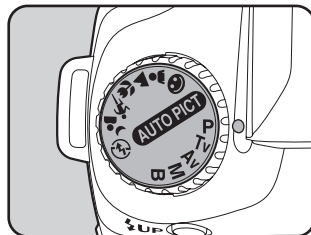

### 2 Turn the e-dial while pressing the $\square$ Av button and adjust the exposure.

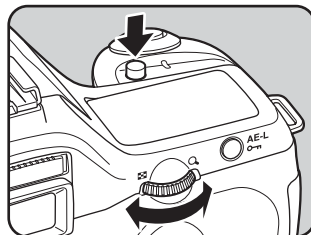

The EV Compensation is displayed in the viewfinder and on the LCD panel.



EV Compensation

The shutter speed and aperture value are also displayed while adjusting the exposure.



- Set EV Compensation in increments of 1/2 EV or 1/3 EV. Set exposure setting steps in [Expsr Setting Steps] in the [C Custom Setting] menu. (p.143)
- You can automatically correct the sensitivity if appropriate exposure cannot be set with the set criteria. Set [Sensitivity] to [AUTO] in the Fn menu. (p.115)
- Set the aperture to the **A** position while holding down the auto-lock button when using a lens with an aperture ring.

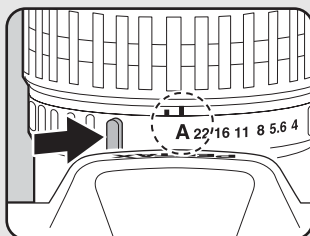



## Using the Tv (Shutter Priority) Mode

Set a proper shutter speed and use to express moving subjects. Set the shutter speed faster and capture fast moving subjects as if they are still or slow down the shutter and capture lively images.

Aperture value is automatically set to appropriate exposure depending on the shutter speed.

☞ Effect of Aperture and Shutter Speed (p.128)

### 1 Set the mode dial to Tv.

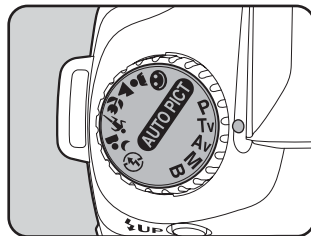

### 2 Turn the e-dial and adjust the shutter speed.

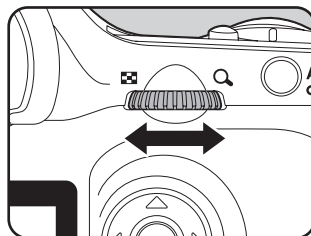

The shutter speed and aperture value are displayed in the viewfinder and on the LCD panel.





- Turn the e-dial while pressing the **Av** button and change the EV Compensation value. (p.142)
- Set the shutter speed in increments of 1/2 EV or 1/3 EV. Set in [Expsr Setting Steps] in the [**C** Custom Setting] menu. (p.143)
- You can automatically correct the sensitivity if appropriate exposure cannot be set with the set criteria. Set [Sensitivity] to [AUTO] in the Fn menu. (p.115)
- Set the aperture to the **A** position while holding down the auto-lock button when using a lens with an aperture ring.

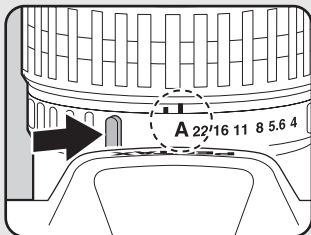

5

Function Reference

## Exposure Warning

If the subject is too bright or too dark, the aperture value will blink in the viewfinder and on the LCD panel. If the subject is too bright, choose a faster shutter speed. If it is too dark, choose a slower shutter speed. When the aperture value indication stops blinking, you can take the picture with proper exposure.



If both the shutter speed and aperture value are blinking, this indicates being out of metering range and the proper exposure cannot be obtained even if the shutter speed is adjusted.

Use an ND (Neutral Density) filter if the subject is too bright.

Use a flash if it is too dark.

## Using the Av (Aperture Priority) Mode

Set a proper aperture and use when you want to adjust the depth of field. The depth of field is deeper and the front and back of the focused object is clear when aperture is set to a large value. The depth of field is shallower and the front and back of the focused object is blurred when aperture is set to a small value.

Shutter speed is automatically set to appropriate exposure depending on the aperture value.

☞ Effect of Aperture and Shutter Speed (p.128)

### 1 Set the mode dial to Av.

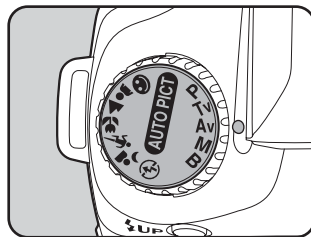

### 2 Turn the e-dial and adjust the aperture value.

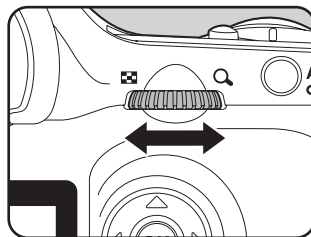

The shutter speed and aperture value are displayed in the viewfinder and on the LCD panel.





- Turn the e-dial while pressing the **Av** button and change the EV Compensation value. (p.142)
- Set the aperture value in increments of 1/2 EV or 1/3 EV. Set in [Expsr Setting Steps] in the [**C** Custom Setting] menu. (p.143)
- You can automatically correct the sensitivity if appropriate exposure cannot be set with the set criteria. Set [Sensitivity] to [AUTO] in the Fn menu. (p.115)
- Set the aperture to the **A** position while holding down the auto-lock button when using a lens with an aperture ring.

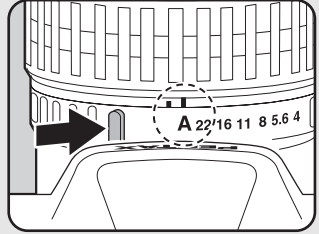

5

Function Reference

## Exposure Warning

If the subject is too bright or too dark, the shutter speed will blink in the viewfinder and on the LCD panel. If the subject is too bright, set the aperture smaller (larger number), and when too dark, open the aperture further (smaller number). Once blinking stops, you can take the picture. If both the shutter speed and aperture value are blinking, this indicates being out of metering range and the proper exposure cannot be obtained even if the aperture is adjusted. Use an ND (Neutral Density) filter if the subject is too bright. Use a flash if it is too dark.



## Using M (Manual) Mode

You can set the shutter speed and aperture value. This mode is suitable to take pictures of your choice by combining them. This mode is convenient for taking pictures using the same shutter speed and aperture setting combination or taking intentionally under-exposed (darker) or over-exposed (brighter) photographs.

☞ Effect of Aperture and Shutter Speed (p.128)

### 1 Set the mode dial to M.

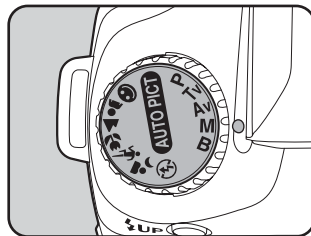

### 2 Turn the e-dial and adjust the shutter speed.

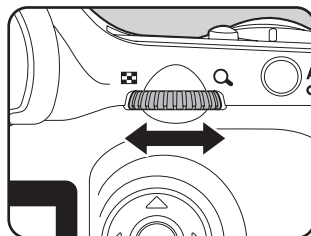

### 3 Turn the e-dial while pressing the $\square$ Av button and adjust the aperture.

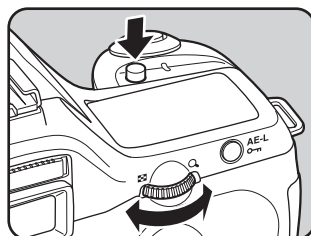

The shutter speed and aperture value are displayed in the viewfinder and on the LCD panel. Of the shutter speed and aperture, the value being adjusted is underlined in the viewfinder. While adjusting the shutter speed or aperture value, the difference with the appropriate exposure (EV value) appears at the bottom right of the viewfinder. The appropriate exposure is set when [0.0] is displayed.



Difference from the appropriate exposure



- When in **M** (Manual) mode, the sensitivity is equivalent to ISO 200 when sensitivity is set to [AUTO].
- Blinks when the difference with appropriate exposure is over  $\pm 3.0$ .
- Set the shutter speed and aperture values in increments of 1/2 EV or 1/3 EV. Set in [Expsr Setting Steps] in the [**C** Custom Setting] menu. (p.143)
- Set the aperture to the **A** position while holding down the auto-lock button when using a lens with an aperture ring.

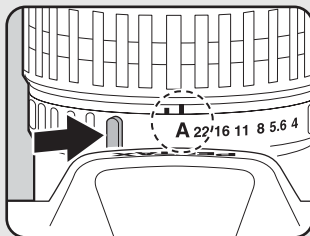

5

## Exposure Warning

You are out of the measuring area if the shutter speed and aperture blink.

Use an ND (Neutral Density) filter if the subject is too bright.

Use a flash if it is too dark.



## About the AE-L Button

The aperture and shutter speed are automatically adjusted to the appropriate exposure at that moment if the **AE-L** button is pressed in **M** (Manual) mode. You can choose from the following three adjustment methods in [AE-L btn on M expsr] in the [**C** Custom Setting] menu.

1	Program Line	The aperture and shutter speed are adjusted automatically.
2	Tv Shift	The aperture is locked and the shutter speed is adjusted automatically.
3	Av Shift	The shutter speed is locked and the aperture is adjusted automatically.

Shutter speed is adjusted to appropriate exposure according to lens aperture when lens aperture is not set to **A** position.

 Notes on [Using Aperture Ring] (p.182)

## Using the B (Bulb) Mode

This mode is useful for the long exposures required for shooting night scenes and fireworks.

The shutter remains open as long as the shutter release button is kept pressed.

### 1 Set the mode dial to **B**.

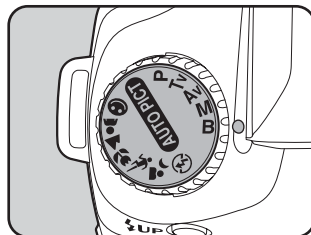

- Turn the e-dial to adjust the aperture value.
- Set the aperture value in increments of 1/2 EV or 1/3 EV. Set in [Expsr Setting Steps] in the [**C** Custom Setting] menu. (p.143)
- Use a sturdy tripod and the cable switch CS-205 (optional) to prevent camera shake when using **B** (Bulb) mode. Connect the cable switch to the cable switch terminal (p.15).
- Bulb shooting is available when using the remote control shooting mode (p.59). The shutter remains open as long as the optional remote control's shutter release button is held down.
- Noise reduction is a process to reduce noise (image roughness or unevenness) caused by low shutter speed. Set in [Noise Reduction] in the [**C** Custom Setting] menu. (p.100)
- When in **B** (Bulb) mode, the sensitivity is equivalent to ISO 200 when sensitivity is set to [AUTO].

## Setting the Exposure

This allows you to deliberately over-expose (brighten) or under-expose (darken) your picture. You can adjust the EV Compensation from  $-2$  to  $+2$  (EV) in increments of  $1/2$  EV or  $1/3$  EV.

Set in [Expsr Setting Steps] in the [**C** Custom Setting] menu. (p.143)

- 1 **Set the compensation with the e-dial while the  Av button is pressed.**

 Av button

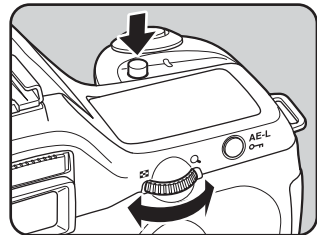

5

Function Reference

- 2 **Confirm the compensation value in the viewfinder.**



Compensation value

 is displayed during compensation.

 blinks when the flash is popped up if the flash compensation is set.



Exposure compensation is not available when the exposure mode is set to **M** (Manual) or **B** (Bulb) mode.



The exposure compensation cannot be canceled by turning the camera off or by setting any other exposure mode.



## Changing the Exposure Setting Steps

Set Exposure Setting Steps in [Expsr Setting Steps] in [**C** Custom Setting] to increments of 1/2 EV or 1/3 EV.

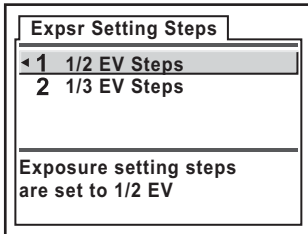

## Recording the Exposure Before Shooting (AE Lock)

AE Lock is a function that memorizes the exposure prior to taking the picture. Use this when the subject is too small or backlit and a proper exposure setting cannot be obtained.

### 1 Press the **AE-L** button.

The camera memorizes the exposure (brightness) at that instant.  
Press it again to unlock.

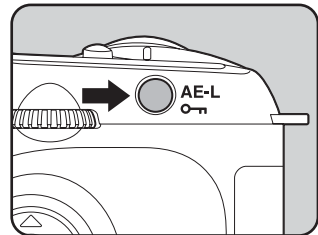

- **\*** is displayed in the viewfinder while the AE lock is engaged. (p.20)
- The exposure remains in memory for twice as much time as the metering timer after releasing the **AE-L** button. The exposure remains locked as long as the **AE-L** button is kept pressed or the shutter release button is kept pressed halfway.
- You will hear a beep when the **AE-L** button is pressed. The beep can be turned off. (p.164)
- AE lock is not available when the exposure mode is **M** (Manual) or **B** (Bulb) mode.
- The combination of shutter speed and aperture value changes depending on the zooming position even while the AE lock is engaged when using a zoom lens for which maximum aperture varies depending on the focal length. However, the exposure value does not change and the picture is taken at the brightness level set by the AE lock.
- If the exposure mode is **M** (Manual), the aperture and/or shutter speed are automatically adjusted to set the appropriate exposure when the **AE-L** button is pressed. (p.141)
- Exposure can be fixed when focus is locked. Set in [AE-L with AF locked] in the [**C** Custom Setting] menu. (p.125)

## Changing the Exposure and Shooting (Auto Bracket)

You can take continuous pictures with different exposure when the shutter release button is pressed. The first frame is exposed with no compensation, the second frame is under-exposed (negative compensation) and the third is over-exposed (positive compensation).



Normal exposure



Under-exposure

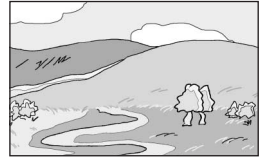

Over-exposure

5

Function Reference

### 1 Press the Fn button in capture mode.

The Fn menu appears.

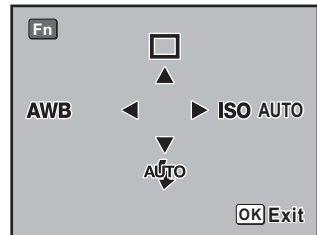

### 2 Press the four-way controller (▲).

The Drive Mode options screen appears.

### 3 Use the four-way controller (▶) to select (Auto Bracket).

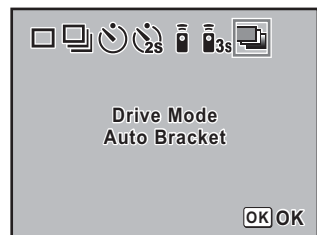

#### 4 Press the OK button twice.

Shooting is ready and  is displayed on the LCD panel.

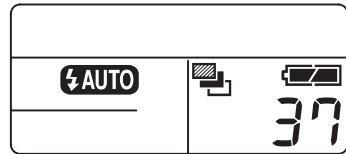

#### 5 Press the shutter release button halfway.

Focus indicator  appears in the viewfinder when focused.

#### 6 Press the shutter release button fully.

Three continuous pictures will be taken, the first with no compensation, the second with negative compensation, and the third with positive compensation.



- When the focus mode is set to **AFS** (Single mode), the focus is locked in the first frame position and used for subsequent continuous frames.
- The auto bracketing exposure setting will remain effective for twice as much time as the exposure metering timer (default setting is 20 seconds) (p.133) when you release your finger from the shutter release button during auto bracketing, and you can take the next picture at the next compensation value. In this case, auto focusing works for each frame. After about twice as much time as the exposure metering timer (default setting is 20 seconds), the camera returns to settings for taking the first picture.
- You can combine Auto Bracket with the built-in flash or external flash (P-TTL auto only) to change only the flash output continuously. However, when using an external flash, holding the shutter release button down to take three continuous frames may cause the second and third frame to be taken before the flash is fully recharged. Always take one frame at a time after confirming that charging is complete.
- Auto Bracket is not available when the exposure mode is set to **B** (Bulb) mode.

## Setting Auto Bracket

Change the shooting order and steps of Auto Bracket.

Bracketng amount (Step interval)	1/2 EV	±0.5, ±1.0, ±1.5, ±2.0
	1/3 EV	±0.3, ±0.7, ±1.0, ±1.3, ±1.7, ±2.0
Shooting images		0 → - → +, - → 0 → +, + → 0 → -

\* Set interval of steps in [Expsr Setting Steps] in the [C Custom Setting] menu. (p.143)

Set in [Auto Bracket] in the [Rec. Mode] menu. (p.98)

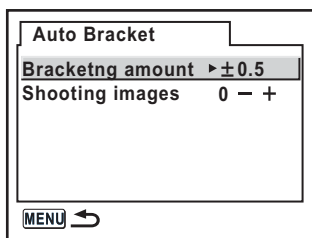

### Taking Only Over-exposed or Under-exposed Pictures

You can use the auto bracketing mode for only under-exposure or over-exposure shots by combining the operation with exposure compensation (p.142). The auto bracketing is performed in both cases on the basis of the specified exposure compensation value.

## Compensating Flash Output

You can change the flash output in a range of  $-2.0$  to  $+1.0$ . The Flash Compensation values are as follows for  $1/2$  EV and  $1/3$  EV.

Step interval	Flash Compensation
$1/2$ EV	$-2.0, -1.5, -1.0, -0.5, 0.0, +0.5, +1.0$
$1/3$ EV	$-2.0, -1.7, -1.3, -1.0, -0.7, -0.3, 0.0, +0.3, +0.7, +1.0$

\* Set interval of steps in [Expsr Setting Steps] in the [C Custom Setting] menu. (p.143)

Set in [Flash Exp. Comp.] in the [Rec. Mode] menu. (p.98)

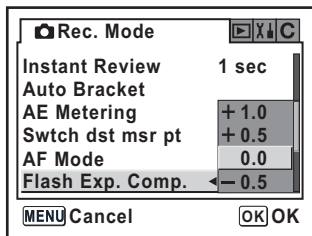

5



- blinks in the viewfinder when the flash pops up during Flash Compensation. (p.20)
- If the maximum flash output is exceeded when corrected to the plus (+) side, no compensation will be effective.
- Compensating to the minus (-) side may not effect the image if the subject is too close, aperture is low or sensitivity is high.

## Allowing Shooting while Charging Flash

You can set to enable shooting while flash is being charged.

Set [2 On] for [Release when Chrging] in the [C Custom Setting] menu (p.101). Pictures cannot be taken while the flash is charging by default.

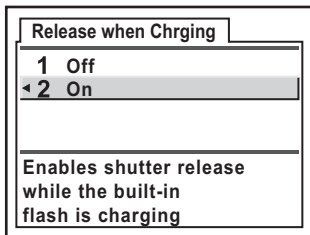

5

Function Reference

## Flash Characteristics in Each Exposure Mode

### Using the Flash in Tv (Shutter Priority) Mode

- When taking a moving subject, you can use the flash to change the blur effect.
- Any desired shutter speed 1/180 sec. or slower can be set for taking a flash photograph.
- The aperture value automatically changes according to the ambient brightness.
- The shutter speed is fixed at 1/180 sec. when lens other than DA, D FA, FA J, FA, F or A is used.

### Using the Flash in Av (Aperture Priority) Mode

- You can set the desired aperture to take a flash photograph when you want to change the depth of field or shoot a subject farther away.
- The shutter speed automatically changes with the ambient brightness.
- The shutter speed shifts automatically anywhere from 1/180 sec. to a slow shutter speed (p.42) that reduces camera shake. The slowest shutter speed depends on the focal length of the lens in use.
- The shutter speed is fixed at 1/180 sec. when lens other than DA, D FA, FA J, FA or F is used.

## Using Slow-Speed-Sync

You can use slow-speed-sync when shooting portraits with the sunset in the background. Both the portrait and the background are captured beautifully.



- Slow-speed-sync slows the shutter speed. Use a tripod to avoid camera shake. The picture will also blur if the subject moves.
- Slow-speed-sync shooting can also be performed with an external flash.

### ● Using Tv (Shutter Priority) Mode

- 1 Set the mode dial to **Tv**.  
**Tv** (Shutter Priority) mode is set.
- 2 Use the e-dial to set the desired shutter speed.  
The background is not properly corrected if aperture value is flashing when shutter speed is set. Set the shutter speed so that aperture does not flash.
- 3 Press the **⚡UP** button.  
The flash pops up.
- 4 Take the picture.

### ● Using M (Manual) Mode

- 1 Set the mode dial to **M**.  
**M** (Manual) mode is set.
- 2 Set the shutter speed (under 1/180 sec.) and aperture value to obtain correct exposure.
- 3 Press the **⚡UP** button.  
The flash pops up.  
In **M** (Manual) mode, pop up the flash at any time.
- 4 Take the picture.

## Distance and Aperture when Using the Built-in Flash

A set criteria is necessary between the guide number, aperture and distance when shooting with the flash.

Calculate and adjust the shooting conditions if flash is not sufficient.

Built-in flash guide number

Sensitivity	Built-in flash guide number
ISO 200	15.6
ISO 400	22
ISO 800	31
ISO 1600	44
ISO 3200	62

5

Function Reference

### Calculating Shooting Distance from Aperture Value

The following equation calculates the distance of the flash for aperture values.

Maximum flash distance  $L1 = \text{Guide number} \div \text{Selected aperture}$

Minimum flash distance  $L2 = \text{Maximum flash distance} \div 5^*$

\* The value 5 used in the formula above is a fixed value which applies only when using the built-in flash alone.

Example

When sensitivity is [ISO 200] and aperture value is F4

$L1 = 15.6 \div 4 = \text{approx. } 3.9 \text{ (m)}$

$L2 = 3.9 \div 5 = \text{approx. } 0.8 \text{ (m)}$

Therefore, the flash can be used in a range of about 0.8 m to 3.9 m.

The flash cannot be used when the distance is less than 0.7 m. When the flash is used at closer than 0.7 m, it causes vignetting in the picture corners, light is distributed unevenly and the picture may be over-exposed.



## Calculating Aperture Value from Shooting Distance

The following equation calculates the aperture value for shooting distances.

Aperture Value Used  $F = \text{Guide number} \div \text{Shooting distance}$

When sensitivity is [ISO 200] and shooting distance is 5.2 m, aperture value is:

$$F = 15.6 \div 5.2 = 3$$

If the resulting number (3, in the above example) is not available as a lens aperture, the smaller number that is closest (2.8, in the above example) is generally used.

## DA, D FA , FA J, FA and F Lens Compatibility with the Built-in Flash

When using DA, D FA, FA J, FA and F lenses with the *\*istDS2* without the hood, built-in flash compatibility is shown below.

Yes : Available

# : Available depending on other factors

No : Unavailable due to vignetting

Following are evaluated without a hood.

Lens Name	Compatibility
F Fish-eye 17-28 mm F3.5-4.5	# Vignetting may occur if focal length is less than 20 mm.
DA16-45 mm F4ED AL	# When the focal length is less than 28 mm or when the focal length is 28 mm and the shooting distance is less than 1 m, vignetting may occur.
FA J18-35 mm F4-5.6AL	# Vignetting may occur if focal length is 18 mm and the shooting distance is less than 1 m.
DA18-55 mm F3.5-5.6AL	Yes
FA20-35 mm F4AL	Yes
FA24-90 mm F3.5-4.5AL (IF)	Yes
FA28-70 mm F4AL	Yes
FA <sup>*</sup> 28-70 mm F2.8AL	# Vignetting may occur if focal length is between 28 and 35 mm and the shooting distance is less than 1 m.
FA J28-80 mm F3.5-5.6	Yes
FA28-80 mm F3.5-5.6	Yes
FA28-90 mm F3.5-5.6	Yes
FA28-105 mm F4-5.6	Yes
FA28-105 mm F4-5.6 (IF)	Yes
FA28-105 mm F3.2-4.5AL (IF)	Yes
FA28-200 mm F3.8-5.6AL (IF)	Yes
FA35-80 mm F4-5.6	Yes
DA50-200 mm F4-5.6ED	Yes
FA70-200 mm F4-5.6	Yes
FA J75-300 mm F4.5-5.8AL	Yes

5

Function Reference

Lens Name	Compatibility
FA★80-200 mm F2.8ED (IF)	Yes
FA80-320 mm F4.5-5.6	Yes
FA80-200 mm F4.7-5.6	Yes
FA100-300 mm F4.7-5.8	Yes
FA★250-600 mm F5.6ED (IF)	No
DA14 mm F2.8ED (IF)	No
FA20 mm F2.8	Yes
FA★24 mm F2AL (IF)	Yes
FA28 mm F2.8AL	Yes
FA31 mm F1.8AL Limited	Yes
FA35 mm F2AL	Yes
DA40 mm F2.8 Limited	Yes
FA43 mm F1.9 Limited	Yes
FA50 mm F1.4	Yes
FA50 mm F1.7	Yes
FA77 mm F1.8 Limited	Yes
FA★85 mm F1.4 (IF)	Yes
FA135 mm F2.8 (IF)	Yes
FA★200 mm F2.8ED (IF)	Yes
FA★300 mm F2.8ED (IF)	No
FA★300 mm F4.5ED (IF)	Yes
FA★400 mm F5.6ED (IF)	Yes
FA★600 mm F4ED (IF)	No
D FA Macro 50 mm F2.8	Yes
D FA Macro 100 mm F2.8	Yes
FA Macro 50 mm F2.8	Yes
FA Macro 100 mm F2.8	Yes
FA Macro 100 mm F3.5	Yes
FA★ Macro 200 mm F4ED (IF)	Yes
FA Soft 28 mm F2.8	# Built-in flash always discharges fully.
FA Soft 85 mm F2.8	# Built-in flash always discharges fully.

## Using an External Flash (Optional)

Using the optional external flash AF360FGZ enables a variety of flash modes, such as P-TTL auto flash mode, high-speed flash sync mode, and wireless mode. See the chart below for details.

(Yes: Available #: Restricted No: Not available)

\* When using an external flash, it is recommended to use the high-precision AF360FGZ, as it is capable of P-TTL auto flash mode.

Flash	Built-in Flash	AF360FGZ	AF500FTZ
Camera Function			
Red-eye reduction flash	Yes	Yes	Yes
Automatic flash discharge	Yes	Yes	Yes
After the flash is charged, the camera automatically switches to the flash sync speed.	Yes	Yes	Yes
Aperture is automatically set in <b>P</b> (Program) mode and <b>Tv</b> (Shutter Priority) mode.	Yes	Yes	Yes
P-TTL auto flash (appropriate sensitivity: 200 to 3200)	Yes* <sup>1</sup>	Yes* <sup>1</sup>	No
TTL auto flash (appropriate sensitivity: 200 to 400)	No	#* <sup>2</sup> * <sup>3</sup>	#* <sup>3</sup>
Slow-speed sync	Yes	Yes	Yes
Flash exposure compensation	Yes	Yes	Yes
AF illuminator	Yes	Yes	Yes
Rear curtain sync flash* <sup>4</sup>	#* <sup>5</sup>	Yes	Yes
Contrast-control-sync flash mode	#* <sup>6</sup>	Yes	Yes
Slave flash	No	Yes	Yes
High-speed flash sync	No	Yes	No
Wireless flash* <sup>7</sup>	No	Yes	Yes

\*<sup>1</sup> When using DA or FA J lens, or D FA, FA or A lens with lens aperture ring set to the A position.

\*<sup>2</sup> When lens aperture ring setting is other than the A position.

\*<sup>3</sup> Image may be underexposed near minimum aperture and overexposed near open aperture in lenses with bright F value.

\*<sup>4</sup> Shutter speed of 1/90 sec. or slower.

\*<sup>5</sup> Can be combined with AF360FGZ for rear curtain sync flash.

\*<sup>6</sup> When combined with the AF360FGZ, 1/3 of the flash discharge can be output by the built-in flash and 2/3 can be output by the external flash.

\*<sup>7</sup> Two or more AF360FGZ units are required.

## About the LCD Panel Display for AF360FGZ

The AF360FGZ will automatically convert the field angle differential between 35 mm format and the *\*istDS2* depending on the focal length of the lens you are using (when using DA, D FA, FA J, FA or F lenses). The conversion indicator appears and the format size indicator disappears when the exposure metering timer of the *\*istDS2* is on (it returns to 35 mm format display when the exposure metering timer is turned off).

Lens focal length	85mm	77mm	50mm	35mm	28mm	24mm	20mm	18mm
AF360FGZ LCD panel	Exposure metering timer Off		85mm	70mm	50mm	35mm	28mm	24mm*
	Exposure metering timer On		58mm	48mm	34mm	24mm	19mm	16mm*

\* Using wide adaptor

## Using P-TTL Auto Mode

Use this flash mode with the AF360FGZ flash unit. When flash mode is set to "P-TTL auto", the flash pre-fires right before taking pictures using 16-segment metering and allows more precise control. P-TTL auto is available in wireless flash mode when two or more AF360FGZ units are used.

- 1 Remove the cover of the hot shoe and attach the AF360FGZ.
- 2 Turn on the AF360FGZ.
- 3 Set the AF360FGZ flash mode to P-TTL auto.
- 4 Confirm that the AF360FGZ is fully charged and then take the picture.



- P-TTL auto is only available with the AF360FGZ flash unit.
- The will light in the viewfinder when the flash is ready (fully charged).
- For details such as operation method and effective distance, please read the external flash manual.
- The flash does not discharge when the subject is bright enough when Flash Mode is or . Therefore, it may not be suitable for daylight-sync shooting.
- Never press the flash pop up button when any external flash unit is attached to the camera. The built-in flash will hit the external flash. If you want to use both at once, see p.158 for the connection method.

## Using High-Speed Flash Sync Mode

With the AF360FGZ, you can discharge the flash to take a picture at a shutter speed faster than 1/180 second. High-speed flash sync can be used with the flash attached to the camera, or wireless.

### Attaching and Using the AF360FGZ on the Camera

- 1 Remove the hot shoe cover and attach the AF360FGZ.
- 2 Turn the mode dial and set the exposure mode to **Tv** or **M**.
- 3 Turn on the AF360FGZ.
- 4 Set the AF360FGZ sync mode to HS  (high-speed flash sync.).
- 5 Confirm that the AF360FGZ is fully charged and then take the picture.



- The  will light in the viewfinder when the flash is ready (fully charged).
- High-speed flash sync is only available when the shutter speed is faster than 1/180 sec.
- High-speed flash sync is not available when the exposure mode is set to **B** (Bulb).

## Using in Wireless Mode

Shoot using the flash without connecting the camera and flash with a cord by using two AF360FGZ units. The High-speed sync mode is also available in wireless mode.



Be sure to set the two AF360FGZ units to the same channel. See the AF360FGZ operating manual for details.

## ● Using in Wireless Mode

- 1 Place the AF360FGZ at the desired location.
- 2 Set the AF360FGZ power switch to [WIRELESS].
- 3 Set the AF360FGZ wireless mode to S (Slave).
- 4 Turn the camera mode dial and set the exposure mode to **P**, **Tv**, **Av** or **M** mode.
- 5 Set the AF360FGZ power switch on the camera to [WIRELESS].
- 6 Set the AF360FGZ wireless mode on the camera to **M** (Master) or **C** (Control).



- Wireless mode is not available for the built-in flash.
- Set the AF360FGZ wireless slave mode to SLAVE1.

### Wireless Flash Control (P-TTL Flash Mode)

The following information is exchanged between the two AF360FGZ flash units before the flash is discharged when the AF360FGZ is used for wireless flash.

Press the shutter release button fully.

- 1 The camera's flash discharges a pre-flash (the camera's flash mode is transmitted).
- 2 The external flash unit discharges a pre-flash (the subject's lighting condition is checked).
- 3 The camera's flash unit discharges a pre-flash (the required flash output is transmitted to the external flash).
  - \* The camera's flash will discharge another pre-flash to transmit the flash duration in HS  $\downarrow$  (High-speed sync).
- 4 The external flash discharges the main flash.



Set the AF360FGZ wireless slave mode to SLAVE1.

## Red-Eye Reduction

As with the built-in flash, red-eye reduction is available with an external flash. This may not be available on some flashes or may have restrictions for usage conditions. See the chart on p.154.



- The red-eye reduction feature works even when only an external flash is used. (p.52)
- If red-eye reduction is used when the AF360FGZ is set as the slave unit or with the wireless function, the preflash for red-eye reduction will trigger the external flash. Do not use red-eye reduction when using a slave unit.

## Rear Curtain Sync Flash

When using the built-in flash with AF360FGZ that is set to the rear curtain flash function, the internal flash will also use this mode. Confirm that both flash units are fully charged before shooting.

## Using the Built-in Flash with the External Flash

As shown in the figure below, attach the hot shoe adapter F<sub>C</sub> (optional) to the camera hot shoe and an off-camera shoe adapter F (optional) to the bottom of the external flash, and connect these with the extension cord F5P (optional). The off camera shoe adapter F comes with a tripod screw for securing to your tripod.

Only the P-TTL auto flash can be used in combination with the built-in flash.

When combining with the built-in flash

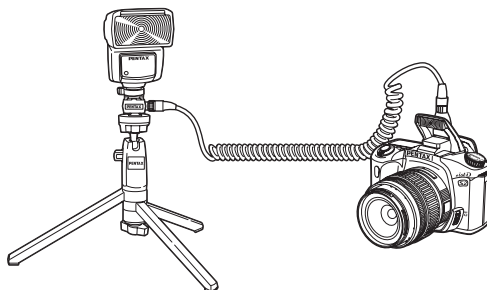



## Discharging Multiple Flashes

You can combine two or more AF360FGZ external flashes or you can use two or more AF360FGZ external flashes in combination with the built-in flash. Connect them as shown in the figure below: Attach an off-camera shoe adapter F (optional) to the external flash and the hot shoe adapter F (optional) and connect the extension cord F5P (optional) to the off-camera shoe adapter F on the other external flash.



- Do not combine with accessories that have a different number of contacts such as a Hot Shoe Grip. A malfunction may occur.
- Combining with flashes from other manufacturers may cause equipment breakdown. We recommend using the AF360FGZ.

When combining two or more external flashes

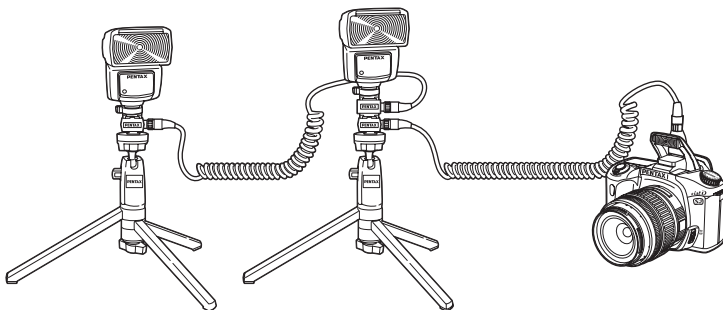

When using multiple AF360FGZ units or an AF360FGZ unit with the built-in flash, P-TTL is used for flash control.

## Contrast-Control-Synch Flash

Combining two or more AF360FGZ or using AF360FGZ in combination with the built-in flash allows twin flash photography (contrast-control-synch flash photography). This is based on the difference between the amounts of light discharged from two units.



- Do not combine with accessories that have a different number of contacts such as a Hot Shoe Grip as a malfunction may occur.
- Combining with flashes from other manufacturers may cause equipment breakdown. We recommend using the PENTAX dedicated automatic flashes.

- 1 Connect the external flash to the camera indirectly. (p.158)
- 2 Set the sync mode for AF360FGZ to the Contrast-Control-Synch mode.
- 3 Turn the mode dial and set the exposure mode to **P**, **Tv**, **Av** or **M**.
- 4 Confirm that both the external flash and built-in flash are fully charged and then take the picture.



- When using two or more external flashes and the Contrast-Control-Synch mode is set on the external master flash unit, the flash output ratio is 2 (master unit) : 1 (slave units). When external flash is used in combination with the built-in flash, the flash output ratio is 2 (external flash) : 1 (built-in flash).
- When using two AF360FGZ units or an AF360FGZ unit with the built-in flash, P-TTL is used for flash control.
- The fastest flash synchronization speed is 1/90 second in the Contrast-Control-Synch mode.

## Changing Playback Display Method

Set information to show during playback.

The camera switches display information when you press **INFO** button.

Images only	Only captured images are displayed.
Image+Histgrm	Images and histogram are displayed.
Image+Detailed Info	Image details appear with a small image in the upper left.
Last memory	Display settings are retained from previous session.

Set in [Plybk dsply mthd] in the [▶ Playback] menu. (p.98)

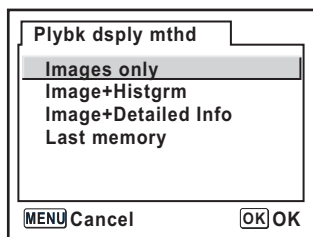

Refer to p.18 for various display information details.

## Displaying Bright Portion Warning

If [Instant Review] or [Instnt review+Plybck] in [Bright Portion] is selected, bright areas (over exposed areas) in the image blink on the Instant Review and playback screens.

The default setting is [OFF].

OFF	Turn off the bright portion warning.
Instant Review	Over exposed area warning is displayed only during Instant Review.
Instnt review+Plybck	Over exposed area warning is displayed during Instant Review and playback.

Set in [Bright Portion] in the [▶ Playback] menu. (p.98)

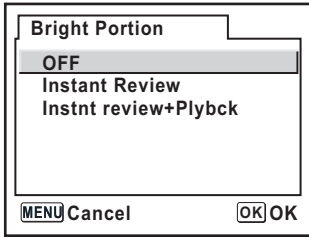

## Setting the Slideshow Display Interval

You can play back all images recorded on your SD Memory Card successively. (p.68)

Set image display interval to [3 sec], [5 sec], [10 sec] or [30 sec]. The default setting is [3 sec].

Set in [Slideshow] in the [▶ Playback] menu (p.98).

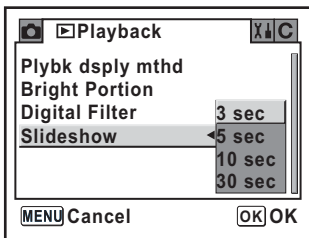

After setting, press the **OK** button to start slideshow.

## Formatting the SD Memory Card

Be sure to format new SD Memory Card with the camera before using the card.

Formatting will delete all the data on the SD Memory Card.



- Do not open the card cover while formatting SD Memory Card. The card may be damaged beyond use.
- Formatting will delete protected data. Be aware.

**1** Select **[Format]** on the **[X↓ Set-up]** menu (p.99).

**2** Press the four-way controller (▶) to display the **Format** screen.

**3** Use the four-way controller (▲) to select **[Format]**.

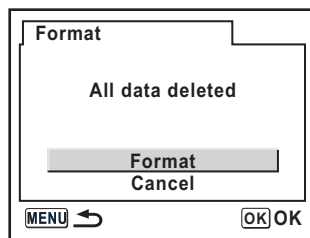

**4** Press the **OK** button.

Formatting starts. When formatting is completed, the camera is ready to take pictures.

## Turning the Beep On and Off

You can turn the camera operation beep on or off. The default setting is [On].

Set in [Beep] in the [X Set-up] menu. (p.99)

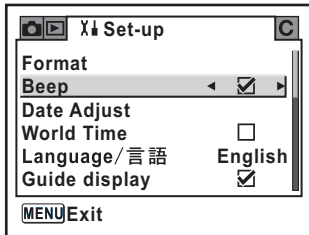

### 5

## Changing the Date and Time and the Display Style

You can change the initial date and time settings. You can also set the display style. Choose [mm/dd/yy], [dd/mm/yy] or [yy/mm/dd]. Choose [12h (12 hour)] or [24h (24 hour)] for time display method.

☞ Setting the Date and Time (p.35)

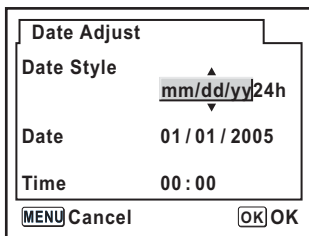

## Setting the World Time

The date and time selected in “Initial Settings” (p.33) serve as the date and time of your present location.

Setting [World Time] enables you to display the local date and time on the LCD monitor when traveling overseas.

### 1 Select [World Time] on the [X] Set-up] menu. (p.99)

### 2 Press the four-way controller (▶).

The World Time screen appears.

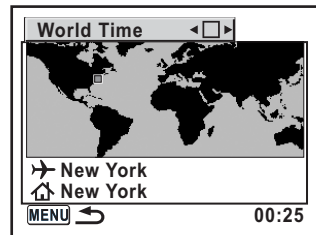

### 3 Use the four-way controller (◀▶) to select (On) or (Off).

<input checked="" type="checkbox"/>	Applies time of city set in ✈ (Destination)
<input type="checkbox"/>	Applies time of city set in 🏠 (Hometown)

### 4 Press the four-way controller (▼).

The selection frame moves to ✈. The city with ✈ blinks.

### 5 Press the four-way controller (▶).

The screen for magnifying the Destination region appears.

Use the four-way controller (◀▶) to change the region to magnify.

### 6 Press the four-way controller (▼).

The frame moves to city.

## 7 Use the four-way controller (◀▶) to select the Destination city.

The current time, location and time difference of the selected city appears.

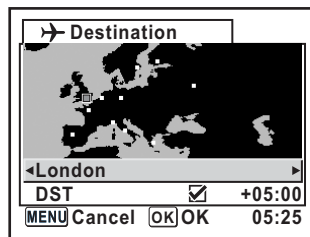

## 8 Use the four-way controller (▼) to select [DST].

## 9 Use the four-way controller (◀▶) to select (On) or (Off).

Select  (On) if the Destination city uses daylight saving time (DST).

## 10 Press the OK button.

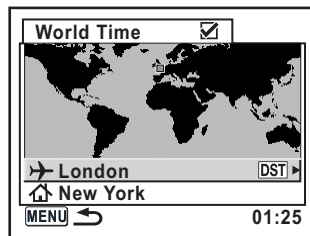

The World Time setting is saved.  
To continue with World Time setting operations, press the **OK** button to return to the World Time screen.



## 11 Press the MENU button twice.

The camera is ready to take pictures.



- See “List of World Time Cities” (p.167) for cities that can be specified as a destination.
- Select  in Step 4 to set the city and DST setting.
-  appears on the guide display screen if World Time is On () . (p.16)



## List of World Time Cities

Region	City	Region	City
North America	Honolulu	Africa/ West Asia	Nairobi
	Anchorage		Jeddah
	Vancouver		Tehran
	San Francisco		Dubai
	Los Angeles		Karachi
	Calgary		Kabul
	Denver		Male
	Chicago		Delhi
	Miami		Colombo
	Toronto		Katmandu
	New York		Dacca
	Halifax		
Central and South America	Mexico City	East Asia	Yangon
	Lima		Bangkok
	Santiago		Kuala Lumpur
	Caracas		Vientiane
	Buenos Aires		Singapore
	Sao Paulo		Phnom Penh
	Rio de Janeiro		Ho chi Minh
			Jakarta
Europe	Madrid		Hong Kong
	London		Beijing
	Paris		Shanghai
	Amsterdam		Manila
	Milan		Taipei
	Rome		Seoul
	Berlin		Tokyo
	Stockholm		Guam
	Athens		
	Helsinki	Oceania	Perth
	Moscow		Adelaide
			Sydney
Africa/ West Asia	Dakar		Noumea
	Algiers		Wellington
	Johannesburg		Auckland
	Istanbul	Pago Pago	
	Cairo		
	Jerusalem		

## Setting the Display Language

You can change the language in which the menus, error messages, etc. are displayed.

Set in [Language/言語] in the [**X**↓ Set-up] menu. (p.99)

You can choose from eleven languages: English, French, German, Spanish, Italian, Swedish, Dutch, Russian, Korean, Chinese (Traditional/Simplified) and Japanese.

☞ Setting the Display Language (p.33)



## Turning the Guide Display On and Off

Set to display guides on the LCD monitor when main switch is on or Exposure mode is changed. (p.16)

<input checked="" type="checkbox"/>	Guide display on
<input type="checkbox"/>	Guide display off

Set in [Guide display] in the [**X**↓ Set-up] menu. (p.99)

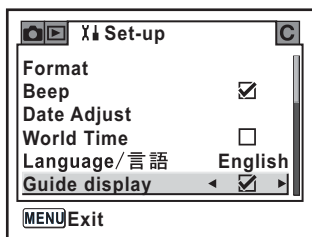

## Adjusting the Brightness of the LCD Monitor

You can adjust the brightness of the LCD monitor. Adjust settings when the LCD monitor is hard to see.

Set in [Brightness Level] in the [**X** Set-up] menu. (p.99)

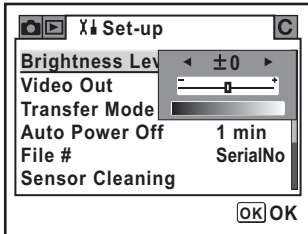

## Selecting the Video Output Format

When you connect the camera to AV equipment such as a TV, choose the appropriate video output format (NTSC or PAL) for playing back images. Set in [Video Out] in the [**X** Set-up] menu. (p.99)

☞ Connecting the Camera to AV Equipment (p.70)

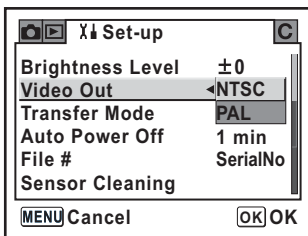

The video output format varies according to region. The video output format used in North America is NTSC.

## Setting Auto Power Off

You can set the camera to turn off automatically if unused after a certain length of time. Select from [1 min], [3 min], [5 min], [10 min], [30 min] or [Off]. The default setting is [1 min].

Set in [Auto Power Off] in the [**X** Set-up] menu. (p.99)

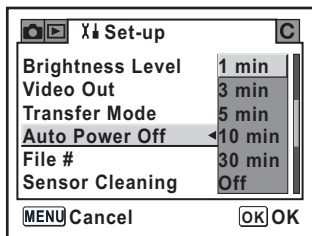

Auto Power Off will not work during slideshow playback, a USB connection, remote control shooting or while displaying menu or Fn menu.

5

Function Reference

## Resetting the File Number

You can set the File Number used for the images when inserting a new SD Memory Card. The default setting is [SerialNo].

SerialNo	The file number for the most recently captured image is placed in memory and the file number will remain continuous after inserting the new SD Memory Card.
Reset	Every time a new SD Memory Card is inserted, the file number is the smallest number. When an SD Memory Card with stored images is inserted, numbering continues from the last stored file number.

Set in [File #] in the [**X** Set-up] menu. (p.99)

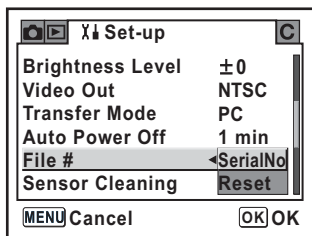

## Setting the Instant Review

### Setting the Display Time

Select from [1 sec], [3 sec], [5 sec] or [Off]. The default setting is [1 sec]. Set in [Instant Review] in the [📷 Rec. Mode] menu. (p.98)

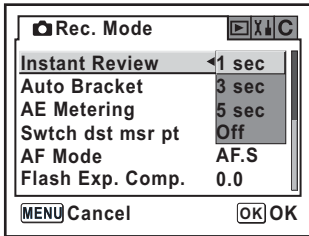

### Displaying Histogram During Instant Review

Set to display histogram during Instant Review. Select [2 Plybck with Hstgram] in [Instant Review Dsply] in the [C Custom Setting] menu. (p.100) The default setting is to not display histogram.

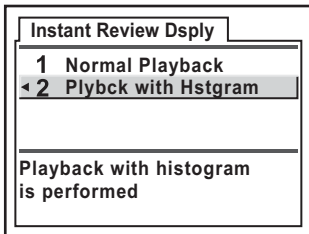

## Resetting Rec. Mode/Playback/Set-up Menu

Settings in [📷 Rec. Mode] menu, [▶ Playback] menu and [X↓ Set-up] menu are reset to default settings.

However, Date Adjust, Language, Video Out and World Time are not reset.

- 1 Select [Reset] on the [X↓ Set-up] menu.
- 2 Press the four-way controller (▶) to display the [Reset] screen.
- 3 Use the four-way controller (▲) to select [Reset].

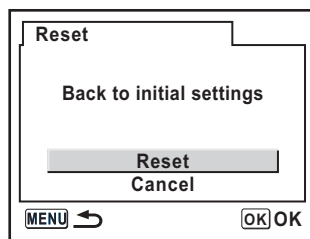

- 4 Press the OK button.

The camera is ready to take or play back images.

## Resetting the Custom Function Menu

Reset settings in [C Custom Setting] menu to default settings. Settings in [Rec. Mode] menu, [Playback] menu and [Set-up] menu are not reset.

- 1 Select [Reset] on the [C Custom Setting] menu.
- 2 Press the four-way controller (▶) and display the Reset Custom Fncn screen.
- 3 Use the four-way controller (▲) to select [Reset].

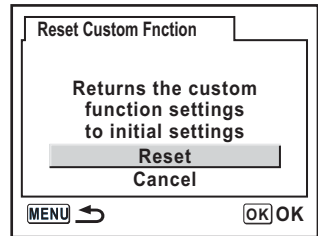

- 4 Press the OK button.

The camera is ready to take or play back images.





# 6 Appendix

---

<b>Default Settings .....</b>	<b>176</b>
<b>Functions Available with Various Lens Combinations .....</b>	<b>180</b>
<b>Notes on [Using Aperture Ring] .....</b>	<b>182</b>
<b>Cleaning the CCD .....</b>	<b>183</b>
<b>Optional Accessories .....</b>	<b>185</b>
<b>Error Messages .....</b>	<b>188</b>
<b>Troubleshooting .....</b>	<b>190</b>
<b>Main Specifications .....</b>	<b>192</b>
<b>Glossary .....</b>	<b>196</b>
<b>Index .....</b>	<b>200</b>
<b>WARRANTY POLICY .....</b>	<b>204</b>

# Default Settings

The table below lists the factory default settings.

Table notations are as follows.

## Last Memory Setting

Yes : The current setting (last memory) is saved when the camera is turned off.







No : The setting returns to the default setting when the camera is turned off.

## Reset Setting

Yes : The setting returns to the default setting with the reset function (p.172).

No : The setting is saved even after reset.

## [📷 Rec. Mode] Menu

Item	Default Setting	Last Memory Setting	Reset Setting	Page
Image Tone	 (Bright)	Yes	Yes	p.108
Recorded Pixels	 (3008×2000)	Yes	Yes	p.109
Quality Level	★★★ (Best)	Yes	Yes	p.110
Saturation	 (0)	Yes	Yes	p.111
Sharpness	 (0)	Yes	Yes	p.111
Contrast	 (0)	Yes	Yes	p.111
Instant Review	1sec	Yes	Yes	p.171
Auto Bracket	±0.5/0 – +	Yes	Yes	p.146
AE Metering	 (Multi-segment)	Yes	Yes	p.131
Switch dst msr pt	 (Auto)	Yes	Yes	p.122
AF Mode	<b>AFS</b> (Single mode)	Yes	Yes	p.121
Flash Exp. Comp.	0.0	Yes	Yes	p.147

## [▶ Playback] Menu

Item	Default Setting	Last Memory Setting	Reset Setting	Page
Plybk dsply mthd	Images only	Yes	Yes	p.161
Bright Portion	OFF	Yes	Yes	p.161
Digital Filter	B&W	Yes*	Yes	p.71
Slideshow	3sec	Yes	Yes	p.68

\* Only the slimness and softness settings for the slim filter and soft filter are saved.

## [X] Set-up] Menu

Item		Default Setting	Last Memory Setting	Reset Setting	Page
Format		—	—	—	p.163
Beep		<input checked="" type="checkbox"/> (On)	Yes	Yes	p.164
Date Adjust		According to default setting	Yes	No	p.164
World Time	World Time setting	<input type="checkbox"/> (Off)	Yes	Yes	p.165
	Hometown (City)	According to default setting	Yes	No	
	Hometown (DST)	According to default setting	Yes	No	
	Destination (City)	Same as Hometown	Yes	No	
	Destination (DST)	Same as Hometown	Yes	No	
Language/言語		According to default setting	Yes	No	p.168
Guide display		<input checked="" type="checkbox"/> (On)	Yes	Yes	p.168
Brightness Level		0	Yes	Yes	p.169
Video Out		According to default setting	Yes	No	p.169
Transfer Mode		PC	Yes	Yes	p.84
Auto Power Off		1min	Yes	Yes	p.170
File #		SerialNo	Yes	Yes	p.170
Sensor Cleaning		—	—	—	p.183
Reset		—	—	—	p.172

**[C Custom Setting] Menu**

Item	Default Setting	Last Memory Setting	Reset Setting	Page
Setting	□ (Off)	Yes	Yes	p.100
Noise Reduction	On	Yes	Yes	p.141
Exprs Setting Steps	1/2 EV Steps	Yes	Yes	p.143
ISO Corction in AUTO	ISO 200-800	Yes	Yes	p.115
ISO Snstvty Wrn Dspl	Off	Yes	Yes	p.116
Link AF Point and AE	Off	Yes	Yes	p.132
Meter Operating Time	10sec	Yes	Yes	p.133
AE-L with AF locked	Off	Yes	Yes	p.125
Recordable Image No.	Remaining image storage capacity	Yes	Yes	p.100
OK btn when shooting	Off	Yes	Yes	p.120, p.122
AE-L btnn on M exprs	Program Line	Yes	Yes	p.141
Superimpose AF Area	On	Yes	Yes	p.122
AF in remote control	Off	Yes	Yes	p.100
FI with S lens used	Not available	Yes	Yes	p.101
Using aperture ring	Prohibited	Yes	Yes	p.182
Release when Chrging	Off	Yes	Yes	p.148
Instant Review Dsply	Normal Playback	Yes	Yes	p.171
Mag to Strt Zm Plybk	1.2times	Yes	Yes	p.101
Man. WB Measurement	Entire screen	Yes	Yes	p.113
Color Space	sRGB	Yes	Yes	p.117
Reset Custom Fncion*	—	—	—	p.173

\* Reset settings in [C Custom Setting] menu.

## Fn Menu

Item	Default Setting	Last Memory Setting	Reset Setting	Page
Drive Mode	<input type="checkbox"/> (Single frame shooting)	No <sup>*1</sup>	Yes	p.53, p.55, p.59, p.144
Flash Mode	 (Auto)	Yes	Yes	p.49
White Balance	<b>AWB</b> (Auto)	Yes	Yes	p.112
ISO Sensitivity	AUTO	Yes	Yes	p.115
DPOF Settings	—	Yes	No	p.79
Digital Filter	B&W	Yes <sup>*2</sup>	Yes	p.71
Slideshow	3sec	Yes	Yes	p.68

\*1 Only continuous shooting settings are saved.

\*2 Only slimness and softness settings for the slim filter and soft filter are saved.

# Functions Available with Various Lens Combinations

## Lenses that can be used with this camera

Only DA and FA J lenses and D FA/FA/F/A lenses having an **A** position on the aperture ring can be used with this camera. Refer to “Notes on [Using Aperture Ring]” (p.182) for other lenses and D FA/FA/F/A lenses with aperture ring set to a position other than **A**.

Function \ Lens [Mount type]	DA/D FA/ FA J/FA lens [KAF, KAF2] <sup>*3</sup>	F lens [KAF] <sup>*3</sup>	A lens [KA]
Autofocus (Lens only) (With AF adapter 1.7×) <sup>*1</sup>	Yes —	Yes —	— Yes
Manual focus (With the focus indicator) <sup>*2</sup> (With Matte field)	Yes Yes	Yes Yes	Yes Yes
Eleven focus points	Yes	Yes	No
Power zoom	No	—	—
Aperture Priority Auto Exposure	Yes	Yes	Yes
Shutter Priority Automatic Exposure	Yes	Yes	Yes
Manual Exposure	Yes	Yes	Yes
P-TTL Auto Flash <sup>*4</sup>	Yes	Yes	Yes
Multi (16-segment) metering	Yes	Yes	Yes

Yes : Functions are available when the aperture ring is set to the **A** position.

No : Functions are unavailable.

\*1 Lenses with a maximum aperture of f/2.8 or brighter. Only available at **A** position.

\*2 Lenses with a maximum aperture of f/5.6 or brighter.

\*3 To use an F/FA soft 85 mm f/2.8 lens or FA soft 28 mm f/2.8 lens, set [Using aperture ring] to [2 Permitted] in the [C Custom Setting] menu (p.100). Pictures can be taken with the aperture you set, but only within manual aperture range.

\*4 When using the built-in flash and AF360FGZ.

## Lens names and mount names

FA prime lenses (non-zoom lenses) and DA, D FA, FA J and F lenses use the KAF mount. Of the FA zoom lenses, power zoom enabled lenses use the KAF2 mount. Lenses without power zoom use the KAF mount. See the lens manual for details. This camera does not have a power zoom function.

## Lenses and accessories that cannot be used with this camera

When aperture ring is set at other than **A** (Auto) or a lens without a **A** (Auto) position or accessories such as an auto extension tube or auto bellows are used, camera does not operate unless [Using aperture ring] is set to [2 Permitted] in the [**C** Custom Setting] menu (p.101). Refer to “Notes on [Using Aperture Ring]” (p.182) for restriction that apply when [Using aperture ring] is set to [2 Permitted] in the [**C** Custom Setting] menu.

All camera exposure modes are available when using DA/FA J or lenses with Aperture **A** (Auto) position set to that position.

## Lens and Built-in Flash

The built-in flash cannot be regulated and fully fires when pre A lenses or soft lenses are used.

Note that the built-in flash cannot be used as the Auto Flash.

## Aperture Ring Use

When [Using aperture ring] is set to [2 Permitted] in [C Custom Setting] menu (p.101), the shutter can be released even if the aperture ring of the D FA, FA, F or A lens is not set to the **A** position or a lens without a **A** position is attached. However, the features will be restricted as shown in the table below.



The camera operates in **Av** (Aperture Priority) mode even if the mode dial is at **P** or **Tv** when the aperture is set to a value other than **A**.

Lens used	Exposure mode	Restriction
D FA, FA, F, A, M (lens only or with auto diaphragm accessories such as auto extension tube K)	<b>Av</b> (Aperture Priority) mode	The aperture remains open regardless of the aperture ring position. The shutter speed changes in relation to the open aperture but an exposure error may occur. In the viewfinder, [F--] appears for the aperture indicator.
D FA, FA, F, A, M, S (with diaphragm accessories such as extension tube K)	<b>Av</b> (Aperture Priority) mode	Pictures can be taken with the specified aperture value but an exposure error may occur. In the viewfinder, [F--] appears for the aperture indicator.
Manual diaphragm lens such as reflex lens (lens only)	<b>Av</b> (Aperture Priority) mode	
FA, F Soft 85mm FA Soft 28mm (lens only)	<b>Av</b> (Aperture Priority) mode	Pictures can be taken with the specified aperture value in the manual aperture range. In the viewfinder, [F--] appears for the aperture indicator. When depth of field is checked (Preview), AE Metering is switched on. Exposure check is possible.
All lenses	<b>M</b> (Manual) mode	Pictures can be taken with the set aperture value and shutter speed. In the viewfinder, [F--] appears for the aperture indicator. When depth of field is checked (Preview), AE Metering is switched on. Exposure check is possible.



Shadows may appear in the image for white backgrounds and other shooting conditions if the CCD becomes dirty or dusty. This indicates that the CCD must be cleaned. Please contact PENTAX service center for professional cleaning because the CCD is a precision part.



- Do not use a spray type blower.
- Do not clean the CCD when the exposure mode is set to **B** (Bulb) mode.
- Always cap the lens mount area to prevent dirt and dust from accumulating on the CCD when no lens is on the camera.
- It is recommended to use the AC adapter when cleaning the CCD.
- When the battery level is low, [Not enough battery remaining to clean sensor] is displayed on the LCD monitor.
- If you are not using the AC adapter, please use batteries with ample capacity remaining. A warning beep will sound if the battery capacity becomes low during cleaning. Please stop cleaning immediately.
- Do not put the tip of the blower inside the lens mount area. If the power is turned off, this could cause damage to the shutter or the CCD sensor.



- Use of the AC adapter (optional) is recommended.
- The self-timer lamp blinks and [Cln] appears on the LCD panel while cleaning the CCD.

- 1 Turn the camera off and remove the lens.**
- 2 Turn the camera on.**
- 3 Select [Sensor Cleaning] on the [X↓ Set-up] menu.**
- 4 Press the four-way controller (▶).**

The Sensor Cleaning screen appears.

- 5** Use the four-way controller (▲) to select [Mirror Up].

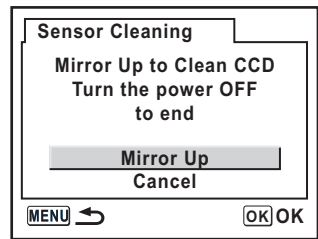

- 6** Press the OK button.

The mirror is locked in the up position.

- 7** Clean the CCD.

Use a brush-less blower to remove dirt and dust from the CCD. Using a blower with a brush may scratch the CCD. Do not wipe the CCD with a cloth.

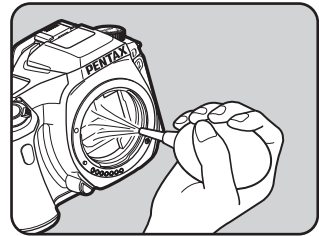

- 8** Turn the camera off.

- 9** Attach the lens after the mirror returns to its original position.

A number of dedicated accessories are available for this camera. Please contact a service center for details regarding accessories.

---

## AC Adapter D-AC10

This AC adapter supplies power from the outlet into your camera.

---

## Cable Switch CS-205

This is a remote shutter release cord. The cord length is 0.5 m.

---

## Remote Control F

Shoot pictures from within 5 m of the front of the camera.

---

## Flash Accessories

### Auto Flash AF360FGZ

This is an auto flash unit with a maximum guide number of 36 (ISO 100/ m). Its features include slave-sync flash, contrast-control-sync flash, AF spot beam, high-speed sync, wireless flash and front/rear curtain-sync.

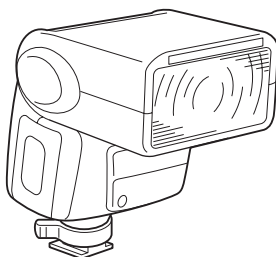

**Off-camera Shoe Clip CL-10**

This is a setting clip for using the AF360FGZ as a wireless slave flash.

**Hot Shoe Adapter F<sub>6</sub>****Extension Cord F5P****Off-camera Shoe Adapter F**

Use the adapters and cords to use the external flash away from the camera.

**For Viewfinder****Magnifier FB**

This viewfinder accessory is for magnifying the central area of the viewfinder.

**Ref-converter A**

This is an accessory that changes the viewfinder viewing angle at 90° intervals. The viewfinder magnification can be switched between 1× and 2×.

**Diopter correction lens adapter M**

This accessory adjusts the diopter. Install it on the viewfinder.

If it is difficult to see the viewfinder image clearly, choose one of the eight correction lens adapter M of  $-5$  to  $+3$  m<sup>-1</sup> (per meter).

**Interchangeable Focusing Screen**

LF-60 : AF Framed Matte (standard)

LL-60 : AF Divided Matte

LI-60 : AF Scale Matte

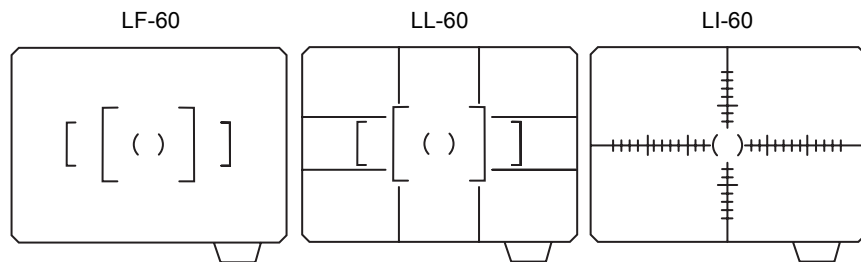

## Camera Case

### Camera Case O-CC34

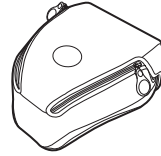

## Others

The accessories below are the same as the accessories that are packaged with the camera.

### ME viewfinder cap



### Eyecup FL



### Strap O-ST10

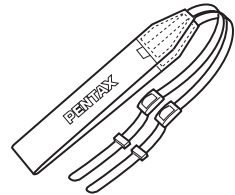





Error Message	Description
Memory card full	The SD Memory Card is full and no more images can be saved. Insert a new SD Memory Card or delete unwanted images. (p.29, p.73) You may be able to save new images by changing the quality level or recorded pixels. (p.109, p.110)
No image	There are no images for playback on the SD Memory Card.
Camera cannot display this image	You are trying to play back an image in a format not supported by this camera. You may be able to play it back on another brand of camera or your computer.
No card in camera	The SD Memory Card is not inserted in the camera. (p.29)
Memory card error	The SD Memory Card has a problem, and image capture and playback are impossible. It may be viewable on a PC but not the camera.
Card not formatted	The SD Memory Card you have inserted is unformatted or has been formatted on a computer or other device and is not compatible with this camera. Use after formatting with the camera. (p.163)
Card locked	
Card is locked Rotation information cannot be saved	A locked SD Memory Card is inserted in the camera. Unlock the SD Memory Card. (p.30)
This image is protected Rotation information cannot be saved	The selected rotated image is protected. Remove protection from the image. (p.77)
Cannot use this card	The inserted card cannot be used on a camera. Insert a usable card.
Battery depleted	The batteries are exhausted. Install new batteries in the camera. (p.25)
Not enough battery remaining to clean sensor	Appears during CCD cleaning if battery set level is insufficient. Replace the battery set with a new one or use an AC adaptor (optional). (p.28)

Error Message	Description
Image folder could not be created	The maximum folder number (999) and file number (9999) are being used, and no more images can be saved. Insert a new SD Memory Card or format the card. (p.163)
The image is not stored	The image could not be saved because of an SD Memory Card error.
Settings not stored	The DPOF settings file could not be saved because SD Memory Card is full. Delete unwanted images and set DPOF again. (p.73)
RAW images cannot be set	DPOF cannot be applied to the RAW images.
RAW images are not supported	RAW images cannot be processed using the digital filter.
No image to be filtered	When digital filter is started from [▶ Playback] menu, this message appears if all saved images are RAW files or images captured with other cameras.
This image cannot be filtered	Appears when digital filter is started from Fn menu for images captured with other cameras.
No DPOF files	No file set with DPOF. Set DPOF and print. (p.79)
Printer error	There is an error with the printer and the file cannot be printed. Fix error and print.
No paper in a printer	Printer has run out of paper. Put paper in printer and print.
No ink in a printer	Printer has run out of ink. Replace ink and print.
Paper stuck in a printer	Paper is jammed in printer. Remove paper and print.
Data error	A data error has occurred during printing.

We recommend checking the following items before contacting a service center.

Problem	Cause	Remedy
Camera does not turn on	Batteries are not installed	Check if batteries are installed. If not, install batteries.
	Batteries are not installed properly	Check orientation of batteries. Re-insert batteries according to the ⊕ ⊖ symbols. (p.25)
	Battery power is low	Replace with a charged battery set or use the AC adapter. (p.28)
The shutter does not release	The lens aperture ring setting is other than the <b>A</b> position	Set the lens aperture ring to the <b>A</b> position (p.134) or select [2 Permitted] in [Using aperture ring] in the [ <b>C</b> Custom Setting] menu (p.182).
	Flash is charging	Wait until charging is finished.
	No available space on SD Memory Card	Insert SD Memory Card with available space or delete unwanted images. (p.29, p.73)
	Recording	Wait until recording is finished.
The Autofocus does not work	Subject is difficult to focus on	Autofocus cannot focus well on subjects that have low contrast (the sky, white walls), dark colors, intricate designs, are moving quickly or scenery shot through a window or a net-like pattern. Lock focus on another object located at same distance (press shutter release button halfway), then aim at target and press shutter release button fully. Alternatively, use manual focus. (p.126)
	Subject is not in focusing area	Position subject in focus frame in middle of viewfinder. If the subject is outside the focusing area, aim the camera at the subject and lock the focus (press shutter release button halfway), then compose picture and press the shutter release button fully.
	Subject is too close	Move away from the subject and take a picture.



Problem	Cause	Remedy
The Autofocus does not work	The focus mode is set to <b>MF</b>	Set the focus mode lever to <b>AF</b> . (p.118)
	The focus mode is set to <b>A.F.C</b> (Continuous mode)	Set the focus mode to <b>A.F.S</b> (Single mode). (p.121)
	The capture mode is set to  (Moving Object) mode	Set the capture mode to setting other than  (Moving Object) mode. (p.47)
AE lock function does not operate	AE lock is not available when set to <b>M</b> (Manual) mode or <b>B</b> (Bulb) mode	Use AE lock with any setting other than <b>M</b> (Manual) mode or <b>B</b> (Bulb) mode.
Built-in Flash does not discharge	When flash mode is set to [Auto discharge] or [Auto flash+Redeye reduct], the flash will not discharge if the subject is bright	Set flash mode to [Manual discharge] or [Manl flash+Redeye reduct]. (p.49)
	Mode dial is set to  (Flash OFF)	Set mode dial to any setting other than  (Flash OFF). (p.47)
The power zoom system does not function	The camera does not have the power zoom function	Use manual zoom. (p.48)
USB connection with computer does not work properly*	The transfer mode is set to [PictBridge]	Set transfer mode to [PC].
	An error occurred while sending USB data	Change the transfer mode to [PC-F].
USB connection with printer does not work properly	The transfer mode is set to [PC] or [PC-F]	Set transfer mode to [PictBridge]. (p.84)

In rare cases, the camera may not operate correctly due to static electricity. This can be remedied by taking the batteries out and putting them back in again. When the mirror remains in the up position, take the batteries out and put them back in again. Then, turn the power on. The mirror will retract. After the procedure is done, if the camera operates correctly, it does not require any repairs.

\* Refer to p.13 of the "PENTAX PHOTO Browser 2.1/PENTAX PHOTO Laboratory 2.1 Operating Manual" for details on connecting the camera to a PC.









# Main Specifications

Type	TTL autofocus, auto-exposure SLR digital-still camera with built-in retractable P-TTL flash
Effective Pixels	6.10 megapixels
Sensor	Total pixels 6.31 megapixels, interline/interlace scan CCD with a primary color filter
Recorded Pixels	<b>6M</b> (RAW: 3008×2008/JPEG: 3008×2000 pixels), <b>4M</b> (2400×1600 pixels), <b>1.5M</b> (1536×1024 pixels)
Sensitivity	Auto, Manual (200/400/800/1600/3200: Standard Output Sensitivity)
File Format	RAW, JPEG (Exif2.21), DCF compliant, DPOF compatible, Print Image Matching III compatible
Quality Level	<b>RAW</b> , ★★★ (Best), ★★ (Better), and ★ (Good)
Storage Medium	SD Memory Card



## Number of Shots

Size	Quality Level	Capacity			
		1 GB	512 MB	256 MB	128 MB
<b>6M</b> 3008×2008	<b>RAW</b>	Approx. 90	Approx. 46	Approx. 22	Approx. 11
	★★★	Approx. 330	Approx. 167	Approx. 78	Approx. 34
<b>6M</b> 3008×2000	★★	Approx. 607	Approx. 311	Approx. 149	Approx. 70
	★	Approx. 966	Approx. 498	Approx. 242	Approx. 117
	★★★	Approx. 459	Approx. 234	Approx. 111	Approx. 51
<b>4M</b> 2400×1600	★★	Approx. 807	Approx. 415	Approx. 201	Approx. 96
	★	Approx. 1397	Approx. 674	Approx. 330	Approx. 161
	★★★	Approx. 880	Approx. 453	Approx. 220	Approx. 106
<b>1.5M</b> 1536×1024	★★	Approx. 1397	Approx. 722	Approx. 354	Approx. 173
	★	Approx. 2151	Approx. 1115	Approx. 549	Approx. 271

Compression: ★★★ (Best) = 1/3, ★★ (Better) = 1/6, ★ (Good) = 1/12

White Balance	Auto, Daylight, Shade, Cloudy, Fluorescent Light (D: Daylight, N: Neutral White, W: White), Tungsten Light, Flash, Manual
LCD Monitor	2.5 inch low-temperature poly-silicon TFT color LCD with approx. 210000 pixels (with backlight)
Playback Function	Single frame, nine-image display, zoom display (up to 12 times, scrolling possible), rotating, slideshow, histogram, bright portion
Digital Filter	B&W, Sepia, Soft, Slim (only for processing after shooting)
Exposure Mode	<b>P</b> Program, <b>Tv</b> Shutter priority, <b>Av</b> Aperture priority, <b>M</b> Manual, <b>B</b> Bulb Picture mode  Auto Picture,  Normal,  Portrait,  Landscape,  Macro,  Moving Object,  Night Scene Portrait,  Flash OFF

Shutter	Electronically controlled vertical-run focal-plane shutter, Speed range (1) Auto 1/4000 to 30 sec. (stepless), (2) Manual 1/4000 to 30 sec. [1/2 EV step or 1/3 EV step] (3) Bulb, Electromagnetic release, Shutter lock by setting Main switch in OFF position.
Lens Mount	Pentax KAF bayonet mount (K-mount with AF coupler, lens information contacts)
Lens Used	Pentax KAF2 (not power zoom compatible), KAF mount lenses, KA mount lenses
Autofocus System	TTL phase-matching autofocus system (SAFOX VIII), AF operational brightness range: EV -1 to 18 (at ISO 100 with f/1.4 lens), Focus lock available, Focus Mode: <b>A.F.S</b> (Single)/ <b>A.F.C</b> (Continuous)/ <b>MF</b> , Adjustable focus point
Viewfinder	Penta-prism viewfinder, Natural-Bright-Matte focusing screen, Field of view: 95%, Magnification 0.95× (with 50 mm f/1.4 lens at ∞), Diopter: -2.5m <sup>-1</sup> to +1.5m <sup>-1</sup> (per meter)
Viewfinder Indication	Focus information: ● is lit when in-focus and blinking when unable to focus, ⚡ is lit=Built-in flash ready, Blinking=Flash should be used, Shutter speed, Aperture value, e-dial enabled indicator, Focus point, ✳=AE lock, Capacity remaining and ☒=Exposure compensation, ☐=Manual white balance, Picture mode icon, <b>MF</b> =Manual focus, <b>ISO</b> =ISO warning
LCD Panel Display	⚡ is lit=Built-in flash ready, Blinking=Flash should be used, <b>⚡AUTO</b> =Auto discharge, <b>⚡AUTO</b> Ⓞ=Auto flash+Redeye reduct, □=Single frame shooting, ☐=Continuous shooting, ⌚=Self-timer, 📡=Remote control shooting, 🔋=Battery exhaustion warning, ☐=Auto bracketing exposure (exposure setting steps can be set to 1/2 EV or 1/3 EV), ☉=Center-weighted metering, ☐=Spot metering, ☐=Select focus point, ☐=Center focus point, Shutter speed, Aperture value, White Balance, Capacity remaining and ☒=Exposure compensation, <b>PC</b> (mass storage)/ <b>Pb</b> (PictBridge) appears when the USB cable is connected
Depth of Field Confirmation	Electronically controlled and usable in all exposure modes
Self-timer	Electronically controlled with delay time of 12 sec./2 sec. (with mirror lock up). Start by pressing shutter release button. Operation confirmation: Possible to set beep. Can be cancelled after operation
Mirror	Quick-return mirror, mirror lock up function (available at 2 sec. self-timer)
Auto Bracket	Three frames (under exposed, proper exposure and overexposed) are shot continuously with exposure bracketing. (Selectable between 1/2 EV and 1/3 EV for Exposure setting steps)
Exposure Meter/ Metering Range	TTL multi (16)-segment metering, Metering range from EV 1 to EV 21.5 (at ISO 200, with 50 mm f/1.4 lens), Center-weighted and Spot metering mode can be set

EV Compensation	±2.0 EV (Selectable between 1/2 EV and 1/3 EV for Exposure setting steps)	
AE Lock	Button type (timer type default: 20 sec. or continuous as long as the shutter button is halfway pressed)	
Built-in Flash	P-TTL built-in flash with serial control , GN 15.6 (ISO 200/m), Angles of coverage: 28 mm lens angle of view (35mm conversion), Flash synchronization speed range at 1/180 sec. and slower, Daylight-sync flash, Slow-speed-sync flash, ISO range = P-TTL: 200 to 3200	
External Flash Sync	Hot shoe with X-contact, which couples with Pentax dedicated auto flashes, ISO range = P-TTL: 200 to 3200, Automatic flash, Red-eye reduction flash function, High-speed-sync, wireless-sync with PENTAX dedicated flash	
Custom Function	19 functions can be set	
Time Function	World Time settings for 70 cities (28 time zones)	
Power	Two CR-V3, four AA lithium, AA Ni-MH rechargeable, or AA alkaline batteries	
Battery Exhaustion	Battery exhaustion symbol  is lit. The shutter is locked and no indication appears in the viewfinder when  starts blinking	
In/Out Port	USB/Video terminal (USB 2.0 (high speed compatible)), DC input terminal, Cable switch terminal	
Video Output Format	NTSC/PAL	
PictBridge	Compatible printer Print mode	PictBridge-compatible printer Print One, Print All, DPOF AUTOPRINT
Dimensions and Weight	125 mm (W) × 92.5 mm (H) × 67 mm (D) (excluding protruding section), 505 g (body only without batteries)	
Accessories	Hot shoe cover F <sub>K</sub> , Eyecup F <sub>L</sub> , ME viewfinder cap, Body mount cover, USB Cable I-USB17, Video cable I-VC28, Software (CD-ROM) S-SW43, Strap O-ST10, Four AA alkaline batteries , Operating manual (this book) and PENTAX PHOTO Browser 2.1/PENTAX PHOTO Laboratory 2.1 operating manual	
Languages	English, French, German, Spanish, Italian, Swedish, Dutch, Russian, Korean, Chinese (Traditional / Simplified) and Japanese	

## Specifications for Remote Control F (Optional)

Remote Control	Infrared Remote Control unit, captured about three seconds after remote control shutter button is pressed or immediate capture on pressing the button, operating distance = within approx. 5 m in front of the camera.
Power	One lithium battery (CR1620)
Dimensions	22 mm (W) × 53 mm (H) × 6.5 mm (D)
Weight	7 g (including battery)

**AdobeRGB**

Color space recommended by Adobe Systems, Inc. for commercial printing. Wider range of color reproduction than sRGB. Covers most of the color range so colors only available when printed are not lost when editing images from a computer. When image is opened by non-compatible software, the colors look lighter.

**AE Metering**

Brightness of subject is measured to determine exposure. In this camera, select from [Multi-segment Metering], [Center-weighted Metering] and [Spot Metering].

**Aperture**

The aperture increases or reduces the light beam (thickness) that passes through the lens.

## 6

## Appendix

**Auto Bracket**

For automatically changing the shooting conditions. When the shutter button is pressed, three images are shot. The first one has no compensation, the second is under-exposed and the third is over-exposed.

**Bright Portion**

Over exposed area in the image loses contrast and appears white.

**Camera Shake (Blur)**

When the camera moves while the shutter is open, the entire image appears as if flowing. This occurs more often when shutter speed is low. Prevent camera shake by raising the sensitivity, using the flash, and raising the shutter speed. Alternatively, use a tripod to stabilize the camera. Because camera motion causes camera shake, use the self-timer, the remote control unit, and the cable switch to prevent.

**CCD (Charge Coupled Devices)**

Photography element which converts the light entering through the lens into electric signals.

## **Color space**

A defined range of colors from the spectrum which are used. In digital cameras, [sRGB] is defined as the standard by Exif. In this camera, [AdobeRGB] is also used because of the richer color expression over sRGB.

## **Color Temperature**

This numerically expresses the color of the light source illuminating the subject. This is indicated in absolute temperature, using Kelvin (K) units. The color of light shifts to a bluish color as the color temperature rises, and to a reddish color as the color temperature falls.

## **DCF (Design Rule for Camera File System)**

A digital camera file system standard established by the Japan Electronics and Information Technology Industries Association (JEITA).

## **Depth of Field**

Area of focus. This depends on the aperture, lens focal length, and distance to the subject. For example, select a smaller aperture to increase the depth of field or use a larger aperture to decrease the depth of field.

## **DPOF (Digital Print Order Format)**

Rules for writing information onto a card with recorded images regarding the specific images and number of copies to be printed. Prints can easily be made by taking images to a DPOF photo printing store.

## **EV (Exposure Value)**

Exposure Value is determined by the combination of the aperture value and the shutter speed.

## **EV Compensation**

Process of adjusting the image brightness by changing the shutter speed and aperture value.

## **Exif (Exchangeable image file format for digital still camera)**

A standard digital camera file format established by the Japan Electronics and Information Technology Industries Association (JEITA).

## **Focus point**

Position in the viewfinder that determines focus.

## Histogram

A graph that shows the darkest and brightest points in an image. The horizontal axis represents the brightness and the vertical axis represents the number of pixels. This is useful when you wish to refer to the exposure status of an image.

## JPEG

An image compression method. The image is recorded in JPEG format when the quality level is set to ★★★ (Best), ★★ (Better), or ★ (Good). Images recorded in JPEG format are suited for viewing on your PC or for attaching to e-mail.

## ND (Neutral Density) Filter

A filter with many saturation levels that adjusts the brightness without affecting the picture itself.

## Noise Reduction

Process to reduce noise (image roughness or unevenness) caused by low shutter speed.

## NTSC/PAL

These are video output formats. NTSC is mainly used in Japan, North America, and South Korea. PAL is mainly used in Europe and in China.

## Quality Level

This refers to the image compression ratio. The lower the compression, the more detailed the image. The image becomes rougher as the compression rate rises.

## RAW data

Unedited image data output from the CCD. RAW data is data before being internally processed by the camera. Add settings that are added before shooting in other file formats (such as White Balance, Contrast, Saturation and Sharpness) individually frame by frame after shooting. In addition, RAW data is 12-bit data that contains 16 times the information of 8-bit JPEG and TIFF data. Rich gradations are possible. Transfer RAW data to your computer and use the provided software to create image data with different settings, such as JPEG or TIFF.



**Recorded Pixels**

Indicates the size of the image by the number of pixels. The more pixels that compose a picture, the larger the image size.

**Sensitivity**

The degree of light. With a high sensitivity, images can be shot with a high shutter speed even in dark places, reducing camera shake. However, images with high sensitivity are more susceptible to noise.

**Shutter Speed**

The length of time that the shutter is open and light strikes the CCD. The amount of light that strikes the CCD can be changed by altering the shutter speed.

**sRGB (standard RGB)**

International standard of color space established by the IEC (International Electrotechnical Commission). This is defined from color space for PC monitors and is also used as the standard color space for Exif.

**Vignetting**

Vignetting occurs when corners of pictures are blackened because the subject was blocked by the hood or filter or the flash was blocked.

**White Balance**

While shooting, color temperature is adjusted to match the light source so that the subject appears to have correct color.

## Symbols

[ Rec. Mode] Menu .....	98, 176
[ Playback] Menu .....	98, 176
[ Set-up] Menu .....	99, 177
[ <b>C</b> Custom Setting] Menu .....	100, 178
Auto Picture .....	43, 47
Normal .....	47
Portrait .....	47
Landscape .....	47
Macro .....	47
Moving Object .....	47
Night Scene Portrait .....	47
Flash OFF .....	47
button .....	93, 95
button .....	94
button .....	93
button .....	95
button .....	93
Preview .....	130

## A

AC Adapter .....	28
Adding the Date .....	79
AdobeRGB .....	117
AE lock .....	143
AE Metering .....	131
<b>AE-L</b> button .....	93
AF Mode .....	121
AF360FGZ .....	154
<b>A.F.C</b> (Continuous mode) .....	121
<b>A.F.S</b> (Single mode) .....	121
Alkaline batteries .....	26
Aperture .....	129
Aperture Priority Mode <b>Av</b> ....	137
Auto Bracket .....	144
Auto Picture  .....	43, 47





Auto Power Off .....	170
<b>AF</b> (Autofocus) .....	118
Autofocus <b>AF</b> .....	118
Automatic Sensitivity Correction .....	115
AV Equipment .....	70
<b>Av</b> (Aperture Priority) mode .....	137

## B

B&W (Digital Filter) .....	71
Batteries .....	25
Beep .....	164
Bright .....	108
Bright Portion .....	161
Brightness of the LCD Monitor .....	169
Built-in flash .....	49, 147
<b>B</b> (Bulb) Mode .....	141
Bulb Mode <b>B</b> .....	141



## C

Cable Switch .....	141
Capture Information .....	17, 18
Card access lamp .....	15
CCD Cleaning .....	183
Center-weighted .....	132
Cloudy (White Balance) .....	112
Color space .....	117
Color Temperature .....	113
Continuous Autofocus .....	125
Continuous mode <b>A.F.C</b> .....	121
Continuous Shooting .....	53
Contrast .....	111
Contrast-Control-Sync Flash .....	160
Correct exposure .....	128
CR-V3 .....	26



- Custom Function ..... 100  
**[C Custom Setting]**  
 Menu ..... 100, 178
- D**
- Date Adjust ..... 35  
 Date change ..... 164  
 Daylight (White Balance) ..... 112  
 Daylight-Sync Shooting ..... 52  
 Default Setting ..... 33, 176  
 Delete ..... 73  
 Delete All Images ..... 74  
 (Delete) button ..... 94  
 Deleting a Single Image ..... 73  
 Depth of Field ..... 129  
 Digital Filter ..... 71  
 Diopter Adjust ..... 39  
 Direct Printing ..... 83  
 Display Language ..... 168  
 Display Style ..... 161  
 DPOF AUTOPRINT ..... 90  
 DPOF Settings ..... 79  
 Drive Mode ..... 102
- E**
- e-dial ..... 93  
 Error Message ..... 188  
 EV Compensation ..... 142  
 **Av** (EV Compensation/Av)  
 button ..... 93  
 Exposure ..... 128  
 Exposure metering timer ..... 145  
 Exposure Mode ..... 133  
 Exposure  
 Warning ..... 136, 138, 140  
 External flash ..... 154
- F**
- File # ..... 170  
 Filter ..... 71  
 Fireworks ..... 141
- Fix Exposure ..... 125  
 Fix Focus ..... 124  
 Flash ..... 147  
 Flash (White Balance) ..... 112  
 Flash Compensation ..... 147  
 Flash Off ..... 47  
 Flash OFF  ..... 47  
 **UP** (Flash pop-up) button ... 93  
 Fluorescent Light  
 (White Balance) ..... 112  
**Fn** button ..... 93, 95  
 Fn Menu ..... 102  
 Focus Indicator ..... 101, 126  
 Focus Lock ..... 124  
 Focus mode lever ..... 93  
 Focus point ..... 122  
 Focusing ..... 118  
 Format ..... 163  
 Four-way controller ..... 93, 95
- G**
- Guide display ..... 16, 168
- H**
- High-Speed Flash Sync  
 Mode ..... 156  
 Histogram ..... 19, 171
- I**
- Image Tone ..... 108  
**INFO** button ..... 93, 95  
 Instant Review ..... 171  
 ISO Sensitivity ..... 115  
 ISO Sensitivity Warning  
 Display ..... 116
- L**
- Landscape  ..... 47  
 Language ..... 33  
 Last Memory ..... 176  
 LCD Monitor ..... 16

LCD panel .....	22
Lens .....	37, 180
Lens unlock button .....	38, 92
Lithium batteries .....	26

## M

Macro  .....	47
Main switch .....	92, 94
<b>MF</b> (Manual focus) .....	126
Manual focus <b>MF</b> .....	126
Manual White Balance .....	113
Matte Field .....	127
<b>MENU</b> button .....	93, 94
Menu Operation .....	96
Meter Operating Time .....	133
Mirror Lock Up .....	62, 184
Mode dial .....	93, 104
Moving Object  .....	47
Multiple Flashes .....	159
Multi-segment .....	131

## N





Natural .....	108
Night Scene .....	141
Night Scene Portrait  .....	47
Ni-MH .....	26
Ni-MH rechargeable batteries .....	26
Nine-Image Display .....	66
Noise Reduction .....	141
Normal  .....	47
NTSC .....	169

## O

<b>OK</b> button .....	93, 95
Optional Accessories .....	185

## P

<b>P</b> (Program) Mode .....	134
PAL .....	169
PC-F .....	191

PictBridge .....	83
Pixels .....	109
Playback .....	18, 63
 (Playback) button .....	93, 95
 Playback] Menu .....	98, 176
Playback Time .....	27
Portrait  .....	47
Power .....	32
Press fully .....	45
Press halfway .....	45
Preview  .....	130
Print All .....	88
Print One .....	86
Print Service .....	79
Printer connection .....	85
Program Mode <b>P</b> .....	134
Protect .....	77
 (Protect) button .....	95
P-TTL (Auto) .....	155
P-TTL (Flash) .....	157

## Q

Quality Level .....	31, 110
---------------------	---------

## R

RAW .....	110
Rear Curtain Sync Flash .....	158
 Rec. Mode] Menu .....	98, 176
Recorded Pixels .....	31, 109
Red-eye reduction .....	52, 158
Remaining image storage capacity .....	27
Remote Control .....	59
Reset .....	172, 173
Rotate .....	64

## S

Saturation .....	111
SD Memory Card .....	29
Select&Delete .....	75
Selecting the Focusing Area ...	122

Self-Timer .....	55
Sensitivity .....	115
Sepia (Digital Filter) .....	71
[X] Set-up] Menu .....	99, 177
Shade (White Balance) .....	112
Sharpness .....	111
Shutter Priority Mode <b>Tv</b> .....	135
Shutter release	
button .....	45, 92, 94
Shutter speed .....	128
Single mode <b>A.F.S</b> .....	121
Slideshow .....	68, 162
Slim (Digital Filter) .....	71
Soft (Digital Filter) .....	71
Spot Metering .....	132
sRGB .....	117
Strap .....	24

## T

Transfer Mode .....	84
Tungsten Light (White Balance) .....	112
TV .....	70
<b>Tv</b> (Shutter Priority) mode ....	135

## U

USB cable .....	83
Using aperture ring .....	182

## V

Video cable .....	70
Video Output Format .....	169
Viewfinder .....	20, 39
Vignetting .....	199

## W

White Balance .....	112
Wireless Mode .....	156
World Time .....	165

## Z

Zoom Display .....	65
Zoom Lens .....	48

All PENTAX cameras purchased through authorized bona fide photographic distribution channels are guaranteed against defects of material or workmanship for a period of twelve months from date of purchase. Service will be rendered, and defective parts will be replaced without cost to you within that period, provided the equipment does not show evidence of impact, sand or liquid damage, mishandling, tampering, battery or chemical corrosion, operation contrary to operating instructions, or modification by an unauthorized repair shop. The manufacturer or its authorized representatives shall not be liable for any repair or alterations except those made with its written consent and shall not be liable for damages from delay or loss of use or from other indirect or consequential damages of any kind, whether caused by defective material or workmanship or otherwise; and it is expressly agreed that the liability of the manufacturer or its representatives under all guarantees or warranties, whether expressed or implied, is strictly limited to the replacement of parts as hereinbefore provided. No refunds will be made on repairs by nonauthorized PENTAX service facilities.

6

Appendix

#### Procedure During 12-month Warranty Period

Any PENTAX which proves defective during the 12-month warranty period should be returned to the dealer from whom you purchased the equipment or to the manufacturer. If there are no representatives of the manufacturer in your country, send the equipment to the manufacturer, with postage prepaid. In this case, it will take a considerable length of time before the equipment can be returned to you owing to the complicated customs procedures required. If the equipment is covered by warranty, repairs will be made and parts replaced free of charge, and the equipment will be returned to you upon completion of servicing. If the equipment is not covered by warranty, regular charges of the manufacturer or of its representatives will apply. Shipping charges are to be borne by the owner. If your PENTAX was purchased outside of the country where you wish to have it serviced during the warranty period, regular handling and servicing fees may be charged by the manufacturer's representatives in that country. Notwithstanding this, your PENTAX returned to the manufacturer will be serviced free of charge according to this procedure and warranty policy. In any case, however, shipping charges and customs clearance fees to be borne by the sender. To prove the date of your purchase when

required, please keep the receipt or bills covering the purchase of your equipment for at least a year. Before sending your equipment for servicing, please make sure that you are sending it to the manufacturer's authorized representatives or their approved repair shops, unless you are sending it directly to the manufacturer. Always obtain a quotation for the service charge, and only after you accept the quoted service charge, instruct the service station to proceed with the servicing.

- **This warranty policy does not affect the customer's statutory rights.**
- **The local warranty policies available from PENTAX distributors in some countries can supersede this warranty policy. Therefore, we recommend that you review the warranty card supplied with your product at the time of purchase, or contact the PENTAX distributor in your country for more information and to receive a copy of the warranty policy.**



The CE Mark is a Directive conformity mark of the European Union.

## For customers in USA

### STATEMENT OF FCC COMPLIANCE

This device complies with Part 15 of the FCC Rules. Operation is subject to the following two conditions: (1) This device may not cause harmful interference, and (2) this device must accept any interference received, including interference that may cause undesired operation.

Changes or modifications not approved by the party responsible for compliance could void the user's authority to operate the equipment.

This equipment has been tested and found to comply with the limits for a Class B digital device, pursuant to part 15 of the FCC Rules.

These limits are designed to provide reasonable protection against harmful interference in a residential installation. This equipment generates, uses and can radiate frequency energy and, if not installed and used in accordance with the instructions, may cause harmful interference to radio communications. However, there is no guarantee that interference will not occur in a particular installation.

If this equipment does cause harmful interference to radio or television reception, which can be determined by turning the equipment off and on, the user is encouraged to try to correct the interference by one or more of the following measures:

- Reorient or relocate the receiving antenna.
- Increase the separation between the equipment and receiver.
- Connect the equipment into an outlet on a circuit different from that to which the receiver is connected.
- \* Consult the dealer or an experienced radio/TV technician for help.

## For customers in Canada

This Class B digital apparatus meets all requirements of the Canadian Interference - Causing Equipment Regulations.

### Pour les utilisateurs au Canada

Cet appareil numérique de la classe B respecte toutes les exigences du Règlement sur le matériel brouilleur du Canada.



# Declaration of Conformity

According to 47CFR, Parts 2 and 15 for  
Class B Personal Computers and Peripherals

We: PENTAX Imaging Company  
A Division of PENTAX of America, Inc.

Located at: 600 12<sup>th</sup> Street, Suite 300  
Golden, Colorado 80401 U.S.A.  
Phone: 303-799-8000 FAX: 303-790-1131

Declare under sole responsibility that the product identified herein complies with 47CFR Parts 2 and 15 of the FCC rules as a Class B digital device. Each product marketed is identical to the representative unit tested and found to be compliant with the standards. Records maintained continue to reflect the equipment being produced can be expected to be within the variation accepted, due to quantity production and testing on the statistical basis as required by 47CFR §2.909. Operation is subject to the following two conditions: (1) This device may not cause harmful interference, and (2) This device must accept any interference received, including interference that may cause undesired operation. The above named party is responsible for ensuring that the equipment complies with the standards of 47CFR §15.101 to §15.109.

Product Name: PENTAX Digital Still Camera

Model Number: *\*istDS2*

Contact person: Customer Service Manager

Date and Place: September, 2005, Colorado

## Information on disposal for users



### 1. In the European Union

If your product is marked with this symbol, it means that used electrical/electronic products should not be mixed with general household waste. There exists a separate collection system for these products.

Used electric/electronic equipment must be treated separately and in accordance with legislation that requires proper treatment, recovery and recycling of these products. Following the implementation by member states, private households within the EU states may return their used electrical/electronic equipments to designated collection facilities free of charge\*. In some countries your local retailer may also take back your old product free of charge if you purchase a similar new one.

\*Please contact your local authority for further details.

By disposing of this product correctly you will help ensure that the waste undergoes the necessary treatment, recovery and recycling and thus prevent potential negative effects on the environment and human health which could otherwise arise due to inappropriate waste handling.

### 2. In other countries outside the EU

If you wish to discard this product, please contact your local authorities and ask for the correct method of disposal.

For Switzerland: Used electrical/electronic equipment can be returned free of charge to the dealer, even when you don't purchase a new product. Further collection facilities are listed on the home page of [www.swico.ch](http://www.swico.ch) or [www.sens.ch](http://www.sens.ch).

# Memo

- PENTAX Corporation** 2-36-9, Maeno-cho, Itabashi-ku, Tokyo 174-8639, JAPAN  
(<http://www.pentax.co.jp/>)
- PENTAX Europe GmbH  
(European Headquarters)** Julius-Vosseler-Strasse, 104, 22527 Hamburg,  
GERMANY  
(HQ - <http://www.pentaxeurope.com>)  
(Germany - <http://www.pentax.de>)
- PENTAX U.K. Limited** PENTAX House, Heron Drive, Langley, Slough, Berks  
SL3 8PN, U.K.  
(<http://www.pentax.co.uk>)
- PENTAX France S.A.S.** 12/14, rue Jean Poulmarch, 95106 Argenteuil Cedex,  
FRANCE
- PENTAX Benelux B.V.** (for Netherlands)  
Spinveld 25, 4815 HR Breda, NETHERLANDS  
(<http://www.pentax.nl>)  
(for Belgium & Luxembourg)  
Weiveldlaan 3-5, 1930 Zaventem, BELGIUM  
(<http://www.pentax.be>)
- PENTAX (Schweiz) AG** Widholzstrasse 1 Postfach 367 8305 Dietlikon,  
SWITZERLAND  
(<http://www.pentax.ch>)
- PENTAX Scandinavia AB** P.O. Box 650, 75127 Uppsala, SWEDEN  
(<http://www.pentax.se>)
- PENTAX Imaging Company**  
**A Division of PENTAX of America, Inc.**  
(Headquarters)  
600 12th Street, Suite 300 Golden, Colorado 80401, U.S.A.  
(Distribution & Service Center)  
16163 West 45th Drive, Unit H Golden, Colorado 80403,  
U.S.A. (<http://www.pentaximaging.com>)
- PENTAX Canada Inc.** 1770 Argentia Road Mississauga, Ontario L5N 3S7,  
CANADA  
(<http://www.pentax.ca>)



<http://www.pentax.co.jp/english>

- Specifications and external dimensions are subject to change without notice.

## Free Manuals Download Website

<http://myh66.com>

<http://usermanuals.us>

<http://www.somanuals.com>

<http://www.4manuals.cc>

<http://www.manual-lib.com>

<http://www.404manual.com>

<http://www.luxmanual.com>

<http://aubethermostatmanual.com>

Golf course search by state

<http://golfingnear.com>

Email search by domain

<http://emailbydomain.com>

Auto manuals search

<http://auto.somanuals.com>

TV manuals search

<http://tv.somanuals.com>