

PENTAX

PENTAX ESPIO140V

PENTAX ESPIO140V QUARTZ DATE



for your
precious moments

OPERATING MANUAL

57240

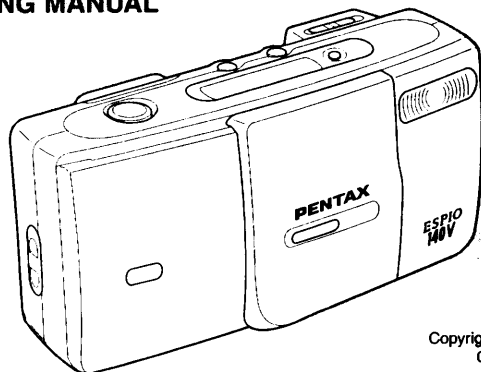

Copyright © PENTAX Corporation 2003
02-200302 Printed in Philippines

- PENTAX Corporation** 2-36-9, Maeno-cho, Itabashi-ku, Tokyo 174-8639, JAPAN (<http://www.pentax.co.jp/>)
- PENTAX Europe GmbH (European Headquarters)**
Julius-Vosseler-Strasse, 104, 22527 Hamburg, GERMANY
(HQ - <http://www.pentax-europe.com>) (Germany - <http://www.pentax.de>)
- Pentax U.K. Limited**
Pentax House, Heron drive, Langley, Slough, Berks SL3 8PN, U.K. (<http://www.pentax.co.uk>)
- Pentax France S.A.S.**
12/14, rue Jean Poulmarch, 95106 Argenteuil Cedex, FRANCE
- Pentax Benelux B.V.**
(for Netherlands) Spinveld 25, 4815 HR Breda, NETHERLANDS (<http://www.pentax.nl>)
(for Belgium & Luxembourg) Weiveldlaan 3-5, 1930 Zaventem, BELGIUM
(<http://www.pentax.be>)
- Pentax (Schweiz) AG**
Widenholzstrasse 1 Postfach 367 8305 Dietlikon, SWITZERLAND (<http://www.pentax.ch>)
- Pentax Scandinavia AB**
P.O. Box 650, 75127 Uppsala, SWEDEN (<http://www.pentax.se>)
- PENTAX U.S.A., Inc.**
35 Inverness Drive East, Englewood, Colorado 80112, U.S.A. (<http://www.pentax.com>)
- PENTAX Canada Inc.**
3131 Universal Drive, Mississauga, Ontario L4X 2E5, CANADA (<http://www.pentaxcanada.ca>)

ペンタックス株式会社 〒174-8639 東京都板橋区前野町2-36-9
ペンタックス販売株式会社 〒100-0014 東京都千代田区永田町1-11-1

このマーク(CE)はEU(欧州共同体)の要求事項に適合している事を示すものです。
The CE Mark is a Directive conformity mark of the European Community.



- Congratulations on your purchase of the PENTAX ESPIO140V/140V DATE and welcome to the world of Pentax zoom compact photography!
- Your compact, light weight camera is a great companion to preserve your favorite memories.
- Please read this manual carefully before operating the camera to ensure you understand the features and capabilities of this camera.
 - Please read the Pentax User's Safety Guide before using the camera for safe operation.
 - The illustrations used in this manual may differ from the camera's actual appearance.
 - Illustrations in this operating manual are for the DATE model.

SPECIFICATIONS

- Type:**
35 mm fully automatic lens-shutter with built-in zoom lens and auto flash
- Film:**
Auto film speed setting with 35 mm perforated DX-coded film with ISO rating from 25-3200 (1EVstep). Non-DX coded films are set to ISO 25
- Format:**
24 × 36 mm
- Film loading:**
Auto film loading. Closing the back cover will automatically wind the film to first frame.
- Film winding:**
Auto film winding.
- Film rewinding:**
Auto film rewinding at the end of roll.
Auto stop upon completion of rewinding. Rewinding time: approx. 25 sec. with 24-exposure film.
Rewinding in mid-roll provided.
- Frame number:**
Automatic readout of successive frame numbers in ascending order when shooting, and descending order when rewinding.
- External Display:**
LCD (Liquid Crystal Display)
- Lens:**
38-140mm f/5.8-11.8, 8 elements in 6 groups,
Angle of view: 59°-17.5°
- Focusing system:**
Pentax phase-matching passive 5 point autofocus.
Landscape mode, Spot AF, AF illuminator, Focus lock, Autofocusing range: 0.8m (2.62ft) - ∞ at Wide-angle and 1.15 m (3.77 ft) - ∞ at Telephoto Macro zoom mode
Maximum magnification: approx. 0.12 × (Equivalent to A4 size)
- Zooming:**
Electronic zoom
- Shutter:**
Programmed AE electronic shutter with speed approx. 1/360-2 sec.
Electromagnetic release.
- Self-timer:**
LED lamp indication. Delay time approx. 10 sec.
Cancellation after activation is possible.
- Viewfinder:**
Actual image zoom viewfinder.
80% field of view.
Magnification: 0.44 × (WIDE) - 1.49 × (TELE)
Diopter adjustment range: -3m⁻¹ - +1m⁻¹ (per meter)
Frame: Autofocus frame, Picture frame, Close distance compensation frame
- Green lamp lit: in-focus,
Green light blinks: out of focus or hard-to-autofocus subject.
- Red lamp lit: Flash is charged,
Red lamp blinks: Flash is charging.
- Exposure control:**
Programmed AE control
(AE compensation in a back light situation)
Range: EV 10.5-17.5 at WIDE, EV 14-19 at TELE in Auto or Daylight-Sync mode (ISO 400).
EV6-EV17.5 at WIDE, EV6-EV19 at TELE in Slow Shutter Speed mode (ISO 400)
- Exposure meter switch: shutter release button
- Flash:**
Built-in zoom flash with red-eye reduction,
Automatic flash discharge in low light and back light situations in Auto mode,
Flash ON=Day-light Sync,
Slow Shutter Speed Sync. (up to 2 sec.)
Automatic soft flash discharge at close-up distance.
Flash effective range:
0.8-6.2 m (1-22.3 ft) (WIDE), 1.15-3.6 m (1.64-9.84 ft) (TELE) (ISO 400 film used).
Flash recycling time:
Approx. 5 sec. (under Pentax testing conditions.)
- Date module:**
Crystal quartz controlled LCD digital clock,
auto calendar up to the year 2100.
Date imprint from the front side of film.
Imprinting mode:
(1) "Year, Month, Day", (2) "Day, Hour, Minute",
(3) "-----" (no imprint), (4) "Month, Day, Year"
(5) "Day, Month, Year".
- Power source:**
One 3V lithium battery (CR123A or equivalent)
- Battery life:**
Approx. 14 rolls of 24-Exposure film when 50% of shooting uses flash (under Pentax testing conditions)
- Battery exhaustion warning:**
(⚡) appears on the LCD panel,
Shutter is locked when (⚡) is blinking.
- Size & Weight:**
120.5(W) × 60.5(H) × 42(D) mm (4.8" × 2.4" × 1.7")
210g (6.9 oz) without battery
- Optional Remote control:**
Infrared remote control unit releases the shutter 3 seconds after the shutter button on the unit is pressed. Works up to 5 meters from the front of the camera.

SPECIFICATIONS AND EXTERNAL DIMENSIONS ARE SUBJECT TO CHANGE WITHOUT NOTICE.

1

1 NAMES OF WORKING PARTS

- ① Lens protector
- ② Shutter release button
- ③ AF/Self-timer button
- ④ Flash button
- ⑤ LCD panel
- ⑥ Diopter adjustment lever
- ⑦ Date button
- ⑧ Built-in flash
- ⑨ Viewfinder window
- ⑩ Lens
- ⑪ Remote control receiver
- ⑫ Light sensor window
- ⑬ Autofocus window
- ⑭ Self-timer lamp
- ⑮ Strap lug
- ⑯ Viewfinder eyepiece
- ⑰ Green lamp
- ⑱ Red lamp
- ⑲ Zoom button
- ⑳ Film information window
- ㉑ Battery chamber cover
- ㉒ Back cover
- ㉓ Tripod socket
- ㉔ Mid-roll rewind button
- ㉕ Back cover release lever

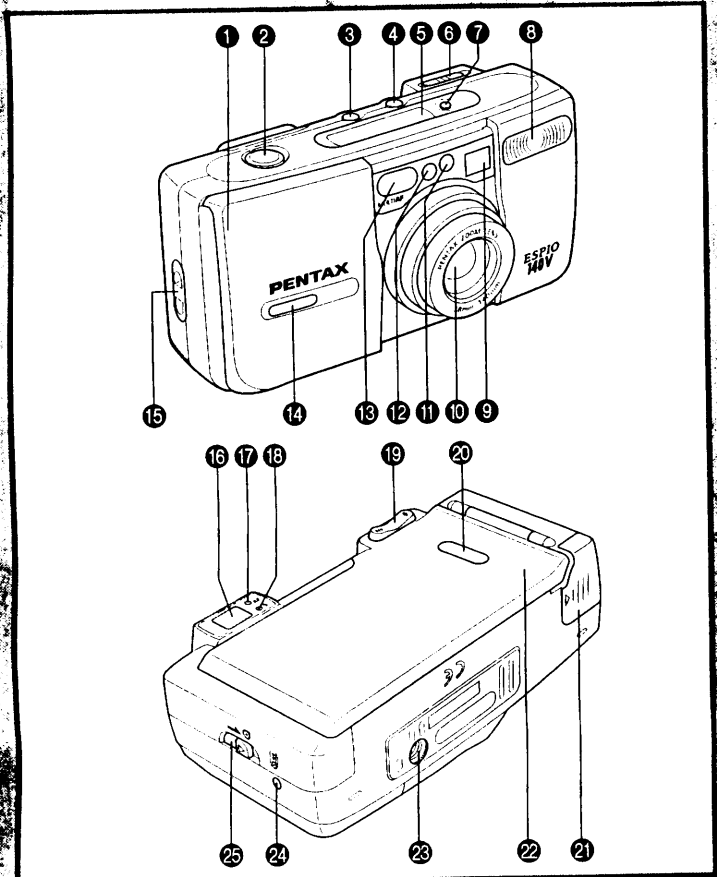

2

2 STRAP ATTACHMENT

Fit the strap on the camera as illustrated.
 * Protrusion A can be used for pushing the mid-roll rewind button and the date button.

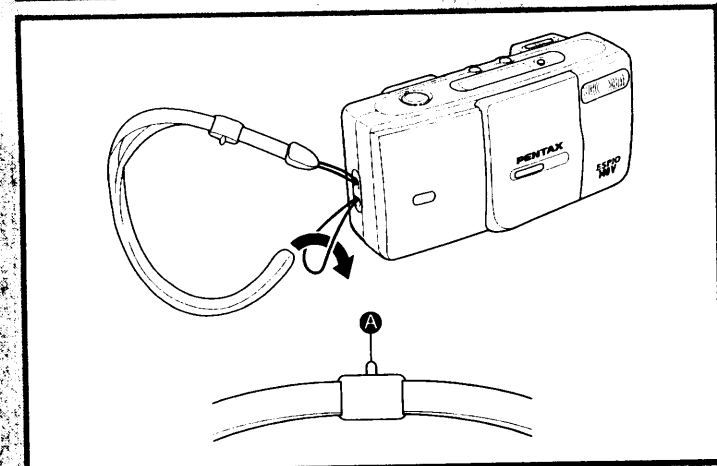

3

3 INSTALLING A BATTERY

Insert the battery with the plus (+) side up in accordance with the indication label in the battery chamber.

Use one 3V Lithium Battery (CR123A or the equivalent)

For **DATE** model, setting the date and time. Refer to the section 5 **IMPRINTING DATE/TIME**.

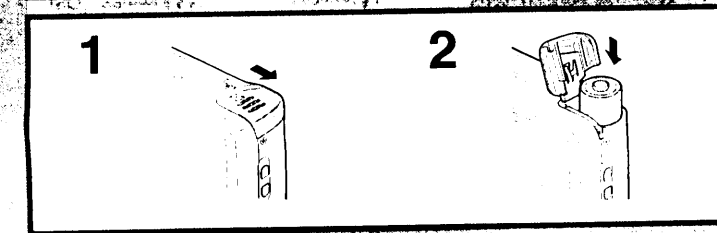

4

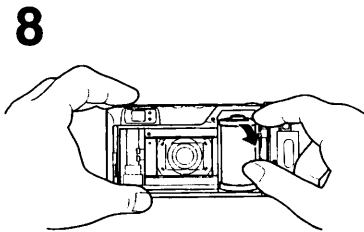
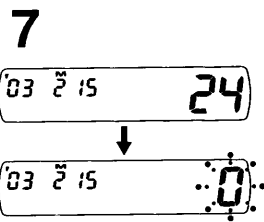
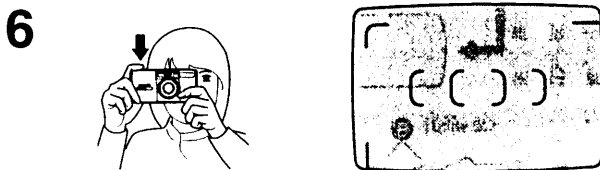
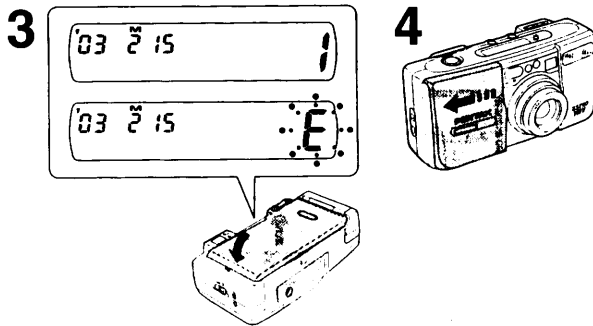
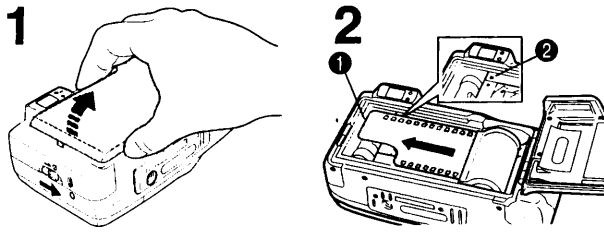

4 BASIC OPERATION

- 1 Open the back cover.
- 2 Load the film. Pull out the film leader end to reach the [FILM] mark ①. If there is dirt on the film detector ②, the film cannot be wound properly.
- 3 Close the back cover. The film automatically advances to the first frame. If "E" blinks on the LCD panel, repeat step 1-3 to load the film properly.
- 4 Open the lens protector to turn the switch ON.
- 5 Adjust the focus frame in the middle of the viewfinder to optimum clarity by diopter adjustment lever. Compose your subject by using the zoom button and focus on the subject within the autofocus frame.
- 6 Press the shutter release button halfway down to confirm the focus with green lamp lights on, and press the shutter release button completely to take a picture. The flash automatically discharges in low light.
- 7 The film will be rewound automatically after you have exposed the last frame of the roll.
- 8 Unload the film after confirm "0" blinks on the LCD panel.

- When the lens protector is opened, the lens slightly extends.
- When the camera is left unused for 3 minutes with the power on, the zoom lens automatically retracts to 38 mm to prevent it from damage.
- When the camera is unused for 5 minutes in the remote control mode, the zoom lens will be retracted to 38 mm position and cancel the remote control mode.

5

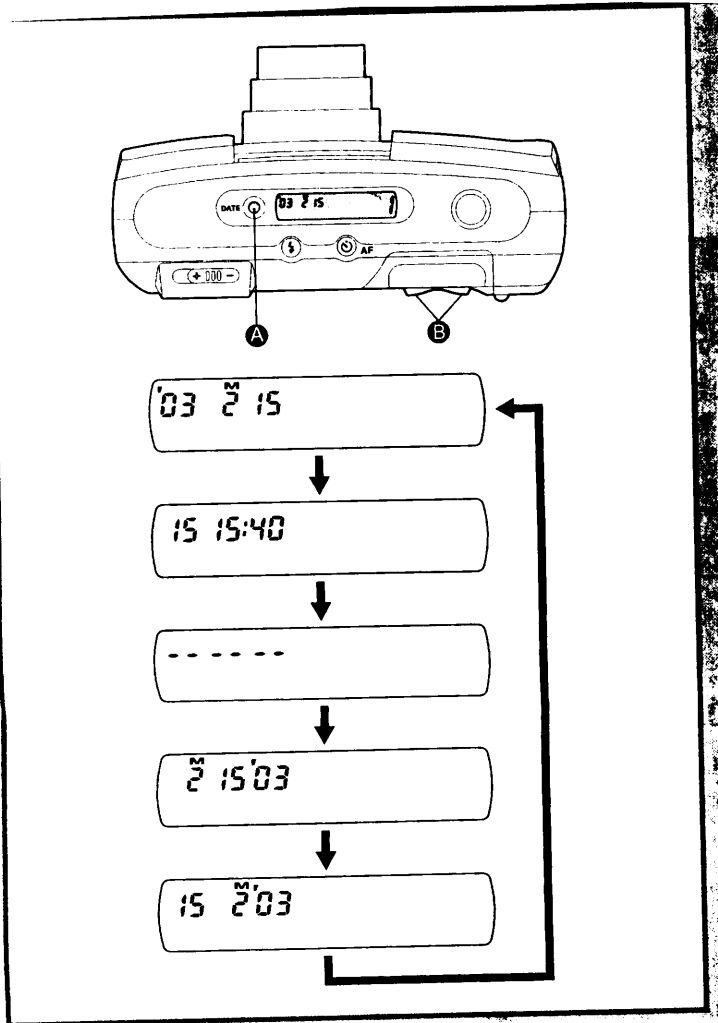

5 IMPRINTING DATE/TIME (DATE model only)

Selecting the Mode

Press the DATE button **A** to change the mode as shown in Fig. 5

Year Month Day

↓
Day Hour Minute

↓
--- (No imprinting)

↓
Month Day Year

↓
Day Month Year

Correcting the date and time

- 1 Press the Date button **A** for 3 seconds, the "Year" digits and **(M)** will blink.
- 2 Each time the Date button **A** is pressed, the blinking digits change in the following manner: Year → Month → Day → Hour → Minute, stop pressing the button when the desired digits appear to be corrected.
- 3 Press the Zoom button **B** to change the blinking digits.
- 4 Repeat 2. and 3. to change the date and time.
- 5 After adjusted all, press the DATE button **A** until blinking stops.

Note:

- 'M' above the digit indicates 'Month'.
- When the battery cover is opened or a new battery is installed, the time is set to 0:00 and no imprinting mode.

6

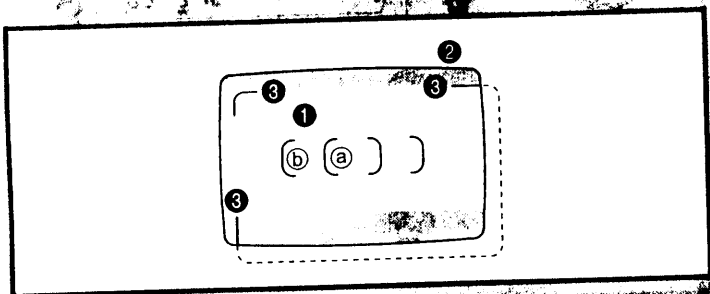

6 VIEWFINDER DISPLAYS

1 Autofocus frame

Focuses on the subject within this frame

- a Multi AF at wide and Spot AF
- b Multi AF at telephoto

2 Picture area

When taking normal pictures, compose your subject within this frame.

3 Close distance compensation frame

When the camera-to-subject distance is less than 1.4 m, compose your subject within this frame.

7

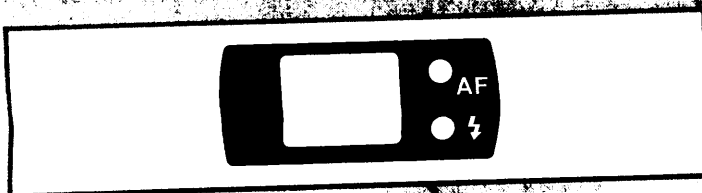

7 LAMP INDICATIONS

1 Green lamp (Autofocus status)

Lights up: The subject is in focus.

Blinks: The subject is out of focus.

The distance is too close.
Difficult subject matter for the autofocus.

2 Red lamp (Flash status)

Lights up: Flash is charged.

Ready to take a picture.

Blinks: Flash is charging.

AF illuminator:

When the shutter release button is pressed halfway down in low light condition, the flash discharges to provide illumination, making it easy for the autofocus to work.

8

ISO	38mm(⬆⬆⬆)	140mm(⬆)
25	0.8-1.6m(2.6-5.1 ft)	-----
50	0.8-2.2m(2.6-7.2 ft)	1.15-1.3m(3.8-4.2 ft)
100	0.8-3.1m(2.6-10.0 ft)	1.15-1.8m(3.8-5.9 ft)
200	0.8-4.4m(2.6-14.0 ft)	1.15-2.5m(3.8-8.3 ft)
400	0.8-6.2m(2.6-20.0 ft)	1.15-3.6m(3.8-12.0 ft)
800	0.8-8.8m(2.6-29.0 ft)	1.15-5.1m(3.8-17.0 ft)
1600	0.8-12.5m(2.6-41.0 ft)	1.15-7.2m(3.8-24.0 ft)
3200	0.8-17.5m(2.6-58.0 ft)	1.15-10.0m(3.8-33.0 ft)

9

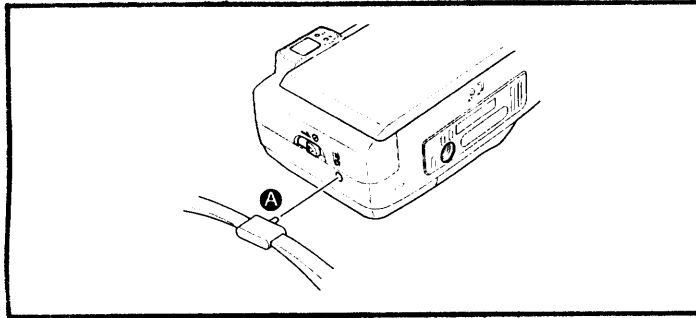

8 FLASH SHOOTING

8-1. Flash effective ranges

9 REWINDING THE FILM IN MID-ROLL

Depress the mid-roll rewind button (A) with the protruding part of the strap clamp. Check that "0" is blinking before removing the film from the camera.

10

10-1

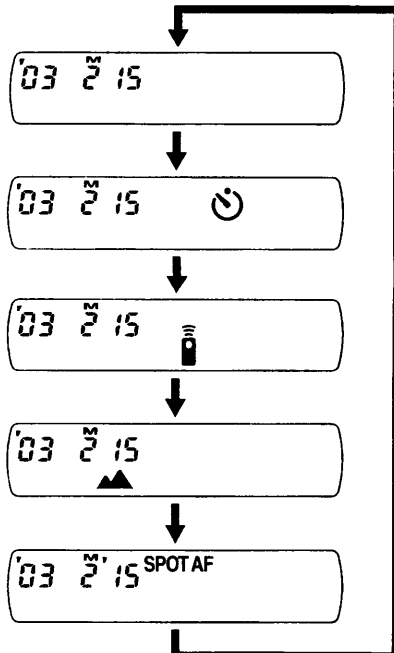
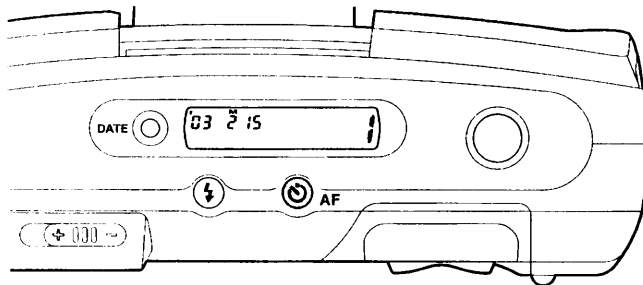

10 TAKING PICTURES WITH VARIOUS EXPOSURE MODES

10-1. EXPOSURE MODES

Open the lens protector and press the AF/Self-timer button (⊙ AF) to select exposure mode.

1. Single-frame photography (no icon displayed)

This mode is set by simply opening the lens protector.

Even if the shutter release button is held down, only one picture is taken.

2. Self-timer photography (⌚)

Use of a tripod is recommended.

The picture will be taken 10 seconds after the shutter button is pressed.

Press the shutter release button halfway down, confirm the green lamp is lit and press the shutter release button fully.

The self-timer is engaged and the self-timer lamp lights. The picture will be taken approximately 3 seconds after the self-timer lamp starts to blink.

To cancel the operation before it is completed, press the Self/AF button (⊙ AF).

3. Remote control photography (Ⓜ)

(Using optional remote control unit)

The self-timer lamp blinks slowly and the camera is in remote control mode.

Press the shutter release on the remote control unit. The self-timer lamp will blink rapidly and the picture will be taken after approximately 3 seconds.

4. Infinity-Landscape photography (⬆)

Use this mode to take a distant landscape or distant subject through a window.

5. Spot AF mode (SPOT AF)

Use this mode to focus on a specific subject. Focus on the subject with the center of the AF frame.

- Closing the lens protector cancels the mode and returns the camera to single-frame mode.

10-2

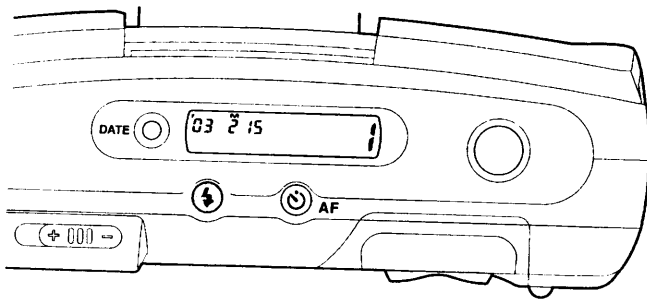

10-2. FLASH/RED-EYE REDUCTION FLASH AND SLOW SHUTTER SPEED MODES

Open the lens protector and press the Flash button (⚡) to select flash mode.

1. Auto flash (Normal mode)(no icon displayed)

The flash will automatically discharge in low light and back light conditions.

2. Auto/Red-eye reduction flash (👁)

Normal mode with red-eye flash discharges.

3. Auto mode/Daylight flash ON (⚡)

The flash will always discharge in both bright and dark conditions.

This mode can be used when a portrait is taken in a back light situation or as a fill-in flash in daylight.

4. Slow shutter speed with flash OFF (📷)

The flash will not discharge and the picture is taken at a slow speed of up to 2 seconds.

Use the mode in places where flash photography is prohibited or for a natural exciting light effect at night or indoors.

5. Slow shutter speed with red-eye reduction flash ON (👁📷⚡)

It is possible to take subjects and background in a balanced way by using the flash to properly expose the foreground subject and a slow speed to expose the low light background.

Red eye-reduction flash

To reduce red-eye caused by light from the flash being reflected in the subject's eyes.

The flash discharges once to make the subject's pupils contract prior to firing the main flash.

- Use a tripod is recommended to avoid camera shake at slow shutter speeds.
- Closing the lens protector cancels the mode and return to Auto flash mode (Normal mode).
- Do not place your hand on the flash when it is discharging as there is a risk of burns.

10-3. Focus-lock shooting

When the main subject is not in the focus frames.

1. Aim the focus frames to main subject and press the shutter release button halfway down.
2. While holding the shutter release button halfway down and then re-aim the camera to your desired compose, then press the shutter release button fully to take a picture.

For Customers in USA

STATEMENT OF FCC COMPLIANCE

This device complies with Part 15 of the FCC rules.

Operation is subject to the following two conditions:

- (1) This device may not cause harmful interference, and
- (2) this device must accept any interference received, including interference that may cause undesired operation.

Changes or modifications not approved by the party responsible for compliance could void the user's authority to operate the equipment.

This equipment has been tested and found to comply with the limits for a Class B digital device, pursuant to part 15 of the FCC Rules.

These limits are designed to provide reasonable protection against harmful interference in a residential installation. This equipment generates, uses and can radiate radio frequency energy and, if not installed and used in accordance with the instructions, may cause harmful interference to radio communications. However, there is no guarantee that interference will not occur in a particular installation. If this equipment does cause harmful interference to radio or television reception, which can be determined by turning the equipment off and on, the user is encouraged to try to correct the interference by one or more of the following measures:

- Reorient or relocate the receiving antenna.
- Increase the separation between the equipment and receiver.

Consult the dealer or an experienced radio/TV technician for help.

For Customers in Canada

This Class B digital apparatus meets all requirements of the Canadian Interference-Causing Equipment Regulations.

Free Manuals Download Website

<http://myh66.com>

<http://usermanuals.us>

<http://www.somanuals.com>

<http://www.4manuals.cc>

<http://www.manual-lib.com>

<http://www.404manual.com>

<http://www.luxmanual.com>

<http://aubethermostatmanual.com>

Golf course search by state

<http://golfingnear.com>

Email search by domain

<http://emailbydomain.com>

Auto manuals search

<http://auto.somanuals.com>

TV manuals search

<http://tv.somanuals.com>