

PENTAX

PC-500
PC-500 DATE

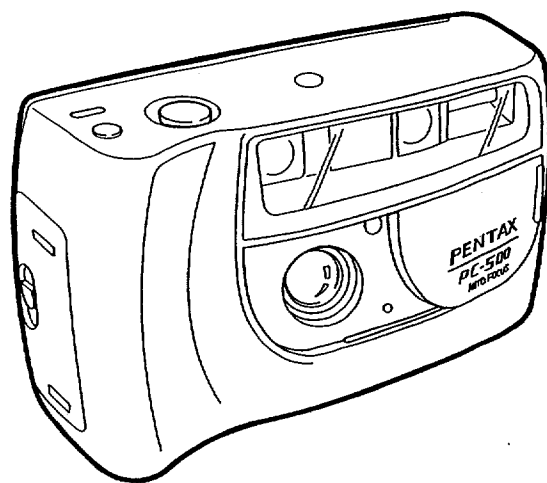

Operating manual
Bedienungsanleitung
Mode d'emploi
Manual de instrucciones
Manuale d'istruzioni
用戶備用手冊

NAMES OF PARTS

- ❶ Self-timer Button
- ❷ Auxiliary Rewind Button
- ❸ Shutter Release Button
- ❹ Film Counter
- ❺ Autofocus Window
- ❻ Built-in Flash
- ❼ Viewfinder Window
- ❽ Lens Protector
- ❾ Self-timer/Red-eye Reduction Lamp
- ❿ Light Sensor Window
- ⓫ Lens
- ⓬ Back Cover Release Lever
- ⓭ Viewfinder Eyepiece
- ⓮ Film Information Window
- ⓯ Tripod Socket
- ⓰ Red-eye Reduction Flash Switch
- ⓱ Battery Chamber Cover
- ⓲ Back Cover
- ⓳ Adjuster

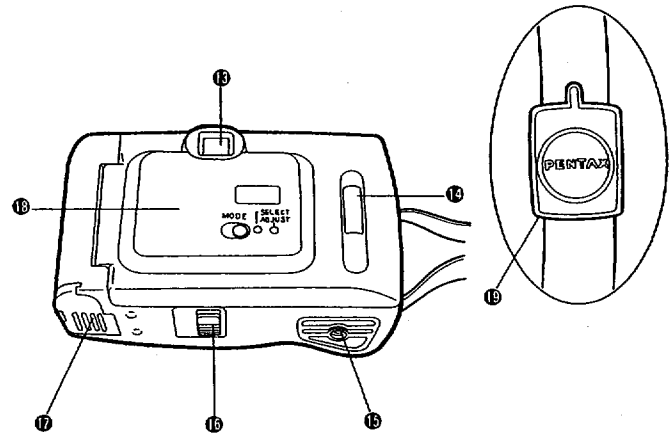
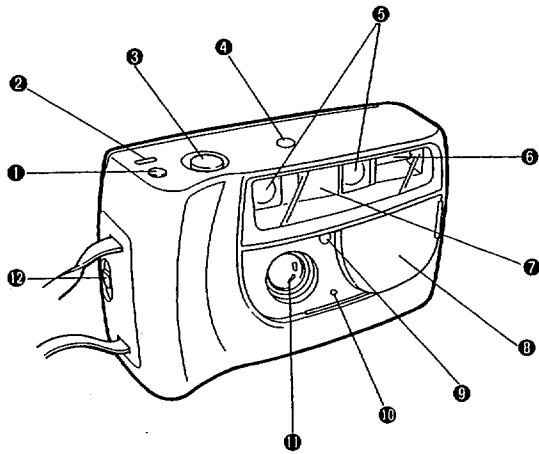

Power Switch

The power is turned on by opening the lens protector. (See figure [1].)

Film Loading

DX-coded film with ISO ratings from 100 to 400 can be used. Camera film speed is automatically set when the film is inserted.

* Camera film speed is set to ISO 400 when ISO 400 or faster films are inserted and set to ISO 100 when films slower than ISO 400 are inserted.

Do not expose the film to direct sunlight when it is inserted.

1. Press down the back cover release lever to open the back cover. (See figure [2].)
2. The film can easily be loaded by fully inserting the lower end of the film cartridge first and then inserting the top end. (See figure [3].)
3. Align the film leader with the film load mark. (See figure [4].)
* Insert the film between the guide rails and remove any slack.
4. Close the back cover. (See figure [5].)
5. Open the lens protector and press the shutter button once to automatically load the film and "1" is displayed in the film counter. If "1" is not displayed, the film has not been loaded properly. Load it again. (See figure [6].)

DATABACK OPERATION

NOTE: THIS IS APPLICABLE TO THE PC 500 DATE MODEL ONLY.

- ① Mode button ② Select button ③ Adjust button ④ Battery cover fixing screw

Changing the Mode

Each time you press the Mode button ①, the mode in the LCD panel changes in succession from A: "Year-Month-Day" to B: "Day-Hour-Minute" to C: "-----" to D: "Month-Day-Year" to E: "Day-Month-Year". Stop pressing the button when the desired mode appears. "-----" indicates that no data will be imprinted on the picture.

NOTE: "M" in the LCD panel indicates "Month". Use the adjuster pin on the strap to press the buttons.

Correcting the Data

1. Press the "Select" button ② until you reach the flickering digit which you wish to change.
2. Press the "Adjust" button ③ to change the digit of specified category you chose with the "Select" button ②. Digits increase by one each time you press the "Adjust" button ③. If you keep it depressed, the digit will advance continuously after two or three seconds.
3. Adjusting the second: Press the "Select" button ② until ":" will flicker. And press the "Adjust" button ③ in sync with a time signal to set the second to zero.
4. After the correction, press the "Select" button ② to make the data imprinting possible (the bar mark (-) appears on the LCD panel).

Battery

The databack is powered by one CR2025 3V Lithium battery. When the displays in the LCD cannot be seen clearly or when the watch function becomes unstable, replace the Battery with a new one by loosening Battery cover fixing screw ④. When the battery is set correctly, Data will be displayed. Reset the data according to "Correcting the Data".

18

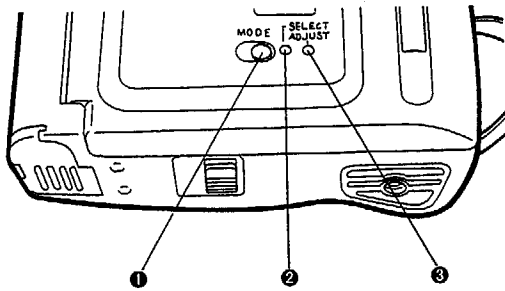

19

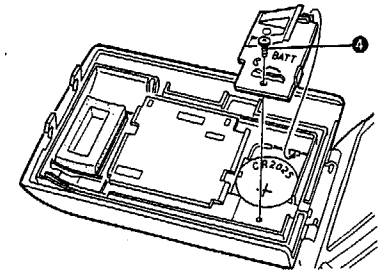

SPECIFICATIONS

Type:	35 mm fully automatic lens-shutter camera
Film:	35 mm DX-coded film with ISO rating from 100 to 400; J135 cartridge. The camera film speed is automatically set to ISO 100 when non-DX film is used.
Picture format:	24 mm × 36 mm
Film loading:	Auto film loading. Closing the back cover and pressing the shutter release button will automatically wind film to first exposure.
Film movement:	Auto winding; auto rewinding starts at end of roll. (Rewind speed: approximately 22 sec for 24-exposure film.) Film can also be rewound in mid roll.
Frame number:	Automatic readout of successive frame numbers in ascending order when shooting and descending order when rewinding.
Lens:	Pentax 35 mm, f/4.5, 3 elements in 3 groups
Focusing system:	Infrared active autofocus with focus-lock. Range: approx. 1.2 m (3.9 ft.) to infinity
Shutter:	Programmed AE electronic shutter.
Self-timer:	Electronic lamp indication. Approx. 10-sec delay. Cancellation after activation is possible.
Viewfinder:	Albada type bright frame finder
Exposure:	Programmed auto-exposure Range: EV 10 - 15 (ISO 100)
Flash:	Built-in flash with automatic low-luminance firing.
Charging time:	Approx. 6 sec according to Pentax testing conditions.
Power source:	Two 1.5V "AA" alkaline or manganese batteries. (Ni-Cd batteries not usable.)
Size and weight:	120 (W) × 70 (H) × 50 (D)mm; approx. 185 g
Date recording system:	Information is recorded on the reverse side of the film.
Date imprinting modes:	Push button to set unit to any of five modes: "Year/Mon/Day", "Day/Hour/Min/", "-- -- --" (Blank), "Mon/Day/Year" or "Day/Mon/Year".
Date imprinting power source:	3 V lithium battery (one CR2025 battery)
Size and weight:	120 (W) × 70(H) × 53 (D)mm; approx. 200 g

Reversal film (slide film) may not be properly exposed. Use of negative color film (print film) is recommended.

WARRANTY POLICY

All Pentax cameras purchased through authorized bona fide photographic distribution channels are guaranteed against defects of material or workmanship for a period of twelve months from date of purchase. Service will be rendered and defective parts will be replaced without cost to you within that period, provided the equipment does not show evidence of impact, sand or liquid damage, mishandling, tampering, battery or chemical corrosion, operation contrary to operating instructions, or modification by an unauthorized repair shop. The manufacturer or its authorized representatives shall not be liable for any repairs or alterations except those made with its written consent and shall not be liable for damages from delay or loss of use or for other indirect or consequential damages of any kind, whether caused by defective material or workmanship or otherwise; and it is expressly agreed that the liability of the manufacturer or its representatives under all guarantees or warranties, whether express or implied, is strictly limited to the replacement of parts as hereinbefore provided. No refunds will be made on repairs performed by nonauthorized Pentax service facilities.

Procedure during 12-month Warranty Period

Any Pentax equipment which proves defective during the 12-month warranty period should be returned to the dealer from whom you purchased the equipment or to the manufacturer. If there is no representative of the manufacturer in your country, send the equipment to the manufacturer, with postage prepaid. In this case, it will take a considerable length of time before the equipment can be returned to you owing to the complicated customs procedures required. If the equipment is covered by warranty, repairs will be made and parts replaced free of charge, and the equipment will be returned to you upon completion of servicing. If the equipment is not covered by warranty, regular charges of the manufacturer or of its representatives will apply. If your Pentax equipment was purchased outside of the country where you wish to have it serviced during the warranty period, regular handling and servicing fees may be charged by the manufacturer's representatives in that country. Notwithstanding this, Pentax equipment returned to the manufacturer will be serviced free of charge according to this procedure and warranty policy. In any case, however, shipping charges and customs clearance fees are to be borne by the sender. To prove the date of your purchase when required, please keep the receipts or bills covering the purchase of your equipment for at least a year. Before sending your equipment for servicing, please make sure that you are sending it to the manufacturer's authorized representatives or their accredited repair shops, unless you are sending it directly to the manufacturer. Always obtain a quotation of the service charge, and only after you accept the quoted service charge, instruct the service station to proceed with the servicing.

This warranty does not apply to Pentax products purchased in the U.S.A., U.K. or Canada. The local warranty policies available from Pentax distributors in those countries supersede this warranty policy.

Photography

Keep a distance of at least 1.2 m between the subject and the camera. When taking pictures outdoors, keep the sun behind you to take good pictures.

Caution: Make sure not to put your fingers or hair in front of the autofocus finder, lens, light sensor window and built-in flash.

1. Open the lens protector, place the subject in the autofocus frame [] and compose the picture. (See figure [7].)
 - * The lens cannot be focused at distances less than 1.2m.
2. Depress the shutter release button halfway and the green lamp in the finder lights up. The picture can now be taken. If the green lamp blinks, this indicates that the built-in flash is being charged or that battery power is too low. In this case, release the button and wait a few seconds before pressing it again. The picture can be taken if the green lamp in the finder lights up. (See figure [8].)
 - * When the green lamp is blinking, the flash is not charged. Release the shutter release button and wait a few seconds for the flash to be charged.
 - * If the green lamp is still blinking after waiting 10 seconds or more, the batteries should be replaced.

Flash Photography

1. The built-in flash in this camera is automatically activated when available light is not sufficient for proper exposure.
2. The table on the right shows the distance ranges that will produce good pictures.

ISO	Flash-effective ranges
100	1.2~3.1m(3.9~10.2ft.)
200	1.2~4.4m(3.9~14.4ft.)
400	1.6~6.3m(5.2~20.7ft.)

Red-Eye Reduction Flash Function

To reduce the red-eye phenomenon in the picture, set the red-eye reduction flash switch ON. With this mode, the red-eye reduction lamp illuminates the subject just before the shutter is released. (See figure [9].)

Red-eye phenomenon in flash photography

When a picture is taken using a flash, a subject's eyes may appear red in the print. This phenomenon is caused by the reflection of the electronic flash in the retina. It can be reduced when the surroundings of the subject are brightened, or shooting distance is shortened with the lens set at the wide-angle position or by employing the red-eye reduction flash feature.

Focus Lock Photography

Focusing is performed in the autofocus frame []. When the subject is not in the autofocus frame, use the focus lock to take the picture.

Focus Lock Operation

Place the subject in the autofocus frame [] and press the shutter release button halfway to focus. The subject will stay in focus as long as the shutter release button is kept at the halfway position and the green lamp is lit. Now recompose the picture and press the shutter release button fully down to take the picture. (See figure [10].)

- * The focus lock is released and the green lamp goes off when the shutter release button is released.
- * If you change the distance between the camera and the subject, release the focus lock and refocus.

Self-Timer Photography

This function allows the photographer to include himself in the picture.

As illustrated, when the self-timer button is pressed, the self-timer lamp lights up and the timer starts as soon as the button is pressed. The picture is taken 10 seconds after the button is pressed. (The lamp starts blinking during the final three seconds.) (See figure [11].)

- * If you want to cancel the self-timer after pressing the button, press the button once again or turn off the power.
- * The self-timer does not operate in dark places when the flash is not charged. Check that the green lamp lights up before using the self-timer.
- * The focus locks when the self-timer button is pressed. First place the subject in the autofocus frame [] and press the self-timer button to lock focus. Now recompose the picture.
- * Use of a tripod is recommended for self-timer photography.

Film Rewinding

The film is automatically rewound when the last picture is taken.

The film counter reverses and the motor stops automatically when the film is completely rewound. Make sure that the film counter indicates "S" before opening the back cover and removing the film. (See figure [12]~[13].)

Rewinding Film in Mid-roll

Open the lens protector and press the auxiliary rewind button with the adjuster pin on the strap to rewind the film in mid-roll. The motor stops automatically when the film is completely rewound.

Make sure that the film counter indicates "S" before opening the back cover and removing the film. (See figure [14].)

7



8

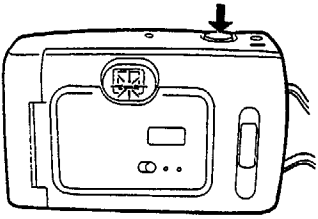

9

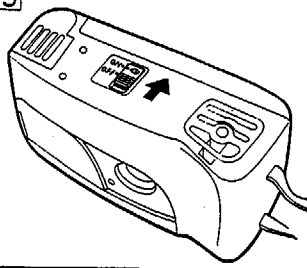

10

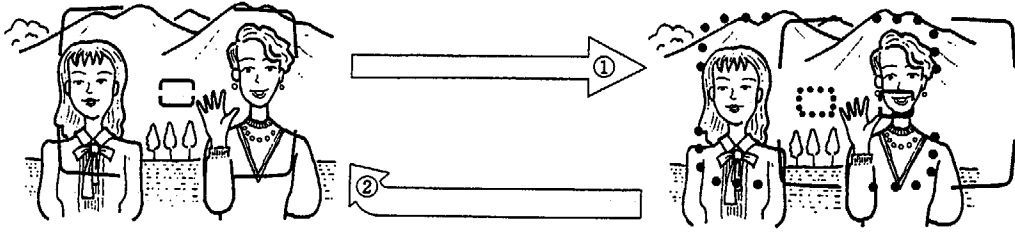

11

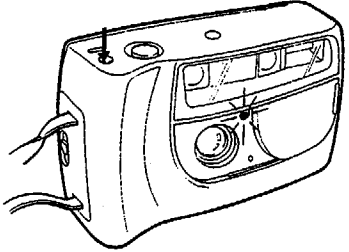

12

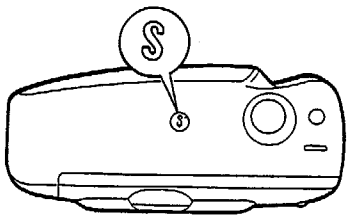

13

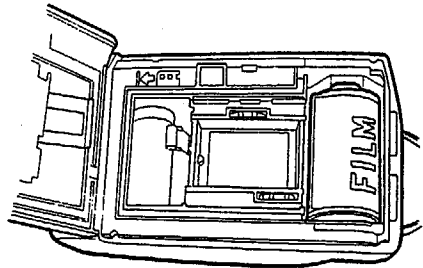

14

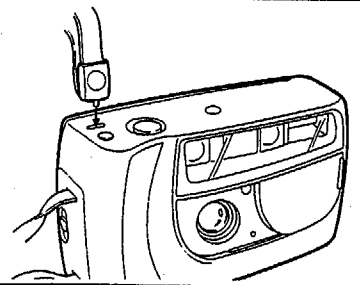



Asahi Optical Co., Ltd. 11-1, Nagata-cho 1-chome, Chiyoda-ku, Tokyo 100, JAPAN
Pentax Europe n.v. Weiveldlaan 3-5, 1930 Zaventem, BELGIUM
Pentax Handelsgesellschaft mbH. Julius-Vosseler-Strasse, 104, 2000 Hamburg 54, GERMANY
Pentax U.K. Limited. Pentax House, South Hill Avenue, South Harrow, Middlesex HA2 0LT, U.K.
Pentax France Z.I. Argenteuil, 12, rue Ambroise Croizat, 95100 Argenteuil, FRANCE
Pentax Benelux (for Netherlands) Spinveld 25, 4815 HR Breda, NETHERLANDS
(for Belgium & Luxemburg) Weiveldlaan 3-5, 1930 Zaventem, BELGIUM
Pentax (Schweiz) AG Industriestrasse 2, 8305 Dietlikon, SWITZERLAND
Pentax Scandinavia AB Falhagsleden 57, 75127 Uppsala, SWEDEN
Pentax Corporation 35 Inverness Drive East, Englewood, Colorado 80112, U.S.A.
Pentax Canada Inc. 3131 Universal Drive, Mississauga, Ontario L4X 2E5, CANADA
Asahi Optical Brasileira Ind. e Com. Ltda. Rua Estados Unidos, 1053, São Paulo, BRAZIL

57101

Copyright © Asahi Optical Co., Ltd. 1993
01-9304 Printed in Japan

Free Manuals Download Website

<http://myh66.com>

<http://usermanuals.us>

<http://www.somanuals.com>

<http://www.4manuals.cc>

<http://www.manual-lib.com>

<http://www.404manual.com>

<http://www.luxmanual.com>

<http://aubethermostatmanual.com>

Golf course search by state

<http://golfingnear.com>

Email search by domain

<http://emailbydomain.com>

Auto manuals search

<http://auto.somanuals.com>

TV manuals search

<http://tv.somanuals.com>