

PENTAX

PZ-20

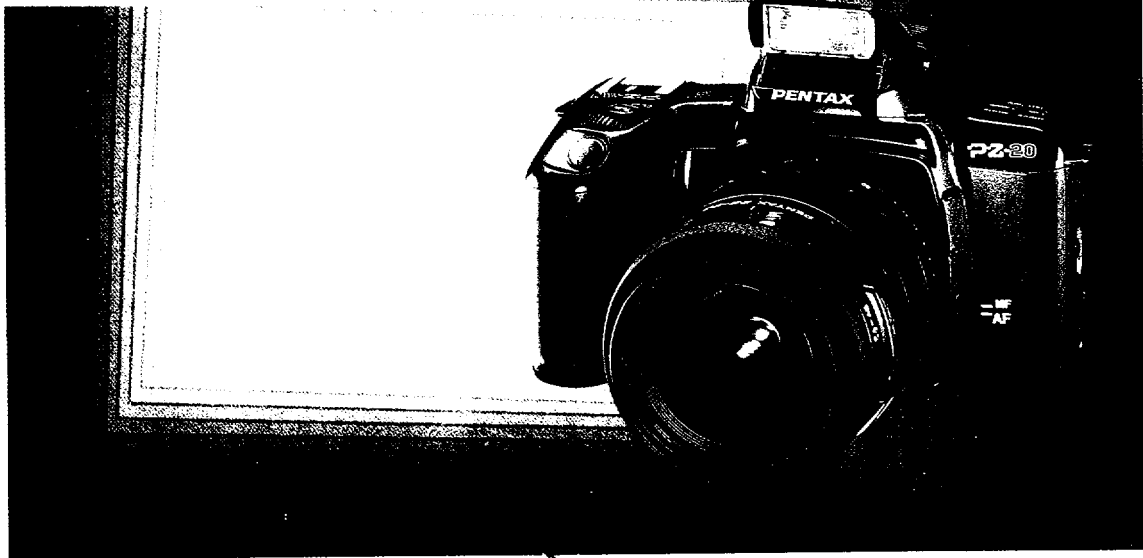



Congratulations on your purchase of this camera and welcome to the exciting world of Pentax autofocus SLR photography! This camera is a totally new breed of autofocus SLR camera that offers even higher levels of sophistication and performance. Incorporating a broad range of advanced technologies and highly accurate automation, this camera will perform superbly under difficult conditions to meet the demands of even the most exacting photographer. Combined with the dedicated Intelligent Power Zoom lenses, the state-of-the-art features such as Predictive Autofocus, Image Size Tracking and Zoom Clip Modes, Zoom Effect shooting capabilities are made possible. Also incorporated are Multi(6)-Segment Metering and Hyper Program Shift feature. With its unmatched performance, versatility and reliability, this camera is an outstanding AF SLR camera.

Read this instruction manual carefully to get a full explanation of the camera's functions and operations before use.

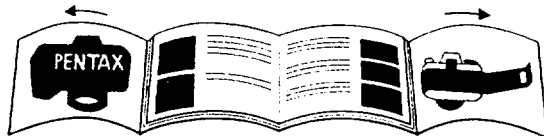

The names of the camera's working parts are listed on the front and back flaps in this manual. Keep the flaps unfolded for quick reference while reading this manual. We sincerely hope you will enjoy taking memorable photographs with this remarkable camera for many years to come.

Icon indicators used in this manual

Operation direction	←
Automatic operation	← ■ ■ ■ →
Attention	⊙
Lamp blinking	☀
Correct	○
Incorrect	×

Commercially available lenses and accessories produced by other manufacturers are not made to our precise specifications and therefore, may cause difficulties with, or actual damage to, your Pentax camera. We do not assume any responsibility or liability for difficulties resulting from the use of lenses and accessories made by other manufacturers.

NAMES OF WORKING PARTS

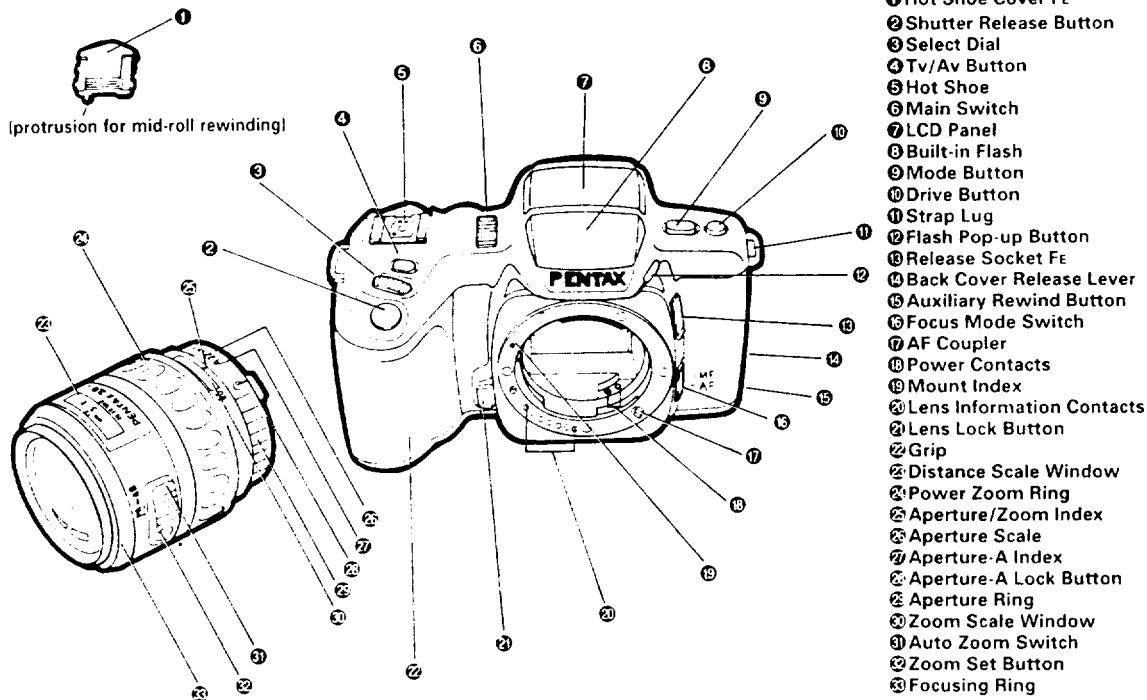
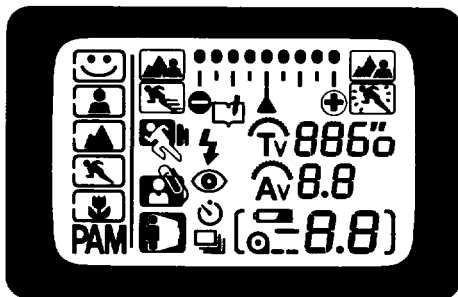

TABLE OF CONTENTS

LCD Panel Indication	2	Manual Focusing	43
Viewfinder Indication	3	Hard-to-Autofocus Subjects	45
Outline of Basic Functions	4	Selecting an Exposure Mode	46
Cameras and Lens Mounts	6	• Programmed AE Mode	48
Camera Functions Available with Various Lenses.....	7	• Shutter-Priority AE Mode	50
How To Use This Guide	8	• Aperture-Priority AE Mode	52
I. BASIC OPERATION (PREPARATION)	9~20	• Metered-Manual Mode	55
Attaching the Camera Strap	9	• Bulb Mode	58
Inserting the Battery	10	Exposure Compensation	60
Mounting the Lens	12	Selecting a Drive Mode	61
Using the Shutter Release Button	14	• Consecutive Photography	62
Main Switch Operation	14	• Self-timer Photography	62
Loading Film	15	Extended Power Zoom Function	64
Unloading Film	19	• Zoom Clip Mode	65
II. BASIC OPERATION (SHOOTING)	21~39	• Image Size Tracking Mode	67
Using the Picture Mode	21	• Zoom Effect	70
Setting the Green Operation Mode	22	Using the Built-in Flash	73
Selecting the Drive Mode	23	Pentax Functions	78
Using Zoom Lenses	24	A Dedicated Accessory Flash Unit	82
Holding the Camera	27	• Contrast Control Synch Flash	85
Selecting the Autofocus Mode	28	Accessories (Optional)	86
Using the Autofocus	28	• Dedicated Accessory	86
• Focus-lock technique	30	• Soft Case	87
Taking a Picture	31	Effect of Aperture and Shutter Speed	88
Using the Built-in Flash	31	Depth of Field	90
• "Red-Eye"	34	Infrared Index	91
Using the Picture Mode	35	OTHERS	92~100
• Portrait Program Mode	36	Precautions for Battery	92
• Landscape Program Mode	37	Precautions for Use	93~4
• Action Program Mode	38	Troubleshooting	96
• Close-up Program Mode	39	Specifications	98
III. ADVANCED OPERATIONS	40~94	Warranty Policy	102
Hyper Program-Shift	40		
Learning Function	42		

LCD PANEL INDICATION



- | | | | |
|----------|---------------------------------------|------------|--|
| P | : Programmed AE (p.48) | | : Bar Graph |
| A | : Shutter/Aperture Priority AE (p.50) | | : Learning Function (p.42) |
| | : Av (aperture) Indication | | : Tv (shutter) Indication |
| M | : Metered-Manual Exposure Mode (p.55) | | : Red-Eye Reduction Flash Function (p.34) |
| | : Image-Size Tracking Mode (p.67) | | : Consecutive Shooting (p.62) |
| | : Zoom Clip Mode (p.65) | | : Single-frame Mode (p.23) |
| | : Zoom Effect (p.70) | | : Self-timer Shooting (p.62) |
| | : Shutter-speed Indication | | : Flash Information (p.31) |
| | : Aperture Indication | 8.8 | : Frame Counter/Exposure Compensation |
| | : Green Operation Mode (p.22) | | : Film Status Information (p.17) |
| | : Portrait Program Mode (p.36) | | : Depth-of-field Indicator (deep)(p.40) |
| | : Landscape Program Mode (p.37) | | : Depth-of-field Indicator (shallow)(p.40) |
| | : Action Program Mode (p.38) | | : Action Indicator (increase in blur)(p.40) |
| | : Close-up Program Mode (p.39) | | : Action Indicator (reduction of blur)(p.40) |
| 2 | | | : Battery Exhaustion Warning (p.11) |

VIEWFINDER INDICATION

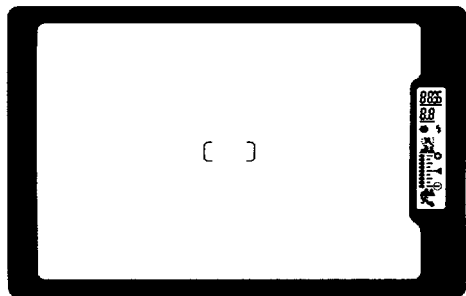

- [] : Autofocus (AF) Frame
- ⚡ : Flash Status Information
- : In-Focus Indicator
- 2000 : Tv Value (Shutter Speed)
- 32 : Av Value (Aperture Value)
- 🏃 : Action Indicator (increase in blur)
- 🏃 : Action Indicator (reduction of blur)
- 🏞 : Depth-of-field Indicator (deep)
- 🏞 : Depth-of-field Indicator (shallow)
- 📊 : Bar-Graph

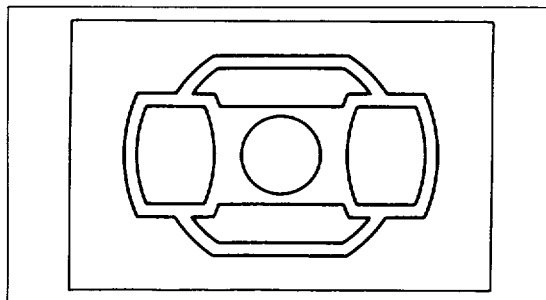

MULTI (6)-SEGMENT EVALUATION METERING FEATURE
Multi(6)-segment evaluation metering system is a method for obtaining optimal exposure of an image by dividing the image into partitions. With averaging metering methods, backlighting can cause a subject to be underexposed because the backlighting is also read into the overall metering. In contrast, Multi(6)-segment metering enables the camera to measure and compare light readings in segmented areas of the scene, thereby eliminating under-exposure of subjects. Multi(6)-segment metering system is a convenient automatic exposure feature that can be used under high-contrast, and difficult lighting conditions.

OUTLINE OF BASIC OPERATIONS

1. Installing the Battery

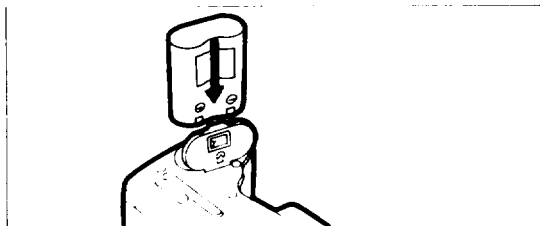

Open the battery chamber cover and install a battery [2CR5] in accordance with the diagrams inside the battery compartment. (See page 10.)

2. Mounting the Lens

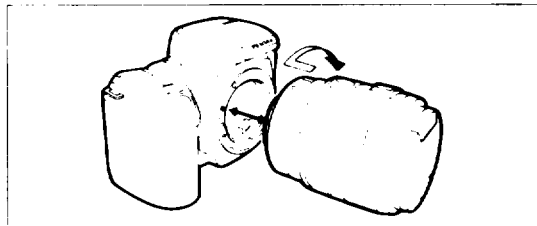

Align the red indexes on the lens and camera and turn the lens to the right until it seats with a click. (See page 12.)

3. Using the "A" (Auto) lens aperture

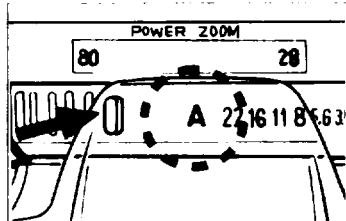

While holding the aperture A-lock button, turn the lens aperture ring to "A" (auto). (See page 22.)

④

4. Selecting the Power Zoom Mode

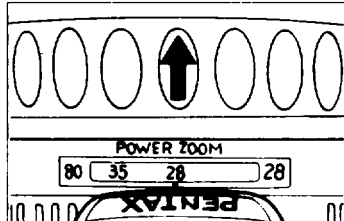

Push the power zoom ring forward until the words **POWER ZOOM** appear beneath the power zoom ring and set the Auto Zoom Switch to [P]. (See page 25.)

5. Selecting the Picture Mode

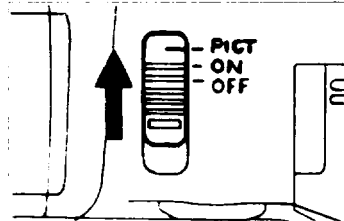

Move the camera's Main Switch to [PICT] to select the Green Operation Mode. (See page 22.)

6. Loading the Film

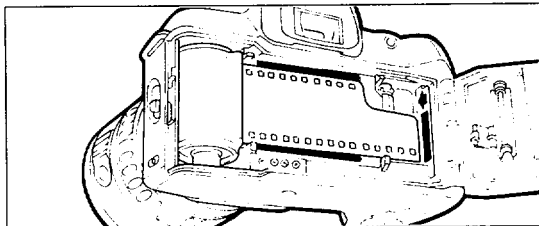

Open the back cover, insert the film, align the tip with the film leader end mark, then close the back cover. The film will automatically advance to the first frame. (See page 17.)

8. Composing the scene with the power zoom

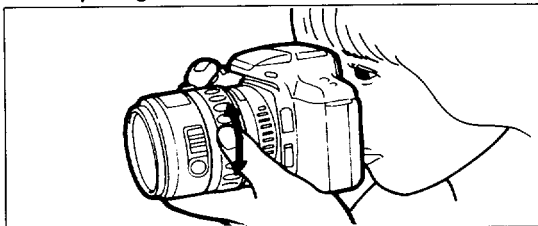

While looking through the viewfinder, turn the power zoom ring to the right or left until you obtain the desired composition. (See page 24.)

7. Selecting the Autofocus Mode

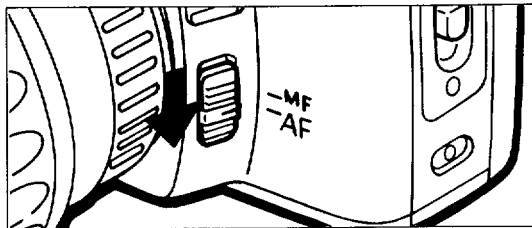

Move the focus mode switch to [AF]. (See page 28.)

9. Focus on the subject and shoot

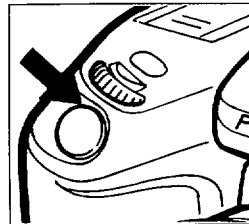

Aim the AF frame [] towards the subject, depress the shutter release button halfway down to lock focus, and then depress it fully to take a photo. (See page 28.)

⑤

CAMERAS AND LENS MOUNTS

Lens Mount and Camera Body Compatibility Chart

Mount Type	Lens Type	Camera Model
A. KAF2-mount	Pentax FA-lens	Z-10/PZ-10, Z-20/PZ-20, Z-1/PZ-1
B. KAF-mount	Pentax F-lens	SFX _N /SF1 _N , SF7/SF10
C. KA-mount	Pentax A-lens	Super A/Super Program, P30 _N /P3 _N , P30 _r
D. K-mount	Pentax M-lens/Pentax lens	LX, K1000
E. Screw mount	SMC TAKUMAR lens	ESII, SP

(A) through (D): basically K-mount lenses.

(A) and (B): autofocus lenses.

(C) through (E): non-AF (manual focus) lenses.

(E): Can be fitted to this camera with the optional Pentax "Mount Adapter K".

(A) though (C): Have "A" (auto) positions on the aperture rings.

Pentax FA lenses incorporate new power contacts to exchange

information between the camera and lens for power zoom.

Pentax FA-lenses operate on existing K-mount cameras.

Pentax FA-lenses incorporate

new contacts as follows in

addition to the contacts on the K-

mount cameras, offering existing

K-mount cameras compatibility.

- Power contacts
- AF coupler
- Lens-information contacts

K mount Lens Compatibility Chart

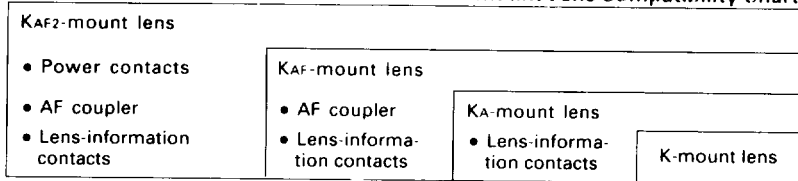

⑥

CAMERA FUNCTIONS AVAILABLE WITH VARIOUS LENSES

Function	Lens (Mount type)	FA lens [KAF2]	F lens [KAF]	A lens [KA]	M lens [K]	S lens [P]
Autofocus (Lens only) (Lens with AF Adapter 1.7X)		○	○	× ○ *1	× ○ *1	× ×
Manual focus (with FI)*2 (with Matte field)		○ *3	○ *3	○ *3	○ *3	× ○
Power zoom		○ *4	×	×	×	×
Zoom clip		○ *4	×	×	×	×
Image size tracking		○ *4	×	×	×	×
Auto zoom effect		○ *4	×	×	×	×
Programmed AE		○	○	○	×	×
Aperture-Priority AE		○	○	○	○ *5	○ *5
Shutter-Priority AE		○	○	○	×	×
Manual Exposure		○	○	○	○ *5	○ *5
Programmed TTL Auto Flash		○	○	○	×	×
TTL Auto Flash		○	○	○		
Learning Function		○	○	○	×	×
Picture Mode		○	○	○	×	×
Multi(6)-segment metering		○	○	○	× *6	× *6
Approx.f-stop indication		○	○	×	×	×

○ : Can be used × : Cannot be used

Notes:

- *1. Lenses with a maximum aperture of f/2.8 or larger (See AF Adapter instruction manual.).
- *2. Manual focusing using the focus indicator (FI) [] in the viewfinder.
- *3. Lenses with a maximum aperture of f/5.6 or larger.
- *4. Pentax-FA zoom lenses only.
- *5. When the lens aperture ring is set to "A" (auto), the aperture cannot be selected with the Select Dial.
- *6. When in the Aperture-Priority AE mode, the metering system is switched to Center-Weighted, while in the Metered Manual Exposure Mode, it is switched to Spot Metering System.

HOW TO USE THIS OPERATING MANUAL

This manual is organized into 4 chapters, allowing you to optimize the use of the camera.

I. PREPARATIONS (p.9)

II. BASIC OPERATIONS (p.21)

III. ADVANCED OPERATIONS (p.40)

IV. OTHERS (p.92)

- For the SLR camera beginners, start with the " PREPARATIONS" and "BASIC OPERATIONS" . These chapters will help you to become familiar with the general functions of the camera without getting into too much detail.

(1) STRAP ATTACHMENT

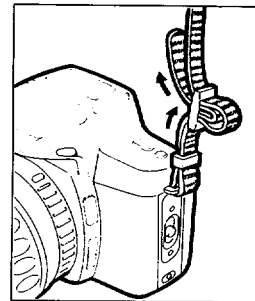
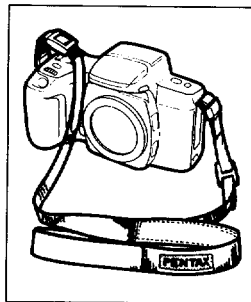

I. PREPARATIONS

Fit the strap on the camera as illustrated.

- To prevent the camera from swaying a lot while walking, adjust the strap so the camera rides above your waist.

(2) INSTALLING THE BATTERY

1

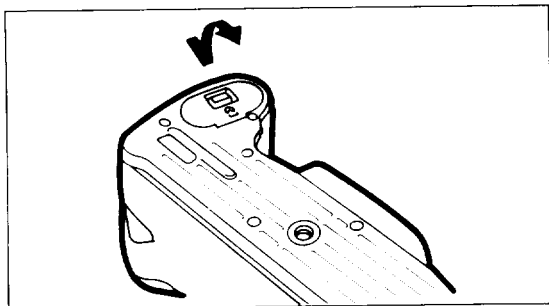

2

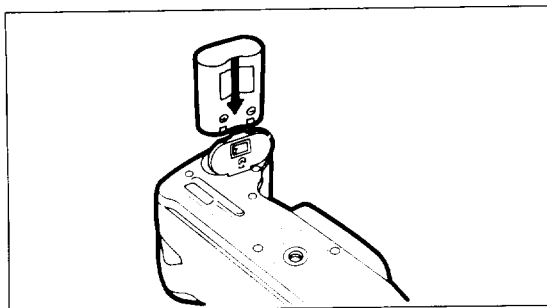

1. Open the battery chamber cover by pulling the cover lock in the direction of the arrow as shown.

- This camera operates on one lithium battery, type **2CR5**.

2. Insert the battery, making sure the plus/minus markings (+/-) match the diagrams inside the battery compartment. Then, reinstall the battery chamber cover.

3

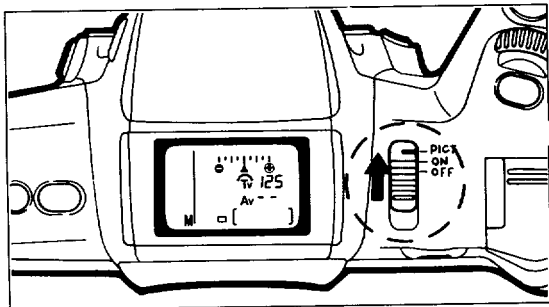

3. Move the camera's Main Switch to [PICT] or [ON] and confirm that the LCD screen appears as shown above.
- If the battery is loaded upside down, the LCD screen may be displayed as shown above; however, the shutter cannot be released. Insert the battery properly.

*

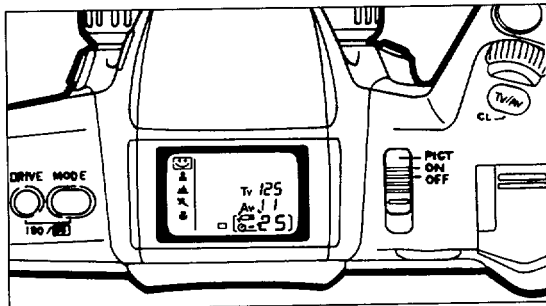

* BATTERY EXHAUSTION WARNING

When the battery is nearly exhausted, the battery symbol [] appears on the LCD panel to warn you. Replace the battery as soon as possible. When [] starts blinking, the shutter cannot be released.

- When the symbol [] starts blinking on the LCD panel, all indications disappear in the viewfinder.
- When the battery is replaced, all camera settings other than the exposure counter indication, film speed setting (ISO), Pentax Function settings, and the contents of learning function stored in memory return to the initial settings.

11

(3) MOUNTING THE LENS

1

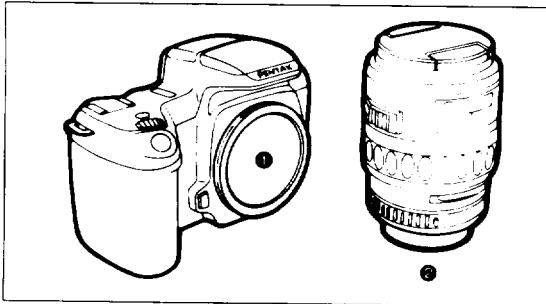

2

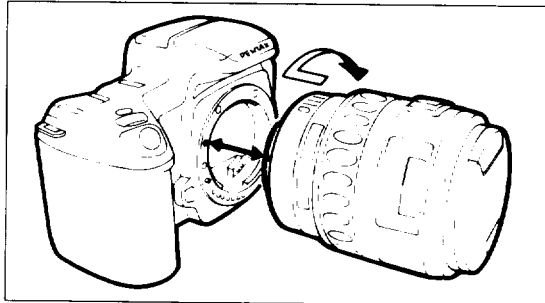

1. Remove the body mount cap ① and rear lens cap ② as shown.
 - The body mount cap is designed to protect the camera against scratches and dust at the factory. For storage purposes after purchase, use the optional accessory "Body Mount Cap K".
 - Ensure that the camera's Main Switch is off before mounting the FA zoom lens to prevent the unexpected operation of the zoom lens.

2. Align the red dots on the camera and the lens. Mount the lens on the camera, and then turn it fully to the right until it locks with a firm click.

3

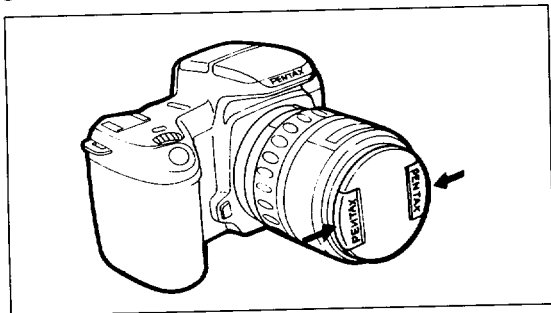

3. To remove the front lens cap, press in the tabs on both sides in the direction of the arrows.

- We assume no responsibility or liability for damages resulting from the use of lenses made by other manufacturers.
- The camera mount and lens mount bear the lens information contacts and AF coupler. Water, dirt, dust or mold at electrical contacts may often cause damage to the electrical system. If the mounts are dirty or smudged, wipe gently with a clean, soft, and dry cloth.

*

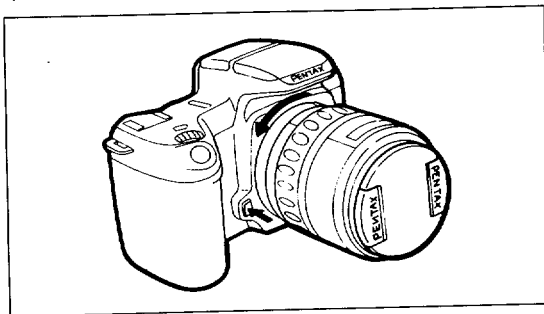

* Removing the Lens

To remove the lens, turn the lens to the left while depressing the lens-lock-release button.

- To protect the contacts and AF coupler of the lens against damage after removal, be sure to set the lens down with the mount side facing upward.

(4) USING THE SHUTTER RELEASE BUTTON (5) MAIN SWITCH OPERATION

The shutter release button has two positions. Depressing it halfway down (first position) turns on the exposure meter and autofocus mechanism. Depressing it fully (second position) allows you to release the shutter. When taking a photograph, gently depress the shutter release button to prevent camera shake.

- To learn where the first position is, depress the shutter release button halfway down before loading a roll of film.
- The exposure meter stays on for about 10 seconds after the button is released from the halfway position. Holding the shutter release button depressed halfway down keeps the exposure meter activated.

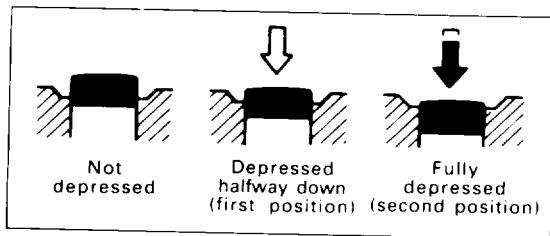

14

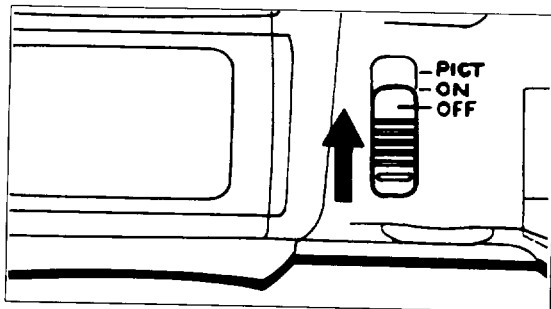

The camera's Main Switch has three positions.

- [**PICT**] = Provides 5 Picture Modes including fully automatic mode (Green Operation Mode) when the lens aperture ring is set to "A".
- [**ON**] = Full-feature mode: All the camera functions except for the Picture Mode are available.
- [**OFF**] = When the camera is not in use, move the camera's Main Switch to this position.

(6) LOADING FILM

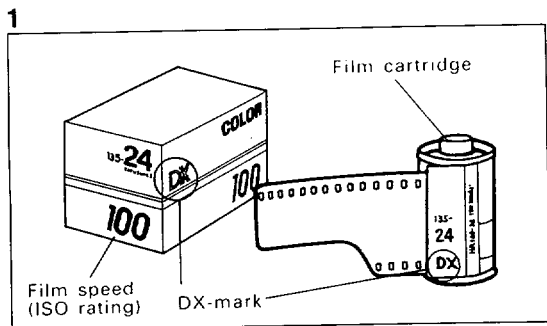

- We suggest that you first operate the camera with no film loaded to become familiar with its operations.
1. When DX-coded film with ISO ratings from 25 to 5000 is loaded, the film speed is automatically set for the camera.

CAUTIONS

- THE SHUTTER CURTAINS ARE FINE-PRECISION MATERIAL. DO NOT TOUCH THEM WITH YOUR FINGERS OR ANYTHING WHILE LOADING FILM.
- Always load or unload film in the shade or by using your body to shade the camera.
- When using non-DX-coded film, set the film speed manually. (See page 80.)

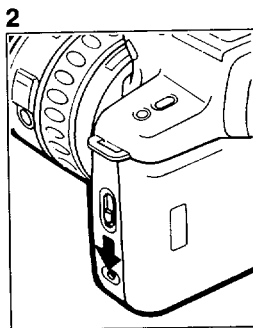

2. To open the back cover, slide the back-cover-release lever in the direction of the arrow.
3. Place the film cartridge in the film chamber by fitting its flat side on top of the rewind shaft first and then slide the top end into the camera.

- Before loading film for the first time after purchase, open the back cover and remove the protective card as shown in the photo. **MAKE SURE NOT TO TOUCH THE SHUTTER CURTAINS.**

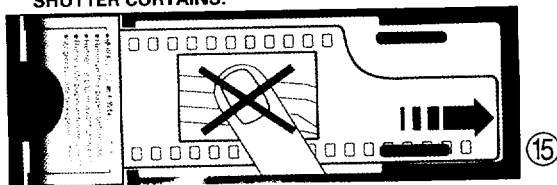

4

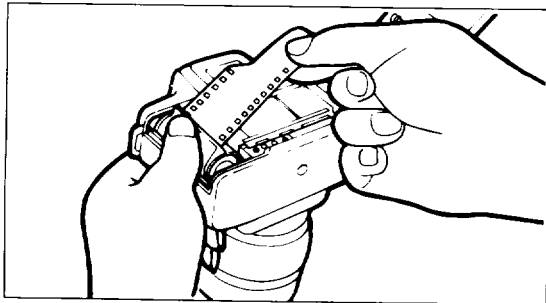

4. Hold the film cartridge with your fingers and pull the film leader out far enough from the cartridge to reach the take-up spool as shown in the illustration. Ensure that your fingers or the end of the film leader does not touch the shutter curtains. If you have pulled out too much film, push it back into the cartridge to reduce the slack.

 - The DX information pins in the film chamber are used to read film speed. Keep them clean and free from scratches. To remove smudges, wipe gently with a soft, dry cloth.

5

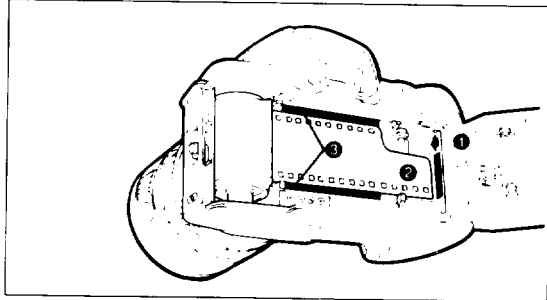

5. Align the film tip with the film leader end mark ① as shown.

 - Ensure that the film is placed properly between the guide rails ③. Make sure that the film perforations properly engage the sprocket teeth ②.

Slack

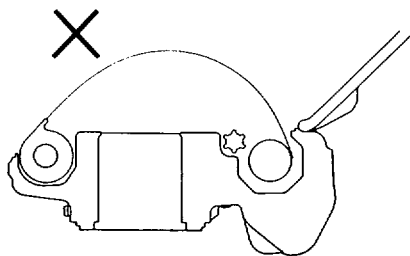

Flat

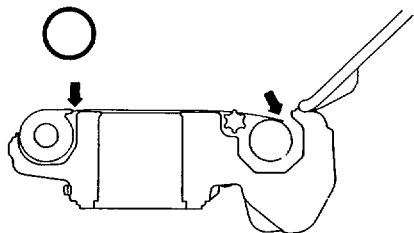

- If the film leader is extremely bent, straighten it or cut off the bent portion.

6

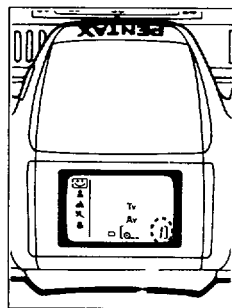
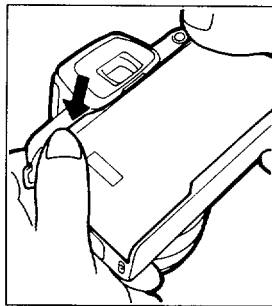

6. Close the back cover and move the camera's Main Switch to [**ON**] or [**PICT**], and the film automatically advances to the first frame. Confirm that [;] and [0...] are displayed on the LCD panel.
- The film counter indication advances one each time the shutter is released to expose the frame.

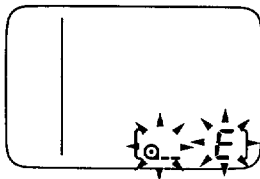



- If the film is not properly loaded, [0... E] blinks on the LCD panel. If this occurs, reload the film.

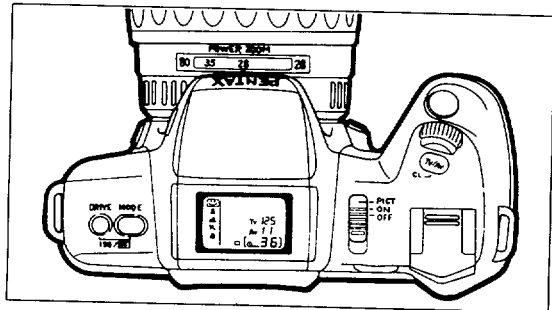

(7) UNLOADING FILM

1



1. After the last frame of the roll is exposed, the camera rewinds the film automatically.
- During rewinding, [] blinks on the LCD panel and the exposure counter counts frame numbers in reverse.
- Never open the back cover during rewinding.
- Remove the film from the camera in the shade or by using your body to shade the camera to prevent the film from being exposed to direct sunlight.

2

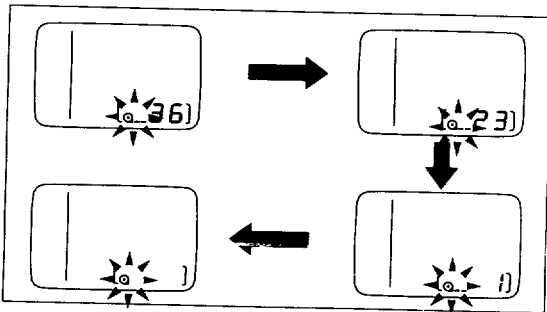

2. When the roll of film is rewound to its end, [] blinks and the exposure counter indication disappears, informing you that the back cover may be opened.

3

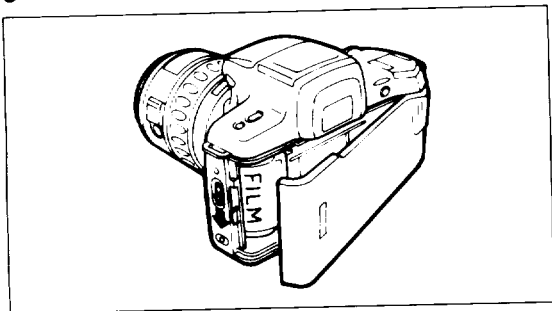

3. Open the back cover and remove the film.
 - A roll of 24-exposure film takes about 15 seconds to be rewound.
 - When the camera is not in use, set the camera's Main Switch to [OFF].
 - Ensure that the [] blinks on the LCD panel before opening the back cover.
 - The shutter may be released a frame or two even after the specified number of frames have been used up as indicated by the number of shots on the film canister. However, those extra frames may be lost in the processing.
 - If the camera stops rewinding due to battery exhaustion, exchange the battery without opening the back cover.

20

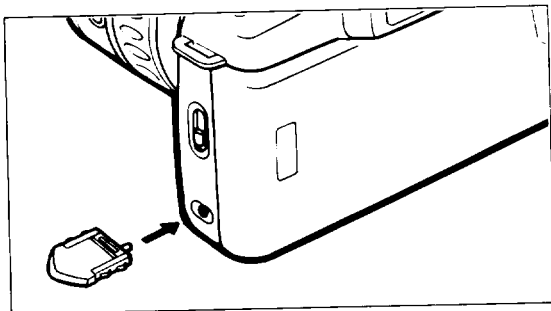

REWINDING A ROLL OF FILM IN MID-ROLL

If you wish to unload the film before exposing all the frames, use this function. First, turn on the camera's Main Switch, and then depress the auxiliary rewind button with the protruding section of the Hot Shoe Cover Fe. Rewinding starts. Ensure that [] blinks on the LCD panel before opening the back cover to remove the film.

- This function does not work when the camera's Main Switch is in the [OFF] position.

II. BASIC OPERATIONS

(1) USING THE PICTURE MODE

This camera comes with advanced automatic exposure modes. This section deals with the fully-automatic Green Operation Mode. See "ADVANCED OPERATIONS" starting on page 35 for advanced exposure modes.

- The Green Operation Mode sets the camera for fully automated shooting, allowing you to use its advanced features with ease. The camera automatically selects the shutter speed and aperture according to the subject brightness.

1

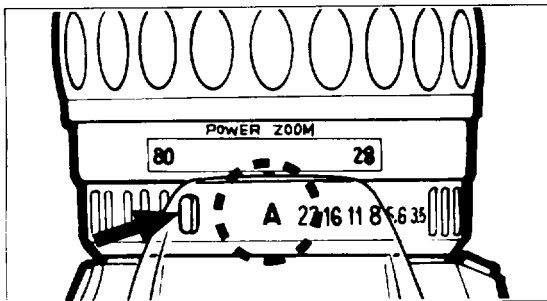

Selecting the Green Operation Mode

1. While holding down the aperture-A lock button, turn the aperture ring to "A" (Auto) as shown.
 - To move the lens aperture to "A" (auto) or to a manual f-stop setting, hold down the aperture-A lock button to turn the aperture ring.

2

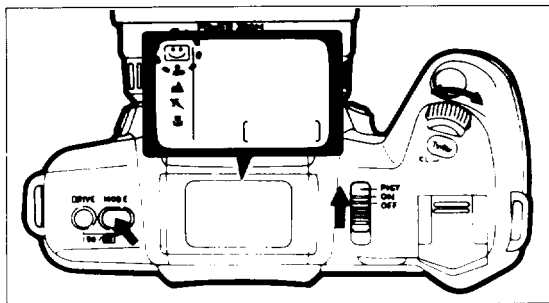

2. Move the camera's Main Switch to [PICT]. Turn the Select Dial while holding down the Mode Button until [A] superimposes on [😊] on the LCD panel.
 - The exposure compensation and Hyper Program Shift do not work in the Green Operation Mode.

(2) DRIVE MODE

The camera offers three drive modes as shown.

- | □ | = Single-frame drive:
The shutter is released each time the shutter release button is depressed.
- | 📷 | = Continuous drive:
The photos are taken consecutively as long as the shutter release button is kept depressed.
- | ⌚ | = Self-timer:
The shutter is released with 12-second delay after the shutter release button is fully depressed.

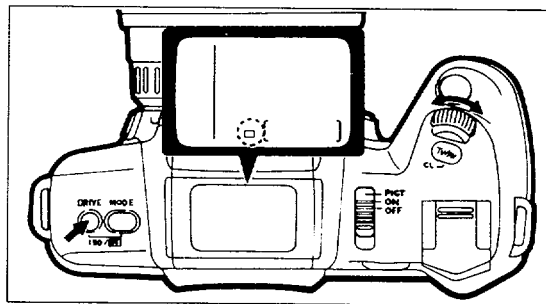

CHANGING THE DRIVE MODE

The desired drive mode can be set by turning the Select Dial while depressing the Drive Button. To begin, select the Single-Frame mode.

(3) USING ZOOM LENSES

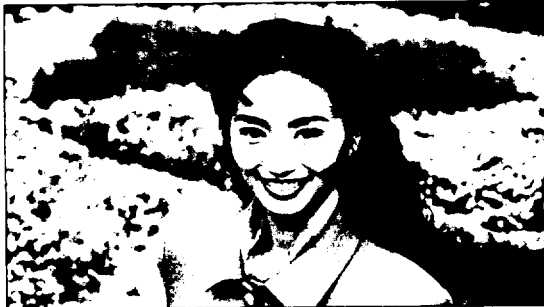

Telephoto



Wide angle

Using the zoom function makes the subject appear larger (telephoto) or smaller (wide angle) in the viewfinder. Turn the zoom ring to the desired position and depress the shutter release button to take a photograph.

- The smaller the number shown in the zoom scale window, the wider the angle. Conversely, the larger the number, the more magnified the image appears.
- When combined with the Pentax-FA Zoom lens, this camera allows the use of the power zoom function.
- When mounting an existing Pentax-F Zoom lens, this camera can be used only in the manual zoom mode.

1

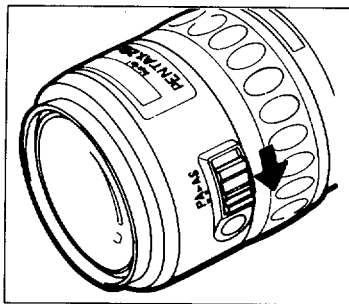

2

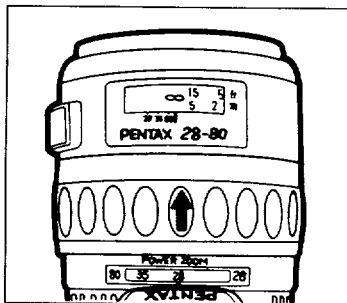

3

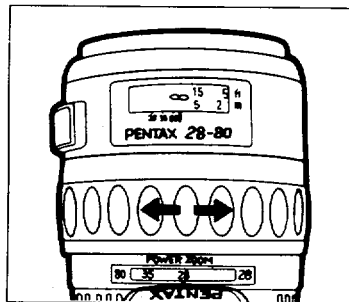

Using the Power Zoom Function

- Only Pentax-FA Zoom lenses offer the power zoom function.
1. Pentax-FA Zoom lenses have an auto zoom switch. Set this switch to [P].
 2. Push the power zoom ring forward until the words **POWER ZOOM** appear beneath the power zoom ring.
 - The lens comes from the factory with the power zoom ring set at this position.
 3. Turning the power zoom ring to the right brings the subject closer (telephoto) and turning it to the left makes the subject appear smaller (wide angle). To stop zooming, release the power zoom ring. The zoom lens zooms in and out at one of the three speeds according to the degree of rotation. Turning the power zoom ring fully to the right or

left zooms the lens quickly, while turning it slightly gives slow operation. At an intermediate position, the lens zooms at medium speed.

- Zooming the lens with the power zoom function automatically focuses the lens on the subject. This function can be overridden with Pentax Function No. 2. However, for final composition, depress the shutter release button halfway down to focus on the subject.
- When the camera's Main Switch is turned off, the automatic lens retraction system retracts the FA Zoom lens in use to the shortest physical length. The focusing ring also turns to the ∞ position (except Pentax FA zoom 100-300mm and 250-600mm lenses).

1

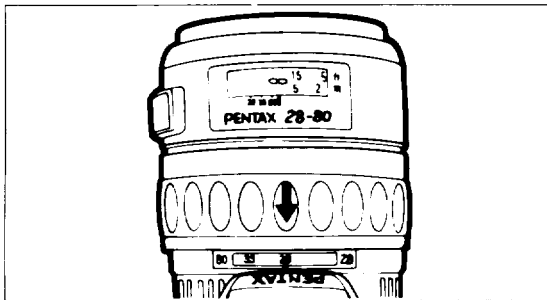

Using the Manual Zoom Function

When the zoom ring is pulled toward the camera body, the zooming mode is switched to manual; zooming can be operated manually using the same ring. When switched to manual zooming, FA Zoom lenses work in a manner similar to the existing Pentax F lenses.

2

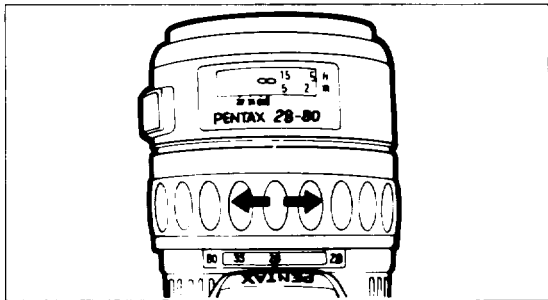

1. To set the manual zoom mode, pull the zoom ring towards the camera body until the words **POWER ZOOM** are hidden.
2. Turning the zoom ring to the right zooms the lens to the tele-position, while turning it to the left zooms the lens to the wide-angle setting. When the lens is zoomed to the desired setting, depress the shutter release button fully to take a photograph.

(4) HOLDING THE CAMERA

Camera held horizontally

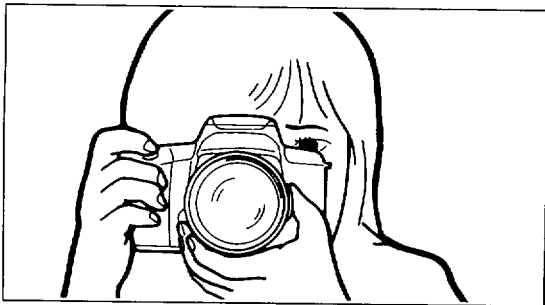

Camera held vertically

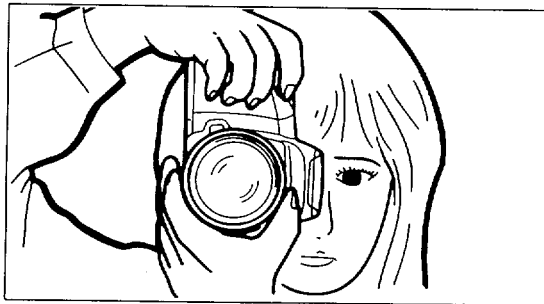

To ensure optimum results, proper camera handling is important.

- When taking a photograph, hold your breath and gently depress the shutter release button. Sudden force on the shutter release button will cause camera shake, making the picture blurred.
- To reduce camera shake, brace your elbows against your body or support yourself and the camera against a stable, stationary object, such as a tree or a wall.

- When taking a photograph at slow shutter speeds of 1/30 or slower or when using a telephoto lens, a tripod and the optional "Cable Switch F" are recommended.
- When using an ultra-telephoto lens, a tripod that is heavier than the total weight of the camera and lens is recommended to avoid camera shake.

(5) SELECTING AN AUTOFOCUS MODE (6) USING THE AUTOFOCUS

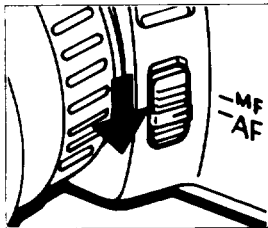

The focus mode switch has two positions as shown in the illustration. For autofocus operation, set the focus mode switch to [AF].

Focus Modes

- [**AF**] = Autofocus
When you depress the shutter release button, the lens automatically focuses on the subject. When the subject is brought into focus, the shutter can be released. For normal use, slide the focus mode switch to this position.
- [**MF**] = Manual focus
Select this position to focus on a subject manually. Set the focus mode switch to [**MF**] when a subject is difficult to achieve autofocus. (See page 45.)

1



2

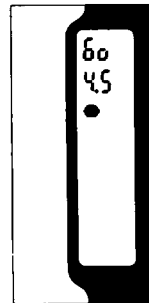

1. Aim the AF frame [()] in the center of the viewfinder toward the subject.
2. When the subject is in focus while the shutter release button is depressed halfway down, the in-focus indicator lights up in the viewfinder, with the audible PCV signal indicating focus confirmation.
 - Audible PCV signal can be canceled by selecting the silence mode with Pentax Function No. 3. (See page 80.)
 - During an autofocus operation, the zoom lens rotation should not be obstructed in any way with your fingers, hands, or any other object.
 - If the in-focus indicator continues blinking, it indicates that the subject is hard to achieve autofocus for the following reasons.
 - ① The subject is too close.
 - ② The subject fools the autofocus system. (See page 45.)

3. Depress the shutter release button fully to take photos.
 - The shutter cannot be released until the camera has confirmed sharp focus.
 - The focus remains locked as long as the in-focus indicator is lit after half-depression of the shutter release button. See "Focus-Lock Technique" on page 30.
 - To reset the focus or focus on another subject, lift your finger from the shutter release button and focus on the desired subject by depressing the shutter release button halfway down.
 - When using the SMC Pentax F Soft 85mm f/2.8 lens, set the lens to an aperture between f/2.8 and f/4.5. (See page 45.)
 - When the subject is out of the AF frame, use the focus-lock technique to focus on the subject. (See page 30.)

Predictive AF Mode

When the camera senses subject movement during an autofocus operation, the camera will automatically switch the focus mode to predictive autofocus to measure the speed of a fast-moving subject, and predict where it will be at the moment of shutter release, to maintain sharp focus on whatever the subject.

- If the subject is moving too fast, the shutter may not be released.

1



2



3

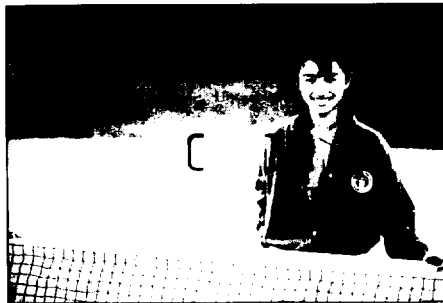

Focus Lock Function



Focusing is established with the AF frame in the center of the viewfinder. When the main subject is off the AF frame in the center of the viewfinder, use the focus-lock technique to bring the main subject into focus.

1. When the composition does not allow the AF frame [] in the center of the viewfinder to focus on the subject as shown in the photo, depressing the shutter release button halfway down will bring only the background into focus.
2. Aim the AF frame towards the subject and keep depressing the shutter button halfway down. The in-focus indicator remains on, indicating that the subject distance is stored into memory.

3. While holding the shutter release button halfway down, return to the original composition, and then fully depress the shutter release button to take a photograph.
 - Lifting your finger from the shutter release button clears the in-focus indicator in the viewfinder and cancels the focus lock.
 - When changing the camera-to-subject distance, clear the focus lock by lifting your finger from the shutter release button, and then use the focus-lock technique again.
 - Focus lock is unlocked after the shutter is released.

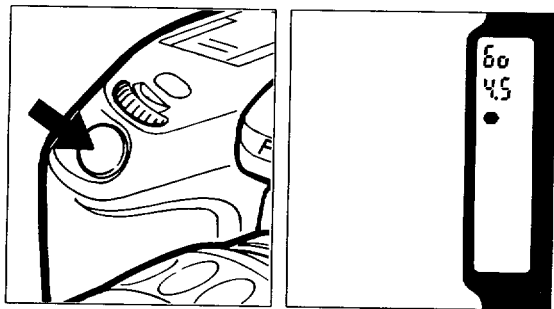
(7) TAKING A PHOTO



When the shutter release button is depressed halfway down, the shutter speed and aperture setting are displayed in the viewfinder and on the LCD panel. To release the shutter, depress the shutter release button fully. The camera automatically winds the film and the exposure counter indication advances by one. If the subject is dark or backlit, the flash-recommended indicator [] blinks in the viewfinder, advising use of flash. [] also blinks on the LCD panel.

- When [] appears to recommend using flash, use the built-in flash (See page 32.).

(8) USING THE BUILT-IN FLASH (RTF)

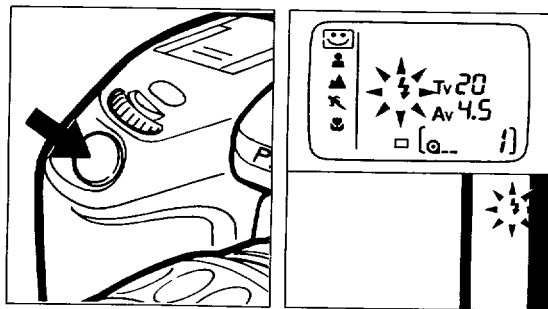

The Flash-Recommended Indicator []

When a subject is shot in dark or in a backlit situation in the Programmed AE (including the Picture Mode) or Aperture-Priority AE mode, the flash-recommended indicator blinks in the viewfinder and on the LCD panel to recommend the use of the built-in flash. In the Shutter-Priority AE Mode, the flash-recommended indicator appears only when a subject is shot in a backlit situation.

1

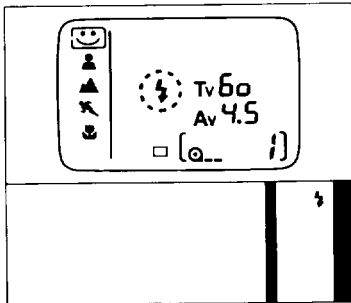
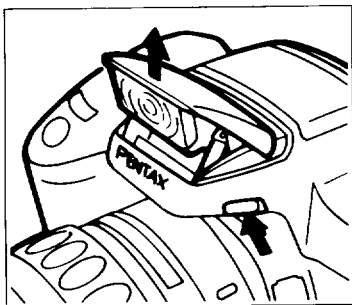

2

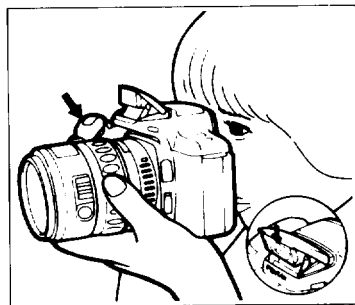

1. Push the flash pop-up button to activate the flash .

- The flash unit starts charging automatically. When it is fully charged, [⚡] appears on the LCD panel. In addition, when the shutter release button is depressed halfway down, [⚡] appears in the viewfinder.
- When the built-in flash is in use in the Picture Mode, the bar graph will not appear in the viewfinder and on the panel.

- When the shutter release button is depressed half-way down, the flash-synch shutter speed and aperture setting will appear in the viewfinder and on the LCD panel.
2. Depress the shutter release button fully, and the flash unit discharges. After using flash, retract the built-in flash by pressing it down into the camera body.

[With ISO100 film]

Maximum lens aperture	Distance
f/1.4	Approx. 0.9-4.6m (3.0-15.1ft.)
f/2	Approx. 0.8-3.9m (2.6-12.8ft.)
f/2.8	Approx. 0.7-3.3m (2.3-10.8ft.)
f/3.5, f/4.7	Approx. 0.7-2.7m (2.3-8.9ft.)
f/5.6	Approx. 0.7-2.3m (2.3-7.5ft.)

Effective Range for Programmed TTL Auto Flash (at ISO100)

The effective flash range depends on the maximum aperture of the lens in use. A lens with a maximum aperture of f/1.4 is marked as 1:1.4 on its barrel.

- In the Picture Mode or Programmed AE mode, the built-in flash works as a Programmed TTL Auto flash.
- The minimum distance for the Programmed TTL flash is always approx. 0.7m even when a lens with a maximum aperture of f/4.5 or smaller is in use.
- When a subject is shot at a distance closer than 0.7m, correct exposure is not obtained, and you will see vignetting in the picture corners.

Notes on Flash Usage

Inappropriate Lens Warning

When using the F- or FA-lenses listed below or other F- or FA- lenses unsuitable for use with the built-in flash, [$\frac{1}{2}$] and [$\frac{1}{4}$] will blink respectively in the viewfinder and on the LCD panel when the shutter release button is depressed halfway down after the flash has been charged.

- Lenses wider than 28mm
- Lenses with the focal length 300mm or longer (except when using the FA Zoom 100-300mm at a focal length of 300mm)

Taking a picture while this warning is displayed will cause vignetting in the picture corners or semi-circular vignetting at the bottom of the picture. When using lenses other than FA- and F-lenses, keep in mind that these indicators do not blink.

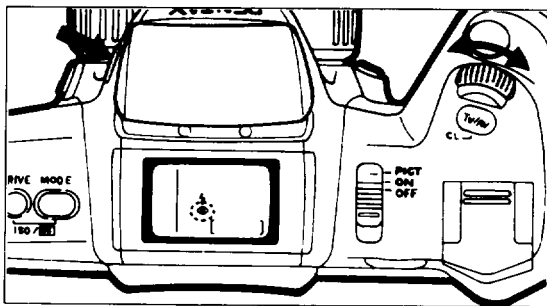

- Do not use a lens hood as it may obstruct the light coming from the flash.
- Shooting subjects with an FA 24-50mm zoom lens at the focal length between 28-35mm does not cause vignetting in the picture corners, though the inappropriate lens warning [$\frac{1}{2}$] appears.
- Shooting subjects at a distance closer than 1m with an FA Zoom 28-105mm lens in the wide-angle range (35-40mm) in tandem with the built-in flash may cause vignetting in the picture corners, though the inappropriate lens warning [$\frac{1}{2}$] is not displayed: take a picture at a distance of 1m or longer in this case.



Red-eye Reduction Flash Function

This camera includes a red-eye reduction flash function, which reduces the red-eye phenomenon by using preflash.

How to Set

Press the flash pop-up button and continue to keep pressure on this button until all the indications other than [] disappear. Then, turn the Select Dial until [] appears on the LCD panel.

Notes:

- When the RTF's red-eye reduction flash function is used in conjunction with the slave-synch flash of a dedicated accessory flash unit such as AF500FTZ, the built-in RTF's preflash sends a synch signal, causing the accessory flash to discharge. Therefore, when using slave-sync flash function, do not use the red-eye reduction flash feature.
- When using only a dedicated accessory flash unit, the red-eye reduction flash feature does not function even if [] is displayed on the LCD panel.

Red-Eye Phenomenon in Flash Shooting

Shooting portraits with flash in a dark environment often results in the subject's eyes to turn out reddish in the print. This phenomenon, commonly known as "red-eye", is caused by the reflection of the electronic flash in the retinas. It can be reduced by taking a photo in a brighter light condition or by shooting with a wider angle lens at a closer distance when using a zoom lens, or by employing the red-eye reduction flash feature. When using a Pentax dedicated accessory flash unit off the camera, it may also help to position the flash as far away from the camera as possible.

(9) PICTURE MODE

1

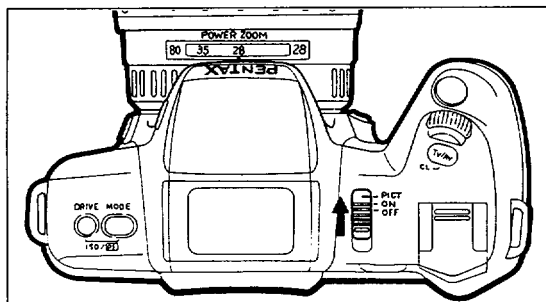

2

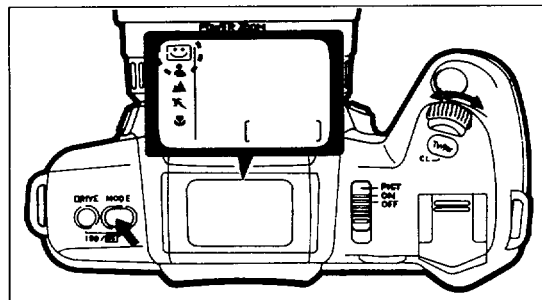

The Picture Mode has a total of 5 modes, including the fully-automatic Green Operation Mode, Portrait Program, Landscape Program, Action Program and Close-up Program modes, allowing you to use these highly advanced photographic techniques effortlessly. See "Green Operation Mode" on page 22.

Procedure

1. Move the camera's Main Switch to [PICT].
2. To set the desired mode, turn the Select Dial while holding down the Mode Button.

To the left

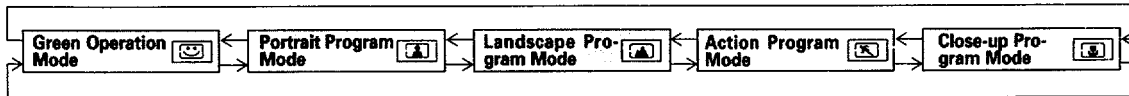

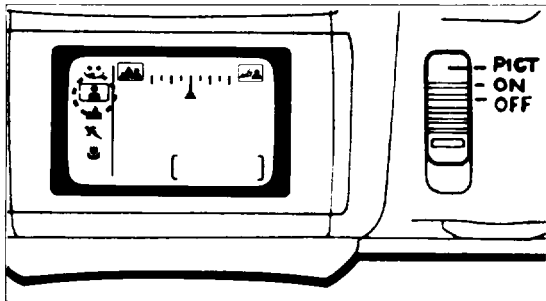

To the right

Portrait Program Mode []



This mode is excellent for taking a portrait. The telephoto lens produces a portrait in crisp focus against the out-of-focus background, while the wide angle lens enables you to shoot group portraits in sharp and clear focus with the extended depth-of-field.

To set this mode, turn the Select Dial while holding down the Mode Button until the rectangle [] superimposes on [].



- The in-focus range (depth-of-field) can be increased or reduced with the Select Dial as desired. See "Hyper Program-Shift" on page 40.

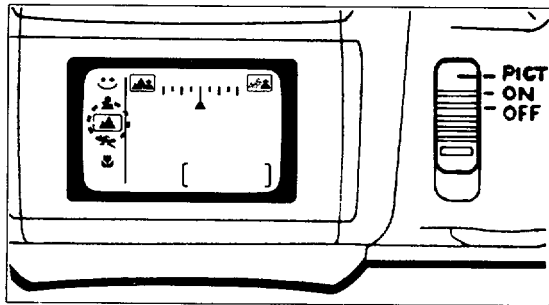

Landscape Program Mode []



This mode ensures that the foreground, middle and background are focused sharply throughout the image field, making it ideal for landscapes and scenic snapshots.



To set this mode, turn the Select Dial while holding down the Mode Button until the rectangle [] superimposes on [].

- The in-focus range (depth-of-field) can be increased or reduced with the Select Dial as you desire. See "Hyper Program-Shift" on page 40.

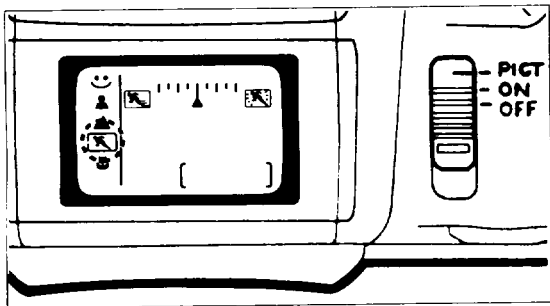
Action Program Mode []



This mode selects a faster shutter speed to capture a subject in motion. It freezes the action and prevents blurred images. This mode is especially convenient for active photography. It is also suitable for portraits with a blurred background, or for action photography while "panning" the subject when wishing to blur/streak the background.

To set this mode, turn the Select Dial while holding down the Mode Button until the rectangle [] superimposes on [].

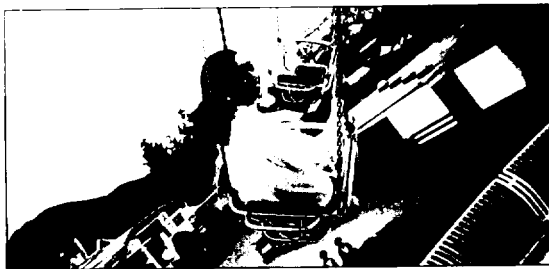

- The image blur can be increased or reduced with the Select Dial as it suits you. See "Hyper Program-Shift" on page 40.

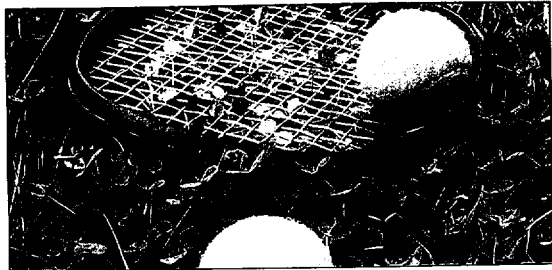
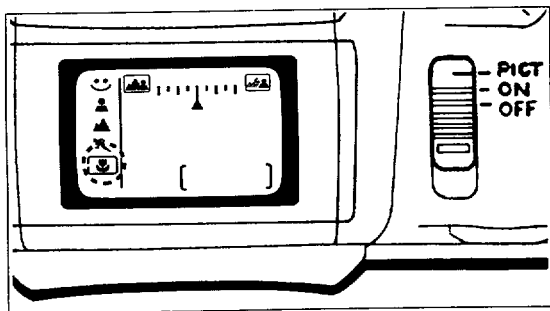

Close-up Program Mode []



This mode is extremely useful for close-up photography. It favors smaller apertures to maximize the depth of field, ensuring sharp focus of a close-up subject.

To set this mode, turn the Select Dial while holding down the Mode Button until the rectangle [] superimposes on [].

- The in-focus range (depth-of-field) can be increased or reduced with the Select Dial as you desire. See "Hyper Program-Shift" on page 40.

(1) HYPER PROGRAM-SHIFT

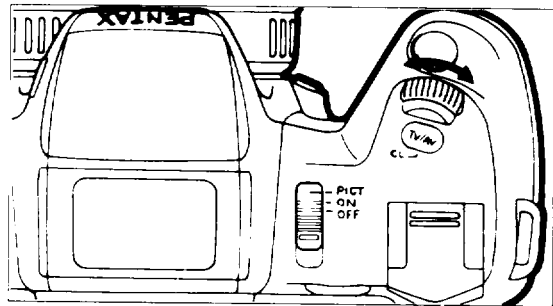

III. ADVANCED OPERATIONS

In each Picture Mode (except the Green Operation Mode), the in-focus range (depth of field) and the extent of image blur can be easily changed by turning the Select Dial, which allows you to create distinctive visual effects or alter the effects drastically. The shifted amount is confirmed by dots on the bar graph in the LCD panel.

- Hyper Program-Shift works effectively within the shutter speed/aperture combination coupling range for correct exposure control.
- Hyper Program-Shift is possible in the Programmed AE mode (See page 40.) However, the bar graph is not displayed in this case.
- Hyper Program-Shift is not canceled after the shutter is released.
- The learning function works when the Hyper Program-Shift is executed.
- Removing the lens resets the Hyper Program-Shift.

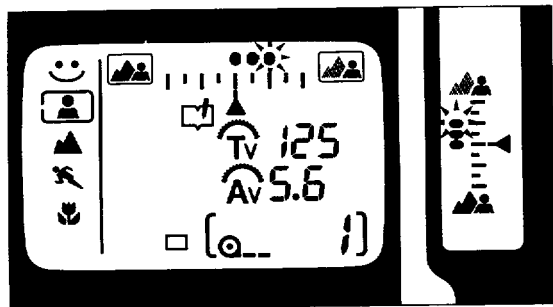

In Portrait Program, Landscape Program and Close-up Program Mode

To reduce the in-focus range, turn the Select Dial to the right. Dots will successively appear to the right on the LCD panel and to the top in the viewfinder, indicating the shift to a narrower in-focus range. To widen the in-focus range, turn the Select Dial to the left. Dots will successively appear to the left on the LCD panel and to the bottom in the viewfinder, indicating the shift to a wider in-focus range.

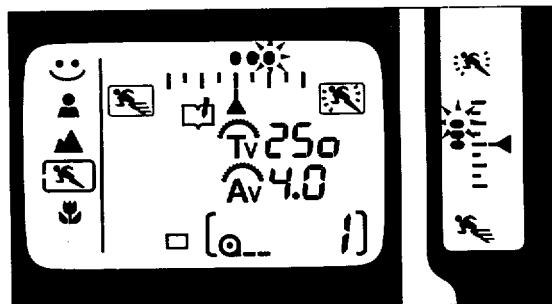



In Action Program Mode

Turning the Select Dial to the right reduces image blur. Dots will successively appear to the right on the LCD panel and to the top in the viewfinder, indicating the shift to a reduced image blur. To increase the image blur, turn the Select Dial to the left. Dots will successively appear to the left on the LCD panel and to the bottom in the viewfinder, indicating the shift to an increased image blur.

- The selection of Hyper Program-Shift is indicated with [\curvearrowright] above Tv and Av mark on the LCD panel and with a bar underneath an aperture and shutter speed in the viewfinder.
- To cancel the Hyper Program-Shift, depress the Tv/Av Button.
- If the selection of Hyper Program-Shift exceeds the range of the bar graph, all five dots to the selected shift side light up continuously.

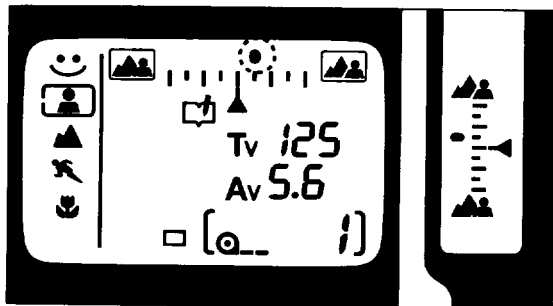
(2) LEARNING FUNCTION



- Each time the shutter releases, [] blinks on the LCD panel, indicating that the learning function is being activated.
- This function does not work unless [] appears on the LCD panel.
- The shifted amount i.e. contents of learning function will be stored in memory even if the camera's Main Switch is turned OFF or the battery removed.
- In order to set this function with the retained memory and prevent the storage of a new memory, use Pentax Function No.4.
- This function can be canceled by Pentax Function No.5. See page 81 for details.
- The learning function works independently in each Picture Mode (except the Green Operation Mode).

If the exposure is shifted with the Hyper Program-Shift in the Picture Mode (except the Green Operation Mode), the learning function works and automatically shifts a shutter speed/aperture combination according to the shift you selected, making it easier to suit a photographer's personal taste. The amount of shift is indicated by the bar graph in the viewfinder and on the LCD panel as shown. If dots shift to the right on the LCD panel and to the top in the viewfinder, it indicates the shift to a narrower in-focus range or a reduced image blur. If dots shift to the left on the LCD panel and to the bottom in the viewfinder, it indicates the shift to a wider in-focus range or an increased image blur.

(3) MANUAL FOCUSING

1

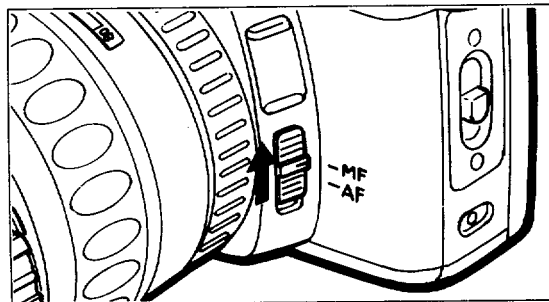

1) With a manual-focus lens

When mounting an existing KA- or K-mount lens with a maximum aperture of f/5.6 or larger (f/1.2 to f/5.6), use the manual focus mode to focus the lens with the aid of the in-focus indicator [] in the viewfinder.

How-To-Manual Focus

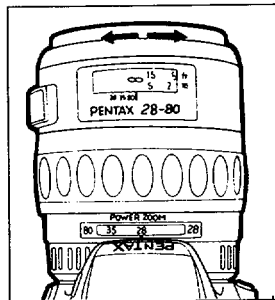

1. Set the focus mode switch to [**MF**].
2. While looking through the viewfinder, turn the focusing ring to the right or left while holding the shutter release button halfway down.
3. When the subject comes into focus, the in-focus indicator [] lights up in the viewfinder. Depress the shutter release button fully to take a photograph.

2

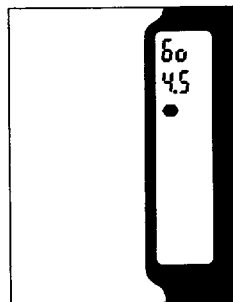

3



- When using a KAF- or KAF2-mount lens in the manual focus mode (with the focus mode switch set to [**MF**]), focus the lens with the aid of the in-focus indicator [] in the viewfinder.
- If an old type screw-mount lens is combined with an optional "Mount Adapter K", the viewfinder's in-focus indicator [] cannot be used for focus confirmation.
- When the subject comes into focus, the in-focus indicator [] lights up in the viewfinder and an audible PCV signal is heard. The audible PCV signal can be canceled by selecting the silence mode using Pentax Function No.3. (See page 80.)

When the Autofocus Mode or the In-Focus Indication Is Unsuitable for Focusing

When the autofocus function or the viewfinder's in-focus indicator [] cannot be used for focus confirmation for the following reasons, focus on the subject in the manual focus mode with the aid of the matte field in the viewfinder as in the case with a non-AF SLR camera.

- The in-focus indicator blinks because the subject is difficult to autofocus.
- The maximum aperture of the lens in use is smaller than f/5.6.
- A Bellows 100mm f/4, Shift 28mm f/3.5 (shifted), or Reflex lens is in use.
- An old type screw-mount lens is fitted with an optional "Mount Adapter K".

How to Manual-Focus

- Set the focus mode switch to [**MF**] .
- While looking through the viewfinder, turn the focusing ring to the right or left until the image in the viewfinder is clearest. Then, depress the shutter release button fully to take a photo.

Using the Snap-in Focus Function

If a K_A- or K-mount lens is used together with the optional "Cable Switch F" with the focus mode switch set at [**AF**] , "snap-in focus" is possible where the shutter is automatically released when a subject comes into focus.

- Use a K_A- or K-mount lens.
- Set the focus mode switch to [**AF**] .
- Focus at the point where you expect to capture the subject.
- Using the optional "Cable Switch F", keep the trigger release button depressed so that the autofocus and metering systems stay active.
- The camera releases the shutter automatically when the subject comes into focus at the point selected.

(4) HARD-TO-AUTOFOCUS SUBJECTS

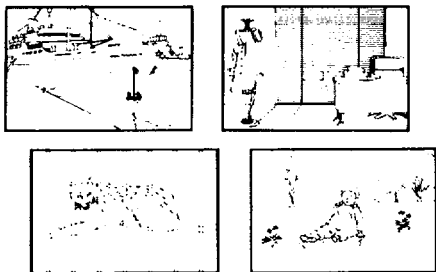

The autofocus system is highly precise, but not perfect. Some subjects may not focus as you wish. In such a case, use the focus-lock technique on a subject near the actual one and equidistant from the lens, or set the focus mode switch to **[MF]** and use the manual focus mode to focus the lens on the subject with the aid of the matte field in the viewfinder. Subjects which may fool the autofocus system include:

- a) Extremely low-contrast subjects such as a white wall in the AF frame
- b) Subjects which don't reflect much light in the AF frame
- c) Subjects which are moving too fast
- d) Subjects with horizontal lines or with finely complex or detailed patterns in the AF frame
- e) Multiple subjects in the foreground and background of the AF frame
- f) Subjects positioned against reflected light or strong backlight or with extremely bright backgrounds

Notes on accessories

The following conditions do not allow autofocusing or manual focusing which uses the in-focus indicator in the viewfinder. Use the manual-focus mode to focus on the subject with the aid of a matte field surrounding the AF frame.

- a) When using special effect filters or "Magic Image Attachment" or "Stereo Adapters"
- b) When using an ordinary polarizing filter; a half mirror incorporated into the autofocus system reduces the effectiveness of the autofocus function when used in combination with an ordinary polarizing filter. Use a circular polarizing filter for autofocus operation.
- c) When using Extension Tubes or an Auto Bellows for close-up photography

Note on the SMC Pentax F SOFT 85mm f/2.8 lens

When shooting at a distance closer than approx. 1.5m, set the lens to a manual f-stop setting between f/2.8 and f/4.5. A smaller aperture (f/5.6 to f/32) may cause the autofocus system and the viewfinder's focus indicator to malfunction. To remedy this problem, temporarily set the lens to f/4.5. After focusing on the subject, lock focus, and set the lens to the required f-stop.

(5) SELECTING AN EXPOSURE MODE

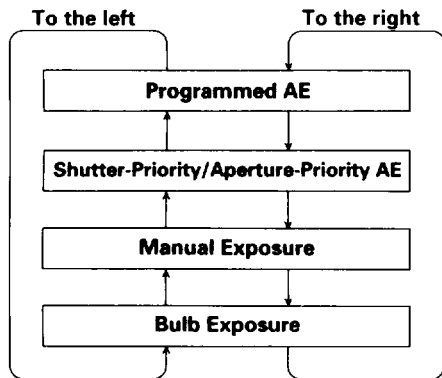

With the lens aperture ring at "A" (auto), moving the camera's Main Switch to [ON] (full-feature position) lets you select any of the available exposure modes other than the Picture Mode, without having to turn the aperture ring to a manual f-stop setting.

Switching the Exposure Mode

The Full-Feature mode provides a total of five exposure modes. The exposure mode switches as shown at left in accordance with the rotation of the Select Dial while holding down the Mode Button. See the respective pages for explanations on each exposure mode.

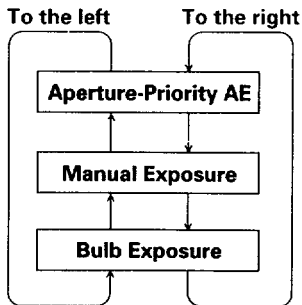

Turn the lens aperture ring from "A" (auto) to a manual f-stop setting when using a Pentax lens without the "A" (auto) position on the lens aperture ring or when using accessories as below.

- Accessories such as the "Extension Tube Set" which do not allow the automatic diaphragm control for exposure.
- Old type flash units which do not allow the use of the "A" (auto) lens aperture.

Whether the Main Switch is set to [ON] or [PICT], with a manual f-stop setting (when the aperture ring is at a position other than "A" (auto)), any of the three exposure modes at left can be selected and the exposure mode switches in a similar manner as when using "A" (auto) lens aperture.

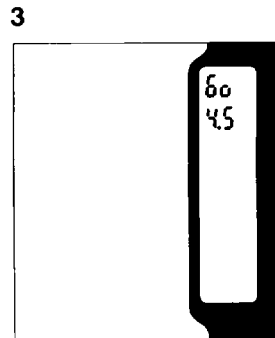
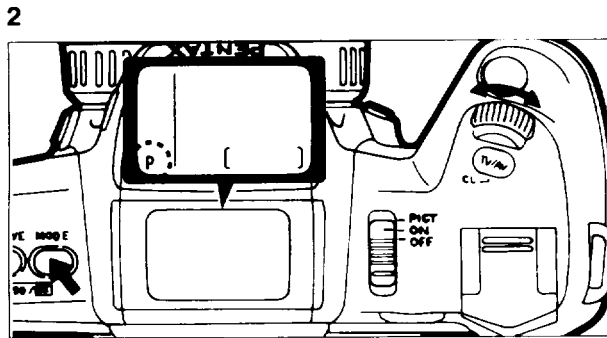
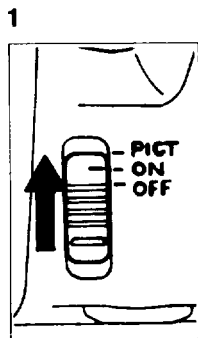

Programmed AE Mode

The camera selects the optimum combination of shutter speed and aperture automatically, making it easy to take a good photograph by just a depression of the shutter release button.

Turn the aperture ring to "A" (auto).

1. Move the Main Switch to [ON].
2. While holding down the Mode Button, turn the Select Dial until [P] is displayed on the LCD panel.
3. When the shutter release button is depressed halfway down, the shutter speed and aperture will be displayed in the viewfinder and on the LCD panel.

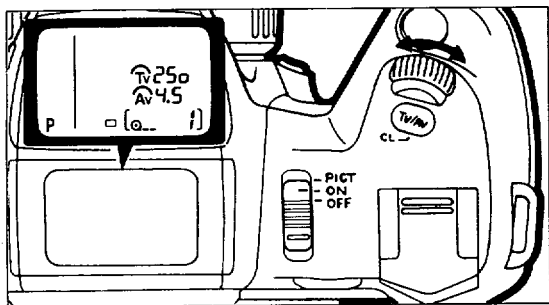

HYPER PROGRAM-SHIFT IN PROGRAMMED AE MODE

The Programmed AE mode features Hyper Program-Shift. Hyper Program-Shift lets you change the shutter speed/aperture combination while maintaining the same exposure. When the Select Dial is rotated to the right, the shutter speed shifts to a faster shutter speed setting while the aperture shifts to a larger aperture; when it is rotated to the left, the shutter speed shifts to a slower shutter speed setting while the aperture shifts to a smaller aperture.

- When the Hyper Program-Shift is executed, [\curvearrowright] will light up above the selected shutter speed and aperture indications in the viewfinder and on the LCD panel, confirming that the Hyper Program-Shift is in use. The selection can be also confirmed by a bar underneath the selected shutter speed and aperture in the viewfinder.
- To cancel the Hyper Program-Shift, depress the Tv/Av Button.

*

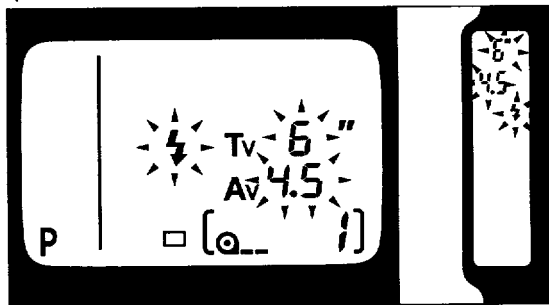

- Hyper Program-Shift works effectively within the shutter speed/aperture combination coupling range for correct exposure control.
- Hyper Program-Shift is possible in the Programed AE Mode. However, the bar graph will not be displayed when the Hyper Program-Shift is executed in this mode.

* EXPOSURE WARNING

With a too bright or dark subject, the indicators will blink in the viewfinder and on the LCD panel as shown in the illustration to warn you. Use an ND filter if the subject is too bright and a flash if it is too dark.

1

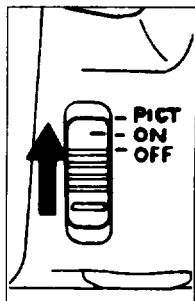

2

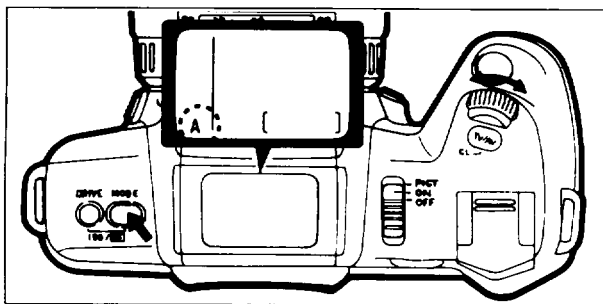

3

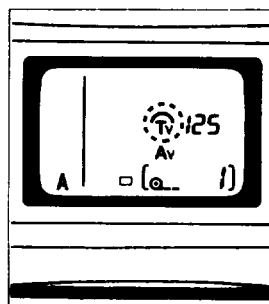

Shutter-Priority AE Mode

When the desired shutter speed is selected, the aperture is automatically set by the camera for a proper exposure according to the brightness of the subject. This mode is suitable for freezing the action with a fast shutter speed or capturing a flowing dynamic image with a slow shutter speed.

Turn the aperture ring to "A" (auto).

1. Move the camera's Main Switch to [ON].
2. While holding down the Mode Button, turn the Select Dial until [A] appears on the LCD panel.
3. Depress the Tv/Av Button so that [\sim] appears above Tv on the LCD panel indication.

4

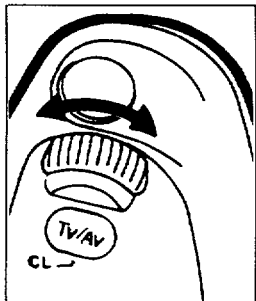

5

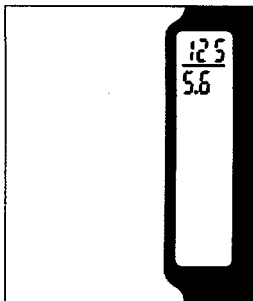

4. Select the desired shutter speed with the Select Dial.
 - At this time a bar will appear underneath the selected shutter speed in the viewfinder indication.
 - When the Select Dial is rotated to the right, the shutter speed is switched to a faster speed; when it is rotated to the left, a shutter speed is switched to a slower speed.
5. When the shutter release button is depressed halfway down, the selected shutter speed and aperture will be displayed in the viewfinder and on the LCD panel.

*

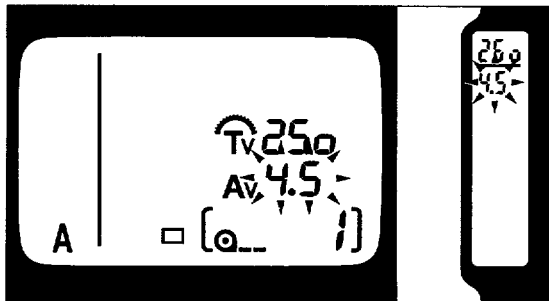

* EXPOSURE WARNING

If the subject is too bright or dark, the selected aperture will blink in the viewfinder and on the LCD panel as a warning as shown. When the subject is too bright, choose a faster shutter speed. If it is too dark, choose a slower shutter speed. When the aperture indication stops blinking, take a photograph. If both the selected shutter speed and aperture blink, it means that the exposure is out of metering range: use an ND filter if the subject is too bright and a flash if it is too dark.

1

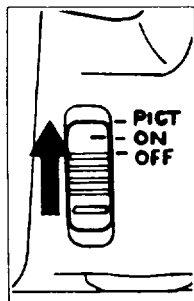

2

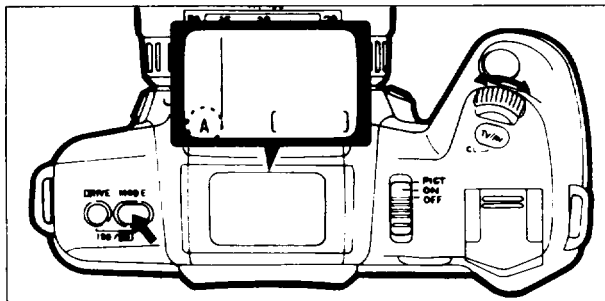

3

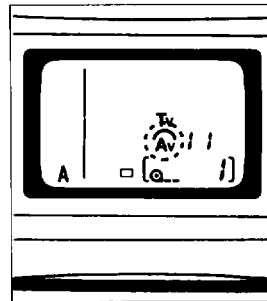

Aperture Priority AE Mode

When the desired aperture is selected, an appropriate shutter speed is automatically set by the camera for a proper exposure. This mode is ideal for shooting landscapes with an increased depth of field, or a portrait against a blurred background.

Turn the aperture ring to "A" (auto)

1. Move the camera's Main Switch to [ON].
2. While holding down the Mode Button, turn the Select Dial until [A] appears on the LCD panel.
3. Depress the Tv/Av Button so that [] appears above Av on the LCD panel.

4

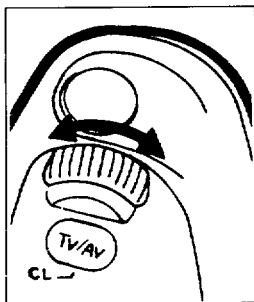

5

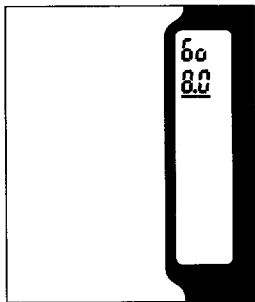

4. Select the desired aperture with the Select Dial.
- At this time a bar will be displayed underneath the selected aperture in the viewfinder.
- When the Select Dial is rotated to the right, the aperture is switched to a smaller aperture; when it is rotated to the left, the aperture is switched to a larger aperture.
5. When the shutter release button is depressed halfway down, a shutter speed and aperture will be displayed in the viewfinder and on the LCD panel.

*

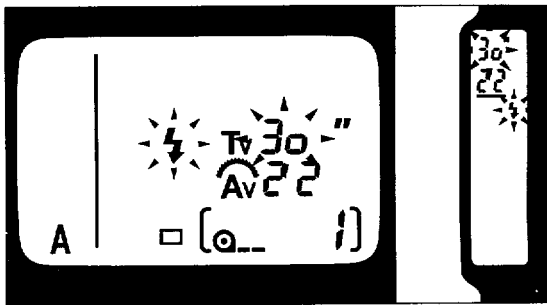

* EXPOSURE WARNING

If the subject is too bright or dark, the selected shutter speed will blink in the viewfinder and on the LCD panel as shown to alert you. When the subject is too bright, choose a smaller aperture; when it is too dark, choose a larger aperture. When the shutter speed indication stops blinking, take a photograph. If both the shutter speed and aperture blink, it means that the exposure is out of metering range: use an ND filter if the subject is too bright and a flash if it is too dark.

1

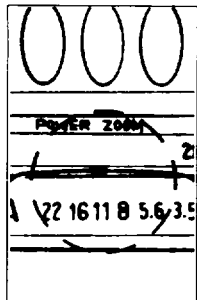

2

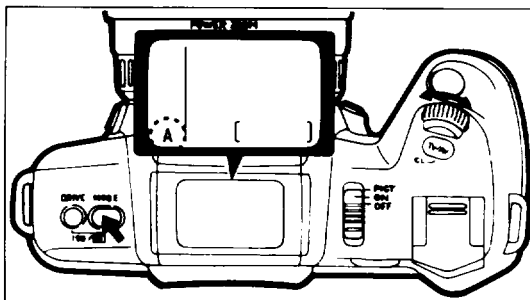

3

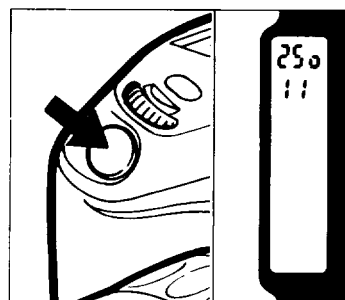

When Using a Manual F-Stop Setting (Move the camera's Main Switch to [ON] or [PICT])

With the aperture ring set at a manual f-stop setting, you can select an Aperture-Priority AE mode.

1. Turn the lens aperture ring to a position other than "A".
 2. While holding down the Mode Button, turn the Select Dial so that [A] appears on the LCD panel.
 3. When the shutter release button is depressed halfway down, a shutter speed and aperture will be displayed in the viewfinder and on the LCD panel.
- When the lens in use is an FA or F lens, the approximate aperture value will be displayed in the viewfinder and on

the LCD panel by half-depression of the shutter release button. With other lenses, no indication will appear.

- When a lens without the lens information contacts (lenses made before the Pentax M series) is used with the aperture selected by the lens aperture ring in the Aperture-Priority AE mode, the camera switches the metering system from Multi(6)-Segment to Center-Weighted.

EXPOSURE WARNING

The exposure warning indication appears in a similar manner as when the lens aperture ring is set to "A" (auto). See page 53 for details.

1

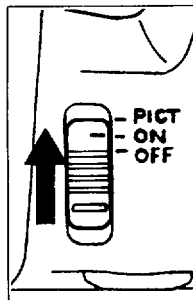

2

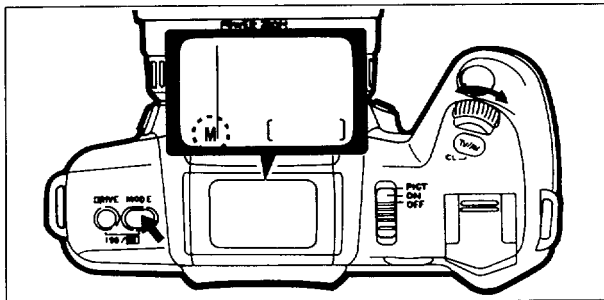

3

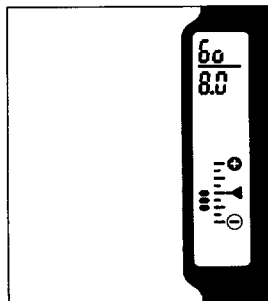

Metered Manual Mode

A proper exposure can be obtained by selecting a combination of shutter speed and aperture according to the meter's indication. However, the Metered Manual mode allows you to adjust that exposure to create different images - for example, over- or underexposing the subject. The camera's metering system is automatically switched to spot-metering when the camera is set in the Metered Manual mode. Spot metering system allows only the central area of the viewfinder to be measured. When in this mode, measure the exposure with this limited small area.



When the shutter release button is depressed while holding down the Hyper button in the Metered Manual Exposure Mode, the shutter speed and aperture vary according to the ambient brightness, which is similar to the Shutter-Priority Exposure Mode or the Aperture-Priority Exposure Mode.

When the Lens Aperture Ring Is Turned to "A" (auto).

1. Move the camera's Main Switch to [ON] .
2. While holding down the Mode Button, turn the Select Dial until [M] is displayed on the LCD panel.
 - The selected shutter speed/aperture and the bar graph are displayed on the LCD panel.
3. When the shutter release button is depressed halfway down, the selected shutter speed/aperture and the bar graph will be displayed in the viewfinder.

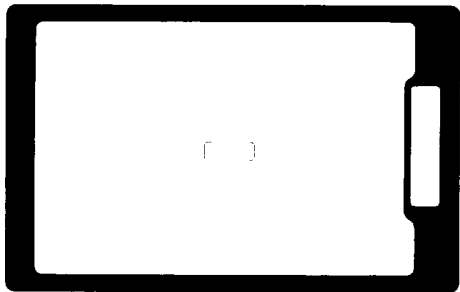





4

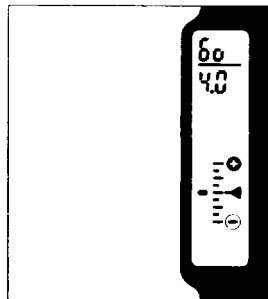
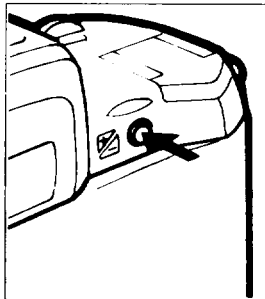

4. Aim the camera's frame in the center of the viewfinder toward a subject to measure the exposure.
- Spot metering system pinpoints light metering in a very small portion of the image field. When the contrast between the main subject positioned in this small area and another subject occupying a relatively large area is great, the favorable result may not be obtained unless scene contrast is taken into consideration.
5. When the Hyper Button [] is depressed and [] is displayed on the LCD panel, the shutter speed remains unchanged while the aperture is adjusted for proper exposure: when [] is displayed on the LCD panel, the aperture remains unchanged while the shutter speed is adjusted for proper exposure (Hyper Manual). At this time, dots appear in the center of the bar graph in both the viewfinder and LCD panel indications, confirming correct exposure. Then, adjust the aperture and/or the shutter speed for the desired exposure.

5



- To change the shutter speed, depress the Tv/Av Button. [] appears above Tv on the LCD panel and a bar underneath a shutter speed in the viewfinder indication. Turning the Select Dial to the right increases the shutter speed, while turning it to the left decreases the shutter speed.
To change the aperture, depress the Tv/Av Button. [] appears above Av on the LCD panel and a bar underneath an aperture in the viewfinder indication. Turning the Select Dial to the right closes down the aperture, while turning it to the left opens up the aperture.
- When dots are displayed to the [] side, it indicates that the exposure biases towards underexposure. When dots are displayed to the [] side, it means that the exposure biases towards overexposure. Bar graph is calibrated in 0.5EV. When the exposure biases beyond ±2EV, [] or [] will blink.

1

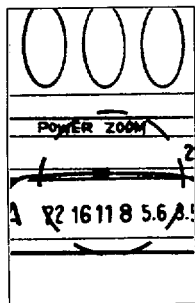

2

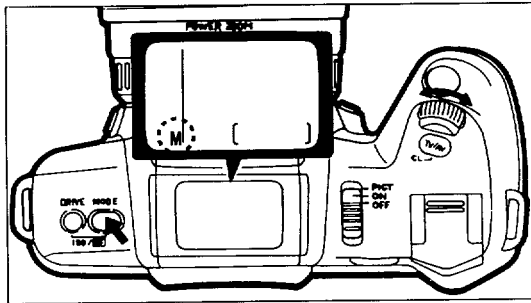

3

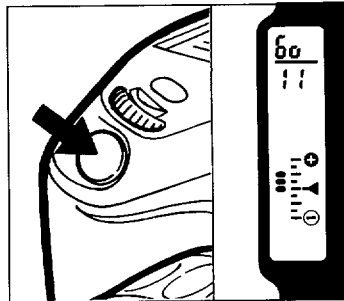

When the Lens Aperture Ring Is at a Position Other Than "A" (Auto)

(Set the Main Switch to [ON] or [PICT] .)

1. Turn the lens aperture ring to a position other than "A".
2. While holding down the Mode Button, turn the Select Dial until [M] is displayed on the LCD panel.
 - A shutter speed and bar graph are displayed on the LCD panel.
3. When the shutter release button is depressed halfway down, a shutter speed and bar graph will be displayed in the viewfinder. Adjust the aperture with the lens

aperture ring and the shutter speed with the Select Dial.

- When the lens in use is an F or FA lens, the approximate aperture value will appear in the viewfinder and on the LCD panel by half-depression of the shutter release button. With other lenses, no indication will appear.
- Adjust the exposure in a similar manner as when the lens aperture ring is set at "A" (auto).
- Pressing the Hyper button [] will immediately adjust the shutter speed for a correct exposure (Hyper Manual).

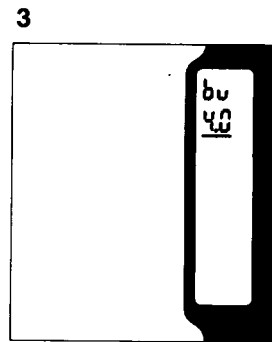
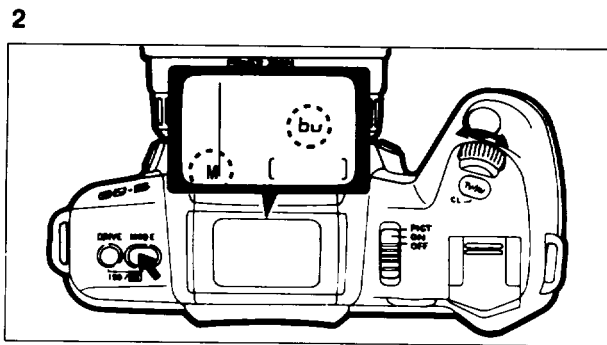
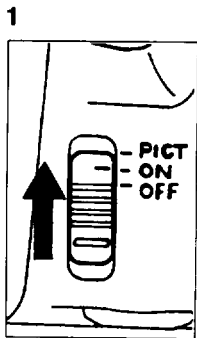

Manual (Bulb) Mode

This mode is useful for long exposures required from shooting fireworks and night scenes, for instance. The shutter remains open as long as the shutter release button is held down.

3. When the shutter release button is depressed halfway down, [bu] and an aperture are displayed on the LCD panel.

When the Lens Aperture Ring Is Set at "A" (auto).

1. Move the camera's Main Switch to [ON].
2. While holding down the Mode Button, turn the Select Dial so that [M] and [bu] appear on the LCD panel. An aperture is displayed on the LCD panel.

4

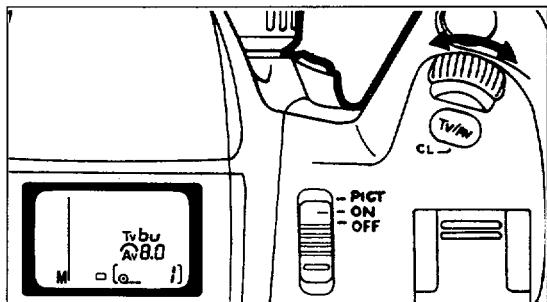

4. Select the desired aperture with the Select Dial.

 - Turning the Select Dial to the right closes down the aperture, while turning it to the left opens up the aperture.

When the Lens Aperture Ring Is at a Position Other Than "A" (auto).

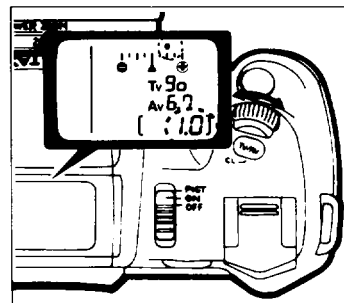
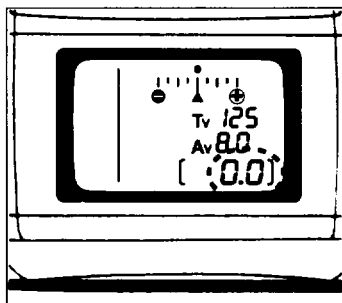
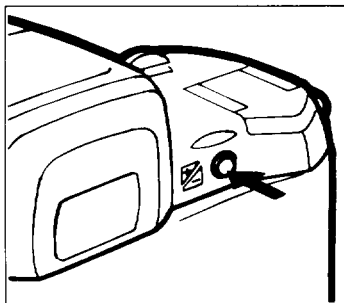

1. Move the Main Switch to [ON] or [PICT] .
 2. Turn the lens aperture ring to a position other than "A".
 3. While holding down the Mode Button, turn the Select Dial until [M] and [bu] are displayed on the LCD panel.
 4. When the shutter release button is depressed halfway down, [bu] is displayed in the viewfinder.
- When the lens in use is an ForFA lens, the approximate aperture value will appear in the viewfinder and on the LCD panel by half-depression of the shutter release button. With other lenses, no indication will appear.
 - When using this mode, use a sturdy tripod and the optional "Cable Switch F".
 - Up to approx. 6 hours of time exposure are possible at room temperatures with a new lithium battery.

(6) ABOUT EXPOSURE COMPENSATION



The exposure compensation allows you to deliberately overexpose (brighten) or underexpose (darken) a subject. When the Hyper button [] is depressed, the compensation value and bar graph will be displayed on the LCD panel and in the viewfinder. Select the desired compensation value by turning the Select Dial while holding down the Hyper button.

- The exposure compensation does not work in the Metered Manual Exposure mode, Bulb mode and Green Operation Mode.
- Exposure compensation is possible in the range from +3EV to -3EV in 0.5 EV step.
- A compensation value is displayed within +/-2EV in 0.5EV step on the bar graph. When a compensation value you set exceeds this range, a dot will blink on the bar graph.

- During an exposure compensation in the Picture Mode, [] or [] will be displayed in the viewfinder and on the LCD panel. When a mode other than a Picture Mode is in use or when the lens aperture ring is set at a position other than "A" (auto) in the Picture Mode, a dot representative for a compensation value will appear on the bar graph in the viewfinder and on the LCD panel.
- To cancel the exposure compensation, reset the corrected value to 0.0 by depressing the Tv/Av Button while holding down the Hyper button.
- Even when the camera's Main Switch is set to [OFF] or the exposure mode is switched, the exposure compensation is not canceled.

(7) SELECTING A DRIVE MODE

This camera has a total of three drive modes as shown.

Types of Drive Modes

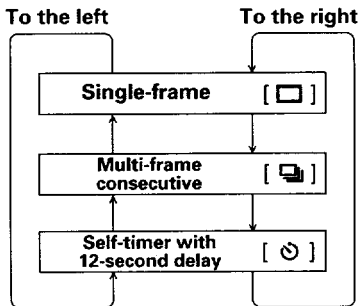

- [□] : One picture is taken at each press of shutter release button.
- [📷] : Pictures can be taken consecutively while holding down the shutter release button.
- [⌚] : A picture is taken with a 12-second-delay.

Changing the Drive Mode

While holding down the Drive Button, turn the Select Dial to set the desired mode.

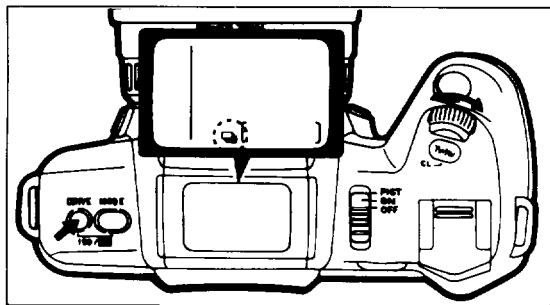

1) Consecutive Photography

A photo can be taken consecutively while the shutter release button is held down.

1. While depressing the Drive Button, turn the Select Dial to Consecutive Shooting [].
2. Depress the shutter release button fully to take a photo.
 - While the shutter release button is held down, photos are shot consecutively.
 - The camera focuses on the subject frame by frame in this mode. However, the shutter cannot be released unless the camera has confirmed sharp focus.

62

1

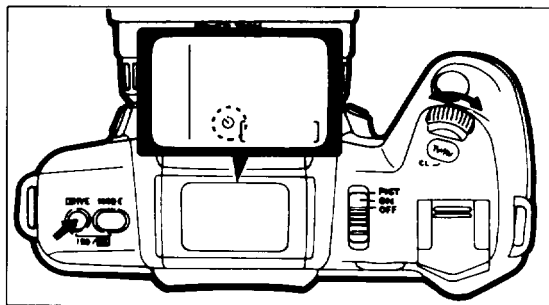

2) Self-Timer Mode

The Self-Timer mode delays the shutter release, allowing the photographer to include himself/herself in the picture.

1. Set the Drive Mode to Self-Timer [] by turning the Select Dial while holding down the Drive Button.

2

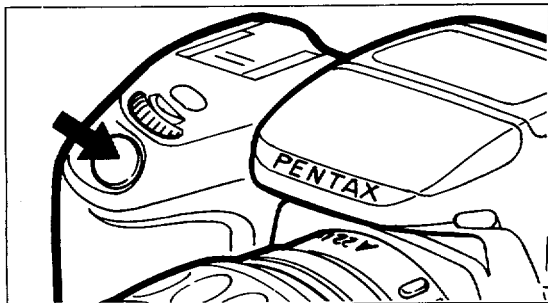

2. Focus on the subject first with the AF frame by depressing the shutter release button halfway down, and then depress the shutter release button fully. The shutter will release in about 12 seconds.

 - When the Self-Timer is in operation, audible PCV signal is delivered: the signal is delivered at a faster pace for the last two seconds, letting you know when to smile.
 - To cancel the Self-Timer operation after it has been activated and before the shot is taken, move the camera's Main Switch to [OFF].
 - If you back away from the viewfinder during a Self-Timer operation, underexposure may result due to light entering the camera through the viewfinder.

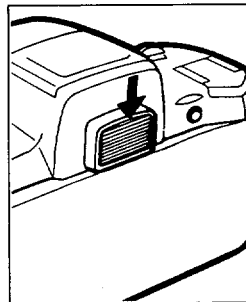
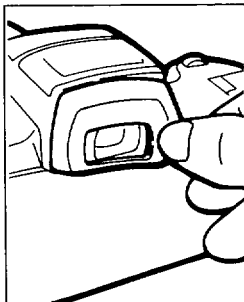

Attach the supplied finder cap when taking Self-Timer photography to prevent stray light entering the camera.

- When using accessories such as the "Correction Lens M" and "Finder Cap", remove the "Eyecup F_E".
- The Eyecup F_E comes from the factory fitted to the camera's viewfinder accessory grooves.
- When you want to use an Eyecup in combination with a "Correction Lens M", combine the optional "Eyecup MII" with a "Correction Lens for 67".
- When you lift your finger from the shutter release button before the shutter is released in the Bulb and Self-Timer modes, the camera uses a shutter speed of 1/60 sec.

63

(8) EXTENDED POWER ZOOM FUNCTIONS

With a Pentax-FA Zoom lens, the following Auto Zoom Functions are made possible:

- ① Zoom Clip Mode
- ② Image Size Tracking Mode
- ③ Auto Zoom Effect Mode

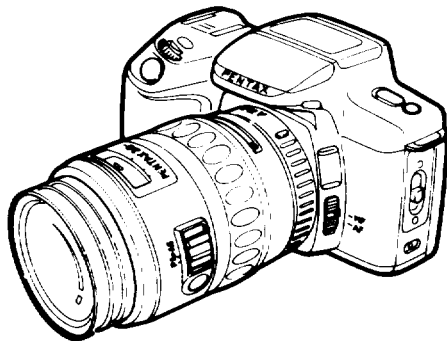

1

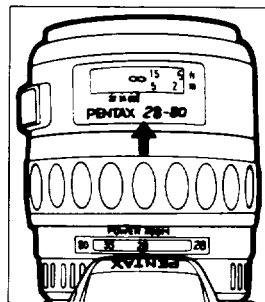

2

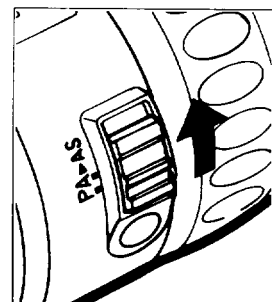

Preparing for Using the Auto Zoom Function

1. Push the power zoom ring forward until the words **POWER ZOOM** appear beneath the zoom ring as shown in the illustration.
 - The zoom lens comes from the factory with the power zoom ring in this position.
2. Set the lens Auto Zoom Switch to "A" (auto).
 - Now you are ready to use the Auto Zoom functions. For details of the available functions, see each page.

1

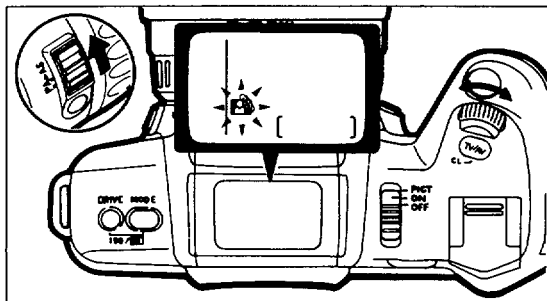

① ZOOM CLIP MODE

With the Zoom Clip Mode, you can preset a focal length for a desired picture area and return to that preset focal length instantly regardless of the setting you might be using by just depressing the lens Zoom Set Button. Zoom Clip Mode is useful for action photography such as sports and snapshots.

2

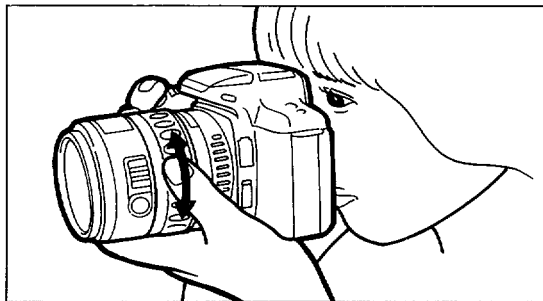

1. While holding the Auto Zoom Switch on the lens barrel toward [AS], turn the Select Dial until [] blinks on the LCD panel.
 - To cancel the Zoom Clip Mode, return the Auto Zoom Switch to [P].
2. While looking through the viewfinder, turn the zoom ring to set the desired focal length.

3

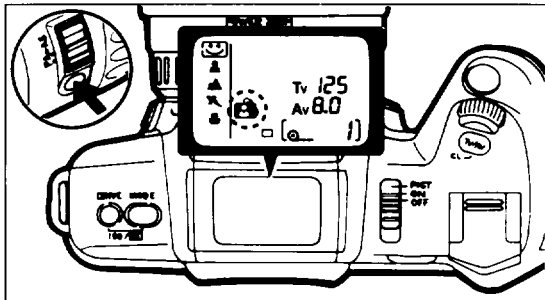

3. Depress the lens Zoom Set Button. [] lights up to indicate that the focal length you set has been entered.
- Entry of another focal length clears a previous focal length.
 - The focal length stored in memory is not cleared even if the camera's Main Switch is set to [OFF]. However, when the battery is replaced, the stored focal length is cleared.
 - If the lens is removed or replaced while the camera's Main Switch is set at [ON] or [PICT], the stored focal length will be cleared from memory. To prevent this, set the camera's Main Switch to [OFF] prior to replacing the lens.

4

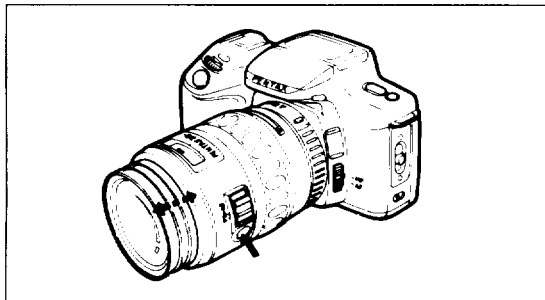

4. Depress the Zoom Set Button and the focal length held in memory will return. Depress the shutter release button fully to take a photograph.
- When the Zoom Set Button is depressed, the lens zooms while maintaining sharp picture focus. However, [] will not appear and the PCV signal will not be heard for focus confirmation.

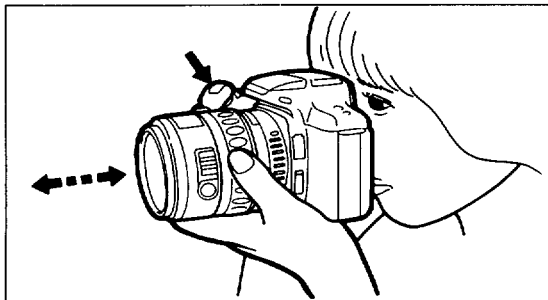

4. Depress the shutter release button halfway down. The camera automatically zooms the lens to always capture the subject at the preset image size regardless of the distance to the subject (within the constraints of the focal length range). Depress the shutter release button fully after the lens finishes zooming.
- To cancel the Image Size Tracking Mode, return the Auto Zoom Switch to [P].
 - Releasing the shutter before completion of zooming operation may not yield a preset image size: to get the desired image size release the shutter only after the lens finishes zooming.

- If the camera-to-subject distance is too close or far, the preset image size may not be obtained as this mode works effectively only within the constraints of the focal length range. In addition, since the preset image size works only on the lens currently in use, the preset image size may not be obtained if the lens is replaced with another.
- When the focus mode switch is set at [MF] in the Image-Size Tracking Mode, the mode is switched from Image-Size Tracking to Zoom Clip Mode.
- The image size stored in memory is not cleared even if the camera's Main Switch is set to [OFF].
- If the lens is removed or replaced while the camera's Main Switch is set at [ON] or [PICT], the stored image size will be cleared from memory. To prevent this, set the camera's Main Switch to [OFF] prior to replacing the lens.
- Entry of another image size clears a previous image size.
- Setting the lens focal length to the middle of its range for the desired image size will provide the most versatility. For instance, set the 28-80mm lens to around 50mm.
- When the battery is replaced, keep in mind that a preset image size is cleared.



3 ZOOM EFFECT

In the Zoom Effect Mode, the lens zooms automatically from wide-angle to telephoto during an exposure, resulting in the subject's contours becoming radially blurred while the subject's core is clearly photographed.

1

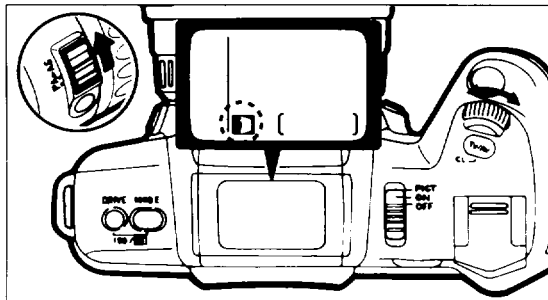

1. While holding the lens Auto Zoom Switch toward [AS], turn the Select Dial until [] appears on the LCD panel.
 - The bar graph will appear in the viewfinder and on the LCD panel only when the Metered-Manual Exposure Mode is in use.
 - To cancel the Zoom Effect Mode, move the lens Auto Zoom Switch to [P].
 - When the Zoom Effect Mode is set while the Hyper Program-Shift is executed, the bar graph will disappear. However, the shifted amount stays in memory.

② IMAGE SIZE TRACKING MODE

In this mode, the camera will automatically zoom the lens to always capture the subject at the preset image size regardless of the distance to the subject (within the constraints of the focal length range). This mode allows you to take a picture of a child coming towards or going away from you with the same preset image size.

1

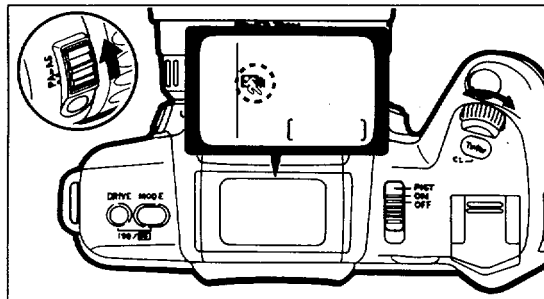

1. While holding the Auto Zoom Switch on the lens barrel toward [**AS**], turn the Select Dial until [**AS**] appears on the LCD panel.
 - When the focus mode switch is set to [**MF**], this mode cannot be used.

2

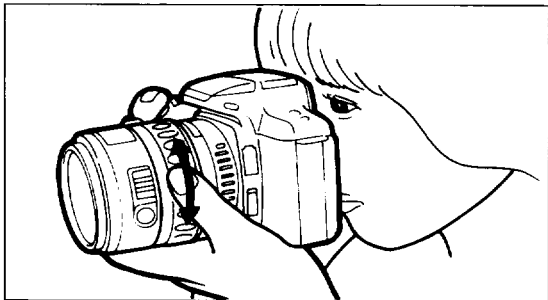

2. While looking through the viewfinder, turn the zoom ring to zoom the lens to the desired setting.
 - At this time the lens zooms while maintaining sharp picture focus.

3

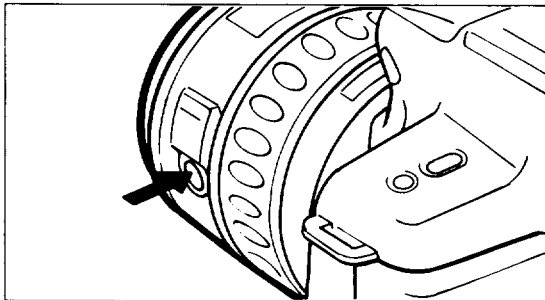

3. Depress the lens Zoom Set Button. The image size you set has been entered.
 - At this time the PCV signal is heard, letting you know that the image size has been entered.

2

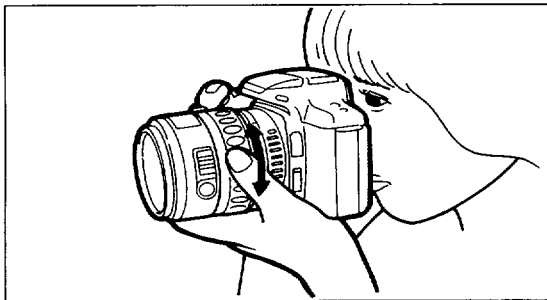

2. Set the power zoom ring to a wide-angle position to create distinctive effects.

- When the lens is at its tele end, the lens zooms from telephoto to wide-angle position.
- Set an exposure so that as slow a shutter speed as possible is selected to create a dramatic effect: with a faster shutter speed, the dramatic zooming effect is not produced.
- In the Picture Mode and Programmed AE Mode, the camera automatically sets an exposure which allows the use of as slow a shutter speed as possible.
- After the shutter is released, zooming starts automatically when exposure reaches half of the total designated exposure time. For example, if the shutter speed is set to 1 second, the lens starts zooming when 0.5 second has elapsed after the shutter is released.

3

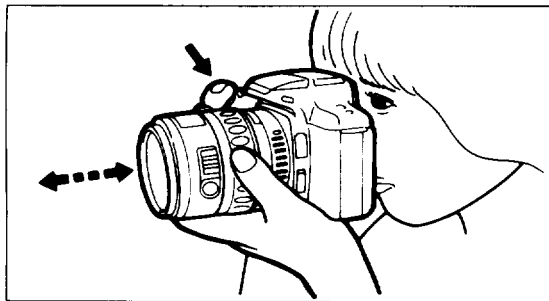

3. Depress the shutter release button fully. The lens zooms according to the selected shutter speed, creating a dynamic zoom effect.



- Faster shutter speeds reduce the zooming time, making it almost impossible to produce a Zoom Effect. For example, a 28-80mm zoom lens takes about 1 second to zoom from the 28mm position to the 80mm position. Thus, a shutter speed of at least 2 seconds is required to produce a full zoom effect. If the shutter speed is too slow, the shutter remains open after the lens finishes zooming, producing two image cores of one subject in two different sizes on a single frame.
- If the zooming range is too extreme, the image becomes difficult to see due to excessively increased blur.
- The lens zooms at the maximum zooming speed in the Zoom Effect Mode.
- Use of a tripod is recommended to prevent camera shake.

(9) USING THE BUILT-IN FLASH (RTF)

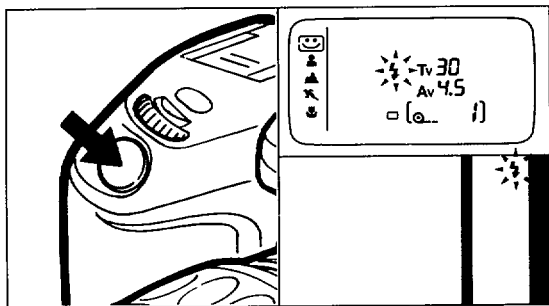
1





When using the camera's built-in flash in a dark or backlit situation, the camera automatically chooses an optimum combination of shutter speed and aperture according to the subject brightness, allowing you to take a flash photograph with ease.

1. Select the Picture Mode or Programmed AE Mode and depress the shutter release button halfway down.
 - In a dark or backlit situation, [] and [] will blink respectively on the LCD panel and in the viewfinder to recommend the use of flash.

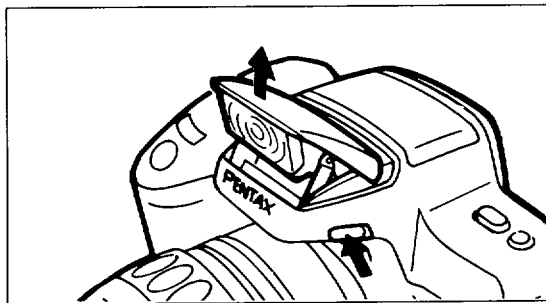
2



2. Depress the flash pop-up button to activate the built-in flash.
 - The built-in flash starts charging automatically. When it is fully charged, [] lights up on the LCD panel. In addition, [] lights up in the viewfinder when the shutter release button is depressed halfway down.
 - The shutter cannot be released while the flash unit is being charged.
 - When the built-in flash is activated while the Hyper Program-Shift is executed, the bar graph will disappear. However, the shifted amount stays in memory.

(73)

3

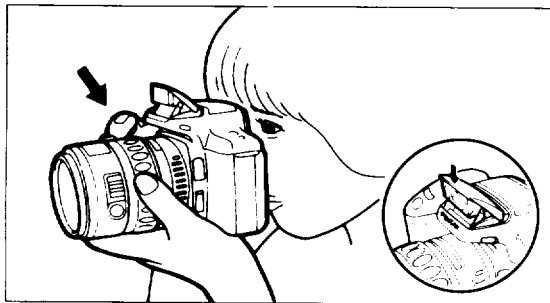

3. Depress the shutter release button fully to take a flash photograph.

- The shutter speed changes in the range from 1/100 to 1/30 sec., and the slowest shutter speed depends on the focal length of the lens in use. The shutter speed of 1/100 sec. is automatically selected when a lens made before the Pentax A-series lens is used or when the Action Program Mode is selected.

- With the Picture Mode (except the Green Operation Mode) or Programmed AE Mode, turning the Select Dial lets you use Hyper Program-Shift, making it possible to change a shutter speed/aperture combination. Hyper Program-Shift works in the aperture range that couples with a shutter speed of 1/100 sec. or slower. When the shutter speed becomes slow, camera shake is likely to blur your picture, so use a tripod.
- After taking a flash photograph, retract the built-in flash into the camera body by pushing it down into the camera body.

When in the Shutter-Priority AE mode

When using the built-in flash in the Shutter-Priority AE mode, you can take a flash photograph with the shutter speed of 1/100 sec. or slower. In the Shutter-Priority AE mode, the aperture setting automatically changes with the ambient brightness, making flash photography easy.

When in Aperture-Priority AE or Metered Manual Exposure Mode

This mode is useful to take a flash photograph with a selected in-focus range (depth of field) by setting a desired aperture. In the Aperture-Priority AE Mode, the shutter speed changes according to the ambient brightness, making flash photography easy.

- The shutter speed changes in the range from 1/100 to 1/30 sec., and the slowest shutter speed depends on the focal length of the lens mounted on the camera. When a lens made before the Pentax A-series is used, the camera uses the shutter speed of 1/100 sec.

Calculating Flash Effective Distance According to the Selected Aperture

Maximum flash distance = GN*÷ Selected aperture
Minimum flash distance = Maximum flash distance ÷ 5
When the distance to the subject is less than 0.7m, flash cannot be used.
***GN: Guide Number**

Calculating the aperture according to the camera-to-subject distance

Aperture = GN ÷ Camera-to-subject distance

If the calculated aperture value is the one other than an f-stop on the aperture ring, for example f/3, choose the next smallest aperture that is an f-stop on the aperture ring (f/2.8 in this case).

The guide numbers depend upon the film speed used as shown below.

ISO25	→ GN6.5	ISO200	→ GN18
ISO50	→ GN9.2	ISO400	→ GN26
ISO100	→ GN13		

If an ISO100 film is used at an aperture of f/4.7, the flash effective distance is obtained as follows:

$$\text{GN13} \div \text{f/4.7} = 2.8\text{m}$$

$$2.8 \div 5 = \text{Approx. } 0.56$$

Thus, flash effective distance ranges from approx. 0.7m to 2.8m.



Without Daylight-Synch



With Daylight-Synch

76

Daylight-Synch Flash

In the Picture Mode or Programmed AE, Shutter Priority AE or Aperture-Priority AE Mode, the shutter speed or aperture changes according to the ambient brightness, making Daylight-Synch flash photography easy, which would otherwise require complicated exposure control. When shooting in a lighting condition that results in a shutter speed of 1/100 sec. or slower, keep in mind that the background may be overexposed.



Slow-Speed-Synch

Slow-speed-sync flash operation works in the Metered Manual Exposure Mode and Shutter-Priority Exposure Mode.

- Metered Manual Exposure Mode

1. Activate the flash by depressing the flash pop-up button.
2. Set the camera's exposure mode on manual.
3. Select an appropriate shutter speed/aperture combination for a correct exposure.
4. Focus the lens on the subject and shoot.
 - The step 1 can be followed at any time before advancing to the step 4.

- Shutter-Priority Exposure Mode

1. Set the Shutter-Priority AE Mode.
2. Set the desired shutter speed.
 - When the aperture blinks in the viewfinder and on the LCD panel, it means that the correct exposure will not be obtained: adjust the shutter speed until the aperture stops blinking.
3. Press the flash pop-up button to activate the built-in flash.
4. Take a photograph.
 - Use of a tripod is recommended to prevent camera shake.

(10) PENTAX FUNCTIONS

1

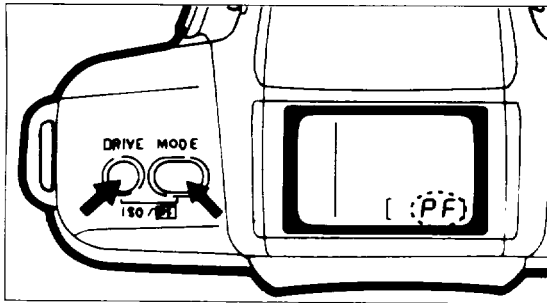

2

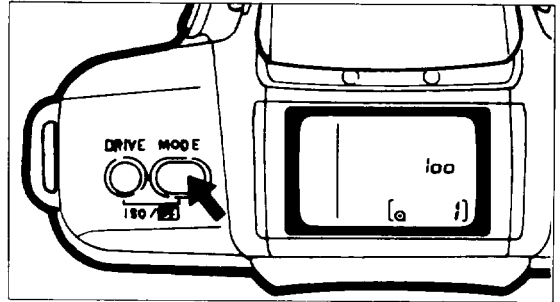

This camera comes equipped with 5 "Pentax Functions", enabling you to revise some of the basic operational features from the original settings to adjust them to your needs.

Setting Pentax Functions

1. Depress the Mode Button and Drive Button simultaneously until the dots disappear on the LCD panel. [PF] is displayed on the LCD panel, indicating that the Pentax Function Setting Mode is engaged.
 - If the camera is left unused for 1 minute in this status, you will be automatically exited from this mode.
2. Select the desired Pentax function number by depressing the Mode Button.

3

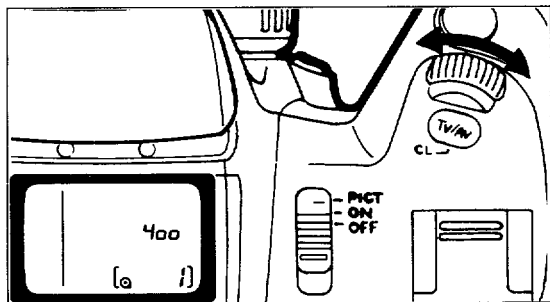

3. Move the Select Dial to set the status of the selected Pentax Function.

- The default settings of all the Pentax Functions are (0).
- After setting the status, to terminate this setting mode, keep depressing the Mode Button and Drive Button simultaneously until the dot indication disappears on the LCD panel.

*

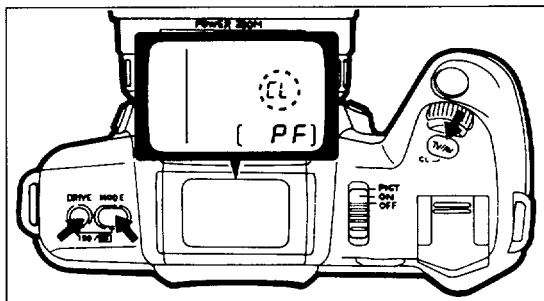

* Initializing the Pentax Function

To initialize the Pentax Functions except when in the Pentax Function Setting Mode, first set the Pentax Function Setting Mode by keeping the Mode and Drive buttons depressed simultaneously until dots disappear on the LCD panel. Then, while holding down the Mode and Drive buttons, keep depressing the Tv/Av Button until dots disappear on the LCD panel. [CL] appears on the LCD panel, indicating that the Pentax Functions are initialized. However, with Pentax Function No.1, a proper film speed is set with DX-coded films, and ISO100 film speed is used with non-DX-coded films. When the Pentax Functions are initialized, all the contents of learning functions are cleared.

79

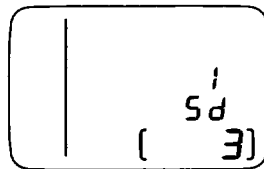
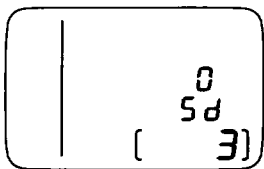
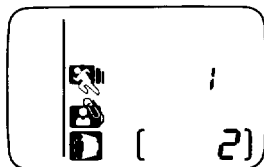
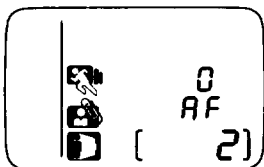
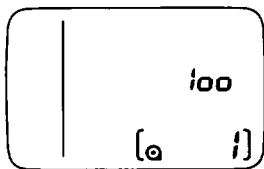

[PF1] Film Speed Selection

Explanation : When using non-DX-coded film or wishing to change the film speed setting of DX-coded film, you can set the film speed manually.

Setting : Turn the Select Dial to set the film speed manually.

- When the camera is set to Manual ISO, loading new film causes the camera to read the DX code and automatically reset ISO.
- When the Tv/Av Button is depressed after the ISO film speed is manually changed, a proper film speed is set with DX-coded films and ISO100 film speed is used with non DX-coded films.

[PF2] Whether to Maintain Picture Focus Or Not While the Lens Is Zooming

Explanation : When the lens is zooming with the power zoom function, you can select between maintaining picture focus or not.

- Selection** : **0** = Picture focus is maintained while the lens is power-zooming
1 = Picture focus is not maintained while the lens is power-zooming

[PF3] Turning On Or Off the PCV Signal When Focus Is Achieved

Explanation : When the subject is in focus, the camera delivers the audible PCV signal to inform you of the in-focus status. The audible PCV signal can be turned on or off using this function.

- Selection** : **0** = PCV signal is delivered
1 = PCV signal is canceled

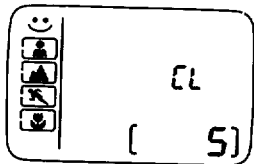
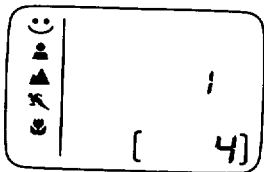
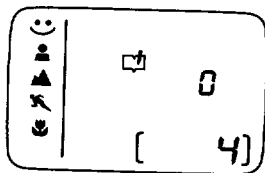

[PF4] Turning On Or Off the Learning Function

Explanation : The learning function can be turned on or off when the Picture Mode is in use.

Selection : **0** = Learning function works in the Picture Mode
1 = Learning function does not work in the Picture Mode

[PF5] Clearing the Contents of Learning Function Entered in All the Picture Mode Or Only the Contents Entered in Each Mode

Explanation : All the contents of learning function entered in all the Picture Modes or only the contents of learning functions entered in each Picture Mode can be cleared.

Setting : Turn the Select Dial to superimpose [□] on the desired mode to be cleared. Depress the Tv/Av Button. [□] stops blinking and blinking [L] starts lighting on the LCD panel, indicating that the contents of learning function will be cleared. To clear all the contents stored in the Picture Mode, turn the Select Dial until [□] superimposes on all the picture icons, and then depress the Tv/Av Button.

(11) USING A PENTAX DEDICATED ACCESSORY FLASH

Use a Pentax dedicated accessory flash unit for increased flash range and improved versatility.

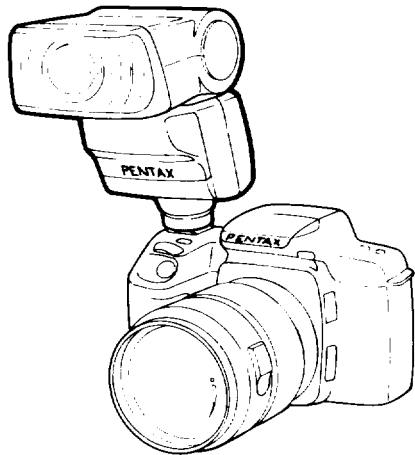

Using the TTL Auto Flash

1. Remove the Hot Shoe Cover F_6 and attach a Pentax dedicated flash unit.

82

2. Set the flash to TTL Auto mode. Set the camera to any of the Picture Modes, Programmed AE Mode or Aperture Priority AE Mode.
3. Move the flash's main switch to ON.
4. Ensure that the flash is fully charged. After the flash ready lamp is lit, if you depress the shutter release button halfway down, [L] comes on in the viewfinder.
 - After the flash is fully charged, the shutter speed varies in the range of 1/100 to 1/30 sec. according to the ambient brightness. The slowest shutter speed depends on the lens focal length.
However, when a lens made before the Pentax A series lens is in use or when the Action Program Mode is in use, the camera uses the shutter speed of 1/100 sec.
5. Focus on the subject and take a flash photograph.
 - In the Shutter-Priority AE or Metered Manual Exposure Mode, slow-speed-sync photography is possible. (See page 77.)
 - When the camera is in the Picture Mode (except the Green Operation Mode) or Programmed AE Mode, turning the Select Dial lets you use Hyper Program-Shift, allowing you to change a shutter speed/aperture combination. The shiftable shutter speed/aperture combination range depends on an aperture range that couples with a shutter speed of 1/100 sec. or slower. When a shutter speed becomes slow, camera shake is likely to blur your picture, so use a tripod.

Overview of Flash Functions

CAMERA FUNCTION	TYPE A	TYPE B	TYPE C	TYPE D	TYPE E
After the flash is charged, the camera automatically selects the flash-sync speed.	○	○	○	○	*1
Automatic aperture setting in the Picture Mode, Programmed AE or Shutter-Priority AE mode	○	○	○	○	*2
Flash confirmation signal in the viewfinder		○	○		
TTL auto flash mode	○	○	○	○	
Slow-speed-sync flash in the Shutter-Priority AE or Metered-Manual Exposure mode	○	○	○	○	○
AF spotbeam	○	○	○		
Trailing-curtain-sync [*3]	*4	○	○		
Contrast control sync flash [*3]		○			

TYPE A : Built-in flash

TYPE B : AF500FTZ[*5], AF330FTZ

TYPE C : AF400FTZ, AF240FT

TYPE D : AF400T, AF280T, AF200T, AF080C, AF140C

TYPE E : AF260SA, AF240Z, AF200SA, AF200S

AF160SA, AF160, AF140

Notes:

1. With the AF140, AF160, AF200S and AF240Z, the camera selects the flash-sync shutter speed only when the lens aperture ring is set to a position other than "A" (auto).
2. Only with the AF200SA, automatic aperture setting is possible.
3. The shutter speed is set to 1/60 sec. or slower.

4. When a type A flash is used in combination with type B or C, trailing-curtain-sync is possible.

5. Multi-burst and slave-sync flash are possible with the AF500FTZ.

- When using an old type flash unit such as the AF140, AF160 and AF200S, calculate the aperture with the calculator board on the rear of the flash unit and use that aperture.

Caution:

- Use of non-Pentax flash units may damage the camera. Use a Pentax dedicated flash unit for best results.

AF500FTZ

- The aperture and shutter speed vary automatically according to the ambient brightness, making daylight-sync-flash possible. The aperture and shutter speed vary in the same way as with the camera's built-in flash. (See page 73.)
- It features a built-in infrared spot-beam to assist the autofocus system in dim light and low-contrast conditions.
- The auto zoom function will automatically adjust the angle of discharge according to the lens focal length.
- It features wireless slave-sync flash function.
- Multiple flash burst on a single frame is possible.
- Contrast control sync flash is possible. (See page 85.)
- In the Picture Mode, Programmed AE, Shutter-Priority AE or Aperture-Priority AE Mode, even when the flash unit is set to Manual, TTL Auto Flash Mode will be set automatically on the flash unit.
- When the flash is charged and left unused for about 3 minutes, the power automatically switches off to save battery power. Depressing the shutter release button halfway down will restart charging of the flash unit.

AF330FTZ

- The aperture and shutter speed vary automatically according to the ambient brightness, making daylight-sync-flash possible. The aperture and shutter speed vary in the same way as with the camera's built-in flash. (See page 73.)

- It features a built-in infrared spot-beam to assist the autofocus system in dim light and low-contrast conditions.
- The auto zoom function will automatically adjust the angle of discharge according to the lens focal length.
- Contrast control sync flash is possible. (See page 85.)
- In the Picture Mode, Programmed AE, Shutter-Priority AE or Aperture-Priority AE Mode, even when the flash unit is set to Manual, TTL Auto Flash mode will be set automatically on the flash unit.
- When the flash is charged and left unused for about 3 minutes, the power automatically switches off to save battery power. Depressing the shutter release button halfway down will restart charging of the flash unit.

AF240FT and AF400FTZ

- The aperture and shutter speed vary automatically according to the ambient brightness, making daylight-sync-flash possible. The aperture and shutter speed vary in the same way as with the camera's built-in flash. (See page 73.)
- It features a built-in infrared spot-beam to assist the autofocus system in dim light and low-contrast conditions.
- In the Picture Mode, Programmed AE, Shutter-Priority AE or Aperture-Priority AE Mode, even when the flash unit is set to Manual, TTL Auto Flash Mode will be set automatically on the flash unit.
- When the flash is charged and left unused for about 5 minutes, the power automatically switches off to save battery power. Depressing the shutter release button halfway down will restart charging of the flash unit.

AF200T, AF280T, and AF400T

- The shutter speed varies in the range from 1/100 to 1/30 sec. according to the ambient brightness in the TTL Auto mode, making daylight-sync-flash ideal. The slowest shutter speed varies according to the lens focal length. However, when a lens made before the Pentax A-series lens is used or when the Action Program Mode is in use, the camera uses the shutter speed of 1/100 sec.
- When the flash unit is used in the Three-Level Auto (red, green or yellow position) mode, the aperture is selected as listed in the table below. After the flash is fully charged, the shutter speed varies in the range from 1/100 to 1/30 sec. The slowest shutter speed varies according to the lens focal length. However, when a lens made before the Pentax A series lens is used or when the Action Program Mode is in use, the camera uses the shutter speed of 1/100 sec.

	AF200T	AF280T	AF400T
Red	f/2.8	f/4	f/4
Green	f/5.6	f/8	f/8
Yellow			f/11

(with ISO100 film)

Notes on Pentax Dedicated Accessory Flash Units

- 1) When using a type D flash unit in the MS (Manual Sync) or M (Manual) mode, set the aperture on the basis of the calculated aperture with the calculator board on the rear of the flash unit.
- 2) When the built-in flash is used in conjunction with a Pentax dedicated accessory flash unit, the dedicated accessory

flash unit has priority function control over the built-in flash. Ensure that the flash units are fully charged before releasing the shutter.

Contrast Control Synch Flash Photography

When the camera's built-in flash is used in conjunction with the AF500FTZ or AF330FTZ, twin-flash photography (contrast control sync flash photography) is possible, providing a flash output ratio of 1 (built-in flash): 2 (accessory flash unit).

1. Put the AF500FTZ or AF330FTZ in the contrast control sync flash mode.
 2. Ensure that both flash units are fully charged and then shoot.
- When the AF500FTZ or AF330FTZ is used off the camera, the effect of contrast control is increased. Use an optional "Hot Shoe Adapter F" (two sets with the AF330FTZ) and "Extension Cord F5P" to connect the accessory flash unit to the camera.

Do not combine an accessory with a different number of contacts such as a "Hot Shoe Grip" as a malfunction may occur.

- In the Contrast Control Sync flash mode, the camera operates in a similar manner as when the leading-curtain sync flash mode is selected except that the camera uses 1/60-sec. top flash-sync speed.

(12) ACCESSORIES

1) Accessories (Optional)

Sufficient line-ups of dedicated accessories are available for this camera. For details, please see our brochures.

• Cable Switch F

A shutter release cord designed for use with the Z-20/PZ-20, Z-1/PZ-1, Z-10/PZ-10, SFX_N/SF1_N and SF7/SF10.

• Magnifier F_B

A close-up accessory for magnifying the central area of the viewfinder.

• AF500FTZ

A TTL Auto Zoom flash with a built-in AF spot beam and large guide number 50. Features slave-sync flash function, multiple flash burst, contrast control synch flash, leading/trailing-curtain-synch flash.

• AF330FTZ Flash

A TTL Auto Zoom flash unit with a built-in AF spot beam and guide number 33. It features contrast control synch flash, leading/trailing-curtain-synch photography.

• Hot Shoe Adapter F and Extension Cord F5P

An adapter and cord which allow the AF240FT, AF330FTZ, AF400FTZ and AF500FTZ to be used off the camera.

• AF Adapter 1.7X

An adapter for autofocus photography using KA- or K-mount lenses with a maximum aperture of f:2.8 or larger.

• Macro flash AF140C

A TTL macro flash unit with the guide number 14.

Notes on Accessories

- "Auto Bellows A" cannot be used in combination with the double cable release. When taking a vertical photograph, position the camera facing the grip upward.
- When vertically positioning the camera with the tripod mount of the Pentax-F 300mm f/4.5ED(IF) lens with the grip facing downward, the tripod mount may strike the camera body. Position the camera facing the grip upward.
- When attaching the "ADAPTER K FOR 645 LENS" to the camera body, the fixing screw may hit against the camera body. To avoid this, change the position of the fixing screw.
- When attaching a Reflex 1000mm f/11 or 2000mm f/13.5 lens to the camera body, the camera position shift lock screw of the lens may strike the camera body. To prevent this, change the position of the screw.
- When the AF200SA, AF280T, AF200T, AF240Z, AF240FT or AF400FTZ is attached to the camera's hot shoe, the camera's Main Switch and Tv Av Buttons may be difficult to access.



1

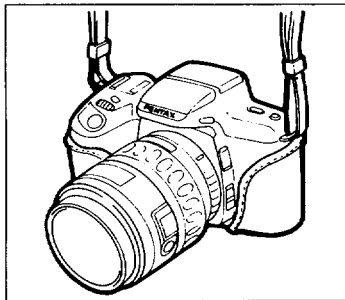

2

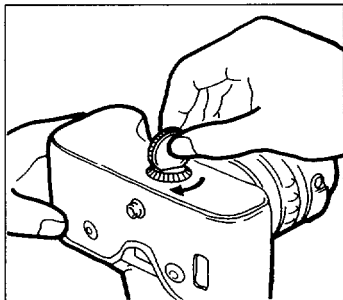

3

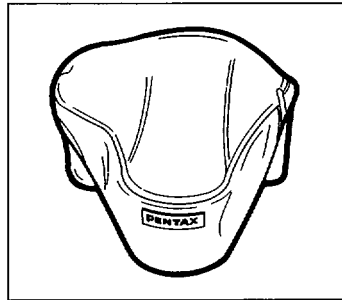

2) SOFT CASE Fc

The optional soft case consists of front and back covers.

1. Open the front cover and place the camera body in the back cover.
2. Tighten the fixing screw on the bottom with a coin to secure the cover to the camera.

Soft case comes in three sizes, S, M and L.

Case	Applicable F, FA-lens
S	50mm f/1.4 or f/1.7, Zoom 35-70mm, etc.
M	Zoom 28-80mm, Zoom 35-105mm, etc.
L	Macro 100mm, Zoom 28-105mm, Zoom 70-200mm, etc.

(13) EFFECTS OF APERTURE AND SHUTTER SPEED

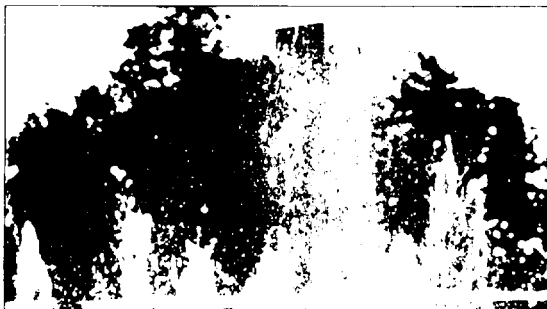

High shutter speed



Slow shutter speed

A correct exposure is established by a combination of shutter speed and aperture setting according to the subject brightness. Actually, there are many correct combinations of shutter speed and aperture for a particular subject brightness. Different shutter speed and aperture settings produce different effects. The Hyper Program-Shift and Picture Mode make it easy to produce these effects. (See pages 40 and 35.)

Effect of Shutter Speed

The shutter speed determines the film exposure time, or the amount of light striking the film. The slower the shutter speed, the longer the shutter stays open. If the subject is moving, its image will be blurred at a slow speed. In contrast, choosing a high shutter speed allows a stationary image to be taken of a moving subject. A high shutter speed prevents camera shake. It is possible to enhance the motion of a wave or a waterfall by blurring the movement using a slow shutter speed.



Closed-down aperture



Open Aperture

Effect of Aperture

The aperture increases or reduces the amount of reflected light from an object through the lens, controlling how much light strikes the film. If the aperture is opened up to increase the amount of light, objects in front of and behind an in-focus subject will not be focused. That is, the range of focus (depth of field) becomes small. If the aperture is closed down to reduce the amount of light, the depth of field increases. For example, if you shoot a person against a landscape with the aperture open, the landscape in front of and behind the person will be blurred, making the person appear to rise out of the landscape. By contrast, closing down the aperture increases the in-focus range.

- The smallest f-number refers to the largest lens opening; the largest f-number refers to the smallest lens opening.

(14) DEPTH OF FIELD

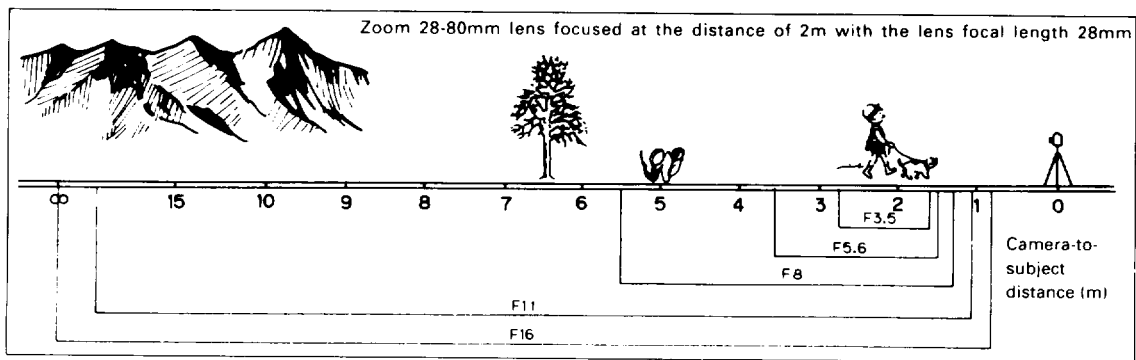

Depth of field refers to the range around the optimum focusing point of the subject in which the elements at different distances are in focus.

The depth of field increases as the aperture is closed down, the focal length of the lens becomes shorter, or the subject is positioned farther away.

The Range Allowed for Focusing

The in-focus range varies depending on the aperture in use. Zoom lenses do not have a depth-of-field scale for mechanical considerations.

(15) INFRARED INDEX

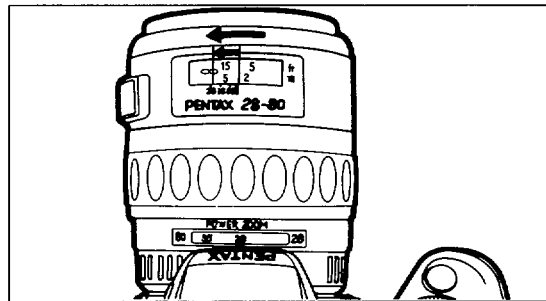
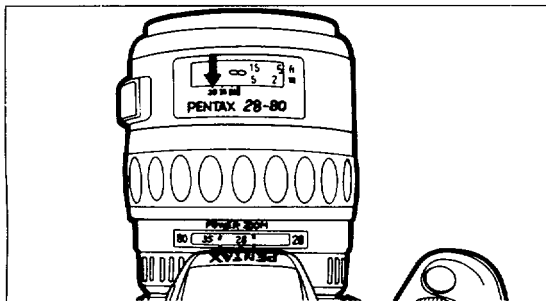

When taking infrared photographs with infrared film and either an "R2" or "02" filter, it is necessary to adjust the focus because the point of focus is not the same with infrared light as it is with visible light. Autofocus cannot adjust the focus for infrared picture. Once the camera adjusts the focus, set the focus mode lever to [**MF**]. Next, memorize the focused point on the lens distance scale and turn the focusing ring so the point you memorized aligns with the infrared index.

- To set the proper exposure level for infrared pictures, refer to the instructions accompanying the film. The Programmed AE mode does not give a correct exposure. Use the Metered Manual exposure mode.



IV. OTHERS

1) PRECAUTIONS FOR BATTERY

- The misuse of a battery can cause hazards such as leakage, overheating, explosions, etc. The battery should be inserted with the "+" and "-" sides facing correctly.
- Never try to disassemble, short or recharge the battery. Also, do not dispose of the battery in a fire, as it may explode.
- Battery performance may be temporarily hindered in low temperatures, but will recover in normal temperatures.
- Keep a spare battery on hand for replacement convenience when shooting outdoors or while traveling.
- Keep the battery out of the reach of children.
- When the camera is in a bag, ensure the Main Switch is off; otherwise, battery power may be wasted if the shutter release button is accidentally pushed.
- If the built-in flash is used continuously, the battery may become warm, but it does not mean that the battery is faulty; it is one of the battery's characteristics.

Battery Life (using 24-exposure film rolls)

General photography	About 100 rolls
Flash photography (using flash 50% of the time)	About 25 rolls
Flash photography (using flash 100% of the time)	About 15 rolls
Bulb exposure time	About 12 hours

The **2CR5** battery was used under Pentax testing conditions. Actual battery life/performance may vary drastically depending on usage of Auto-Focus, Power Zoom and Flash and external conditions such as temperature and freshness of the battery.

2) PRECAUTIONS FOR CAMERA

Your Pentax camera is a sophisticated, high-precision, and reliable mechanism. Handle it with great care.

- Be careful not to subject it to strong vibrations, shock or pressure. Use a cushion to protect the camera when carrying it in a motorcycle, car, boat, etc.
- Use a blower and lens brush to remove dust accumulated on the lens and viewfinder.
- Avoid leaving the camera for extended periods in places where temperature and humidity are high, such as in a car.
- The temperature range at which this camera functions properly is 50 °C to -10 °C (122 °F to 14 °F).
- Condensation on the interior or the exterior of the camera may be extremely harmful to the camera mechanism as it may cause rust. If the camera is taken from warm temperature to a subfreezing one or vice versa, the formation of icelets may cause damage. In such a case, put the camera into a case or plastic bag so that change in temperature is as gradual as possible. After the temperature difference is minimized, take it out of the bag. Sudden fluctuations in temperature should be avoided.
- Do not store the camera in a closet with mothballs or in a case where chemicals are handled. Store it in a place with good air circulation to prevent the fungus growth.
- Never use solvents such as paint thinner, alcohol or benzene to clean the camera.
- Dirt and dust, moisture and toxic gas or water penetrating the inside of the camera may render it inoperable. If the camera should fail for such reasons, even during the period of warranty, it may not be repaired free of charge. If the camera gets wet, wipe it off and allow it to dry.
- Never touch the shutter curtains or mirror.
- The electric circuit inside the camera contains high voltage working parts. Never attempt to disassemble it.
- Most electrical problems are caused by dirt and dust on the contacts. If electrical failure is detected, check that the contacts are free from finger marks, salt, gas or dust. Also check for battery leakage, traces of dirt or grease, or corrosion due to salinity or gas.
- Regular size color prints may cut off what appears on the extreme edges of the film frame. Compose your picture with a margin of safety at the edges.
- A camera which has been submerged in water cannot usually be repaired. However, if such an

accident should occur, it is advisable to contact a Pentax Service Center immediately.

- To maintain optimum performance, it is recommended that the camera be inspected every one or two years. If the camera has not been used for an extended period, or is being prepared for an important photographic session, it is recommended that you have the camera inspected or test shoot with it.
- When a macro or telephoto lens is used, the upper portion of the viewfinder may be darkened by the mirror. This darkening, however, does not appear on the developed prints.

LCD (Liquid-crystal display) Backup Circuit

Even if the battery is removed before the film reaches its end, the exposure number and film speed stay in memory.

LCD (Liquid-crystal display) Display

- When the LCD is exposed to high temperatures over about 60°C, it may blacken, but when the temperature normalizes, it may return to normal.
- The LCD may also slow down in response to lower temperatures, but this is a normal characteristic of an LCD.

3) TROUBLESHOOTING





What appears troublesome may be easily remedied. Here are some problems that may occur and their remedies. Before contacting a Pentax service center, check the following items.

Symptoms	Causes	Remedies	Reference
The shutter does not release.	The camera's Main Switch is off.	Turn on the camera's Main switch.	p.14
	The battery exhaustion symbol [] appears.	Replace the battery.	p.10
	The battery polarity is reversed.	Reinsert the battery properly.	p.10
	The camera is in the self-timer mode.	Clear the Self-Timer mode.	p.62
	The camera is in the Pentax Function Setting Mode.	Cancel the Pentax Function Setting Mode.	p.78
	Built-in flash is charging.	Wait until charging is complete.	p.73
Indicators do not appear on the LCD panel.	The camera's Main Switch is not turned on.	Turn on the camera's Main Switch.	p.14
	The battery has not been inserted.	Insert the battery.	p.10
	The battery polarity is reversed.	Insert the battery properly.	p.10
	The battery is dead.	Replace the battery.	p.10
The camera cannot focus the subject.	AF frame is not aimed toward the subject.	Focus on the subject with the AF frame.	p.28
	The camera is too close to the subject.	Increase the camera-to-subject distance.	p.28
	The camera is in the manual focus [MF] mode.	Set the focus mode switch to [AF].	p.28
	The subject is difficult to autofocus.	Use the focus-lock technique or use the matte area in the viewfinder for focusing.	p.30, 45
The LED indicator blinks in the viewfinder.	The camera-to-subject distance is too close or the subject is difficult to autofocus.	Use the focus-lock technique or use the matte area in the viewfinder for focusing.	p.30, 45
The built-in flash does not charge.	The battery is low.	Replace the battery.	p.10

Symptoms	Causes	Remedies	Reference
The exposure compensation cannot be set.	The Green Operation Mode is in use.	Set an exposure mode other than the Green Operation Mode.	p.22
	The Exposure Mode is set to Metered Manual.	Set an exposure mode other than the Metered Manual Exposure Mode.	p.55
Zoom Clip mode cannot be set.	The lens is set at manual zoom mode.	Push the power zoom ring of the lens forward until the words POWER ZOOM appear.	p.64
	The lens Auto Zoom Switch is set at [P].	Set the lens Auto Zoom Switch to [A].	p.64
The Image Size Tracking Mode cannot be set.	The camera's focus-mode switch is set to Manual Focus Mode [MF].	Move the camera's focus mode switch to [AF].	p.67
	The lens is set at manual zoom mode.	Push the power zoom ring of the lens forward until the words POWER ZOOM appear.	p.64
	The lens Auto Zoom Switch is set at [P].	Move the lens Auto Zoom Switch to [A].	p.64
The power zoom does not work.	The lens is set at manual zoom mode.	Push the power zoom ring of the lens forward until the words POWER ZOOM appear.	p.25
While shooting, the lens is zoomed unexpectedly.	The camera is in the Image Size Tracking Mode.	Clear the Image Size Tracking Mode.	p.67
The Zoom Effect Mode cannot be set.	The lens is in the manual zoom mode.	Push the Power Zoom ring of the lens forward until the words POWER ZOOM appear.	p.64
Sharp picture focus is maintained while the lens is zooming.	When the lens is zooming with the power zooming function, sharp picture focus is maintained while the lens is zooming.	Maintaining a sharp picture focus during a power zooming operation can be canceled by using Pentax Function 2.	p.80
Learning function does not work.	The exposure mode other than the Picture Mode is in use.	Use the Picture Mode other than the Green Operation Mode.	p.35
	Learning function has been canceled by Pentax Function 4.	Activate the learning function by Pentax Function 4.	p.81

4) SPECIFICATIONS

Type:	TTL AE/AF 35mm SLR with built-in TTL auto flash
Format:	24 × 36mm
Film:	35mm cartridge film. DX coded-film with ISO25-5000; non-DX-coded film with ISO6-6400
Exposure Mode:	Picture Mode (Green Operation mode, Portrait Program mode, Landscape Program mode, Action Program mode, Close-up Program mode); Programmed AE mode; Shutter-Priority AE mode; Aperture-Priority AE mode; Metered Manual mode; Bulb mode
Shutter:	Electronically controlled vertical-run focal-plane shutter. Auto:1/2000-30sec (stepless), Manual: 1/2000-30sec., Bulb., Electromagnetic release, Shutter lock by turning the camera's Main Switch off.
Lens Mount:	Pentax KAF2 bayonet mount (=K-mount with AF coupler, lens information contacts and power contacts)
Compatible Lens:	Pentax KA-F2-, KA-F-, KA-, and K-mount lenses are usable. Autofocus is possible using the AF Adapter with KA- and K-mount lenses.
Autofocus System:	TTL phase-matching system (SAFOX III). AF operational brightness range: EV1-18 (at ISO100 with f/1.4 lens) Focus lock available using shutter release button, Focus mode: AF (predictive AF provided), Manual [MF]
Power Zoom:	3-speed power zoom, Zoom Clip Mode, Image Size Tracking mode, Auto Zoom Effect when combined with an FA zoom lens
Viewfinder:	Penta-mirror finder, Aspheric-micro-matte focusing screen. Field of view: 92%, Magnification: 0.77 × (with 50mm lens at ∞), -1 diopter eyepiece
Viewfinder Indication:	Focus information: in-focus ([] is lit), unable-to-focus indication ([] blinks) // Shutter speed indication Aperture value indication, Accessory/Built-in flash ready indication ([] is lit), Flash-recommended display: ([] blinks slowly. In appropriate lens warning: [] blinks rapidly/Bar Graph [] exposure compensation value, over-/underexposure. Shifted amount indication of learning function, Shifted amount indication of Hyper Program-Shift, ([] / [] =Depth-of-field Indicator, [] / [] =Action Indicator
LCD panel indication:	([]) =Green Operation Mode, ([]) =Portrait Program mode, ([]) =Landscape Program mode, ([]) =Action Program mode, ([]) =Close-up Program mode, ([]) =Programmed AE mode, ([]) =Shutter-Priority/Aperture Priority AE mode, ([]) =Metered Manual Exposure mode, Exposure compensation=-3.0-3.0, ([]) =Image Size Tracking mode, ([]) =Zoom Clip mode, ([]) =Auto Zoom Effect mode, Shutter speed indication=2000-30s, Bulb= [], Aperture indication=f/1.2-9.0, ISO=6-6400, Bar graph (exposure compensation, over-/underexposure indication in Metered Manual mode, Shifted amount indication of learning function, Shifted amount indication of Hyper Program-Shift, [] =Film status information (load/advance/rewind) symbol, ([]) =Battery exhaustion mark, Film counter indication=0-99, ([]) =RTF ready indication, ([]) =Flash-recommended display, ([]) = blinking rapidly = Inappropriate lens warning, ([]) =Self-timer indication, ([]) =Tv indication, ([]) = Av indication, ([]) =Red-eye reduction flash indication, ([]) =Consecutive shooting mode, ([]) =Learning func-

Self-Timer:	tion mode, []/[]=Depth-of-field Indicator, []/[]=Action Indicator Electronically-controlled type with delay time of 12 sec.; start by depression of shutter release button; audible PCV signal; Cancelable after operation
Mirror:	Quick-return mirror with AF secondary mirror
Film Loading:	Film advances automatically to 1st frame after the back cover is closed. Film information window is provided.
Film Wind & Rewind:	Auto wind/rewind and auto rewind stop by built-in motor. Consecutive or single advance mode. Approx. 2 frames sec. (continuous mode), Auto rewinding starts at end of roll. Film rewinding/completion of rewinding is displayed on the LCD panel. Mid-roll rewind provided.
Exposure Meter/ Metering Range:	TTL multi(6)-segment metering, Metering range from EV1 to EV21 at ISO 100 with 50mm f/1.4 lens. Spot Metering in Metered Manual mode.
Exposure Compensation:	+/-3EVs in 0.5 stop increments
Built-in Flash:	Series-control, retractable TTL Auto Flash (RTF); Guide number:13 (ISO 100/m). Illumination angle: covers 28mm lens angle of view. Automatic switch to flash-synch-speed in the range from 1/100 to 1/30sec. Daylight-sync-flash, Slow-speed sync and Contrast control sync is possible. Usable films: ISO 25-400
Flash Sync:	With built-in RTF or hot shoe with X-contact which couples with Pentax dedicated auto flashes with ISO25-800
Power Source:	One 6V lithium battery 2CR5
Battery Exhaustion	Battery exhaustion symbol [] is lit. (blinking when the shutter is locked; indication disappears on the right hand edge of the viewfinder.)
Warning:	
Pentax Functions:	5 user-defined functions
Learning Function:	Learning function works in Hyper Program-Shift
Back Cover:	Interchangeable
Dimensions & Weight:	146.0mm(W)×93.0(H)×69.5(D)(5.7"×3.7"×2.7") 520g (18.3oz.) without lithium battery
Supplied Accessories:	Hot shoe cover Fe, Release socket cap Fe, Camera strap Fc, Eyecup Fe, Finder cap

SPECIFICATIONS ARE SUBJECT TO CHANGE AT ANY TIME WITHOUT NOTIFICATION OR ANY OBLIGATION ON THE PART OF THE MANUFACTURER.

Program Line (Normal Program/Green Operation Mode)

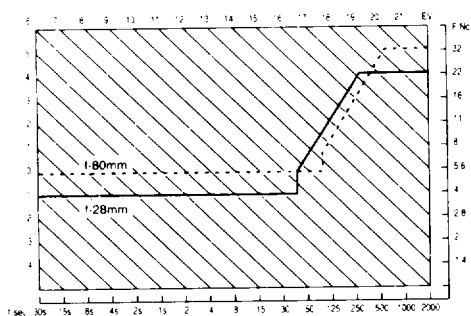

ISO100 FA28-80mm f/3.5-4.7

Program Line (Landscape Program Mode)

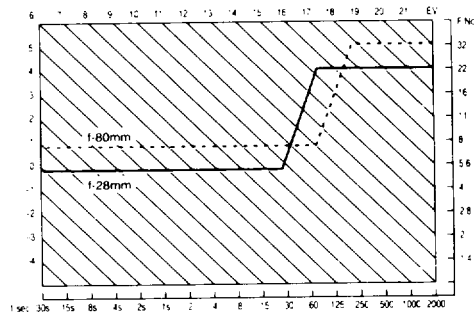

ISO100 FA28-80mm f/3.5-4.7

Program Line (Portrait Program Mode)

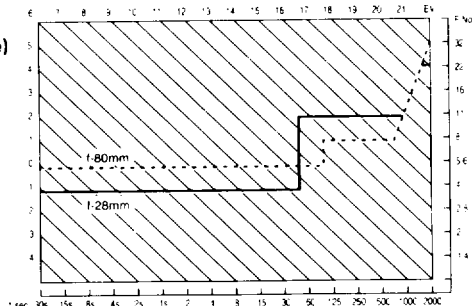

ISO100 FA28-80mm f/3.5-4.7

Program Line (Program Action Mode)

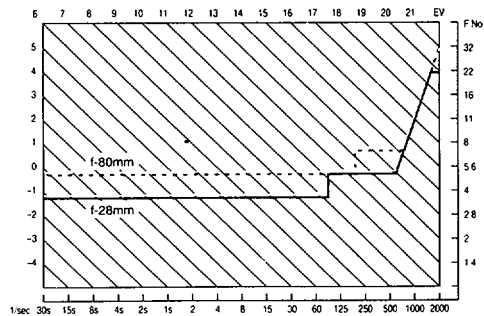

ISO100 FA28-80mm f/3.5-4.7

Program Line (Close-up Program Mode)

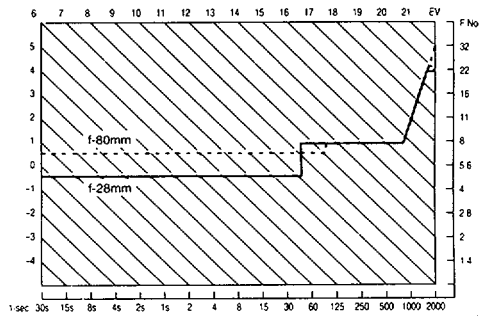

ISO100 FA28-80m f/3.5-4.7

WARRANTY POLICY

All Pentax cameras purchased through authorized bona fide photographic distribution channels are guaranteed against defects of material or workmanship for a period of twelve months from date of purchase. Service will be rendered, and defective parts will be replaced without cost to you within that period, provided the equipment does not show evidence of impact, sand or liquid damage, mishandling, tampering, battery or chemical corrosion, operation contrary to operating instructions, or modification by an unauthorized repair shop. The manufacturer or its authorized representatives shall not be liable for any repair or alterations except those made with its written consent and shall not be liable for damages from delay or loss of use or from other indirect or consequential damages of any kind, whether caused by defective material or workmanship or otherwise; and it is expressly agreed that the liability of the manufacturer or its representatives under all guarantees or warranties, whether expressed or implied, is strictly limited to the replacement of parts as hereinbefore provided. No refunds will be made on repairs performed by non-authorized Pentax service facilities.

Procedure During 12-month Warranty Period

Any Pentax which proves defective during the 12-month warranty period should be returned to the dealer from whom you purchased the equipment or to the manufacturer. If there is no representative of the manufacturer in your country, send the equipment to the manufacturer, with postage prepaid. In this case, it will take a considerable length of time before the equipment can be returned to you owing to the complicated customs procedures required. If the equipment is covered by warranty, repairs will be made and parts replaced free of charge, and the equipment will be returned to you upon completion of servicing. If the equipment is not covered by warranty, regular charges of the manufacturer or of its representatives will apply. Shipping charges are to be borne by the owner. If your Pentax was purchased outside of the country where you wish to have it serviced during the warranty period, regular handling and servicing fees may be charged by the manufacturer's representatives in that country. Notwithstanding this, your Pentax returned to the manufacturer will be serviced free of charge according to this procedure and warranty policy.

In any case, however, shipping charges and customs clearance fees are to be borne by the sender. To prove the date of your purchase when required, please keep the receipts or bills covering the purchase of your equipment for at least a year. Before sending your equipment for servicing, please make sure that you are sending it to the manufacturer's authorized representatives or their approved repair shops, unless you are sending it directly to the manufacturer. Always obtain a quotation for the service charge, and only after you accept the quoted service charge, instruct the service station to proceed with the servicing.

The warranty policy does not apply to Pentax products purchased in the U.S.A., UK, or Canada. The local warranty policies available from Pentax distributors in those countries supersede this warranty policy.

NAMES OF WORKING PARTS (BACK)

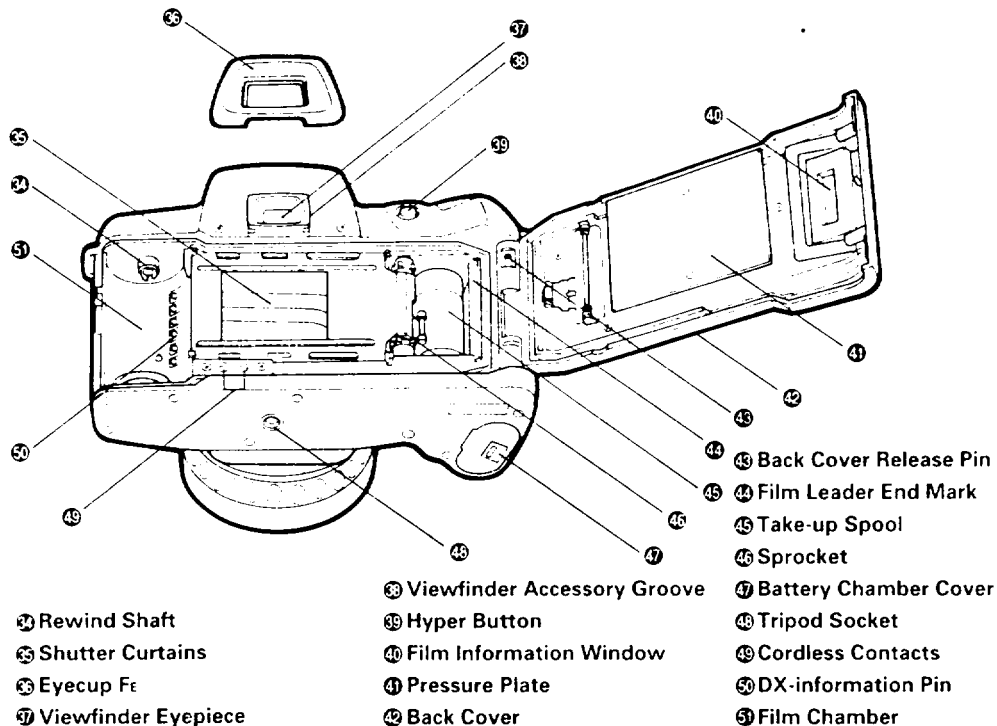

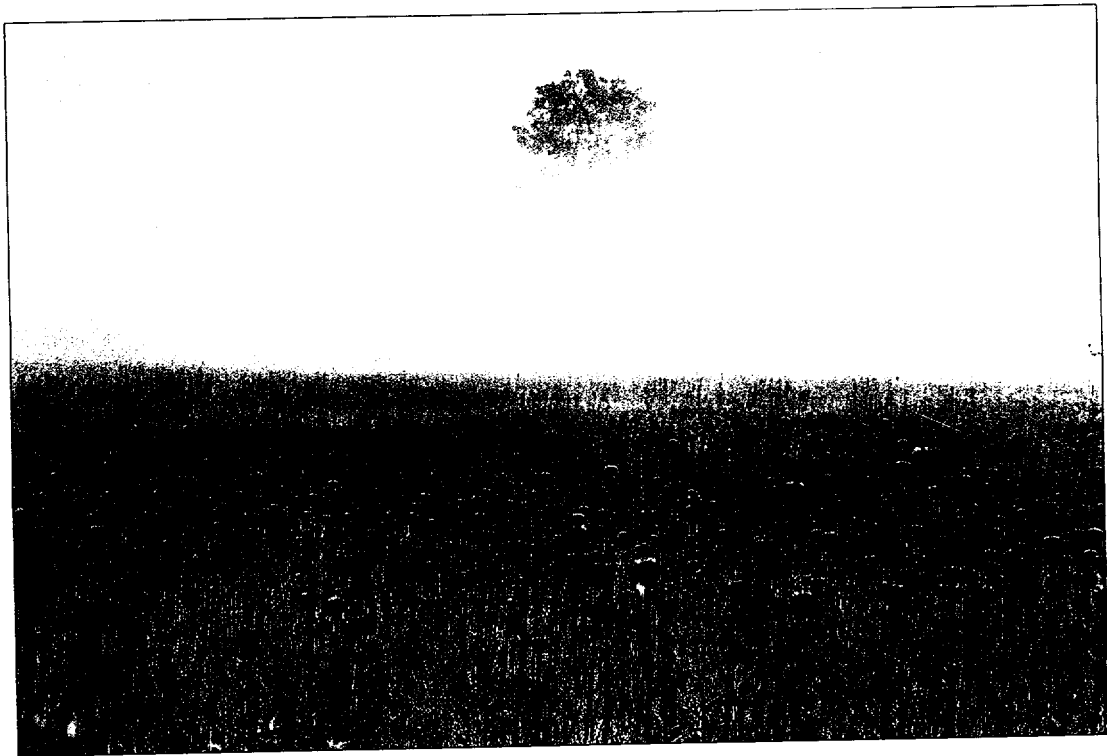



Asahi Optical Co., Ltd. 11-1 Nagata-cho 1-chome, Chiyoda-ku Tokyo 100 JAPAN
Pentax Europe n.v. Weveldlaan 3-5, 1930 Zaventem, BELGIUM
Pentax Handelsgesellschaft mbH. Julius-Vosseler-Strasse 104 2000 Hamburg 54, GERMANY
Pentax U.K. Limited. Pentax House, South Hill Avenue, South Harrow, Middlesex HA2 0LT, U.K.
Pentax France ZI Argenteuil, 12, rue Ambroise Croizat, 95100 Argenteuil, FRANCE
Pentax Benelux (for Netherlands) Spinveld 25, 4815 HR Breda, NETHERLANDS
(for Belgium & Luxemburg) Weveldlaan 3-5, 1930 Zaventem, BELGIUM
Pentax (Schweiz) AG Industriestrasse 2, 8305 Dietlikon, SWITZERLAND
Pentax Scandinavia AB Falhagsleden 57, 75127 Uppsala, SWEDEN
Pentax Corporation 35 Inverness Drive East, Englewood, Colorado 80112, U.S.A.
Pentax Canada Inc. 3131 Universal Drive, Mississauga, Ontario L4X 2E5, CANADA
Asahi Optical Brasileira Ind. e Com. Ltda. Rua Estados Unidos 1053 São Paulo, BRAZIL

Free Manuals Download Website

<http://myh66.com>

<http://usermanuals.us>

<http://www.somanuals.com>

<http://www.4manuals.cc>

<http://www.manual-lib.com>

<http://www.404manual.com>

<http://www.luxmanual.com>

<http://aubethermostatmanual.com>

Golf course search by state

<http://golfingnear.com>

Email search by domain

<http://emailbydomain.com>

Auto manuals search

<http://auto.somanuals.com>

TV manuals search

<http://tv.somanuals.com>