

PENTAX®

ZOOM 60-X

ZOOM 60-X DATE

OPERATING MANUAL



OUTLINE OF BASIC OPERATIONS

1

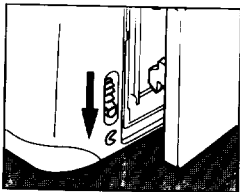

Open the back cover (see page 8).

2

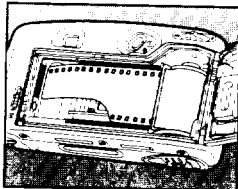

Load the film and close the back cover (see page 8).

3

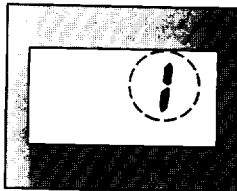

The film automatically advances to the first frame (see page 9).

4

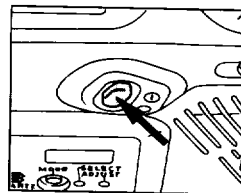

Switch on the power (see page 4).

5

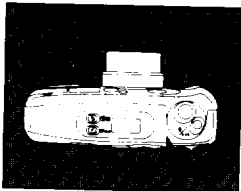

Frame your subject and operate the zooming lever to determine the composition (see page 6).

6

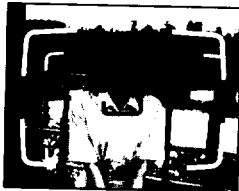

Focus your subject (see page 12).

7

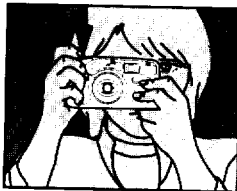

Press the shutter release button. In dark conditions, the flash fires automatically (see page 13).

8

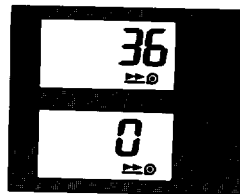

When the film reaches its end, the camera automatically rewinds it (see page 16).







INTRODUCTION

Welcome to the world of Pentax zoom compact photography! This compact, lightweight camera is a great companion to help you preserve memorable moments anywhere at any time. A built-in 38 ~ 60 mm zoom lens allows flexibility in shot framing. A variety of features, mostly automatic, makes it virtually effortless for you to take great pictures. The model with the date function makes it easy to remember when photos are shot.

- Please read this manual carefully before operating the camera to learn how to take consistently superior pictures.
- Pay particular attention to cautions, warnings, and notes in this operating manual. Pictures and illustrations shown within may differ from the camera's actual appearance. Sample photos were not taken with this camera.
- Illustrations in this manual show the DATE model.

Names of the camera's working parts are listed on front and back foldout flaps of this manual. Keep the flaps unfolded for quick reference while you read.

Symbols used in this manual:

Operation direction	
Automatic operation	
Attention	
Lamp glowing	
Lamp flickering	
Correct	
Incorrect	



NAMES OF WORKING PARTS

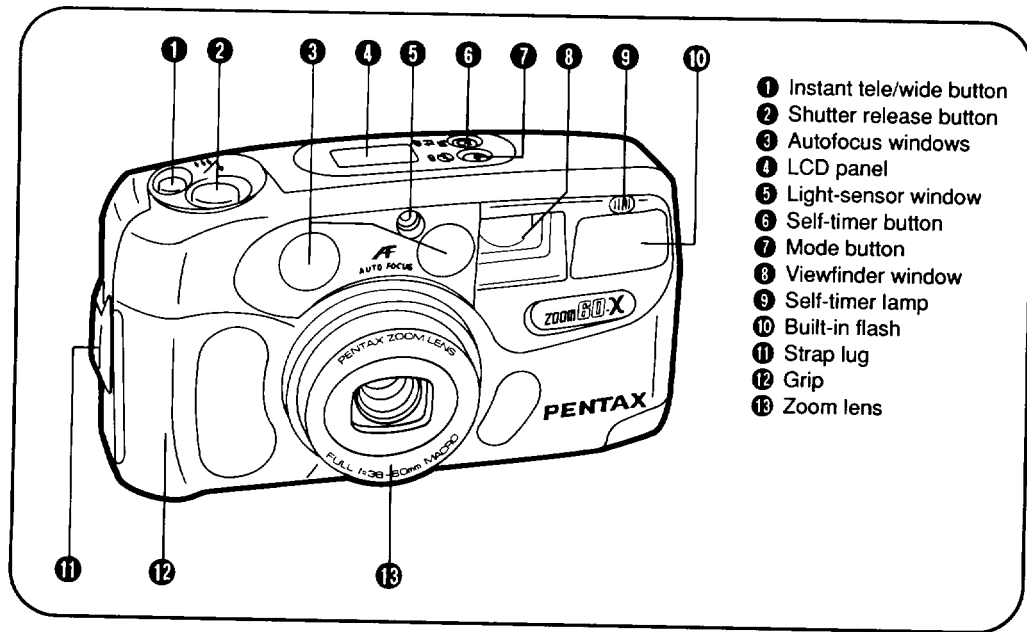

CAUTIONS

- Shield the camera from salty air and water at the beach, splashing liquid of any kind, and rain. If immersed in water, the camera will be rendered inoperable.
- If the camera is exposed to dirt, mud, sand, dust, moisture, toxic gas or salt water, the camera may be damaged or rendered inoperable.
- Avoid leaving the camera for extended periods where temperature and humidity are high, such as in a car.
- Never use solvents such as paint thinner, alcohol or benzine to clean the camera.
- Be careful not to drop or otherwise subject the camera to strong vibrations, shock or pressure.
- Do not apply force to the zoom lens; do not place the camera with the lens facing down.
- The electric circuitry inside the camera contains high voltage working parts. Never attempt to disassemble the camera.
- Keep the batteries out of the reach of children.
- Replace all batteries at the same time. Do not mix battery brands, types or old battery with new one. Otherwise, overheating or fire might result.
- The misuse of batteries causes hazards such as leakage, heating, explosions, etc. Batteries should be inserted with the "+" or "-" sides facing correctly.
- To prevent explosion, never try to break up or recharge the batteries, or throw exhausted ones into fire.

TABLE OF CONTENTS

- Names of working parts Flaps
- Introduction Front foldout
- Outline of basic operations Inside cover

CAUTIONS ①

PREPARATIONS BEFORE TAKING PHOTOGRAPHS

1. Strap attachment ③
2. Power switch and battery check ④
3. How to hold the camera ⑤
4. Continuous zoom and instant tele/wide ⑥

TAKING PHOTOGRAPHS

1. Usable film ⑦
2. Film loading ⑧
3. Viewfinder displays and shooting range ⑩
4. Green/red lamps ⑪
5. Ordinary photography ⑪
6. Taking pictures ⑫
7. Focus-lock shooting ⑭
8. Unloading film ⑮

②

TAKING BETTER PHOTOGRAPHS

- How to select modes ⑮
- LCD panel ⑲
- Daylight-Sync mode (forced emission) ⑳
- Flash Off mode (flash override) ㉑
- Bulb mode ㉑
- Self-Timer modes ㉒
- DATE MODEL ㉔

MAINTENANCE CONSIDERATIONS

- Battery exhaustion warning ㉖
- Replacing batteries ㉗
- Taking care of your camera ㉘
- Troubleshooting ㉚
- Warranty policy ㉛

SPECIFICATIONS Back foldout

PREPARATIONS BEFORE TAKING PHOTOGRAPHS

You should be aware of certain fundamentals to make it easier to use this camera in the best way.

1. STRAP ATTACHMENT

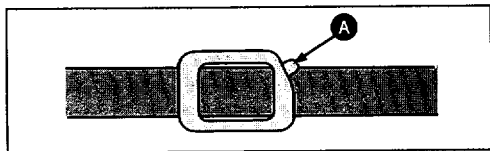
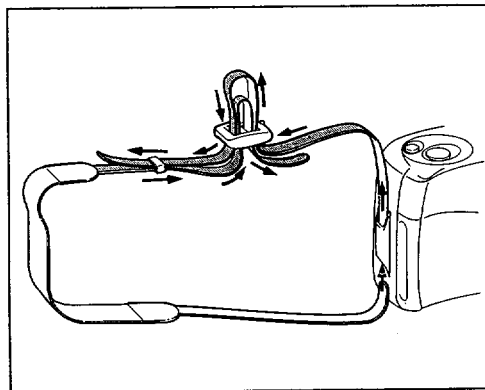

Attach and adjust the camera strap as illustrated. On the DATE model, use the strap clamp's protrusion **A** to press the SELECT and ADJUST buttons.

Note:

- Adjust the strap so that the camera is positioned above your waist to minimize camera sway when you walk.

2. POWER SWITCH AND BATTERY CHECK

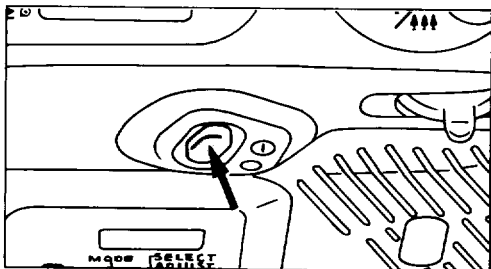

Power switch

To switch on, push the power switch. The lens extends slightly, and the lens cover opens. To switch off, push the power switch again. Make sure the camera is switched off when not in use.

Caution:

The lens cover automatically opens when the power is turned on, and closes when the power is turned off. Never attempt to open the lens cover by hand.

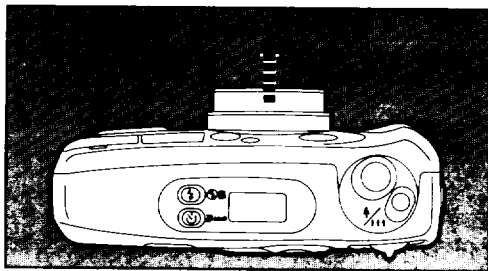

Battery check

After power is switched on, the lens extends slightly and the lens cover opens. The camera is then ready to shoot.

Notes:

- When the camera is left unused with the power on for over 3 minutes, its power automatically switches off.
- Use two 3 V lithium batteries (CR123A or DL123A). Do not remove the batteries until they are exhausted, since they are also used by the date function on the DATE model to keep constant track of time.
- Refer to page 27 for directions on battery insertion.

3. HOW TO HOLD THE CAMERA

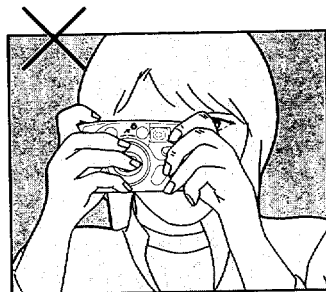
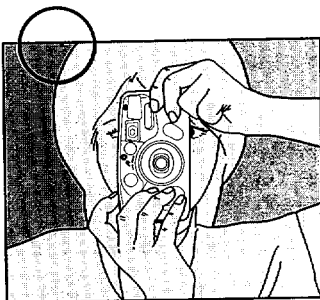
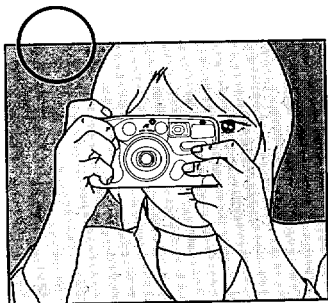

When shooting, hold the camera securely with both hands. Keep the camera as still as possible, and gently press the shutter release button. (If pressed forcefully, the camera is likely to shake, and the picture will be blurred.) Try to brace your elbows against your body, or support yourself and the camera against a stable, stationary object, such as a wall.

Caution:

Do not hold the zoom lens because it moves back and forth when zooming.

Notes:

- When using flash with the camera vertically positioned, hold the camera so that the flash is above the lens.
- Keep your fingers and hair away from the lens, autofocus window, sensor window, flash, etc.

4. CONTINUOUS ZOOM AND INSTANT TELE/WIDE

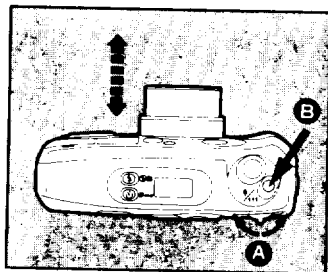

38 mm

60 mm

A Continuous Zoom

When you press the zooming lever to the right (), the lens frames the subject more tightly, moving towards the 60 mm telephoto setting. When you press the zooming lever to the left (), the lens moves towards the wider-angle 38 mm setting. Release your finger from the zooming lever when you've framed the composition in the best possible way through the viewfinder, and press the shutter release button.

B Instant Tele/Wide

Pressing the instant tele/wide button alternates the maximum focal length lens position with the minimum focal length lens position.

Note:

- When the lens is at a relatively wide-angle position and the button is pressed, the lens will move to the 60 mm position; when the lens is at a relatively telephoto position and the button is pressed, the lens will move to the 38 mm position.

⑥

TAKING PHOTOGRAPHS

After reading through this section to familiarize yourself with operations, you are ready to insert the film.

1. USABLE FILM

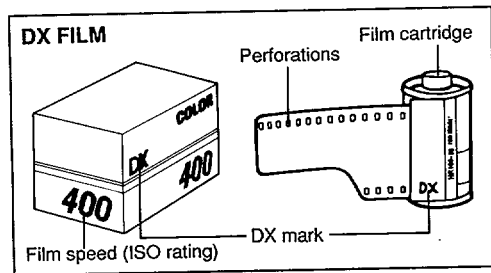

Automatic film speed setting

This camera is designed to use DX-coded films with ISO ratings from 50 to 1600. When such film is loaded, the camera automatically sets itself for the film's speed.

Notes:

- When buying DX film, make sure the package bears the "DX" mark.
- Non-DX film cannot be used.
- Use high-speed film with an ISO rating of 1000 or higher for shooting indoors or dimly lit conditions.

2. FILM LOADING First, make sure that the power is off.

1

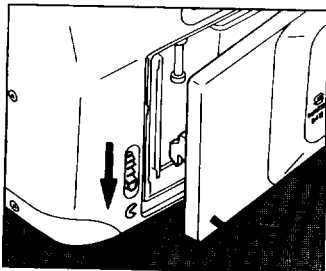

2

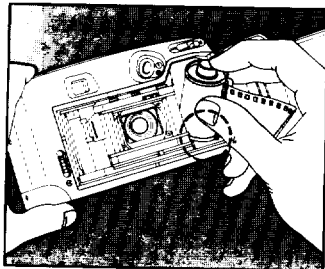

3

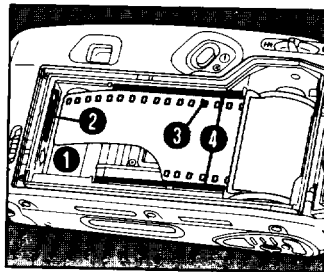

- 1 To open the back cover, slide the back cover release lever in the direction of the arrow as illustrated.
- 2 Place the film cartridge in the film chamber, fitting its flat side on top of the rewind shaft.
- 3 Pull the film leader out far enough from the cartridge to reach the take-up spool 1. Align the film's tip with the film leader end mark 2.

Notes:

- Make sure the film perforations properly engage the sprocket teeth 3.
- Make sure the film is properly placed between the guide rails 4.

- Make sure the film is taut as illustrated. Take up any slack in the film by pushing it back into the cartridge.
- If the end of the film leader is extremely bent, straighten it or cut off the bent portion.

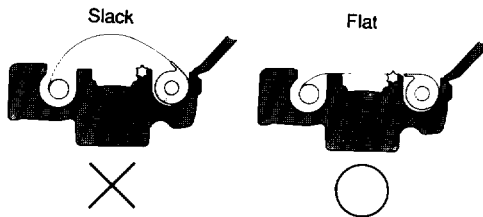

8

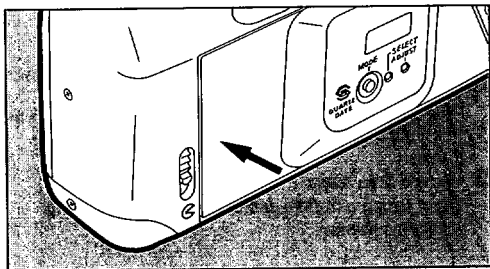
4

- 4** Close the back cover. The film automatically advances to the first frame. (Even if no film is loaded, the motor operates for a second or two after the back cover is closed.)

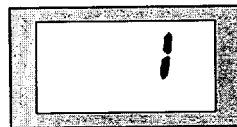
5

- 5** When " | " appears in the exposure counter on the LCD panel, the film automatically stops winding, and the first exposure is ready to be taken. The indication seen above appears.

Notes:

- If " | " does not appear on the LCD panel, the film is not properly loaded. Reload the film.
- If the film is not properly loaded, " E " flickers on the LCD panel.
- The exposure counter remains visible even when the power is off.

3. VIEWFINDER DISPLAYS AND SHOOTING RANGE **First, make sure the power is on.**

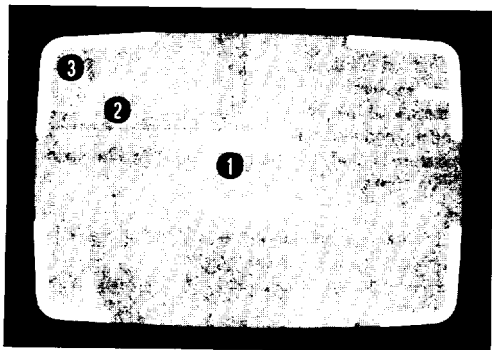

Viewfinder displays

① Autofocus frame

Position the whole (□) on the subject of focus.

② Close distance compensation frame

When the camera-to-subject distance is between 0.6 m (2 ft) and 1 m (3.3 ft), compose the picture within this frame.

③ Picture-area frame

When taking a normal picture, compose the picture within this frame.

Shooting ranges

(effective camera-to-subject distance)

- Pictures can be taken within the range of 0.6 m (2 ft) to ∞ (infinity).
- A subject closer than 0.6 m (2 ft) cannot be shot in sharp focus.

4. GREEN/RED LAMPS

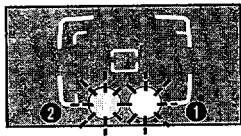

When you press the shutter release button halfway, the lamps ① and ② shown on the left glow or flicker.

① Green lamp

When it glows, the subject is in focus. When using the focus lock function, it indicates that focus and exposure are temporarily locked (refer to page 14).

② Red lamp

When it glows, the flash is ready to fire. When it flickers, the flash is being charged.

Note:

- If the green lamp flickers, the subject is too close. Adjust the camera-to-subject distance so that the green lamp glows, then release the shutter. (When the subject is even closer, at less than 30 cm (1 ft), the green lamp may glow).

5. ORDINARY PHOTOGRAPHY (AUTO AND SINGLE-FRAME SHOOTING)

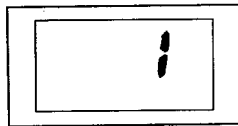

When the power is switched on, the camera enters the ordinary shooting mode. (The LCD panel displays only the exposure counter

indication whether the power is on or off.) In this mode, the flash fires automatically in dimly lit places.

Notes:

- If the LCD panel displays indications other than those above, switching the power off, then on again resets the LCD panel to appear as above.
- The shutter speed when the flash fires automatically is approximately 1/40 sec.

6. TAKING PICTURES Shooting distance: 0.6 meters (2 ft) ~ ∞ (infinity)

1



- 1 After zooming and composing your shot using the zooming lever or instant tele/wide button, position the autofocus frame (□) on the subject.

2

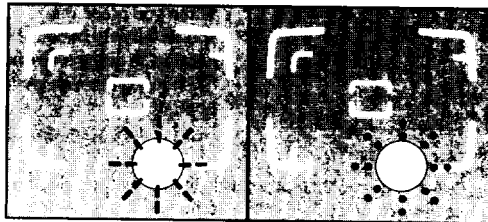

- 2 Press the shutter release button halfway. If the subject is in focus, the green lamp should glow. If the subject is closer than 0.6 meters (2 ft), the green lamp flickers. In this case, release your finger from the shutter release button and lengthen the camera-to-subject distance. Then, press the shutter release button halfway again, making sure the green lamp glows.

Notes:

- If you wish to shift subject focus, release your finger from the shutter release button and repeat steps 1 and 2 above.
- The shutter cannot be released while the lens is zooming.
- When the red lamp glows, the flash will automatically fire. Make sure that the subject is within the flash-effective range before shooting (refer to next page).

3

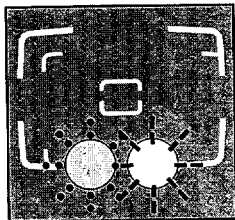
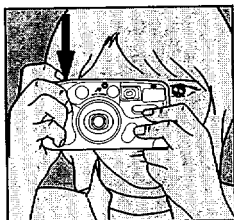

- 3 Press the shutter release button all the way down. The shutter will be released, and the film will automatically advance to the next frame.

Note:

- When the shutter is released, the self-timer lamp glows momentarily to indicate that a shot has been taken.

* **When taking pictures in the dark, the flash automatically fires.**

When the shutter release button is pressed lightly in dim lighting, the red lamp glows, indicating that the flash is ready to fire. Make sure the red lamp glows before shooting.

Flash-effective ranges

(Nega-color film used)

Lens	ISO	100	200	400
38mm ($\uparrow\uparrow\uparrow$)		0.6 ~ 3m (2 ~ 10ft)	0.6 ~ 4.3m (2 ~ 14ft)	0.6 ~ 6m (2 ~ 20ft)
60mm (\uparrow)		0.6 ~ 2m (2 ~ 6.6ft)	0.6 ~ 3m (2 ~ 10ft)	0.6 ~ 4m (2 ~ 13ft)

7. FOCUS-LOCK SHOOTING



If you shoot without positioning the autofocus frame (□) on the main subject of the picture as shown above, only the background will be in focus. When the main subject of your picture is off the autofocus frame (□) in the center of the viewfinder, use the focus-lock technique according to the following procedures.

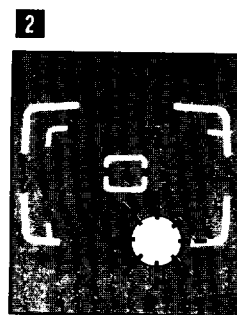

- 1** First position the autofocus frame (□) on the area to be focused upon. If that area is too small to take up the entire autofocus frame (as when trying to focus on a faraway face), position the autofocus frame (□) on a larger equidistant object (like the subject's chest).
- 2** As you press the shutter release button halfway, the green lamp glows, and focus and exposure are temporarily locked.

3



- 3 Recompose the picture while keeping the shutter release button depressed halfway, and then fully depress the shutter release button to take a picture.

Note:

- Taking your finger off the shutter release button in its halfway position cancels focus lock .

Hard-to-autofocus subjects

Like many other autofocus cameras, this camera's autofocus system is highly precise, but it may not focus exactly as you wish on certain subjects. In such cases, use the focus-lock technique on a subject which is both near the actual one and at an equal distance from the lens.

Subjects which are hard to autofocus include:

1. Black objects, like hair, which don't reflect much light
(and therefore don't reflect infrared autofocus beams).
2. Wire netting, latticework, iron exercise-bars, etc.
3. Flickering light sources such as neon signs, fluorescent lamps, TV images, sunlight coming through trees, etc., and subjects illuminated by these light sources.
4. Glossy and reflective surfaces like glass, mirrors, car bodies, etc.
5. Fast-moving objects, like trains in motion.
6. Water jets, water surface, smoke, flame, fireworks, etc., which have no distinct or consistent form, or a subject in mist.

8. UNLOADING FILM Be sure to remove the film from the camera in the shade.

1

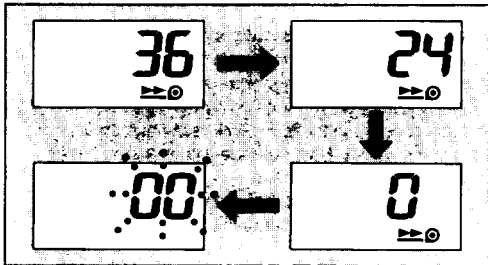

- 1 After you have shot the last frame of the roll, film rewinds automatically. Then, the motor stops, and the "00" flickers as shown to indicate end of rewind.

2

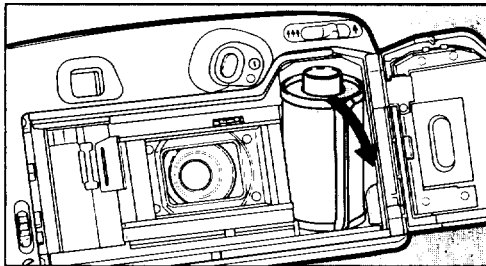

- 2 Open the back cover, and remove the cartridge from the chamber by pulling on its top with your fingertip as shown.

Note:

- The shutter may continue to release for a frame or two after the number of exposures indicated on the film canister has been shot, but the last frame may not be developed.

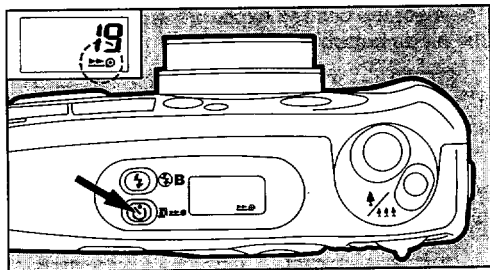
1

Rewinding the film in midroll

- 1** If you wish to unload the film before exposing all the frames, push the self-timer button for more than 3 seconds. " 19 " appears on the LCD panel, and the camera is now ready to rewind the film.
- 2** While keeping the self-timer button pressed, press the shutter release button. The camera will start rewinding the film. When the rewind is completed, the motor stops, and "00" flickers on the LCD panel, indicating the back cover may be safely opened.

Caution:

Never open the back cover until rewinding is completed.

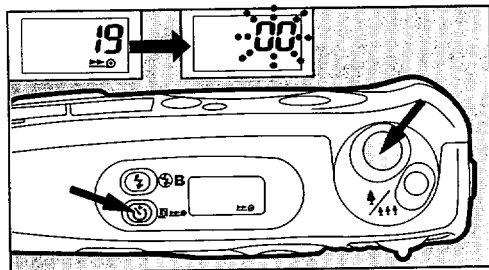
2

Notes:

- During rewinding, the exposure counter counts frame numbers in reverse.
- A 24-exposure film roll takes about 20 seconds to be rewound.
- The entire roll of film including the film leader is always rewound into the cartridge to avoid leakage of light onto any part of the film.

TAKING BETTER PHOTOGRAPHS

There are a variety of ways to take the picture you want.

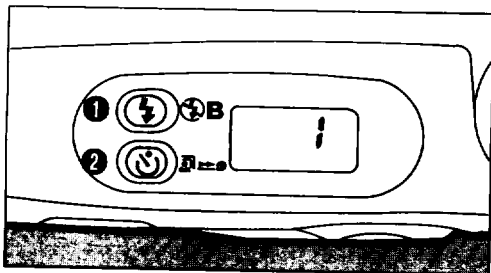

HOW TO SELECT MODES

To select the desired exposure modes, press the mode button ①.

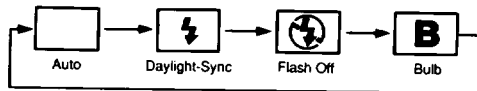

To select the desired self-timer modes, press the self-timer button ②.

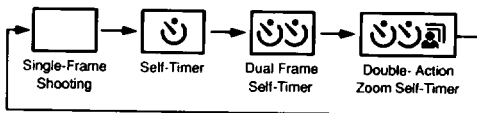

Press the mode button ① and/or the self-timer button ② in succession to set the required modes.

Note:

- When the power is switched on, the Auto and Single-Frame modes are automatically engaged.

LCD PANEL All indications will not actually appear simultaneously as shown.

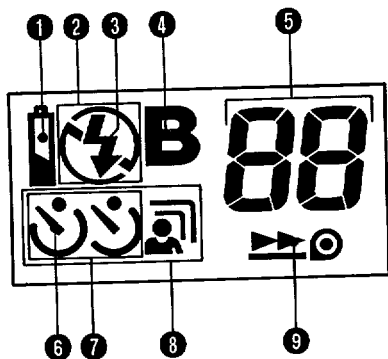

- 1 Battery exhaustion warning
- 2 Flash Off mode
- 3 Daylight-Sync mode
- 4 Bulb mode
- 5 Exposure counter
- 6 Self-Timer mode
- 7 Dual-Frame Self-Timer mode
- 8 Double-Action Zoom Self-Timer mode
- 9 Film rewind

Notes:

- At a high temperature of approx. 60°C (140°F), the LCD panel may blacken. It returns to normal when normal temperature is restored.
- At lower temperatures, the response speed of the LCD panel may be slower. This is an LCD characteristic, not a defect.

DAYLIGHT-SYNC MODE (FORCED EMISSION)

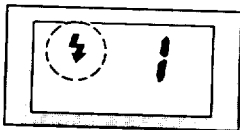

In this mode, the flash will always fire regardless of the available light. Press the mode button until "⚡" appears on the LCD panel.

In portrait photography such as when the subject is backlit or the subject is shadowed by trees, the main subject sometimes turns out darkened because the camera automatically sets the exposure according to the bright background. In such cases, use the Daylight-Sync Shooting mode so that both the subject and background are shot in beautifully balanced lighting.

Note:

- Press the shutter release button halfway to make sure the red lamp in the viewfinder glows before shooting. When the red lamp flickers, the flash is being charged.
- Make sure you're within the flash-effective distance range even when the flash is used as an auxiliary light source.



Without Daylight-Sync



With Daylight-Sync



Flash Off

FLASH OFF MODE (FLASH OVERRIDE)



In this mode, the flash does not fire, and a picture is taken at a slower shutter speed as slow as approx. 1/4 sec. Press the mode button

until "⚡" appears on the LCD panel.

Use this mode in situations where flash photography is prohibited, such as in theaters, museums, etc., or when you want to capture the natural-looking ambience of softer light.

Notes:

- When shooting in darkness, the shutter speed gets slower, and camera shake is more likely to blur your shot, so use a tripod.
- If the "⚡" flickers on the LCD panel when the shutter release button is pressed halfway, switch the mode to Auto (automatic flash emission). If the shutter release button is pressed all the way while "⚡" is flickering, the picture will be insufficiently exposed.

BULB MODE



In this mode, the shutter remains open as long as the shutter release button is held down for up to 8 seconds. It is useful for shooting such things

as fireworks and night scenes. When using this mode, you should avoid camera shake by using a tripod, etc.

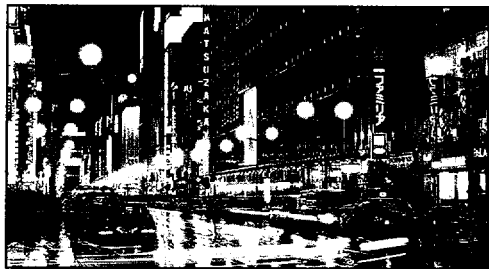

SELF-TIMER MODES Use of a tripod is recommended.



Self-Timer

Use the self-timer to get the photographer into the picture.

1. Press the self-timer button until "☺" appears on the LCD panel.
2. Focus on the subject or the area where the subject will appear, then depress the shutter release button. The shutter will be released in about 10 seconds.
3. When the self-timer is working, "☺" flickers on the LCD panel. The self-timer lamp on the front of the camera first lights up, then starts blinking 3 seconds before the shutter is released.

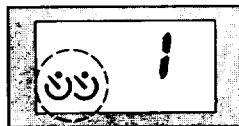

Dual-Frame Self-Timer

Two consecutive self-timer pictures can capture a sequence of expressions or actions.

1. Press the self-timer button until "☺☺" appears on the LCD panel.
2. Focus on the subject or the area where the subject will appear, then depress the shutter release button. The first shot will be exposed in about 10 seconds, and the second shot will be exposed about 5 seconds after that. Note that focus will remain locked at the first shot.



Double-Action Zoom Self-Timer

Two consecutive self-timer pictures can be taken: The first at a selected focal length; the

second at the 38 mm focal length.

1. Press the self-timer button until "  " appears on the LCD panel.
2. Manipulate the zooming lever to determine the first shot's focal length, and focus on the subject or the area where the subject will appear, then depress the shutter release button. The first shot will be exposed in about 10 seconds, the lens will move to the wide-angle position, and the second shot will be exposed about 5 seconds after the first. Note that focus is locked at the first shot.



Notes on self-timer shooting (including the Dual-Frame Self-Timer and Double-Action Zoom Self-Timer):

- To cancel the self-timer at any time after it's been activated, push the power switch. (In such a case, the power will not be turned off.)
- When you want to use the flash with the self-timer, make sure the flash has been charged (the red lamp glows) before operating the self-timer. If the batteries are exhausted, the self-timer operation may not be completed once started. In this case, replace the batteries.
- When the Bulb mode is used with the self-timer, the shutter speed is automatically set to approx. 1/2 sec.

DATE MODEL

If you purchased the DATE model, read this section. The DATE model records dates up to the year 2019 on pictures.

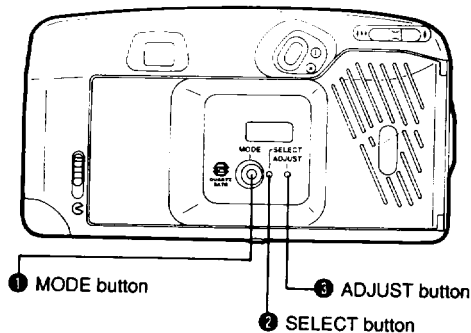

24

Switching the mode

Each time you press the MODE button ① with your fingernail, the data mode on the date indicator switches in succession as shown in the chart.

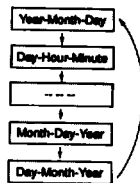

Notes:

- When you want no data to be imprinted, press the MODE button ① until "-- --" appears on the date indicator.
- "M" on the date indicator indicates "Month".
- Use the strap clamp's pin-shaped protrusion to press the SELECT ② and ADJUST ③ buttons.



The date in the picture above is simulated.

Correcting the data

1. Press the SELECT button (2) until you reach the flickering digit(s) which you wish to change.
2. Press the ADJUST button (3) to change digits within the specified category chosen using the SELECT button (2). Digits increase by one each time you press the ADJUST button (3). If you hold down the button, the digit will advance continuously after two or three seconds.
3. After the adjustment is made, press the SELECT button (2). The bar mark (—) appears on the date indicator, indicating that data imprinting choices are possible.

Notes:

- When the flickering data on the date indicator is being corrected, it cannot be imprinted even if the shutter is released.
- Date and time are indicated as follows:
Year = 87 ~ 19 (1987 ~ 2019)
Month = 1 ~ 12
Day = 1 ~ 31
Hour = 0 ~ 23
Minute = 00 ~ 59

- The flickering ":" allows precise fine-tuning of the internal clock to the beginning of a specified minute. To make this adjustment, press the SELECT button (2) until ":" will flicker. Then, press the ADJUST button (3) in sync with a time signal.

Date imprinting

The (Year-Month-Day) or (Day-Hour-Minute) data is recorded on the lower right of a picture. The data on the date indicator is imprinted on each frame you expose.

Notes:

- If the corner of the picture has a white or yellow object, the imprinted data will be difficult to see. When composing, try to avoid a brightly colored subject in that corner.
- "Year-Month-Day" and "Day-Hour-Minute" cannot both be printed at the same time.
- As you release the shutter, the bar mark (—) on the date indicator flickers for a few seconds, indicating the data has been imprinted.



Power source of the data-imprinting section

The data imprinting section is powered by the batteries in the camera's main unit. When the batteries are replaced, the data and time may change. So, after replacing the batteries, make sure to confirm the date and time before use.

MAINTENANCE CONSIDERATIONS

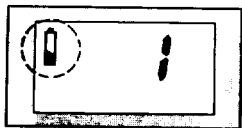
Read this section to keep this camera working as well as possible at all times.



When the batteries are nearly exhausted, the battery mark "  " appears on the LCD panel to warn you. Replace the batteries as soon as possible. When "  " starts flickering, no operations can be performed.

BATTERY EXHAUSTION WARNING

Precautions on batteries

- Battery performance may temporarily decrease in low temperatures, but it will recover in normal temperature.
- Keep spare batteries on hand for convenience when shooting outdoors or while traveling.
- When the camera is in a bag, make sure the power switch is off. Otherwise, battery power may be wasted with the accidental push of the shutter release button.

Battery life (using 24-exposure film rolls):

Ordinary picture taking mode, 50% of shooting employs flash	Approx. 30 rolls.
--	-------------------

(The CR-123A batteries were used based on our own test conditions. Actual battery life/performance may vary drastically depending on either usage of Auto-Focus, Power Zoom and Flash and external conditions such as temperature and freshness.)

Caution:

Replace all batteries at the same time. Do not mix battery brands, types or old battery with new one. It may cause explosion or overheating.

TAKING CARE OF YOUR CAMERA

Your Pentax camera is a sophisticated, precision instrument built to give long-lasting, reliable service. It will serve you well if you handle and care for it properly.

- Avoid storing the camera in a wardrobe where a mothball is put among the clothes or in a laboratory containing chemicals that can cause serious damage to it. Keep it in a cool, dry, well-ventilated place.

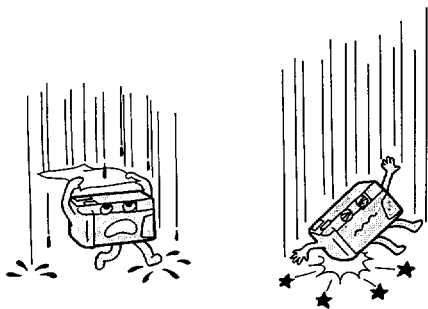

- Be careful not to subject it to strong vibrations, shock or pressure.
Use a cushion to protect the camera when carried in a motorcycle, car, boat, etc.
- Use a blower and lens brush to remove dust accumulated on the lens or viewfinder.
- Avoid leaving the camera for extended periods in conditions of high temperature and humidity, such as in a car.

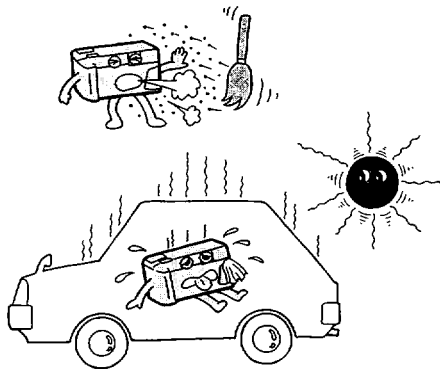

REPLACING BATTERIES First, switch off the power.

1

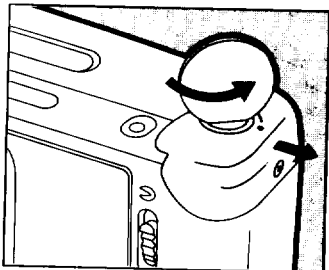

2

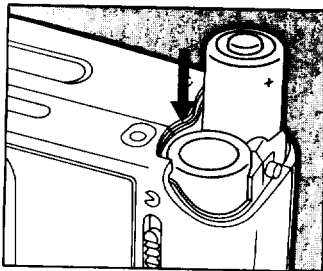

3

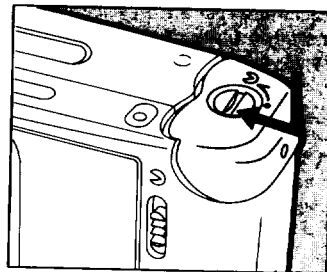

- 1** Using a coin, etc., rotate the cover lock on the battery chamber cover counterclockwise to open the cover.
- 2** Align the batteries with the "+" and "-" indications and insert two lithium batteries.

- 3** As illustrated, slide the battery chamber cover in the direction of the arrow while pressing down to close. Rotate the cover lock clockwise to fasten it securely. (When the batteries are inserted correctly, the zoom lens and motor operate for a few moments.)

Notes on replacing the batteries:

- Make sure there is no film loaded. Switch off the power before replacing the batteries.
- If the batteries are replaced with film already loaded, the camera behaves as if just loaded. Film advances several frames, and the film counter will read " 1 ".
(In this case, when the loaded film reaches its end, an exposure counter indication may not appear on the LCD panel, because the camera is unable to detect the film. If this happens, perform the "rewinding the film in midroll" operation (refer to page 17) before removing the film.)

TROUBLESHOOTING For details, refer to respective pages.

What appears troublesome might be easily remedied.
Here are some problems and their remedies.

1. The shutter cannot be released.

- Is the power switch turned off? If so, turn it on. (See page 4.)
- Are the batteries exhausted? Are they loaded? Replace them or insert new batteries. (See page 27.)
- Are you pressing the zooming lever? If so, release your fingers from the zooming lever, then shoot. (See page 6.)
- Is rewind film left inside? If so, replace it with a new roll. (See pages 8, 9, and 16.)

2. My printed pictures don't look very clear.

- Did you position the autofocus frame () on your subject? (See page 12.)
- Did you press the shutter release button gently while taking care not to obstruct the autofocus window with your fingers or hair? (See page 5.)
- Was the subject too near? Shoot in the range of 0.6 meters (3 ft) to ∞ (infinity). (See page 10.)
- Was the subject too far when you used the flash? Use the flash in the effective ranges. (See page 13.)
- Are your pictures looking greenish? They may have been shot under fluorescent light. Shoot after selecting the Daylight-Sync mode. (See page 20.)

- If the camera is brought into a warm room from the cold outdoors, condensation may occur in the interior and on the exterior of the camera. In such a case, put the camera into a case or plastic bag so its change in temperature is as gradual as possible. After the temperature difference is minimized, take it out of the bag.
- The temperature range in which the camera functions properly is 50°C to -10°C (122°F to 14°F).
- Don't use solvents such as thinner, alcohol or benzine to clean the camera.
- Dirt, mud, sand, dust, moisture, toxic gas, salt water, etc., penetrating inside the camera may damage it or make it inoperable. If the camera should fail for such reasons, it may not be repaired free of charge, even within the period of warranty. When the camera is subjected to rain or moisture, wipe it off, let it dry, and immediately send it to a Pentax service center for examination.
- Electrical problems may often be caused by dirt or dust at points of electrical contact. Also check for battery leakage, traces of dirt or grease, or corrosion due to salinity or gas. If you cannot rectify the problem, have your camera inspected at a Pentax service center.

- Regular size color prints may cut off what appears on the extreme edges of the film frame. Compose your picture with a margin of safety at the edges.
- Once immersed into water, the camera may be rendered inoperable. In such a case, contact our service center.
- To maintain optimum performance, it is recommended that the camera be inspected every one or two years. If the camera has not been used for an extended period, or is being readied for an important shoot (photography), it is recommended that you inspect the camera or test shoot with it.
- Repairs made necessary due to usage of this product in an industrial application may not be covered under the terms of the Pentax warranty.

Red eye phenomenon in flash shooting:

When a picture is taken using a flash, a subject's eyes may appear red in the print. This phenomenon is caused by the reflection of electronic flash in the retina. It can be reduced when the surroundings of the subject are brightened, or shooting distance is shortened with the lens set at the wide-angle position.

WARRANTY POLICY

All Pentax cameras purchased through authorized bona fide photographic distribution channels are guaranteed against defects of material or workmanship for a period of twelve months from date of purchase. Service will be rendered, and defective parts will be replaced without cost to you within that period, provided the equipment does not show evidence of impact, sand or liquid damage, mishandling, tampering, battery or chemical corrosion, operation contrary to operating instructions, or modification by an unauthorized repair shop. The manufacturer or its authorized representatives shall not be liable for any repair or alterations except those made with its written consent and shall not be liable for damages from delay or loss of use or from other indirect or consequential damages of any kind, whether caused by defective material or workmanship or otherwise; and it is expressly agreed that the liability of the manufacturer or its representatives under all guarantees or warranties, whether expressed or implied, is strictly limited to the replacement of parts as hereinbefore provided. No refunds will be made on repairs performed by non-authorized Pentax service facilities.

Procedure During 12-month Warranty Period

Any Pentax camera which proves defective during the 12-month warranty period should be returned to the dealer from whom you purchased the equipment or to the manufacturer. If there is no representative of the manufacturer in your country, send the equipment to the manufacturer, with postage prepaid. In this case, it will take a considerable length of time before the equipment can be returned to you, due to complicated customs procedures required. If the equipment is covered by warranty, repairs will be made and parts replaced free of charge, and the equipment will be returned to you upon completion of servicing. If the equipment is not covered by warranty, regular charges of the manufacturer or of its representatives will apply. Shipping charges are to be borne by the owner. If your Pentax was purchased outside of the country where you wish to have it serviced during the warranty period, regular handling and servicing fees may be charged by the manufacturer's representatives in that country. Notwithstanding this, your Pentax returned to the manufacturer will be serviced free of charge according to this procedure and warranty policy. In any case,

3. The zoom lens does not move.

- Are you depressing the shutter release button? If so, the zoom lens cannot operate at the same time. Take your finger off the shutter release button.

4. The zoom lens retracted automatically.

- Did you leave the camera with the power switch on and not operate it for over three minutes? If so, the camera switches off the power and protectively covers the lens automatically. (See page 4.)

5. " H " or " U " is displayed on the LCD panel.

- It indicates that the camera's self-diagnosis function is working. In this case, operate the zooming lever until " H " or " U " disappears. If either letter remains on or appears frequently after that, the camera may have some trouble. Contact our service center.

Do you know about film?

What is ISO?

ISO describes the sensitivity of film to light. The greater the film's ISO rating, the more sensitive it is. Usually, color negative film of ISO 100, 200 or 400 is used.

What is DX-coded film?

DX coding informs the camera of a film's ISO sensitivity, so the camera can self-adjust to the film's speed. Almost all negative-color film is DX-coded.

Flash-effective range other than ISO 100, 200 or 400

Lens	ISO	50	1000	1600
38 mm ((●●●))		0.6~2.2 m (2~7 ft)	1*~9.5 m (3~31 ft)	1.2*~10.5 m (3.9~34 ft)
60 mm ((●))		0.6~1.5 m (2~5 ft)	0.6~6.5 m (2~21 ft)	0.8*~8 m (2.6~26 ft)

- * Because of high film speed, overexposure may occur at close range.

however, shipping charges and customs clearance fees are to be borne by the sender. To prove the date of your purchase when required, please keep the receipts or bills covering the purchase of your equipment for at least a year. Before sending your equipment for servicing, please make sure that you are sending it to the manufacturer's authorized representatives or their approved repair shops, unless you are sending it directly to the manufacturer. Always obtain a quotation for the service charge, and only after you accept the quoted service charge, instruct the service station to proceed with the servicing.

This warranty policy does not apply to Pentax products purchased in the U.S.A., U.K., or Canada. The local warranty policies available from Pentax distributors in those countries supersede this warranty policy.

NAMES OF WORKING PARTS

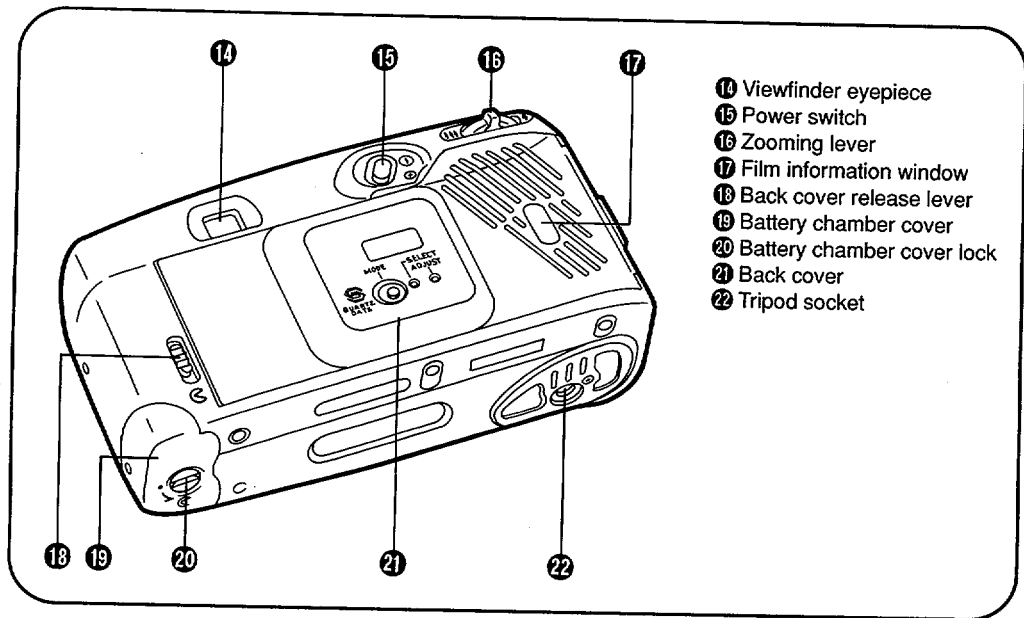

SPECIFICATIONS

SPECIFICATIONS ARE SUBJECT TO CHANGE AT ANY TIME WITHOUT NOTIFICATION OR ANY OBLIGATION ON THE PART OF THE MANUFACTURER.

Type:

35 mm fully automatic leaf-shutter camera with built-in zoom lens.

Film:

35 mm perforated DX-coded film with ISO rating from 50 to 1600 (EV1 steps). 24 × 36 mm format.

Film loading/winding:

Auto film loading. Auto winding: single-frame advance mode.

Film rewinding:

Auto rewinding starts at end of roll. Auto stop upon completion of rewinding. Film roll can also be rewound in mid-roll.

Lens:

Pentax 38 mm to 60 mm, f/4.5 to f/6.7, power zoom lens, 6 elements in 5 groups, angle 59° to 39.5°.

Focusing system:

Infrared active autofocus with focus-lock.
Range: 0.6 m (2 ft) to infinity.

Shutter:

Programmed AE electronic shutter; approx. 1/250 to 1/4 sec; bulb (approx. 1/2 to 8 sec); electromagnetic release.

Self-timer:

Electronic red lamp indication. Approx. 10-sec delay. Cancellation after activation is possible. Dual-Frame and Double-Action Zoom Self-Timer can take 2 consecutive exposures.

Zooming:

2-type system: Continuous Zoom and Instant Tele/Wide.

Viewfinder:

Zoom viewfinder with albedo-bright frame. Autofocus frame.

Exposure:

Programmed auto-exposure.

Ranges (ISO 100): Auto and Daylight Sync—EV9 to EV16.5 (38 mm), EV10.5 to EV16.5 (60 mm); Flash Off—EV6.5 to EV16.5 (38 mm), EV7.5 to EV16.5 (60 mm)

Flash:

Built-in automatic flash discharge. Automatic low-luminance firing in Auto mode. Charging time: Approx. 3 sec. (using fresh lithium batteries).

Power source:

Two 3V lithium batteries (equivalent to CR123A).

Size and weight:

139 (W) × 76 (H) × 43 (D) mm (5.4" × 3.0" × 1.7"); 295g (10.4 oz) without batteries

DATE model

Imprinting mode:

"Year, Month and Day", "Day, Hour and Minute" or blank.

Size and weight:

139 (W) × 76 (H) × 45 (D) mm (5.4" × 3.0" × 1.8"); 305g (10.8 oz) without batteries



Asahi Optical Co., Ltd. 11-1, Nagata-cho 1-chome, Chiyoda-ku, Tokyo 100, JAPAN
Pentax Europe n.v. Weveldlaan 3-5, 1930 Zaventem, BELGIUM
Pentax Handelsgesellschaft mbH. Julius-Vosseler-Strasse, 104, 2000 Hamburg 54, GERMANY
Pentax U.K. Limited. Pentax House, South Hill Avenue, South Harrow, Middlesex HA2 0LT, U.K.
Pentax France Z.I. Argenteuil, 12, rue Ambroise Croizat, 95100 Argenteuil, FRANCE
Pentax Benelux (for Netherlands) Spinveid 25, 4815 HR Breda, NETHERLANDS
(for Belgium & Luxemburg) Weveldlaan 3-5, 1930 Zaventem, BELGIUM
Pentax (Schweiz) AG Industriestrasse 2, 8305 Dietlikon, SWITZERLAND
Pentax Scandinavia AB Falhagsleden 57, 75127 Uppsala, SWEDEN
Pentax Corporation 35 Inverness Drive East, Englewood, Colorado 80112, U.S.A.
Pentax Canada Inc. 3131 Universal Drive, Mississauga, Ontario L4X 2E5, CANADA
Asahi Optical Brasileira Ind. e Com. Ltda. Rua Estados Unidos, 1053, São Paulo, BRAZIL

Free Manuals Download Website

<http://myh66.com>

<http://usermanuals.us>

<http://www.somanuals.com>

<http://www.4manuals.cc>

<http://www.manual-lib.com>

<http://www.404manual.com>

<http://www.luxmanual.com>

<http://aubethermostatmanual.com>

Golf course search by state

<http://golfingnear.com>

Email search by domain

<http://emailbydomain.com>

Auto manuals search

<http://auto.somanuals.com>

TV manuals search

<http://tv.somanuals.com>