

UltraPort Serial Adaptors

User Guide

Part number: 5500152-23

Date: 19 November 2008

Navigating around this manual



[Using this on-line manual. See page 5.](#)



[Fast Contents. See page 7.](#)



[Contents. See page 8.](#)



[Index. See page 154.](#)

Copyright statement

This document must not be reproduced in any way whatsoever, either printed or electronically, without the consent of:

Perle Systems Limited
60 Renfrew Drive
Markham,
Ontario,
Canada
L3R 0E1

Perle reserves the right to make changes without further notice, to any products to improve reliability, function or design.

JETSTREAM, JETSTREAM4000, JETSTREAM8500 and LANSTREAM2000 are trademarks of Perle Systems Limited.

Microsoft, Windows 95, Windows 98, Windows NT, Windows 2000, Windows 2003 Server, Windows Vista, Windows Server 2008, and Internet Explorer are trademarks of Microsoft Corporation.

Netscape is a trademark of Netscape Communications Corporation.

Solaris is a registered trademark of Sun Microsystems, Inc. in the USA and other countries.

Perle Systems Limited, 19 November 2008.

FCC Note

The products described in this manual have been found to comply with the limits for a Class A digital device, pursuant to Part 15 of the FCC rules. These limits are designed to provide reasonable protection against harmful interference when the equipment is operated in a commercial environment. This equipment generates, uses and can radiate radio frequency energy and, if not installed and used in accordance with the instructions in this Guide, may cause harmful interference to radio communications. Operation of this equipment in a residential area is likely to cause harmful interference, in which case the user will be required to correct the interference at his/her own expense.

EN 55022: 1998, Class A Note

Warning: This is a Class A product. In a domestic environment this product may cause radio interference in which case the user may be required to take adequate measures.



Caution: The products described in this manual are approved for commercial use only.

About this manual

Purpose of this manual

This manual tells you how to install, configure and use the Perle UltraPort, UltraPort SI, and UltraPort Express serial adaptor cards, cabling hardware, associated drivers and utilities.

Who this manual is for

This manual is aimed at users who want to add extra serial ports to their system using UltraPort serial adaptor cards. This manual requires a working knowledge of using personal computers and associated operating systems, as well as experience in installing host cards.



Warning

Dangerous voltages exist inside computer systems. Before installing host cards in your system, turn off the power supply and disconnect the power cord.

Using this on-line manual

The following is a brief guide to using this manual on-line.

Document navigation

This manual features document navigation hypertext buttons in the header area as shown in the next picture:

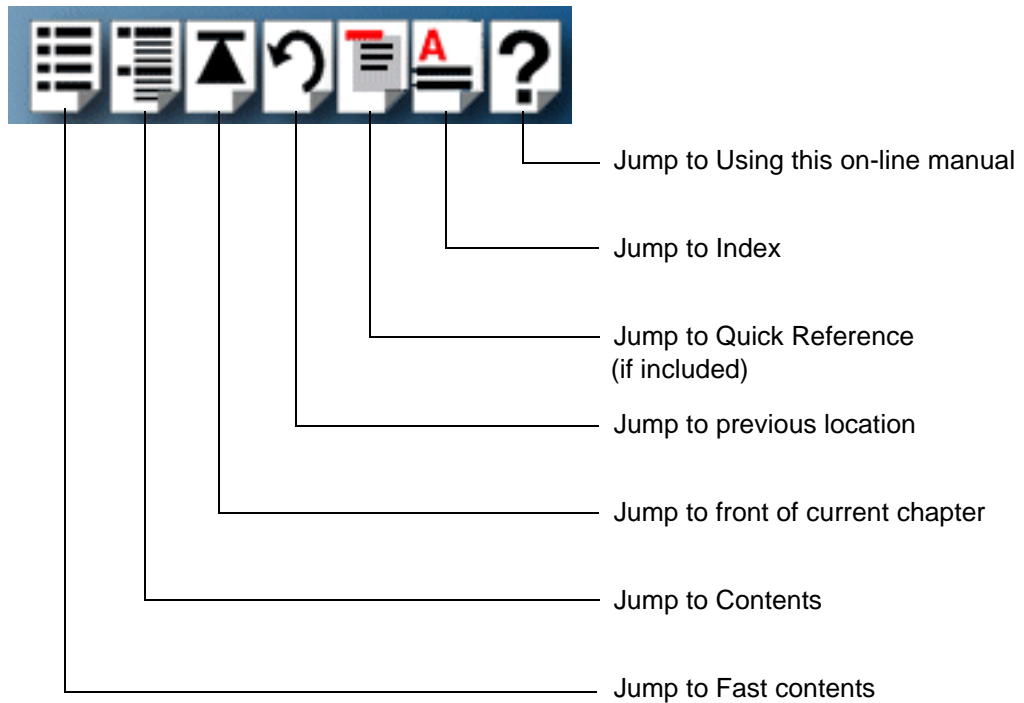

Hypertext jumps

You can also navigate around this manual by clicking on any cross reference or text in blue for example, [Hypertext jumps](#).

Note

The **Fast Contents**, **Contents** and **Index** entries are all hypertext jumps into this manual.

Revision history

Date	Part number	Description
June 2003	5500152-10	First issue of the UltraPort user manual.
October 2003	5500152-11	Support for UltraPort2 and UltraPort8i adapter cards.
February 2004	5500152-12	Updated the UltraPort for Linux installation.
May 2004	5500152-13	Support for Linux 2.6 kernels.
June 2004	5500152-14	Support for UltraPort SI adapter cards.
November 2004	5500152-15	Support for Windows 95/98 on Ultraport SI adapter cards.
March 2005	5500152-16	HD-68M Ultra SCSI has been changed to VHDCI-68 Ultra SCSI.
August 2005	5500152-17	Made corrections to the VHDCI-68 Ultra SCSI pinout table.
October 2005	5500152-18	Added support for SCO OpenServer 6.
November 2005	5500152-19	Support for UltraPort Express adapter cards.
August 2006	5500152-20	Updated Solaris installation instructions.
February 2007	5500152-21	Added instructions for a new Windows 2000/XP/Server 2003/Vista installation process. There are now three Windows drivers to support 32-bit, 64-bit x64, and 64-bit Itanium operating systems/processors.
September 2008	5500152-22	Updated guide for Windows Server 2008 support.
November 2008	5500152-23	Updated the instructions for installing the device drivers.

Fast Contents

ABOUT THIS MANUAL	4
REVISION HISTORY	6
FAST CONTENTS	7
CONTENTS	8
CHAPTER 1 INTRODUCTION	12
CHAPTER 2 INSTALLING DRIVERS AND HOST CARDS	15
CHAPTER 3 CABLING INFORMATION	101
APPENDIX A : TRANSPARENT PRINTING	128
APPENDIX B : OPERATIONS FOR EIA-422/EIA-485	132
APPENDIX C : TROUBLESHOOTING	139
APPENDIX D : CONTACTING PERLE	150
INDEX	154

Contents

ABOUT THIS MANUAL	4
<i>Purpose of this manual</i>	<i>4</i>
<i>Who this manual is for</i>	<i>4</i>
<i>Using this on-line manual</i>	<i>5</i>
<i>Document navigation</i>	<i>5</i>
<i>Hypertext jumps</i>	<i>5</i>
REVISION HISTORY	6
FAST CONTENTS.....	7
CONTENTS.....	8
CHAPTER 1 INTRODUCTION	12
<i>About the UltraPort, UltraPort SI, and UltraPort Express Serial</i>	
<i>Adaptor cards</i>	<i>13</i>
<i>Connection accessories</i>	<i>14</i>
CHAPTER 2 INSTALLING DRIVERS AND HOST CARDS	15
<i>Before you start</i>	<i>16</i>
<i>Downloading drivers from the Perle web site</i>	<i>17</i>
<i>Installing under Windows 95 and 98</i>	<i>18</i>
<i>General installation procedure for Windows 95 and 98</i>	<i>19</i>
<i>Installing device drivers and utilities.....</i>	<i>20</i>
<i>Configuring serial ports</i>	<i>24</i>
<i>Removing drivers and utilities from your system</i>	<i>30</i>

Installing under Windows NT	32
Installing under Windows 2000/XP/Server 2003/Vista/Server 2008	33
General setup procedure for Windows 2000/XP/Server 2003/Vista/Server 2008	34
Installing device drivers and utilities onto your system	35
Adding additional cards and/or updating drivers	37
Configuring serial ports	38
Installing under SCO OpenServer and OpenServer6	44
General installation procedure for SCO OpenServer	45
Installing device drivers and utilities	46
Serial port naming conventions	51
Configuring serial ports	52
Setultrap Interface Protocol Configuration Utility (UltraPort SI only)	57
Command Line Interface	57
Removing drivers and utilities from your system	60
Installing under SCO UnixWare	62
General installation procedure for SCO UnixWare	63
Installing drivers and utilities	64
Serial port naming conventions	65
Configuring serial ports	66
Setultrap Interface Protocol Configuration Utility (UltraPort SI only)	70
Command Line Interface	70
Removing drivers and utilities from your system	73
Installing under Solaris	74
General installation procedure for Solaris	75
Installing drivers and utilities	76
Serial port naming conventions	77
Configuring serial ports	78
Setultrap Interface Protocol Configuration Utility (UltraPort SI only)	82
Command Line Interface	82
Removing drivers and utilities from your system	85
Installing under Linux	86
General installation procedure for Linux	86
Installing Drivers onto your system	86
Uninstall Patch Versions	87
Install from Source RPM	88
Install from Tar File	88
Creating devices for the attached ports	89
UltraPort 8i and UltraPort81 Express RTS/DTR option	90

Setultrap Interface Protocol Configuration Utility (UltraPort SI only).....	90
Command Line Interface	91
Uninstalling the UltraPort Driver for Linux.....	93
Installing host cards and cable accessories	94
Installing UltraPort, UltraPort SI, and UltraPort Express cards	95
Installing cables and connector boxes	96
Installing cables on UltraPort1, UltraPort1 SI, UltraPort1 Express, UltraPort2, and UltraPort2 SI cards	97
Installing converter cables on UltraPort2 Express, UltraPort4, UltraPort4 Express, and UltraPort4 SI-RJ45 cards	97
Installing converter cables on UltraPort8i, and UltraPort81 Express cards ...	97
Installing fan-out cables and connector boxes on UltraPort4 SI-LP, UltraPort4 Express HD, UltraPort 8 SI, UltraPort8, and UltraPort8 Express HD cards ..	98
Installing fan-out cables and connector boxes on UltraPort16 and UltraPort16 SI cards	99
Removing host cards	100
CHAPTER 3 CABLING INFORMATION	101
Definitions of Signals and Direction	102
Host card back panel connectors and pinouts	103
DB9 back panel connectors and pinout	104
RJ45 back panel connectors and pinout.....	105
UltraPort4 SI-RJ45 Switches	106
RJ12 back panel connectors and pinout.....	107
VHDCI-68 Ultra SCSI back panel connectors and pinout.....	108
Connector box and cable guide	115
Connector box and cable pinouts	117
RJ45 10-pin to DB25 converter.....	118
RJ45 10-pin to DB9 converter.....	119
RJ45 10-pin to RJ45 SPEED converter	120
RJ45 10-pin to RJ45 Digi converter.....	121
RJ45 10-pin to RJ45 Digi ALTPIN converter.....	122
RJ45 connector box.....	123
DB25 connector box	124
DB9 connector box	125
DB25 Fan-out cable	126
DB9 Fan-out cable.....	127

APPENDIX A : TRANSPARENT PRINTING	128
<i>What is transparent printing?</i>	129
<i>Problems with printer output</i>	130
<i>The printcap.spd configuration file</i>	130
<i>The print.spd configuration file</i>	131
APPENDIX B : OPERATIONS FOR EIA-422/EIA-485	132
<i>The EIA-422 Standard</i>	133
<i>The EIA-485 Standard</i>	134
<i>Cabling Distances</i>	138
APPENDIX C : TROUBLESHOOTING	139
SCO OpenServer 5	140
<i>Example of normal SPEED driver boot messages</i>	140
<i>Additional card warning messages</i>	141
<i>SCO OpenServer 5 error messages</i>	142
SCO UnixWare/SCO OpenServer 6	143
<i>Additional card warning messages</i>	144
<i>SCO UnixWare error messages</i>	145
Windows NT	147
<i>Windows NT general troubleshooting UltraPort and UltraPort SI only</i>	147
Windows 2000/XP/Server 2003/Vista/Server 2008	148
<i>General troubleshooting under Windows 2000/XP/Server 2003/Vista/</i>	
<i>Server 2008</i>	149
<i>Windows error messages</i>	149
APPENDIX D : CONTACTING PERLE	150
Making a technical support query	150
<i>Who to contact</i>	150
<i>Information needed when making a query</i>	151
<i>Making a support query via the Perle web page</i>	152
Repair procedure	152
Feedback about this manual	152
Perle support centres worldwide	153
INDEX	154

Chapter 1 Introduction

You need to read this chapter if you want to...

You need to read this chapter if you want an introduction to the Perle UltraPort, UltraPort SI, and UltraPort Express serial adaptor cards, driver software and configuration utilities.

This chapter includes the following sections:

- [About the UltraPort, UltraPort SI, and UltraPort Express Serial Adaptor cards](#) on page 13
- [Connection accessories](#) on page 14

About the UltraPort, UltraPort SI, and UltraPort Express Serial Adaptor cards

The UltraPort Serial Adaptor cards are multi-port cards which provide extra serial ports for EIA-232, EIA-422 and EIA-485 peripherals. These cards plug into your PC servers and provide 1, 2, 4, 8 or 16 high speed ports suitable for remote access, data collection, point of sale or any other EIA-232, EIA-422, or EIA-485 applications.

You use the UltraPort, UltraPort SI, and UltraPort Express serial adaptor cards when you want a robust entry level solution for the small office or point of sale applications. Typically you use UltraPort, UltraPort SI, and UltraPort Express serial adaptor cards because you want to add extra serial ports to an existing computer system rather than replacing it with the considerable cost that entails. Higher data rates and ESD protection in the UltraPort, UltraPort SI, and UltraPort Express serial adaptor cards make it suitable for any modem or ISDN TA application.

Note

To use the UltraPort, UltraPort SI, or UltraPort Express serial adaptor cards you must first install the card, and then install the drivers supplied with the card. You can now configure each card as required prior to mechanical installation. The installation procedure varies for different operating systems. Please read [Before you start](#) on page 16 in [Chapter 2 Installing drivers and host cards](#) before commencing installation.

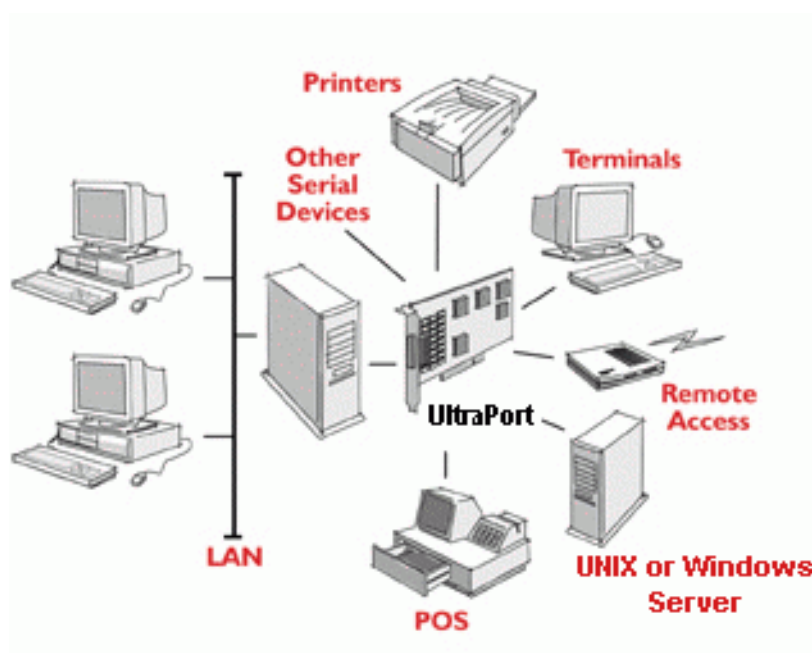

Connection accessories

The connector box or cable required for the UltraPort products you are using depends on the number of ports and product type. For details see [Chapter 3 Cabling information](#)

Chapter 2 Installing drivers and host cards

You need to read this chapter if you want to...

You need to read this chapter if you want to install UltraPort, UltraPort SI, and UltraPort Express serial adaptor cards, associated hardware and software.

This chapter provides information about installing and configuring UltraPort, UltraPort SI, and UltraPort Express serial adaptor cards.

Note

The procedure for installing and configuring UltraPort serial adaptor cards varies for different operating systems. Please read **Before you start** on page 16 before commencing installation.

This chapter includes the following sections:

- **Before you start** on page 16
- **Downloading drivers from the Perle web site** on page 17
- **Installing under Windows 95 and 98** on page 18
- **Installing under Windows NT** on page 32
- **Installing under Windows 2000/XP/Server 2003/Vista/Server 2008** on page 33
- **Installing under SCO OpenServer and OpenServer6** on page 44
- **Installing under SCO UnixWare** on page 62
- **Installing under Solaris** on page 74
- **Installing under Linux** on page 86
- **Installing host cards and cable accessories** on page 94
- **Removing host cards** on page 100.

Before you start

Before you install your UltraPort, UltraPort SI, and UltraPort Express host cards and software, note that the procedure for installing and configuring UltraPort and UltraPort SI, UltraPort Express serial adaptor cards varies for different operating systems.

To install under a particular operating system, please refer to one of the operating system specific installation procedures listed below:

- [Installing under Windows 95 and 98](#) on page [18](#)
- [Installing under Windows NT](#) on page [32](#)
- [Installing under Windows 2000/XP/Server 2003/Vista/Server 2008](#) on page [33](#)
- [Installing under SCO OpenServer and OpenServer6](#) on page [44](#)
- [Installing under SCO UnixWare](#) on page [62](#)
- [Installing under Solaris](#) on page [74](#)
- [Installing under Linux](#) on page [86](#)

Downloading drivers from the Perle web site

You can install the UltraPort driver and utility software from the Perle web site. To do this proceed as follows:

1. On your PC, start the Internet browser you want to use.
2. Within your Internet browser window, select the software directory using the following URL:

<http://www.perle.com/downloads>

Note

In the event of any problems contact your System Administrator or Internet Service provider for assistance.

3. Change to the software directory.
The software directory is now displayed.
4. Download the zip files in this directory to a suitable location on your PC for example, **/tmp**.
5. Uncompress the files using a suitable utility.
6. You can now install the driver software using the correct procedure for your operating system. See **Before you start** on page **16**.

Installing under Windows 95 and 98

This section tells you how to install UltraPort and UltraPort SI only host cards, software drivers and utilities under the Windows 95 and Windows 98 operating systems and includes the following:

- [General installation procedure for Windows 95 and 98](#) on page **19**
- [Installing device drivers and utilities](#) on page **20**
- [Configuring serial ports](#) on page **24**
- [Removing drivers and utilities from your system](#) on page **30**.

General installation procedure for Windows 95 and 98

The general procedure for installing UltraPort and UltraPort SI only cards under the Windows 95/98 operating systems is as follows:

1. Install any UltraPort and UltraPort SI cards and cables or connector boxes you require into your system. See [Installing host cards and cable accessories](#) on page [94](#).
2. Using the Windows **Found New Hardware Wizard**, install the UltraPort or UltraPort SI device driver software. See [Installing device drivers and utilities](#) on page [20](#)

Note

The UltraPort and UltraPort SI device drivers for Windows 95/98 are not included on your Windows 95 or Windows 98 CDROM.

3. If required, remove any host cards you want from your system. See [Removing host cards](#) on page [100](#).
4. Using the Windows **Device Manager**, configure the serial ports you have added to the system. See [Configuring serial ports](#) on page [24](#).

Installing device drivers and utilities

To install or enable the UltraPort and UltraPort SI device drivers on your system proceed as follows:

1. Turn on your PC and if required, log in.

If you have installed any new UltraPort or UltraPort SI cards, a **Found New Hardware - "PCI Serial Controller"** message is briefly shown followed by the **Add New Hardware Wizard** window as shown below:



- Proceed by clicking **Next** and the following **Add New Hardware Wizard** window will appear:



- Proceed again by clicking **Next** and the following **Add New Hardware Wizard** window will appear



4. Inset the Perle CD and check the **Specify a location** check box. Now either browse to, or type in the following path **d:\driversultraport\win9x\x.yy**. Where **x.yy** is the windows 95/98 driver version number. Then click **Next** and the following **Add New Hardware Wizard** window will appear:



5. Proceed by clicking **Next** and the final **Add New Hardware Wizard** window will appear as below:



6. Proceed by clicking **Finish**. Windows will now copy all the files needed for the device driver. After the driver installation is complete, the driver will automatically find all of the serial ports associated with the UltraPort or UltraPort SI card. A series of **New Hardware Found** messages will be temporarily displayed for every port found.

Installation of the device drivers and utilities is now complete.

Note:

Your system does not need to be restarted to start using the newly added serial ports

Configuring serial ports

To configure UltraPort or UltraPort SI serial ports proceed as follows:

1. In the windows desktop, click on the **Start** button and select **Settings > Control panel**.
The control panel window is now displayed.

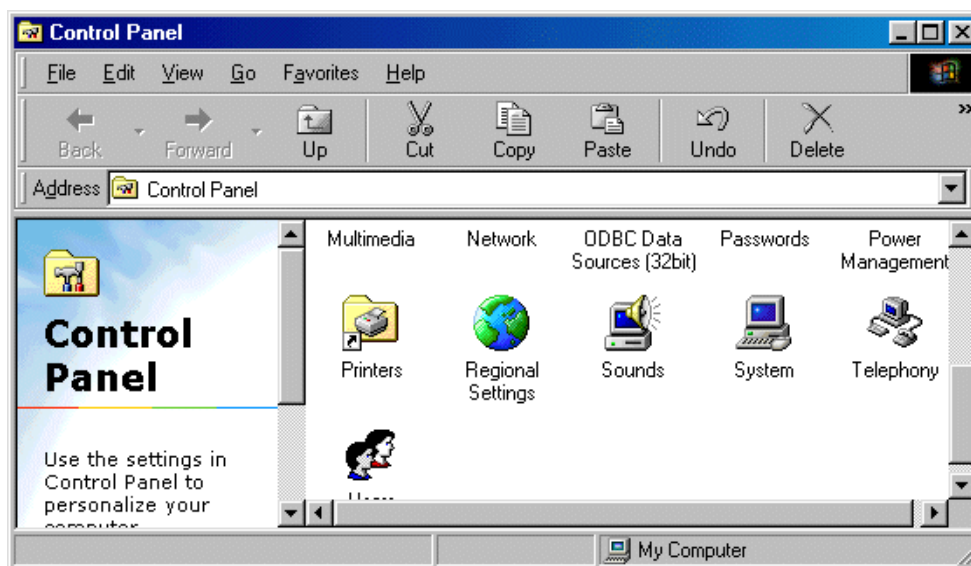

2. In the control panel window, double click on the **System** icon. The System Properties tabbed window is displayed.

Hint

You can also display the **System Properties** tabbed window by right clicking on the **My Computer** icon on your desktop and selecting the **Properties** menu option.

- In the System Properties tabbed window, click on the **Device Manager** tab.
The Device Manager page is now displayed.

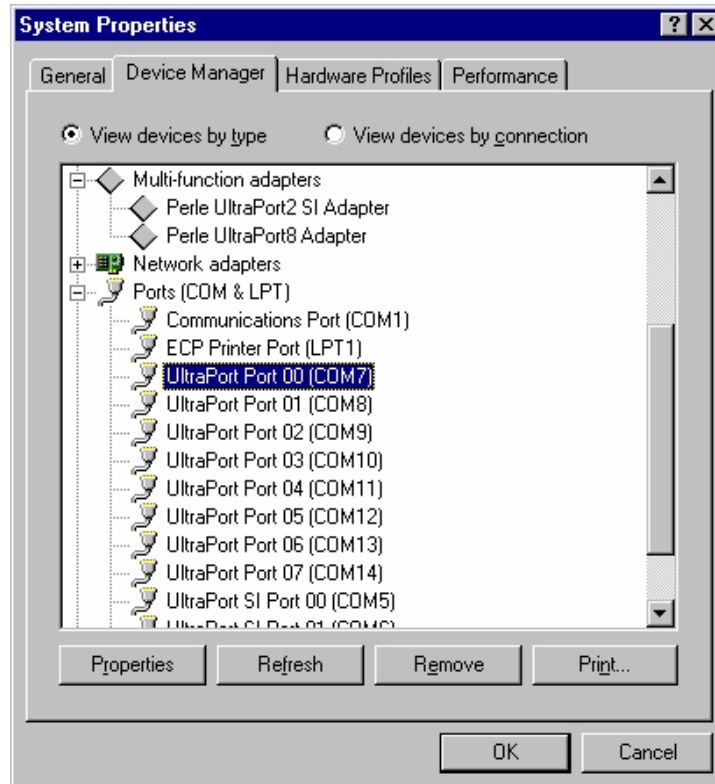

- In the Device Manager page, double click on the device whose properties you wish to view.
The properties tabbed window for the selected device is now displayed.

5. In the properties window, click on the **Port Settings** tab.
The Settings page is now displayed.

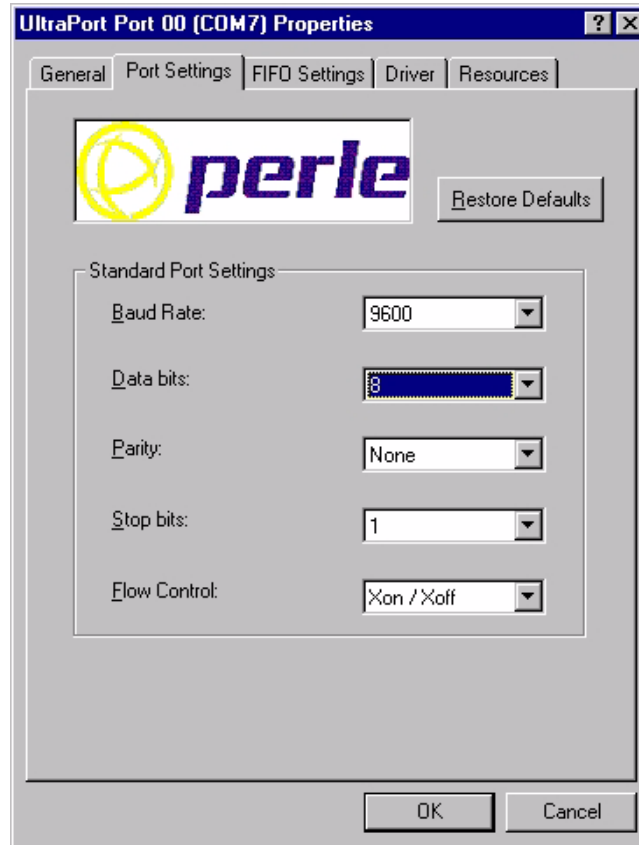

6. In the Port Settings page, select the configuration values you want and either click on the **OK** button or click on the **FIFO Settings** tab to display FIFO configuration settings for the device driver.

7. The FIFO Settings page is now displayed as shown in the next picture

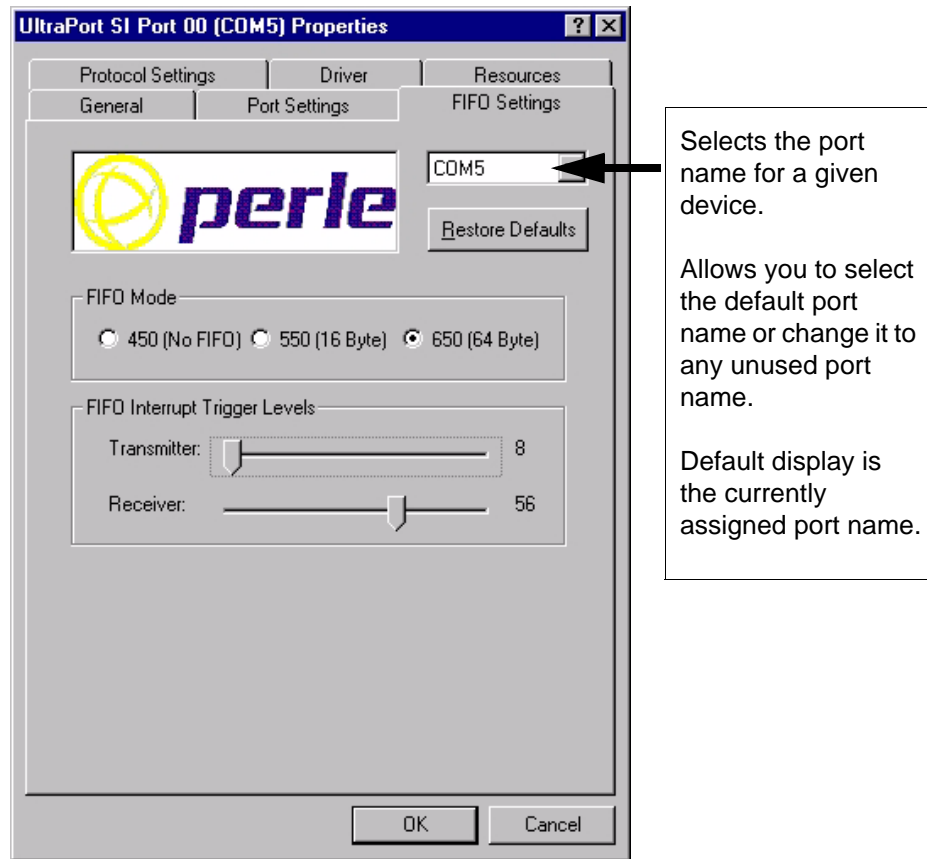

8. In the FIFO Settings page, select the configuration values you want and either click on the **OK** button or, if the COM port belongs to a UltraPort SI card, then you can click on the **Protocol Settings** tab to access the software switchable interface modes.

 **Caution**
It is strongly recommended that you do not make changes to the FIFO trigger levels or com port name unless you have a valid reason to do so.

9. The Protocol Settings page is now displayed as shown in the next picture

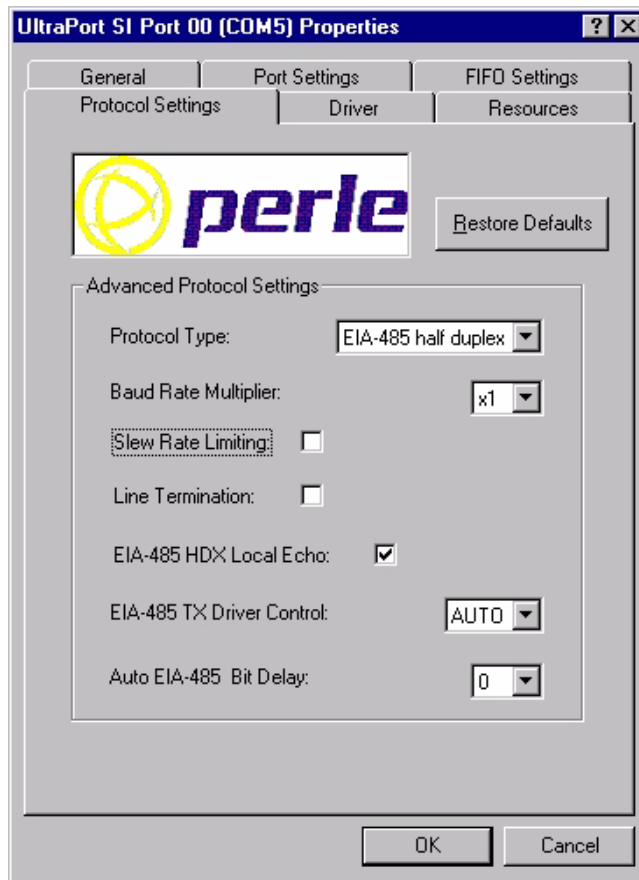

10. In the Protocol Settings page, select the configuration values you want and click on the **OK** button.

Re-configuration of ports is now complete.

Protocol Type: The valid software switchable protocol types are EIA-232, EIA-422, EIA-485 Full Duplex and EIA-485 Half Duplex. Each port on the UltraPort SI are independent of each other and therefore you may select different protocols per serial port.

Baud Rate Multiplier: The baud rate multiplier allows the user to multiply the configured baud rate by 1, 2, 4, 8, 16 or 32, hence achieving greater speeds on the UltraPort SI serial interfaces. This is applicable for each protocol type selected. Baud rates for EIA-232 are up to 921.6 Kbps per serial port. Baud rates for EIA-422/EIA-485 are up to 3.686 Mbps per serial port.

Slew Rate Limiting: The default setting for slew rate limiting is disabled. This will allow higher baud rate speeds on each EIA interface port. Slew rate limiting enabled, minimizes EMI and reduces reflections caused by improperly terminated cables. Operation in slew rate limited mode reduces the amplitudes of high-frequency harmonics.

Line Termination: The line termination parameter is not changeable by the user in EIA-232 mode. However both EIA-422 and EIA-485 modes are defaulted to disabled but can be enabled by the user if needed.

EIA-485 HDX Local Echo: Local echo by default is on. This parameter applies only to EIA-485 half duplex mode. All characters will be echoed to the user and transmitted across the serial ports. Some EIA-485 applications require local echo to be enable in order to monitor the loopback data to determine that line contention has occurred. If your application cannot handle loopback data the local echo should be disabled.

EIA-485 TX Driver Control: The default for this field is AUTO. When Auto is set the UltraPort SI will automatically detect the beginning and the ending of data being transmitted in order to enable and disable the transmit line. When the field is set to RTS it is the host application's responsibility to enable and disable the transmit line via the RTS handshake line when it wants to send data.

Auto EIA-485 Bit Delay: By default this field is set to 0 delay. This field is only applicable if you have configured EIA-485 TX Driver Control to AUTO. Values for this field are 0 through 15 bits.

Note

The port must be closed and then opened for the new parameters to take effect.

Removing drivers and utilities from your system

To remove drivers and utilities from your system proceed as follows:

1. In the windows desktop, click on the **Start** button and select **Settings > Control panel**.
The control panel window is now displayed.

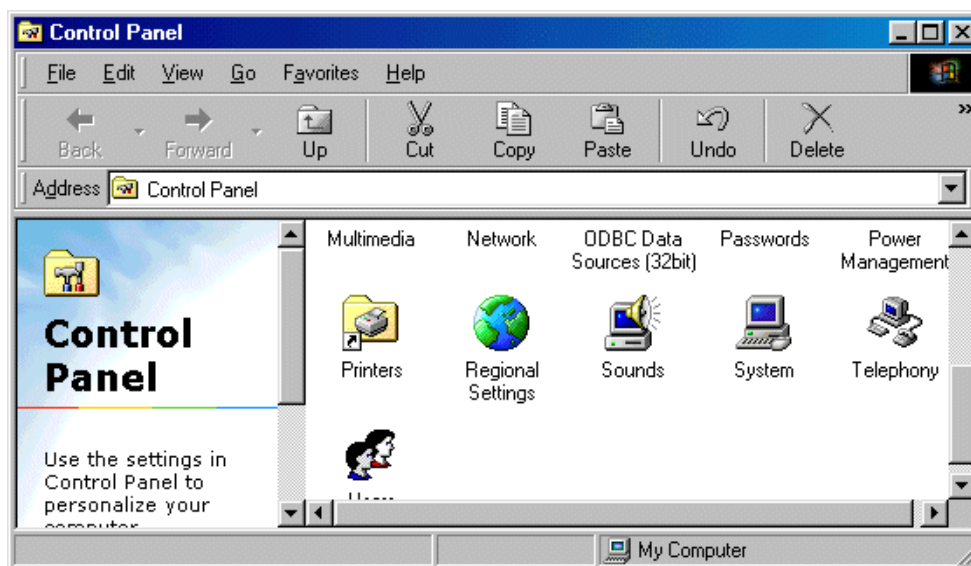

- In the control panel window, double click on the **System** icon.

The System Properties tabbed window is now displayed as shown in the next picture.

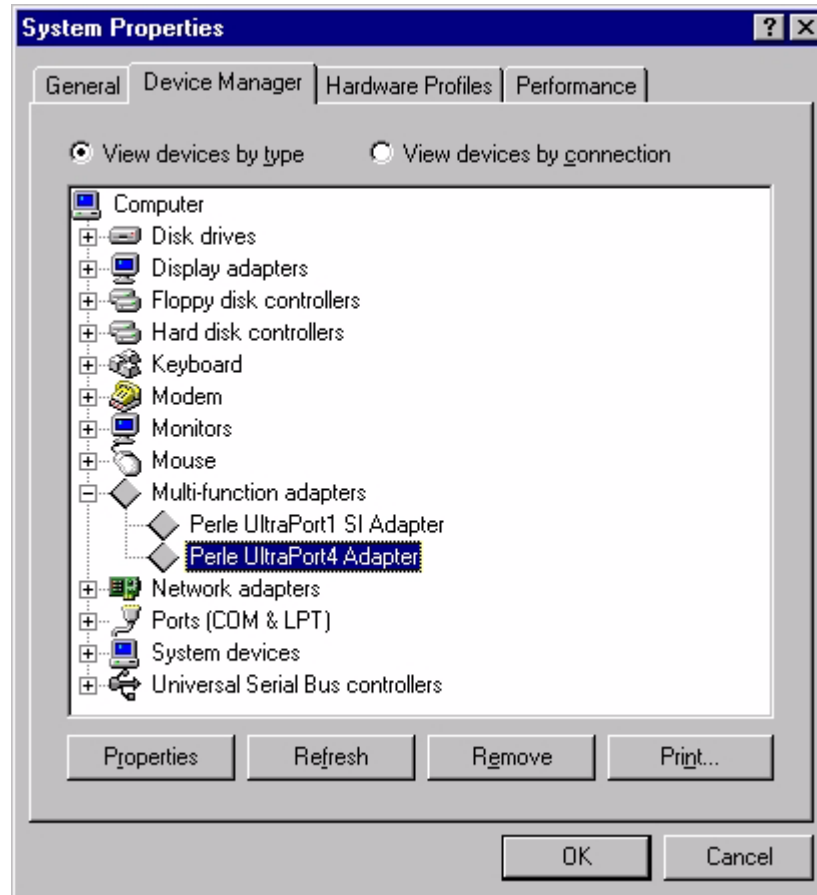

- In the System Properties tabbed window, click on the **Device Manager** tab

The Device Manager page is now displayed.

- In the Device Manager page, click on the Perle Multi-function adapter that you wish to remove, highlighting it then press the **Remove** button.

The selected device is now removed from the system.



Warning

If you remove the devices but do not remove the hardware, the devices will be re-installed when you next re-boot the machine or run the Hardware Wizard.

Installing under Windows NT

The procedure for installing and configuring host cards, drivers software and associated utilities for the Windows NT operating system is as follows:

Note

The Perle PortDirector software contains drivers for the UltraPort and UltraPort SI host cards only.

You will need to install the PortDirector **for Windows NT** on your system in order to use the UltraPort and UltraPort SI host cards.

See the PortDirector user guide part number **5500028** for further details.

1. Install any UltraPort and UltraPort SI cards, cables or connector boxes you require into your system. See [Installing host cards and cable accessories](#) on page [94](#).
2. If required, remove any host cards you want from your system. See [Removing host cards](#) on page [100](#).
3. Use the PortDirector software to update your system with the revised number and type of host cards. See The PortDirector user guide part number 5500028 for further details.

Your system can now use the serial adaptor cards you have installed.

Installing under Windows 2000/XP/Server 2003/Vista/Server 2008

This section describes how to install the UltraPort, UltraPort SI, and UltraPort Express driver software under Microsoft Windows 2000, XP, Server 2003, Vista, or Server 2008.

This section includes the following:

- [General setup procedure for Windows 2000/XP/Server 2003/Vista/Server 2008](#) on page [34](#)
- [Installing device drivers and utilities onto your system](#) on page [35](#)
- [Adding additional cards and/or updating drivers](#) on page [37](#)
- [Configuring serial ports](#) on page [38](#)

General setup procedure for Windows 2000/XP/Server 2003/Vista/Server 2008

The general procedure for installing UltraPort, UltraPort SI, and UltraPort Express cards under the Windows 2000, XP, Server 2003, Vista, or Server 2008 operating systems is as follows:

1. Install any UltraPort and cards and cables or connector boxes you require into your system. See [Installing host cards and cable accessories](#) on page [94](#).
2. Install the UltraPort, UltraPort SI, or UltraPort EXPRESS device driver software. See [Installing device drivers and utilities onto your system](#) on page [35](#).
3. If you add new UltraPort, UltraPort SI, and UltraPort Express cards, you should run Update Driver to make sure the new cards have the latest driver. See [Adding additional cards and/or updating drivers](#) on page [37](#).
4. If required, remove any host cards you want from your system. See [Removing host cards](#) on page [100](#).
5. Using the Windows **Device Manager**, configure the serial ports you have added to the system. See [Configuring serial ports](#) on page [38](#).

Installing device drivers and utilities onto your system

To install or enable the UltraPort, UltraPort SI, and UltraPort Express device drivers on your system, proceed as follows:

1. Turn on your PC and, if required, log in.

If you have installed any new UltraPort cards, a Found New Hardware message is briefly shown followed by the Found New Hardware wizard as shown below.

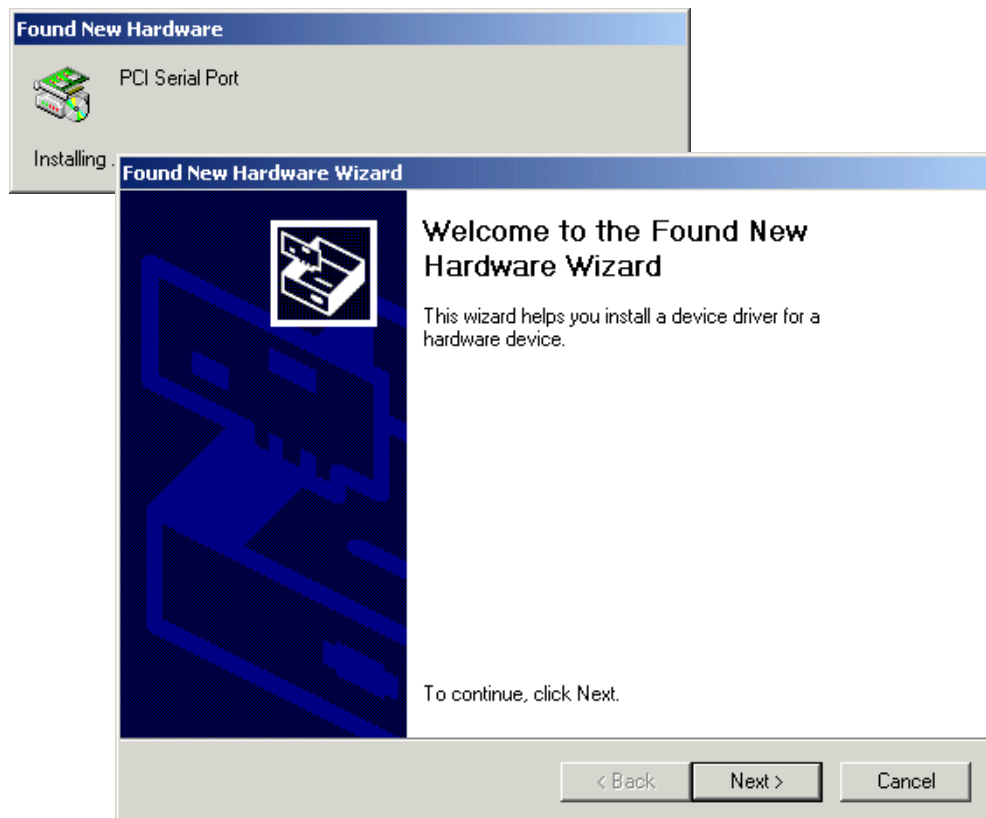

2. In the Found New Hardware wizard, click the **Cancel** button.
3. Download the latest UltraPort/UltraPort SI/UltraPort Express driver file from the Perle website for your operating system:

pserial-x86.exe for 32-bit Windows operating systems

pserial-amd64.exe for 64-bit Windows operating systems

pserial-ia64.exe for 64-bit Windows Itanium operating systems

4. Double-click the installation executable that you downloaded in step 3, and follow the installation wizard steps:

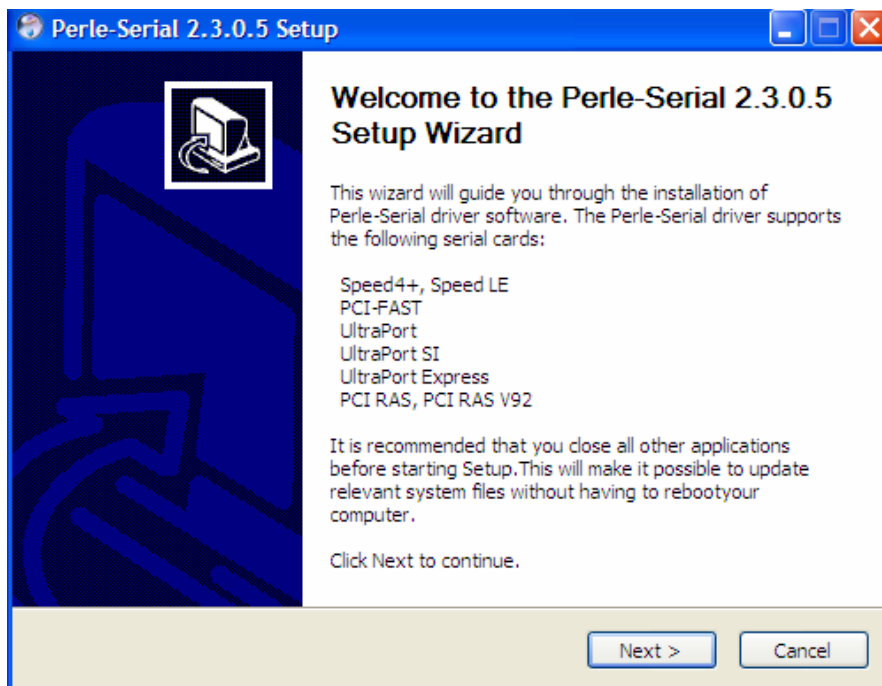

5. During the installation, you may get a Windows Logo message. Click **Continue Anyway** when the message appears.

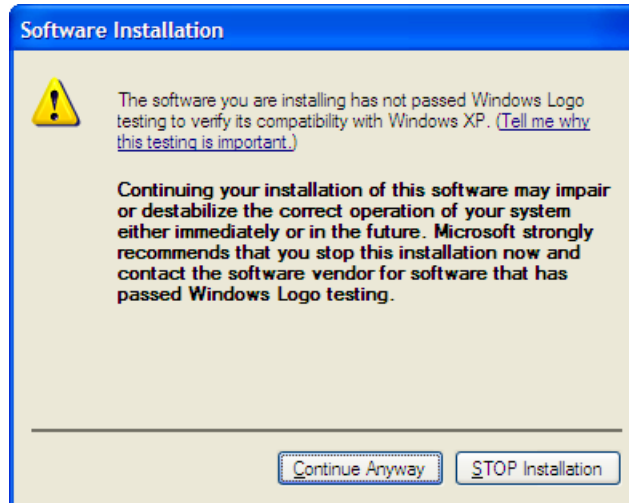

Note

If you are installing an unsigned driver, you may have to click through the Found New Hardware wizard for every UltraPort port on your system.

Your UltraPort/UltraPort SI/UltraPort Express driver installation is now finished.

Adding additional cards and/or updating drivers

Whenever you add any additional UltraPort, UltraPort SI, or UltraPort Express hardware to your system, Windows might install the latest digitally signed driver in its database (depending on your Windows operating system and settings). To ensure you have the latest driver installed after you add new hardware, you can either:

- Click **Start > All Programs > Perle > Perle-Serial > Update Driver**
or
- Reinstall the drivers as described in [Installing device drivers and utilities onto your system](#) on page 35.

Configuring serial ports

To configure UltraPort and UltraPort SI and UltraPort Express serial ports under Windows 2000, XP, Server 2003, Vista, or Server 2008 proceed as follows:

1. In the Windows desktop, click on the **Start** button and select **Settings > Control Panel**
The control panel window is now displayed.

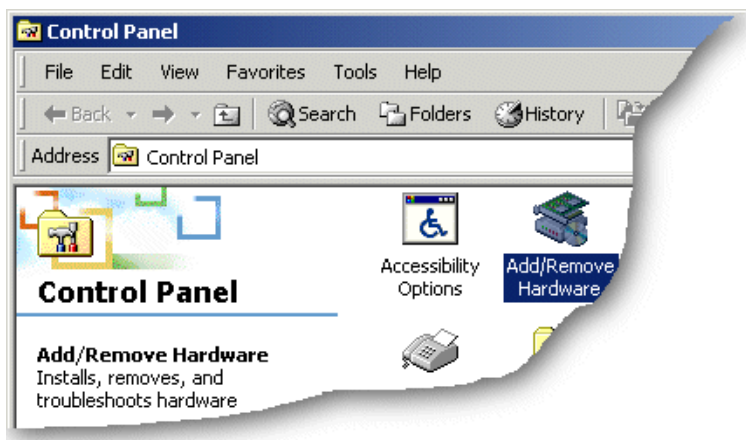

2. In the Control Panel window, click on the **System** icon.
The System Properties tabbed window is now displayed.
3. In the System Properties window, click on the **Hardware** tab.
The hardware page is now displayed.
4. In the Hardware page, click on the **Device Manager** Button.
The Device Manager window is now displayed.

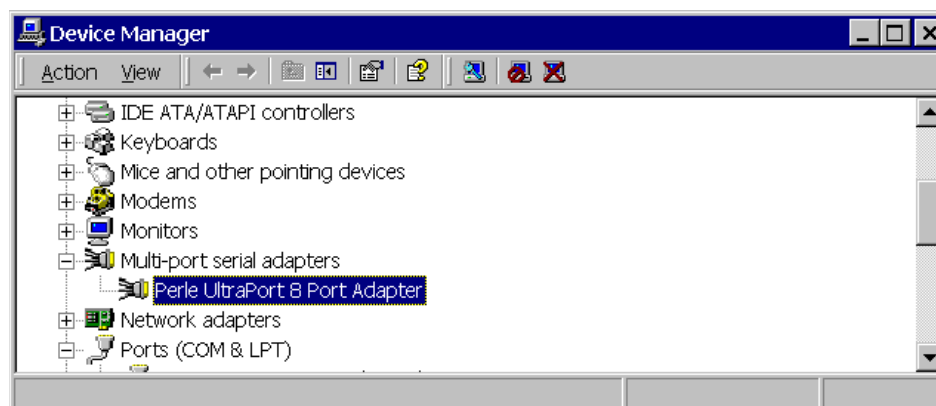

5. In the Device Manager window, click on the Multiport serial adapters icon to display the currently installed devices.
6. In the Device Manager window, double click on the device whose properties you want to view or change
The device Properties tabbed window is now displayed.
7. In the device Properties window, click on the **Port Settings** tab to display the Port Settings page.

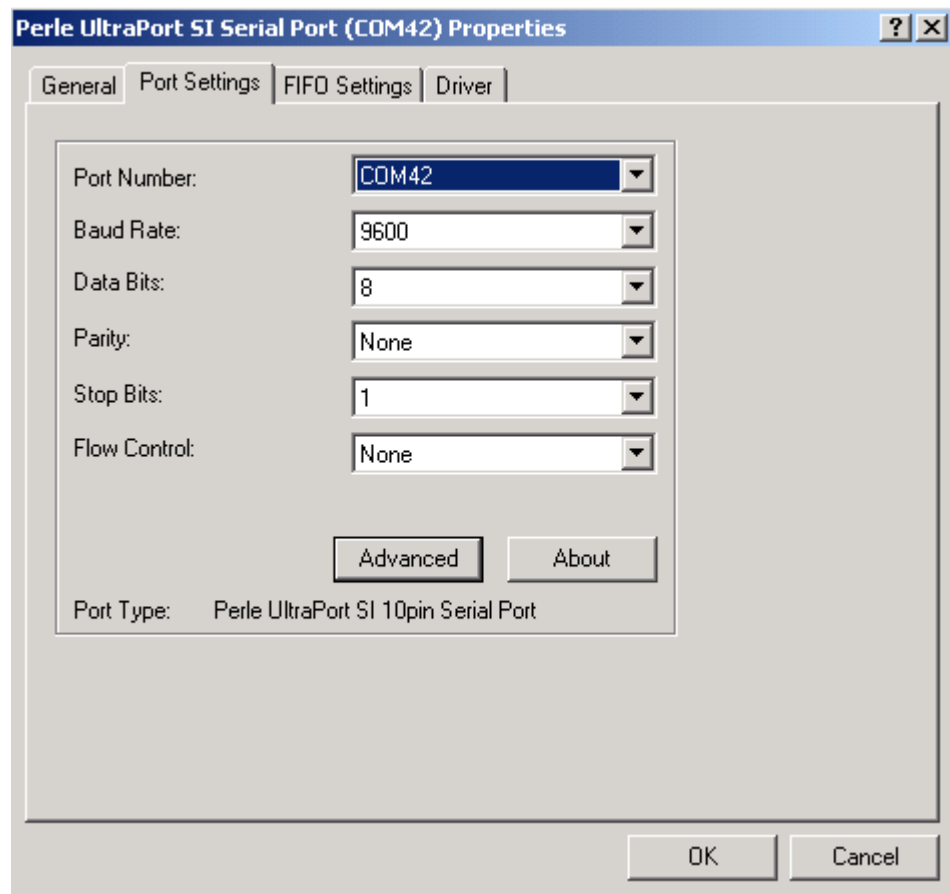

8. In the Port Settings page, set the **Port Number**, **Baud Rate** and other configuration parameters you require.

- If the COM port belongs to a UltraPort SI card then you can click on the **Advanced** button to access the software switchable interface modes as shown in the next diagram.

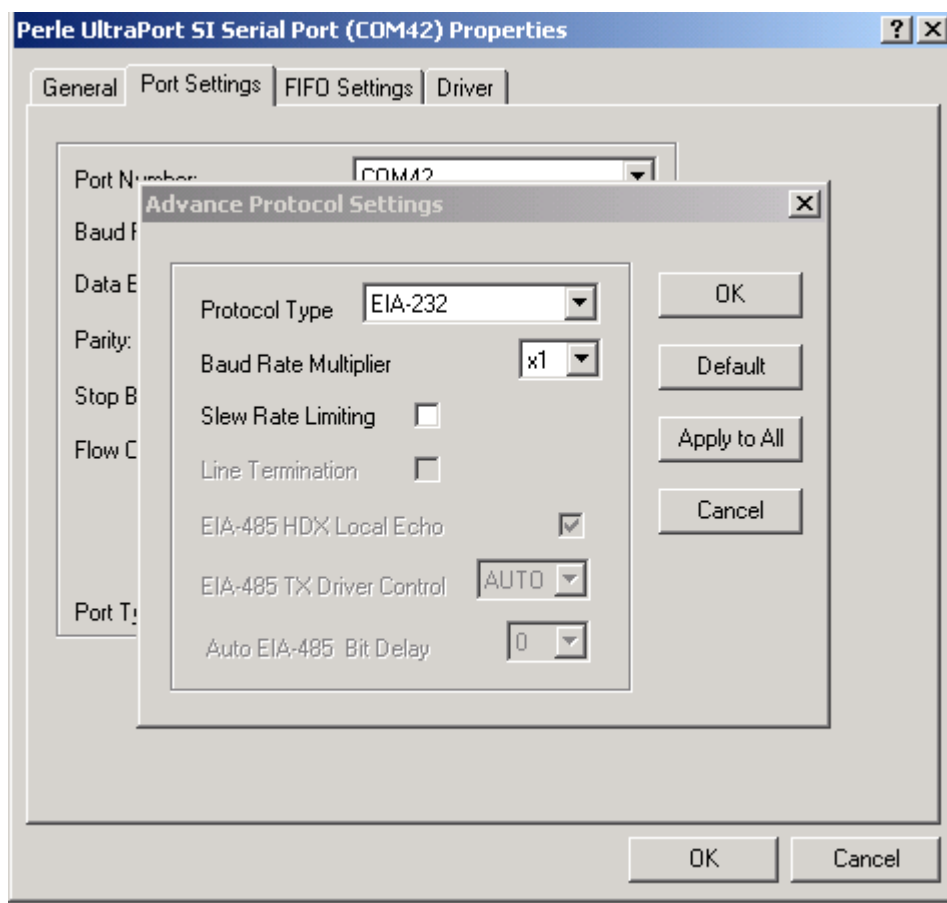

Protocol Type: The valid software switchable protocol types are EIA-232, EIA-422, EIA-485 Full Duplex and EIA-485 Half Duplex. Each port on the UltraPort SI are independent of each other and therefore you may select different protocols per serial port.

Baud Rate Multiplier: The baud rate multiplier allows the user to multiply the configured baud rate by 1, 2, 4, 8, 16 or 32, hence achieving greater speeds on the UltraPort SI serial interfaces. This is applicable for each protocol type selected. Baud rates for EIA-232 are up to 921.6 Kbps per serial port. Baud rates for EIA-422/EIA-485 are up to 3.686 Mbps per serial port.

Slew Rate Limiting: The default setting for slew rate limiting is disabled. This will allow higher baud rate speeds on each EIA interface port. Slew rate limiting enabled, minimizes EMI and reduces reflections caused by improperly terminated cables. Operation in slew rate limited mode reduces the amplitudes of high-frequency harmonics.

Line Termination: The line termination parameter is not changeable by the user in EIA-232 mode. However both EIA-422 and EIA-485 modes are defaulted to disabled but can be enabled by the user if needed.

EIA-485 HDX Local Echo: Local echo by default is on. This parameter applies only to EIA-485 half duplex mode. All characters will be echoed to the user and transmitted across the serial ports. Some EIA-485 applications require local echo to be enable in order to monitor the loopback data to determine that line contention has occurred. If your application cannot handle loopback data the local echo should be disabled.

EIA-485 TX Driver Control: The default for this field is AUTO. When Auto is set the UltraPort SI will automatically detect the beginning and the ending of data being transmitted in order to enable and disable the transmit line. When the field is set to RTS it is the host application's responsibility to enable and disable the transmit line via the RTS handshake line when it wants to send data.

Auto EIA-485 Bit Delay: By default this field is set to 0 delay. This field is only applicable if you have configured EIA-485 TX Driver Control to AUTO. Values for this field are 0 through 15 bits.

Note

The port must be closed and then opened for the new parameters to take effect.

In the **FIFO Settings** page, set the FIFO buffer levels using the parameters detailed in the table.

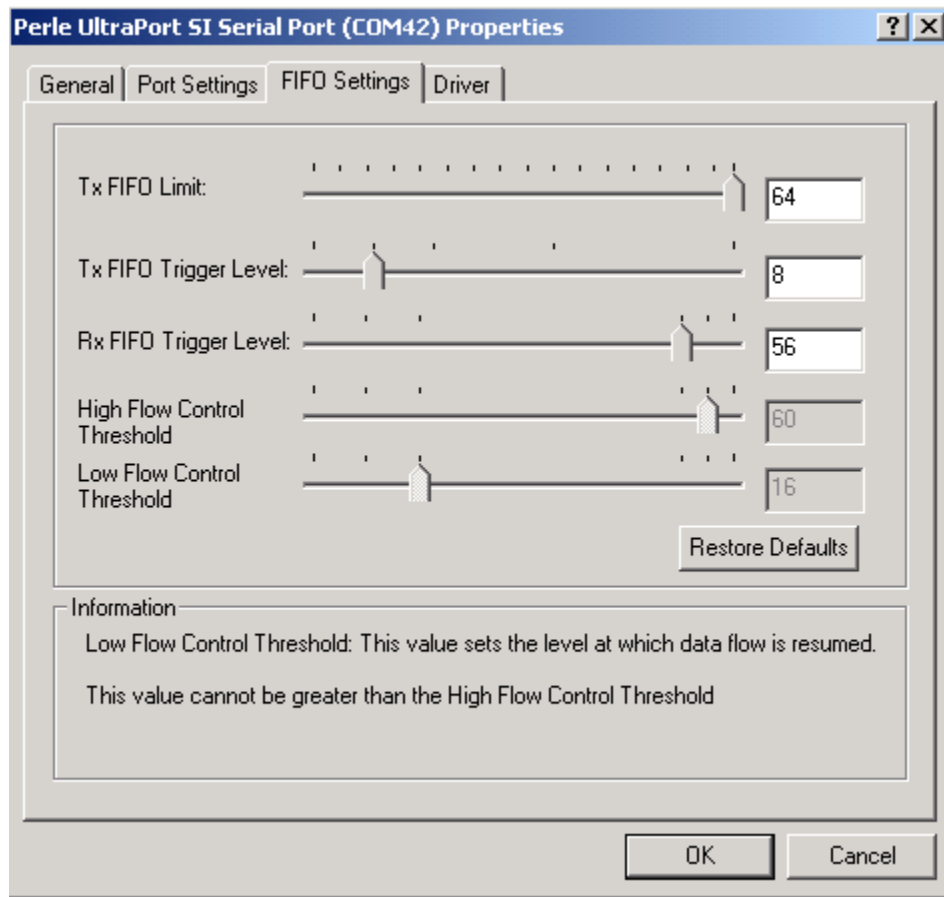

Parameter	Description
Tx FIFO Limit	<p>Sets the overall size of the Transmit FIFO buffer. You use this when you want to restrict the size of the buffer in order to control the data flow. This is useful when your application requires you to send small amounts of data but needs acknowledgement that the data has been sent.</p> <p>For example, if your application is designed to receive 4 bytes at a time, a larger value of say 16 would time out.</p> <p>Permitted values for an UltraPort card are 1 to 64.</p>
Tx FIFO Trigger Level	<p>Sets the level at which the com port Transmit FIFO buffer is filled with data each time a request for more data is made.</p> <p>For example, if set to 16 bytes you get 16 bytes at a time when driver requests data.</p> <p>Permitted values for an UltraPort card are 8, 16, 32 and 56.</p>

Parameter	Description
Rx FIFO Trigger Level	<p>Sets the level at which the com port Receive FIFO buffer is filled before the data is passed on to an application.</p> <p>For example, if set to 16 bytes, 16 bytes of data are accumulated at a time before data is passed on to an application. The FIFO trigger will also time out if the level is not achieved within two character periods of the last byte received.</p> <p>Permitted values for an UltraPort card are 8, 16, 56 and 60.</p>
High Flow Control Threshold	<p>Sets the level at which data flow is suspended. If the limit is exceeded, the driver will stop collecting data.</p> <p>For UltraPort, value is read only, set automatically from FIFO trigger level.</p>
Low Flow Control Threshold	<p>Sets the level at which data flow is resumed.</p> <p>If the low flow threshold is exceeded, the driver requests more data.</p> <p>For UltraPort, value is read only, set automatically from FIFO trigger level.</p>

10. Within the Serial Port properties window, click on the **OK** button to save changes and close the window.

The configuration process is now complete.

Hint

To restore the default settings, use the **Restore Defaults** button.

Installing under SCO OpenServer and OpenServer6

This section tells you how to install host cards, software drivers and utilities under the SCO OpenServer operating system and includes the following:

- [General installation procedure for SCO OpenServer](#) on page [45](#)
- [Installing device drivers and utilities](#) on page [46](#)
- [Serial port naming conventions](#) on page [51](#)
- [Configuring serial ports](#) on page [52](#)
- [Removing drivers and utilities from your system](#) on page [60](#).

General installation procedure for SCO OpenServer

The general procedure for installing and configuring host cards, drivers software and associated utilities for the SCO OpenServer operating system is as follows:

1. Install any UltraPort, UltraPort SI, and UltraPort Express cards you require into your system. See [Installing host cards and cable accessories](#) on page [94](#)
2. Install the SPEED SCO OpenServer drivers and utilities onto your system using the procedures described in [Installing device drivers and utilities](#) on page [46](#).
3. If required, remove any host cards you want from your system. See [Removing host cards](#) on page [100](#).
4. Using the **Port Configuration tool**, configure the serial ports you have added to the system. See [Configuring serial ports](#) on page [52](#).

Your system can now use the serial adaptor cards you have installed. If required, you can reconfigure serial ports following initial installation.

Installing device drivers and utilities

To install the SPEED device drivers and utilities for the SCO OpenServer operating system proceed as follows:

1. Login to your system as super user.
2. Load the CDROM into your system CD drive.
3. At the command prompt, make a directory for your installation by typing:

```
mkdir /cdrom
```

4. Mount the CDROM file system using the following commands:

```
mount -f ISO9660 -r/dev/cd0 /cdrom
```

Note

The example above shows the directory name as **/cdrom**, You can either use this name or use another directory name to suit your requirements. For example, **/mnt**.

5. In the SCO OpenServer desktop, double click on the System Administration folder. The System Administration window is now displayed.
6. In the System Administration window, double click on the software manager icon. The Software Manager window is now displayed.

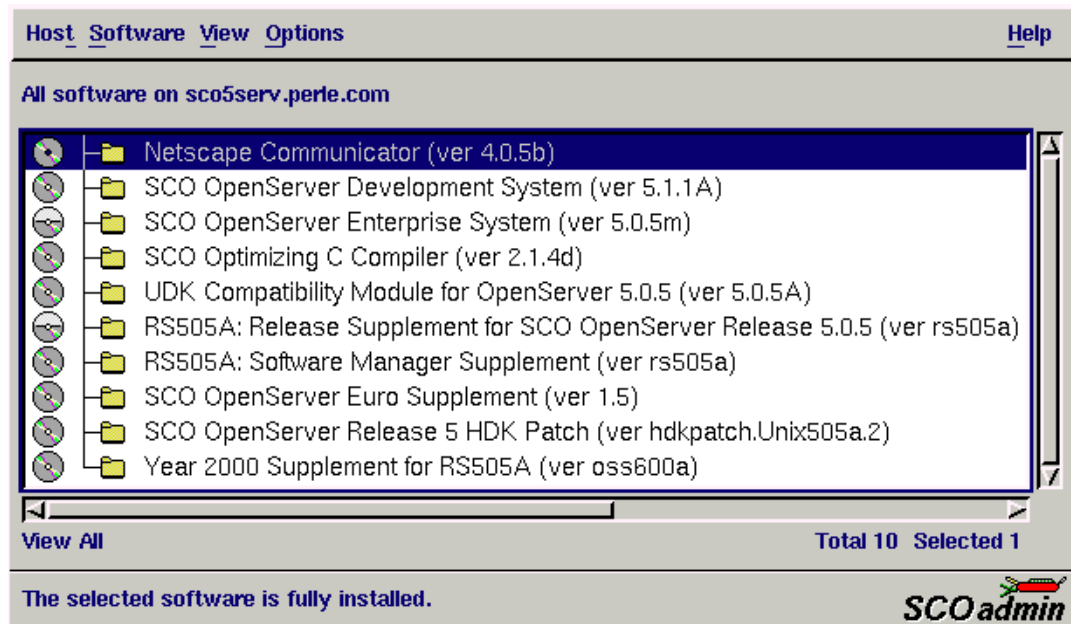

- In the Software Manager menu, click on **Software > Install New**.

The Begin Installation window is now displayed as shown in the next picture.

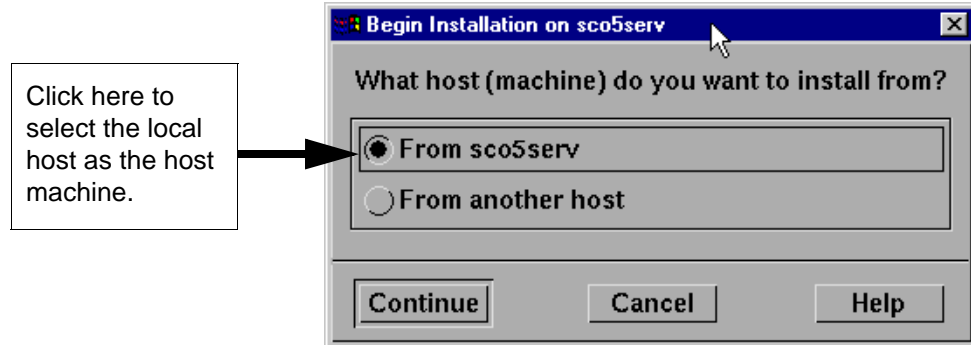

- In the Begin Installation window, select the local host as the machine to install from by clicking on the **From localhostname** button and then click on **Continue**.

The Select Media window is now displayed.

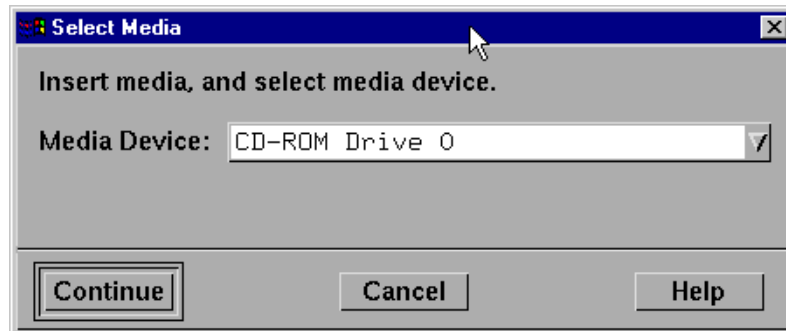

- In the Select Media window, using the **Media Device** selector choose the **Media Images** option then click on **Continue**.

The Enter Image Directory window is now displayed.

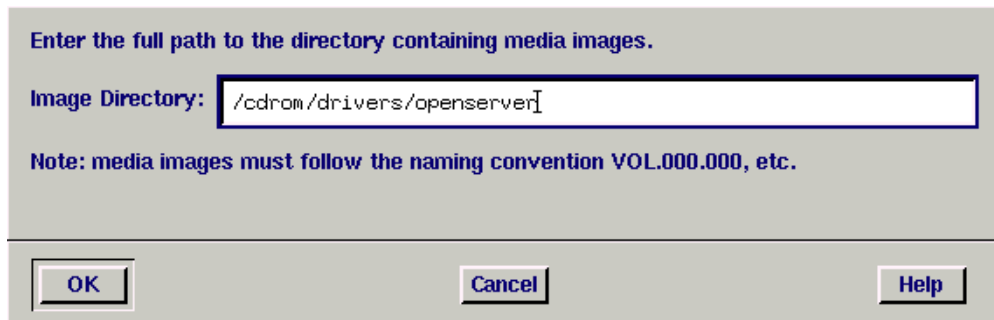

10. In the Enter Image Directory window, enter the following in the Image directory field:

/cdrom/drivers/ultraport/openserver/x.y.z, where x.y.z is the version number of the driver for SCO OpenServer 5.

/cdrom/drivers/ultraport/openserver6/x.y.z, where x.y.z is the version number of the driver for SCO OpenServer 6.

Note

The example and picture above show a directory name including **/cdrom**, You can either include this name in the path or use another directory name to suit your requirements. For example, **/mnt**.

11. In the Enter Image Directory window, click on **OK**.

The Install Selection window is now displayed.

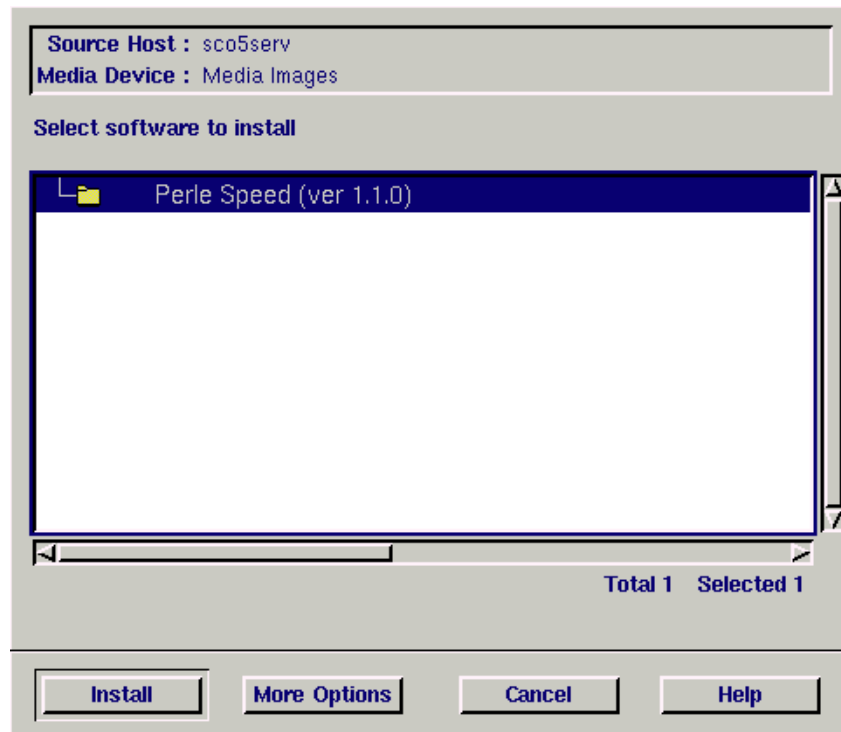

12. In the Install Selection window, click on the **Install** button.

The following progress message is now displayed.

```

Installing      : Selected Software
Installation Phase : Extracting control files
Installation Status : Executing cqs script /opt/K/Perle/SPD_Drivers/1.1.0/cntl/cqs
    
```

The above window will display various progress messages and then the Speed Installation Options window will be displayed.

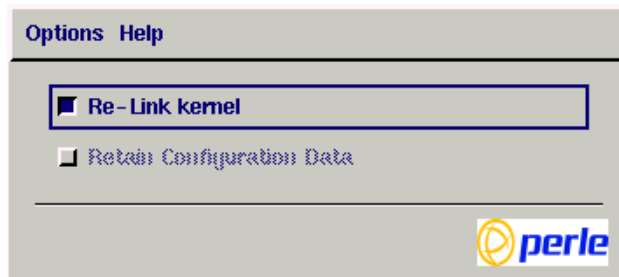

13. If required, in the Speed Installation Options window, select the **Re-Link kernel** option.

Hint
 If you are installing more than one driver, you can de-select this option until you have installed all the drivers and utilities you require to save time.

14. In the Speed Window Installation menu, click on **Options > Exit** to close the window and continue the installation process.

If you select **Re-link kernel**, a message window is displayed at the end of the driver installation prompting you to re-boot the system.



15. In the message window click on **OK** to continue the installation process.

The following message is now displayed upon completion of the installation process.

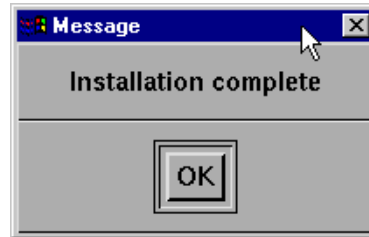

16. In the message window, click on **OK** to close the window.

The software manager window is now updated to show the driver you have installed as shown in the next picture.

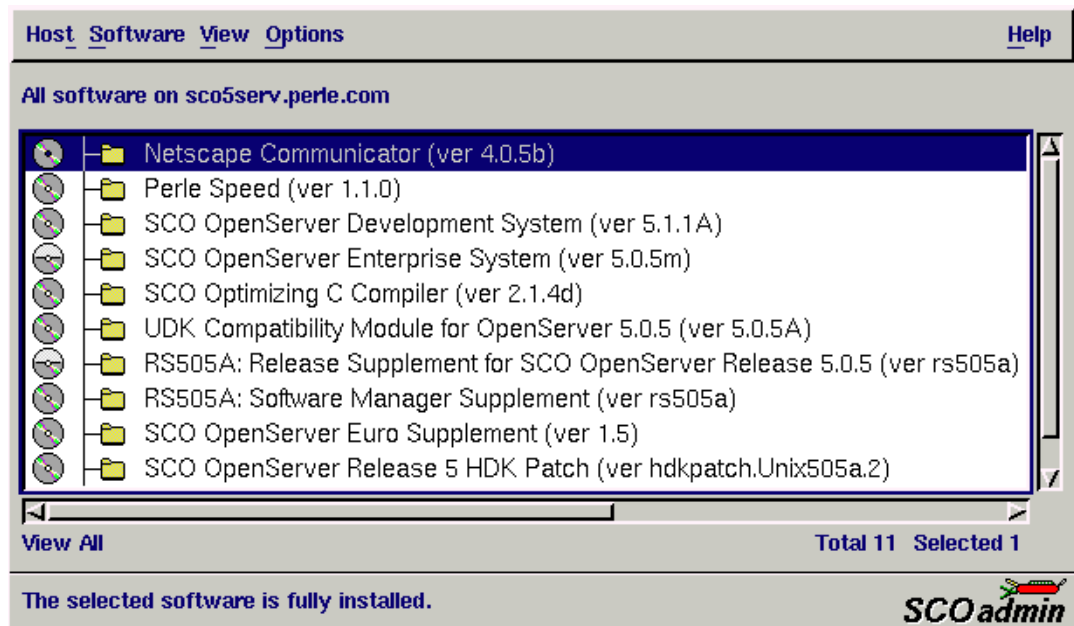

17. In the Software Manager window, click on the **Host > Exit** menu option to close the window.

18. Shut down your system and turn the power off.

You can now continue with the rest of the installation process see [General installation procedure for SCO OpenServer](#) on page 45.

Serial port naming conventions

Each serial port has three device nodes associated with it. Each node takes the form of a file which you can access from operating system utilities and user applications. Details of these nodes are shown in the next table.

Device name	Function	Description	Location
ttyz1	Normal communications port for local "ty" devices.	Indicates normal communications port behaviour.	/dev
ttyZ1	Modem port	Indicates that a port open will not complete unless DCD is present	/dev
ttyz1p	Transparent print port.	Indicates that device should only be used for transparent print.	/dev

Configuring serial ports

The Port Configuration utility allows you to configure the SPEED serial ports you have installed on your system. To do this proceed as follows:

Note

If you want to perform transparent printing from any of the terminals attached to your system, you need to check the contents of the **printcap.spd** file to see if the terminal type you are using is supported. To do this proceed as follows:

1. Using a text editor, go to the **/etc** directory and open the file called **printcap.spd**
2. Check the contents of the **printcap.spd** file to see if the terminal type you are using is supported. See [page 128](#) in [Appendix A : Transparent printing](#) for the syntax of the entries in this file.
3. If the terminal type you are using is not supported, add an entry for the new terminal type (including the type, transparent print ON and transparent print OFF strings) to the **printcap.spd** file ([page 130](#)). See the user guide for your terminal for details of the entries required.

You can now configure the ports you want using the Port Configuration utility.

Starting the Port Configuration utility

1. In the command prompt, type **spdpcfg** and press the **Enter** key. Alternatively use the SCO OpenServer desktop as follows:
 - a. In the SCO OpenServer desktop, open the **System Administration** folder. The System Administration window is now displayed.
 - b. In the System Administration window, click on the **Perle Speed** folder on OpenServer 5 or **Perle-Serial** folder for OpenServer 6 to open it. The Speed window is now displayed.
 - c. In the Speed window, click on the **Speed Port Configuration** Icon. The Port Configuration window is now displayed as shown in the next picture.

The screenshot shows the 'Ports Help' window with the following components and callouts:

- Ports Help** window title.
- Table with columns: Port, Login, gettydef, Terminal Type, Forced flow control.
- Callout: "Menus see page 53." pointing to the title bar.
- Callout: "Select one or more ports from this list." pointing to the table.
- Callout: "Select a getty definition here. See page 54." pointing to the 'Available gettydefs' list (k, l, m, n).
- Callout: "Select a terminal type here. See page 55" pointing to the 'Terminal type' list (ansice, tvl925, unknown, vt220).
- Callout: "Enables or disables flow control. See page 55" pointing to the 'Transparent print flow control' checkboxes (ixon, bany).
- Callout: "Enables or disables login. See page 55" pointing to the 'Login Session' buttons (Enable, Disable).

Menu map

The Port Configuration tool menu is as follows:

Menu option	Description	
Ports >	Quit	Quit Port Configuration tool without saving changes.
	Logins	Display all ports with logins enabled.
	Unconfigured	Display all ports without logins enabled.
	All	Display all ports.
	Save & Exit	Exit the Port Configuration tool and save changes.

Selecting ports

- In the Port Configuration window, select the ports you want you want to configure by clicking on one or more items in the list of ports (example in next picture).

Hint

To select multiple items which follow each other in the list, hold down the **Shift** key and click on all the items you want.

To select multiple items from anywhere in the list, hold down the **Ctrl** key and click on all the items you want.

Port	Login	gettydef	Terminal Type	Forced flow control
1	m		unknown	
2	m		unknown	
3	m		unknown	

Selecting a getty definition

- In the Port Configuration window, select the getty definition you want by double clicking on an item in the **Available gettydefs** list. Alternatively, click on the **Set** button.

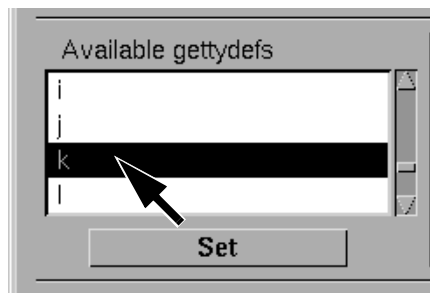

The list of currently selected ports is now updated to show the new getty definition.

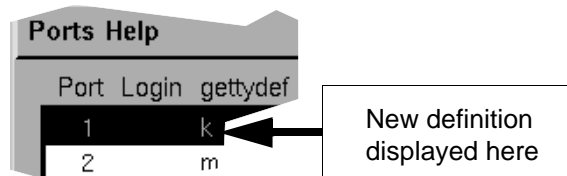

Selecting terminal type

- In the Terminal type list, double click on the terminal type you want for the currently selected ports. Alternatively, single click on the item you want in the Terminal type list and press the **Set** button.

The list of ports is now updated to show the new terminal type.

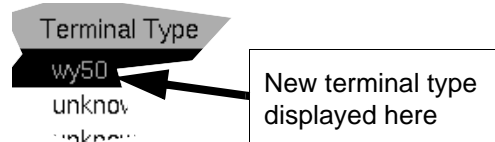

Enabling and disabling flow control

- If required, in the Port Configuration window, click on the **ixon** button to enable flow control for Transparent printing.

Note
For information about transparent printing, see [Appendix A : Transparent printing](#).

- If required, in the Port Configuration window, click on the **ixany** button to enable sending of data on receipt of the next character (when flow control is enabled on the transparent print port).

Setting up a port login

- In the Port Configuration window, click on one of the menu options shown in the next table to display the ports with the login status you want to change. For example, ports without logins enabled.

These options allow you to filter on the type of ports you are looking for. This facility is helpful when you have a large number of ports installed.

To Display	Click menu option
All ports with logins enabled	Ports > Logins
All ports without logins enabled	Ports > Unconfigured
Display all ports	Ports > All

8. If required, in the Port Configuration window, select the ports whose logins status you want to change, then click on one of the following to change the login status:

Tc	Click on
Enable logins for a port	Enable button
Disable logins for a port	Disable button

The selected ports in the list now are updated show their new login status. For example if you enable the login for a port, a tick is displayed along side the port as shown in the next picture.

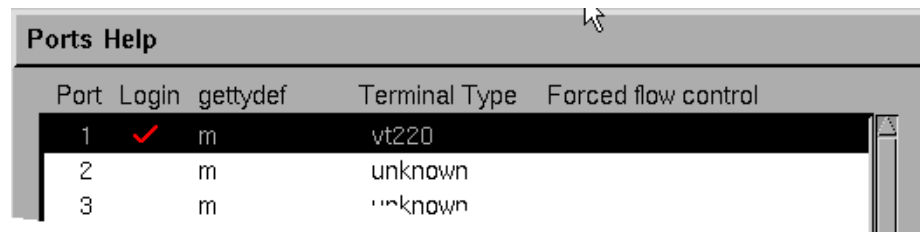

Port	Login	gettydef	Terminal Type	Forced flow control
1	✓	m	vt220	
2		m	unknown	
3		m	unknown	

9. Repeat steps 2. to 8. until you have configured all the ports you want.

Exiting the Port Configuration tool

10. In the Port Configuration menu, click on **Ports > Save & Exit**.

Note

To quit the Port Configuration tool without saving changes,

- In the Port Configuration menu, click on **Ports > Quit**.

The Port Configuration tool now closes and saves any changes you have made.

Setultrap Interface Protocol Configuration Utility (UltraPort SI only)

Perle provides a command line utility that allows the user to configure each UltraPort SI serial ports for features EIA-232, EIA-422, EIA-485 full duplex and EIA-485 half duplex.

Note

The default interface protocol for the Perle UltraPort SI cards is EIA-232.

Command Line Interface

setultrap -f device_name -l

setultrap -f device_name -x baud-multiplier

setultrap -f device_name -m 232 [-s fast|slow]

setultrap -f device_name -m 422 [-s fast|slow] [-t term|unterm]

setultrap -f device_name -m 485fdx [-s fast|slow] [-t term|unterm] [-a auto|rts] [-b 0-15]

setultrap -f device_name -m 485hdx [-s fast|slow] [-t term|unterm] [-e echoon|echooff] [-a auto|rts] [-b 0-15]

-l list protocol configuration for serial device(s)

-x set baudrate multiplier for serial devices(s)

-m set interface protocol for serial device(s)

Option description	Configuration option	232	422	485hdx	485fdx
specifies the port to apply the configuration option to	-f	required	required	required	required
Lists the serial ports configuration	-l	optional	optional	optional	optional
Interface mode	-m	default 232	optional 422	optional 485hdx	optional 485fdx

Option description	Configuration option	232	422	485hdx	485fdx
Baud rate multiplier	-x	optional (1,2,4,8, 16,32)	optional (1,2,4,8, 16,32)	optional (1,2,4,8, 16,32)	optional (1,2,4,8, 16,32)
Slew rate limiting	-s	optional fast/slow	optional fast/slow	optional fast/slow	optional fast/slow
Line termination	-t	N/A	optional (term/ unterm)	optional (term/ unterm)	optional (term/ unterm)
EIA-485 HDX local echo	-e	N/A	N/A	optional echoon/ echoff	N/A
EIA-485 TX Driver Control	-a	N/A	N/A	optional (auto/rts)	optional (auto/rts)
Auto EIA-485 bit delay	-b	N/A	N/A	optional (0 -15)	optional (0 -15)

(-f) Specifies the name or range of names which the action should be taken on.

For example:

/dev/ttyz1 -specifies port 1

/dev/ttyz1,/dev/ttyz64 - specifies ports 1 through 64

(-l) Lists the protocol configuration for each serial port configured on the UltraPort SI.

/dev/ttyz1 232 slow term 1

/dev/ttyz1 485fdx fast term auto 5 1

The first example shows a device named ttyz1 configured for protocol mode EIA-232, slew rate limiting is set to slow, termination is on, and the baud rate multiplier is 1

The second example shows device named ttyz1 configured for protocol mode EIA-485fdx, slew rate limiting is set to fast, termination is on, EIA-485 HDX TX Driver Control is set to auto with bit delay of 5 bits and the baud rate multiplier is 1

(- m) Interface mode: The valid software switchable protocol types are EIA-232, EIA-422, EIA-485 Full Duplex and EIA-485 Half Duplex. Each port on the UltraPort SI are independent of each other and therefore you may select different protocols per serial port.

(-x) Baud Rate Multiplier: The baud rate multiplier allows the user to multiply the configured baud rate by 1, 2, 4, 8,16 or 32, hence achieving greater speeds on the UltraPort SI serial interfaces. This is applicable for each protocol type selected. Baud rates for EIA-232 are up to 921.6 Kbps per serial port. Baud rates for EIA-422/EIA-485 are up to 3.686 Mbps per serial port.

(-s) Slew Rate Limiting: The default setting for slew rate limiting is fast. This will allow higher baud rate speeds on each EIA interface port. Slew rate limiting enabled, minimizes EMI and reduces reflections caused by improperly terminated cables. Operation in slew rate limited mode reduces the amplitudes of high-frequency harmonics.

(-t) Line Termination: The line termination parameter is not changeable by the user in EIA-232 mode. However both EIA-422 and EIA-485 modes are defaulted to terminated but can be changed by the user if needed.

(-e) EIA-485 HDX Local Echo: Local echo by default is set to echoon. This parameter applies only to EIA-485 half duplex mode. All characters will be echoed to the user and transmitted across the serial ports. Some EIA-485 applications require local echo to be enable in order to monitor the loopback data to determine that line contention has occurred. If your application cannot handle loopback data the local echo should be set to echooff.

(-a) EIA-485 TX Driver Control: The default for this field is auto. When auto is set the UltraPort SI will automatically detect the beginning and the ending of data being transmitted in order to enable and disable the transmit line. When the field is set to rts it is the host application's responsibility to enable and disable the transmit line via the RTS handshake line when it wants to send data.

(-b) Auto EIA-485 Bit Delay: By default this field is set to 0 delay. This field is only applicable if you have configured EIA-485 TX Driver Control to AUTO. Values for this field are 0 through 15 bits.

(-h) Help: Displays the setultrap usage screen.

The following examples show typical user applications:

```
etc/setultrap -f /dev/ttyz1,/dev/ttyz16 -l -lists options configured for serial ports 1 through 16.
```

```
etc/setultrap -f /dev/ttyz1,/dev/ttyz16 -m 422 -sets serial port 1 through 16 to interface type EIA-422
```

```
etc/setultrap -f /dev/ttyz1,/dev/ttyz4 -m 485fdx -configures ports 1 to 4 to EIA-485 full duplex
```

```
etc/setultrap -f /dev/ttyz1 -m 485hdx -t term -b 5 -sets serial port ttyz1 to EIA-485 half duplex termination enabled, control bit-delay 5
```

These commands may be added to a startup script to cause them to run automatically whenever the system is started. A sample commented out startup script (etc/rc.setultrap) is supplied with this driver.

Note

The port must be closed and then opened for the new parameters to take effect.

Removing drivers and utilities from your system

To remove the SPEED device drivers and utilities for the SCO OpenServer operating system proceed as follows:

1. In the SCO OpenServer desktop, double click on the System Administration folder.
The System Administration window is now displayed.
2. In the System Administration window, double click on the software manager icon.
The Software Manager window is now displayed.

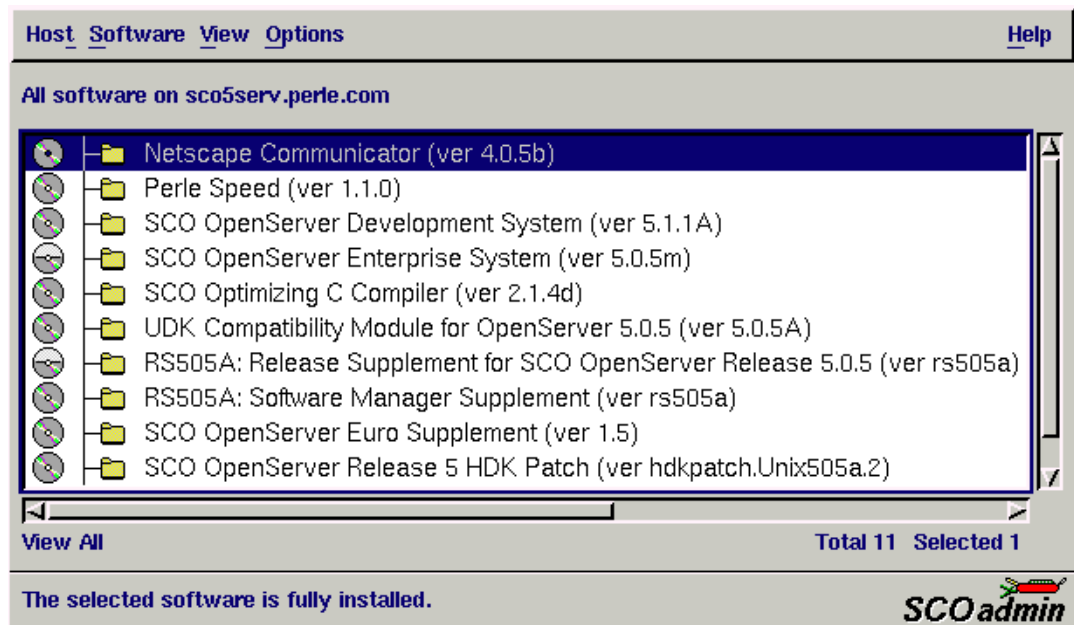

3. In the Software Manager window select the driver you want to remove.
4. In the Software Manager menu, click on **Software > Remove software**.
A confirmation window is now displayed prompting you to confirm removal.

5. In the confirmation window, click on the **Remove** button.

The software is now removed and the following Kernel re-link message is now displayed as shown in the next picture (not displayed under SCO OpenServer 6).

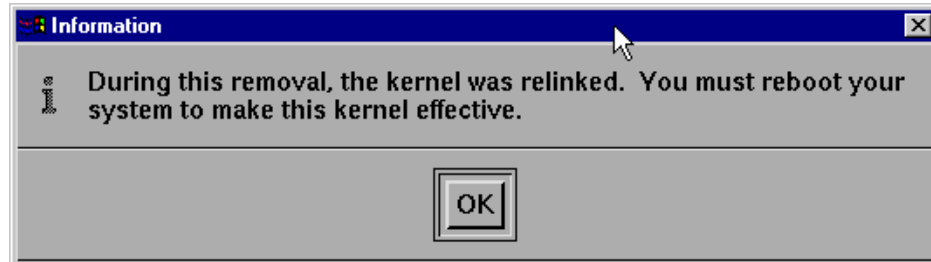

The Kernel re-link message window now closes and the removal continues. A message is displayed upon completion.

6. In the message window, click on **OK** to close the window.

The software manager window is now updated to show the remaining software.

Installing under SCO UnixWare

This section tells you how to install host cards, software drivers and utilities under the SCO UnixWare operating system and includes the following:

- [General installation procedure for SCO UnixWare](#) on page [63](#)
- [Installing drivers and utilities](#) on page [64](#)
- [Serial port naming conventions](#) on page [65](#)
- [Configuring serial ports](#) on page [66](#)
- [Installing under Solaris](#) on page [74](#).

General installation procedure for SCO UnixWare

The general procedure for installing and configuring host cards, drivers software and associated utilities for the SCO UnixWare operating system is as follows:

1. Install any UltraPort cards you require into your system. See [Installing host cards and cable accessories](#) on page [94](#)

Note

Once you have installed the SPEED drivers, if you add or remove any host cards the operating system will update the kernel accordingly using the **spdconf** program.

spdconf is run automatically during boot up and checks to see if any host cards have been added or removed since the last time the system was powered up. If anything has changed the files which identify the ports, terminals and transparent printing are updated.

2. If required, install the SPEED SCO UnixWare drivers and utilities onto your system using the procedures described in [Installing drivers and utilities](#) on page [64](#).
3. If required, remove any host cards you want from your system. See [Removing host cards](#) on page [100](#).
4. Using the **Serial Manager** utility, configure the serial ports you have added to the system. See [Configuring serial ports](#) on page [66](#).

Your system can now use the serial adaptor cards you have installed. If required, you can reconfigure serial ports following initial installation.

Installing drivers and utilities

To install the SPEED device drivers and utilities for the SCO UnixWare operating system proceed as follows:

1. Login to your system as root.
2. Load the CDROM into your system CD drive.
3. Mount the CDROM to a mount point, for example `/cdrom`.
4. At the command prompt, type:
pkgadd -d /cdrom/drivers/ultraport/unixware/x.y.z/spd-uw-x.y.z.pkg spd , where x.y.z is the version number of the driver.
5. Press the **Enter** key.

The system now installs the driver and displays a series of messages ending with a successful installation message.

Upon installation of the drivers, your UltraPort cards are ready to use.

Note

A re-boot of your system is not necessary as the drivers for your UltraPort card are dynamically loadable and will be loaded as soon as any software attempts to access the associated devices.

Serial port naming conventions

Each serial port has three device nodes associated with it. Each node takes the form of a file which you can access from operating system utilities and user applications. Details of these nodes are shown in the next table.

Device name	Function	Description	Location
z1	Normal communications port for local "tty" devices.	Indicates normal communications port behaviour.	/dev/term
Z1	Modem port	Indicates that a port open will not complete unless DCD is present	/dev/term
z1p	Transparent print port.	Indicates that device should only be used for transparent print.	/dev/term

Configuring serial ports

The software provided with the SCO UnixWare operating system includes a utility called Serial Manager which allows you to configure the extra serial ports you have added to your system.

Note

On UnixWare 7.0, you must apply a patch file called **ptf7053** before using the Serial Manager. You can find the patch on the SCO web site at:

<http://www.sco.com>

To configure serial ports with Serial Manager proceed as follows:

Note

If you want to perform transparent printing from any of the terminals attached to your system, you need to check the contents of the **printcap.spd** file to see if the terminal type you are using is supported. To do this proceed as follows:

1. Using a text editor, go to the **/etc** directory and open the file called **printcap.spd**
2. Check the contents of the **printcap.spd** file to see if the terminal type you are using is supported. See [page 130](#) in [Appendix A : Transparent printing](#) for the syntax of the entries in this file.
3. If the terminal type you are using is not supported, add an entry for the new terminal type (including the type, transparent print ON and transparent print OFF strings) to the **printcap.spd** file ([page 130](#)). See the user guide for your terminal for details of the entries required.
4. If you have made any changes then type **spdconf** in order to re-configure the print port settings.

You can now configure the ports you want using the Serial Manager utility.

1. At the command prompt, type **scoadmin**

The System Administration window is now displayed as shown in the next picture.

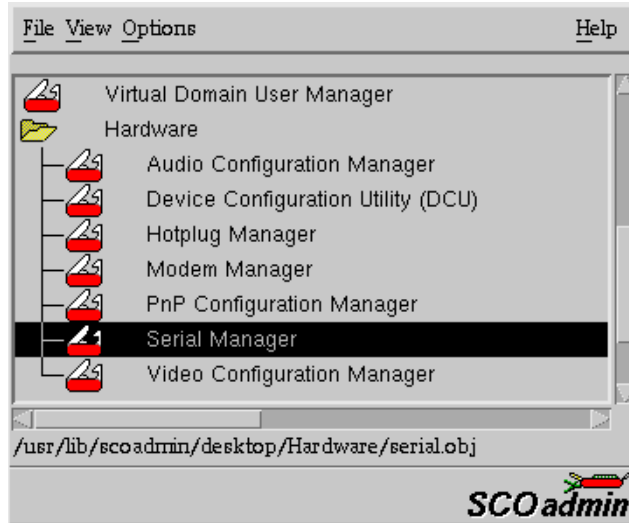

2. In the System Administration tool window, click on the Hardware folder and then select **Serial Manager**

The Serial Manager window is now displayed showing the host cards (including SPEED) currently present on the system.

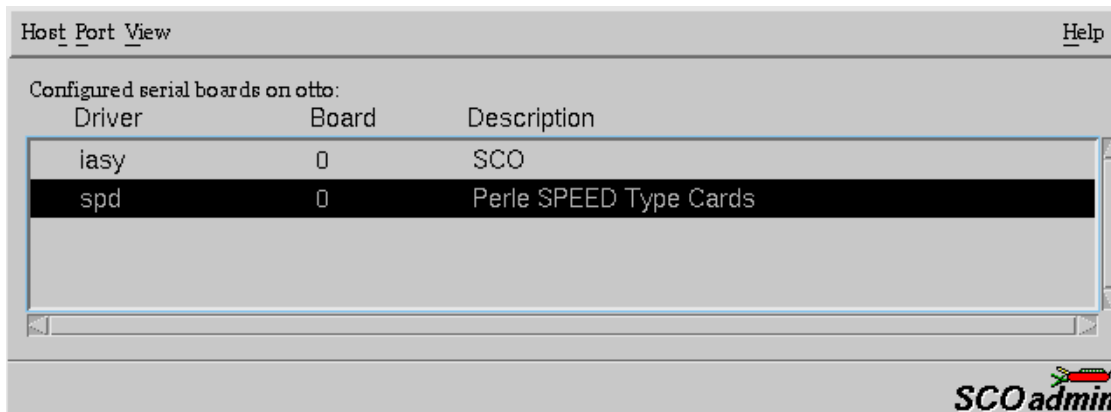

- In the Serial Manager window, select the host card you want. Then in the Serial Manager menu, click on **View > Ports**.

The Serial Manager window now displays the ports available for the selected host card as shown in the next picture.

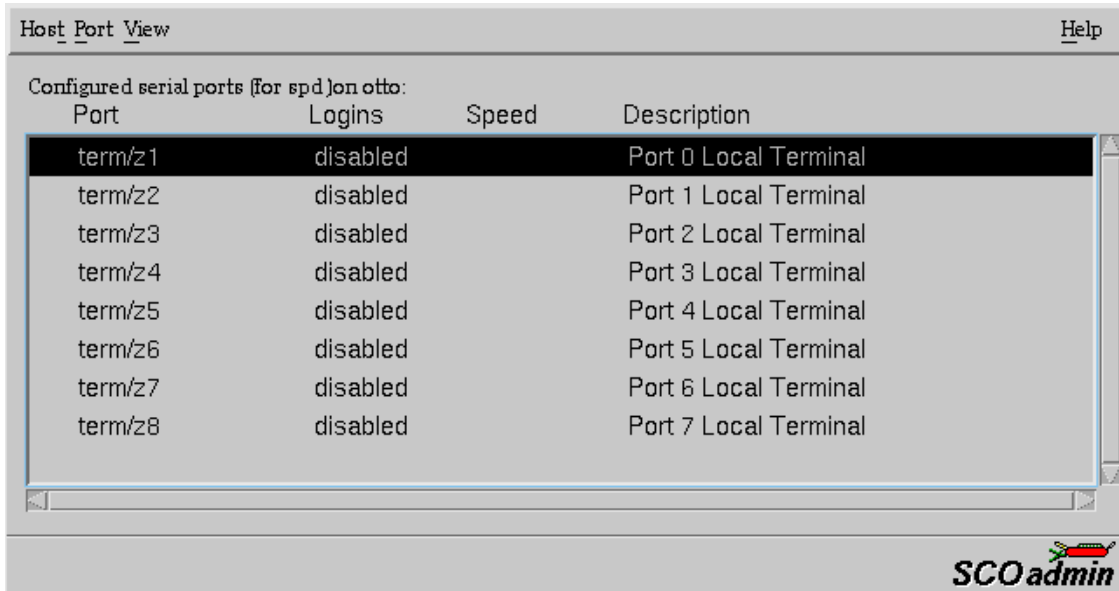

- In the Serial Manager menu, click on **Port-U > Modify**.

The Modify Serial Port window is now displayed.

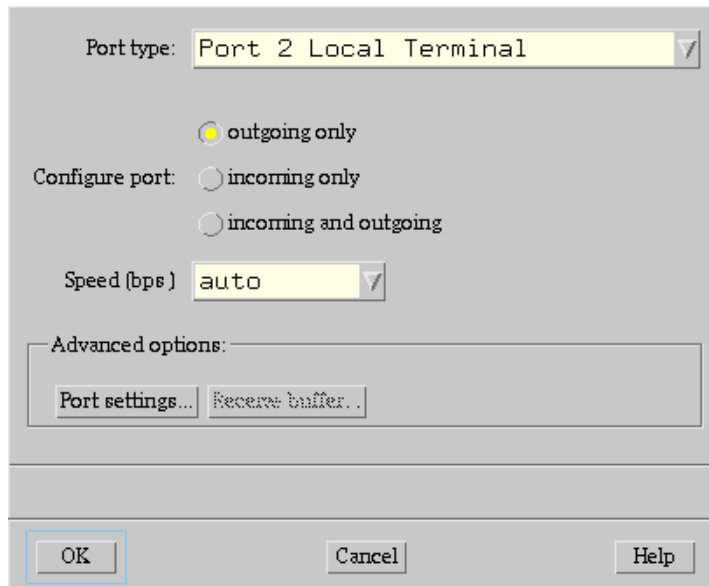

5. In the Modify Serial Port window, set the parameters shown in the next table

Parameter	Set to
Port Type	Select either Local Terminal or Modem
Configure port	incoming only
Speed	the speed value you require

Note

Because the system does not support the selection of speeds above 115200 bps, lower baud rates have been permanently remapped to support higher port speeds. Remapped speeds are shown in the next table.

Selected speed (bps)	Actual speed (bps)
50	230400
75	460800
110	921600

6. In the Modify Serial Port window, click on the **Port settings** button.

The Port settings window is now displayed.

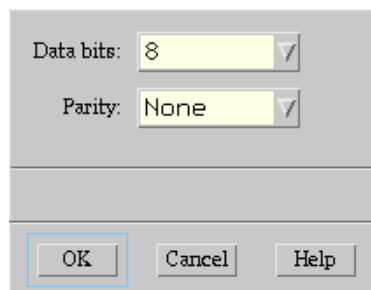

7. In the Port settings window, select the **Data bits** and **Parity** values you require and click on **OK**.
8. In the Modify Serial Port window, click on OK to accept the changes you have made and close the window.
9. Repeat steps 3. to 8. until you have configured the serial ports for all the host cards you require.
10. In the Serial Manager menu click on **Host > Quit** to quit Serial Manager and close the window.

Setultrap Interface Protocol Configuration Utility (UltraPort SI only)

Perle provides a command line utility that allows the user to configure each UltraPort SI serial port individually for EIA-232, EIA-422, EIA-485 full duplex or EIA-485 half duplex protocol.

Note

The default interface protocol for the Perle UltraPort SI cards is EIA-232.

Command Line Interface

setultrap -f device_name -l

setultrap -f device_name -x baud-multiplier

setultrap -f device_name -m 232 [-s fast|slow]

setultrap -f device_name -m 422 [-s fast|slow] [-t term|unterm]

setultrap -f device_name -m 485fdx [-s fast|slow] [-t term|unterm] [-a auto|rts] [-b 0-15]

setultrap -f device_name -m 485hdx [-s fast|slow] [-t term|unterm] [-e echoon|echooff] [-a auto|rts] [-b 0-15]

-l list protocol configuration for serial device(s)

-x set baudrate multiplier for serial devices(s)

-m set interface protocol for serial device(s)

:

Option description	Configuration option	232	422	485hdx	485fdx
specifies the port to apply the configuration option to	-f	required	required	required	required
Lists the serial ports configuration	-l	optional	optional	optional	optional

Option description	Configuration option	232	422	485hdx	485fdx
Interface mode	-m	default 232	optional 422	optional 485hdx	optional 485fdx
Baud rate multiplier	-x	optional (1,2,4,8, 16,32)	optional (1,2,4,8, 16,32)	optional (1,2,4,8, 16,32)	optional (1,2,4,8, 16,32)
Slew rate limiting	-s	optional fast/slow	optional fast/slow	optional fast/slow	optional fast/slow
Line termination	-t	N/A	optional (term/ unterm)	optional (term/ unterm)	optional (term/ unterm)
EIA-485 HDX local echo	-e	N/A	N/A	optional echoon/ echoff	N/A
EIA-485 TX Driver Control	-a	N/A	N/A	optional (auto/rts)	optional (auto/rts)
Auto EIA-485 bit delay	-b	N/A	N/A	optional (0 -15)	optional (0 -15)

(-f) Specifies name or range of names of the tty device on which the action should be taken.

For example:

`/dev/term/z1` -specifies port 1

`/dev//term/z1,/dev/term/z64` -specifies ports 1 through 64 (ranges are separated by a comma)

(-l) Lists the protocol configuration for each serial port configured on the UltraPort SI.

`/dev/term/z1 232 slow term 1`

`/dev/term/z1 485fdx fast term auto 5 1`

The first example shows a device named z1 configured for protocol mode EIA-232, slew rate limiting is set to slow, termination is on, and the baud rate multiplier is 1

The second example shows device named z1 configured for protocol mode EIA-485fdx, slew rate limiting is set to fast, termination is on, EIA-485 HDX TX Driver Control is set to auto with bit delay of 5 bits and the baud rate multiplier is 1

(- m) Interface mode: The valid software switchable protocol types are EIA-232, EIA-422, EIA-485 Full Duplex and EIA-485 Half Duplex. Each port on the UltraPort SI are independent of each other and therefore you may select different protocols per serial port.

(-x) Baud Rate multiplier: The baud rate multiplier allows the user to multiply the configured baud rate by 1, 2, 4, 8, 16 or 32, hence achieving greater speeds on the UltraPort SI serial interfaces. This is applicable for each protocol type selected. Baud rates for EIA-232 are up to 921.6 Kbps per serial port. Baud rates for EIA-422/EIA-485 are up to 3.686 Mbps per serial port.

(-s) Slew Rate Limiting: The default setting for slew rate limiting is fast. This will allow higher baud rate speeds on each EIA interface port. Slew rate limiting enabled, minimizes EMI and reduces reflections caused by improperly terminated cables. Operation in slew rate limited mode reduces the amplitudes of high-frequency harmonics.

(-t) Line Termination: The line termination parameter is not changeable by the user in EIA-232 mode. However both EIA-422 and EIA-485 modes are defaulted to terminated but can be changed by the user if needed.

(-e) EIA-485 HDX Local Echo: Local echo by default is echoon. This parameter applies only to EIA-485 half duplex mode. All characters will be echoed to the user and transmitted across the serial ports. Some EIA-485 applications require local echo to be enable in order to monitor the loopback data to determine that line contention has occurred. If your application cannot handle loopback data the local echo should be set to echooff.

(-a) EIA-485 TX Driver Control: The default for this field is auto. When auto is set the UltraPort SI will automatically detect the beginning and the ending of data being transmitted in order to enable and disable the transmit line. When the field is set to rts it is the host application's responsibility to enable and disable the transmit line via the RTS handshake line when it wants to send data.

(-b) Auto EIA-485 Bit Delay: By default this field is set to 0 delay. This field is only applicable if you have configured EIA-485 TX Driver Control to AUTO. Values for this field are 0 through 15 bits.

(-h) Help: Displays the setultrap usage screen.

Note

The port must be closed and then opened for the new parameters to take effect.

The following examples show typical user applications:

```
etc/setultrap -f /dev/term/z1,/dev/term/z16 -l -lists options configured for serial ports 1 through 16
```

```
etc/setultrap -f /dev/term/z1,/dev/term/z16 -m 422 -sets mode EIA-422 for serial port 1 through 16
```

```
etc/setultrap -f /dev/term/z1,/dev/term/z4 -m 485fdx -configures serial ports 1 to 4 to EIA-485 full duplex
```

`etc/setultrap -f /dev/term/z1 -m 485hdx -t term -b 5 -sets serial port z1 to EIA-485 half duplex, termination enabled, control bit-delay 5.`

These commands may be added to a startup script to cause them to run automatically whenever the system is started. A sample commented out startup script (`/etc/rc.setultrap`) is supplied with this driver.

Removing drivers and utilities from your system

To remove the software drivers from your system under the SCO UnixWare operating system proceed as follows:

1. At the command prompt, type **pkgrm spd** and press **Enter**

The SPEED driver and associated utilities are now removed from your system.

Installing under Solaris

This section tells you how to install host cards, software drivers and utilities under the Solaris operating system and includes the following:

- [General installation procedure for Solaris](#) on page [75](#)
- [Installing drivers and utilities](#) on page [76](#)
- [Serial port naming conventions](#) on page [77](#)
- [Configuring serial ports](#) on page [78](#)
- [Removing drivers and utilities from your system](#) on page [85](#).

General installation procedure for Solaris

The general procedure for installing and configuring host cards, drivers software and associated utilities for the Solaris operating system is as follows:

1. Install any UltraPort cards you require into your system. See [Installing host cards and cable accessories](#) on page [94](#)

Note

Once you have installed the drivers, if you add or remove any host cards the operating system will update the kernel accordingly using the **startcomf** program.

startcomf is run automatically during boot up and checks to see if any host cards have been added or removed since the last time the system was powered up. If anything has changed the files which identify the ports and terminals are updated.

2. If required, install the Solaris drivers and utilities onto your system using the procedures described in [Installing drivers and utilities](#) on page [76](#).
3. If required, remove any host cards you want from your system. See [Removing host cards](#) on page [100](#).
4. Using the **admintool** utility, configure the serial ports you have added to the system. See [Configuring serial ports](#) on page [78](#).

Your system can now use the serial adaptor cards you have installed. If required, you can reconfigure serial ports following initial installation.

Installing drivers and utilities

To install the device drivers and utilities for the Solaris operating system proceed as follows:

1. Login to your system as root.
2. Load the CDROM into your system CD drive.
3. Mount the CDROM to a mount point, for example `/cdrom`.
4. At the command prompt, type:
pkgadd -d /cdrom/drivers/ultraport/solaris/x.y.z/fast-sol-x.y.z.<arch>.pkg comf,
where x.y.z is the version number of the driver and <arch> is the Solaris architecture,
either **i386** for Intel or **sparc** for Sparc stations.
5. Press the **Enter** key.

The system now installs the driver and displays a series of messages ending with a successful installation message.

Upon installation of the drivers, your UltraPort cards are ready to use.

Note

A re-boot of your system is not necessary as the drivers for your UltraPort card are dynamically loadable and will be loaded as soon as any software attempts to access the associated devices.

Serial port naming conventions

By default, each port is associated with three entries under the `/dev` directory.

Two take the form `/dev/comfxy` and `/dev/term/comfxy` where **x** is the card number (1-4) and **y** is a lower case letter in the range a-p. a is port 1, ..., p is port 16. These device names are intended for local devices.

The third device name takes the form `/dev/cua/comfxy` where **x** is the card number and **y** is a lower case letter in the range a-p, as before. These devices are intended for use with modems.

These mappings can be altered by careful modification of the **mkdev** and **startcomf** scripts in `/usr/lib/comf/i86`.

Configuring serial ports

The software provided with the Solaris operating system includes a utility called **admintool** which allows you to configure the extra serial ports you have added to your system.

To configure serial ports with **admintool** proceed as follows:

1. At the command prompt, type **admintool**

The **Admintool: Users** window is now displayed as shown in the next picture.

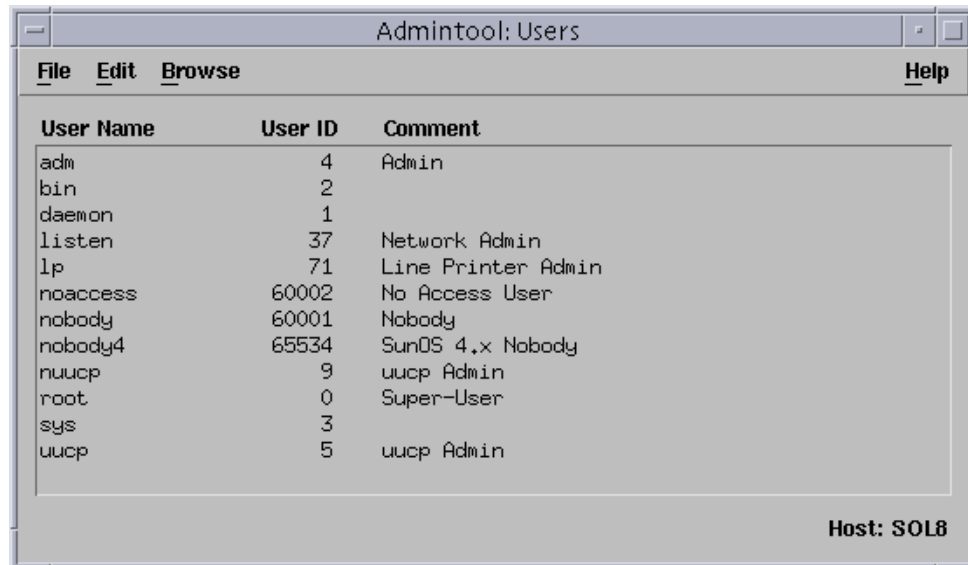

- In the **Admintool: Users** window, click on **Browse > Serial Ports**.

The **Admintool: Serial Ports** window is now displayed showing all serial ports currently present on the system

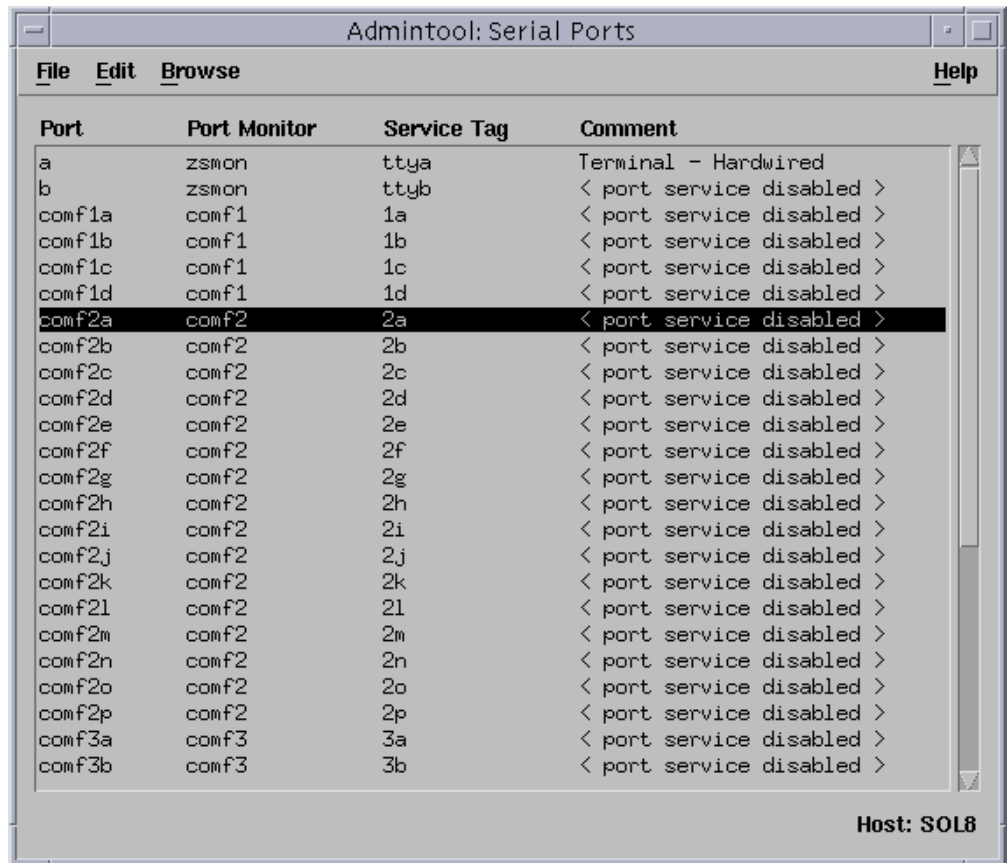

Port	Port Monitor	Service Tag	Comment
a	zsmn	ttya	Terminal - Hardwired
b	zsmn	ttyb	< port service disabled >
comf1a	comf1	1a	< port service disabled >
comf1b	comf1	1b	< port service disabled >
comf1c	comf1	1c	< port service disabled >
comf1d	comf1	1d	< port service disabled >
comf2a	comf2	2a	< port service disabled >
comf2b	comf2	2b	< port service disabled >
comf2c	comf2	2c	< port service disabled >
comf2d	comf2	2d	< port service disabled >
comf2e	comf2	2e	< port service disabled >
comf2f	comf2	2f	< port service disabled >
comf2g	comf2	2g	< port service disabled >
comf2h	comf2	2h	< port service disabled >
comf2i	comf2	2i	< port service disabled >
comf2j	comf2	2j	< port service disabled >
comf2k	comf2	2k	< port service disabled >
comf2l	comf2	2l	< port service disabled >
comf2m	comf2	2m	< port service disabled >
comf2n	comf2	2n	< port service disabled >
comf2o	comf2	2o	< port service disabled >
comf2p	comf2	2p	< port service disabled >
comf3a	comf3	3a	< port service disabled >
comf3b	comf3	3b	< port service disabled >

Host: SOL8

3. In the **Admintool: Serial Ports** window, select the port you want to configure. To configure the port, click on **Edit > Modify**.

The **Admintool: Modify Serial Port** window is now displayed.

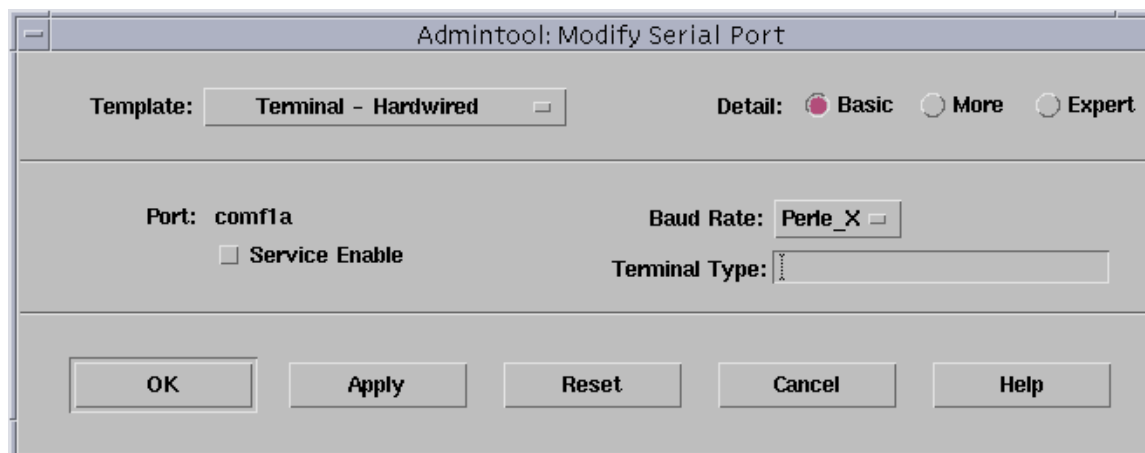

In the **Admintool: Modify Serial Port** window you can click on the **Expert** button to show more fields, as shown in the next picture.

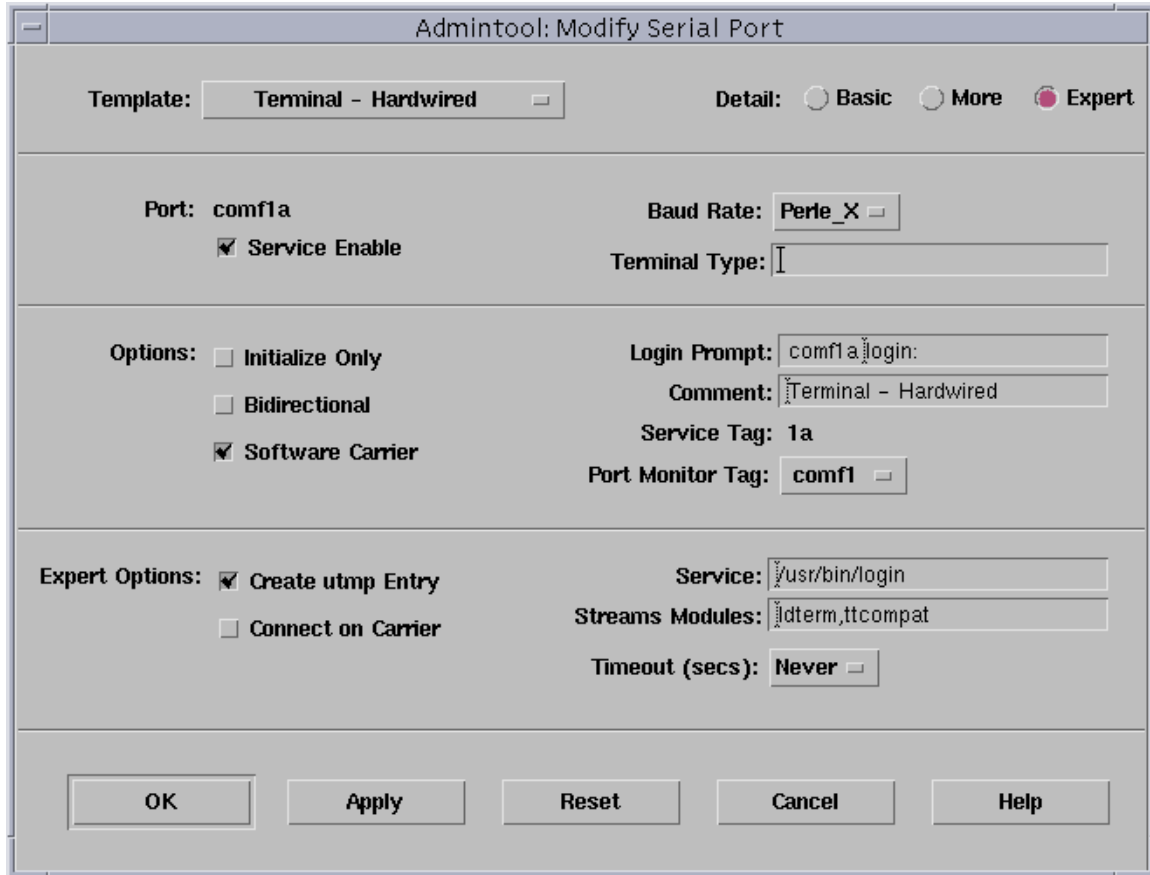

4. In the **Admintool: Modify Serial Port** window, set the parameters you require.

Note
Because the system does not support the selection of speeds above 460800 bps, lower baud rates have been permanently remapped to support higher port speeds. Remapped speeds are shown in the next table.

Selected speed (bps)	Actual speed (bps)
50	921600

5. In the **Admintool: Modify Serial Port** window, click on OK to accept the changes you have made and close the window.
6. Repeat steps 3. to 5. until you have configured the serial ports for all the host cards you require.
7. In the Serial Manager menu click on **Host > Quit** to quit Serial Manager and close the window.

Setultrap Interface Protocol Configuration Utility (UltraPort SI only)

Perle provides a command line utility that allows the user to configure each UltraPort SI serial ports for features EIA-232, EIA-422, EIA-485 full duplex and EIA-485 half duplex.

Note

The default interface protocol for the Perle UltraPort SI cards is EIA-232.

Command Line Interface

setultrap -f device_name -l

setultrap -f device_name -x baud-multiplier

setultrap -f device_name -m 232 [-s fast|slow]

setultrap -f device_name -m 422 [-s fast|slow] [-t term|unterm]

setultrap -f device_name -m 485fdx [-s fast|slow] [-t term|unterm] [-a auto|rts] [-b 0-15]

setultrap -f device_name -m 485hdx [-s fast|slow] [-t term|unterm] [-e echoon|echooff] [-a auto|rts] [-b 0-15]

-l list protocol configuration for serial device(s)

-x set baudrate multiplier for serial devices(s)

-m set interface protocol for serial device(s):

Option description	Configuration option	232	422	485hdx	485fdx
specifies the port to apply the configuration option to	-f	required	required	required	required
Lists the serial ports configuration	-l	optional	optional	optional	optional
Interface mode	-m	default 232	optional 422	optional 485hdx	optional 485fdx

Option description	Configuration option	232	422	485hdx	485fdx
Baud rate multiplier	-x	optional (1,2,4,8, 16,32)	optional (1,2,4,8, 16,32)	optional (1,2,4,8, 16,32)	optional (1,2,4,8, 16,32)
Slew rate limiting	-s	optional fast/slow	optional fast/slow	optional fast/slow	optional fast/slow
Line termination	-t	N/A	optional (term/ unterm)	optional (term/ unterm)	optional (term/ unterm)
EIA-485 HDX local echo	-e	N/A	N/A	optional echoon/ echoff	N/A
EIA-485 TX Driver Control	-a	N/A	N/A	optional (auto/rts)	optional (auto/rts)
Auto EIA-485 bit delay	-b	N/A	N/A	optional (0 -15)	optional (0 -15)

(-f) Specifies the name or range of names in which the action should be taken on.

/term/comf1a -specifies port 1 on card 1

/term/comf2a,/term/comf2p - specifies ports 1 through 16 to interface type EIA-422 on card 2

(-l) Lists protocol configuration for each serial port configured on the UltraPort SI.

/dev/term/comf1a 232 slow term 1

/dev/term/comf1a 485fdx fast term auto 5 1

The first example shows a device named comf1a configured for protocol mode EIA-232, slew rate limiting is set to slow, termination is on, and the baud rate multiplier is 1

The second example shows device named comf1a configured for protocol mode EIA-485fdx, slew rate limiting is set to fast, termination is on, EIA-485 HDX TX Driver Control is set to auto with bit delay of 5 bits and the baud rate multiplier is 1

(- m) Interface mode: The valid software switchable protocol types are EIA-232, EIA-422, EIA-485 Full Duplex and EIA-485 Half Duplex. Each port on the UltraPort SI are independent of each other and therefore you may select different protocols per serial port.

(-x) Baud Rate multiplier: The baud rate multiplier allows the user to multiply the configured baud rate by 1, 2, 4, 8,16 or 32, hence achieving greater speeds on the UltraPort SI serial interfaces. This is applicable for each protocol type selected. Baud rates for EIA-232 are up to 921.6 Kbps per serial port. Baud rates for EIA-422/EIA-485 are up to 3.686 Mbps per serial port.

(-s) Slew Rate Limiting: The default setting for slew rate limiting is fast. This will allow higher baud rate speeds on each EIA interface port. Slew rate limiting enabled, minimizes EMI and reduces reflections caused by improperly terminated cables. Operation in slew rate limited mode reduces the amplitudes of high-frequency harmonics.

(-t) Line Termination: The line termination parameter is not changeable by the user in EIA-232 mode. However both EIA-422 and EIA-485 modes are defaulted to terminated but can be changed by the user if needed.

(-e) EIA-485 HDX Local Echo: Local echo by default is echoon. This parameter applies only to EIA-485 half duplex mode. All characters will be echoed to the user and transmitted across the serial ports. Some EIA-485 applications require local echo to be enable in order to monitor the loopback data to determine that line contention has occurred. If your application cannot handle loopback data the local echo should be set to echooff.

(-a) EIA-485 TX Driver Control: The default for this field is auto. When auto is set the UltraPort SI will automatically detect the beginning and the ending of data being transmitted in order to enable and disable the transmit line. When the field is set to rts it is the host application's responsibility to enable and disable the transmit line via the RTS handshake line when it wants to send data.

(-b) Auto EIA-485 Bit Delay: By default this field is set to 0 delay. This field is only applicable if you have configured EIA-485 TX Driver Control to auto. Values for this field are 0 through 15 bits.

(-h) Help: Displays the setultrap usage screen.

Note

The port must be closed and then opened for the new parameters to take effect.

The following examples show typical user applications:

```
etc/setultrap -f /dev/term/comf1a,/dev/term/comf1p -l -lists options configured for serial ports 1 through 16.
```

```
etc/setultrap -f /dev/term/comf1a,/dev/term/comf1p -m 422 -sets serial port 1 through 16 to interface type EIA-422
```

```
etc/setultrap -f /dev/term/comf1a,/dev/term/comf1d -m 485fdx -configures ports 1 to 4 to EIA-485 full duplex
```

```
etc/setultrap -f /dev/term/comf1a -m 485hdx -t term -b 5 -sets serial port comf1a to EIA-485 half duplex termination enabled, control bit-delay 5
```

The commands may be added to a startup script or put at the end of the /etc/inittab file, to cause them to run automatically whenever the system is started. A sample commented out startup script /etc/init.setultrap is supplied with this driver.

Removing drivers and utilities from your system

To remove the software drivers from your system under the Solaris operating system proceed as follows:

1. At the command prompt, type **pkgrm comf** and press **Enter**

The driver and associated utilities are now removed from your system.

Installing under Linux

This section tells you how to install host cards, software drivers and utilities under the Linux operating system and includes the following:

- [General installation procedure for Linux](#) on page [86](#)
- [Installing Drivers onto your system](#) on page [86](#)
- [Creating devices for the attached ports](#) on page [89](#)
- [UltraPort 8i and UltraPort81 Express RTS/DTR option](#) on page [90](#)
- [Setultrap Interface Protocol Configuration Utility \(UltraPort SI only\)](#) on page [90](#)

General installation procedure for Linux

The general procedure for installing and configuring host cards, driver software and associated utilities for the Linux operating system is as follows:

1. Install any UltraPort cards you require into your system. See [Installing host cards and cable accessories](#) on page [94](#).
2. Install the UltraPort Linux drivers onto your system using the procedures described in [Installing Drivers onto your system](#) on page [86](#).
3. Create devices for the required ports using the procedures detailed in [Creating devices for the attached ports](#) on page [89](#).

Your system can now use the UltraPort serial adaptor cards you have installed.

Installing Drivers onto your system

The UltraPort cards and UltraPort SI installed on Linux machines use the perle-serial driver for Linux. The driver supports the Linux kernel versions 2.2, 2.4 and 2.6. The kernel header files are needed for kernel 2.2 and 2.4. For the 2.6 kernel, a configuration kernel source tree and a set of makefile rules describing how the modules are built is required.

The UltraPort Express cards installed on Linux machines use the perle-serial driver for Linux. The driver supports the Linux kernel versions 2.4 and 2.6. The Kernel header files are needed for kernel 2.4. For the 2.6 kernel, a configuration kernel source tree and a set of makefile rules describing how the modules are build is required

The driver is supplied in both source RPM package format and a compressed tar file. The procedure for installation of each format is as follows:

Uninstall Patch Versions

The Perle-Serial driver version 2.0 and higher is a standalone kernel module. If previous patches have been made to the kernel for the UltraPort card, then these patches must be uninstalled before the new driver module can be installed.

1. Find the UltraPort patch files to the kernel. Remove the patches from the kernel source files by entering the following commands:

```
cd /usr/src/linux  
patch -R -p1 < <path to patches>/<patch file>
```

Note: If more than one patch file was added, then remove them in the reverse order that they were applied. (i.e. If the `ultraport.patch-x.y.z-2.4.x` was added and then the `ultraport.IO8mode-x.y.z-2.4.x` was added, remove the `ultraport.IO8mode` patch first.)

2. Recompile and install the kernel based on your specific system. For help on this procedure please refer to your LINUX documentation.
3. The new Perle-Serial software can now be installed

Install from Source RPM

1. Log in to the LINUX system as root user.

Notes:

The <packages directory> path name in the following instructions will be different depending on the LINUX distribution you have installed. (i.e. Redhat will have a "redhat" directory; Suse will have a "packages" directory)

The <rpm build command> will change depending on the version of the RPM utilities installed. For newer versions (i.e. 4.2) , the <rpm build command> is "rpmbuild". For older versions use "rpm".

2. At the LINUX prompt, copy the supplied perle-serial-<version>-<release>.src.rpm file onto your system in the **/tmp** directory.
3. Install the source rpm by typing the following command:
rpm -ivh perle-serial-<version>-<release>.src.rpm
4. Build the binary RPM package for your system by entering the following commands:
cd /usr/src/<packages directory>/SPECS
<rpm build command> -bb perle-serial-<version>.spec
5. Install the binary RPM which was just created. Enter the following commands:
cd /usr/src/<packages directory>/RPMS/<arch>
rpm -ivh perle-serial-<version>-<release>.<arch>.rpm

The <arch> value is the architecture of your LINUX machine such as "i386" or "alpha".

Install from Tar File

1. Log in to the LINUX system as root user.
2. At the LINUX prompt, copy the supplied perle-serial .tgz file onto your system in the **/tmp** directory.
3. Unpack the file using the command:
tar -xzvf perle-serial-<version>-<release>.tgz
4. Build and install the perle-serial software by entering the following commands
cd /tmp/perle-serial-<version>-<release>
./tar_install.sh

Creating devices for the attached ports

After the UltraPort cards and the new driver have been installed, terminal devices will need to be created for the added ports. This can be done by using the **ps_addports** utility.

To use the `ps_addports` script, enter the following command:

```
ps_addports m n
```

where:

m is the first port device (starting at 0)

n is the last port device to add.

The port devices will be created in the `/dev` directory and will have the following format:

```
/dev/ttyPSnn
```

where **nn** is the 2 digit port number.

The `perle-serial` driver has been installed so that it will automatically be loaded the first time an UltraPort device is used. However, if more than one UltraPort card has been installed in the Linux machine, then the driver can be manually loaded to determine which terminal device numbers have been assigned to each card.

To load the driver, enter the command:

```
modprobe perle-serial
```

Review the messages in the file `/var/log/messages`.

Once the port devices have been created, they may be used as standard LINUX serial TTYs.

UltraPort 8i and UltraPort81 Express RTS/DTR option

The Perle UltraPort8i and UltraPort81 Express can only support either RTS or DTR. There is a utility included with this driver to configure which signal will be active. The configuration is stored in the modules.conf file.

The utility is used as follows:

set_io8_rts off

This is the default action. The driver will use the pin as "DTR" when the tty is in software handshake mode.

set_io8_rts on

If this option is used or hardware handshake is on, the pin will always be RTS.

Note

The perle serial module will have to be unloaded and reloaded for the RTS/CTS option to take effect.

Setultrap Interface Protocol Configuration Utility (UltraPort SI only)

Perle provides a command line utility that allows the user to configure each UltraPort SI serial ports for features EIA-232, EIA-422, EIA-485 full duplex and EIA-485 half duplex.

Note

The default interface protocol for the Perle UltraPort SI cards is EIA-232.

Command Line Interface

```
setultrap -f device_name -l
setultrap -f device_name -x baud-multiplier
setultrap -f device_name -m 232 [-s fast|slow]
setultrap -f device_name -m 422 [-s fast|slow] [-t term|unterm]
setultrap -f device_name -m 485fdx [-s fast|slow] [-t term|unterm] [-a auto|rts] [-b 0-15]
setultrap -f device_name -m 485hdx [-s fast|slow] [-t term|unterm] [-e echoon|echooff]
[-a auto|rts] [-b 0-15]
-l list protocol configuration for serial device(s)
-x set baudrate multiplier for serial devices(s)
-m set interface protocol for serial device(s)
:
```

Option description	Configuration option	232	422	485hdx	485fdx
specifies the port to apply the configuration option to	-f	required	required	required	required
Lists the serial ports configuration	-l	optional	optional	optional	optional
Interface mode	-m	default 232	optional 422	optional 485hdx	optional 485fdx
Baud rate multiplier	-x	optional (1,2,4,8, 16,32)	optional (1,2,4,8, 16,32)	optional (1,2,4,8, 16,32)	optional (1,2,4,8, 16,32)
Slew rate limiting	-s	optional fast/slow	optional fast/slow	optional fast/slow	optional fast/slow
Line termination	-t	N/A	optional (term/ unterm)	optional (term/ unterm)	optional (term/ unterm)

Option description	Configuration option	232	422	485hdx	485fdx
EIA-485 HDX local echo	-e	N/A	N/A	optional echoon/ echoff	N/A
EIA-485 TX Driver Control	-a	N/A	N/A	optional (auto/rts)	optional (auto/rts)
Auto EIA-485 bit delay	-b	N/A	N/A	optional (0 -15)	optional (0 -15)

(-f) Specifies the port the action should be taken on.

/dev/ttyPS1 - specifies port 1

/dev/ttyPS1,/dev/ttyPS64 -specifies port 1 through port 64 (ranges are separated by a comma)

(-l) Lists protocol configuration for each serial port configured on the UltraPort SI.

/dev/ttyPS1 232 slow term 1

/dev/ttyPS1 485fdx fast term auto 5 1

The first example shows a device named ttyPS1 configured for protocol mode EIA-232, slew rate limiting is set to slow, termination is on, and the baud rate multiplier is 1

The second example shows device named ttyPS1 configured for protocol mode EIA-485fdx, slew rate limiting is set to fast, termination is on, EIA-485 HDX TX Driver Control is set to auto with bit delay of 5 bits and the baud rate multiplier is 1

(- m) Interface mode: The valid software switchable protocol types are EIA-232, EIA-422, EIA-485 Full Duplex and EIA-485 Half Duplex. Each port on the UltraPort SI are independent of each other and therefore you may select different protocols per serial port.

(-x) Baud Rate multiplier: The baud rate multiplier allows the user to multiply the configured baud rate by 1, 2, 4, 8,16 or 32, hence achieving greater speeds on the UltraPort SI serial interfaces. This is applicable for each protocol type selected. Baud rates for EIA-232 are up to 921.6 Kbps per serial port. Baud rates for EIA-422/EIA-485 are up to 3.686 Mbps per serial port.

(-s) Slew Rate Limiting: The default setting for slew rate limiting is disabled. This will allow higher baud rate speeds on each EIA interface port. Slew rate limiting enabled, minimizes EMI and reduces reflections caused by improperly terminated cables. Operation in slew rate limited mode reduces the amplitudes of high-frequency harmonics.

(-t) Line Termination: The line termination parameter is not changeable by the user in EIA-232 mode. However both EIA-422 and EIA-485 modes are defaulted to disabled but can be enabled by the user if needed.

(-e) EIA-485 HDX Local Echo: Local echo by default is on. This parameter applies only to EIA-485 half duplex mode. All characters will be echoed to the user and transmitted across the serial ports. Some EIA-485 applications require local echo to be enable in order to monitor the loopback data to determine that line contention has occurred. If your application cannot handle loopback data the local echo should be disabled.

(-a) EIA-485 TX Driver Control: The default for this field is AUTO. When Auto is set the UltraPort SI will automatically detect the beginning and the ending of data being transmitted in order to enable and disable the transmit line. When the field is set to RTS it is the host application's responsibility to enable and disable the transmit line via the RTS handshake line when it wants to send data.

(-b) Auto EIA-485 Bit Delay: By default this field is set to 0 delay. This field is only applicable if you have configured EIA-485 TX Driver Control to AUTO. Values for this field are 0 through 15 bits.

(-h) Help: Displays the setultrap usage screen.

Note

The port must be closed and then opened for the new parameters to take effect.

The following examples show typical user applications:

```
etc/setultrap -f /dev/ttyPS0,/dev/ttyPS15- l -lists options configured for serial ports 1 through 16
```

```
etc/setultrap -f /dev/ttyPS0,/dev/ttyPS15 -m 422 -sets serial port 1 through 16 to interface type EIA-422
```

```
etc/setultrap -f /dev/ttyPS0,/dev/ttyPS3 -m 485fdx -configures ports 1 to 4 to EIA-485 full duplex
```

```
etc/setultrap -f /dev/ttyPS1 -m 485hdx -t term -b 5 -sets serial port ttyPS1 to EIA-485 half duplex termination enabled, control bit-delay 5
```

These commands may be added to a startup script to cause them to run automatically whenever the system is started. A sample commented out startup script is (/etc/init.d/rc.setultrap) supplied with this driver.

Uninstalling the UltraPort Driver for Linux

To uninstall the driver enter the following command:

```
rpm -e perle-serial
```

Installing host cards and cable accessories

This section describes the mechanical installation of the UltraPort or UltraPort SI host cards and associated connector boxes and cables for 1,2, 4, 8 and 16 ports and includes the following:

- [Installing UltraPort, UltraPort SI, and UltraPort Express cards](#) on page **95**
- [Installing cables and connector boxes](#) on page **96**

Installing UltraPort, UltraPort SI, and UltraPort Express cards

This section describes the mechanical installation of UltraPort cards.

To install an UltraPort host card proceed as follows:

Note

The exact location of host card slots varies for different systems, for exact mechanical details of your system, refer to your system documentation.



Warning

Dangerous voltages exist inside computer systems. Before installing host cards in your system, turn off the power supply and unplug the power cord.

1. Turn off the power to your system and unplug the power cord.
2. Remove the system cover to expose the inside of the connector panel for host cards.
3. Insert the UltraPort card you want to install into a vacant host PCI /PCI Express card slot and secure in place as shown in the next picture.



Caution

Full anti-static precautions should be taken when handling host cards.

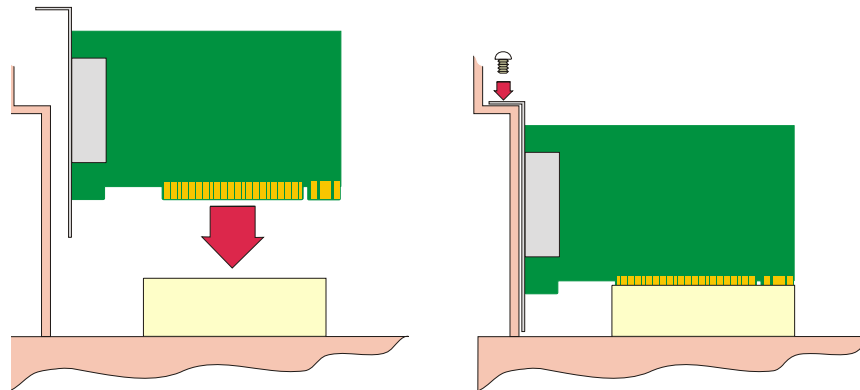

4. Repeat step 3. until you have installed all the UltraPort cards you want.
5. Replace and secure the system cover.

Installation of UltraPort cards is now complete.

Installing cables and connector boxes

This section describes the mechanical installation of cables and connector boxes to the UltraPort host cards for 1, 2, 4, 8 and 16 ports and includes the following:

- [Installing cables on UltraPort1, UltraPort1 SI, UltraPort1 Express, UltraPort2, and UltraPort2 SI cards](#) on page 97
- [Installing converter cables on UltraPort2 Express, UltraPort4, UltraPort4 Express, and UltraPort4 SI-RJ45 cards](#) on page 97
- [Installing converter cables on UltraPort8i, and UltraPort81 Express cards](#) on page 97
- [Installing fan-out cables and connector boxes on UltraPort4 SI-LP, UltraPort4 Express HD, UltraPort 8 SI, UltraPort8, and UltraPort8 Express HD cards](#) on page 98
- [Installing fan-out cables and connector boxes on UltraPort16 and UltraPort16 SI cards](#) on page 99

For information on available connectors and their pinouts and cabling, see [Chapter 3 Cabling information](#).

Installing cables on UltraPort1, UltraPort1 SI, UltraPort1 Express, UltraPort2, and UltraPort2 SI cards

The UltraPort1, UltraPort1 SI and the UltraPort1 Express have a single DB9 male connector on the back panel and UltraPort2 and UltraPort2 SI cards have two DB9 male connectors on the back panel. There is one for each serial port and they are labelled 1 to 2.

You can connect peripheral serial devices directly to the UltraPort2 *card by using standard RS-232 DB9 female connectors on the adapter side of the cable* you are using to connect the peripheral device.

Installing converter cables on UltraPort2 Express, UltraPort4, UltraPort4 Express, and UltraPort4 SI-RJ45 cards

UltraPort2 Express, UltraPort4, UltraPort4 Express and the UltraPort4 SI-RJ45 cards have two to four RJ45 10-pin connectors on the back panel. There is one for each serial port and they are labelled 1 to 4.

Converter cables with the proper connector on the opposite end can be plugged into these RJ45 connectors to provide the desired interface.

Installing converter cables on UltraPort8i, and UltraPort81 Express cards

UltraPort8i, and UltraPort81 Express cards have eight RJ12 6-pin connectors on the back panel. There is one for each serial port.

Converter cables with the proper connector on the opposite end can be plugged into these RJ12 connectors to provide the desired interface.

Installing fan-out cables and connector boxes on UltraPort4 SI-LP, UltraPort4 Express HD, UltraPort 8 SI, UltraPort8, and UltraPort8 Express HD cards

UltraPort4 Express HD, UltraPort4 SI-LP, UltraPort8 SI and UltraPort8, UltraPort8 Express HD cards have a single VHDCI-68 connector on the back panel. It provides the signals for 4 or 8 serial ports.

A fan-out cable or connector box with the proper individual connectors can be plugged into the card to provide the desired interface. The port numbers will be identified on the interface connectors or connector box.

Note

The UltraPort fan-out cables and connector boxes need to be secured or supported in case of sudden contact or excessive weight on the cables. Please ensure that adequate caution is taken to avoid possible damage to the UltraPort card or Host system. This can be accomplished by securing the cable(s) to a rack or to the back of the server as shown below:



Installing fan-out cables and connector boxes on UltraPort16 and UltraPort16 SI cards

UltraPort16 and UltraPort16 SI cards have two VHDCI-68 connectors on the back panel. Each one provides the signals for 8 serial ports, to provide a total of 16 ports. The connectors are labelled "1 - 8" and "9 - 16" on the back panel, to indicate the port numbers that are provided on each connector.

A fan-out cable or connector box with the proper individual connectors can be plugged into each connector on the card to provide the desired interface for 8 ports. The port numbers will be identified on the interface connectors or connector box.

Note

On an UltraPort16 and UltraPort16 SI card, the port numbers for ports on the connector labelled "9 - 16" will be 8 higher than the numbers given on the interface connectors of the fan-out cable or connector box.

Note

The UltraPort fan-out cables and connector boxes need to be secured or supported in case of sudden contact or excessive weight on the cables. Please ensure that adequate caution is taken to avoid possible damage to the UltraPort card or Host system. This can be accomplished by securing the cable(s) to a rack or to the back of the server as shown below:



Removing host cards

To remove an UltraPort card from your system, proceed as follows:

Note

The exact location of host card slots varies for different systems, for exact mechanical details of your system, refer to your system documentation.



Warning

Dangerous voltages exist inside computer systems. Before removing host cards from your system, turn off the power supply and unplug the power cord.

1. Turn off the power to your system and unplug the power cord.
2. Remove the system cover to expose the inside of the connector panel for host cards.
3. Disconnect any cables or connector boxes connected to the card you want to remove.
4. Undo the securing screw for the host card you want to remove then lift the card out of its slot as shown in the next picture.



Caution

Full anti-static precautions should be taken when handling host cards.

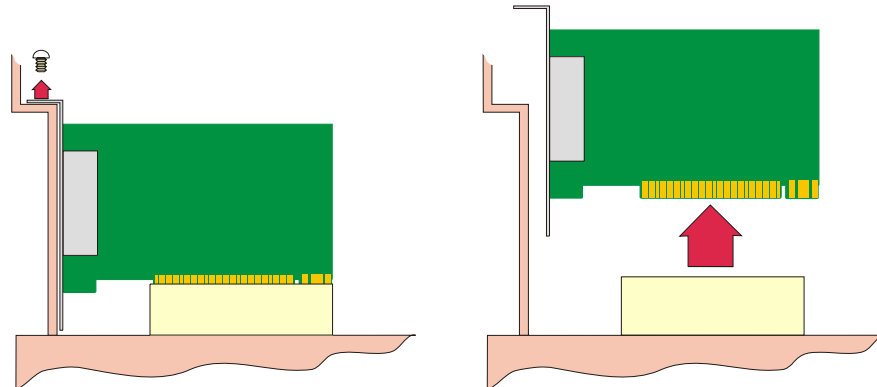

5. Repeat from step 3. until you have removed all the host cards you want.
6. Replace and secure the system cover.
7. Plug in the mains lead and turn on the power.

Removal of UltraPort card is now complete.

Chapter 3 Cabling information

You need to read this chapter if you want to...

You need to read this chapter if you want cabling information for the Perle UltraPort and UltraPort SI and UltraPort Express serial adaptor cards.

This chapter provides cabling and connector pinout information for the Perle UltraPort serial adaptor cards. Included are details of standard cables for use with UltraPort, UltraPort SI and UltraPort Express products available from Perle.

This chapter includes the following sections:

- [Definitions of Signals and Direction](#) on page **102**
- [Host card back panel connectors and pinouts](#) on page **103**
- [Connector box and cable guide](#) on page **115**
- [Connector box and cable pinouts](#) on page **117**

Definitions of Signals and Direction

EIA-232	EIA-422	EIA-485	Direction	Description
RI			In	Ring Indicator
DCD			In	Data Carrier Detect
RTS			Out	Request To Send
	RTS+		Out	Request to Send
	RTS-		Out	Request to Send
DSR			In	Data Set Ready
TXD			Out	Transmit Data
	TXD+		Out	Transmit Data
	TXD-		Out	Transmit Data
		TXD-/RXD-	In/Out	Transmit/Receive Data
		TXD+/RXD+	In/Out	Transmit/Receive Data
RXD			In	Receive Data
	RXD+	RXD+	In	Receive Data
	RXD-	RXD-	In	Receive Data
S-GND	S-GND	S-GND		Signal Ground
CTS			In	Clear to Send
	CTS+		In	Clear to Send
	CTS-		In	Clear to Send
DTR			Out	Data Terminal Ready
C-GND	C-GND	C-GND		Chassis Ground

Note

Only the UltraPort SI series of cards supports EIA-422 and EIA-485 interface modes.

Host card back panel connectors and pinouts

This section contains diagrams and pinout information for the UltraPort host card back panel connectors contains the following:

[DB9 back panel connectors and pinout](#) on page **104**

[RJ45 back panel connectors and pinout](#) on page **105**

[UltraPort4 SI-RJ45 Switches](#) on page **106**

[VHDCI-68 Ultra SCSI back panel connectors and pinout](#) on page **108**

DB9 back panel connectors and pinout

The following diagram shows the UltraPort2/UltraPort2 SI, UltraPort 1/UltraPort1 SI, the UltraPort1 SI Low Profile and UltraPort1 Expressback panels respectively.

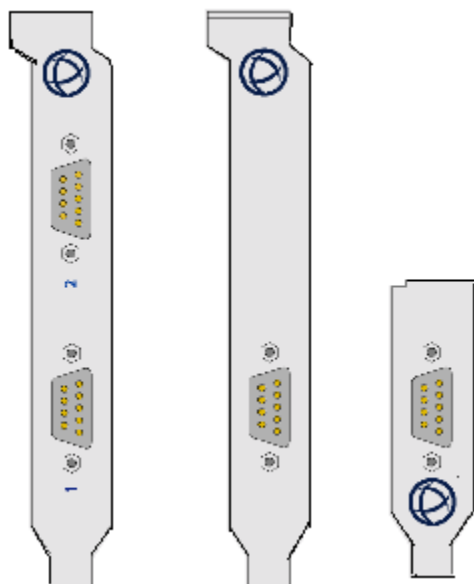

DB9M pin	EIA-232	EIA-422	EIA-485
1	DCD	CTS-	NC
2	RXD	RXD+	RXD+
3	TXD	TXD-	TXD-/RXD-
4	DTR	TXD+	TXD+/RXD+
5	S-GND	S-GND	S-GND
6	DSR	RXD-	RXD-
7	RTS	RTS-	NC
8	CTS	CTS+	NC
9	RI	RTS+	NC
Shell	C-GND	C-GND	C-GND

RJ45 back panel connectors and pinout

The following diagram shows the UltraPort2 Express, UltraPort4/UltraPort4 SI RJ-45 and UltraPort4 Express cards back panel.

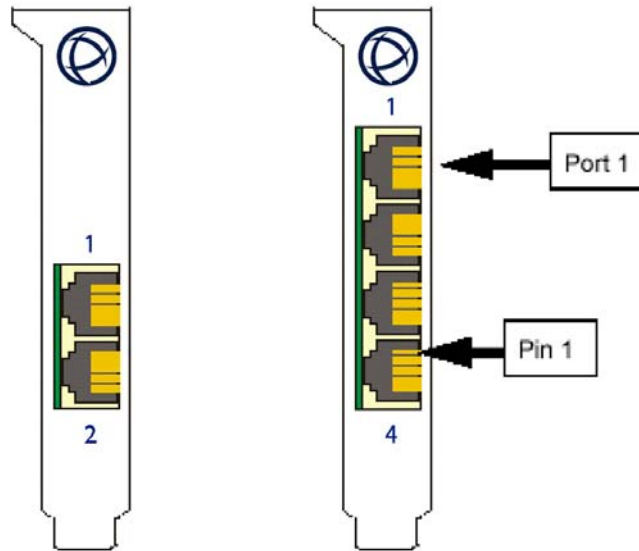

The connector pinout for each RJ45 socket fitted to the UltraPort2 Express, UltraPort4, UltraPort4 SI, and UltraPort4 Express cards are as follows:

RJ45 10-pin	RJ45 8-pin	EIA-232	EIA-422	EIA-485
1	N/A	RI	RTS+	
2	1	DCD	CTS-	NC
3	2	RTS	RTS-	NC
4	3	DSR	RXD-	RXD-
5	4	TXD	TXD-	TXD-/RXD-
6	5	RXD	RXD+	RXD+
7	6	S-GND	S-GND	S-GND
8	7	CTS	CTS+	NC
9	8	DTR	TXD+	TXD+/RXD+
10	N/A			
Shell	Shell	C-GND	C-GND	C-GND

UltraPort4 SI-RJ45 Switches

The UltraPort 4 SI-RJ45 card has 4 switches (one for each port) which can be found next to each serial RJ-45 connector. These switches allow the user to switch between Perle's, Digi's, or Digi ALTPIN EIA-232 pin-out assignments for the RJ-45 connectors. Please see the table below for the meaning of each switch position

Switch	Position 1	Position 1	Position 2	Position 2	Position 3	Position 3
EIA-232 Signals	RJ45 10-pin Perle	RJ45 8-pin Perle	RJ45 10-pin Digi	RJ45 8-pin Digi	RJ45 10-pin Digi ALTPIN	RJ45 8-pin Digi ALTPIN
RI	1	N/A	1	N/A	1	N/A
DCD	2	1	10	N/A	2	1
RTS	3	2	3	2	3	2
DSR	4	3	2	1	10	N/A
TXD	5	4	5	4	5	4
RXD	6	5	6	5	6	5
S-GND	7	6	7	6	7	6
CTS	8	7	8	7	8	7
DTR	9	8	9	8	9	8
	10	N/A	N/C	N/A	N/C	N/A
C-GND	Shell	Shell	4 & Shell	3 & Shell	4 & Shell	3 & Shell

RJ12 back panel connectors and pinout

The following diagram shows the UltraPort8i card and UltraPort81 Express back panel:

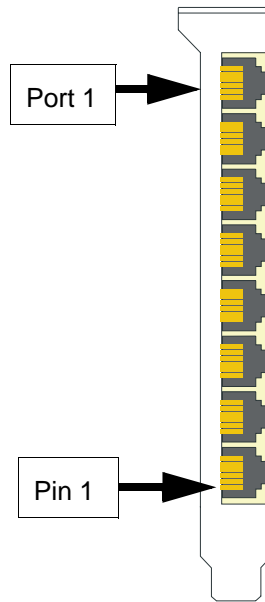

The connector pinout for each RJ12 socket fitted to the UltraPort8i and UltraPort81 Express card is as follows:

RJ12 pin	EIA-232
1	DCD
2	RXD
3	DTR or RTS
4	S-GND
5	TXD
6	CTS
Shell	C-GND

VHDCI-68 Ultra SCSI back panel connectors and pinout

The following diagram shows the UltraPort4/UltraPort4 SI and UltraPort4/UltraPort4 SI Low Profile and UltraPort4 Express HD back panels respectively.

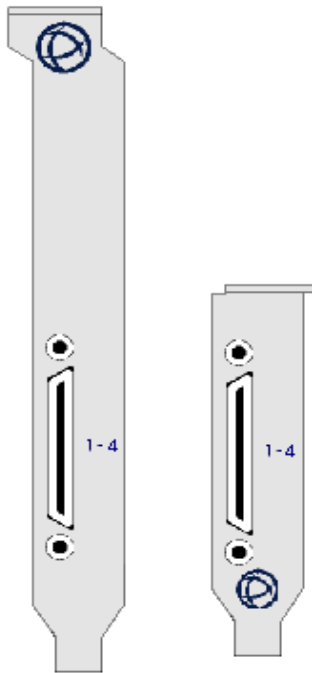

Note

The UltraPort fan-out cables need to be secured or supported in case of sudden contact or excessive weight on the cables. Please ensure that adequate caution is taken to avoid possible damage to the UltraPort card or Host system. This can be accomplished by securing the cables to a rack or to the back of the server.

The connector pinout for each VHDCI-68 Ultra SCSI connector fitted to the UltraPort4, UltraPort4 SI, and UltraPort4 Express HD is as follows:

VHDCI-68 Ultra SCSI Pin Number	EIA-232	EIA-422	EIA-485
1	RXD4	RXD4+	RXD4+
2	CTS4	CTS4+	NC

VHDCI-68 Ultra SCSI Pin Number	EIA-232	EIA-422	EIA-485
3	RI4	RTS4+	NC
4	RTS4	RTS4-	NC
5	DCD4	CTS4-	NC
6	DTR4	TXD4+	TXD4+/RXD4+
7	DSR4	RXD4-	RXD4-
8	TXD4	TXD4-	TXD4-/RXD4-
9	S-GND	S-GND	S-GND
10	TXD3	TXD3-	TXD3-/RXD3-
11	DSR3	RXD3-	RXD3-
12	DTR3	TXD3+	TXD3+/RXD3+
13	DCD3	CTS3-	NC
14	RTS3	RTS3-	NC
15	RI3	RTS3+	NC
16	CTS3	CTS3+	NC
17	RXD3	RXD3+	RXD3+
18	RXD2	RXD2+	RXD2+
19	CTS2	CTS2+	NC
20	RI2	RTS2+	NC
21	RTS2	RTS2-	NC
22	DCD2	CTS2-	NC
23	DTR2	TXD2+	TXD2+/RXD2+
24	DSR2	RXD2-	RXD2-
25	TXD2	TXD2-	TXD2-/RXD2-
26	S-GND	S-GND	S-GND
27	TXD1	TXD1-	TXD1-/RXD1-
28	DSR1	RXD1-	RXD1-
29	DTR1	TXD1+	TXD1+/RXD1+
30	DCD1	CTS1-	NC
31	RTS1	RTS1-	NC
32	RI1	RTS1+	NC
33	CTS1	CTS1+	NC

VHDCI-68 Ultra SCSI Pin Number	EIA-232	EIA-422	EIA-485
34	RXD1	RXD1+	RXD1+
35-42	NC	NC	NC
43	S-GND	S-GND	S-GND
44-59	NC	NC	NC
60	S-GND	S-GND	S-GND
61-68	NC	NC	NC

The following diagram shows the UltraPort8 (old standard height PCI PCB board), UltraPort16/UltraPort16 SI, UltraPort8/UltraPort8 SI, and UltraPort8 Express Low profile back panels respectively

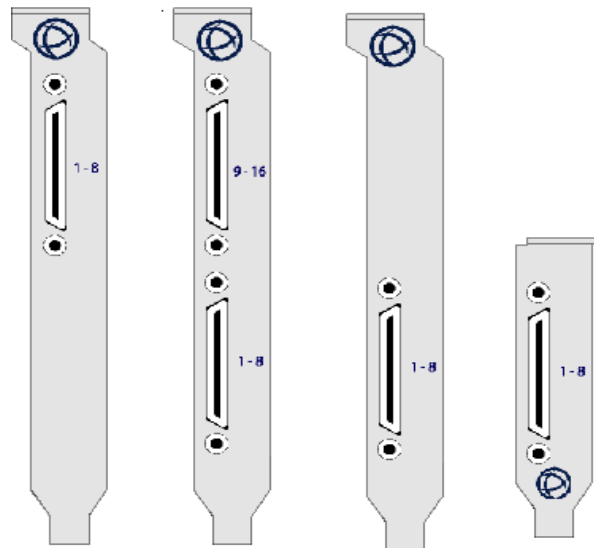

Note

The UltraPort fan-out cables need to be secured or supported in case of sudden contact or excessive weight on the cables. Please ensure that adequate caution is taken to avoid possible damage to the UltraPort card or Host system. This can be accomplished by securing the cables to a rack or to the back of the server.

The connector pinout for each VHDCI-68 Ultra SCSI connector fitted to the UltraPort8 (old standard height PCI PCB board), UltraPort16/UltraPort16 SI, UltraPort8/UltraPort8 SI, and UltraPort8 Express HD Low profile are as follows:

Ports 1-8 of VHDCI-68 Connector for UltraPort8, UltraPort8 SI, UltraPort8 Express HD, UltraPort16, and UltraPort16 SI adapter cards

VHDCI-68 Ultra SCSI Pin Number	EIA-232	EIA-422	EIA-485
1	RXD7	RXD7+	RXD7+
2	CTS7	CTS7+	NC
3	RI7	RTS7+	NC
4	RTS7	RTS7-	NC
5	DCD7	CTS7-	NC
6	DTR7	TXD7+	TXD7+/RXD7+
7	DSR7	RXD7-	RXD7-
8	TXD7	TXD7-	TXD7-/RXD7-
9	S-GND	S-GND	S-GND
10	TXD5	TXD5-	TXD5-/RXD5-
11	DSR5	RXD5-	RXD5-
12	DTR5	TXD5+	TXD5+/RXD5+
13	DCD5	CTS5-	NC
14	RTS5	RTS5-	NC
15	RI5	RTS5+	NC
16	CTS5	CTS5+	NC
17	RXD5	RXD5+	RXD5+
18	RXD3	RXD3+	RXD3+
19	CTS3	CTS3+	NC
20	RI3	RTS3+	NC
21	RTS3	RTS3-	NC
22	DCD3	CTS3-	NC
23	DTR3	TXD3+	TXD3+/RXD3+
24	DSR3	RXD3-	RXD3-
25	TXD3	TXD3-	TXD3-/RXD3-
26	S-GND	S-GND	S-GND
27	TXD1	TXD1-	TXD1-/RXD1-

VHDCI-68 Ultra SCSI Pin Number	EIA-232	EIA-422	EIA-485
28	DSR1	RXD1-	RXD1-
29	DTR1	TXD1+	TXD1+/RXD1+
30	DCD1	CTS1-	NC
31	RTS1	RTS1-	NC
32	RI1	RTS1+	NC
33	CTS1	CTS1+	NC
34	RXD1	RXD1+	RXD1+
35	RXD8	RXD8+	RXD8+
36	CTS8	CTS8+	NC
37	RI8	RTS8+	NC
38	RTS8	RTS8-	NC
39	DCD8	CTS8-	NC
40	DTR8	TXD8+	TXD8+/RXD8+
41	DSR8	RXD8-	RXD8-
42	TXD8	TXD8-	TXD8-/RXD8-
43	S-GND	S-GND	S-GND
44	TXD6	TXD6-	TXD6-/RXD6-
45	DSR6	RXD6-	RXD6-
46	DTR6	TXD6+	TXD6+/RXD6+
47	DCD6	CTS6-	NC
48	RTS6	RTS6-	NC
49	RI6	RTS6+	NC
50	CTS6	CTS6+	NC
51	RXD6	RXD6+	RXD6+
52	RXD4	RXD4+	RXD4+
53	CTS4	CTS4+	NC
54	RI4	RTS4+	NC
55	RTS4	RTS4-	NC
56	DCD4	CTS4-	NC
57	DTR4	TXD4+	TXD4+/RXD4+
58	DSR4	RXD4-	RXD4-

VHDCI-68 Ultra SCSI Pin Number	EIA-232	EIA-422	EIA-485
59	TXD4	TXD4-	TXD4-/RXD4-
60	S-GND	S-GND	S-GND
61	TXD2	TXD2-	TXD2-/RXD2-
62	DSR2	RXD2-	RXD2-
63	DTR2	TXD2+	TXD2+/RXD2+
64	DCD2	CTS2-	NC
65	RTS2	RTS2-	NC
66	RI2	RTS2+	NC
67	CTS2	CTS2+	NC
68	RXD2	RXD2+	RXD2+

Ports 9-16 of second VHDCI-68 Connector for UltraPort16 and UltraPort16 SI cards

VHDCI-68 Ultra SCSI Pin Number	EIA-232	EIA-422	EIA-485
1	RXD15	RXD15+	RXD15+
2	CTS15	CTS15+	NC
3	RI15	RTS15+	NC
4	RTS15	RTS15-	NC
5	DCD15	CTS15-	NC
6	DTR15	TXD15+	TXD15+/RXD15+
7	DSR15	RXD15-	RXD15-
8	TXD15	TXD15-	TXD15-/RXD15-
9	S-GND	S-GND	S-GND
10	TXD13	TXD13-	TXD13-/RXD13-
11	DSR13	RXD13-	RXD13-
12	DTR13	TXD13+	TXD13+/RXD13+
13	DCD13	CTS13-	NC
14	RTS13	RTS13-	NC
15	RI13	RTS13+	NC
16	CTS13	CTS13+	NC

VHDCI-68 Ultra SCSI Pin Number	EIA-232	EIA-422	EIA-485
17	RXD13	RXD13+	RXD13+
18	RXD11	RXD11+	RXD11+
19	CTS11	CTS11+	NC
20	RI11	RTS11+	NC
21	RTS11	RTS11-	NC
22	DCD11	CTS11-	NC
23	DTR11	TXD11+	TXD11+/RXD11+
24	DSR11	RXD11-	RXD11-
25	TXD11	TXD11-	TXD11-/RXD11-
26	S-GND	S-GND	S-GND
27	TXD9	TXD9-	TXD9-/RXD9-
28	DSR9	RXD9-	RXD9-
29	DTR9	TXD9+	TXD9+/RXD9+
30	DCD9	CTS9-	NC
31	RTS9	RTS9-	NC
32	RI9	RTS9+	NC
33	CTS9	CTS9+	NC
34	RXD9	RXD9+	RXD9+
35	RXD16	RXD16+	RXD16+
36	CTS16	CTS16+	NC
37	RI16	RTS16+	NC
38	RTS16	RTS16-	NC
39	DCD16	CTS16-	NC
40	DTR16	TXD16+	TXD16+/RXD16+
41	DSR16	RXD16-	RXD16-
42	TXD16	TXD16-	TXD16-/RXD16-
43	S-GND	S-GND	S-GND
44	TXD14	TXD14-	TXD14-/RXD14-
45	DSR14	RXD14-	RXD14-
46	DTR14	TXD14+	TXD14+/RXD14+
47	DCD14	CTS14-	NC

VHDCI-68 Ultra SCSI Pin Number	EIA-232	EIA-422	EIA-485
48	RTS14	RTS14-	NC
49	RI14	RTS14+	NC
50	CTS14	CTS14+	NC
51	RXD14	RXD14+	RXD14+
52	RXD12	RXD12+	RXD12+
53	CTS12	CTS12+	NC
54	RI12	RTS12+	NC
55	RTS12	RTS12-	NC
56	DCD12	CTS12-	NC
57	DTR12	TXD12+	TXD12+/RXD12+
58	DSR12	RXD12-	RXD12-
59	TXD12	TXD12-	TXD12-/RXD12-
60	S-GND	S-GND	S-GND
61	TXD10	TXD10-	TXD10-/RXD10-
62	DSR10	RXD10-	RXD10-
63	DTR10	TXD10+	TXD10+/RXD10+
64	DCD10	CTS10-	NC
65	RTS10	RTS10-	NC
66	RI10	RTS10+	NC
67	CTS10	CTS10+	NC
68	RXD10	RXD10+	RXD10+

Connector box and cable guide

The connector pinout information for the UltraPort product you are using depends on the number of ports and type of connector box or cable used as detailed in the next table:

Product	Card edge connector	Cable or connector box options	For connector pinouts see...
UltraPort2 Express	RJ45 10-pin	RJ45 - DB25M Converter	See page 118
UltraPort4		RJ45 - DB25F Converter	See page 118

Product	Card edge connector	Cable or connector box options	For connector pinouts see...
UltraPort4 Express		RJ45 - DB9M Converter	See page 119
UltraPort4 SI		RJ45 - DB9F Converter	See page 119
UltraPort4 Express HD		RJ45 - Speed Converter	See page 120
		RJ45 - Digi Converter	See page 121
		RJ45 - Digi ALTPIN Converter	See page 122
UltraPort 4 SI UltraPort8 Express HD UltraPort 8 UltraPort8 Express HD UltraPort16, UltraPort16 SI	VHDCI-68	RJ45 Connector Box	See page 123
		DB25M Connector Box	See page 124
		DB25F Connector Box	See page 124
		DB9M Connector Box	See page 125
		DB25M Fan-out Cable	See page 126
		DB25F Fan-out Cable	See page 126
		DB9M Fan-out Cable	See page 127
		DB9F Fan-out Cable	See page 127

Connector box and cable pinouts

This section contains pinout information for the UltraPort product range connector box and cable accessories and contains the following:

- [RJ45 10-pin to DB25 converter](#) on page [118](#)
- [RJ45 10-pin to DB9 converter](#) on page [119](#)
- [RJ45 10-pin to RJ45 SPEED converter](#) on page [120](#)
- [RJ45 10-pin to RJ45 Digi converter](#) on page [121](#)
- [RJ45 10-pin to RJ45 ALTPIN converter](#) on page [122](#)
- [RJ45 connector box](#) on page [123](#)
- [DB25 connector box](#) on page [124](#)
- [DB9 connector box](#) on page [125](#)
- [DB25 Fan-out cable](#) on page [126](#)
- [DB9 Fan-out cable](#) on page [127](#)

Note

For details of which cables to use with which product, see [Connector box and cable guide](#) on page [115](#).

RJ45 10-pin to DB25 converter

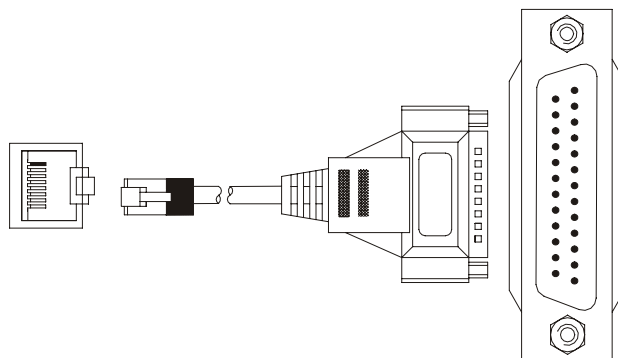

RJ45 pin	DB25 Pin	EIA-232	EIA-422	EIA-485
1	22	RI	RTS+	NC
2	8	DCD	CTS-	NC
3	4	RTS	RTS-	NC
4	6	DSR	RXD-	RXD-
5	2	TXD	TXD-	TXD-/RXD-
6	3	RXD	RXD+	RXD+
7	7	S-GND	S-GND	S-GND
8	5	CTS	CTS+	NC
9	20	DTR	TXD+	TXD+/RXD+
10	N/C			
1 & Shell	1 & Shell	C-GND	C-GND	C-GNDI

RJ45 10-pin to DB9 converter

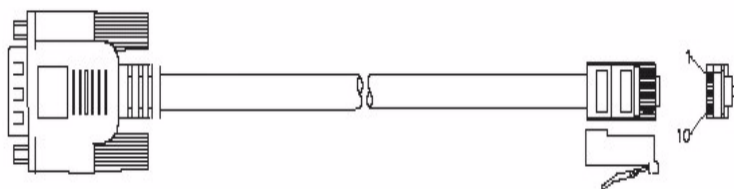

RJ45 pin	DB9 Pin	EIA-232	EIA-422	EIA-485
1	9	RI	RTS+	NC
2	1	DCD	CTS-	NC
3	7	RTS	RTS-	NC
4	6	DSR	RXD-	RXD-
5	3	TXD	TXD-	TXD-/RXD-
6	2	RXD	RXD+	RXD+
7	5	S-GND	S-GND	S-GND
8	8	CTS	CTS+	NC
9	4	DTR	TXD+	TXD+/RXD+
10	N/C			
Shell	Shell	C-GND	C-GND	C-GND

RJ45 10-pin to RJ45 SPEED converter

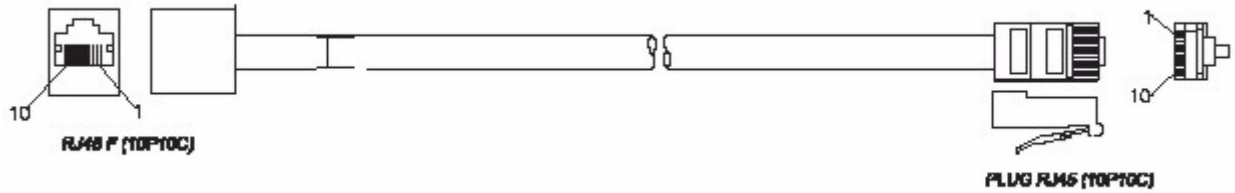

RJ45 10-pin to card	RJ45 10-pin SPEED	RJ45 8-pin SPEED	EIA-232
1	1	N/A	RI
2	2	1	DCD
3	8	7	RTS
4	4	3	DSR
5	6	5	TXD
6	7	6	RXD
7	5	4	S-GND
8	9	8	CTS
9	3	2	DTR
10	10	N/A	
Shell	Shell	Shell	C-GND

RJ45 10-pin to RJ45 Digi converter

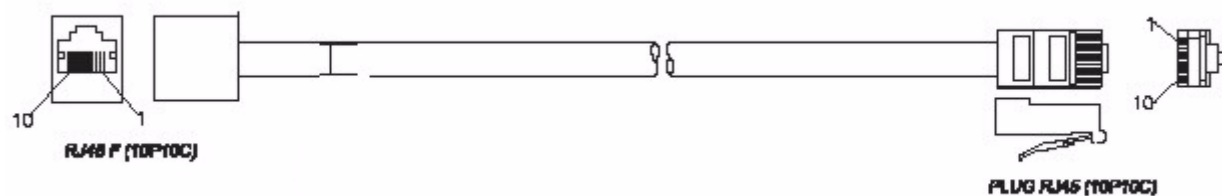

RJ45 10-pin to card	RJ45 10-pin Digi	RJ45 8-pin Digi	EIA-232
1	1	N/A	RI
2	10	N/A	DCD
3	3	2	RTS
4	2	1	DSR
5	5	4	TXD
6	6	5	RXD
7	7	6	S-GND
8	8	7	CTS
9	9	8	DTR
10	N/C	N/A	
Shell	4 & Shell	3 & Shell	C-GND

RJ45 10-pin to RJ45 Digi ALTPIN converter

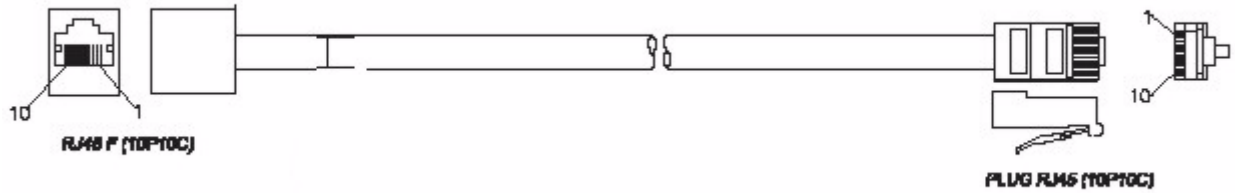

RJ45 10-pin to card	RJ45 10-pin Digi ALTPIN	RJ45 8-pin Digi ALTPIN	EIA-232
1	1	N/A	RI
2	2	1	DCD
3	3	2	RTS
4	10	N/A	DSR
5	5	4	TXD
6	6	5	RXD
7	7	6	S-GND
8	8	7	CTS
9	9	8	DTR
10	N/C	N/A	
Shell	4 & Shell	3 & Shell	C-GND

RJ45 connector box

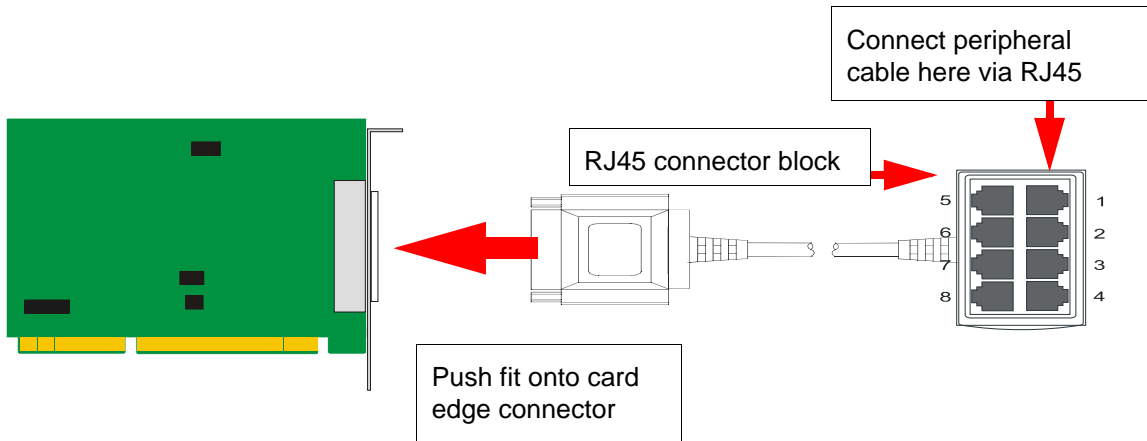

Note

The UltraPort connector box cable needs to be secured or supported in case of sudden contact or excessive weight on the cables. Please ensure that adequate caution is taken to avoid possible damage to the UltraPort card or Host system. This can be accomplished by securing the cable to a rack or to the back of the server.

RJ45 10-pin	RJ45 8-pin	EIA-232	EIA-485	EIA-485
1	N/A	RI	NC	NC
2	1	DCD	NC	NC
3	2	RTS	NC	NC
4	3	DSR	RXD-	RXD-
5	4	TXD	TXD-/RXD-	TXD-/RXD-
6	5	RXD	RXD+	RXD+
7	6	S-GND	S-GND	S-GND
8	7	CTS	NC	NC
9	8	DTR	TXD+/RXD+	TXD+/RXD+
10	N/A	NC	NC	NC
Shell	Shell	C-GND	C-GND	C-GND

DB25 connector box

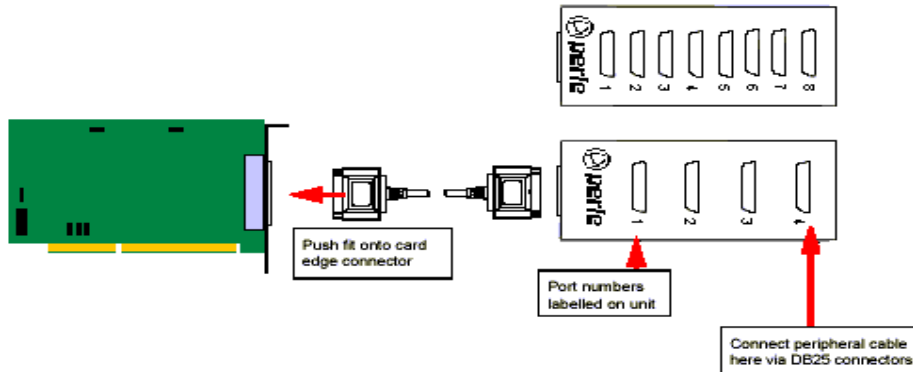

Note

The UltraPort connector box cable needs to be secured or supported in case of sudden contact or excessive weight on the cables. Please ensure that adequate caution is taken to avoid possible damage to the UltraPort card or Host system. This can be accomplished by securing the cable to a rack or to the back of the server.

DB25 Pin	EIA-232	EIA-422	EIA-485
1 & Shell	C-GND	C-GND	C-GND
2	TXD	TXD-	TXD-/RXD-
3	RXD	RXD+	RXD+
4	RTS	RTS-	NC
5	CTS	CTS+	NC
6	DSR	RXD-	RXD-
7	S-GND	S-GND	S-GND
8	DCD	CTS-	NC
20	DTR	TXD+	TXD+/RXD+
22	RI	RTS+	NC

DB9 connector box

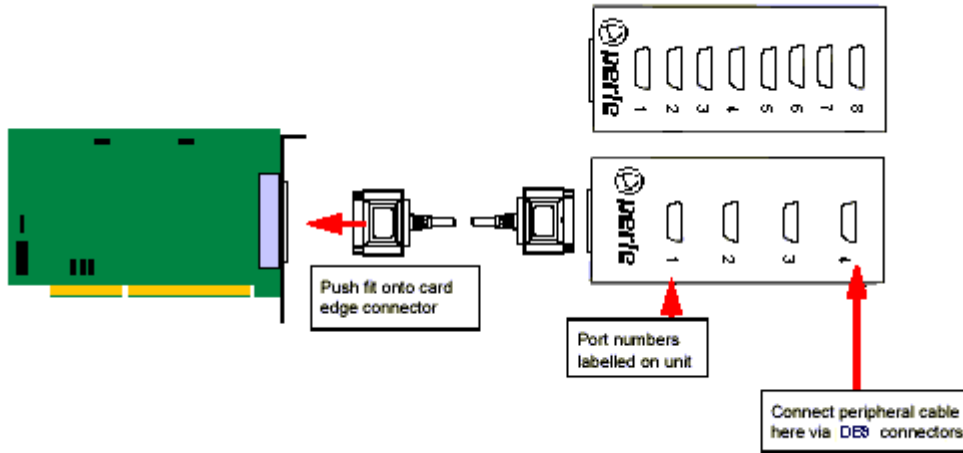

Note

The UltraPort connector box cable needs to be secured or supported in case of sudden contact or excessive weight on the cables. Please ensure that adequate caution is taken to avoid possible damage to the UltraPort card or Host system. This can be accomplished by securing the cable to a rack or to the back of the server.

DB9 Pin	EIA-232	EIA-422	EIA-485
1	DCD	CTS-	NC
2	RXD	RXD+	RXD+
3	TXD	TXD-	TXD-/RXD-
4	DTR	TXD+	TXD+/RXD+
5	S-GND	S-GND	S-GND
6	DSR	RXD-	RXD-
7	RTS	RTS-	NC
8	CTS	CTS+	NC
9	RI	RTS+	NC
Shell	C-GND	C-GND	C-GND

DB25 Fan-out cable

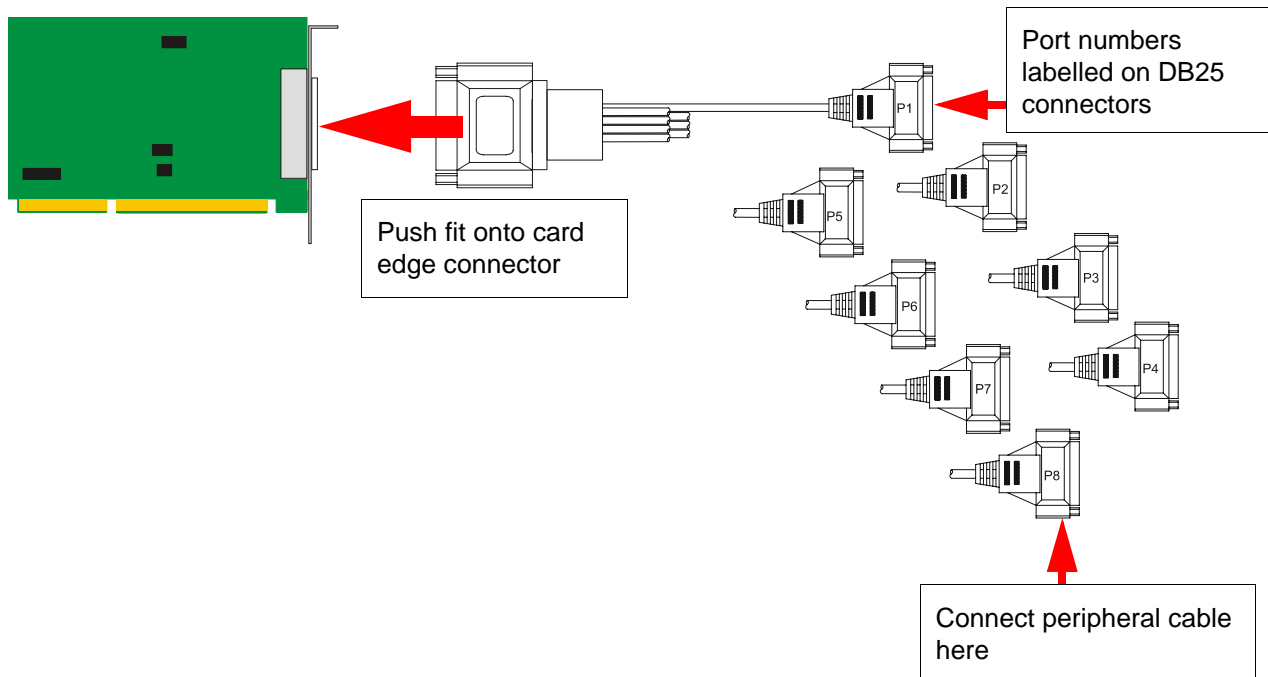

Note

The UltraPort fan-out cables need to be secured or supported in case of sudden contact or excessive weight on the cables. Please ensure that adequate caution is taken to avoid possible damage to the UltraPort card or Host system. This can be accomplished by securing the cables to a rack or to the back of the server.

DB25 Pin	EIA-232	EIA-422	EIA-485
1 & Shell	C-GND	C-GND	C-GND
2	TXD	TXD-	TXD-/RXD-
3	RXD	RXD+	RXD+
4	RTS	RTS-	NC
5	CTS	CTS+	NC
6	DSR	RXD-	RXD-
7	S-GND	S-GND	S-GND
8	DCD	CTS-	NC
20	DTR	TXD+	TXD+/RXD+
22	RI	RTS+	NC

DB9 Fan-out cable

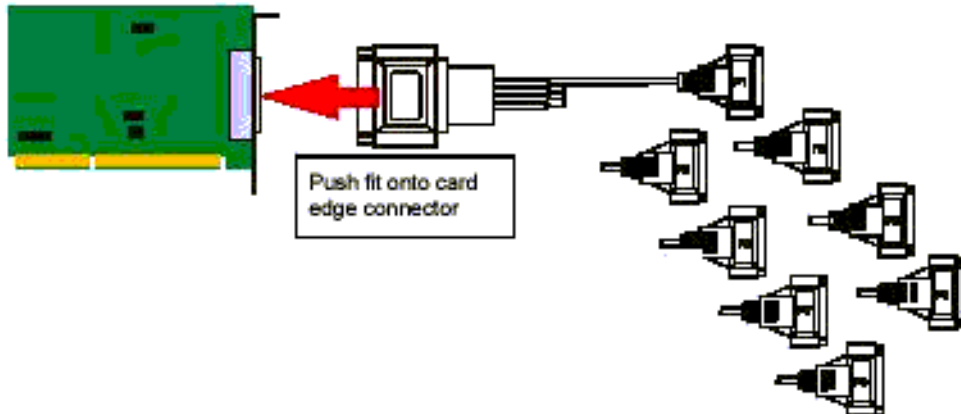

Note

The UltraPort fan-out cables need to be secured or supported in case of sudden contact or excessive weight on the cables. Please ensure that adequate caution is taken to avoid possible damage to the UltraPort card or Host system. This can be accomplished by securing the cables to a rack or to the back of the server.

DB9 Pin	EIA-232	EIA-422	EIA-485
1	DCD	CTS-	NC
2	RXD	RXD+	RXD+
3	TXD	TXD-	TXD-/RXD-
4	DTR	TXD+	TXD+/RXD+
5	S-GND	S-GND	S-GND
6	DSR	RXD-	RXD-
7	RTS	RTS-	NC
8	CTS	CTS+	NC
9	RI	RTS+	NC
Shell	C-GND	C-GND	C-GND

Appendix A : Transparent printing

You need to read this appendix if you want to... You need to read this appendix if you want background information on transparent printing.

This appendix gives an overview of the transparent printing feature offered for the OpenServer and Unixware operating systems. Included are details of configuration files associated with transparent printing.

This appendix includes the following sections:

- [What is transparent printing?](#) on page **129**
- [Problems with printer output](#) on page **130**
- [The printcap.spd configuration file](#) on page **130**
- [The print.spd configuration file](#) on page **131**

What is transparent printing?

Most terminals have an auxiliary (AUX) port which can be connected to a serial printer. Data can then be output to the terminal or the printer via the same serial line. This is called **transparent print** (or xprint) and is designed for printing simple ASCII text. A separate xprint device node (`ttyzn` where `n` is device number) is created for each port. This device is enabled automatically if either the local or modem device is enabled for the port.

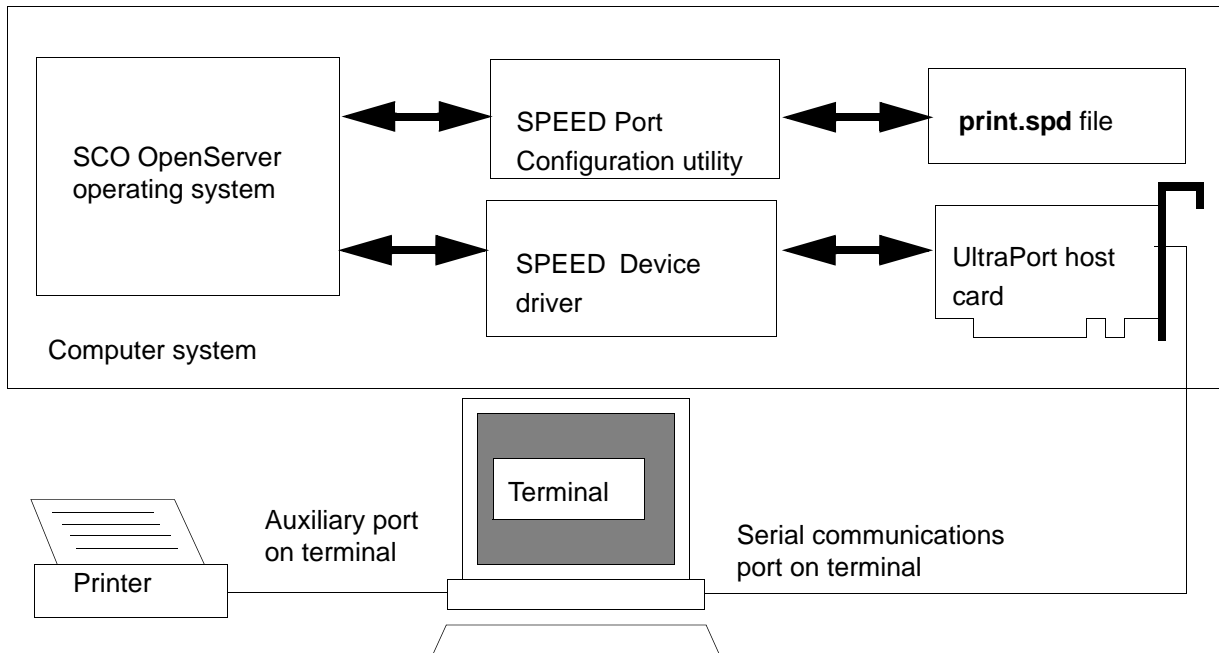

When a host card receives data addressed to the transparent print device it prefixes it with the transparent print mode ON string and appends it with the transparent mode OFF string. The ON and OFF strings for each terminal type available are defined by the `printcap.spd` file. See [The `printcap.spd` configuration file](#) on page 130 for more details.

When the host card receives data addressed to the transparent print device, it prefixes it with the Transparent Print Mode ON string and appends it with the Transparent Print Mode OFF string. Terminal I/O has absolute priority over printer output. Transparent print data will only be sent when there is a break in output to the terminal (for more than a tenth of a second)

For each port, the transparent printing parameters are controlled by an entry in the `print.spd` file found in the `/etc/` directory on your system. The entry for each port includes definitions of the terminal type, transparent print throughput rate and device name. See [The `print.spd` configuration file](#) on page 131 for further details.

Problems with printer output

When you use transparent printing you may obtain incorrect printer output due to the following reasons:

Graphics printers may misinterpret some characters output through transparent print. This problem is more likely if the terminal is in 7-bit mode, because 8-bit characters will not be printed.

Some terminals suppress the output of certain characters to their printer or AUX ports. Such terminals can prevent essential control characters from reaching the printer thus generating incorrect printer output. This occurrence is extremely unpredictable because of the large number of potential hardware configurations.

The `printcap.spd` configuration file

The `printcap.spd` file defines the transparent print ON and OFF strings for each terminal type available. When a host card receives data addressed to the transparent print device it prefixes it with the transparent print mode ON string and appends it with the transparent mode OFF string.

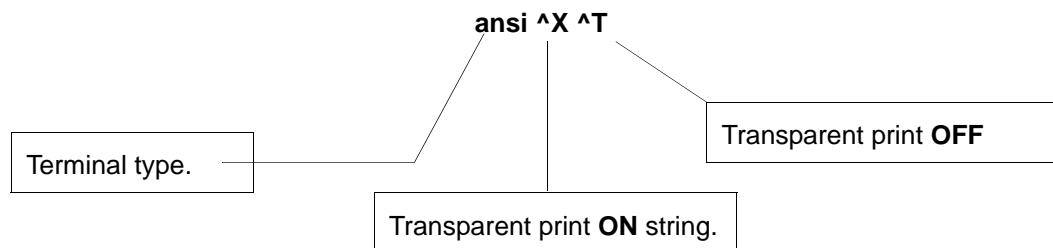

If you don't configure a specific terminal type `printcap.spd` will use the default type which is "unknown"

The print.spd configuration file

For each port, transparent printing is controlled by an entry in the **print.spd** file. The **print.spd** file is found in the /etc/ directory on your system. The entry for each port includes definitions of the terminal type, transparent print throughput rate, device name. The content of the **print.spd** file is normally controlled automatically by either the Port Configuration utility (SCO OpenServer). A sample entry from a typical print.spd file is shown in the next example.

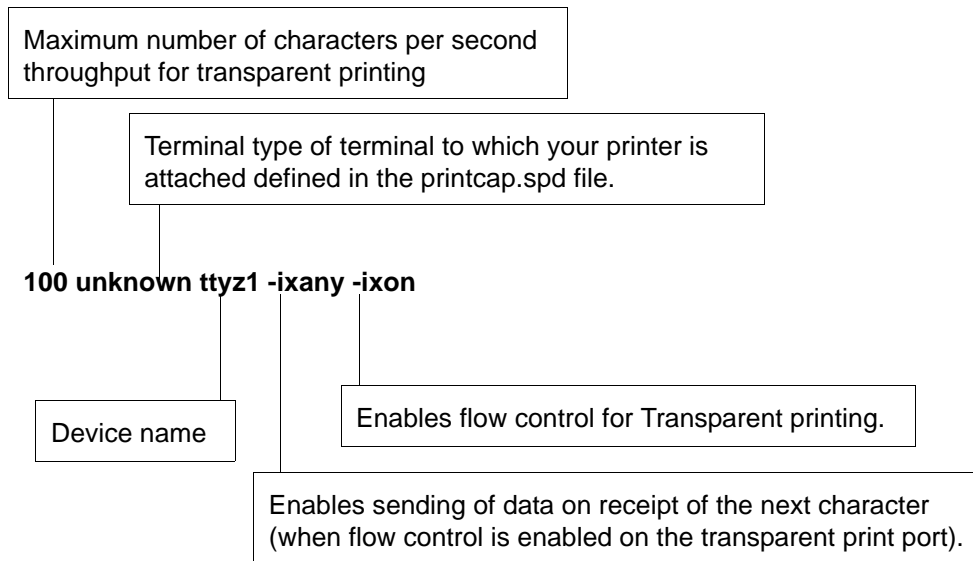

Appendix B : Operations for EIA-422/EIA-485

- [The EIA-422 Standard](#) on page [133](#)
- [The EIA-485 Standard](#) on page [134](#)
- [Cabling Distances](#) on page [138](#)

The EIA-422 Standard

The EIA-422 defines a standard for serial communications. EIA-422 is a high speed or long distance transmission method. EIA-422 system software differs little from familiar point to point EIA-232 communication systems. EIA-422 is often used to extend the distance between nodes over the capabilities of EIA-232. When communicating at high data rates or over long distances in real world environments, single ended methods are often inadequate. Differential data transmission (balanced differential signal) offers superior performance in most applications. Differential signals can help nullify the effects of ground shifts and induced noise signals that appear as common mode voltages on a network. EIA-422 is also specified for multi-drop (party-line) applications where only one driver is connected to, and transmits on a "bus" of up to 10 receivers. While a multi-drop "type" application has many advantages, EIA-422 devices cannot be used to construct a truly multi-point network. A true multi-point network consists of multiple drivers and receivers connected on a single bus, where any node can transmit and receive. However a "Quasi" multi-drop network using EIA-422 consisting of 4 wires can enable a single master in a system to send a command to one of several slave devices on a network. The master node simply prefixes the commands with the appropriate address of the slave. There is no data echo or turn around delays to consider. Since each of the slaves transmitters shares the same pair of wires, care should be taken that the master never requests data from multiple nodes at the same time or data collision can occur.

Specifications	EIA-422
Mode of operation.	Differential
Total number of Drivers and receivers on one line	1 driver, 10 receivers
Maximum Driver Output Voltage	-0.25V to +6V
Driver Output signal loaded	+/-2.0V
Driver Output signal unloaded	+/-6V
Driver load Impedance (Ohms)	100
Slew Rate	fast/slow
Receiver Input Voltage range	-10V to + 10V
Receiver Input Sensitivity	+/-200mV
Receiver Input Resistance (Ohms)	4k min.

The EIA-485 Standard

The EIA-485 standard is similar to the EIA-422 standard upon which it was based. The main difference is that up to 32 transmitter receiver pairs may be present on the line at one time. A 120-Ohm resistor integrated on the UltraPort SI card should be enabled to terminate either end of the main line. The UltraPort SI when configured for EIA-485 full duplex is compatible to use in a EIA-422 multi-drop environment. EIA-485 caan be used in situations where more than one device may transmit data on a shared data line. In general not all lines are used for EIA-485 systems. In a two wire half duplex configuration the TXD+ line is connected to the RXD+ while the TDX- line is connected to the RXD-, only one pair of twisted wire cable is used in a EIA-485 half duplex communications configuration. The special circuitry in the UltraPort SI card when set to auto will automatically sense when data is being transmitted and automatically enable the transmit line as well as disable the transmit line when the data has been sent. Some EIA-485 applications use the RTS handshake line to enable and disable the transmit line. In this case then the field EIA-485 HDX TX Control should be set to RTS. It is now the host application's responsibility to enable and disable the transmit line via the RTS handshake line when it wants to send data. When the EIA-485 HDX TX Control field is set to AUTO, the UltraPort SI card allows you to further customized your application by applying a Auto EIA-485 Bit Delay. This field by default is setto 0 delay, however in some applications the user may want to increase this field up to 15 bits..

Specifications	EIA-485
Mode of operation.	Differential
Total number of Drivers and receivers on one line	32 drivers or receivers
Maximum Driver Output Voltage	-0.25V to +6V
Driver Output signal loaded	+/-2.0V
Driver Output signal unloaded	+/-6V
Driver load Impedance (Ohms)	100
Slew Rate	fast/slow
Receiver Input Voltage range	-10V to + 10V
HDX Control	+/-200mV
Bit-delay	4k min.

*Many Masters /
Many Slaves*

The EIA-485 Full Duplex mode supports many Masters and many Slaves. This system can be used when all EIA-485 devices have separate transmit and receive channels. There is no multiplexing of the TXD and RXD signals on the same device. This system is especially useful when there is no flow control available on the PC, usually due to the use of third party communications programs that prevents the use of the RTS signal as a “transmit enable” control. The advantages of this system are great, since no new communications software is needed, and the PC can talk and listen at the same time. In effect the handshaking is done by the intelligence of the UltraPort SI card.

As wired in the next diagram, the PC can transmit data at any time and the EIA-485 devices#1 to #n can simultaneously receive it. Only one of the EIA-485 devices may transmit data at any one time. Each EIA-485 device recognizes commands and data addressed to it and will only transmit when the Master PC commands it to do so. When the EIA-485 devices receives a command, the UltraPort SI card automatically turns its TXD drivers on and sends the data on the TXD channel, and then disables its TXD drivers afterwards. The other EIA-485 devices remain in the tri-state mode when they are not being addressed and do not transmit any data.

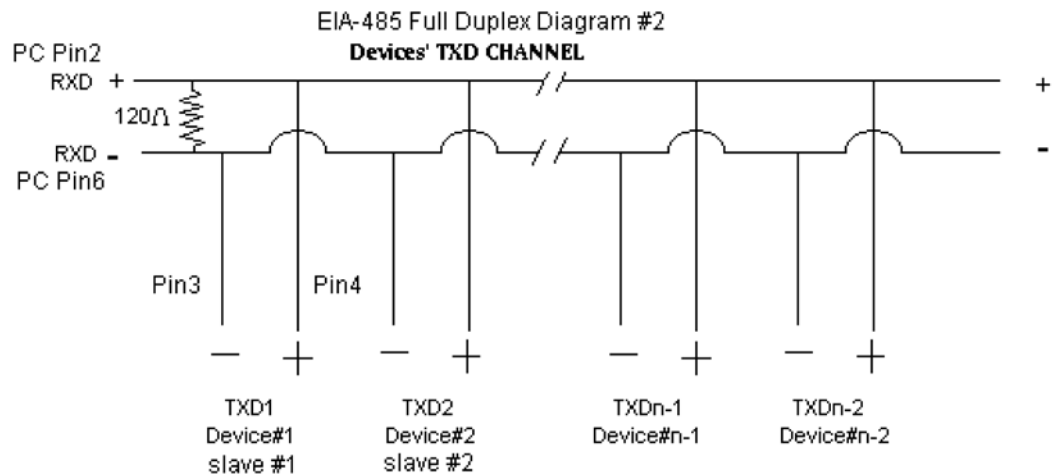
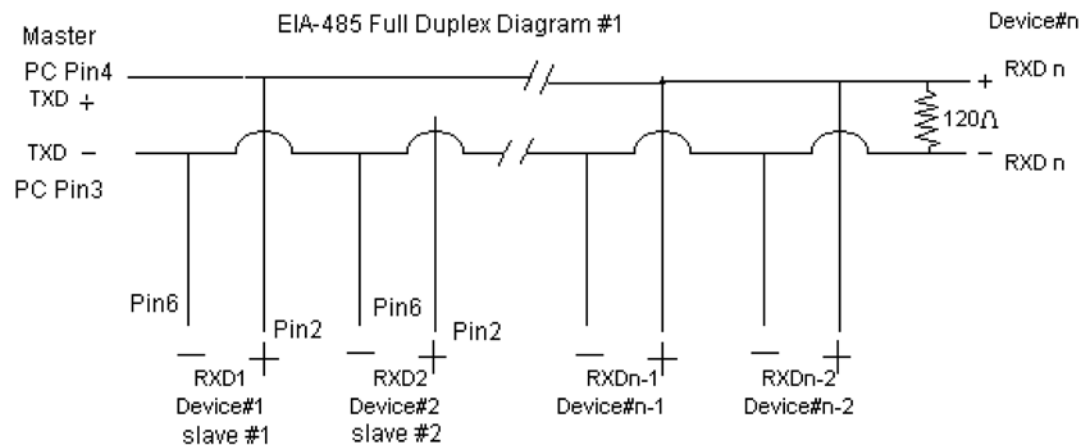

One Masters / Many Slaves

The EIA-485 Half Duplex mode supports a Master and many Slaves devices. This system has only one master device which can transmit to multiple slave devices. In many cases there will be only one maser device, which can transmit data and the other simply receives it. There is no multiplexing of the TXD and RXD lines. The data is flowing only in one direction and needs only one pair of wires.

EIA-485 Half Duplex Diagram #1

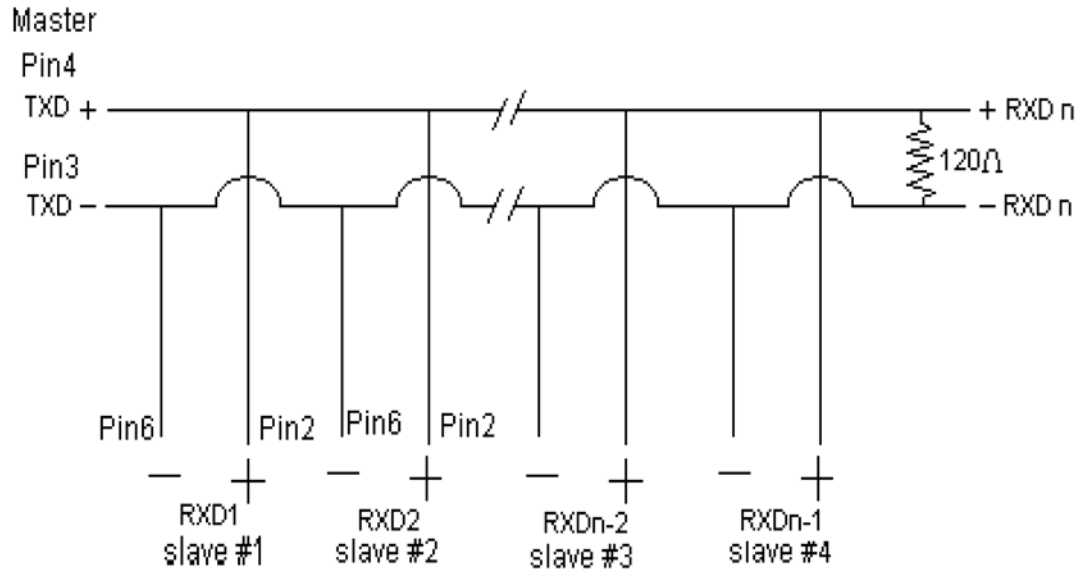

Another popular layout is for multiple masters and slaves in EIA-485 half duplex mode. This is also known as a party line transmission. It is imperative to have some method of preventing two devices from driving the line at the same time. The normal method is to use the RTS as a talk enable control. The RTS line will go true immediately prior to transmission and go false immediately after the last byte in the data stream is sent.

Note: Pin numbers provided in above diagrams are for UltraPort SI DB9 connectors

EIA-485 Half
Duplex Diagram #2

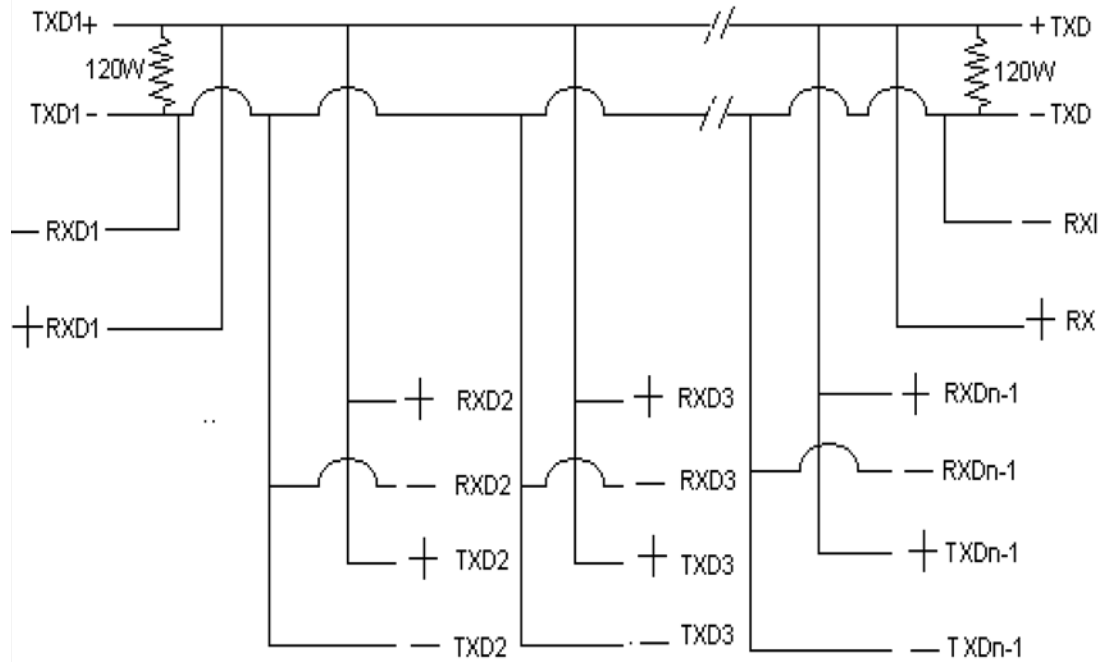

Fail Safe Circuitry

Two common fault conditions that an EIA-485 system can experience are as follows: The cable is open

- The cable is open: This occurs when there are no drivers on the circuit. In a party line/ multi driver/receiver system this is intentional. However there are unintentionally situations when the twisted pair line is accidentally cut/disconnected or the transmitting device fails. In EIA-485 half duplex multi-drop systems there are extended periods of time when none of the possible talkers are gated onto the bus. This is known as a idle state and occurs when all the driver outputs are in the high impedance state. The lines float perhaps being pulled to high or low which can be caused by noise or other voltages. The UltraPort SI cards contain Fail safe Open circuit detection which allows the receiver to go into a known, pre-determined state and prevents false start bits and bad data from being transmitted

The cable has a short: Short circuits are when the two lines of a twisted pair are connected together. This can occur due to a damaged or due to a failure of one or more transmitters/ receivers on the line. The short condition on the line is dangerous in that damage to the receiver may occur and communications can be corrupted or disabled. The EIA-485 specifies that the input threshold of a receiver be between +/200mV differential. This basically means that if the differential voltage on a receiver is 0V, the output state is indeterminate. The Perle UltraPort SI design ensures that the receiver thresholds are between -50mV and -200mV. If 0V appears across the input stage due to a fault condition, the output is guaranteed to be a logic high.

Cabling Distances

Cable length (in feet)	Protocol	Transfer Rate, Kbps
7	EIA-422/EIA-485	3686.4
1000	EIA-422/EIA-485	3686.4
2000	EIA-422/EIA-485	1843.2
3000	EIA-422/EIA-485	921.6
4000	EIA-422/EIA-485	921.6
7	EIA-232	19.2
1000	EIA-232	38.4
2000	EIA-232	19.2
3000	EIA-232	9.6
4000	EIA-232	9.6

Note

These tests were conducted in a controlled lab environment using shielded CAT 5 cabling

Appendix C : Troubleshooting

You need to read this appendix if you want to... You need to read this appendix if you want information on troubleshooting problems with UltraPort, UltraPort SI, and UltraPort Express serial adaptor cards.

This appendix provides examples of normal boot up messages and a table of error messages, their meaning and corrective action required for the all the currently supported operating systems.

This appendix includes the following sections:

- [SCO OpenServer 5](#) on page [140](#).
- [SCO UnixWare/SCO OpenServer 6](#) on page [143](#)
- [Windows NT](#) on page [147](#) (UltraPort and UltraPort SI only)
- [Windows 2000/XP/Server 2003/Vista/Server 2008](#) on page [148](#)

SCO OpenServer 5

Example of normal SPEED driver boot messages

This example shows one UltraPort16 and one UltraPort8 successfully detected and initialised by the driver.

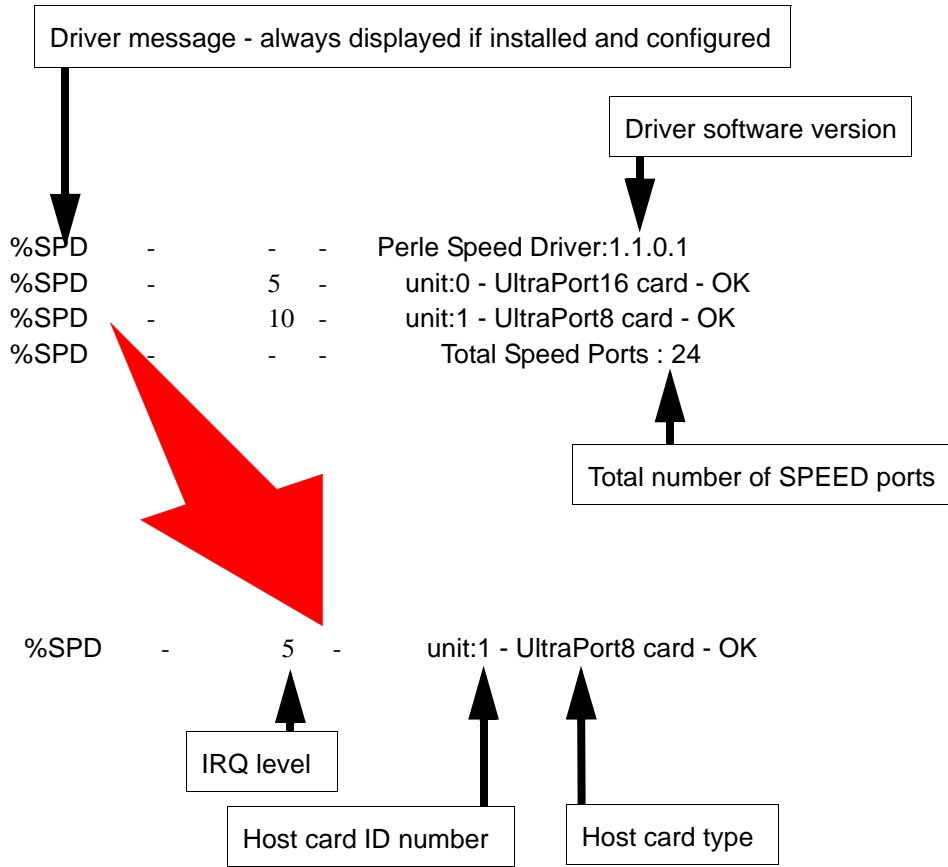

Additional card warning messages

If you install more than one UltraPort, UltraPort SI or UltraPort Express host card, or install additional cards at a later date, the following warning messages will be displayed (they appear immediately following the driver initialisation messages shown on [page 140](#)).

Note

Display of these messages and update of **Speed Node** and **Init** files only occurs once after installation of additional cards. This takes place during system start-up.

Message	This message tells you that...
WARNING: Speed Node file updated - old file moved to <code>/etc/conf/node.d/spd_#####</code>	The speed node file has been updated to include the revised number of ports. Your old Speed node file is retained with the file name shown in the message. '#####' is a unique number so that previous Speed node files are not lost on updating.
WARNING: New Speed ports detected - <code>/etc/conf/node.d/spd</code> being updated	You now have additional entries in the Speed init file, existing entries are retained unchanged. The automatic init file update is necessary to make any additional nodes available in the Speed Port Configuration tool.

Hint

If you have modified your Speed node file, (for example you may have changed the default permission for security reasons), you may wish to re-instate the previous node set-up for existing Speed ports.

If you have not modified your Speed node file or do not require to retain the old settings you may safely delete the file shown in the first message.

SCO OpenServer 5 error messages

Error message	Reason	Action required
ERROR: unit @0xnntnnnnn has bad resource(s)	Incorrectly installed or faulty card. Incorrect BIOS settings.	<ol style="list-style-type: none"> 1. Ensure that you have followed the installation procedure correctly. See page 45. 2. Check BIOS settings. 3. If the problem persists try another card. See page 45 and page 94.
ERROR: unit @0xnntnnnnn not mapped	Insufficient memory available to kernel.	Reconfigure system/kernel memory parameters.
ERROR: unit @0xnntnnnnn not initialised	Incorrectly installed or faulty card.	<ol style="list-style-type: none"> 1. Ensure that you have followed the installation procedure correctly. See page 45. 2. If the problem persists try another card. See page 45 and page 94.
WARNING: unit @0xnntnnnnn not configured	System error.	<ol style="list-style-type: none"> 1. Uninstall the driver and remove all Speed cards from the system. See page 60 2. Re-install the driver and cards taking care to follow the correct procedure. See page 45 and page 94.
WARNING: No Speed ports configured	No cards installed. Installed cards suffer from one or more of above symptoms.	<ol style="list-style-type: none"> 1. Install cards. See page 94. 2. Resolve any above listed faults.

SCO UnixWare/SCO OpenServer 6

There are no messages displayed on the system at startup. Messages from the SPEED driver are sent to the **syslog** file in the /var/adm directory. Each entry in the **syslog** file is date and time stamped (You can review the content of the syslog file using a suitable text editor). Each time the driver is loaded, entries similar to those shown below indicate successful UltraPort card detection.

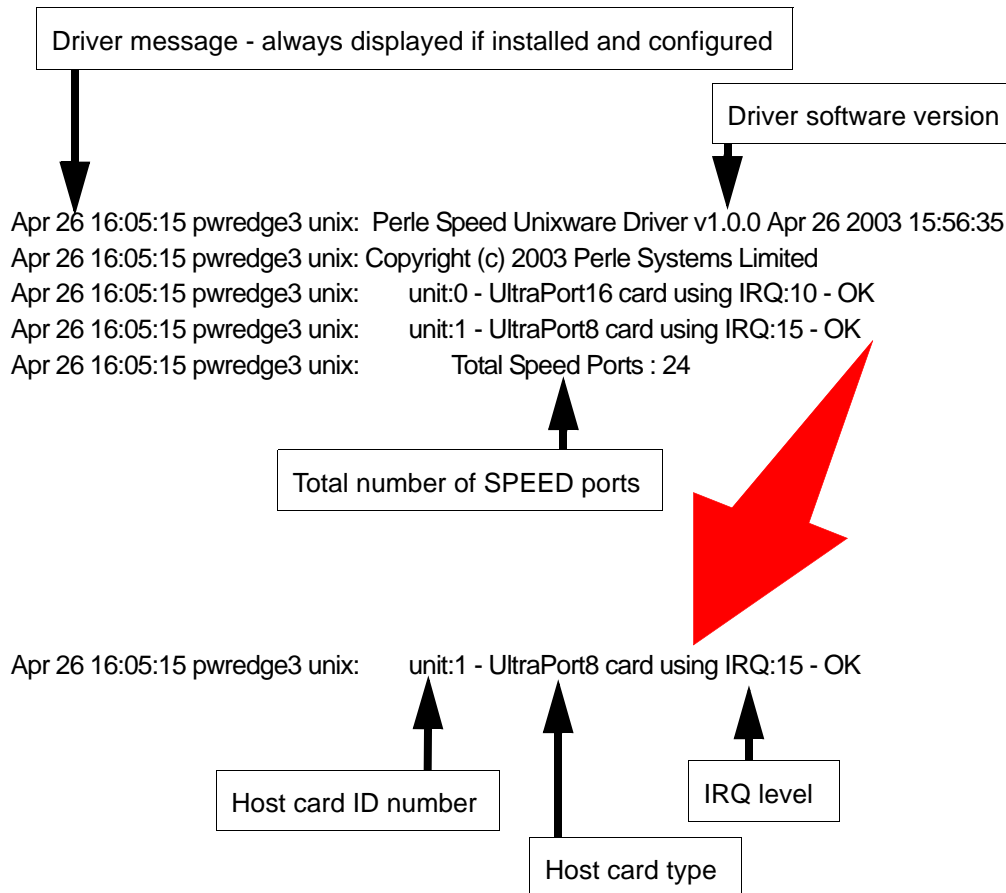

Additional card warning messages

If you install more than one UltraPort, UltraPort SI or UltraPort Express host card, or install additional cards at a later date, the following warning messages will be displayed during system start-up.

Note

Display of these messages and update of **Speed Node** and **Init** files only occurs once after installation of additional cards. This takes place during system start-up.

Message	This message tells you that...
WARNING: Speed Node file updated - old file moved to <code>/etc/conf/node.d/spd_#####</code>	The speed node file has been updated to include the revised number of ports. Your old Speed node file is retained with the file name shown in the message. '#####' is a unique number so that previous Speed node files are not lost on updating.
WARNING: New Speed ports detected - <code>/etc/conf/node.d/spd</code> being updated	You now have additional entries in the Speed init file, existing entries are retained unchanged. The automatic init file update is necessary to make any additional nodes available in the Speed Port Configuration tool.

Hint

If you have modified your Speed node file, (for example you may have changed the default permission for security reasons), you may wish to re-instate the previous node set-up for existing Speed ports.

If you have not modified your Speed node file or do not require to retain the old settings you may safely delete the file shown in the first message.

SCO UnixWare error messages

Error message	Reason	Action required
ERROR: unit @0xn timer has bad resource(s)	Incorrectly installed or faulty card. Incorrect BIOS settings.	<ol style="list-style-type: none"> 1. Ensure that you have followed the installation procedure correctly. See page 63. 2. Check BIOS settings. 3. If the problem persists try another card. See page 63 and page 94.
ERROR: unit @0xn timer not mapped	Insufficient memory available to kernel.	Reconfigure system/kernel memory parameters.
ERROR: unit @0xn timer not initialised	Incorrectly installed or faulty card.	<ol style="list-style-type: none"> 1. Ensure that you have followed the installation procedure correctly. See page 63. 2. If the problem persists try another card. See page 63 and page 94.
WARNING: unit @0xn timer not configured	System error.	<ol style="list-style-type: none"> 1. Uninstall the driver and remove all Speed cards from the system. See page 63 2. Re-install the driver and cards taking care to follow the correct procedure. See page 63 and page 94.
Error: could not register interrupt handler for unit @0xn timer	System error	<ol style="list-style-type: none"> 1. Uninstall the driver and remove all Speed cards from the system. See page 63 2. Re-install the driver and cards taking care to follow the correct procedure. See page 63 and page 94.
WARNING: No Speed ports configured	No cards installed. Installed cards suffer from one or more of above symptoms.	<ol style="list-style-type: none"> 1. Install cards. See page 94. 2. Resolve any above listed faults.

Error message	Reason	Action required
UX: sh (sh): ERROR: telinit: Not found (Note this error occurs on UnixWare 2 systems only)	telinit command not found	None. The installation process takes care of configuring the kernel and ensures that SPEED ports are ready for use when the installation process is complete.
Unable to open device /dev/spd : No such device	No SPEED cards installed during driver installation.	1. Install cards. See page 94 . Note that there is no need to uninstall and re-install the driver. When the system is rebooted, your SPEED cards will be detected and configured into the kernel.

Windows NT

Windows NT general troubleshooting UltraPort and UltraPort SI only

In the event of any problems, open the **Devices** window to view the status of any installed hardware. For further details of troubleshooting under Windows NT, see your Windows NT user documentation or help system.

Windows 2000/XP/Server 2003/Vista/Server 2008

This section describes troubleshooting UltraPort, UltraPort SI, and UltraPort Express products under the Windows 2000, Windows XP, Windows Server 2003, Windows Vista, or Server 2008 operating systems and includes the following sections:

Note

To contact Perle for technical support, see [Appendix D : Contacting Perle](#)

- [General troubleshooting under Windows 2000/XP/Server 2003/Vista/Server 2008](#) on page 149.
- [Windows error messages](#) on page 149.

General troubleshooting under Windows 2000/XP/Server 2003/Vista/Server 2008

Problem	Action required
Machine fails to boot.	<ol style="list-style-type: none"> 1. Turn off your machine, remove UltraPort card(s) and reboot. See page 100. 2. Try installing a different host card in case the one currently installed is faulty. See page 94.
Windows operating system fails while loading and the system hangs.	<ol style="list-style-type: none"> 1. Reboot machine and then switch to the last known good configuration. 2. Check for resource conflicts or faulty hardware.
Windows operating system fails while loading and displays a blue screen.	<ol style="list-style-type: none"> 1. Note the five hexadecimal numbers at the top line of the screen 2. Reboot your machine and then switch to the last known good configuration. 3. Check for resource conflicts or faulty hardware.
Operating system loads OK, but SPEED driver or another driver fails to boot	<ol style="list-style-type: none"> 1. Run Windows Device Manager to find available IRQ and memory addresses.
UltraPort ports do not work after installation.	<ol style="list-style-type: none"> 1. Check the Windows Event Log and follow the suggested actions.
SPEED Windows driver fails during normal operation, symptom: blue screen	<ol style="list-style-type: none"> 1. Note the five hexadecimal numbers displayed at the top line of the screen. 2. Reboot your machine and then switch to the last known good configuration. 3. Check for resource conflicts or faulty hardware.
SPEED Windows driver fails during normal operation, symptoms either: black screen, machine reboots or system hangs	<ol style="list-style-type: none"> 1. Contact Technical Support. See Appendix D : Contacting Perle.

Windows error messages

In the event of any error messages, check the **Windows Event** Log. Also open the Windows Device Manager and check for warning icons on the installed hardware. See your Windows 2000, Windows XP, Windows Server 2003, Windows Vista, or Server 2008 user documentation or help system for details.

For general problems, see [General troubleshooting under Windows 2000/XP/Server 2003/Vista/Server 2008](#) on page [149](#).

Appendix D : Contacting Perle

You need to read this appendix if you want to... You need to read this appendix if you want to contact Perle for technical support or any other queries about this product.

This appendix includes the following sections:

- [Making a technical support query](#) on page 150
- [Repair procedure](#) on page 152
- [Feedback about this manual](#) on page 152
- [Perle support centres worldwide](#) on page 153

Internet access

[Click here to access the our website at the following URL:](#)
<http://www.perle.com>

Email

[Click here to email](#) Perle at the following address:
[Email: support@perle.com](mailto:support@perle.com)

Making a technical support query

This section contains the following information about making a query:

- [Who to contact](#) on page 150
- [Information needed when making a query](#) on page 151
- [Making a support query via the Perle web page](#) on page 152

Who to contact

If you bought your product from a registered Perle supplier, you must contact their Technical Support department; they are qualified to deal with your problem.

If you are a registered Perle supplier, and bought your product from Perle, contact Perle Technical Support at the offices listed below.

Information needed when making a query

When you make a technical support enquiry please have the following information ready:

Hint
Print out this page and fill in the table provided with the basic information you need.

Item	Write details here
Product name and version	
Problem description	
Operating system version	
Driver version	
Details of any other cards installed in your system	
Your name	
Company Name	
Country	
Phone number	
Fax number	
Email address (if available)	

Making a support query via the Perle web page

If you have an internet connection, please send details of your problem to Technical Support using the email links provided on the Perle web site in the 'Support' area.

See also [Perle support centres worldwide](#) on page 153 for email links and other contact details for the Perle technical support centres.

Click here to access our website at the following URL:
<http://www.perle.com>

Repair procedure

Before sending a unit for repair, you must contact your Perle supplier. If, however, you bought your product directly from Perle you can contact directly. See [Perle support centres worldwide](#) on page 153 for contact information.

Customers who are In Europe, Africa or Middle East can submit repair details via a website form shown in the next picture. This form is on the Perle website, www.perle.com, in the **Support** area.

Click here to access our web site at the following URL:
http://www.perle.com/support_services/rma_form.asp

In the USA and Asia contact the office shown in the Technical Support section.

Feedback about this manual

If you have any comments or suggestions for improving this manual please email Perle using the following address:

docfeedback@perle.com

Please include the **title**, **part number** and **date** of the manual (you can find these on the title page at the front of this manual).

Perle support centres worldwide

Note

Perle offers free technical support to Perle Authorised Distributors and Registered Perle Resellers.

To access technical support please visit the Perle website at www.perle.com/support_services/index.shtml.

If you are unable to find the information you require, please feel free to contact our technical support teams by email using the addresses shown in the next table.

Country	Address	Email
North America	Perle Systems Ltd. 60 Renfrew Drive Markham Ontario Canada L3R OE1	Email: ptac@perle.com
Europe	Perle Systems Europe Ltd. 3 Wintersells Road Byfleet Surrey KT14 7LF UK	Email: ptac@perle.com
Asia	Perle Asia Pacific (Pte) Ltd. 190 Middle Road #19-05 Fortune Centre Singapore 188979	Email: ptac@perle.com
Worldwide	Perle Systems Ltd. 60 Renfrew Drive Markham Ontario Canada L3R OE1	Email: ptac@perle.com

A B C D E F G H I J K L M N O P Q R S T U V W X Y Z

Index

Numerics

- 4 port cards
 - installing [95](#)

A

- About this manual [4](#)

C

- cables
 - connector pinouts [115](#)
- cabling information [101](#)
- card edge
 - connector pinouts [102](#)
- connector pinouts
 - cables [115](#)
 - card edge [102](#)
 - distribution boxes [115](#)
- contacting Perle Systems
 - email [150](#)
 - for technical support [150](#)
 - internet [150](#)

D

- device drivers and utilities
 - installing
 - SCO OpenServer [46](#)
 - SCO UnixWare [64, 76](#)
 - Windows 95 and 98 [20](#)
 - removing
 - SCO OpenServer [60](#)
 - SCO UnixWare [73, 85](#)
 - Windows 95 and 98 [30](#)
- distribution boxes
 - connector pinouts [115](#)
- drivers and host cards [15](#)

E

- email [150](#)
- error messages
 - SCO OpenServer 5 [142](#)
 - SCO UnixWare [145](#)

F

- FAST serial adaptors
 - introduction to [13](#)

H

- host cards
 - installing
 - 4 port [95](#)
 - removing [100](#)

I

- installation [15](#)
 - device drivers and utilities
 - Linux [86](#)
 - SCO OpenServer [44, 46](#)
 - SCO UnixWare [62, 64, 76](#)
 - Solaris [74](#)
 - Windows 2000 [35](#)
 - Windows 95 and 98 [20](#)
 - general procedure
 - Linux [86](#)
 - SCO OpenServer [45](#)
 - SCO UnixWare [63, 75](#)
 - Windows 95 and 98 [19](#)
 - under Windows 95 and 98 [18](#)
- installing
 - 4 port cards [95](#)
- Installing host cards and cable accessories [94](#)

A B C D E F G H I J K L M N O P Q R S T U V W X Y Z

L

Linux

- general installation procedure [86](#)
- installation under [86](#)

O

on-line manual

- guide to using [5](#)
- hypertext jumps [5](#)
- navigation [5](#)

OpenServer, see SCO OpenServer

P

Port Configuration utility

- exiting [56](#)
- port login, setting up [55](#)
- starting [52](#)

port login

- setting up under SCO OpenServer 5 [55](#)

print.spd configuration file [131](#)

printcap.spd configuration file [130](#), [134](#)

printing, transparent [128](#)

problems [130](#), [133](#)

product repair form [152](#)

R

removing

- device drivers and utilities
 - SCO OpenServer [60](#)
 - SCO UnixWare [73](#), [85](#)
 - Windows 95 and 98 [30](#)
- host cards [100](#)

repair procedure [152](#)

- product repair form [152](#)
- RMA form [152](#)

RJ45 socket

- card edge views [102](#)
- pinouts [102](#)

RMA form [152](#)

S

SCO OpenServer

device drivers and utilities

- installing [46](#)
- removing [60](#)

general installation procedure [45](#)

installation under [44](#)

installing device drivers and utilities [46](#)

Port Configuration utility [52](#)

SCO OpenServer 5

- error messages [142](#)
- troubleshooting [140](#)

SCO UnixWare

device drivers and utilities

- installing [64](#), [76](#)
- removing [73](#), [85](#)

error messages [145](#)

installation under [62](#)

serial ports, configuring [66](#), [78](#)

serial ports

configuring

- SCO OpenServer [52](#)
- SCO UnixWare [66](#), [78](#)
- under Windows 2000 [38](#)
- Windows 95 and 98 [24](#)

Solaris

installation under [74](#)

T

technical support [150](#)

- centres worldwide [153](#)
- queries, information needed for [151](#)
- via the internet [152](#)
- who to contact [150](#)

transparent printing [128](#), [130](#), [133](#)

definition of [129](#)

print.spd configuration file [131](#)

printcap.spd configuration file [130](#), [134](#)

troubleshooting

- SCO OpenServer 5 [140](#)
- Windows 2000 [148](#)
- Windows NT [147](#)

U

UnixWare, see SCO UnixWare

A B C D E F G H I J K L M N O P Q R S T U V W X Y Z

W

- Windows 2000 [35](#)
 - configuring serial ports [38](#)
 - device drivers and utilities
 - installing [35](#)
 - installing device drivers and utilities [35](#)
 - troubleshooting [148](#)
- Windows 95 and 98
 - device drivers and utilities
 - installing [20](#)
 - removing [30](#)
 - general installation procedure [19](#)
 - installation under [18](#)
 - installing device drivers and utilities [20](#)
 - Port Configuration utility [24](#)
- Windows NT
 - troubleshooting [147](#)

Free Manuals Download Website

<http://myh66.com>

<http://usermanuals.us>

<http://www.somanuals.com>

<http://www.4manuals.cc>

<http://www.manual-lib.com>

<http://www.404manual.com>

<http://www.luxmanual.com>

<http://aubethermostatmanual.com>

Golf course search by state

<http://golfingnear.com>

Email search by domain

<http://emailbydomain.com>

Auto manuals search

<http://auto.somanuals.com>

TV manuals search

<http://tv.somanuals.com>