



# Perle PoE/PoE+

## 10/100/1000 Ethernet

### Media Converters

---

## Installation Guide

S-1110P

S-1110PP

S-1110DP

S-1110DPP



P/N 5500317-11

# Overview

This document contains instructions necessary for the installation and operation of the Perle Standalone PoE/PoE+ 10/100/1000 rate converting Media Converters (S-1110P). These products have the ability to convert 10/100/1000Base-T cable connections (copper) to 100/1000Base-X connections (fiber). The Perle media converters function as a PoE switch, and support a variety of port configurations, including single or dual UTP and fiber ports. These media converters function as Power Sourcing Equipment (PSE) and can power either one or two Powered Devices (PDs) using standard UTP cables that carry Ethernet data. The S-1110P models are compatible with Powered Devices that comply with the IEEE 802.3af standard and the S-1110PP models are compatible with Powered Devices that comply with both the IEEE 802.3af and the 802at-2009 standard. The fiber connection can be either single mode (SM) or multimode (MM) and can operate over different wavelengths and distances, depending on the model selected (see table below).

## 2 Port Models

PoE (P) PoE+ (PP)	Connector (xx)	Mode Distance	Wavelength (TX/RX)
S-1110P-M2xx05 S-1110PP-M2xx05	SC/ST	MM 550 m/1804 ft.	850 nm
S-1110P-S2xx10 S-1110PP-S2xx10	SC/ST	SM 10 km/6.2 mi.	1310 nm
S-1110P-S1SC10U S-1110PP-S1SC10U	SC	SM 10 km/6.2 mi.	1310/1490 nm
S-1110P-S1SC10D S-1110PP-S1SC10D	SC	SM 10 km/6.2 mi.	1490/1310 nm
S-1110P-S1SC20U S-1110PP-S1SC20U	SC	SM 20 km/12.4 mi.	1310/1490 nm
S-1110P-S1SC20D S-1110PP-S1SC20D	SC	SM 20 km/12.4 mi.	1490/1310 nm
S-1110P-S2xx40 S-1110PP-S2xx40	SC/ST	SM 40 km/25 mi.	1310 nm
S-1110P-S1SC40U S-1110PP-S1SC40U	SC	SM 40 km/25 mi.	1310/1490 nm
S-1110P-S1SC40D S-1110PP-S1SC40D	SC	SM 40 km/25 mi.	1490/1310 nm
S-1110P-S2xx70 S-1110PP-S2xx70	SC/ST	SM 70 km/43.5 mi.	1550 nm

PoE (P) PoE+ (PP)	Connector (xx)	Mode Distance	Wavelength (TX/RX)
S-1110P-S1SC80U S-1110PP-S1SC80U	SC	SM 80 km/50 mi.	1510/1590 nm
S-1110P-S1SC80D S-1110PP-S1SC80D	SC	SM 80 km/50 mi.	1590/1510 nm
S-1110P-S2xx120 S-1110PP-S2xx120	SC/ST	SM 120 km/74.6 mi.	1550 nm
S-1110P-S1SC120U S-1110PP-S1SC120U	SC	SM 120 km/74.6 mi.	1510/1590 nm
S-1110P-S1SC120D S-1110PP-S1SC120D	SC	SM 120 km/74.6 mi.	1590/1510 nm
S-1110P-S2xx160 S-1110PP-S2xx160	SC/ST	SM 160 km/100 mi.	1550 nm
S-1110P-SFP S-1110PP-SFP	SFP	<b>Note 1</b>	

**Note 1:** Fiber characteristics will depend on the SFP fiber module selected.

### 3 Port Models

Dual Copper / PoE (DP) Dual Copper / PoE+ (DPP)	Connector (xx)	Mode Distance	Wavelength (TX/RX)
S-1110DP-M2xx05 S-1110DPP-M2xx05	SC/ST	MM 550 m/1804 ft.	850 nm
S-1110DP-S2xx10 S-1110DPP-S2xx10	SC/ST	SM 10 km/6.2 mi.	1310 nm
S-1110DP-S1SC10U S-1110DPP-S1SC10U	SC	SM 10 km/6.2 mi.	1310/1490 nm
S-1110DP-S1SC10D S-1110DPP-S1SC10D	SC	SM 10 km/6.2 mi.	1490/1310 nm
S-1110DP-S1SC20U S-1110DPP-S1SC20U	SC	SM 20 km/12.4 mi.	1310/1490 nm
S-1110DP-S1SC20D S-1110DPP-S1SC20D	SC	SM 20 km/12.4 mi.	1490/1310 nm
S-1110DP-S2xx40 S-1110DPP-S2xx40	SC/ST	SM 40 km/25 mi.	1310 nm
S-1110DP-S1SC40U S-1110DPP-S1SC40U	SC	SM 40 km/25 mi.	1310/1490 nm
S-1110DP-S1SC40D S-1110DPP-S1SC40D	SC	SM 40 km/25 mi.	1490/1310 nm
S-1110DP-S2xx70 S-1110DPP-S2xx70	SC/ST	SM 70 km/43.5 mi.	1550 nm
S-1110DP-S1SC80U S-1110DPP-S1SC80U	SC	SM 80 km/50 mi.	1510/1590 nm

Dual Copper / PoE (DP) Dual Copper / PoE+ (DPP)	Connector (xx)	Mode Distance	Wavelength (TX/RX)
S-1110DP-S1SC80D S-1110DPP-S1SC80D	SC	SM 80 km/50 mi.	1590/1510 nm
S-1110DP-S2xx120 S-1110DPP-S2xx120	SC/ST	SM 120 km/74.6 mi.	1550 nm
S-1110DDP-S1SC120U S-1110DDPP-S1SC120U	SC	SM 120 km/74.6 mi.	1510/1590 nm
S-1110DP-S1SC120D S-1110DPP-S1SC120D	SC	SM 120 km/74.6 mi.	1590/1510 nm
S-1110DP-S2xx160 S-1110DPP-S2xx160	SC/ST	SM 160 km/100 mi.	1550 nm
S-1110DP-SFP S-1110DPP-SFP	SFP	<b>Note 1</b>	

### 3 Port Models - SFP

Model PoE (P) / Dual SFP PoE+ (PP) / (Dual SFP)	Connector (xx)	Mode Distance	Wavelength (TX/RX)
S-1110P-DSFP	SFP	<b>Note 1.</b>	<b>Note 1.</b>
S-1110PP -DSFP	SFP	<b>Note 1</b>	<b>Note 1.</b>

### 4 Port Models - SFP

Model Dual copper / PoE / Dual SFP Dual copper / PoE+ / Dual SFP	Connector (xx)	Mode Distance	Wavelength (TX/RX)
S-1110DP-DSFP	SFP	<b>Note 1.</b>	<b>Note 1.</b>
S-1110DPP-DSFP	SFP	<b>Note 1</b>	<b>Note 1.</b>

**Note 1:** Fiber characteristics will depend on the SFP fiber module selected.

Please visit Perle's website for the most up to date Installation guides models and specifications.

<http://www.perle.com/>

# Installation

The default DIP switch settings (all switches in the UP position) will work for most installations.

These are the steps required to configure the Perle S-1110P Ethernet media converter:

1. Insert SFP Module (SFP Model only).
2. Set the Auto-MDIX jumper setting (optional).
3. Set the DIP switch settings (if required).
4. Set the Powering Option Jumpers (if required).
5. Install and connect the fiber cable(s).
6. Install and connect the copper cable(s).
7. Power up the media converter.

## *Auto-MDIX Jumper Settings*

**Note:** The factory settings for Auto-MDIX will work for most installations, but in the rare case that you need to modify the settings, the procedure is below.

For dual copper media converters, each copper interface has an Auto-MDIX jumper bank. To access the Auto-MDIX jumper settings, unscrew the six side screws on the case and remove the cover plate. Locate the MDIX AUTO jumper set as detailed below. By covering or strapping pins 1 and 2, the S-1110P will operate as an MDIX device. By covering or strapping pins 2 and 3, the S-1110P will automatically detect the Ethernet cable's polarity. Removing the strapping is the same as AUTO.

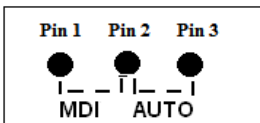

**Note:** The default jumper setting is AUTO

# Power Sourcing Pinouts

**Note:** The factory settings for Power Sourcing Pinouts will work for most installations as 802.3a and 802at-2009 ( POE/POE+) devices will detect and sync to the correct POE option. However, in the rare case that you need to modify the settings, the procedure is below.

When Power Sourcing is enabled on a copper port, the S-1110P will provide power to the connected PD device over the Ethernet cable ([see PSE function on Dip Switch configurations](#)). The wire pairs on the cable used for delivering power will depend on the device. The following options are available.

RJ-45	PoE Option		
	Alternative A	Alternative B	Legacy
1	positive		
2	positive		
3	negative		
4		positive	negative
5		positive	negative
6	negative		
7		negative	positive
8		negative	positive

## ***UTP (copper) Power***

### **PoE**

- IEEE 802.3af (PoE) up to 15.4 Watts per UTP port.

### **PoE+**

- IEEE 802at-2009 (PoE+)
- Up to 30 Watts on a single UTP port model and up to 25.5 Watts per port on a dual UTP port model
- PoE+ models will also support 802.3af PDs (Type 1) and PoE+ PDs (Type 2)

# Powering Options Jumper Settings

In order to select a powering option, the Power Options Jumper settings must be set. Each copper port has a set of Power Option jumpers. To access the Powering Options Jumper settings, unscrew the six side screws on the case and remove the cover plate. Locate the Power Option jumper set and strap the option pins as detailed below.

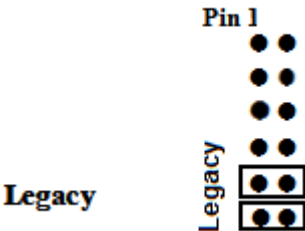
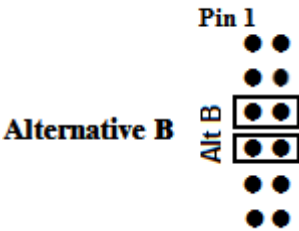
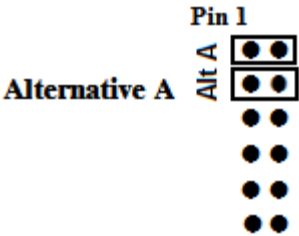

# DIP Switches

The DIP switches are accessible through the opening in the side of the enclosure.



Bank 1      Bank 2

## Bank 1

1 - Auto-Negotiation (copper)

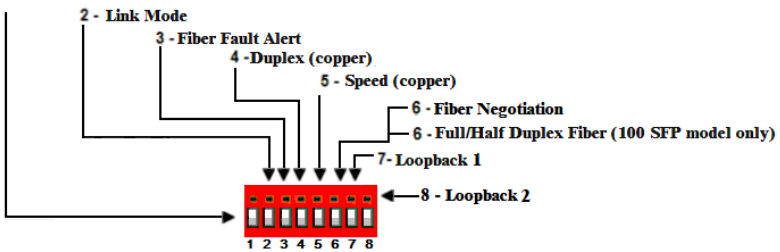

## Bank 2

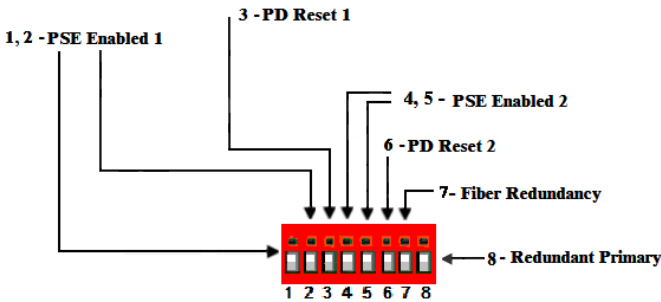

**Note:** All switch changes take effect immediately. Switch changes will cycle power to the PD only if the PD Reset switch is set to On or you make changes to the PSE Power switches.



# DIP Switch Settings

## Bank 1

### *Auto Negotiation copper (Switch 1)*

Switch Position	Copper 1	Copper 2
Up (default)	Auto	Auto
Down	Off	Auto

**Note:** Auto negotiation should only be turned off, if the copper link partner does not support Auto Negotiation and fixed settings are required by the copper link partner.

**Auto:** When enabled, the media converter will negotiate with its link partner to determine the most optimal parameters for this connection. The S-1110P will advertise capabilities of 10,100 and 1000 Mbps, full and half duplex as well as pause, and remote fault capabilities to the link partner.

If the copper link partner does not support Auto negotiation, the S-1110P will parallel detect to 10 or 100 Mbps and force Half Duplex mode as per IEEE specifications.

**Off:** When the Auto Negotiation switch is set to the OFF position, the media converter will not negotiate the Ethernet parameters with the copper link partner. The parameters used by the media converter will be determined by the Duplex (switch 4) and Speed (switch 5) DIP switch settings.

**Note:** This switch affects the behaviour of copper port 1 only; copper port 2 is always set to Auto.

### *Link Mode (Switch 2)*

Switch Position	Mode
Up (default)	Standard Mode
Down	Smart Link Pass-Through

**Standard Mode:** In this mode, link on the fiber and copper sides can be brought up and down independently of each other. A loss

of link on either the fiber or copper port can occur without affecting the other connection.

**Smart Link Pass-Through** In this mode, the link state on one connection is directly reflected through the media converter to the other connection. If link is lost on one of the connections, then the other link will be brought down by the media converter.

If the media converter has 2 copper or 2 fiber connections, then both must go down in order to affect the other connection(s).

If the installation has a media converter on both ends of the fiber link and both are set-up for Smart Link Pass-Through, then a loss of copper link on the far end device will propagate through both media converters and will result in a loss of link at the near end device.

### ***Fiber Fault Alert (Switch 3)***

Switch Position	Fiber Port 1	Fiber Port 2
Up (default)	Enabled	Enabled
Down	Disabled	Enabled

**Enabled:** If the media converter detects a loss of signal on the fiber receiver, it will immediately disable its fiber transmitter signal on the same port. This, in effect, notifies the fiber link partner that an error condition exists on the fiber connection.

If the remote media converter is set up for Fiber Fault Alert (FFA) and the local media converter is set up with Link Pass-Through, a loss of fiber link on either the transmit or receive line will be passed through to the local copper connection thus notifying the connected device.

If the media converter has been set to Smart Link Pass-Through mode, the effect will be the same as FFA, since the link loss on the fiber receiver will result in bringing down the copper link, which will in turn cause the transmit fiber link to be brought down.

**Note:** This feature only takes effect if Fiber Negotiation has been turned off.

**Disabled:** The media converter will not monitor for or generate Fiber Fault Alert.

## Illustration of the FFA

The following diagram is an illustration of the operation of this feature.

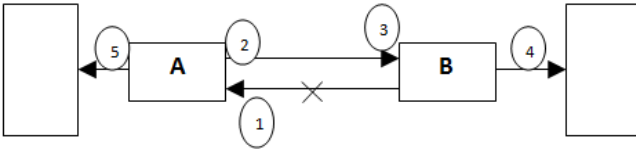

**(A)** – Remote Media Converter setup for Fiber Fault Alert Enabled, Fiber Negotiation – OFF and Link Mode – Standard.

**(B)** – Local Media Converter setup for Fiber Fault Alert Enabled, Smart Link Pass-Through On and Fiber Negotiation - OFF

1 – **(A)** Loses fiber connection on its receiver.

2 – **(A)** Sends FFA.

3 – **(B)** Detects FFA signal and shuts down the fiber link.

4 – **(B)** Drops link on copper connection because Smart Link Pass-Through is configured.

5 – **(A)** Link on copper connection is not affected because Smart Link Mode is set to Standard.

## Duplex copper (Switch 4)

Switch Position	Copper port 1	Copper port 2
Up (default)	Full Duplex	NA
Down	Half Duplex	NA

**Note:** When Auto Negotiation (SW1) is set to Off, the media converter will use this Duplex setting for copper port 1.

**Full Duplex:** In the Up switch position; the media converter will be set to Full Duplex mode.

**Half Duplex:** The media converter will be set to Half Duplex mode.

## ***Speed copper (Switch 5)***

<b>Switch Position</b>	<b>Copper port 1</b>	<b>Copper port 2</b>
Up (default)	100	NA
Down	10	NA

**Note** When Auto Negotiation (SW1) is set to Off, the media converter will use this switch setting for copper port 1 speed.

**100:** When Switch 5 is in the Up position, the S-1110P will force the speed to 100 Mbps.

**10:** When Switch 5 is in the Down position the media converter will force the speed to 10 Mbps.

## ***Auto Fiber Negotiation (Switch 6)***

<b>Switch Position</b>	<b>Fiber 1 1000 Mbps</b>	<b>Fiber 2 1000 Mbps</b>
Up (default)	Auto	Auto
Down	Off	Auto

**Auto:** The Media Converter will negotiate Ethernet parameters on the fiber connection. This will ensure that the most optimal connection parameters will be in effect. If connecting to another Perle Media Converter, this parameter should be set to Auto. The Media Converter Module will advertise 1000Mbps, Full and Half Duplex, no Pause.

**Off:** The Media Converter Module's fiber will be fixed to 1000Mbps, Full Duplex.

**Note:** Fiber port 2 is always set to Auto.

## ***When using a 100 Mbps SFP module Full/Half Duplex on Fiber (Switch 6)***

<b>Switch Position</b>	<b>Fiber 1 100 Mbps</b>	<b>Fiber 2 100 Mbps</b>
Up (default)	Full Duplex	Full Duplex
Down	Half Duplex	Full Duplex

**Full Duplex:** The Media Converter Module will be set to Full Duplex mode on its fiber link.

**Half Duplex:** The Media Converter Module will be set to Half Duplex mode on its fiber link.

### ***Loopback Fiber-1 (Switch 7)***

### ***Loopback Fiber-2 (Switch 8)***

Switch Position	Mode
Up (default)	Disabled
Down	Enabled

**Disabled:** The loopback feature is disabled. This is default position for normal operation. The switch must be set to this position in order for data to pass through the media converter.

**Enabled:** This is a test mode. All data received on the receive (RX) fiber connection is looped back to the transmit (TX) fiber connection. The data link will be disabled; however power to the powered devices will be maintained. This mode will override all other switch settings.

**Note:** On media converters with two fiber ports, both ports can be in loopback mode at the same time.

## **Bank 2**

### **PSE Enable Copper-1 (Switch 1, 2)**

### **PSE Enable Copper-2 (Switch 4, 5) (dual copper models only)**

Switch Position 1, 4	Switch Position 2, 5	Type
Up (default)	Up (default)	PSE enabled normal detection
Up	Down	PSE enabled High capacitance detection
Down	Up	PSE enabled Legacy device detection

Down	Down	PSE disabled
------	------	--------------

These switches must be set in order to enable the power sourcing function and to indicate the type of device detection required. If the device type is unknown, the default should be used as per IEEE802.3af/at standards.

**Enabled:** When enabled, the media converter will perform Power Sourcing Equipment (PSE) functions as per IEEE802.3af (POE) or 802.3at-2009 (POE+) standards.

**Disabled:** When disabled the media converter will not perform PSE functions.

## PD Power Reset 1 (Switch 3) PD Power Reset 2 (Switch 6) (dual copper models only)

Switch Position	Mode
Up (default)	Disabled
Down	Enabled

**Disabled:** When disabled, the loss of fiber link has no effect on PSE power to the PD device.

**Enabled:** When enabled, if the media converter detects loss of link on any fiber port it will turn off PSE output power to the PD device connected to copper port 1. After 2 seconds, the media converter will restore power to the PD and the power will remain on until one of the fiber links transitions from the link up to link down state.

**Disabled:** When disabled the media converter will not perform PSE functions.

## ***Fiber Redundancy (Switch 7)***

### ***Dual fiber models only***

<b>Switch Position</b>	<b>Mode</b>
Up (default)	Disabled
Down	Enabled

**Disabled:** When this feature is disabled, both fiber ports will operate as independent ports on a switch. Normal switch rules and functions will apply.

**Enabled:** When this feature is enabled, fiber port 1 will be the primary active fiber connection port and fiber port 2 will be in standby and in an inactive state. Should a loss of link occur on fiber port 1, fiber port 2 will be activated within 50 ms. The MAC caching table for fiber port 2 will be cleared and the switch will begin to re-learn Mac address routing. See Redundant Primary for information on link connections.

## ***Redundant Primary (Switch 8)***

**Note:** This switch is used in conjunction with the Fiber Redundancy feature to determine the behaviour after link restoration.

<b>Switch Position</b>	<b>Mode</b>
Up (default)	Disabled
Down	Enabled

**Disabled:** Following the loss of link on fiber port 1 and the activation of fiber port 2, fiber port 2 will remain the primary port until its link is lost at which time a switch over to fiber port 1 will occur.

**Enabled:** Fiber port 1 will be designated as the Primary fiber port. If a loss of link occurs on fiber port 1 which causes a switch over to fiber port 2, the S-1110P will monitor fiber port 1 for link restoration. Once the link is re-established and remains so for 6 seconds, fiber port 1 will be re-activated and fiber port 2 will be put back into stand-by-mode.

# Installing the SFP Fiber Module

SFP models only.

1. Locate the appropriate fiber module and insert the SFP into the opening on the front of the media converter.
2. Ensure the SFP module is properly seated. The release latch of the SFP fiber transceiver must be in the closed (up) position before insertion.
3. The SFP module may be inserted before or after applying power to the media converter.
4. Proceed with cable connections.

# Installing the Duplex Fiber Cable

1. Locate a 1000Base-X compliant duplex (2 strands) fiber cable with appropriate connectors.
2. Connect the fiber cables from one media converter to the other media converter/switch/fiber device ensuring that the RX and TX are reversed (crossed) at the opposite end.

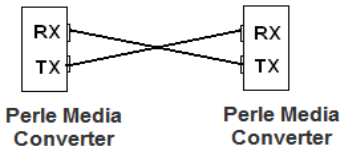

# Installing the Simplex Fiber Cable

1. Locate a 1000Base-X compliant simplex (1 strand) fiber cable with appropriate connectors. Ensure that the TX wavelength matches the RX wavelength at the other end and the RX wavelength matches the TX wavelength at the other end.
2. Connect the fiber cable from one media converter to the other media converter/switch/fiber device.



# Installing the Copper Cable

1. Locate 10/100/1000Base-T compliant copper cables with the appropriate connectors.
2. Connect the RJ-45 cable between the Perle media converter and the device.

**Note:** The Perle media converter supports Auto-MDIX which allows connection of a straight-through or cross-over Ethernet cable. See [Auto-MDIX Jumper Settings](#) in this guide for jumper positions.

## ***Grounding the Media Converter***

If your installation requires additional grounding the following procedure can be followed.

Grounding the chassis requires the following items:

- One grounding lug (not provided).
- One 18 - 12 AWG wire (not provided).
- Cross-head screwdriver (not provided).

**Note:** For your safety, when installing this equipment, always ensure that the chassis ground connection is installed first and disconnected last.

## ***Attaching the Grounding Lug***



1. Attach the grounding lug to one end of an 18-12 AWG wire.

2. Attach the grounding lug to the chassis and secure with the grounding screw(s).

### ***Attaching the Power cord strain relief clip***



1. Feed the power cord through the opening in the power cord relief clip.
2. Attach the power cord relief clip to the chassis and secure with the provided screw.
3. Plug the power cord into the AC power connector at the rear of the chassis.
4. Plug the other end of the power cord into an appropriate power outlet.

## **Powering up the Perle Media Converter**

1. Connect the Perle supplied power adapter to the media converter.
2. Connect the power adapter to a power source.
3. Check that the PWR LED light is lit.

# Operation

## Status LED

The Perle PoE/PoE+10/100/1000 Rate converting Media converters have status LEDs located on the front panel of the unit.

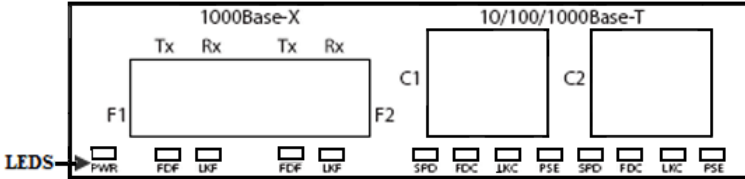

### PWR

**On** – Power is applied to the unit

**Blinking (slow)** – Loopback mode (one or both fiber interfaces are in loopback mode)

**Blinking (fast)** Power On failure. See LED Pattern to determine pattern combination and failure cause

LED Pattern				
FDF	LKF	FDC	PSE	
Off	Off	On	On	SFP incompatible
All other LED patterns				Internal hardware failure

### FDF-1/2 (Fiber 1/2 Duplex)

**On** – Full Duplex

**Off** – Half Duplex

### LKF-1/2 (Status on Fiber Link 1/2)

**On** – Fiber link is present

**Off** – No fiber link present

**Blinking (slow)** – Fiber link appears functional – Fiber link has been brought down by Smart Link Pass-Through

**Blinking (fast)** – Fiber link up and receiving data

**SPD-(Copper Port 1/2)**

**Green** – 1000 Mbps

**Orange** – 100 Mbps

**Off** – 10 Mbps (if link is currently established)

**FDC-1/2 (Duplex on Copper 1/2)**

**On** – Full Duplex Mode

**Off** – Half Duplex Mode

**LKC-1/2 (Link Status on Copper port 1/2)**

**On** – Copper link is present

**Off** – No copper link present

**Blinking (slow)** – Copper link appears functional – Copper link has been brought down by Smart Link Pass-Through.

**Blinking (fast)** – Copper link up and receiving data

**PSE-1/2**

**Solid Green (Active)** – The PSE has successfully detected a compliant PD and is applying power over the UTP.

**Solid Orange (Inactive)** – The PSE is not active. The PSE has been configured to provide power, however

- a compliant PD is not detected - no power applied
- a PSE has turned off power for Reset function

**Off – (Disabled)** The PSE function is disabled in the configuration.

**Error conditions**

A blinking red light is an error condition. The led light will cycle with a 3 second stop interval between the error condition code.

PSE-1 / 2 LED	
1 blink	PD Capacitance too high
2 blinks	PD Resistance too low or short circuit
3 blinks	PD Resistance too high

# Other Features

## ***Auto-MDIX***

Auto-MDIX (automatic medium-dependent interface crossover) detects the signalling on the 10/100/1000BASE-T interface to determine the type of cable connected (straight-through or crossover) and automatically configures the connection.

## ***Pause (IEEE 802.3xy)***

Integrated Pause signalling is an IEEE feature that temporarily suspends data transmission between two devices in the event that one of the devices becomes overwhelmed with data. The Perle media converter can generate and respond to Pause messages. If Auto negotiation is set to On, the media converter will advertise symmetrical and asymmetrical pause. If Auto negotiation is set to Off, the Pause receive and send will be disabled.

# Troubleshooting

## **General**

1. Ensure power is supplied to the media converter. Only the Perle provided power supply may be used.
2. Ensure the remote device's fiber connection type is compatible with the media converter. If using a simplex fiber connection, ensure that you have both an Upstream (U) and Downstream (D) media converter.
3. Ensure all cabling is of the correct type and is in good working order.
4. For duplex fiber connections, ensure the RX and TX has been reversed between the two media converters.

## **No connectivity**

If unable to get full connectivity with all DIP switches in the UP position, this procedure is recommended for troubleshooting.

### **Method 1**

1. Set the Link Mode to Standard on both media converters. Leave all other switches in the Up position.
2. Connect the copper device to the copper port on the media converter. The LKC LED light indicates good copper connection. If the LKC LED is not lit, the check the copper cable and the attached device.
3. Repeat for the far end media converter.
4. Connect the fiber cable to both media converters. The LKF LED indicates good fiber connection. If no LKF LED then check the fiber cabling. Ensure the transmitter and receiver pairs are crossed.
5. Return the units to the desired configuration. Plug the other end of the power cord into an appropriate power outlet.

### **Method 2:**

The fiber connection can also be verified by configuring the remote media converter for loopback mode. The LKF LEDs on both media converters should be lit. Data should pass through the local converter, over the fiber connection to the remote media

converter. At the remote media converter, the data will be looped back and passed through the fiber, back to the local converter and passed to the copper link.

## ***No Power to the PD***

1. Ensure that the PD is compatible with the S-1110P. If the PD is a POE+ device, a POE+ media converter must be used. (S-1110PP)
2. Ensure that the power supply being used, is the one provided with the product
3. If the PD does not support Alternative A (including legacy PD's), the Power Option Jumpers must be set accordingly. Also ensure the correct pin out for the device.
4. For proper detection of different classes of devices, the dip switches must be set correctly.

# Technical Specifications

The following applies to all S-1110P media converters:

**Power Input / Consumption:** 46V DC to 57V DC @ 6 W

**Operating Temperature:** 0°C to 50°C (32°F to 122°F)

**Storage Temperature:** -25°C to 70°C (-13°F to 158°F)

**Operating Humidity:** 5% to 90% non-condensing

**Storage Humidity:** 5% to 95% non-condensing

**Operating Altitude:** Up to 3,048 m (10,000 ft)

**Dimensions:** 150 mm by 95 mm by 26 mm

MTBF 1 copper port	No Power supply	POE	POE+
2 SFP / 1 copper ports	399,432 hours	218,384 hours	79,977 hours
1 SFP / 1 copper ports	410,188 hours	221,560 hours	80,399 hours
SC/ST – 1 copper ports	361,190 hours	206,434 hours	78,317 hours
MTBF 2 copper ports	No Power supply	POE	POE+
2 SFP / 2 copper ports	317,119 hours	191,244 hours	76,026 hours
1 SFP / 2 copper ports	323,861 hours	193,675 hours	76,407 hours
SC/ST – 2 copper ports	292,529 hours	182,017 hours	74,524 hours

## Fiber Optic Specifications:

### 2 Port Models

PoE (P) PoE+ (PP)	Mode	Wavelength (nm)	TX Power (dB)	RX Power (dB)	Budget
S-1110P-M2xx05 S-1110PP-M2xx05	MM	TX: 850 RX: 850t.	Min: -9.5 Max: -4	Min: -17 Max: -3	7.5
S-1110P-S2xx10 S-1110PP-S2xx10	SM	TX: 1310 RX: 1310.	Min: -9.5 Max: -3	Min: -20 Max: -3	10.5



PoE (P) PoE+ (PP)	Mode	Wavelength (nm)	TX Power (dB)	RX Power (dB)	Budget
S-1110P-S1SC10U S-1110PP-S1SC10U	SM	TX: 1310 RX: 1490	Min: -9 Max: -3	Min: -20 Max: -3	11
S-1110P-S1SC10D S-1110PP-S1SC10D	SM	TX: 1490 RX: 1310	Min: -9 Max: 3	Min: -20 Max: -3	11
S-1110P-S1SC20U S-1110PP-S1SC20U	SM	TX: 1310 RX: 1490	Min: -8 Max: -3	Min: -22 Max: -3	14
S-1110P-S1SC20D S-1110PP-S1SC20D	SM	TX: 1490 RX: 1390	Min: -8 Max: -3	Min: -22 Max: -3	14
S-1110P-S2xx40 S-1110PP-S2xx40	SM	TX: 1310 RX: 1310.	Min: -3 Max: 5	Min: -23 Max: -3	20
S-1110P-S1SC40U S-1110PP-S1SC40U	SM	TX: 1310 RX: 1490.	Min: -3 Max: 2	Min: -23 Max: -3	14
S-1110P-S1SC40D S-1110PP-S1SC40D	SM	TX: 1490 RX: 1310	Min: -2 Max: -3	Min: -23 Max: -3 Max: -3	14
S-1110P-S2xx70 S-1110PP-S2xx70	SM	TX: 1550 RX: 1550	Min: -2 Max: 5	Min: -23 Max: -3	21
S-1110P-S1SC80U S-1110PP-S1SC80U	SM	TX: 1510 RX: 1590	Min: -2 Max: 3	Min: -26 Max: -3	24
S-1110P-1SC80D S-1110PP-1SC80D	SM	TX: 1590 RX: 1510	Min: -2 Max: 3	Min: -26 Max: -3	24
S-1110P-S2xx120 S-1110PP-S2xx120	SM	TX: 1550 RX: 1550	Min: -0 Max: 5	Min: -32 Max: -3	32
S-1110P-S1SC120U S-1110PP-S1SC120U	SM	TX: 1590 RX: 1510	Min: -3 Max: 2	Min: -34 Max: -9	31
S-1110P-S1SC120D S-1110PP-S1SC120D	SM	TX: 1510 RX: 1590	Min: -3 Max: 2	Min: -34 Max: -9	31
S-1110P-S2xx160 S-1110PP-S2xx160	SM	TX: 1550 RX: 1550	Min: 2 Max: 5	Min: -34 Max: -9	31
S-1110P-SFP S-1110PP-SFP	SFP	<b>Note 1</b>	<b>Note 1</b>	<b>Note 1</b>	<b>Note</b>

**Note 1:** Fiber characteristics will depend on the SFP fiber module selected

### 3 Port Models

Dual Copper / PoE (DP) Dual Copper / PoE+ (DPP)	Mode	Wavelength (nm)	TX Power (dB)	RX Power (dB)	Budget (dB)
S-1110DP-M2xx05 S-1110DPP-M2xx05	MM	TX: 850 RX: 850	Min: -9.5 Max: -4	Min: -17 Max: -3	7.5
S-1110DP-S2xx10 S-1110DPP-S2xx10	SM	TX: 1310 RX:1310	Min: -9.5 Max: -3	Min: -20 Max: -3	10.5
S-1110DP-S1SC10U S-1110DPP-S1SC10U	SM	TX: 1310 RX:1490	Min: -9 Max: -3	Min: -20 Max: -3	11
S-1110DP-S1SC10D S-1110DPP-S1SC10D	SM	TX:1490 RX:1310	Min: -9 Max: -3	Min: -20 Max: -3	11
S-1110DP-S1SC20U S-1110DPP-S1SC20U	SM	TX: 1310 RX:1490	Min: -8 Max: -3	Min: -22 Max: -3	14
S-1110DP-S1SC20D S-1110DPP-S1SC20D	SM	TX:1490 RX:1310	Min: -8 Max: -3	Min: -22 Max: -3	14
S-1110DP-S2SC40 S-1110DPP-S2SC40	SM	TX: 1310 RX:1310	Min: -3 Max: 5	Min: -23 Max: -3	20
S-1110DP-S2ST40 S-1110DPP-S2ST40	SM	TX: 1310 RX:1310	Min: -3 Max: 5	Min: -23 Max: -3	20
S-1110DP -S2LC40 S-1110DPP -S2LC40	SM	TX: 1310 RX:1310	Min: -3 Max: 2	Min: -23 Max: -3	20
S-1110DP -S1SC40U S-1110DPP -S1SC40U	SM	TX: 1310 RX:1490	Min: -3 Max: 2	Min: -23 Max: -3	14
S-1110DP -S1SC40D S-1110DPP -S1SC40D	SM	TX:1490 RX:1310	Min: -2 Max: -3	Min: -23 Max: -3	14
S-1110DP -S2SC70 S-1110DPP -S2SC70	SM	TX: 1550 RX:1550	Min: -2 Max: 5	Min: -23 Max: -3	21
S-1110DP -S2ST70 S-1110DPP -S2ST70	SM	TX: 1550 RX:1550	Min: 0 Max: 5	Min: -23 Max: -3	23
S-1110DP -S1SC80U S-1110DPP -S1SC80U	SM	TX: 1510 RX:1590	Min: -2 Max: 3	Min: -26 Max: -3	24
S-1110DP -S1SC80D S-1110DPP -S1SC80D	SM	TX:1590 RX:1510	Min: -2 Max: 3	Min: -26 Max: -3	24

Dual Copper / PoE (DP) Dual Copper / PoE+ (DPP)	Mode	Wavelength (nm)	TX Power (dB)	RX Power (dB)	Budget (dB)
S-1110DP -S2xx120 S-1110DPP -S2xx120	SM	TX: 1550 RX:1550	Min: 0 Max: 5	Min: -32 Max: -9	32
S-1110DP -S1SC120U S-1110DPP -S1SC120U	SM	TX: 1590 RX:1510	Min: -3 Max: 2	Min: -34 Max: -9	31
S-1110DP -S1SC120D S-1110DPP -S1SC120D	SM	TX:1510 RX:1590	Min: -3 Max: 2	Min: -34 Max: -9	31
S-1110DP -S2xx160 S-1110DPP -S2xx160	SM	TX: 1550 RX:1550	Min: 2 Max: 5	Min: -34 Max: -9	32
S-1110DP-SFP S-1110DPP-SFP	SFP	<b>Note 1</b>			31

## Fiber Cabling Requirements:

**MM:** 50/125 microns or 62.5/125 microns

**SM:** 9/125 microns

## Ethernet Copper Cabling Requirements:

- Category 5 UTP or STP
- 24-22 AWG
- Straight through or Ethernet crossover

**Note:** Please refer the product page on the Perle website for the most up to date models and specifications.

<http://www.perle.com/>

# Compliance Information

## FCC

This product has been found to comply with the limits for a Class A digital device, pursuant to Part 15 of the FCC rules. These limits are designed to provide reasonable protection against harmful interference when the equipment is operated in a commercial environment. This equipment generates, uses, and can radiate radio frequency energy and, if not installed and used in accordance with the instructions in this Guide, may cause harmful interference to radio communications. Operation of this equipment in a residential area is likely to cause harmful interference, in which case the user will be required to correct the interference at his/her own expense.

### **EN 55022, Class A**

**WARNING** This is a Class A product. In a domestic environment this product may cause radio interference in which case the user may be required to take adequate measures.

### **EN 55024, Class A**

### **Laser Safety – IEC 60825-1:2007**

This product meets Class I Laser safety requirements per IEC-60825-1:2007 standard and complies with FDA/CDRH 21 CFR1040.10 and 21CFR1040.11.

**WARNING:** Visible and invisible laser radiation may be present when cables are not connected. Do not stare into the beam or view the beam directly with optical instruments. Failure to observe this warning could result in an eye injury or blindness.

**WARNING:** Use of controls, adjustments or the performance of procedures other than those specified herein may result in hazardous radiation exposure.

## ***Warranty / Registration***

Perle's standard Lifetime Warranty provides customers with return to factory repairs for Perle products that fail under the conditions of the warranty coverage. Details can be found at:

[http://www.perle.com/support\\_services/warranty.shtml](http://www.perle.com/support_services/warranty.shtml)

## **Contacting Technical Support**

Contact information for the Perle Technical Assistance Center (PTAC) can be found at the link below. A Technical Support Query may be made via this web page.

[www.perle.com/support\\_services/support\\_request.shtml](http://www.perle.com/support_services/support_request.shtml)

## **Copyright**

© 2011 Perle Systems Limited

All rights reserved. No part of this document may be reproduced or used in any form without written permission from Perle Systems.

## Free Manuals Download Website

<http://myh66.com>

<http://usermanuals.us>

<http://www.somanuals.com>

<http://www.4manuals.cc>

<http://www.manual-lib.com>

<http://www.404manual.com>

<http://www.luxmanual.com>

<http://aubethermostatmanual.com>

Golf course search by state

<http://golfingnear.com>

Email search by domain

<http://emailbydomain.com>

Auto manuals search

<http://auto.somanuals.com>

TV manuals search

<http://tv.somanuals.com>