

KENWOOD

CD-RECEIVER

KDC-X8529 KDC-MP8029

INSTRUCTION MANUAL

KENWOOD CORPORATION



PHATNOISE

© B64-2964-00/01 (MW)

Download from www.Somanuals.com. All Manuals Search And Download.

Contents

Safety precautions	4	CD/Audio file/External disc control features	25
Notes	5	Playing CD & Audio file	
About CDs	6	Playing External Disc	
About AAC, MP3 and WMA	7	Fast Forwarding and Reversing	
Notes on Multi-function Key System	8	Track/File Search	
General features	9	Disc Search/Folder Search	
Power		Direct Track/File Search	
Selecting the Source		Direct Disc Search	
Volume		Track/File/Disc/Folder Repeat	
Attenuator		Scan Play	
Audio Control		Random Play	
Audio Setup		Magazine Random Play	
Equalizer Control		Disc Random Play	
Speaker Setting		Folder Select	
Subwoofer Output		Switching the Play mode	
Display Mode Switching		Letter Seek	
Graphic part/ Spectrum Analyzer Display Switching		Text/Title Scroll	
Wallpaper selecting			
Text Display Switching (Display Type B)			
Text Display Switching (Display Type C/ Display Type D)			
Font Color Select			
G-Analyzer display Switching			
TEL Mute			
Faceplate Angle Adjustment			
Station/Disc Naming (SNPS/DNPS)			
Theft Deterrent Faceplate			
Tuner & TV features	22	Menu system	30
Tuning		Menu System	
Tuning Mode		Security Code	
Direct Access Tuning		Touch Sensor Tone	
Station Preset Memory		Manual Clock Adjustment	
Auto Memory Entry		Date Adjustment	
Preset Tuning		Date Mode	
Frequency Step Setting		DSI (Disabled System Indicator)	
TV Tuning		Selectable Illumination	
TV channel Preset Memory		Dimmer	
Preset TV Tuning		Switching preout	
Direct TV Tuning		Built-in Amp Setting	
		G-Counter Level setup	
		G-Analyzer Reset	
		G-Analyzer Calibration setup	
		G-Analyzer Stop Watch	
		Dual Zone System Setting	
		B.M.S. (Bass Management System)	
		B.M.S. Frequency Offset	
		AMP Control	
		CRSC (Clean Reception System Circuit)	
		Auxiliary Input Display Setting & Station/Disc Naming	
		Text Scroll	
		Built-in Auxiliary input Setting	
		CD Read Setting	
		Voice Index	
		ACDrive firmware version display	
		Unique ID display	
		Audio Preset Memory	
		Audio Preset Call	

Basic Operations of remote	38
Accessories/ Installation Procedure	40
Connecting Wires to Terminals	41
Installation	42
Removing the Unit	44
Troubleshooting Guide	45
Specifications	49

Safety precautions

▲WARNING

To prevent injury or fire, take the following precautions:

- To prevent a short circuit, never put or leave any metallic objects (such as coins or metal tools) inside the unit.
- Never watch the G-Analyzer Display screen when you are driving. Otherwise, a car accident may result.

▲CAUTION

To prevent damage to the machine, take the following precautions:

- Make sure to ground the unit to a negative 12V DC power supply.
- Do not install the unit in a spot exposed to direct sunlight or excessive heat or humidity. Also avoid places with too much dust or the possibility of water splashing.
- Do not set the removed faceplate or the faceplate case in areas exposed to direct sunlight, excessive heat or humidity. Also avoid places with too much dust or the possibility of water splashing.
- To prevent deterioration, do not touch the terminals of the unit or faceplate with your fingers.
- Do not subject the faceplate to excessive shock, as it is a piece of precision equipment.
- When replacing a fuse, only use a new one with the prescribed rating. Using a fuse with the wrong rating may cause your unit to malfunction.
- Do not apply excessive force to the open faceplate or place objects on it. Doing so will cause damage or breakdown.
- Do not use your own screws. Use only the screws provided. If you use the wrong screws, you could damage the unit.

Attach the panel while you are on the vehicle

The panel lock arm will be appeared when the panel is removed. Therefore, the panel must be attached during the driving.

Do Not Load 8 cm (3 in.) CDs in the CD slot

If you try to load a 8 cm (3 in.) CD with its adapter into the unit, the adapter might separate from the CD and damage the unit.

About CD players/disc changers connected to this unit

KENWOOD disc changers/ CD players released in 1998 or later can be connected to this unit.

Refer to the catalog or consult your Kenwood dealer for connectable models of disc changers/ CD players.

Note that any KENWOOD disc changers/ CD players released in 1997 or earlier and disc changers made by other makers cannot be connected to this unit.

Unsupported connection may result in damage. Setting the "O-N" Switch to the "N" position for the applicable KENWOOD disc changers/ CD players.

The functions that can be used and the information that can be displayed will differ depending on the models being connected.



- You can damage both your unit and the CD changer if you connect them incorrectly.

Lens Fogging

Right after you turn on the car heater in cold weather, dew or condensation may form on the lens in the CD player of the unit. Called lens fogging, CDs may be impossible to play. In such a situation, remove the disc and wait for the condensation to evaporate. If the unit still does not operate normally after a while, consult your Kenwood dealer.

About "Media Manager" of PC application attached to KDC-X8529

- "Media Manager" is recorded in the CD-ROM attached to this unit.
- Refer to the attached installation manual for the installation method of "Media Manager".
- Refer to the user's manual recorded in the installation CD-ROM and Help of "Media Manager" for the operation method of "Media Manager".
- The unit can play CD (hereafter called "ACDrive disc") created by "Media Manager".
- Refer to the following site for the updated information of "Media Manager".
<http://www.kenwood.mediamanager.jp>
- Contact Kenwood for the function and operation of the "Media Manager".
- "Media Manager" is a product of PhatNoise.

The "AAC" logo is trademark of Dolby Laboratories.

Notes

- If you experience problems during installation, consult your Kenwood dealer.
- If the unit fails to operate properly, press the Reset button. The unit returns to factory settings when the Reset button is pressed.
- Press the reset button if the disc auto changer fails to operate correctly. Normal operation should be restored.

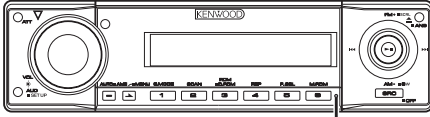

Reset button

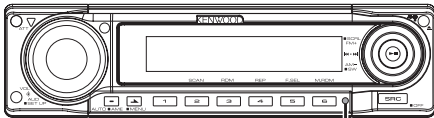

Reset button

- The characters which can be displayed by ISO 8859-1.
- The illustrations of the display and the panel appearing in this manual are examples used to explain more clearly how the controls are used. Therefore, what appears on the display in the illustrations may differ from what appears on the display on the actual equipment, and some of the illustrations on the display may represent something impossible in actual operation.

Cleaning the Unit

If the faceplate of this unit is stained, wipe it with a dry soft cloth such as a silicon cloth.

If the faceplate is stained badly, wipe the stain off with a cloth moistened with neutral cleaner, then wipe neutral detergent off.



- Applying spray cleaner directly to the unit may affect its mechanical parts. Wiping the faceplate with a hard cloth or using a volatile liquid such as thinner or alcohol may scratch the surface or erase characters.

Cleaning the Faceplate Terminals

If the terminals on the unit or faceplate get dirty, wipe them with a dry, soft cloth.

About DAB Tuner control

Refer to [A] group on the Instruction manual of DAB Tuner KTC-9090DAB (optional accessory) for the control method of DAB Tuner function.

However, the following control methods of the function for this unit may be differed from the Instruction manual; therefore, refer to the following supplemental instruction.

<Auto Ensemble Memory Entry>

1. Select the preset band for Auto Ensemble Memory Entry.
2. Press the [AME] button for at least 2 seconds. Open Auto Ensemble Memory Entry. After storing in the memory finishes, the number of the pre-set buttons and the ensemble label are displayed.

<Searching by programme type and language> and <Languages to be displayed> in

<Programme Type (PTY) Function>

At the operation to press [DISP] button, press [TI] button.

The marking of products using lasers (Except for some areas)

**CLASS 1
LASER PRODUCT**

The label is attached to the chassis/case and says that the component uses laser beams that have been classified as Class 1. It means that the unit is utilizing laser beams that are of a weaker class. There is no danger of hazardous radiation outside the unit.

About CDs

Handling CDs

- Don't touch the recording surface of the CD.



- CD-R and CD-RW are easier to damage than a normal music CD. Use a CD-R or a CD-RW after reading the caution items on the package etc.
- Don't stick tape etc. on the CD. Also, don't use a CD with tape stuck on it.

When using a new CD

If the CD center hole or outside rim has burrs, use it after removing them with a ball pen etc.

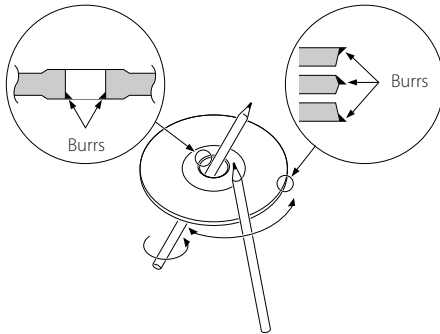

CD accessories

Don't use disc type accessories.

CD cleaning

Clean from the center of the disc and move outward.

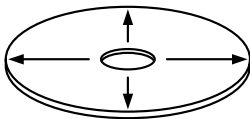

Removing CDs

When removing CDs from this unit pull them out horizontally.

CDs that can't be used

- CDs that aren't round can't be used.

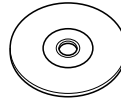

- CDs with coloring on the recording surface or that are dirty can't be used.
- This unit can only play the CDs with



It may not correctly play discs which do not have the mark.

- A CD-R or CD-RW that hasn't been finalized can't be played. (For the finalization process refer to your CD-R/CD-RW writing software, and your CD-R/CD-RW recorder instruction manual.)

CD storage

- Don't place them in direct sunlight (On the seat or dashboard etc.) and where the temperature is high.
- Store CDs in their cases.

About AAC, MP3 and WMA

The playable AAC/MP3/WMA file (hereafter called Audio file) and the media format has the following limitation. The Audio file, which is out of the specification, may not be played normally, or the file and folder names may not be displayed correctly.



- Attach the correct extension for the Audio file (AAC: ".M4A", MP3: ".MP3", WMA: ".WMA")
- Do not attach the extensions to the other files besides the Audio file. If it is attached, the file, which is not the Audio file, will be played and outputs the loud noise, and then the speaker will be damaged.
- The files with copy protection cannot be played.

Playable AAC file

- ".m4a" file encoded by AAC-LC format.
Refer to <http://www.kenwood.mediamanager.jp> for the details.

Playable MP3 file

- MPEG 1/2 Audio Layer 3 file
- Transfer bit rate: 8-320 kbps
- Sampling frequency
KDC-MP8029: 8, 11.025, 12, 16, 22.05, 24, 32, 44.1, 48 kHz
KDC-X8529: 16, 22.05, 24, 32, 44.1, 48 kHz

Playable WMA file

- The file in accordance with Windows Media Audio (Except for the file for Windows Media Player 9 or after which applies the new functions)
- Transfer bit rate: 48-192 kbps
- Sampling frequency: 32, 44.1, 48 kHz

Playable media

- CD-ROM, CD-R, CD-RW



- Depending on the writing software, it may not be possible to use quick formatted CD-RW discs.
- When recording to the media up to the maximum capacity at once, the writing soft is set to "Disc at once".

Playable disc format

- ISO 9660 Level 1/2
- Joliet
- Romeo
- Long file name.

The maximum number of characters for display

File/Folder name:

KDC-MP8029: 64 characters

KDC-X8529: 128 characters

MP3 ID3 Tag/ WMA Contents property/

AAC song information (KDC-X8529 only): 30 characters



- File/Folder name is the number of the characters including the extensions.
- MP3 ID3 Tag can only display the tag of Ver1.X. (KDC-MP8029 only)
- AAC ID3 Tag cannot be displayed.

Limitation of structure for the file and the folder

- Maximum number of directory levels: 8
- Maximum number of folders: 100
- Maximum number of files per folder:
KDC-MP8029: 255
KDC-X8529: 4096

Playing order of the Audio file

The Audio file is played in the order which is written by writing soft. You may be able to set the playing order by writing the play sequence numbers such as "01" to "99" at the beginning of the file name.

Example

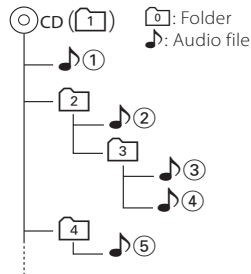

Playing order

Playing order after 🎵1 play.

⇒ 🎵2, 🎵3, 🎵4, 🎵5...

File search

Forward file search during 🎵3 play.

Push the Control knob to [▶▶] ⇒ 🎵4

Folder search

Forward folder search during 🎵2 play.

Push the Control knob to [FM] ⇒ [3], [4]...

Folder select

When it is set to directory [4], skip to the folder before the same level by folder select.

Push the Control knob to [◀◀] ⇒ [2]

When it is set to directory [3], makes the level up by folder select.

Push the Control knob to [AM] ⇒ [2]

Notes on Multi-function Key System

Multi-function Key System serves to control various functions with the [1] — [6] buttons.

The basic operation of the Multi-function Key System is described below.

What's the Multi-function Key System?

This unit is equipped with the Multi-function Key System that enables the operation of multiple functions with one button.

For example, you can enter the Display Control Mode or turn ON/OFF the Random Play by pressing the [3] button during CD play.

Setting each function

The function display will show the controllable function of the [1] — [6] button above the button. Pressing the [1] — [6] button below the desired function enables the setting of the function.

Displaying the desired function

If five or more functions are available to be set with the [1] — [6] button, they are divided into multiple function groups (referred to as sections in this manual) for registration.

Press the [NEXT] button to switch the sections.

Example: Function display of CD & External disc source

Example: KDC-X8529

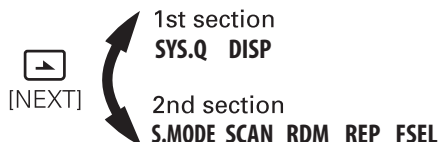

Real operational example of the Multi-function Key System

Example: Turning ON/OFF the Random Play during CD play.

1. Show the function display of the Random Play.
If "RDM" is not shown in the display, press the [NEXT] button to switch the sections until the "RDM" function display is shown above the [3] button.
2. Turn ON/OFF the Random Play.
Press the [3] button.
Each time the [3] button under the "RDM" function display is pressed the Random Play is turned ON/OFF.

Example: KDC-X8529

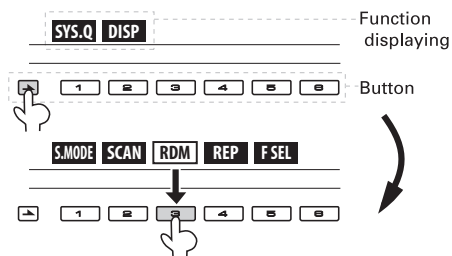

General features

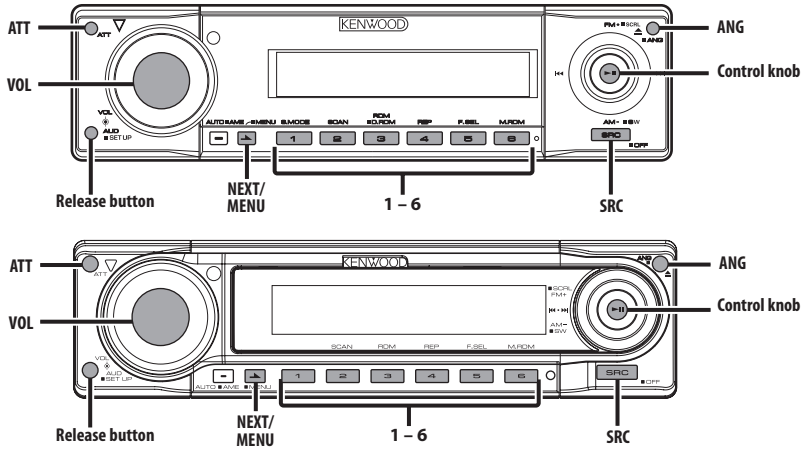

Power

Turning ON the Power

Press the [SRC] button.



- When the power is ON, the <Security Code> (page 30) is displayed as "CODE ON" or "CODE OFF".

Turning OFF the Power

Press the [SRC] button for at least 1 second.

Selecting the Source

Press the [SRC] button.

Source required	Display
Tuner	"TUNER"
CD	"Compact Disc"
TV (Optional accessory)	"TV"
External disc (Optional accessory)	"CD Changer"
Auxiliary input	"AUX"
Auxiliary input (Optional accessory)	"AUX EXT"
Standby (Illumination only mode)	"STANDBY"

Volume

Increasing Volume

Turn the [VOL] knob clockwise.

Decreasing Volume

Turn the [VOL] knob counterclockwise.

Attenuator

Turning the volume down quickly.

Press the [ATT] button.

Each time the button is pressed, the Attenuator turns ON and OFF.

When it's ON, "ATT" is displayed.

Audio Control

1 Select the source for adjustment

Press the [SRC] button.

2 Enter Audio Control mode

Press the [VOL] knob.

3 Select the Basic Audio item for adjustment

Press the [VOL] knob.

Each time the knob is pressed, the items that can be adjusted switch as shown below.

4 Adjust the Basic Audio item

Turn the [VOL] knob.

Adjustment Item	Display	Range
Rear Volume *1	"Rear Volume"	0 — 35
Subwoofer level*2,3,4	"Sub-WLevel"	-15 — +15
Bass level*5	"Bass Level"	-8 — +8
Middle level*5	"Middle Level"	-8 — +8
Treble level*5	"Treble Level"	-8 — +8
Balance	"Balance"	Left 15 — Right 15
Fader*4	"Fader"	Rear 15 — Front 15

Exit Audio Control mode



- *1 You can control this item when "2 ZONE" of <Audio Setup> (page 10) is set to "ON".
- *2 You can control this item when <Switching preout> (page 32) is set to "SWPRE Sub-W". (KDC-MP8029 only)
- *3 You can control this item when <Subwoofer Output> (page 12) is set to "SW ON".
- *4 You can control this item when "2 ZONE" of <Audio Setup> (page 10) is set to "OFF".
- *5 These items can be adjusted in details by the following methods.
- *5 Source tone memory: The set up value is put in the memory per source. (Detail Audio item is included)

5 Exit Audio Control mode

Press any button.

Press the button which is not [VOL] knob and [ATT]/[ANG] button.

Adjust the detail of Audio Control

1 Select the Audio item for adjustment

By referring to the step 1 — 3 above, select the desired item to be set in detail from the items marked with *5.

2 Enter Detail adjustment mode of Audio Control

Press the [VOL] knob for at least 1 second.

3 Select the Detail Audio item for adjustment

Press the [VOL] knob.

Each time the knob is pressed, the items that can be adjusted switch as shown below.

4 Adjust the Detail Audio item

Turn the [VOL] knob.

Bass level

Adjustment Item	Display	Range
Bass Center Frequency	"Bass FRQ"	40/50/60/70/80/100/120/150 Hz
Bass Q Factor	"Bass Q Factor"	1.00/1.25/1.50/2.00
Bass Extend	"Bass EXT"	OFF/ON

Middle level

Adjustment Item	Display	Range
Middle Center Frequency	"Middle FRQ"	0.5/1.0/1.5/2.0 kHz
Middle Q Factor	"Middle Q Factor"	1.00/2.00

Treble level

Adjustment Item	Display	Range
Treble Center Frequency	"Treble FRQ"	10.0/12.5/15.0/17.5 kHz

5 Exit the Detail Audio Control mode

Press the [VOL] knob for at least 1 second.



- When the Bass Extend is set to ON, low frequency response is extended by 20%.
- You can exit the Audio Control mode at anytime by pressing any button except for [VOL] and [ATT]/[ANG] buttons.

Audio Setup

Setting the Sound system, such as Cross over Network.

1 Select the source for adjustment

Press the [SRC] button.

2 Enter Audio Setup mode

Press the [VOL] knob for at least 1 second.

3 Select the Audio Setup item for adjustment

Press the [VOL] knob.

Each time the knob is pressed, the items that can be adjusted switch as shown below.

4 Setup the Audio item

Turn the [VOL] knob.

Adjustment Item	Display	Range
Front High Pass Filter*2	"HPF-F Fc"	Through/40/60/80/100/120/ 150/180/220 Hz
Rear High Pass Filter*2	"HPF-R Fc"	Through/40/60/80/100/120/ 150/180/220 Hz
Low Pass Filter*1,2	"LPF-SW"	50/60/80/100/120/ Through Hz
Subwoofer Phase*1,2	"SW Phase"	Reverse (180°)/Normal (0°)
Volume offset	"Vol-Offset"	-8 — 0
Loudness	"LOUD"	OFF/ON
Dual Zone System	"2 ZONE"	OFF/ON



- Volume offset: Each source's volume can be set as a difference from the basic volume.
- Loudness: Compensating for low and high tones during low volume.
- *1 You can control this item when <Switching preout> (page 32) is set to "SWPRE Sub-W". (KDC-MP8029 only)
- *1 You can control this item when <Subwoofer Output> (page 12) is set to "SW ON".
- *2 You can control this item when "2 ZONE" of <Audio Setup> is set to "OFF".
- Dual Zone System
 - Main source and sub source (Auxiliary input) output Front channel and Rear channel separately.
 - The channel of sub source is set up by <Dual Zone System Setting> (page 34).
 - Main source is selected by [SRC] button.
 - The volume of Front channel is adjusted by [VOL] knob.
 - The volume of Rear channel is adjusted by <Audio Control> (page 10).
 - The Audio Control has no effect on sub source.
- The Dual Zone System can be used with the Auxiliary input sources shown below.
 - Internal auxiliary input

5 Exit Audio Setup mode

Press [VOL] knob for at least 1 second.

Equalizer Control

1 Select the source for adjustment

Press the [SRC] button.

2 Select the key function section

Press the [NEXT] button.

Repeatedly press the button until "SYS.Q" is displayed above the [1] button.

Refer to <Notes on Multi-function Key System> (page 8).

3 Enter Equalizer Control mode

Press the [1] ("SYS.Q") button.

4 Select the Equalizer Control item for adjustment

Press the [1] ("SYS.Q") button.

5 Adjust the Equalizer control item

Push the Control knob to [◀◀] or [▶▶].

Each time the knob is pushed, the setting switches as shown below.

Sound setting	Display
User memory	"USER"
Rock	"ROCK"
Pops	"POPS"
Easy	"EASY"
Top 40	"TOP 40"
Jazz	"JAZZ"
Natural	"NATURAL"



- User memory:
 - The values set on the <Audio Control> (page 10).
- Each setting value is changed with the <Speaker Setting> (page 12).
 - First, select the speaker type with the Speaker setting.

General features

Speaker Setting

Fine-tuning so that the System Q value is optimal when setting the speaker type.

1 Enter Standby

Press the [SRC] button.

Select the "STANDBY" display.

2 Enter Speaker Setting mode

Press the [VOL] knob.

"SP SEL" is displayed.

3 Select the Speaker type

Turn the [VOL] knob.

Each time the knob is turned, the setting switches as shown below.

Speaker type	Display
OFF	"OFF"
For 5 & 4 in. speaker	"5/4 inch"
For 6 & 6x9 in. speaker	"6x9/6 inch"
For the OEM speaker	"O.E.M."

4 Exit Speaker Setting mode

Press the [VOL] knob.

Subwoofer Output

Turning the Subwoofer output ON or OFF.

Hold down on [AM] of the Control knob for at least 1 second.

Each time the button is pressed, Subwoofer output switches ON and OFF.

When it's ON, "SW ON" is displayed.



- You can control this function when <Switching preout> (page 32) is set to "SWPRE Sub-W". (KDC-MP8029 only)
- You can control this item when "2 ZONE" of <Audio Setup> (page 10) is set to "OFF".

Display Mode Switching

Switching the display mode.

1 Select the key function section

Press the [NEXT] button.

Repeatedly press the button until "DISP" is displayed above the [2] button.

Refer to <Notes on Multi-function Key System> (page 8).

2 Enter display control mode

Press the [2] ("DISP") button.



3 Select the display mode

Press the [1] ("MODE") button.

4 Select the display Type

Push the Control knob to [◀◀] or [▶▶].

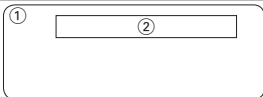
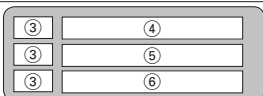
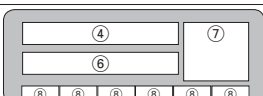
Each time the knob is pushed, the display mode switches as shown below.

Display Mode	Display
"Display Type A"	
"Display Type B"	
"Display Type C"	
"Display Type D"	
"Display Type E"*	

- Graphic display part
- Text display part
- Text icon display part
- Upper text display part
- Middle text display part
- Lower text display part
- Source icon display part
- Function item display
- G-Analyzer display part



- * Function of the KDC-X8529

5 Exit display control mode Press the [6] ("RTN") button.



- Under the display type other than "Display Type D", the function item is not displayed. When the display type other than "Display Type D" is selected, press [1] to [6] buttons or [NEXT] button. The function item will be displayed approximately 5 seconds.
- The information can be switched by the Display Type. Refer to the page on the following table for the methods to switch by the Display Type.

Display Type	A	B	C	D	E
Graphic ①	13	13	—	—	—
Text ②	—	14	—	—	—
Upper ④	—	—	15	15	—
Middle ⑤	—	—	15	—	—
Lower ⑥	—	—	15	15	—
G-Analyzer ⑨	—	—	—	—	18

Display Type A/ Display Type B

Graphic part/ Spectrum Analyzer Display Switching

Switching the graphic Display/ Spectrum analyzer display.

1 Select the key function section Press the [NEXT] button.

Repeatedly press the button until "DISP" is displayed above the [2] button.
Refer to <Notes on Multi-function Key System> (page 8).

2 Enter display control mode Press the [2] ("DISP") button.

3 Select the display mode Press the [1] ("MODE") button.

4 Select the display Type Push the Control knob to [◀◀] or [▶▶]. Select the "Display Type A"/ "Display Type B" display.

5 Select the graphic/ spectrum analyzer display Press the [3] ("Graph") button.

6 Select the graphic/ spectrum analyzer display part display Push the Control knob to [◀◀] or [▶▶].

Each time the button is pressed, the graphic display/ spectrum analyzer display switches as shown below.

Graphic display/ Spectrum Analyzer display
Movie 1
Movie 2
Movie 3*
Spectrum analyzer 1*
Spectrum analyzer 2*
Spectrum analyzer 3*
Spectrum analyzer 4*
Spectrum analyzer 5*
Wallpaper



- * Function of the KDC-X8529
- KDC-MP8029 doesn't display the Spectrum analyzer.

7 Exit display control mode Press the [6] ("RTN") button.



- The setting of this function is available while "Display Type A"/ "Display Type B" is selected for the Display mode.

General features

Display Type A/ Display Type B

Wallpaper selecting

Select a wallpaper to display when Display Type is set to "Display Type A"/ "Display Type B".

1 Select the wallpaper display

Refer to <Graphic part/ Spectrum Analyzer Display Switching> (page 13).

2 Select the wallpaper

Display the wallpapers one after another and select one

1 Turn the wallpaper scan ON.

Press the Control knob.

Each time the knob is pressed, the Wallpaper scan is turned ON and OFF.

When it's ON, "SCAN" is displayed.

When it's ON, each wallpaper is displayed every several seconds.

2 At the wallpaper you want to display.

Press the Control knob.

Select wallpaper manually

1 Turn the wallpaper scan OFF.

Press the Control knob.

Each time the knob is pressed, the Wallpaper scan is turned ON and OFF.

2 Select the wallpaper.

Push the Control knob to [FM] or [AM].

Each time the knob is pushed, the Wallpaper changes.

3 Exit Display Control mode

Press the [6] ("RTN") button.

Display Type B

Text Display Switching

Switching the text display.

1 Select the key function section

Press the [NEXT] button.

Repeatedly press the button until "DISP" is displayed above the [2] button.

Refer to <Notes on Multi-function Key System> (page 8).

2 Enter display control mode

Press the [2] ("DISP") button.

3 Select the display mode

Press the [1] ("MODE") button.

4 Select the display Type

Push the Control knob to [◀◀] or [▶▶].

Select the "Display Type B" display.

5 Enter text select mode

Press the [2] ("TEXT") button.

6 Select the text

Push the Control knob to [◀◀] or [▶▶].

Refer to the table described later for setting items.

7 Exit Display Control mode

Press the [6] ("RTN") button.

In Tuner source

Information	Display
Station name	"BAND+ch+SNPS"
Frequency	"BAND+ch+FREQ"
Clock	"Clock"
Date	"Date"

In CD & External disc source

Information	Display
Disc title	"Disc Title"*
Track title	"Track Title"*
Track number & Play time	"P-Time"
Disc name	"DNPS"
Clock	"Clock"
Date	"Date"

In Audio file source

Information	Display
Song title & Artist name	"Title/Artist"*
Album name & Artist name	"Album/Artist"*
Folder name	"Folder Name"
File name	"File Name"
Play time & File number	"P-Time"
Clock	"Clock"
Date	"Date"

In Auxiliary input source

Information	Display
Auxiliary input name	"AUX Name"/"AUX EXT"
Clock	"Clock"
Date	"Date"

In Standby

Information	Display
Standby	"STANDBY"
Clock	"Clock"
Date	"Date"



- Auxiliary input name is displayed for the Auxiliary input source.
- * If the contents of the information cannot be displayed, Play time or Frequency is displayed.
- When LX-AMP is connected, the item setup by the Display mode of LX-AMP is displayed.
- File number at Audio file displays the last 3 digits when it exceeds 1000 songs (KDC-X8529 only).
- Album name cannot be displayed in WMA file. (KDC-MP8029 only)
- Song title, Artist name, and Album name cannot be displayed in AAC file. (KDC-MP8029 only)

Display Type C/ Display Type D

Text Display Switching

Switching the text display.

1 Select the key function section

Press the [NEXT] button.

Repeatedly press the button until "DISP" is displayed above the [2] button.

Refer to <Notes on Multi-function Key System> (page 8).

2 Enter display control mode

Press the [2] ("DISP") button.

3 Select the display mode

Press the [1] ("MODE") button.

4 Select the display Type

Push the Control knob to [◀◀] or [▶▶].

Select the "Display Type C"/"Display Type D" display.

5 Enter text select mode

Press the [2] ("TEXT") button.

6 Select the text display part

Push the Control knob to [FM] or [AM].

The cursor (➡) moves to the selected text display part.

Select the text

Push the Control knob to [◀◀] or [▶▶].

Refer to the table described later for setting items.

7 Exit Display Control mode

Press the [6] ("RTN") button.



- The information displayed in Upper text display part, Middle text display part and Lower text display part can be switched when "Display Type C" is selected.
- The information displayed in Upper text display part and Lower text display part can be switched when "Display Type D" is selected.
- Same information cannot be displayed in Upper text display part, Middle text display part and Lower text display part. However, the blank display is able to have multiple selections.
- Album name cannot be displayed in WMA file. (KDC-MP8029 only)
- KDC-MP8029 doesn't display the Spectrum analyzer.
- Song title, Artist name, and Album name cannot be displayed in AAC file. (KDC-MP8029 only)
- When LX-AMP is connected, the item setup by the Display mode of LX-AMP is displayed.

General features

The text display in the Upper text display part

In Tuner source

Information	Display
Station name	"BAND+ch+SNPS"
Frequency	"BAND+ch+FREQ"
Spectrum Analyzer & Clock	"Speana/Clock"
Date	"Date"

In CD & External disc source

Information	Display
Disc title	"Disc Title"*
Track title	"Track Title"*
Track number & Play time	"P-Time"
Disc name	"DNPS"
Spectrum Analyzer & Clock	"Speana/Clock"
Date	"Date"

In Audio file source

Information	Display
Song title & Artist name	"Title/Artist"*
Album name & Artist name	"Album/Artist"*
Folder name	"Folder Name"
File name	"File Name"
Play time & File number	"P-Time"
Spectrum Analyzer & Clock	"Speana/Clock"
Date	"Date"

In Standby

Information	Display
Standby	"STANDBY"
Clock	"Clock"
Date	"Date"

In Auxiliary input source

Information	Display
Auxiliary input name	"AUX Name" / "AUX EXT"
Spectrum Analyzer & Clock	"Speana/Clock"
Date	"Date"



- Auxiliary input name is displayed for the Auxiliary input source.
- * If the contents of the information cannot be displayed, Play time is displayed.
- File number at Audio file displays the last 3 digits when it exceeds 1000 songs (KDC-X8529 only).

The text display in the Middle text display part (Display Type C)

In Tuner source

Information	Display
Spectrum Analyzer & Clock	"Speana/Clock"
Date	"Date"
Blank	"Blank"

In CD & External disc source

Information	Display
Spectrum Analyzer & Clock	"Speana/Clock"
Date	"Date"
Blank	"Blank"
Disc title	"Disc Title"*
Track title	"Track Title"*
Disc name	"DNPS"

In Audio file source

Information	Display
Spectrum Analyzer & Clock	"Speana/Clock"
Date	"Date"
Blank	"Blank"
Song title & Artist name	"Title/Artist"*
Album name & Artist name	"Album/Artist"*
Folder name	"Folder Name"
File name	"File Name"

Standby source

Information	Display
Clock	"Clock"
Date	"Date"
Blank	"Blank"

In Auxiliary input

Information	Display
Spectrum Analyzer & Clock	"Speana/Clock"
Date	"Date"
Blank	"Blank"



- * If the contents of the information cannot be displayed, Kenwood Logo displayed.

The text display in the Lower text display part

In Tuner source

Information	Display
Indicator	"Indicator"
Spectrum Analyzer & Clock	"Speana/Clock"
Date	"Date"
Blank	"Blank"

In CD & External disc source

Information	Display
Indicator	"Indicator"
Spectrum Analyzer & Clock	"Speana/Clock"
Date	"Date"
Blank	"Blank"
Disc title	"Disc Title"*
Track title	"Track Title"*
Disc name	"DNPS"

In Audio file source

Information	Display
Indicator	"Indicator"
Spectrum Analyzer & Clock	"Speana/Clock"
Date	"Date"
Blank	"Blank"
Song title & Artist name	"Title/Artist"*
Album name & Artist name	"Album/Artist"*
Folder name	"Folder Name"
File name	"File Name"

Standby source

Information	Display
Indicator	"Indicator"
Clock	"Clock"
Date	"Date"
Blank	"Blank"

In Auxiliary input

Information	Display
Indicator	"Indicator"
Spectrum Analyzer & Clock	"Speana/Clock"
Date	"Date"
Blank	"Blank"



- * If the contents of the information cannot be displayed, indicator displayed.

General features

Display Type C / Display Type D

Font Color Select

Selecting the display font color.

1 Select the key function section

Press the [NEXT] button.

Repeatedly press the button until "DISP" is displayed above the [2] button.

Refer to <Notes on Multi-function Key System> (page 9).

2 Enter display control mode

Press the [2] ("DISP") button.

3 Select the display mode

Press the [1] ("MODE") button.

4 Select the display Type

Push the Control knob to [◀◀] or [▶▶].

Select the "Display Type C"/"Display Type D" display.

5 Enter Font color select mode

Press the [4] ("COLOR") button.

6 Select the text display part

Push the Control knob to [FM] or [AM].

The cursor (➡) moves to the selected text display part.

Select the Font Color

Push the Control knob to [◀◀] or [▶▶].

7 Exit display control mode

Press the [6] ("RTN") button.

Function of the KDC-X8529

Display Type E

G-Analyzer display Switching

Switches G-Analyzer display when the Display type is set to "Display Type E". (G: gravity)



- Before switching G-Analyzer display, <G-Counter Level set> (page 33) and <G-Analyzer Calibration set> (page 33) are required to be setup.

1 Select the key function section

Press the [NEXT] button.

Repeatedly press the button until "DISP" is displayed above the [2] button.

Refer to <Notes on Multi-function Key System> (page 8).

2 Enter display control mode

Press the [2] ("DISP") button.

3 Select the display mode

Press the [1] ("MODE") button.

4 Select the display Type

Push the Control knob to [◀◀] or [▶▶].

Select the "Display Type E" display.

5 Enter G-Analyzer display select mode

Press the [3] ("GMENU") button.

6 Select the G-Analyzer display

Push the Control knob to [◀◀] or [▶▶].

G-Force Sensor display

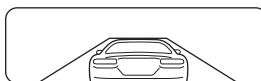

G- Graphic display

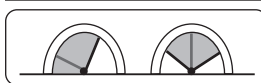

G-Meter display
(Graphic)

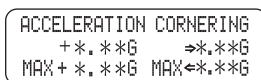

G-Meter display
(Text)



G-Counter display



- G-Graphic display
Displays the condition of G on horizontal direction (e.g; when turning the curve) by the graphic.
- G-Meter display (Graphic)
Displays the maximum value of acceleration G, right direction G, and left direction G by the numerical value.
- G-Meter display (Text)
The maximum value of acceleration G, right direction G, and left direction G is displayed by the numerical value. The value of G is only the reference so it is differed from the actual value.
- G-Counter display
Adds the point of the acceleration level. The point is determined after a lapse of 1 hr drive or at power off (ex; ACC Off), and then it will be displayed by the graph. Furthermore, it displays the average of the past data by the line. (The scale of graph is determined along with the largest point among the past 10 data.)
- The value of G-Meter display and G-Counter display can be reset by <G-Analyzer Reset> (page 33).

7 Exit display control mode

Press the [6] ("RTN") button.

TEL Mute

The audio system automatically mutes when a call comes in.

When a call comes in

"CALL" is displayed.

The audio system pauses.

Listening to the audio during a call

Press the [SRC] button.

The "CALL" display disappears and the audio system comes back ON.

When the call ends

Hang up the phone.

The "CALL" display disappears and the audio system comes back ON.

Faceplate Angle Adjustment

Press the [ANG] button for at least 1 second.



- Do not apply excessive force to the faceplate. It can cause damage.

General features

Station/Disc Naming (SNPS/DNPS)

Attaching a title to a Station or CD.

1 Receive/play the station/disc you want to attach a title to



- A title can't be attached to MD or Audio file media.

2 Enter Menu mode

Press the [MENU] button for at least 1 second.

"Menu" is displayed.

3 Select Name set mode

Push the Control knob to [FM] or [AM].

Select the "Name Set" display.

4 Enter Name set mode

Press the Control knob for at least 1 second.

5 Move the cursor to the enter character position

Push the Control knob to [◀◀] or [▶▶].

6 Select the character type

Press the Control knob.

Each time the knob is pressed, the character type switches as shown below.

Character type

Alphabet upper case

Alphabet lower case

Numbers and symbols

Special characters (Accent characters)

7 Select the characters

Push the Control knob to [FM] or [AM].



- Characters can be entered by using a remote with a numbers buttons.
Example: If "DANCE" is entered.

Character	Button	Times pressed
"D"	[3]	1
"A"	[2]	1
"N"	[6]	2
"C"	[2]	3
"E"	[3]	2

8 Repeat steps 5 through 7 and enter the name.

9 Exit Menu mode

Press the [MENU] button.



- When operation stops for 10 seconds the name at that time is registered, and Name Set mode closes.
- Memory numbers
 - FM/AM: 30 stations
 - Internal CD player: 10 discs
 - External CD changer/ player: Varies according to the CD changer/ player. Refer to the CD changer/ player manual.
- The title of station/CD can be changed by the same operation used to name it.

Theft Deterrent Faceplate

The faceplate of the unit can be detached and taken with you, helping to deter theft.

Removing the Faceplate

Press the Release button.

The faceplate is unlocked, allowing you to detach it.

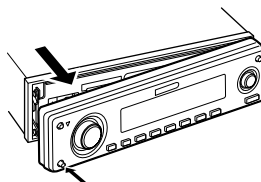

- The faceplate is a precision piece of equipment and can be damaged by shocks or jolts. For that reason, keep the faceplate in its special storage case while detached.
- Do not expose the faceplate or its storage case to direct sunlight or excessive heat or humidity. Also avoid places with too much dust or the possibility of water splashing.

Reattaching the Faceplate

- 1** Align the shaft on the unit with the depression on the faceplate.

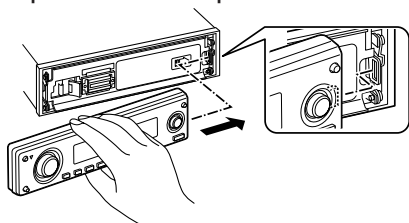

- 2** Push the faceplate in until it clicks.

The faceplate is locked in place, allowing you to use the unit.

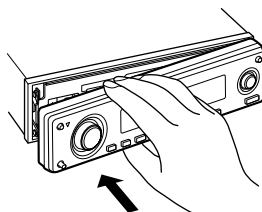

Tuner/TV control features

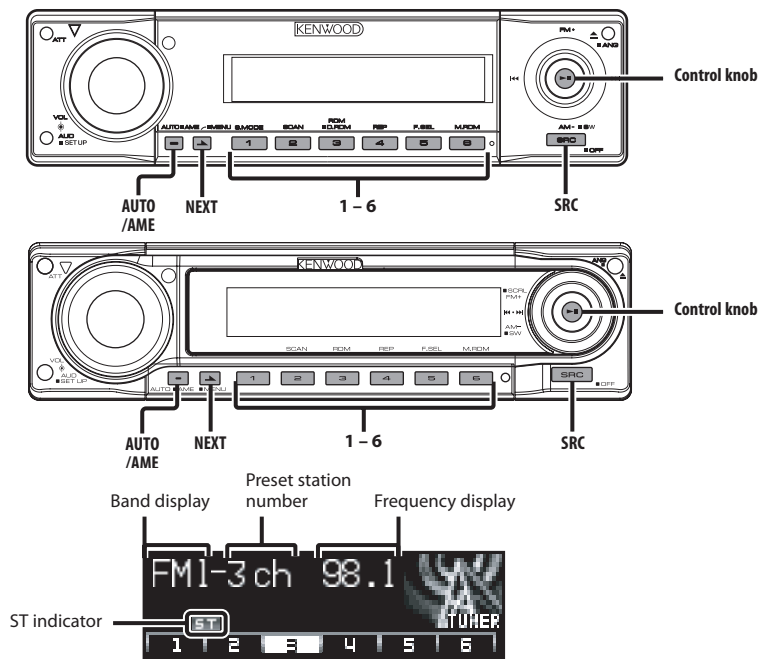

Tuning

Selecting the station.

- 1 Select tuner source**
Press the [SRC] button.
 Select the "TUNER" display.
- 2 Select the band**
Push the Control knob to [FM] or [AM].
 Each time the knob is pushed to [FM], it switches between the FM1, FM2, and FM3 bands.
- 3 Tune up or down band**
Push the Control knob to [◀◀] or [▶▶].



- During reception of stereo stations the "ST" indicator is ON.

Tuning Mode

Choose the tuning mode.

- Press the [AUTO] button.**
 Each time the button is pressed, the Tuning mode switches as shown below.

Tuning mode	Display	Operation
Auto seek	"Seek Mode Auto 1"	Automatic search for a station.
Preset station seek	"Seek Mode Auto 2"	Search in order of the stations in the Preset memory.
Manual	"Seek Mode Manual"	Normal manual tuning control.

Function of remote

Direct Access Tuning

Entering the frequency and tuning.

- 1 Select the band**
Press the [FM] or [AM] button.
- 2 Enter Direct Access Tuning mode**
Press the [DIRECT] button on the remote.
 "- - - -" is displayed.

3 Enter the frequency

Press the number buttons on the remote.

Example:

Desired frequency	Press button
92.1 MHz (FM)	[0], [9], [2], [1]
810 kHz (AM)	[0], [8], [1], [0]

Canceling Direct Access Tuning

Press the [DIRECT] button on the remote.

Station Preset Memory

Putting the station in the memory.

1 Select the band

Push the Control knob to [FM] or [AM].

2 Select the frequency to put in the memory

Push the Control knob to [◀◀] or [▶▶].

3 Select the key function section

Press the [NEXT] button.

Repeatedly press the button until "[1]" — "[6]" are displayed above the [1] — [6] buttons.

Refer to <Notes on Multi-function Key System> (page 8).

4 Put the frequency in the memory

Press the desired [1] — [6] button for at least 2 seconds.

The preset number display blinks 1 time.

On each band, 1 station can be put in the memory on each [1] — [6] button.

Auto Memory Entry

Putting stations with good reception in the memory automatically.

1 Select the band for Auto Memory Entry

Push the Control knob to [FM] or [AM].

2 Open Auto Memory Entry

Press the [AME] button for at least 2 seconds.

When 6 stations that can be received are put in the memory Auto Memory Entry closes.

Preset Tuning

Calling up the stations in the memory.

1 Select the band

Push the Control knob to [FM] or [AM].

2 Select the key function section

Press the [NEXT] button.

Repeatedly press the button until "[1]" — "[6]" are displayed above the [1] — [6] buttons.

Refer to <Notes on Multi-function Key System> (page 8).

3 Call up the station

Press the desired [1] — [6] button.

Frequency Step Setting

Changing the tuning frequency step.

The original setting is FM band 50 kHz, and AM band 9 kHz.

1 Turn the power OFF

Press the [SRC] button for at least 1 second.

2 Switch the frequency step

While pressing the [1] and [5] button, press the [SRC] button.

Release your fingers from the button after the display is appeared.

The frequency step changes to FM band 200 kHz, and AM band 10 kHz.



- When the same operation is repeated, it returns to the original setting.
- When the frequency step is switched, the frequencies in the memory are deleted.

Tuner/TV control features

Function of LX BUS Television

TV Tuning

The TV channel of a connected LX BUS Television (optional accessory) can be selected.

The action depends on the setting of the connected LX BUS Television. Refer to the user instruction of the LX BUS Television for details.

1 Select TV source

Press the [SRC] button.

Select the "TV" display.

2 Select the TV band and Video input

Press the [FM] button.

Each time the [FM] button is pressed, TV bands and Video input switch.

3 Select the TV channel

Push the Control knob to [◀◀] or [▶▶].

Function of LX BUS Television

TV channel Preset Memory

Putting the TV channels in the memory.

1 Select the TV band

Press the [FM] button.

2 Select the TV channel to put in the memory

Push the Control knob to [◀◀] or [▶▶].

3 Put the TV channel in the memory

Press the desired [1] — [6] button for at least 2 seconds.

The preset number display blinks 1 time.

On each band, 1 TV channel can be put in the memory on each [1] — [6] button.

Function of LX BUS Television

Preset TV Tuning

Calling up the TV channels in the memory.

1 Select the TV band

Press the [FM] button.

2 Call up the TV channel

Press the desired [1] — [6] button.

Function of remote

Direct TV Tuning

Entering the TV channel and tuning.

1 Select the TV band

Press the [FM] button.

2 Enter Direct TV Tuning mode

Press the [DIRECT] button on the remote.

"—" is displayed.

3 Enter the TV channel

Press the number buttons on the remote.

Example:

Desired channel	Press button
8 ch	[0], [8]

Canceling Direct TV Tuning

Press the [DIRECT] button on the remote.

CD/Audio file/External disc control features

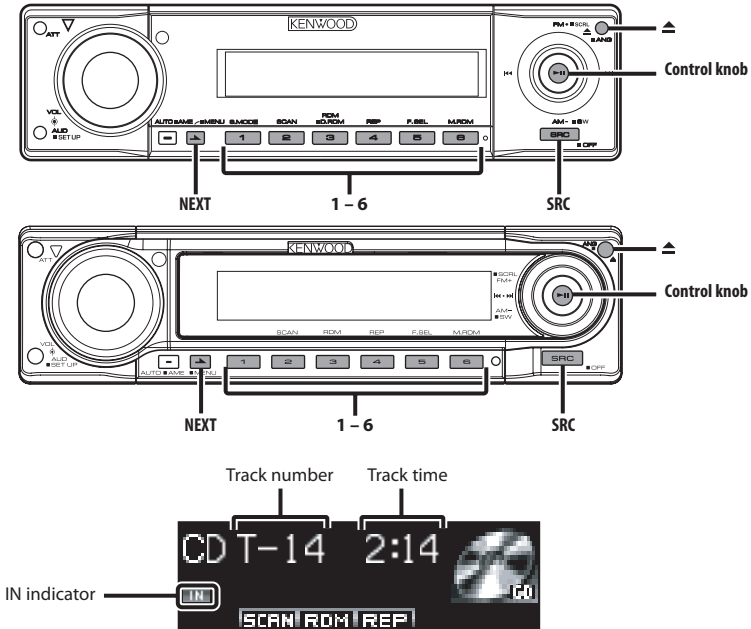

Playing CD & Audio file

When there is no disc inserted

- 1 Open the panel.
Press the [▲] button.
- 2 Insert a disc.



- When the faceplate has been slid open, it might interfere with the shift lever or something else. If this happens, pay attention to safety and move the shift lever or take an appropriate action, then operate the unit.
- Insert the disc horizontal to the slot. If you insert the Disc as you push down the Disc, it may scratch the Disc.



- Refer to <About AAC, MP3 and WMA> (page 7) for the Audio file by models which can be played.
- The announcement when selecting the folder can be canceled by <Voice Index> (page 36) during the play of the ACDrive.
- When a disc is inserted the "IN" indicator is ON.

When a disc is inserted

- Press the [SRC] button.
Select the "Compact Disc" display.

Pause and play

- Press the Control knob.
Each time the knob is pressed, it pauses and plays.

Eject the disc

- 1 Eject the disc
Press the [▲] button.
- 2 Return the panel to the original position
Press the [▲] button.

CD/Audio file/External disc control features

Playing External Disc

Playing discs set in the optional accessory disc player connected to this unit.

Press the [SRC] button.

Select the display for the disc player you want.

Display examples:

Display	Disc player
"CD Changer"	CD changer
"MD Changer"	MD changer

Pause and play

Press the Control knob.

Each time the knob is pressed, it pauses and plays.



- The functions that can be used and the information that can be displayed will differ depending on the external disc players being connected.

Fast Forwarding and Reversing

Fast Forwarding

Hold down on [▶▶] of the Control knob.

Release your finger to play the disc at that point.

Reversing

Hold down on [◀◀] of the Control knob.

Release your finger to play the disc at that point.



- The sound is not output while the Audio file is being searched.
- Fast Forwarding and Reversing cannot be done while AAC file is being played. (KDC-MP8029 only)
- Fast Forwarding and Reversing cannot be done depending on AAC file format. (KDC-X8529 only)

Track/File Search

Searching for a song on the disc or in the Audio file folder.

Push the Control knob to [◀◀] or [▶▶].

Function of disc changer/ Audio file

Disc Search/Folder Search

Selecting the disc set in the Disc changer or the folder recorded on the Audio file media.

Push the Control knob to [FM] or [AM].

Function of remote

Direct Track/File Search

Doing Track/File Search by entering the track/file number.

1 Enter the track/file number

Press the number buttons on the remote.



- Direct File Search can be selected up to 999. (KDC-X8529 only)

2 Do Track/File Search

Press the [◀◀] or [▶▶] button.

Canceling Direct Track/File Search

Press the [▶II] button.

Function of disc changers with remote

Direct Disc Search

Doing Disc Search by entering the disc number.

1 Enter the disc number

Press the number buttons on the remote.

2 Do Disc Search

Press the [+] or [-] button.

Canceling Direct Disc Search

Press the [▶II] button.

Track/File/Disc/Folder Repeat

Replaying the song, disc in the Disc changer or Audio file folder folder you're listening to.

1 Select the key function section

Press the [NEXT] button.

Repeatedly press the button until "REP" is displayed above the [4] button.

Refer to <Notes on Multi-function Key System> (page 8).

2 Turn ON/OFF the Repeat Play

Press the [4] ("REP") button.

Each time the button is pressed, the Repeat Play switches as shown below.

In CD & External disc source

Repeat play	Display
Track Repeat (In Disc Changer)	"Repeat ON" ("Track Repeat ON")
Disc Repeat (In Disc Changer)	"Disc Repeat ON"
OFF	"Repeat OFF"

In Audio file

Repeat play	Display
File Repeat	"File Repeat ON"
Folder Repeat	"Folder Repeat ON"
OFF	"Repeat OFF"

Scan Play

Playing the first part of each song on the disc or Audio file folder you are listening to and searching for the song you want to listen to.

1 Select the key function section

Press the [NEXT] button.

Repeat to press the button until "SCAN" is displayed above the [2] button.

Refer to <Notes on Multi-function Key System> (page 8).

2 Start Scan Play

Press the [2] ("SCAN") button.

"Scan ON"/"Track Scan ON" is displayed.

3 Release it when the song you want to listen to is played

Press the [2] button.

Random Play

Play all the songs on the disc or Audio file folder in random order.

1 Select the key function section

Press the [NEXT] button.

Repeatedly press the button until "RDM" is displayed above the [3] button.

Refer to <Notes on Multi-function Key System> (page 8).

2 Turn ON/OFF the Random Play

Press the [3] ("RDM") button.

Each time the button is pressed, Random Play turns ON and OFF.

When it's ON, "Random ON" is displayed.



- When the Control knob is pushed to [▶▶], the next random song starts.

Function of disc changer

Magazine Random Play

Play the songs on all the discs in the disc changer in random order.

1 Select the key function section

Press the [NEXT] button.

Repeatedly press the button until "M.RDM" is displayed above the [6] button.

Refer to <Notes on Multi-function Key System> (page 8).

2 Turning ON/OFF the Magazine Random Play

Press the [6] ("M.RDM") button.

Each time the button is pressed, the Magazine Random Play turns ON and OFF.

When it's ON, "Magazine RDM ON" is displayed.



- When the Control knob is pushed to [▶▶], the next random song starts.

CD/Audio file/External disc control features

Function of the KDC-X8529

Function of Audio file

Disc Random Play

Playing randomly from all of the Audio files recorded in the disc.

1 Select the key function section

Press the [NEXT] button.

Repeatedly press the button until "RDM" is displayed above the [3] button.

Refer to <Notes on Multi-function Key System> (page 8).

2 Turn ON the Disc Random Play

Press the [3] ("RDM") button for at least 1 second.

When it's ON, "Disc Random ON" is displayed.

Canceling the Disc Random Play

Press the [3] ("RDM") button.



- When the Control knob is pushed to [▶▶], the next random song starts.

Function of Audio file

Folder Select

Quickly selecting the folder you want to listen to.

1 Select the key function section

Press the [NEXT] button.

Repeatedly press the button until "FSEL" is displayed above the [5] button.

Refer to <Notes on Multi-function Key System> (page 8).

2 Enter Folder Select mode

Press the [5] ("FSEL") button.

"Select Mode" is displayed.

During Select mode the folder information is displayed as shown below.

Folder number display

Displays the number in the folder belonging to the currently selected folder.



Folder name display

Displays the current folder name.



- It doesn't function when <Disc Random Play> (page 28) is ON.

3 Select the folder level*

Push the Control knob to [FM] or [AM].

With the [FM] button, you move 1 level down and with the [AM] button 1 level up.

Selecting a folder in the same level

Push the Control knob to [◀◀] or [▶▶].

With the [◀◀] of the Control knob, you move to the previous folder, and with the [▶▶] of the Control knob to the next folder.

Returning to the top level*

Press the [3] ("HOME") button.



- * You can operate when <Switching the Play mode> (page 28) is set to "Folder Mode" while playing ACDrive. (KDC-X8529 only)

Scrolling the folder name display

Press the [SCRL] button.

4 Decide the folder to play

Press the [1] ("OK") button.

The Folder Select mode releases, and the Audio file in the folder being displayed is played.

Canceling the Folder Select mode

Press the [2] ("EXIT") button.

Function of the KDC-X8529

Function of ACDrive disc

Switching the Play mode

Arrange the playing orders of the songs by categories.

1 Select the key function section

Press the [NEXT] button.

Repeatedly press the button until "S.MODE" is displayed above the [1] button.

Refer to <Notes on Multi-function Key System> (page 8).

2 Select the Play mode

Press the [1] ("S.MODE") button.

Each time the button is pressed, the Play mode switches as follows.

Play mode	Category which is to be arranged
"Play List Mode"	Play list order.
"Genre Mode"	By genre.
"Artist Mode"	By artist.
"Album Mode"	By album.
"Folder Mode"	By the folder recorded in Disc.



- The category information of each song is the data registered in Media Manager when ACDrive disc is being generated.
- The announcement when the mode is switched can be canceled by <Voice Index> (page 36).
- The advancement of the Play mode information can be selected by [AM] and [FM] keys.

*Function of the KDC-X8529
Function of the ACDrive disc*

Letter Seek

The song, in which you want to play, can be searched by selecting the initial of Genre name, Artist name, or Album name.

1 Select the key function section

Press the [NEXT] button.

Repeatedly press the button until "S.MODE" is displayed above the [1] button.

Refer to <Notes on Multi-function Key System> (page 8).

2 Enter the Letter Seek mode

Press the [1] ("S.MODE") button for at least 1 second.



- It doesn't function when <Disc Random Play> (page 28) is ON.
- This function is available only when the Play mode is set Genre, Artist, or Album.

Canceling the Letter Seek

Press the [1] ("EXIT") button.

3 Start the Letter Seek

Push the Control knob to [◀◀] or [▶▶].

The initial of Genre name, Artist name, or Album name is displayed and read out by the order.



- The announcement of the initial can be canceled by <Voice Index> (page 36).
- When the Control knob is pushed to the reverse of [◀◀] or [▶▶] while Letter Seek, the initial is displayed and read by the reversed order.
- When the Letter Seek is started, it cannot be cancelled.

4 Select the song to play

Press the Control knob when the initial of the song you are searching is displayed and read.

The selected initial group plays.



- The category with marks or letters that cannot be read cannot be selected.

Text/Title Scroll

Scrolling the displayed CD text, Audio file text, or MD title.

Hold down on [FM] of the Control knob for at least 1 second.

Menu system

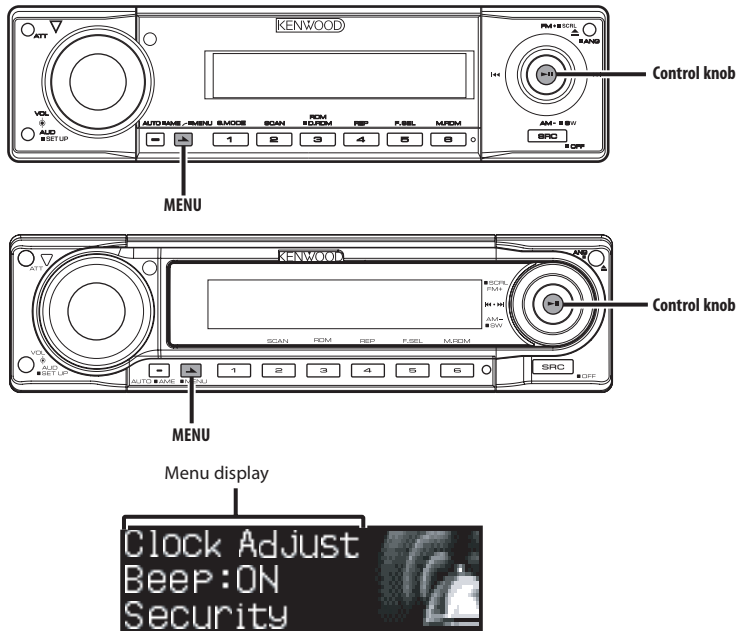

Menu System

Setting during operation beep sound etc. functions.

The Menu system basic operation method is explained here. The reference for the Menu items and their setting content is after this operation explanation.

1 Enter Menu mode

Press the [MENU] button for at least 1 second.

"Menu" is displayed.

2 Select the menu item

Push the Control knob to [FM] or [AM].

Example: When you want to set the beep sound select the "Beep" display.

3 Set the menu item

Push the Control knob to [◀◀] or [▶▶].

Example: When "Beep" is selected, each time the knob is pushed it switches "Beep : ON" or "Beep : OFF". Select 1 of them as the setting.

You can continue by returning to step 2 and setting other items.

4 Exit Menu mode

Press the [MENU] button.



- When other items that are applicable to the basic operation method above are displayed, afterwards their setting content chart is entered. (Normally the uppermost setting in the chart is the original setting.) Also, the explanation for items that aren't applicable (<Manual Clock Adjustment> etc.) are entered step by step.
- It is the item when the menu item of Middle text display part is selected.

In Standby mode

Security Code

Because authorization by the Security Code is required when it's removed from the vehicle, personalizing this unit is by using the Security Code is a help in preventing theft.



- When the Security Code function is activated, it can't be released.
Note, your Security Code is the 4 digit number entered in your "Car Audio Passport" in this package.

1 Enter Standby

Press the [SRC] button.

Select the "STANDBY" display.

2 Enter Menu mode

Press the [MENU] button for at least 1 second.

When "Menu" is displayed, "Security" is displayed.

3 Enter Security Code mode

Press the Control knob for at least 1 second.

When "Enter" is displayed, "Security" is displayed.

4 Select the digits to enter

Push the Control knob to [◀◀] or [▶▶].

5 Select the Security Code numbers

Push the Control knob to [FM] or [AM].

6 Repeat steps 4 and 5, and complete the Security Code.

7 Confirm the Security Code

Press the Control knob for at least 3 seconds.

When "Re-Enter" is displayed, "Security" is displayed.

8 Do the step 4 through 7 step operation, and reenter the security code.

"Approved" is displayed.

The Security Code function activates.



- If you enter a Code different from your Security Code, you have to start over from step 4.

Press the Reset button and when it's removed from the battery power source

1 Turn the power ON.

2 Do the step 4 through 7 step operation, and reenter the security code.

"Approved" is displayed.

The unit can be used.



- If an incorrect code is input, "Waiting" is displayed, and the input prohibited time shown below is generated. After the input prohibited time lapses, "Security" is displayed, and input can be done.

Number of times the incorrect code was input	Input prohibited time
1	—
2	5 minutes
3	1 hour
4	24 hours

In Standby mode

Touch Sensor Tone

Setting the operation check sound (beep sound) ON/OFF.

Display	Setting
"Beep : ON"	Beep is heard.
"Beep : OFF"	Beep canceled.

In Standby mode

Manual Clock Adjustment

1 Select Clock Adjustment mode

Push the Control knob to [FM] or [AM].

Select the "Clock Adjust" display.

2 Enter Clock Adjust mode

Press the Control knob for at least 1 second.

The clock display blinks.

3 Adjust the hours

Push the Control knob to [FM] or [AM].

Adjust the minutes

Push the Control knob to [◀◀] or [▶▶].

4 Exit Clock adjustment mode

Press the [MENU] button.

Menu system

In Standby mode

Date Adjustment

1 Select Date Adjust mode

Push the knob to [FM] or [AM].

Select the "Date Adjust" display.

2 Enter Date Adjust mode

Press the Control knob for at least 1 second.

The date display blinks.

3 Selecting the item (day, month, or year) to adjust

Push the Control knob to [◀◀] or [▶▶].

The items that are blinking are items that can be adjusted.

4 Adjust each item

Push the Control knob to [FM] or [AM].

5 Repeat step 3 and 4 operation and adjust the date.

6 Exit Date adjustment mode

Press the [MENU] button.

In Standby mode

Date Mode

Setting the date format.

1 Select Date Mode

Push the Control knob to [FM] or [AM].

Select the "Date Mode" display.

2 Select the date format

Push the Control knob to [◀◀] or [▶▶].

3 Exit Menu mode

Press the [MENU] button.

In Standby mode

DSI (Disabled System Indicator)

A red indicator will blink on the unit after the faceplate is removed, warning potential thieves.

Display	Setting
"DSI : ON"	LED flashes.
"DSI : OFF"	LED OFF.

In Standby mode

Selectable Illumination

Selecting the button illumination color as green or red.

Display	Setting
"Button : Green"	The illumination color is green.
"Button : Red"	The illumination color is red.

In Standby mode

Dimmer

Dimming this unit's display automatically when the vehicle light switch is turned ON.

Display	Setting
"Dimmer : ON"	The display dims.
"Dimmer : OFF"	The display doesn't dim.

Function of the KDC-MP8029

In Standby mode

Switching preout

Switching the preout between the rear and subwoofer. (In subwoofer it outputs without effect from the fader control.)

Display	Setting
"SWPRE : Rear"	Rear preout.
"SWPRE : Sub-W"	Subwoofer preout.

In Standby mode

Built-in Amp Setting

Built-in amplifier is controlled.

Turning OFF this control enhances the preout quality.

Display	Setting
"AMP : ON"	The built-in amplifier activates.
"AMP : OFF"	The built-in amplifier deactivates.

Function of the KDC-X8529
In Standby mode

G-Counter Level set

Calibrating G-Counter. Setting the level according to the kinds of vehicles.

Display	Setting
"G-Counter: Level1"	Counter is easy to go up.
"G-Counter: Level2"	:
"G-Counter: Level3"	Counter is hard to go up.



- In the case of less acceleration, set it up to "G-Counter: Level1". In the case of frequent acceleration, set it up to "G-Counter: Level3".

Function of the KDC-X8529
In Standby mode

G-Analyzer Reset

Resets the value of G-Meter and G-Counter.

1 Select G-Analyzer Reset mode

Push the Control knob to [FM] or [AM].

Select the "G-Reset" display.

2 Enter G-Analyzer Reset mode

Press the Control knob for at least 1 second.

3 Select the Reset item

Push the Control knob to [FM] or [AM].

"G-Meter Reset": Reset the value of G-Meter.

"G-Counter Reset": Reset the value of G-Counter.

4 Reset the value

Press the Control knob for at least 2 seconds.

"Reset OK" is displayed.

5 Exit G-Analyzer Reset mode

Press the [MENU] button.

Function of the KDC-X8529
In Standby mode

G-Analyzer Calibration setup

G-Analyzer requires calibration for horizontal acceleration and braking.



- Detection of horizontal and straight directions should be done at horizontal location to go straight.

1 Park the vehicle at horizontal location

2 Select G-Analyzer Calibration set mode

Push the Control knob to [FM] or [AM].

Select the "G-Calibration" display.

3 Enter G-Analyzer Calibration set mode

Press the Control knob for at least 1 second.

"Stop" is displayed.

4 Start Calibration of horizontal direction

Press the Control knob.

Once "Move Forward" appears on the display, the vehicle must be advanced.

5 Start Calibration of straight direction

When the vehicle is driven on the straight direction, calibration of straight direction automatically starts.



- In order to operate the detection of straight direction.

When the Calibration is finished, "Calibration OK" is displayed.



- If you fail to complete the calibration, "No Calibration" is displayed. In such a case, repeats step 1 thru 6.

6 Exit G-Analyzer Calibration set mode

Press the [MENU] button.

Menu system

Function of the KDC-X8529

G-Analyzer Stop Watch

The control of stop watch can be started by G-Analyzer function.



- Do not use G-Analyzer stop watch on the Public roads.

1 Select G-Analyzer Stop Watch mode

Push the Control knob to [FM] or [AM].

Select the "Stop Watch" display.

2 Enter G-Analyzer Stop Watch mode

Press the Control knob for at least 1 second.

"Stop" is displayed.

3 Enter Counter Ready mode

Press the Control knob.

"Ready" is displayed.

4 Start Count

When G on the vertical direction is detected during the traveling, the count is automatically started.

"Running" is displayed.



- You can also start the counter by pressing the Control knob.

5 Stop Count

Press the Control knob.

"Stop" is displayed.



- The control will be started again when you accelerate or press the Control knob.
Do the operation after step3.

When you Reset the Count (While "Stop" is displayed)

Press the Control knob for at least 2 seconds.



- The reset of count can be done when the count is stopped.

6 Exit G-Analyzer Stop Watch mode

Press the [MENU] button.



- When "Running" is displayed (counted), the count is continued on although G-Analyzer Stop Watch mode is finished. If you want to stop the count, enter the menu mode then press the control knob.
- When Power off (ex; ACC OFF) while counting, the value of 1 second or less will be "00".

When the Dual Zone System is ON
Other than Standby mode

Dual Zone System Setting

Setting the Front channel and Rear channel sound in the Dual Zone System.

Display	Setting
"Zone 2 : Rear"	Sub source (Auxiliary input source) is to be rear channel.
"Zone 2 : Front"	Sub source (Auxiliary input source) is to be front channel.

Other than Standby mode

B.M.S. (Bass Management System)

Adjust the bass boost level of the external amplifier using the main unit.

Display	Setting
"AMP Bass : Flat"	Bass boost level is flat.
"AMP Bass : +6"	Bass boost level is low (+6dB).
"AMP Bass : +12"	Bass boost level is mid (+12dB).
"AMP Bass : +18"	Bass boost level is high (+18dB).



- Refer to the catalog or instruction manual for power amplifiers that can be controlled from this unit.
- For amplifiers there are the model that can be set from Flat to +18 dB, and the model that can be set from Flat to +12 dB.
When an amplifier that can only be set to +12 is connected to the unit, "AMP Bass : +18" won't work correctly even if it's selected.

Other than Standby mode

B.M.S. Frequency Offset

Setting the central frequency boosted by B.M.S.

Display	Setting
"AMP FREQ : Normal"	Boost with the normal central frequency.
"AMP FREQ : Low"	Drop the normal central frequency 20%.

When LX AMP unit connecting

AMP Control

You can control the LX AMP connected to the unit.

1 Select AMP Control mode

Push the Control knob to [FM] or [AM].

Select the "AMP Control" display.

2 Enter AMP Control mode

Press the Control knob for at least 1 second.

3 Select the AMP Control item for adjustment

Push the Control knob to [FM] or [AM].



- For the details of the AMP Control item, see the Instruction manual attached to the LX AMP.

4 Adjust the AMP Control item

Push the Control knob to [◀◀] or [▶▶].

5 Exit AMP Control mode

Press the [MENU] button.



- You cannot use the LX AMP operation during standby mode.

In FM reception

CRSC (Clean Reception System Circuit)

Temporarily have reception switched from stereo to mono to reduce multi-path noise when listening to the FM station.

Display	Setting
"CRSC : ON"	The CRSC is ON.
"CRSC : OFF"	The CRSC is OFF.



- Strong electrical fields (such as from power lines) may cause unstable sound quality when CRSC is turned ON. In such a situation, turn it OFF.

Auxiliary Input Display Setting & Station/Disc Naming

For selecting the display when switched to Auxiliary input source. For the Station/Disc Naming refer to the <Station/Disc Naming (SNPS/DNPS)> (page 20).

1 Select Auxiliary input source

Press the [SRC] button.

Select the "AUX"/"AUX EXT" display.

2 Enter Menu mode

Press the [MENU] button for at least 1 second.

"Menu" is displayed.

3 Select Auxiliary input display setting mode

Push the Control knob to [FM] or [AM].

Select the "Name Set" display.

4 Enter Auxiliary input display setting mode

Press the Control knob for at least 1 second.

The presently selected Auxiliary input display is displayed.

5 Select the Auxiliary input display

Push the Control knob to [◀◀] or [▶▶].

Each time the button is pressed, the display switches as shown below.

- "AUX"/"AUX EXT"
- "DVD"
- "PORTABLE"
- "GAME"
- "VIDEO"
- "TV"

6 Exit Menu mode

Press the [MENU] button.



- When operation stops for 10 seconds, the name at that time is registered, and the Auxiliary input display setting mode closes.
- The Auxiliary Input Display can be set only when the built-in auxiliary input or the auxiliary input of optional KCA-S210A is used.

Menu system

Text Scroll

Setting the displayed text scroll.

Display	Setting
"Scroll : Auto"	Scrolls when the display changes.
"Scroll : Manual"	Doesn't scroll.



- The text scrolled is shown below.
 - CD text
 - Folder name/ File name/ Song title/ Artist name/ Album name
 - MD title

In Standby mode

Built-in Auxiliary input Setting

Set the Built-in Auxiliary Input function.

Display	Setting
"Built in AUX : OFF"	When selecting the source there's no Auxiliary Input.
"Built in AUX : ON"	When selecting the source there's Auxiliary Input.

In Standby mode

CD Read Setting

When there is a problem on playing a CD with special format, this setting play the CD by force.

Display	Setting
"CD Read : 1"	Play CD and Audio file.
"CD Read : 2"	Play CD by force.



- Setting "CD Read : 2" cannot play Audio file. Some music CDs may not be played back even in the "CD Read : 2" mode.

*Function of the KDC-X8529
Function of ACDrive disc*

Voice Index

Set the announce to guide during the play of ACDrive disc.

Display	Setting
"Voice Index : ON"	Guide is announced.
"Voice Index : OFF"	Not be announced.

*Function of the KDC-X8529
In CD mode*

ACDrive firmware version display

Displaying the firmware version with the ACDrive function.

- 1 Select the firmware version display mode**
Push the Control knob to [FM] or [AM].
Select the "ACD F/W Version" display.
- 2 Display the ACDrive firmware version**
Push the Control knob to [◀◀] or [▶▶].

*Function of the KDC-X8529
In CD mode*

Unique ID display

Displaying the serial number for each product.

- 1 Select the unique ID display mode**
Push the Control knob to [FM] or [AM].
Select the "ACD Unique ID" display.
- 2 Display the unique ID**
Push the Control knob to [◀◀] or [▶▶].

Other than Standby mode

Audio Preset Memory

Registering the value setup by Sound Control. The memory can't be erased by the Reset button.

1 Setup Sound Control

Refer to the following operations to setup the Sound Control.

- <Audio Control> (page 10)
- <Audio Setup> (page 10)
- <Equalizer Control> (page 11)

2 Enter Menu mode

Press the [MENU] button for at least 1 second.
"Menu" is displayed.

3 Select Audio Preset mode

Push the Control knob to [FM] or [AM].
Select the "Audio Preset" display.

4 Enter Audio Preset mode

Press the Control knob for at least 1 second.

5 Select the Audio Preset Memory

Push the Control knob to [FM] or [AM].
Select the "Memory" display.

6 Put the Audio Preset in the memory

Press the Control knob for at least 2 seconds.
The "Memory" display blinks 1 time.

7 Exit Menu mode

Press the [MENU] button.



- Register 1 pair of Audio Preset Memory. You can't register by the source.
- When you press the Reset, all the sources will be the setting value which is registered.
- The following items can't be registered.
Volume, Balance, Fader, Loudness, Volume offset, Dual Zone System, Rear Volume, System Q Setting

5 Select the Audio Preset Call

Push the Control knob to [FM] or [AM].
Select the "Call Ready" display.

6 Call up the Audio Preset

Press the Control knob for at least 2 seconds.
The "Call Ready" display blinks 1 time.

7 Exit Menu mode

Press the [MENU] button.



- The User memory of <Equalizer Control> (page 11) is changed to the value which was recalled.
- The source tone memory item of <Audio Control> (page 10) is changed to the value which was recalled by the selected source.

Other than Standby mode

Audio Preset Call

Recalling the sound setup registered by <Audio Preset Memory> (page 36).

1 Select the source

Press the [SRC] button.

2 Enter Menu mode

Press the [MENU] button for at least 1 second.
"Menu" is displayed.

3 Select Audio Preset mode

Push the Control knob to [FM] or [AM].
Select the "Audio Preset" display.

4 Enter Audio Preset mode

Press the Control knob for at least 1 second.

Basic Operations of remote

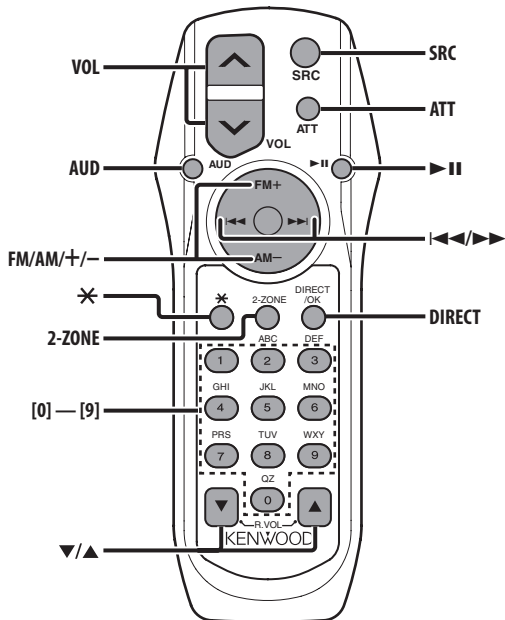

Loading and Replacing the battery

Use two "AA"-size batteries.

Slide the cover while pressing downwards to remove it as illustrated.

Insert the batteries with the + and - poles aligned properly, following the illustration inside the case.

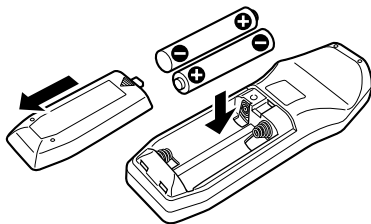

⚠ WARNING

- Store unused batteries out of the reach of children. Contact a doctor immediately if the battery is accidentally swallowed.



- Do not set the remote on hot places such as above the dashboard.

Basic operations

[VOL] buttons

Adjusting the volume.

[SRC] button

Each time the button is pressed, the source switches.

For the source switching order refer to <Selecting the Source> (page 9).

[ATT] button

Turning the volume down quickly.

When it is pressed again, it returns to the previous level.

[*] button

Adjusting the Faceplate Angle.

Audio Control

[AUD] button

Select the Audio item for adjustment.

[VOL] buttons

Adjust the Audio item.



- Refer to <Audio Control> (page 10) for the operation method, such as the procedures of Audio control and others.
- Only selecting and adjusting of the Basic Audio item can be done by the remote control. Selecting and adjusting of the Detail Audio item cannot be done.

Dual Zone System

[2-ZONE] button

Each time the button is pressed, "2 ZONE" of <Audio Setup> (page 10) is turned ON and OFF.

[▲]/[▼] buttons

Adjusts the volume of the rear channel.
It activates while the Dual Zone System is ON.

In Tuner source

[FM]/[AM] buttons

Select the band.
Each time the [FM] button is pressed, it switches between the FM1, FM2, and FM3 bands.

[◀◀]/[▶▶] buttons

Tune up or down band.

[0] — [9] buttons

Press buttons [1] — [6] to recall preset stations.

[DIRECT] button

Enters and cancels the <Direct Access Tuning> (page 22) mode.

In Disc source

[◀◀]/[▶▶] buttons

Doing track/file forward and backward.

[+]/[-] buttons

Doing disc/folder forward and backward.

[▶II] button

Each time the button is pressed, the song pauses and plays.

[0] — [9] buttons

When in <Direct Track/File Search> (page 26) and <Direct Disc Search> (page 26), enter the track/file/disc number.

In TV source

[FM] button

Select the TV band and Video input.
Each time the [FM] button is pressed, TV bands and Video input switch.

[◀◀]/[▶▶] buttons

Select the TV channel.

[0] — [9] buttons

Press buttons [1] — [6] to recall preset TV channels.

[DIRECT] button

Enters and cancels the <Direct TV Tuning> (page 24) mode.

Accessories/ Installation Procedure

Accessories

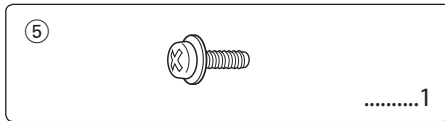
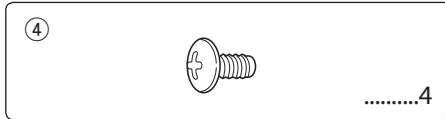
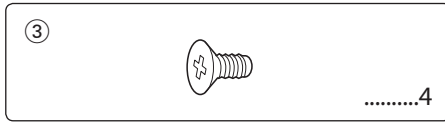
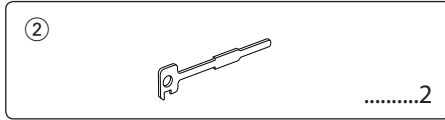
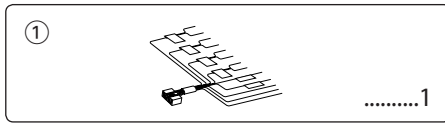

Installation Procedure

1. To prevent a short circuit, remove the key from the ignition and disconnect the ⊖ battery.
2. Make the proper input and output wire connections for each unit.
3. Connect the speaker wires of the wiring harness.
4. Connect the wiring harness wires in the following order: ground, battery, ignition.
5. Connect the wiring harness connector to the unit.
6. Install the unit in your car.
7. Reconnect the ⊖ battery.
8. Press the reset button.

▲WARNING

If you connect the ignition wire (red) and the battery wire (yellow) to the car chassis (ground), you may cause a short circuit, that in turn may start a fire. Always connect those wires to the power source running through the fuse box.



- If the power is not turned ON (or it is ON, but will be OFF immediately), the speaker wire may have a short-circuit or touched the chassis of the vehicle and the protection function may have been activated. Therefore, the speaker wire should be checked.
- If your car's ignition does not have an ACC position, connect the ignition wires to a power source that can be turned on and off with the ignition key. If you connect the ignition wire to a power source with a constant voltage supply, as with battery wires, the battery may die.
- If the console has a lid, make sure to install the unit so that the faceplate will not hit the lid when closing and opening.
- If the fuse blows, first make sure the wires aren't touching to cause a short circuit, then replace the old fuse with one with the same rating.
- Insulate unconnected wires with vinyl tape or other similar material. To prevent a short circuit, do not remove the caps on the ends of the unconnected wires or the terminals.
- Connect the speaker wires correctly to the terminals to which they correspond. The unit may be damaged or fail to work if you share the ⊖ wires or ground them to any metal part in the car.
- When only two speakers are being connected to the system, connect the connectors either to both the front output terminals or to both the rear output terminals (do not mix front and rear). For example, if you connect the ⊕ connector of the left speaker to a front output terminal, do not connect the ⊖ connector to a rear output terminal.
- After the unit is installed, check whether the brake lamps, blinkers, wipers, etc. on the car are working properly.
- Mount the unit so that the mounting angle is 30° or less.

Connecting Wires to Terminals

	A	B
KDC-X8529	Subwoofer right output (Red)	Rear right output (Red)
	Subwoofer left output (White)	Rear left output (White)
KDC-MP8029	Rear right output (Red)/ Subwoofer right output (Red)	—
	Rear left output (White)/ Subwoofer left output (White)	—



To connect these leads, refer to the relevant instruction manuals.

KENWOOD disc changer control input

Fuse (10A)

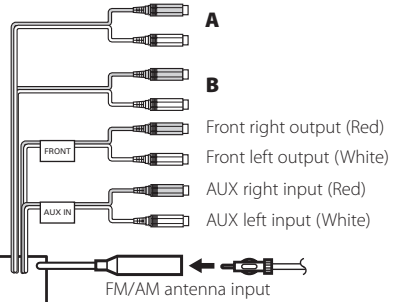

If no connections are made, do not let the wire come out from the tab.

When using the optional power amplifier, connect to its power control terminal.
Depending on what antenna you are using, connect either to the control terminal of the motor antenna, or to the power terminal for the booster amplifier of the film-type antenna.
Connect to the terminal that is grounded when either the telephone rings or during conversation.

To "EXT.AMP.CONT" terminal of the amplifier having the external amp control function.

To car light control switch

- To front left speaker
- To front right speaker
- To rear left speaker
- To rear right speaker

- P.CONT Power control wire (Blue/White)
- ANT.CONT Motor antenna control wire (Blue)
- MUTE TEL mute wire (Brown)
- EXT.CONT External amplifier control wire (Pink / Black)
- ILLUMI Dimmer control wire (Orange / White)

- FRONT • L
- FRONT • R
- REAR • L
- REAR • R

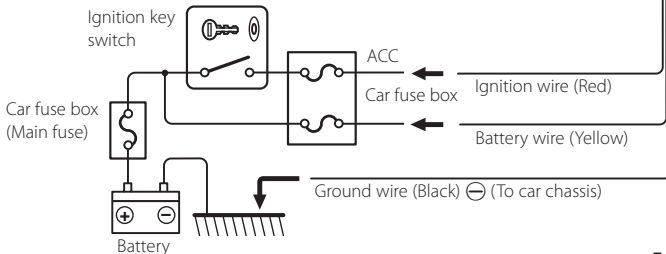

Wiring harness (Accessory①)

Installation

non-Japanese cars

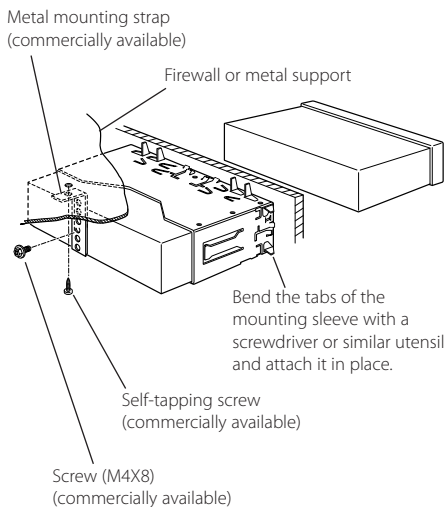

- Make sure that the unit is installed securely in place. If the unit is unstable, it may malfunction (for example, the sound may skip).

Japanese cars

- 1 Refer to the section <Removing the hard rubber frame> (page 44) and then remove the hard rubber frame.
- 2 Align the holes in the unit (two locations on each side) with the vehicle mounting bracket and secure the unit with the accessory screws.

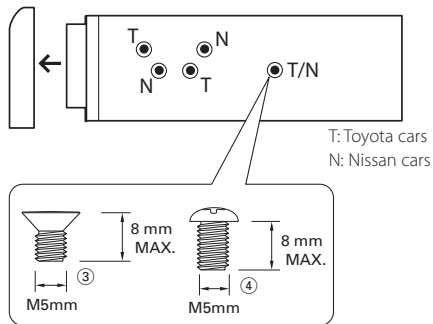

- During installation, do not use any screws except for those provided. The use of different screws might result in damage to the main unit.
- Damage may occur if a screwdriver or similar tool is used with excessive force during the installations.

Screwing the Faceplate on the Unit

If you want to fasten the faceplate to the main unit so that it does not fall off, screw in the provided screws in the holes shown below.

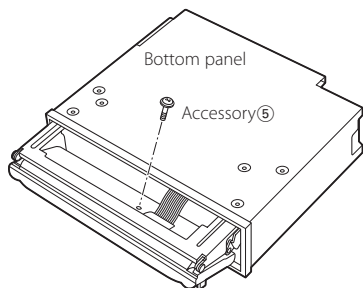

- Never insert the screw in any other screw hole than the one specified. If you screw them in another hole, it will contact and may cause damage to the mechanical parts inside the unit.

Removing the Unit

Removing the hard rubber frame

- 1 Engage the catch pins on the removal tool and remove the two locks on the upper level. Upper the frame and pull it forward as shown in the figure.

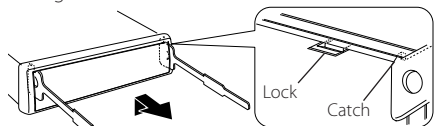

Accessory②
Removal tool

- 2 When the upper level is removed, remove the lower two locations.

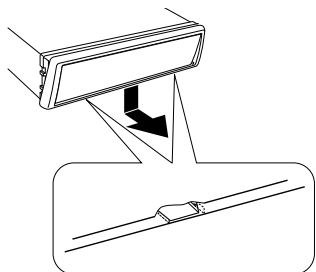

- The frame can be removed from the bottom side in the same manner.

Removing the Unit

- 1 Refer to the section <Removing the hard rubber frame> (page 44) and then remove the hard rubber frame.
- 2 Remove the screw (M4 × 8) on the back panel.
- 3 Insert the two removal tools deeply into the slots on each side, as shown.

Screw (M4X8)
(commercially available)

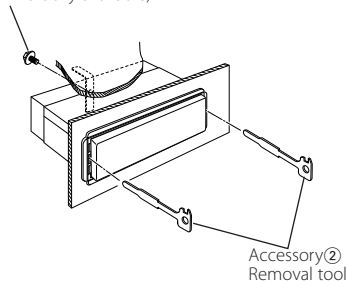

- 4 Lower the removal tool toward the bottom, and pull out the unit halfway while pressing towards the inside.

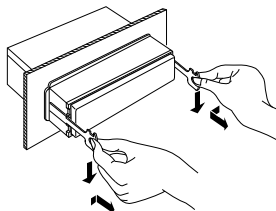

- Be careful to avoid injury from the catch pins on the removal tool.
- 5 Pull the unit all the way out with your hands, being careful not to drop it.

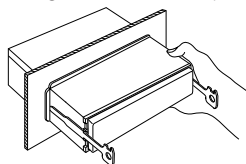

Troubleshooting Guide

What might seem to be a malfunction in your unit may just be the result of slight misoperation or miswiring. Before calling service, first check the following table for possible problems.

General

? The power does not turn ON.

- ✓ The fuse has blown.
 - ⓘ After checking for short circuits in the wires, replace the fuse with one with the same rating.
- ✓ The speaker wire has a short-circuit or touches the chassis of the vehicle, and then the protection function is activated.
 - ⓘ Wire or insulate the speaker cable properly and press the reset button.

? There's a source you can't switch.

- ✓ There's no media inserted.
 - ⓘ Set the media you want to listen to. If there's no media in this unit, you can't switch to each source.
- ✓ The Disc changer isn't connected.
 - ⓘ Connect the Disc changer. If the Disc changer isn't connected to it's input terminal, You can't switch to an external disc source.

? The memory is erased when the ignition is turned OFF.

- ✓ The ignition and battery wire are incorrectly connected.
 - ⓘ Connect the wire correctly, referring to the section on <Connecting Wires to Terminals>.

? The TEL mute function does not work.

- ✓ The TEL mute wire is not connected properly.
 - ⓘ Connect the wire correctly, referring to the section on <Connecting Wires to Terminals>.

? The TEL mute function turns ON even though the TEL mute wire is not connected.

- ✓ The TEL mute wire is touching a metal part of the car.
 - ⓘ Pull the TEL mute wire away from the metal part of the car.

? Even if Loudness is turned ON, high-pitched tone isn't compensated for.

- ✓ Tuner source is selected.
 - ⓘ High-pitched tone isn't compensated for when in Tuner source.

? No sound can be heard, or the volume is low.

- ✓ The fader or balance settings are set all the way to one side.
 - ⓘ Center the fader and balance settings.
- ✓ The input/output wires or wiring harness are connected incorrectly.
 - ⓘ Reconnect the input/output wires or the wiring harness correctly. See the section on <Connecting Wires to Terminals>.
- ✓ The values of Volume offset are low.
 - ⓘ Turn up the Volume offset, referring to the section on <Audio Setup> (page 10).
- ✓ The <Built-in Amp Setting> (page 32) is OFF.
 - ⓘ Turn it ON.

? The sound quality is poor or distorted.

- ✓ One of the speaker wires is being pinched by a screw in the car.
 - ⓘ Check the speaker wiring.
- ✓ The speakers are not wired correctly.
 - ⓘ Reconnect the speaker wires so that each output terminal is connected to a different speaker.

? The Touch Sensor Tone doesn't sound.

- ✓ The preout jack is being used.
 - ⓘ The Touch Sensor Tone can't be output from the preout jack.

? The Dimmer function doesn't work.

- ✓ The Dimmer wire isn't connected correctly.
 - ⓘ Check the Dimmer wire connection.
- ✓ The <Dimmer> (page 32) is OFF.
 - ⓘ Turn it ON.

? The sound is not output from Subwoofer or it outputs the different sound.

- ✓ When "2 ZONE" of <Audio Setup> (page 10) is set to ON.
 - ⓘ Turn OFF "2 ZONE".

Tuner source

? Radio reception is poor.

- ✓ The car antenna is not extended.
 - ☞ Pull the antenna out all the way.
- ✓ The antenna control wire is not connected.
 - ☞ Connect the wire correctly, referring to the section on <Connecting Wires to Terminals>.

? The desired frequency can't be entered with the Direct Access Tuning.

- ✓ A station that can't be received is being entered.
 - ☞ Enter a station that can be received.
- ✓ You're trying to enter a frequency with a 0.01 MHz unit.
 - ☞ What can be designated in the FM band is to 0.1 MHz.

? It isn't the set Traffic information sound volume.

- ✓ The set sound volume is less than the tuner sound volume.
 - ☞ If the tuner sound volume is louder than the set sound volume, the tuner sound volume is used.

Disc source

? "AUX EXT" is displayed without achieving External disc control mode.

- ✓ Unsupported disc changer is connected.
 - ☞ Use the disc changer mentioned in the <About CD players/disc changers connected to this unit> (page 4) of the section on <Safety precautions>.

? The specified disc does not play, but another one plays instead.

- ✓ The specified CD is quite dirty.
 - ☞ Clean the CD.
- ✓ The disc is loaded in a different slot from that specified.
 - ☞ Eject the disc magazine and check the number for the specified disc.
- ✓ The disc is severely scratched.
 - ☞ Try another disc instead.

? Can't remove disc.

- ✓ The cause is that more than 10 minutes has elapsed since the vehicle ACC switch was turned OFF.
 - ☞ The disc can only be removed within 10 minutes of the ACC switch being turned OFF. If more than 10 minutes has elapsed, turn the ACC switch ON again and press the Eject button.

? The disc won't insert.

- ✓ There's already another disc inserted.
 - ☞ Press the [▲] button and remove the disc.

? Direct Search can't be done.

- ✓ Another function is ON.
 - ☞ Turn Random Play or other functions OFF.

? Track Search can't be done.

- ✓ For the discs/folders first or last song.
 - ☞ For each disc/folder, Track Search can't be done in the backward direction for the first song or in the forward direction for the last song.

Audio file source

? Cannot play an Audio file.

- ✓ The media is scratched or dirty.
 - ☞ Clean the media, referring to the CD cleaning of the section on <About CDs> (page 6).

? The sound skips when an Audio file is being played.

- ✓ The media is scratched or dirty.
 - ☞ Clean the media, referring to the CD cleaning of the section on <About CDs> (page 6).
- ✓ The recording condition is bad.
 - ☞ Record the media again or use another media.

? The Audio file track time isn't displayed correctly.

- ✓ ---
 - ☞ There are times when it isn't displayed correctly according to the Audio file recording conditions.

The messages shown below display your systems condition.

Eject:	No disc magazine has been loaded in the changer. The disc magazine is not completely loaded. <ul style="list-style-type: none">↔ Load the disc magazine properly.↔ No CD in the unit.↔ Insert the CD.
No Disc:	No disc has been loaded in the disc magazine. <ul style="list-style-type: none">↔ Load a disc into the disc magazine.
TOC Error:	No disc has been loaded in the disc magazine. <ul style="list-style-type: none">↔ Load a disc into the disc magazine. The CD is quite dirty. The CD is upside-down. The CD is scratched a lot.↔ Clean the CD and load it correctly.
Error 05:	The CD is upside-down. <ul style="list-style-type: none">↔ Load the CD correctly.
Blank Disc:	Nothing has been recorded on the MD.
No Track:	No tracks are recorded on the MD, although it has a title.
Error 15:	Media was played that doesn't have data recorded that the unit can play. <ul style="list-style-type: none">↔ Use media that has data recorded that the unit can play.
NO PANEL:	The faceplate of the slave unit being connected to this unit has been removed. <ul style="list-style-type: none">↔ Replace it.
Error 77:	The unit is malfunctioning for some reason. <ul style="list-style-type: none">↔ Press the reset button on the unit. If the "Error 77" code does not disappear, consult your nearest service center.
Mecha Error:	Something is wrong with the disc magazine. Or the unit is malfunctioning for some reason. <ul style="list-style-type: none">↔ Check the disc magazine. And then press the reset button on the unit. If the "Mecha Error" code does not disappear, consult your nearest service center.

Troubleshooting Guide

Hold Error:	The protective circuit in the unit activates when the temperature inside the automatic disc changer exceeds 60°C (140°F), stopping all operation. ↔ Cool down the unit by opening the windows or turning on the air conditioner. As the temperature falls below 60°C (140°F), the disc will start playing again.
No Name:	Attempted to display DNPS during the CD play having no disc names preset.
Waiting:	Radio text data is being received.
Load:	Discs are being exchanged in the Disc changer.
Reading:	The unit is reading the data on the disc.
IN (Blink):	The CD player section is not operating properly. ↔ Reinsert the CD. If the CD cannot be ejected or the display continues to flash even when the CD has been properly reinserted, please switch off the power and consult your nearest service center.
Unsupported File:	An Audio file is played with a format that this unit can't support. ↔ ----
Copy Protection:	A copy-protected file is played. ↔ ----

Specifications

Specifications subject to change without notice.

FM tuner section

- Frequency range
 - (50 kHz space) : 87.5 MHz – 108.0 MHz
 - (200 kHz space) : 87.9 MHz – 107.9 MHz
- Usable sensitivity (S/N = 30dB)
 - : 9.3 dBf (0.8 μ V /75 Ω)
- Quieting Sensitivity (S/N = 50dB)
 - : 15.2 dBf(1.6 μ V /75 Ω)
- Frequency response (\pm 3.0 dB)
 - : 30 Hz – 15 kHz
- Signal to Noise ratio (MONO)
 - : 70 dB
- Selectivity (DIN) (\pm 400 kHz)
 - : \geq 80 dB
- Stereo separation (1 kHz)
 - : 40 dB

AM tuner section

- Frequency range
 - (9 kHz space) : 531 kHz – 1611 kHz
 - (10 kHz space) : 530 kHz – 1700 kHz
- Usable sensitivity (S/N = 20dB)
 - : 28 dB μ (25 μ V)

CD player section

- Laser diode
 - : GaAlAs
- Digital filter (D/A)
 - : 8 Times Over Sampling
- D/A Converter
 - : 1 Bit
- Spindle speed (Audio file)
 - : 1000 – 400 rpm (CLV 2times)
- Wow & Flutter
 - : Below Measurable Limit
- Frequency response (\pm 1 dB)
 - : 10 Hz – 20 kHz
- Total harmonic distortion (1 kHz)
 - : 0.008 % (KDC-X8529)
 - : 0.01 % (KDC-MP8029)
- Signal to Noise ratio (1 kHz)
 - : 110 dB (KDC-X8529)
 - : 105 dB (KDC-MP8029)
- Dynamic range
 - : 93 dB
- Channel separation
 - : 96 dB
- MP3 decode
 - : Compliant with MPEG-1/2 Audio Layer-3
- WMA decode
 - : Compliant with Windows Media Audio
- AAC decode
 - : AAC-LC ".m4a" files

Audio section

- Maximum output power
 - : 50 W x 4
- Full Bandwidth Power (at less than 1% THD)
 - : 22 W x 4
- Tone action
 - Bass : 100 Hz \pm 10 dB
 - Middle : 1 kHz \pm 10 dB
 - Treble : 10 kHz \pm 10 dB
- Preout level / Load (during disc play)
 - : 5000 mV/10 k Ω
- Preout impedance (during disc play)
 - : \leq 80 Ω

Auxiliary input

- Frequency response (\pm 1 dB)
 - : 20 Hz – 20 kHz
- Input Maximum Voltage
 - : 1200 mV
- Input Impedance
 - : 100 k Ω

General

- Operating voltage (11 – 16V allowable)
 - : 14.4 V
- Current consumption
 - : 10 A
- Installation Size (W x H x D)
 - : 182 x 53 x 155 mm
- Weight
 - : 1.5 kg (3.31 lbs)

KENWOOD

Free Manuals Download Website

<http://myh66.com>

<http://usermanuals.us>

<http://www.somanuals.com>

<http://www.4manuals.cc>

<http://www.manual-lib.com>

<http://www.404manual.com>

<http://www.luxmanual.com>

<http://aubethermostatmanual.com>

Golf course search by state

<http://golfingnear.com>

Email search by domain

<http://emailbydomain.com>

Auto manuals search

<http://auto.somanuals.com>

TV manuals search

<http://tv.somanuals.com>