

Owner's Manual

PHILCO



Please read before using this unit.

DVD/CD Player PVD1000

INSTRUCCIONES EN ESPAÑOL INCLUIDAS.

Table of Contents

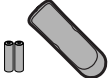
Supplied Accessories

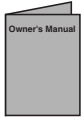
Remote control (NB079UD) with two AA batteries 	Audio/Video cables (WPZ0102TM015/ WPZ0102LTE01) 	Owner's Manual (1VMN23217) 
---	--	---

Connecting to RF Modulator

If your TV has AUDIO/VIDEO input jacks, see the section "Connections" on page 6. If not, it is still possible to connect this unit to your TV by using a STEREO AUDIO/VIDEO RF modulator (commercially available). In this case, follow the instructions below.

- 1) Connect the AUDIO/VIDEO output jacks of this unit to the AUDIO/VIDEO input jacks of your RF modulator by Audio / Video cables.
- 2) The antenna input jack of your TV may have been already occupied. If so, disconnect the RF cable from your TV, and then connect the RF cable to your RF modulator (usually marked "ANT IN").
- 3) Connect your RF modulator to your TV by another RF cable.
- 4) Set your RF modulator's channel 3/4 switch to either 3 or 4, whichever TV channel is least used in your area. If your RF modulator has a modulator/antenna switch, set it according to your RF modulator's manual.
- 5) Turn on your TV and choose the same channel as you set the RF modulator's channel 3/4 switch to. For more details, follow the instructions supplied with the RF modulator.

If your TV does not have AUDIO / VIDEO input jacks.

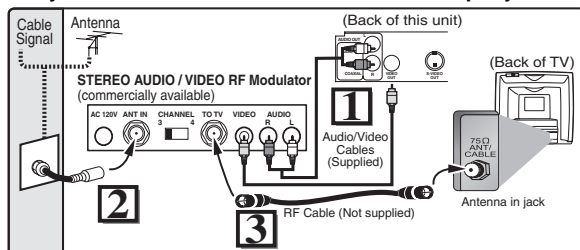

Hint

- The quality of picture may become poor if the unit is connected to an RF modulator.

If you need additional operating assistance after reading this owner's manual, please call
TOLL FREE : 1-800-317-6062
or visit our web site at
<http://www.funai-corp.com>

Precautions

Laser Safety	2
■ Important Safeguards	3
Location and Handling	4
Avoid the Hazards of Electrical Shock and Fire	4
Warning of Dew Formation	4
About Copyright	4
Symbols Used in This Manual	4
Maintenance	4
■ About the Media	5
Playable Media	5
Unplayable Media	5

Setup

■ Connections	6
Connection to a TV	6
Connection to an Audio System	7
Rear Terminals	7
■ About the Remote Control	8
Remote Control	8
Installing the Batteries for the Remote Control	8

Functions

■ Playback	9
■ On-Screen Display	10
■ Search Function	10
Using Title / Chapter Search	10
Using Track Search	10
Using Time Search	11
Marker Setup	11
■ Repeat / Random / Programmed Playback	12
Repeat Playback	12
Repeat A-B Playback	12
Random Playback	12
Programmed Playback	12
■ Special Settings	13
Subtitle Language	13
Audio Language	13
Camera Angles	13
Black Level Setting	13
Stereo Sound Mode	13
Virtual Surround	13
■ DVD Setup	14
LANGUAGE Setting	14
DISPLAY Setting	15
AUDIO Setting	15
PARENTAL Setting	16
OTHERS Setting	16
Reset to the Default Setting (except for PARENTAL Setting)	17

Information

■ Troubleshooting Guide	17
■ Specifications	18
■ Language Code List	18
■ Limited Warranty	18
■ Español	19
■ Quick Use Guide	Back Cover

Precautions

Setup

Functions

Information

Español

Precautions

WARNING: TO REDUCE THE RISK OF FIRE OR ELECTRIC SHOCK, DO NOT EXPOSE THIS APPLIANCE TO RAIN OR MOISTURE.



CAUTION
RISK OF ELECTRIC SHOCK
DO NOT OPEN



The lightning flash with arrowhead symbol, within an equilateral triangle, is intended to alert the user to the presence of uninsulated "dangerous voltage" within the product's enclosure that may be of sufficient magnitude to constitute a risk of electric shock to persons.

CAUTION:

TO REDUCE THE RISK OF ELECTRIC SHOCK, DO NOT REMOVE COVER (OR BACK). NO USER SERVICEABLE PARTS INSIDE. REFER SERVICING TO QUALIFIED SERVICE PERSONNEL.



The exclamation point within an equilateral triangle is intended to alert the user to the presence of important operating and maintenance (servicing) instructions in the literature accompanying the appliance.

The caution marking is located on the rear of the cabinet.

Laser Safety

This unit employs a laser. Only a qualified service person should remove the cover or attempt to service this device, due to possible eye injury.

CAUTION: USE OF CONTROLS OR ADJUSTMENTS OR PERFORMANCE OF PROCEDURES OTHER THAN THOSE SPECIFIED HEREIN MAY RESULT IN HAZARDOUS RADIATION EXPOSURE.

CAUTION: VISIBLE AND INVISIBLE LASER RADIATION WHEN OPEN AND INTERLOCK DEFEATED. DO NOT STARE INTO BEAM.

LOCATION: INSIDE, NEAR THE DECK MECHANISM.

FCC WARNING- This equipment may generate or use radio frequency energy. Changes or modifications to this equipment may cause harmful interference unless the modifications are expressly approved in the manual. The user could lose the authority to operate this equipment if an unauthorized change or modification is made.

RADIO-TV INTERFERENCE

This equipment has been tested and found to comply with the limits for a Class B digital device, pursuant to Part 15 of the FCC Rules. These limits are designed to provide reasonable protection against harmful interference in a residential installation. This equipment generates, uses, and can radiate radio frequency energy and, if not installed and used in accordance with the instructions, may cause harmful interference to radio communications. However, there is no guarantee that interference will not occur in a particular installation. If this equipment does cause harmful interference to radio or television reception, which can be determined by turning the equipment off and on, the user is encouraged to try to correct the interference by one or more of the following measures:

- 1) Reorient or relocate the receiving antenna.
- 2) Increase the separation between the equipment and receiver.
- 3) Connect the equipment into an outlet on a circuit different from that to which the receiver is connected.
- 4) Consult the dealer or an experienced radio/TV technician for help.

This Class B digital apparatus complies with Canadian ICES-003.

Cet appareil numérique de la classe B est conforme à la norme NMB-003 du Canada.

CAUTION: TO PREVENT ELECTRIC SHOCK, MATCH WIDE BLADE OF PLUG TO WIDE SLOT, FULLY INSERT.

ATTENTION: POUR ÉVITER LES CHOCs ÉLECTRIQUES, INTRODUIRE LA LAME LA PLUS LARGE DE LA FICHE DANS LA BORNE CORRESPONDANTE DE LA PRISE ET POUSSER JUSQU'AU FOND.

A NOTE ABOUT RECYCLING

This product's packaging materials are recyclable and can be reused. Please dispose of any materials in accordance with your local recycling regulations.

Batteries should never be thrown away or incinerated but disposed of in accordance with your local regulations concerning chemical wastes.

Make your contribution to the environment!!!

- Used up batteries do not belong in the dust bin.
- You can dispose of them at a collection point for used up batteries or special wastes. Contact your council for details.



For Customer Use:

Read carefully the information located at the bottom of this unit and enter below the Model No. and the Serial No. Retain this information for future reference.

Model No. _____

Serial No. _____

IMPORTANT SAFEGUARDS

- 1) Read Instructions - All the safety and operating instructions should be read before the product is operated.
 - 2) Retain Instructions - The safety and operating instructions should be retained for future reference.
 - 3) Heed Warnings - All warnings on the product and in the operating instructions should be adhered to.
 - 4) Follow Instructions - All operating and use instructions should be followed.
 - 5) Cleaning - Unplug this product from the wall outlet before cleaning. Do not use liquid cleaners or aerosol cleaners. Use a damp cloth for cleaning.
 - 6) Attachments - Do not use attachments not recommended by the product manufacturer as they may cause hazards.
 - 7) Water and Moisture - Do not use this product near water - for example, near a bath tub, wash bowl, kitchen sink, or laundry tub; in a wet basement; or near a swimming pool; and the like.
 - 8) Accessories - Do not place this product on an unstable cart, stand, tripod, bracket, or table. The product may fall, causing serious injury to a child or adult, and serious damage to the product. Use only with a cart, stand, tripod, bracket, or table recommended by the manufacturer, or sold with the product. Any mounting of the product should follow the manufacturer's instructions, and should use a mounting accessory recommended by the manufacturer.
- PORTABLE CART WARNING
(Symbol provided by RETAC)



S3125A
- 9) A product and cart combination should be moved with care. Quick stops, excessive force, and uneven surfaces may cause the product and cart combination to overturn.
 - 10) Ventilation - Slots and openings in the cabinet are provided for ventilation and to ensure reliable operation of the product and to protect it from overheating, and these openings must not be blocked or covered. The openings should never be blocked by placing the product on a bed, sofa, rug, or other similar surface. This product should not be placed in a built-in installation such as a bookcase or rack unless proper ventilation is provided or the manufacturer's instructions have been adhered to.
 - 11) Power Sources - This product should be operated only from the type of power source indicated on the marking label. If you are not sure of the type of power supply to your home, consult your product dealer or local power company. For products intended to operate from battery power, or other sources, refer to the operating instructions.
 - 12) Grounding or Polarization - This product may be equipped with a polarized alternating-current line plug (a plug having one blade wider than the other). This plug will fit into the power outlet only one way. This is a safety feature. If you are unable to insert the plug fully into the outlet, try reversing the plug. If the plug should still fail to fit, contact your electrician to replace your obsolete outlet. Do not defeat the safety purpose of the polarized plug.
 - 13) Power-Cord Protection - Power-supply cords should be routed so that they are not likely to be walked on or pinched by items placed upon or against them, paying particular attention to cords at plugs, convenience receptacles, and the point where they exit from the product.
 - 14) Lightning - For added protection for this product during a lightning storm, or when it is left unattended and unused for long periods of time, unplug it from the wall outlet. This will prevent damage to the product due to lightning and power-line surges.
 - 15) Power lines - An outside antenna system should not be located in the vicinity of overhead power lines or other electric light or power circuits, or where it can fall into such power lines or circuits. When installing an outside antenna system, extreme care should be taken to keep from touching such power lines or circuits as contact with them might be fatal.
 - 16) Overloading - Do not overload wall outlets, extension cords, or integral convenience receptacles as this can result in a risk of fire or electric shock.
 - 17) Object and Liquid Entry - Never push objects of any kind into this product through openings as they may touch dangerous voltage points or short-out parts that could result in a fire or electric shock. Never spill liquid of any kind on the product.
 - 18) Servicing - Do not attempt to service this product yourself as opening or removing covers may expose you to dangerous voltage or other hazards. Refer all servicing to qualified service personnel.
 - 19) Damage Requiring Service - Unplug this product from the wall outlet and refer servicing to qualified service personnel under the following conditions:
 - a) When the power-supply cord or plug is damaged.
 - b) If liquid has been spilled, or objects have fallen into the product.
 - c) If the product has been exposed to rain or water.
 - d) If the product does not operate normally by following the operating instructions. Adjust only those controls that are covered by the operating instructions as an improper adjustment of other controls may result in damage and will often require extensive work by a qualified technician to restore the product to its normal operation.
 - e) If the product has been dropped or damaged in any way.
 - f) When the product exhibits a distinct change in performance - this indicates a need for service.
 - 20) Replacement Parts - When replacement parts are required, be sure the service technician has used replacement parts specified by the manufacturer or have the same characteristics as the original part. Unauthorized substitutions may result in fire, electric shock, or other hazards.
 - 21) Safety Check - Upon completion of any service or repairs to this product, ask the service technician to perform safety checks to determine that the product is in proper operating condition.
 - 22) Heat - The product should be situated away from heat sources such as radiators, heat registers, stoves, or other products (including amplifiers) that produce heat.

Location and Handling

- Do not stand this unit up vertically. Install this unit in a horizontal and stable position. Do not place anything directly on top of this unit. Do not place this unit directly on top of the TV.
- Depending on the TV, noise or disturbance of the picture and/or sound may be generated if this unit is placed too close to your TV. In this case, please ensure enough space between your TV and this unit.
- Do not cover or place this unit in enclosed spaces to prevent excessive temperature build up.
- Do not place this unit in direct sunlight, or near heat sources.
- Depending on the environment, the temperature of this unit may increase slightly. This is not a malfunction.
- Keep this unit away from strong magnetic objects.
- Do not place any object containing water or other liquids on this unit. In the event that liquid should enter the cabinet, unplug this unit and contact the retailer or an Authorized Service Center immediately.
- Do not remove this unit cabinet. Touching parts inside the cabinet could result in electric shock and/or damage to this unit. For service and adjustment inside the cabinet, call a qualified dealer or an Authorized Service Center.
- Be sure to remove disc and unplug the AC power cord from the output before carrying this unit.

Avoid the Hazards of Electrical Shock and Fire

- Do not handle the power cord with wet hands.
- Do not pull on the power cord when disconnecting it from AC wall outlet. Grasp it by the plug.
- If, by accident, water is spilled on this unit, unplug the power cord immediately and take the unit to our Authorized Service Center for servicing.

Warning of Dew Formation

Moisture may form inside this unit under the following conditions:

- Immediately after a heater is turned on.
- In a steamy or humid room.
- When this unit is suddenly moved from a cold to warm environment.

If moisture forms inside this unit, it may not operate properly or damage the disc. In such case, turn on the power and wait for more than 2 hours for the moisture to evaporate.

About Copyright

Unauthorized copying, broadcasting, public performance and lending of discs are prohibited.

This product incorporates copyright protection technology that is protected by U.S. patents and other intellectual property rights. Use of this copyright protection technology must be authorized by Macrovision, and is intended for home and other limited viewing uses only unless otherwise authorized by Macrovision. Reverse engineering or disassembly is prohibited.

Symbols Used in This Manual

The following symbols appear in some headings in this manual.



: Description refers to playback of DVD-Video discs.



: Description refers to playback of Audio CDs.



: Description refers to playback of Video CDs.

Maintenance

SERVICING

- Please refer to relevant topics on the “Troubleshooting Guide” on page 17 before returning the unit.
- If this unit becomes inoperative, do not try to correct the problem by yourself. There are no user-serviceable parts inside. Turn off, unplug the power plug, and please call our help line mentioned on the front page to locate an Authorized Service Center.

CLEANING THE CABINET

- Use a soft cloth slightly moistened with a mild detergent solution. Do not use a solution containing alcohol, spirits, ammonia or abrasive.

CLEANING DISCS

- When a disc becomes dirty, clean it with a cleaning cloth. Wipe the disc from the center to out. Do not wipe in a circular motion.
- Do not use solvents such as benzine, thinner, commercially available cleaners, detergent, abrasive cleaning agents or antistatic spray intended for analog records.

CLEANING THE DISC LENS

- If this unit still does not perform properly although you refer to the relevant sections and to “Troubleshooting Guide” in this Owner’s Manual, the laser optical pickup unit may be dirty. Consult your dealer or an Authorized Service Center for inspection and cleaning of the laser optical pickup unit.

DISC HANDLING

- When you handle a disc hold it by its edge and try not to touch the surface of the disc.
- Always store a disc in its protective case when it is not used.

Manufactured under license from Dolby Laboratories. “Dolby” and the double-D symbol are trademarks of Dolby Laboratories.

About the Media

Playable Media

Playable discs	Mark (logo)	Region code	Recorded signals	Disc size	Disc types
DVD-Video *1, 2, 4, 6			Digital video (MPEG2)	12 cm or 8 cm	<p>Example: Title 1, Title 2, Chapter 1, Chapter 2, Chapter 3, Chapter 4, Chapter 1, Chapter 2</p>
DVD-R DVD-RW *1, 3, 4, 5, 6, 7, 9, 10		—			
DVD+R DVD+RW *1, 3, 4, 5, 6, 8, 9, 10		—			
Video CD *4, 6, 11		—	Digital video with audio	12 cm or 8 cm	<p>Example: Track 1, Track 2, Track 3, Track 4, Track 5, Track 6</p>
Audio CD *4, 6		—	Digital audio		
CD-R CD-RW *4, 5, 6, 9, 10		—			

DVD is a trademark of DVD Format/Logo Licensing Corporation.

If you cannot play back a disc which bears one of the marks above, check the following notes.

- *1: This unit conforms to the NTSC color system. Discs recorded in other color systems such as PAL cannot be played back.
- *2: Certain DVD-Video discs do not operate as described in this manual due to the intentions of the disc's producers.
- *3: Discs recorded in the VR (Video Recording) format cannot be played back.
- *4: Scratched or stained discs may not be played back.
- *5: Some discs cannot be played back because of incompatible recording conditions, characteristics of the recorder or special properties of discs.
- *6: You can play back discs which bear the marks above. If you use non-standardized discs, this unit may not play them back. Even if they are played back, the sound or video quality will be compromised.
- *7: You may play back the unfinalized DVD-R/RW disc recorded in the video format on our brand's DVD recorder. However, depending on the recording status of a disc, the disc may not be played back at all or normally (the picture or sound may not be smooth, etc.). In this case, you need to finalize the disc with the DVD recorder. Refer to the manual accompanying the DVD recorder.
- *8: Only the discs recorded in the video format and finalized can be played back. Unfinalized discs cannot be played back. Depending on the recording status of a disc, the disc may not be played back at all. The picture or sound may not be smooth, etc.
- *9: If the recorded portion of the disc is too small (smaller than 55mm across), it may not be played back.
- *10: Do not glue paper or put stickers on to the disc. These may damage the disc, and the unit may not read it correctly.
- *11: This unit conforms to ver.1.1 and ver.2.0 of Video CD standard with PBC function.
 - Ver.1.1 (without PBC function) : You can enjoy playback picture as well as music CD.
 - Ver.2.0 (with PBC function) : While using a Video CD with PBC function, "Pbc" appears on the screen and the display.

NOTE: When playing Video CDs with PBC function, some operations (e.g., track search and repeat tracks) cannot be performed. Cancel PBC function temporarily to perform those operations (refer to page 9).

What is PBC? "PBC" stands for Playback Control.

You can play interactive software using menu screens. Refer to instructions in the Video CD.

Unplayable Media

- **NEVER play back the following discs. Otherwise, malfunction may result!**
DVD-RAM / DVD-Audio / CD-i / Photo CD / DVD with region codes other than 1 or ALL / DTS-CD / DVD-ROM for personal computers / CD-ROM for personal computers
- **On the following disc, the sound MAY NOT be heard.**
Super Audio CD
- NOTE:**
Only the sound recorded on the normal CD layer can be delivered.
The sound recorded on the high density Super Audio CD layer cannot be delivered.
- **Any other discs without compatibility indications**

Setup

Connections

If your TV has AUDIO/VIDEO input jacks, see the following instructions. If not, see the section "Connecting to RF Modulator" on the front page.

Connection to a TV

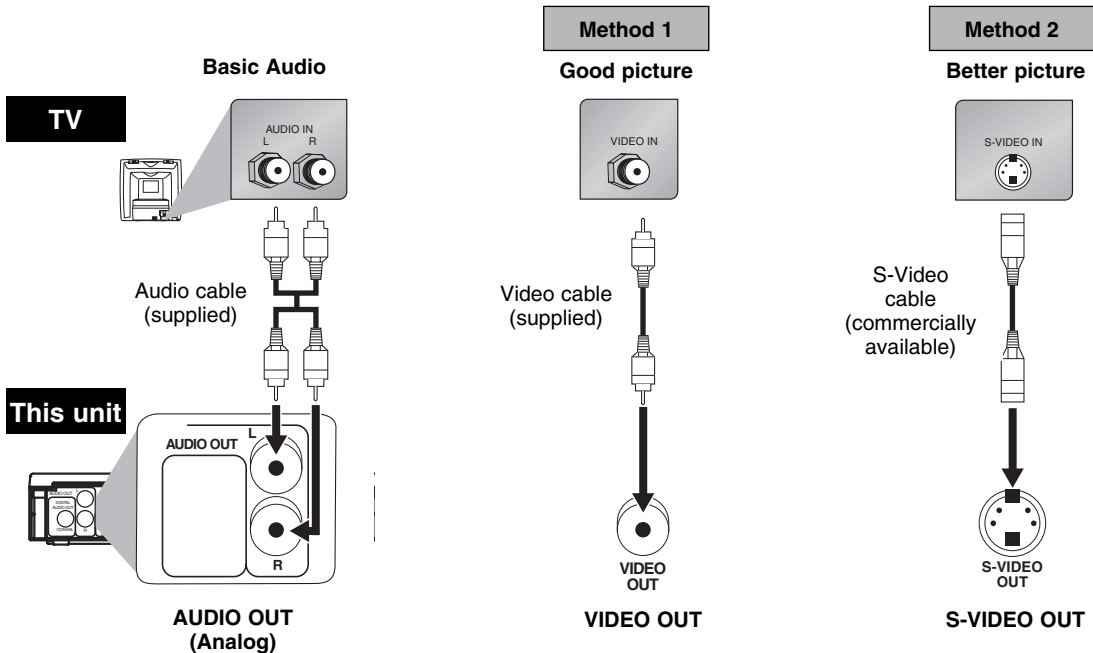

Hint

• Connect this unit directly to the TV. If the Audio/Video cables are connected to a VCR, pictures may be distorted due to the copy protection system.

After you have completed connections;

Press the input selector button (usually TV/VIDEO, INPUT or AUX) on your TV to switch an appropriate external input channel (usually near channel 0) for viewing the picture from this unit. If the picture does not appear, also refer to the manual accompanying your TV.

INPUT MODES FOR COMMON TV BRANDS

Listed below are inputs for common brand name TV's.

Admiral:	AUX	Panasonic:	TV/VIDEO
Curtis Mathis:	LINE1, LINE2, 00, 90, 91, 92, 93	RCA:	INPUT, TV/VCR, 00, 90, 91, 92, 93
GE:	INPUT, TV/VCR, 00, 90, 91, 92, 93	Samsung:	TV/VIDEO
Hitachi:	INPUT, AUX	Sanyo:	VIDEO
JVC:	VIDEO, VIDEO1, VIDEO2, VIDEO3	Sharp:	00
Kenwood:	AUX	Sony:	VIDEO1, VIDEO2, VIDEO3
LXI-Series:	00	Toshiba:	TV/GAME
Magnavox:	AUX CHANNEL	Zenith:	00

Connection to an Audio System

Playing 2 channel audio

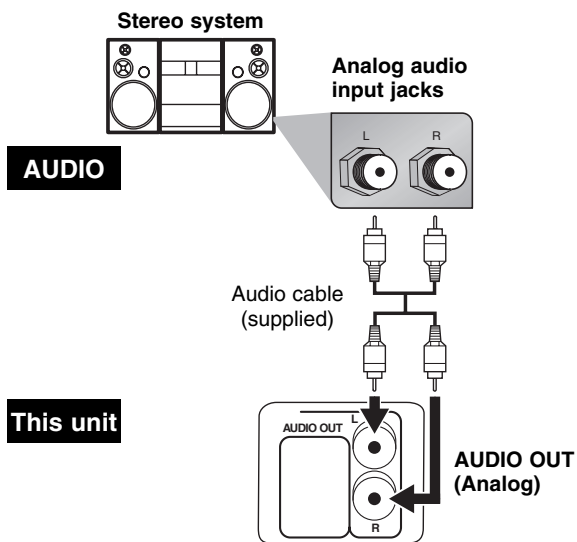

Hint

- Playing a DVD using incorrect settings may generate noise distortion and may also damage the speakers.

Playing Dolby Digital (Multi-channel audio)

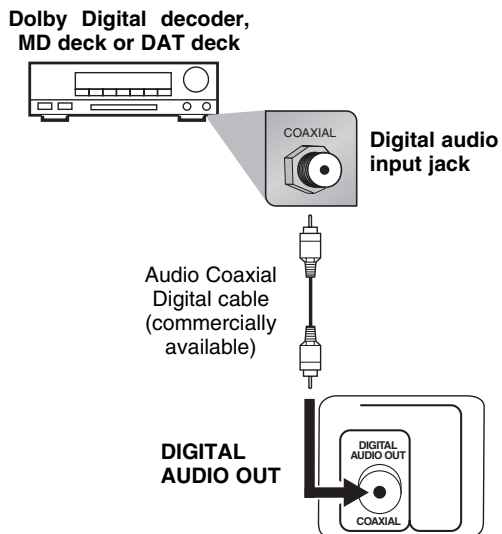

Setting	SETUP > QUICK>
Connection	DOLBY DIGITAL
Connecting to a Dolby Digital decoder for Dolby Digital audio output.	BITSTREAM
Connecting to other equipment (an MD deck or DAT deck etc.) without Dolby Digital decoder.	PCM

* To complete these settings, refer to pages 14-15.

Hint

- The audio source on a disc in a Dolby Digital Multi-channel Surround format cannot be recorded as digital sound by an MD or DAT deck.
- By hooking this unit up to a Multi-channel Dolby Digital decoder, you can enjoy high-quality Dolby Digital Multi-channel Surround sound as heard in the movie theaters.
- Playing a DVD using incorrect settings may generate noise distortion and may also damage the speakers.

Rear Terminals

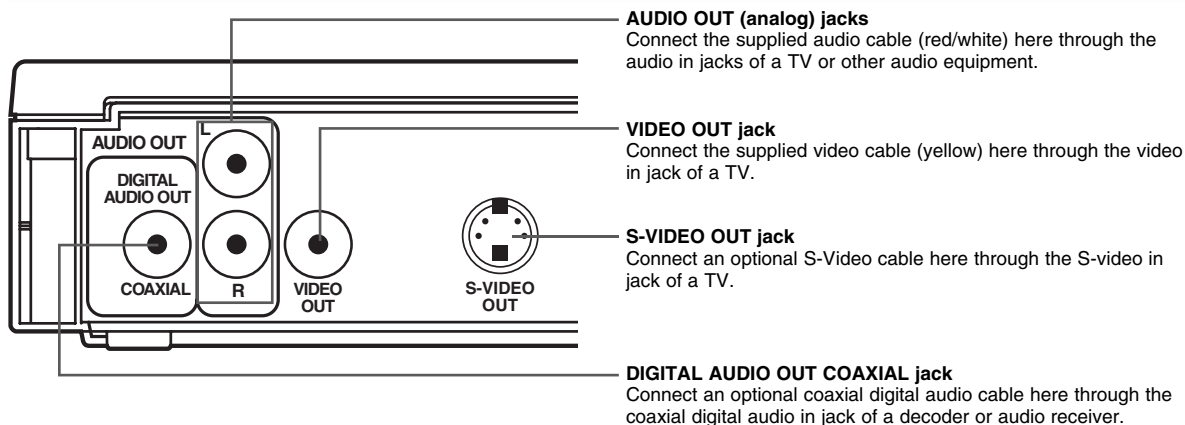

About the Remote Control

Remote Control

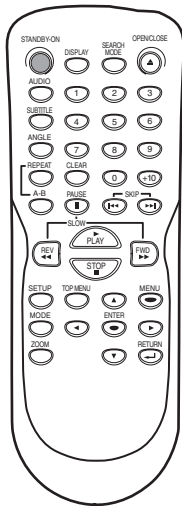

Installing the Batteries for the Remote Control

Install two AA batteries (supplied) matching the polarity indicated inside battery compartment of the remote control.



- Keep in mind the following when using the remote control:
- Make sure that there is no obstacle between the remote control and the remote sensor on the unit.
 - The maximum operable ranges from the unit are as follows.
 - **Line of sight:** approx. 23 feet (7m)
 - **Either side of the center:** approx. 16 feet (5m) within 30°
 - **Above:** approx. 16 feet (5m) within 15°
 - **Below:** approx. 10 feet (3m) within 30°

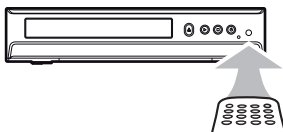

Hint

- Do not mix alkaline and manganese batteries.
- Do not mix old and new batteries.

Button (Alphabetical order)	Disc	DVD	CD	VCD
1-10		• To select chapter or title directly.	• To select track directly.	
ENTER		• To move the cursor and determine its position.	• To move the cursor and determine its position.	
A-B		• To repeat between your chosen point of A and B.	• To repeat between your chosen point of A and B.	
ANGLE		• To select camera angles on a disc.	—	
AUDIO		• To select audio language on a disc.	• To select STEREO, L-ch or R-ch.	
CLEAR		• To clear the markers. • To clear the numbers. • To cancel the point for A-B repeat.	• To clear the markers. • To remove status number in program input. (CD) • To clear the numbers entered incorrectly. • To cancel the point for A-B repeat.	
DISPLAY		• To display the current disc mode.	• To display the current disc mode.	
REV	FWD	• To search forward/backward through a disc. • To begin slow forward/reverse playback in the pause mode.	• To search forward/backward through a disc. • To begin slow forward playback in the pause mode. (VCD)	
MENU		• To call up the Menu on a disc.	—	
MODE		• To set black level on/off. • To set virtual surround on/off.	• To arrange the playing order or play randomly. (CD) • To set virtual surround on/off. • To set black level on/off. (VCD)	
OPEN/CLOSE		• To open or close the disc tray.	• To open or close the disc tray.	
PAUSE		• To pause disc playback. • To advance playback one frame at a time.	• To pause disc playback. • To advance playback one frame at a time. (VCD)	
PLAY		• To begin disc playback.	• To begin disc playback.	
REPEAT		• To play a chapter or title repeatedly.	• To play a track or disc repeatedly.	
RETURN		• To return to the previous operation in menu.	• To return to the previous operation menu.	
SEARCH MODE		• To search chapter, title or time. • To set or search the markers.	• To search tracks. • To search time. • To set or search the markers.	
SETUP		• To call up the DVD setup menu.	• To call up the DVD setup menu.	
SKIP		• To skip chapters or titles.	• To skip tracks.	
STANDBY-ON		• To turn the unit on/off.	• To turn the unit on/off.	
STOP		• To stop playback.	• To stop playback.	
SUBTITLE		• To select subtitles on a disc.	—	
TOP MENU		• To call up the Top Menu on a disc.	—	
ZOOM		• To magnify part of a picture. (x2/x4)	• To magnify part of a picture. (x2)(VCD)	

Functions

Operations described in this section are mainly based on the remote control use. Some operations can be carried out on main unit.

Playback

Before: Turn on the TV, amplifier and any other equipment which are connected to this unit. Make sure the TV and audio receiver (commercially available) are set to the correct channel.



- 1 Press [STANDBY-ON] to turn on the DVD/CD Player.
- 2 Press [OPEN / CLOSE ▲] and insert a disc with label facing up.
- 3 Press [PLAY ►] to start playback.
- 4 Press [STOP ■] to stop playback.

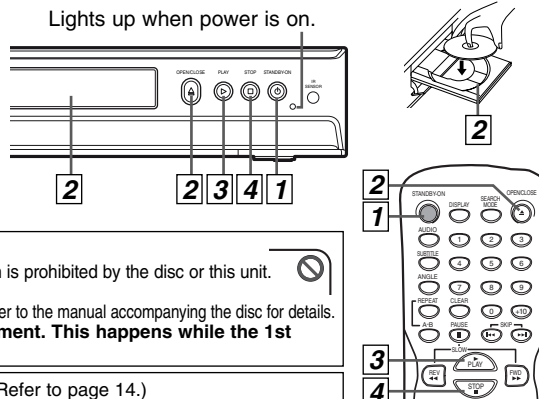

Hint

- A "prohibited icon" may appear at the top-right on the TV screen when the operation is prohibited by the disc or this unit.
- Some DVDs may start playback from title 2 or 3 due to specific programs.
- The operation may vary when you playback DVDs with disc menu or Video CDs with PBC. Refer to the manual accompanying the disc for details.
- **During the playback of a two-layered disc, pictures may stop for a moment. This happens while the 1st layer is being switched to the 2nd layer. This is not a malfunction.**

TIP: You can change the On-Screen language in "PLAYER MENU" setting. (Refer to page 14.)

Canceling and Calling Back PBC Function



- 1) Insert a Video CD and press [STOP ■].
- 2) Press the **Number buttons** to enter the desired Track number.
 - PBC function is now canceled and the playback of the Video CD will start.
- 3) To call back PBC function, press [STOP ■] twice, and then press [PLAY ►].
 - The title menu will appear on the display.

DVD menu



Some discs contain menus which allow you to customize DVD playback. Use [▲ / ▼ / ◀ / ▶] to select an item, then press [ENTER] (or [PLAY ►]).

Calling Up a Menu Screen during Playback



- Press [MENU] to call up the DVD menu.
- Press [TOP MENU] to call up the title menu.

Hint

- Menu operations may vary depending on the disc. Refer to the manual accompanying the disc for more details.

Resume



Press [STOP ■] during playback. Resume message will appear on the TV screen. Press [PLAY ►], playback will resume from the point at which playback was stopped.

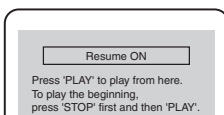

Hint

- To cancel resume, press [STOP ■] one more time in the stop mode.
- The resume information will be kept even when unit is in standby mode.
- Some Video CDs with the PBC function resume playback from the beginning of the track.

Paused and Step-by-Step Playback



Press [PAUSE II] during playback. To continue playback, press [PLAY ►].



The disc goes forward by one frame each time [PAUSE II] is pressed in the pause mode. To continue playback, press [PLAY ►].

Hint

- On DVDs, set "STILL MODE" to "FIELD" in the DISPLAY menu if pictures in the pause mode are blurred. (Refer to pages 14-15.)

Fast Forward / Reverse Search



Use [FWD ►►] or [REV ◀◀] repeatedly during playback to select the required forward or reverse speed. To continue playback, press [PLAY ►].

Hint

- For DVDs, fast forward or reverse search speed is different depending on the disc. Approximate speed is 1(x2), 2(x8), 3(x20), 4(x50) and 5(x100).
- For Audio CDs, Video CDs approximate speed is 1(x2), 2(x8) and 3(x30).

Slow Forward / Reverse



Press [FWD ►►] or [REV ◀◀] repeatedly in the pause mode to select the required forward or reverse speed. To continue playback, press [PLAY ►].

Hint

- Slow forward or reverse speed is different depending on the disc. Approximate speed is 1(1/16), 2(1/8) and 3(1/2).
- Set "STILL MODE" to "FIELD" in the DISPLAY menu if pictures in the slow playback mode are blurred. (Refer to pages 14-15.)
- Only slow forward is available when playing a Video CD.

Zoom



- 1) Press [ZOOM] repeatedly during playback to select the required zoom factor: x2, x4 or OFF.



- 2) Use [▲ / ▼ / ◀ / ▶] to slide the zoomed picture across the screen.
- 3) To exit zoom function, press [ZOOM] repeatedly to select OFF.

Hint

- Zooming function does not work while the disc menu is displayed.
- x4 zoom is not available on some discs.
- The picture may be distorted when you press [PAUSE II] or [REV ◀◀] repeatedly in the zoom mode.
- In the zoom mode, it automatically changes [x2/x4] to the zoomed position guide.
- Only x2 zoom is available on Video CDs.

On-Screen Display

You can check the information about the current disc by pressing **[DISPLAY]** on the remote control.

DVD

1. Angle icon appears in a case multi-angle is available on the DVD.
Current playback status
Remaining time of the current chapter
Elapsed time of the current chapter
CH (Chapter): Current chapter number / Total chapters

2. Remaining time of the current title
Elapsed time of the current title
TT (Title): Current title number / Total titles

3. Layer numbers, appears only when playing a two-layered Disc.
LO: Layer 0 is playing
L1: Layer 1 is playing
Current repeat setting appears only when the repeat setting is active.
C: Chapter repeat
T: Title repeat
A=B: A-B repeat
BIT RATE: The amount of audio and video data currently being read.

4.

CD VCD

1. Current playback status
Remaining time of the current track
Elapsed time of the current track
TR (Track): Current track number / Total tracks

2. ALL: Current track number / Total tracks
Current repeat setting appears only when the repeat setting is active.
C: Track repeat
A: All Tracks repeat
A=B: A-B repeat
Remaining time of the entire disc
Elapsed time of the entire disc

3.

Hint

- For the Audio CDs, when you are playing a disc in PROGRAM or RANDOM mode, **[TR]** PROGRAM (or RANDOM) will be displayed instead of **[2]**.
- [TR]** PBC is displayed when you play the Video CD with PBC function.

Search Function

SEARCH MODE does not work during the Programmed or Random Playback.

Using Title / Chapter Search

DVD

1. Press **[SEARCH MODE]** once for the chapter search.
Press twice for the title search.

2. Press title / chapter number, using the **Number buttons** within 30 seconds.

Using Track Search

CD VCD

1. Press track number, using the **Number buttons**.

- For single digit tracks (1-9), press a single number (e.g. track 3, press **[3]**).
- To play track 26, press **[+10]**, **[2]**, **[6]** of the **Number buttons**.

Using [SEARCH MODE]

1. Press **[SEARCH MODE]**.

2. Press track number, using the **Number buttons** within 30 seconds.

Using [SKIP <<<, >>>]

1. Use **[SKIP <<<, >>>]** to search title / chapter during playback.

Current Chapter (CH)
CH 1 CH 2 CH 3 CH 4
SKIP <<< SKIP >>>

or

Current Title (TT)
TT 1 TT 2 TT 3 TT 4
SKIP <<< SKIP >>>
(If the disc has no chapters)

Hint

- Depending on the disc being played, this function can also be performed by directly entering the desired chapter number with the **Number buttons**. Refer to the manual accompanying the disc.

Using [SKIP <<<, >>>]

1. Using **[SKIP <<<, >>>]** to search track.

Current Track (TR)
TR 1 TR 2 TR 3 TR 4
SKIP <<< SKIP >>>

Hint

- For Audio CDs and MP3, Track Search is not available for Program and Random Playback.
- Track Search is not available when you play the Video CD with PBC function.

Search Function

Using Time Search



1 Press **[SEARCH MODE]** repeatedly until the Time Search display appears during playback.

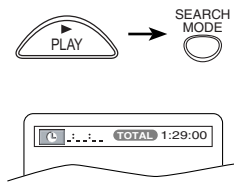

2 Press the desired time location on the disc, using the **Number buttons** within 30 seconds.

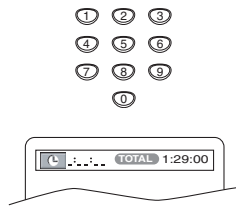

Hint

- When there is no need to enter a number, "0" appears automatically.
- For example, "0 : 0: --" appears in the Time Search display if the total time of the title or track is less than 10 minutes.
- Press **[CLEAR]** to erase the incorrect input at step 2.
- For Audio CDs, Track Search is not available for Program and Random Playback.
- Time Search is not available when you play the Video CD with PBC function.

Marker Setup



This feature allows you to assign a specific point on a disc to be called back later.

To set a marker

1 Press **[SEARCH MODE]** repeatedly until the marker display appears during playback.



2 Use **[</>]** to select the markers.

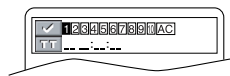

3 Press **[ENTER]** to set the markers.

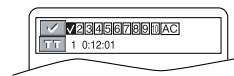

To return to the marker later

1 Press **[SEARCH MODE]** repeatedly until the marker display appears.



2 Use **[</>]** to select markers.

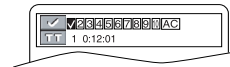

3 Playback will restart from the specific point which you have set as the desired marker.

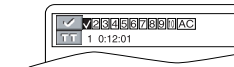

To exit the marker display

1 Press **[RETURN ↵]** to exit the marker display.



Hint

- Opening the disc tray or putting unit in standby mode will erase all markers.
- Selecting "AC" at step 2 in the section "To set a marker" or "To return to the marker later" will also erase all markers.
- To clear a marker, select the marker to be cleared at step 2 in the section "To set a marker" or "To return to the marker later," and then press **[CLEAR]**.
- The marker display will disappear in about 30 seconds when there is no output.
- Marker Setup is not available when you play the Video CD with PBC function.

Repeat / Random / Programmed Playback

Repeat Playback



Repeat function is available only during playback.

1 Press [REPEAT] during playback.

<Example: DVD>

Each time you press [REPEAT], repeat function changes as example below.

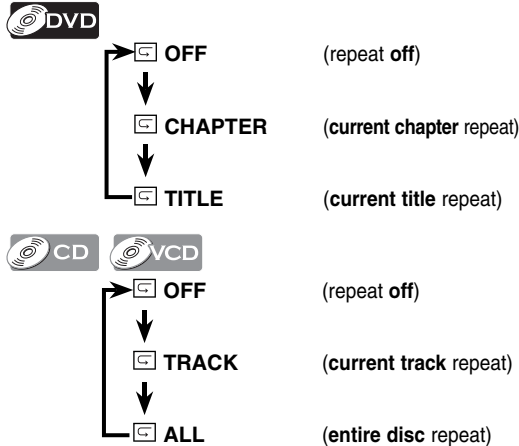

Hint

- Repeat setting will be cleared when moving to another title, chapter or track.
- Repeat playback may not function with some discs or during repeat A-B playback.
- Repeat playback is not available when you play the Video CD with PBC function.

Repeat A-B Playback



Repeat function is available only during playback.

1 Press [A-B] at your desired starting point (A).

2 Press [A-B] at your desired ending point (B).

• Point B should be in the same title or track as point A.

Hint

- To exit the sequence, press [A-B] so that "OFF" appears.
- To cancel point A, press [CLEAR] at step 1.
- This function does not work in the other repeat modes.
- The A-B Repeat section can only be set within the current title (for DVDs), or current track (for Audio CDs, Video CDs).

Random Playback



This function shuffles the playing order of tracks instead of playback in sequence.

1 Press [MODE] twice when any track is not in playback.

2 Press [PLAY] to start random playback.

Hint

- To repeat the current track in the random selections, press [REPEAT] repeatedly until "[TRACK]" appears during playback.
- To repeat the entire random selections, press [REPEAT] repeatedly until "[ALL]" appears during playback.
- During random playback, you cannot go back to the previous track.

Programmed Playback



You may determine the order in which tracks will play.

1 Press [MODE] once when any track is not in playback.

2 Use [▲ / ▼] at your desired track, then press [ENTER]. Up to 99 tracks can be ordered. If eight or more tracks are in a program, use [SKIP] to see all the tracks.

3 Press [PLAY] to start the program.

Hint

- Press [CLEAR] at step 2 to erase the most recently entered track.
- To erase all programmed tracks at once, select "ALL CLEAR" and press [ENTER] at step 2.
- While a program is being played back, [STOP] works as follows: Press [STOP] and [PLAY] next, so that the programmed playback restarts. Press [STOP] twice and [PLAY] next, so that playback restarts from the first track in the original order. However, your programmed playback can be restarted when you follow the above steps. (Your programs are still stored until either the disc tray is open or power is turned off.)
- To repeat the current track in the program, press [REPEAT] repeatedly until "[TRACK]" appears during playback.
- To repeat the entire program, press [REPEAT] repeatedly until "[ALL]" appears during playback.

Special Settings

Subtitle Language

DVD This unit allows you to select a subtitle language (if available) during DVD playback.

1 Press **[SUBTITLE]** during playback.

OFF (no subtitles)
 ENG (English subtitles)
 FRE (French subtitles)

Each time you press **[SUBTITLE]**, subtitle language changes as example above.

To set subtitle ON/OFF

1 Press **[SUBTITLE]** during playback.

2 Press **[▶]** to set ON or OFF.

Hint

- If your language is not shown after pressing **[SUBTITLE]** several times, the disc may not have that language. However, some discs have the subtitle language setting on the disc menu. (Operation varies depending on the disc, so refer to the manual along with the disc.)
- When "NOT AVAILABLE" appears on the TV screen, it means no subtitle is recorded on the scene.
- If you choose a language that has a three-letter-language code, the code will be displayed every time you change the subtitle language setting. If you choose any other languages, '---' will be displayed instead. (Refer to page 18.)
- Some discs will only allow you to change the subtitle from the disc menu. Refer to the manual accompanying the discs for details.

Audio Language

DVD This unit allows you to select an audio language (if multiple languages are available) during DVD playback.

1 Press **[AUDIO]** during DVD playback.

ENG (English audio)
 SPA (Spanish audio)
 FRE (French audio)

Each time you press **[AUDIO]**, the audio language changes as example above.

Hint

- Some discs will only allow you to change the audio setting from the disc menu. Refer to the manual accompanying the discs for details.
- When "OFF" appears on the TV screen, it means audio language is not available.
- If your language is not shown after pressing **[AUDIO]** several times, the disc may not have that language. However, some discs allow audio language setting on the disc menu. (Operation varies depending on the disc, so refer to the manual along with the disc.)

Camera Angles



Some DVD discs may contain scenes which have been shot simultaneously from various angles. You can change the camera angle if the angle icon appears on the screen. If the "ANGLE ICON" setting is "OFF" in the OTHERS menu, the angle icon will not appear. (Refer to pages 14-16.)

1 Press **[ANGLE]** during playback.



Black Level Setting

DVD VCD Adjust the Black Level Setting to make the dark areas of the TV picture brighter.

1 Press **[MODE]** during playback.



2 Press **[ENTER]** to adjust the Black Level Setting.



ON: Makes the dark areas brighter.
OFF: Shows the original picture as recorded.

3 Press **[RETURN ↵]** to exit the Black Level Setting.



Stereo Sound Mode

CD VCD This unit allows you to select a sound mode during CD playback.

1 Press **[AUDIO]** during CD playback.

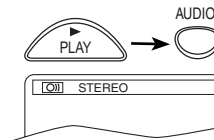

- STEREO (right and left channels are active)
 L-ch (left channel is active)
 R-ch (right channel is active)

Each time you press **[AUDIO]**, sound mode changes as example above.

Hint

- Virtual Surround cannot be changed when the sound mode is set to either L-ch or R-ch.

Virtual Surround



You can enjoy stereophonic virtual world on your existing 2 channel stereo system.

1 Press **[MODE]** twice (once for Audio CD) during playback.

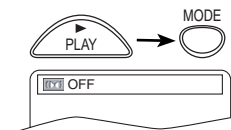

2 Press **[ENTER]** for the desired effect.



- 1: Natural effect
 2: Emphasized effect
 OFF: No effects (original sound)

3 Press **[RETURN ↵]** to exit the Virtual Surround Setting.



Hint

- The setting will be kept even if the unit is turned off.
- Virtual Surround will not be effective if the sound mode is set to something other than "STEREO" (for Audio CD and Video CD playback only). Refer to "Stereo Sound Mode".
- Turn down the level or select "OFF" if the sound is distorted.
- When playing back 96kHz with Virtual Surround function, the sound will be down sampled at 48kHz and output as digital audio.

DVD Setup

QUICK SETUP Menu

You can select the "PLAYER MENU", "TV ASPECT" or "DOLBY DIGITAL" from the QUICK SETUP menu quickly.

1 Press [SETUP] in the stop mode.

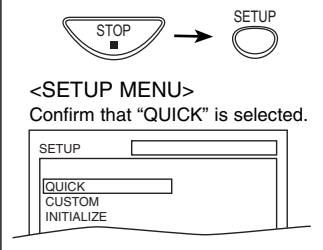

2 Select the desired item.

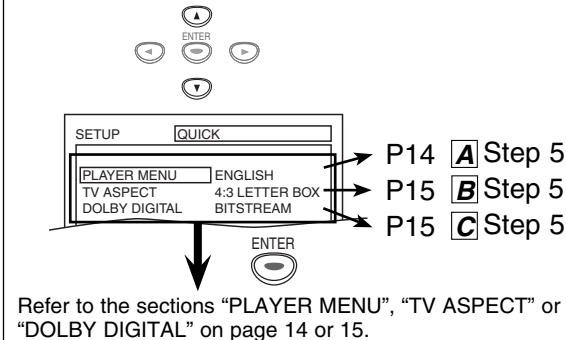

Refer to the sections "PLAYER MENU", "TV ASPECT" or "DOLBY DIGITAL" on page 14 or 15.

CUSTOM Menu

You can change the settings of the unit.

- **QUICK** on pages 14-15 indicates DVD Setup menus also accessible from the QUICK SETUP menu.

1 Press [SETUP] in the stop mode.

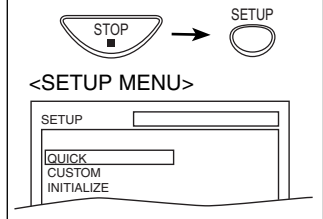

2 Select "CUSTOM".

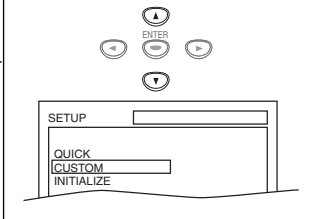

3 Select the desired item.

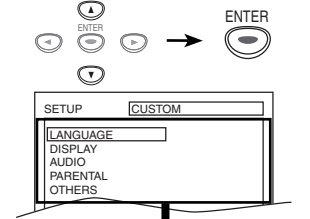

LANGUAGE menu

DISPLAY menu

AUDIO menu

PARENTAL menu

OTHERS menu

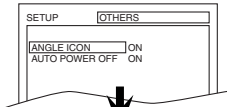
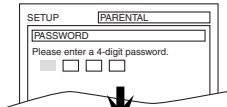
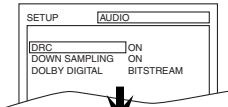
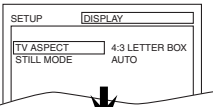
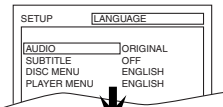

page 14 **A**

page 15 **B**

page 15 **C**

page 16 **D**

page 16 **E**

A LANGUAGE Setting

Follow steps 1 to 3 in the "CUSTOM Menu" section above.

4 Select the desired item.

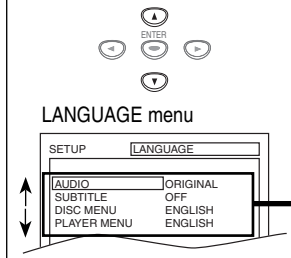

Hint

• In QUICK SETUP Menu, "PLAYER MENU", "TV ASPECT" or "DOLBY DIGITAL" are available. QUICK SETUP Menu consists of the setting menus frequently used, and they are accompanied with **QUICK** mark. You can make all settings in CUSTOM Menu.

5 Select the desired language.

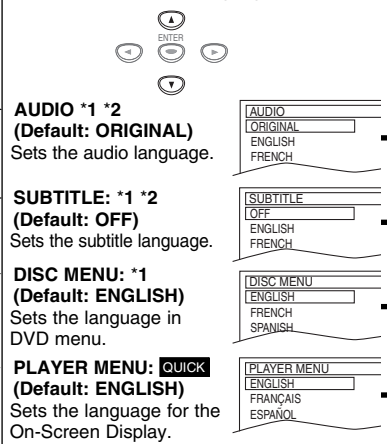

6 To exit the menu



Hint

- *1**
- Language options are not available with some discs.
 - If OTHER is selected in the AUDIO, SUBTITLE or DISC MENU screen, press a four-digit number to enter the code for the desired language. (Refer to the language code list on page 18.)
 - Only the languages supported by the disc can be selected.
- *2**
- Language setting for Audio and Subtitle are not available with some discs. Then press [AUDIO] and [SUBTITLE]. Details are on page 13.

B DISPLAY Setting

You can change the display functions. Follow steps 1 to 3 in the "CUSTOM Menu" section on page 14.

4 Select the desired item.

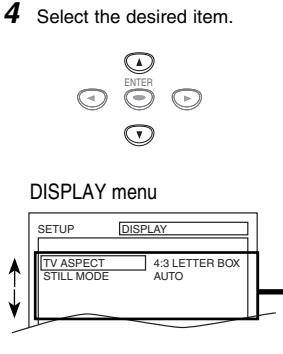

Hint

- In QUICK SETUP Menu, "PLAYER MENU", "TV ASPECT" or "DOLBY DIGITAL" are available. QUICK SETUP Menu consists of the setting menus frequently used, and they are accompanied with **QUICK** mark. You can make all settings in CUSTOM Menu.

5

TV ASPECT: **QUICK**
(Default: 4:3 LETTER BOX)
See Hint on the right.

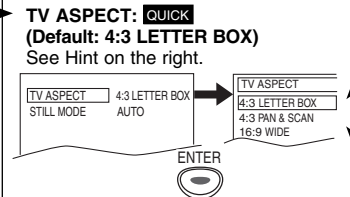

STILL MODE:
(Default: AUTO)
See Hint on the right.

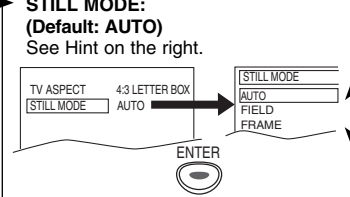

6 To exit the menu

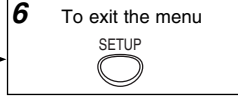

Hint

TV ASPECT:

- Select "4:3 LETTER BOX", so that black bars may appear on the top and bottom of the screen.
- Select "4:3 PAN & SCAN" for a full height picture with both sides adjusted.
- Select "16:9 WIDE" if a wide-screen TV is connected to this unit.

STILL MODE:

- Select "AUTO" usually.
- If you select "FIELD", the picture in the still mode will be stabilized.
- If you select "AUTO", automatically select the best resolution setting (FRAME or FIELD) based on the data characteristics of the pictures. (default)
- If you select "FRAME", the picture in the still mode will be highly defined.
- An individual picture on the TV screen is called as "frame", which consists of two separate images called a "field".
- Some pictures may be blurred if you select "AUTO" in the still mode due to their data characteristics.

C AUDIO Setting

Choose the appropriate audio settings for your equipment. It only affects during the playback of DVD discs. Follow steps 1 to 3 in the "CUSTOM Menu" section on page 14.

4 Select the desired item.

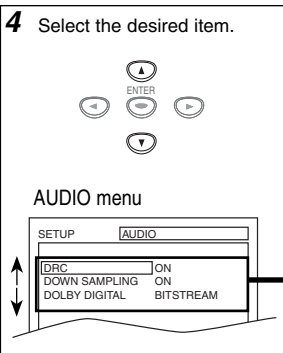

Hint

- In QUICK SETUP Menu, "PLAYER MENU", "TV ASPECT" or "DOLBY DIGITAL" are available. QUICK SETUP Menu consists of the setting menus frequently used, and they are accompanied with **QUICK** mark. You can make all settings in CUSTOM Menu.

5

DRC (Dynamic Range Control):
(Default: ON)
Set to "ON" to compress the range between soft and loud sounds.

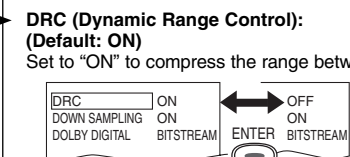

DOWN SAMPLING:
(Default: ON)
Set to "ON" when outputting in 48kHz.
Set to "OFF" when outputting the original sound.

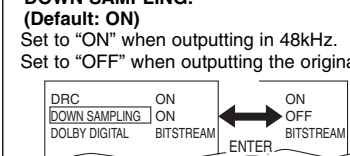

DOLBY DIGITAL: **QUICK**
(Default: BITSTREAM)
Set to "BITSTREAM" when the unit is connected to a Dolby Digital decoder.

- BITSTREAM: outputs Dolby Digital Signals.
- PCM: convert the Dolby Digital into PCM (2 channel).

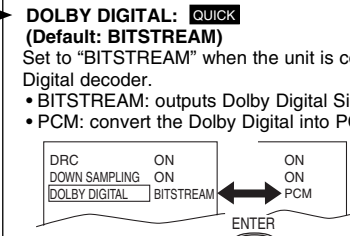

6 To exit the menu

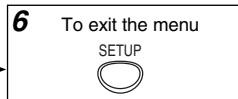

Hint

DRC:

- This function is available only on the discs which are recorded in the Dolby Digital format.

DOWN SAMPLING:

- When playing back a 96kHz disc with the copyright protection, or when Virtual Surround is set to "1" or "2", the sound will be down sampled at 48kHz and output as digital Audio even if the "DOWN SAMPLING" is set to "OFF".
- This function is available only on digital outputting of a disc recorded in 96kHz.

D PARENTAL Setting

Parental Control limits the disc viewing that exceed your settings. (An incorrect password will not be acceptable.) This feature prevents your children from viewing inappropriate materials.

Parental Levels

Parental Level allows you to set the rating levels of your DVD discs. Playback will stop if the ratings exceed the levels you set. Follow steps 1 to 3 in the "CUSTOM Menu" section on page 14.

4 Enter your desired four-digit password.

PARENTAL menu

SETUP PARENTAL

PASSWORD

Please enter a 4-digit password.

□ □ □ □

..... Or

If you have set a password already, enter the current four-digit password.

SETUP PARENTAL

PASSWORD

Enter current password.

□ □ □ □

5 Select "PARENTAL LEVEL".

PARENTAL LEVEL ALL

PASSWORD CHANGE

CONTROL LEVELS

- ALL: All parental locks are canceled. DVD softwares of any grades (adult / general / children) can be played back.
- Level 8: DVD softwares of any grades (adult / general / children) can be played back.
- Levels 7 to 2: Only DVD softwares intended for general use and children can be played back.
- Level 1: Only DVD softwares intended for children can be played back, with those intended for adult and general use prohibited.

TIPS FOR LEVELS

- 8 [ADULT]: DVD software of any grades (adult/general/children) can be played back.
- 7 [NC-17]: No one under 17 admitted
- 6 [R]: Restricted; under 17 requires accompanying parent or adult guardian
- 5 [PGR]: Parental Guidance Recommended
- 4 [PG13]: Unsuitable for children under 13
- 3 [PG]: Parental Guidance suggested
- 2 [G]: General Audience
- 1 [KID SAFE]: Suitable for children

Hint

- DVD-Video discs may not respond to the Parental Lock settings. Make sure this function works with your DVD-Video discs.

6 Select the desired level.

PARENTAL LEVEL

ALL

8 [ADULT]

7 [NC-17]

6 [R]

7 To exit the menu

SETUP

To Change the Password for Parental Controls

You can change your password for parental controls. Follow steps 1 to 3 in the "CUSTOM Menu" section on page 14.

4 Enter the current four-digit password.

PARENTAL menu

SETUP PARENTAL

PASSWORD

Enter current password.

□ □ □ □

5 Select "PASSWORD CHANGE".

PARENTAL LEVEL ALL

PASSWORD CHANGE

6 Enter your new four-digit password (except for 4737).

SETUP PARENTAL

PASSWORD

Please enter a 4-digit password.

□ □ □ □

7 To exit the menu

SETUP

Hint

- Record the password in case you forget it.
- If you forget the password, enter [4], [7], [3], [7] at step 4, then enter your new password. Password will be cleared and Parental Levels will be set to "ALL".

E OTHERS Setting

You can change the other functions. Follow steps 1 to 3 in the "CUSTOM Menu" section on page 14.

4 Select the desired item.

OTHERS menu

SETUP OTHERS

ANGLE ICON ON

AUTO POWER OFF ON

5 **ANGLE ICON:**
(Default: ON)
Set to "ON" to show the angle icon when multiple camera angles are available during DVD playback.

ANGLE ICON ON OFF

AUTO POWER OFF ON ON ENTER

AUTO POWER OFF:
(Default: ON)
Set to "ON" to turn this unit off automatically after 30 minutes of no use.

ANGLE ICON ON ON

AUTO POWER OFF ON ON OFF ENTER

6 To exit the menu

SETUP

Reset to the Default Setting (except for PARENTAL Setting)

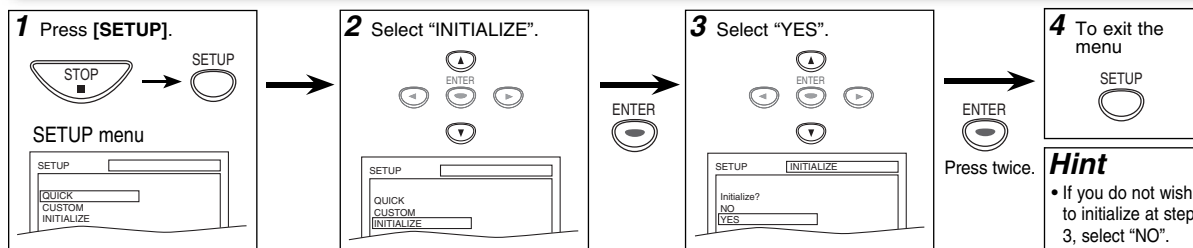

Information

Troubleshooting Guide

If the unit does not perform properly when operated as instructed in this Owner's Manual, check the unit consulting the following checklist.

Problem	Solution
No power	<ul style="list-style-type: none"> -Check if the AC power cord is properly connected. -Unplug the outlet once, and wait for 5-10 seconds and then plug it in again.
No sound or picture	<ul style="list-style-type: none"> -Check if the TV is switched on. -Check the video connection. -Check the VIDEO/AUDIO cable connections to the TV. (See page 6.)
Distorted picture	<ul style="list-style-type: none"> -Sometimes a small amount of picture distortion may appear. This is not a malfunction. -Connect the unit directly to the TV.
Completely distorted picture or black/white picture with DVD	<ul style="list-style-type: none"> -Connect the unit directly to the TV. -Make sure the disc is compatible with the unit.
No sound or distorted sound	<ul style="list-style-type: none"> -Adjust the volume. -Check that the speakers are connected correctly.
No audio at digital output	<ul style="list-style-type: none"> -Check the digital connections. -Check if the audio format of the selected audio language matches your receiver capabilities.
No DTS audio is output.	<ul style="list-style-type: none"> -This unit does not support DTS audio. -This is not a malfunction.
Picture freezes momentarily during playback.	<ul style="list-style-type: none"> -Check the disc for finger prints/scratches and clean with a soft cloth wiping from center to edge.
Disc can't be played.	<ul style="list-style-type: none"> -Clean the disc. -Ensure the disc label is facing up. -Check if the disc is defective by trying another disc. -Cancel the parental lock or change the control level. -Insert a correct disc that plays on this unit. -Handle a disc with special care so that it does not have fingerprints, scratches, or dusts on its surface.
No return to start-up screen when disc is removed.	<ul style="list-style-type: none"> -Reset the unit by switching the unit off, then on again.
The unit does not respond to the remote control.	<ul style="list-style-type: none"> -Aim the remote control directly at the sensor on the front of the unit. -Reduce the distance to the unit. -Replace the batteries in the remote control. -Re-insert the batteries with their polarities (+/- signs) as indicated. -Tune your radio to an empty AM station so that you hear a lot of static. Then, turn the volume up. If you hear some signal sound from the radio by pressing buttons on the remote control, the remote control is working.
Buttons do not work or the unit stops responding.	<ul style="list-style-type: none"> -To completely reset the unit, unplug the AC cord from the AC outlet for 5-10 seconds.
The unit does not respond to some operating commands during playback.	<ul style="list-style-type: none"> -Operations may not be permitted by the disc. Refer to the instructions of the disc.
The unit cannot read CDs / DVDs.	<ul style="list-style-type: none"> -Use a commonly available cleaning CD / DVD to clean the lens before sending the unit for repair.
Angle does not switch.	<ul style="list-style-type: none"> -The angle cannot be switched for DVDs which do not contain multiple angles. In some cases multiple angles are only recorded for specific scenes.
The password for rating level has been forgotten.	<ul style="list-style-type: none"> -Enter the default password "4737", then your forgotten password will be cleared.

NOTES:

- Some functions are not available in specific modes, but this is not a malfunction. Read the description in this Owner's Manual for more details on correct operations.
- Playback from a desired track and random playback are not available during program playback.
- Some functions are prohibited on some discs.
- When playing Video CDs with PBC function, some operations (e.g., select and track repeat) cannot be performed.

Specifications

Output signal format:

NTSC color

Power source:

120 V AC +/- 10%, 60 Hz +/- 0.5%

Power consumption:

10 W (standby: 0.8 W)

Operating temperature:

41°F (5°C) to 104°F (40°C)

Dimensions:

W : 9 5/8 " (245 mm)

H : 2 1/16 " (52 mm)

D : 9 11/16 " (246 mm)

Weight :

Approx. 1.9 lbs (0.9 kg)

• Designs and specifications are subject to change without notice.

• If there is a discrepancy between languages, the default language will be English.

Language Code List

Language	Code	Language	Code	Language	Code	Language	Code
	A-B	French [FRE]	5264	Macedonian	5957	Siswat	6565
Abkhazian	4748	Frisian	5271	Malagasy	5953	Slovak	6557
Afar	4747	Galician	5358	Malay	5965	Slovenian	6558
Afrikaans	4752	Georgian	5747	Malayalam	5958	Somali	6561
Albanian	6563	German [GER]	5051	Maltese	5966	Spanish [SPA]	5165
Amharic	4759	Greek [GRE]	5158	Maori	5955	Sundanese	6567
Arabic	4764	Greenlandic	5758	Marathi	5964	Swahili	6569
Armenian	5471	Guarani	5360	Moldavian	5961	Swedish [SWE]	6568
Assamese	4765	Gujarati	5367	Mongolian	5960		
Aymara	4771	Hausa	5447	Nauru	6047	Tagalog	6658
Azerbaijani	4772	Hebrew	5569	Nepali	6051	Tajik	6653
Bashkir	4847	Hindi	5455	Norwegian [NOR]	6061	Tamil	6647
Basque	5167	Hungarian [HUN]	5467			Tatar	6666
Bengali;Bangla	4860			O-R		Telugu	6651
Bhutani	5072	Icelandic [ICE]	5565	Occitan	6149	Thai	6654
Bihari	4854	Indonesian	5560	Oriya	6164	Tibetan	4861
Bislama	4855	Interlingua	5547	Oromo (Afan)	6159	Tigrinya	6655
Breton	4864	Interlingue	5551	Panjabi	6247	Tonga	6661
Bulgarian	4853	Inupiak	5557	Pashto;Pusho	6265	Tsonga	6665
Burmese	5971	Irish [IRI]	5347	Persian	5247	Turkish [TUR]	6664
Byelorussian	4851	Italian [ITA]	5566	Polish [POL]	6258	Turkmen	6657
	C-E	Japanese [JPN]	5647	Portuguese [POR]	6266	Twi	6669
Cambodian	5759	Javanese	5669	Quechua	6367		
Catalan	4947	Kannada	5760	Rhaeto-Romance	6459		
Chinese [CHI]	7254	Kashmiri	5765	Romanian [RUM]	6461	U-Z	
Corsican	4961	Kazakh	5757	Russian [RUS]	6467	Ukrainian	6757
Croatian	5464	Kinyarwanda	6469			Urdu	6764
Czech [CZE]	4965	Kirghiz	5771	S		Uzbek	6772
Danish [DAN]	5047	Kirundi	6460	Samoan	6559	Vietnamese	6855
Dutch [DUT]	6058	Korean [KOR]	5761	Sangho	6553	Volapuk	6861
English [ENG]	5160	Kurdish	5767	Sanskrit	6547	Welsh	4971
Esperanto	5161			Scots Gaelic	5350	Wolof	6961
Estonian	5166			Serbian	6564	Xhosa	7054
	F-H	Laothian	5861	Serbo-Croatian	6554	Yiddish	5655
Faroese	5261	Latin	5847	Sesotho	6566	Yoruba	7161
Fiji	5256	Latvian;Lettish	5868	Setswana	6660	Zulu	7267
Finnish [FIN]	5255	Lingala	5860	Shona	6560		
		Lithuanian	5866	Sindhi	6550		
				Singhalese	6555		

If you choose a Language that has a 3 letter language code, the code will be displayed every time you change the Audio or Subtitle language setting on page 13. If you choose any other languages, '---' will be displayed instead. (3 letter language code is written in bracket.)

PHILCO Limited Warranty

FUNAI CORP. will repair this product, free of charge in the USA in the event of defect in materials or workmanship as follows:

DURATION:

PARTS: FUNAI CORP. will provide parts to replace defective parts without charge for one (1) year from the date of original retail purchase. Certain parts are excluded from this warranty.

LABOR: FUNAI CORP. will provide the labor without charge for a period of ninety (90) days from the date of original retail purchase.

LIMITS AND EXCLUSIONS:

This warranty is extended only to the original retail purchaser. A purchase receipt or other proof of original retail purchase will be required together with the product to obtain service under this warranty.

This warranty shall not be extended to any other person or transferee.

This warranty is void and of no effect if any serial numbers on the product are altered, replaced, defaced, missing or if service was attempted by an unauthorized service center. This limited warranty does not apply to any product not purchased and used in the United States.

This product is produced for home use and this warranty only covers failures due to defects in material or workmanship which occurs during normal use. It does not cover damage which occurs in shipment, or failures which are caused by repairs, alterations or product not supplied by FUNAI CORP., or damage which results from accident, misuse, abuse, mishandling, misapplication, alteration, faulty installation, improper maintenance, commercial use such as hotel, rental or office use of this product or damage which results from fire, flood, lightning or other acts of God.

THIS WARRANTY DOES NOT COVER PACKING MATERIALS, ANY ACCESSORIES (EXCEPT REMOTE CONTROL), ANY COSMETIC PARTS, COMPLETE ASSEMBLY PARTS, DEMO OR FLOOR MODELS, FUNAI CORP. AND ITS REPRESENTATIVES OR AGENTS SHALL IN NO EVENT BE LIABLE FOR ANY GENERAL, INDIRECT OR CONSEQUENTIAL DAMAGES ARISING OUT OF OR

OCCASIONED BY THE USE OF OR THE INABILITY TO USE THIS PRODUCT. THIS WARRANTY IS MADE IN LIEU OF ALL OTHER WARRANTIES, EXPRESS OR IMPLIED, AND OF ALL OTHER LIABILITIES ON THE PART OF FUNAI, ALL OTHER WARRANTIES INCLUDING THE WARRANTY OF MERCHANTABILITY, AND FITNESS FOR A PARTICULAR PURPOSE, ARE HEREBY DISCLAIMED BY FUNAI AND ITS REPRESENTATIVES IN THE UNITED STATES. ALL WARRANTY INSPECTIONS AND REPAIRS MUST BE PERFORMED BY AN AUTHORIZED SERVICE CENTER. THIS WARRANTY IS VALID WHEN THE UNIT IS CARRIED-IN TO AN AUTHORIZED SERVICE CENTER.

IMPORTANT:

THIS LIMITED WARRANTY GIVES YOU SPECIFIC LEGAL RIGHTS. YOU MAY HAVE OTHER RIGHTS THAT VARY FROM STATE TO STATE. IF, AT ANY TIME DURING THE WARRANTY PERIOD, YOU ARE UNABLE TO OBTAIN SATISFACTION WITH THE REPAIR OF THIS PRODUCT, PLEASE CONTACT FUNAI CORP.

ATTENTION:

FUNAI CORP. RESERVES THE RIGHT TO MODIFY ANY DESIGN OF THIS PRODUCT WITHOUT PRIOR NOTICE.

WARRANTY STATEMENT REGARDING NON AUTHORIZED REPAIRS:

To obtain warranty service, you must take the product, or deliver the product freight prepaid, in either its original packaging or packaging affording an equal degree of protection, to any AUTHORIZED SERVICE CENTER. FUNAI CORP. will not reimburse you for any service done by unauthorized service providers without prior written approval.

To locate your nearest AUTHORIZED SERVICE CENTER or for general service inquiries, please contact us at:

FUNAI CORPORATION
Customer Service

Tel :1-800-317-6062

<http://www.funai-corp.com>

19900 Van Ness Avenue, Torrance, CA 90501

1 Conexiones

Si su televisor tiene entradas de AUDIO/VIDEO vea la sección "Connection to a TV" en la página 6 en el Manual de Manejo. En caso contrario, vea la sección "Connecting to RF Modulator" en la página del frente en el Manual de Manejo.

2 Instalación de las pilas en el control remoto



3 Para cambiar el idioma en la pantalla

1 Confirme que ha seleccionado "QUICK".

2 Confirme que ha seleccionado "PLAYER MENU".

3 Seleccione el idioma deseado para las indicaciones en la pantalla.

4 Para salir del menú

4 Reproducción



Antes.

¡Encienda el televisor, amplificador y otros equipos conectados a esta unidad. Asegúrese que el televisor y el sintonizador de audio (de venta en los comercios) están en el canal correcto.

1	2 Ponga un disco con la etiqueta hacia arriba.
3 Para empezar la reproducción	4 Para parar la reproducción

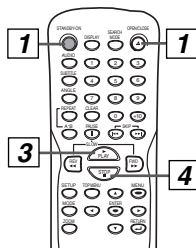

5 Control remoto

Botón (Orden alfabético)	Disco 	
1 2 3 4 5 6 7 8 9 0	• Para seleccionar directamente el capítulo o título.	• Para seleccionar directamente la canción.
ENTER ← → ↑ ↓	• Para mover el cursor y determinar la posición.	• Para mover el cursor y determinar la posición.
A-B	• Para repetir entre su punto A y B seleccionado.	• Para repetir entre su punto A y B seleccionado.
ANGLE	• Para seleccionar los ángulos de cámara en un disco.	—
AUDIO	• Para seleccionar idiomas de audio en un disco.	• Para seleccionar ESTÉREO, L-ch o R-ch.
CLEAR	• Para borrar los marcadores. • Para borrar los números mal entrados. • Para borrar el punto para la repetición A-B.	• Para borrar los marcadores. • Para eliminar el N° de estado en la entrada de programa. (CD) • Para borrar los números mal entrados. • Para borrar el punto para la repetición A-B.
DISPLAY	• Para mostrar el modo de disco actual.	• Para mostrar el modo de disco actual.
REV FWD	• Para buscar en avance/retroceso por un disco. • Para empezar la reproducción en avance lento/retroceso durante el modo de pausa.	• Para buscar en avance/retroceso por un disco. • Para empezar la reproducción en avance lento durante el modo de pausa. (VCD)
MENU	• Para llamar el Menú en un disco.	—
MODE	• Para activar/desactivar el nivel del negro. • Para activar/desactivar el ambiental virtual.	• Para disponer el orden de reproducción o la reproducción aleatoria. (CD) • Para activar/desactivar el ambiental virtual. • Para activar/desactivar el nivel del negro. (VCD)
OPEN/CLOSE	• Para abrir o cerrar la bandeja del disco.	• Para abrir o cerrar la bandeja del disco.
PAUSE	• Para hacer una pausa en la reproducción. • Para avanzar la reproducción un cuadro cada vez.	• Para hacer una pausa en la reproducción del disco. • Para avanzar la reproducción un cuadro a la vez. (VCD)
PLAY	• Para empezar la reproducción del disco.	• Para empezar la reproducción del disco.
REPEAT	• Para reproducir repetidamente un capítulo o título.	• Para reproducir repetidamente una canción o disco.
RETURN	• Para volver a la operación anterior en el menú.	• Para volver a la operación anterior en el menú.
SEARCH MODE	• Para buscar un capítulo, título o tiempo. • Para colocar o buscar los marcadores.	• Para buscar una canción. • Para buscar el tiempo. • Para colocar o buscar los marcadores.
SETUP	• Para llamar el menú de ajustes de DVD.	• Para llamar el menú de ajustes de DVD.
SKIP	• Para saltar capítulos o título.	• Para saltar canciones.
STANDBY-ON	• Para encender o apagar la unidad.	• Para encender o apagar la unidad.
STOP	• Para parar la reproducción.	• Para parar la reproducción.
SUBTITLE	• Para seleccionar subtítulos en un disco.	—
TOP MENU	• Para llamar el menú inicial en un disco.	—
ZOOM	• Para ampliar la imagen de vídeo en DVD. (x2 / x4)	• Para ampliar parte de la imagen. (x2)(VCD)

Quick Use Guide

1 Connections

If your TV has AUDIO/VIDEO input jacks, see the section "Connection to a TV" on page 6 of the Owner's Manual. If not, see the section "Connecting to RF Modulator" on the front page of the Owner's Manual.

2 Installing the Batteries for the Remote Control

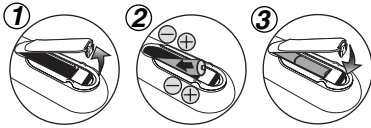

3 To Change the On-Screen Language

1 Confirm that "QUICK" is selected.

2 Confirm that "PLAYER MENU" is selected.

3 Select the desired language for the On-Screen Display.

4 To exit the menu

4 Playback



Before:

Turn on the TV, amplifier and any other equipment which are connected to this unit. Make sure the TV and audio receiver (commercially available) are set to the correct channel.

1 Turn on the TV, amplifier and any other equipment which are connected to this unit. Make sure the TV and audio receiver (commercially available) are set to the correct channel.

2 Insert a disc with label facing up.

3 To start playback

4 To stop playback

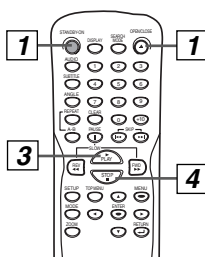

5 Remote Control

Button (Alphabetical order)	Disc	DVD	CD VCD
1 2 3 4 5 6 7 8 9 0		• To select chapter or title directly.	• To select track directly.
ENTER ← → ↓		• To move the cursor and determine its position.	• To move the cursor and determine its position.
A-B		• To repeat between your chosen point of A and B.	• To repeat between your chosen point of A and B.
ANGLE		• To select camera angles on a disc.	—
AUDIO		• To select audio language on a disc.	• To select STEREO, L-ch or R-ch.
CLEAR		• To clear the markers. • To clear the numbers. • To cancel the point for A-B repeat.	• To clear the markers. • To remove status number in program input. (CD) • To clear the numbers entered incorrectly. • To cancel the point for A-B repeat.
DISPLAY		• To display the current disc mode.	• To display the current disc mode.
REV FWD		• To search forward/backward through a disc. • To begin slow forward/reverse playback in the pause mode.	• To search forward/backward through a disc. • To begin slow forward playback in the pause mode. (VCD)
MENU		• To call up the Menu on a disc.	—
MODE		• To set black level on/off. • To set virtual surround on/off.	• To arrange the playing order or play randomly. (CD) • To set virtual surround on/off. • To set black level on/off. (VCD)
OPEN/CLOSE		• To open or close the disc tray.	• To open or close the disc tray.
PAUSE		• To pause disc playback. • To advance playback one frame at a time.	• To pause disc playback. • To advance playback one frame at a time. (VCD)
PLAY		• To begin disc playback.	• To begin disc playback.
REPEAT		• To play a chapter or title repeatedly.	• To play a track or disc repeatedly.
RETURN		• To return to the previous operation in menu.	• To return to the previous operation menu.
SEARCH MODE		• To search chapter, title or time. • To set or search the markers.	• To search tracks. • To search time. • To set or search the markers.
SETUP		• To call up the DVD setup menu.	• To call up the DVD setup menu.
SKIP		• To skip chapters or titles.	• To skip tracks.
STANDBY-ON		• To turn the unit on/off.	• To turn the unit on/off.
STOP		• To stop playback.	• To stop playback.
SUBTITLE		• To select subtitles on a disc.	—
TOP MENU		• To call up the Top Menu on a disc.	—
ZOOM		• To magnify part of a picture. (x2/x4)	• To magnify part of a picture. (x2)/(VCD)

Free Manuals Download Website

<http://myh66.com>

<http://usermanuals.us>

<http://www.somanuals.com>

<http://www.4manuals.cc>

<http://www.manual-lib.com>

<http://www.404manual.com>

<http://www.luxmanual.com>

<http://aubethermostatmanual.com>

Golf course search by state

<http://golfingnear.com>

Email search by domain

<http://emailbydomain.com>

Auto manuals search

<http://auto.somanuals.com>

TV manuals search

<http://tv.somanuals.com>