

Register your product and get support at

[www.philips.com/welcome](http://www.philips.com/welcome)



CD 455  
SE 455

---

US Telephone Answering Machine

---



### **Warning**

Use only rechargeable batteries.

Charge the handset for 24 hours before use.

**PHILIPS**



# Table of contents

<b>1</b>	<b>Important Safety Instructions</b>	<b>4</b>	4.8	Switching your handset ON/OFF	17
<b>2</b>	<b>Important</b>	<b>6</b>	4.9	Menu structure	18
2.1	Power requirements	6	<b>5</b>	<b>Call</b>	<b>22</b>
2.2	Conformity	7	5.1	Making a call	22
2.3	Environmental	7	5.2	Ending a call	23
2.4	Recycling & disposal	7	5.3	Answering a call	23
2.5	Electric, Magnetic and Electromagnetic Fields ("EMF")	7	5.4	During a call	23
<b>3</b>	<b>Your phone</b>	<b>9</b>	5.5	Using the speaker or handsfree	23
3.1	What's in the box	9	5.6	Making a second call	24
3.2	Overview of your phone	10	<b>6</b>	<b>Intercom and Conference Calls</b>	<b>25</b>
3.3	Overview of the base station	11	6.1	Calling another handset	25
3.4	Display icons	12	6.2	Transferring a call	25
3.5	The menus	12	6.3	Making a conference call	25
<b>4</b>	<b>Getting started</b>	<b>13</b>	<b>7</b>	<b>Text and Numbers</b>	<b>27</b>
4.1	Connect the base station	13	7.1	Entering text and numbers	27
4.2	Connect your charger	13	7.2	Switching between uppercase and lowercase	27
4.3	Install your handset	15	<b>8</b>	<b>Phonebook</b>	<b>28</b>
4.4	Checking the battery level	16	8.1	Viewing the phonebook	28
4.5	Setting the clock	16	8.2	Calling from the phonebook	28
4.6	What is standby mode?	17			
4.7	Checking the signal strength	17			

# Table of contents

8.3	Adding a record	28	11.1	Personalizing your phone's display	34
8.4	Editing a record	29	11.2	Personalizing your phone's sounds	34
8.5	Setting VIP melodies	29	<b>12</b>	<b>Calling Features</b>	<b>36</b>
8.6	Deleting a record	29	12.1	Auto hang up	36
8.7	Deleting all records	29	12.2	Auto conference	36
8.8	Using quick dial	29	12.3	Dial mode	36
<b>9</b>	<b>Call log</b>	<b>31</b>	12.4	Flash selection	36
9.1	Viewing the call records	31	12.5	Call barring	36
9.2	Editing the caller's number before returning a call	31	12.6	Area code management	37
9.3	Returning a call	31	12.7	Auto prefix	37
9.4	Saving a call record to your phonebook	31	12.8	First ring	38
9.5	Deleting a call record	32	<b>13</b>	<b>Network Services</b>	<b>39</b>
9.6	Deleting all call records	32	13.1	Call forward	39
<b>10</b>	<b>Redial List</b>	<b>33</b>	13.2	Voicemail	39
10.1	Viewing the redial records	33	13.3	Info center	40
10.2	Redialing a call	33	13.4	Call return	40
10.3	Saving a redial record to your phonebook	33	13.5	Cancel call back	40
10.4	Deleting a redial record	33	13.6	Withholding ID	41
10.5	Deleting all redial records	33	<b>14</b>	<b>Extra Features</b>	<b>42</b>
<b>11</b>	<b>Custom Options</b>	<b>34</b>	14.1	Alarm clock	42
			14.2	Easy call	42

# Table of contents

14.3	Keypad lock	43	<b>18</b>	<b>Technical Data</b>	<b>52</b>
14.4	Missing handset(s)	43	<b>19</b>	<b>Frequently asked questions</b>	<b>53</b>
<b>15</b>	<b>The System</b>	<b>44</b>	<b>20</b>	<b>Appendix</b>	<b>55</b>
15.1	Registering handset(s)	44	20.1	Equipment approval Information	55
15.2	Un-registering a handset	44	20.2	Notification to the local telephone company	55
15.3	Changing your PIN	44	20.3	Notes	55
15.4	Restoring default settings	44	20.4	Rights of the Phone Company	55
<b>16</b>	<b>The Answering Machine</b>	<b>46</b>	20.5	Interference Information	56
16.1	Turning on the answering machine	46	20.6	Noise	57
16.2	Turning off the answering machine	46	20.7	FCC RF Radiation Exposure Statement	57
16.3	Setting the answering machine language	47	20.8	Hearing Aid Compatibility (HAC)	57
16.4	Setting the answer mode	47	20.9	Privacy	57
16.5	Greetings (OGM)	47	20.10	Additional Information	57
16.6	Incoming messages (ICM)	48	20.11	Terminal Equipment	57
16.7	Call screening	49	20.12	Radio Equipment	58
16.8	Message alert	49	20.13	Do not attempt to repair or modify this equipment	58
16.9	Setting the ring delay	49	20.14	The RBRC® seal	58
16.10	Remote access	50	<b>21</b>	<b>Index</b>	<b>59</b>
<b>17</b>	<b>Default (pre-programmed) settings</b>	<b>51</b>			

---

# 1 Important Safety Instructions

Some of the following information may not apply to your particular product; however, when using telephone equipment, basic safety precautions should always be followed to reduce the risk of fire, electric shock and injury to persons, including the following:

1. Read and understand all instructions.
2. Follow all warnings and instructions marked on the product.
3. Unplug this product from the wall outlet before cleaning. Do not use liquid cleaners or aerosol cleaners. Use a damp cloth for cleaning.
4. Telephones should not be used while you are in a bathtub, shower or pool. Immersion of the telephone or handset in water could cause an electrical shock.
5. Slots and openings in the cabinet back or bottom are provided for ventilation, to protect it from overheating. These openings must not be blocked or covered. The openings should never be blocked by placing the product on the bed, sofa, rug, or other similar surface. This product should not be placed in a built-in installation unless proper ventilation is provided.
6. This product should be operated only from the type of power source indicated on the marking label. If you are not sure of the type of power supply to your home, consult your dealer or local power company.
7. Do not allow anything to rest on the power cord. Do not locate this product where the cord will be abused by persons walking on it.
8. Do not overload wall outlets and extension cords as this can result in the risk of fire or electric shock.
9. Never push objects of any kind into this product through cabinet slots as they may touch dangerous voltage points or short out parts that could result in a risk of fire or electric shock. Never spill liquid of any kind on the product.
10. To reduce the risk of electric shock, do not disassemble this product, but take it to a qualified service personnel when service or repair work is required. Opening or removing covers may expose you to dangerous voltages or other risks. Incorrect reassembly can cause electric shock when the appliance is subsequently used.
11. Do not expose the product to extreme temperatures such as areas near a hot radiator or stove or in a hot car.
12. Do not place lighted candles, cigarettes, cigars, etc., on the telephone.
13. Never touch uninsulated telephone wires or terminals unless the telephone line has been disconnected at the network interface.
14. Never install or modify telephone wiring during a lightning storm.
15. Never install telephone jacks in wet locations unless the jack is specifically designed for wet locations.
16. Use caution when installing or modifying telephone lines to prevent electrical shock and/or fire.
17. Unplug this product from the wall outlet and refer servicing to qualified service personnel under the following conditions:
  - A. When the power supply cord or plug is damaged or frayed.
  - B. If the product has been exposed to rain or water.

- C. If the product does not operate normally by following the operating instructions.
  - D. If the product's cabinet has been damaged.
  - E. If the product exhibits a distinct change in performance.
18. Avoid using a telephone (other than a cordless type) during an electrical storm. There may be a remote risk of electric shock from lightning.
  19. Do not use the telephone to report a gas leak in the vicinity of the leak.
  20. Do not place this product on an unstable cart, stand or table. The product may fall, causing serious damage to the product.

**IF YOUR PRODUCT UTILIZES BATTERIES, THE FOLLOWING ADDITIONAL PRECAUTIONS SHOULD BE OBSERVED:**

1. Use only the type and size of battery(ies) specified in the user manual.
2. Do not dispose of the battery(ies) in fire. They may explode. Check with local codes for possible special disposal instructions.
3. Do not open or mutilate the battery(ies). Released electrolyte is corrosive and may cause damage to the eyes or skin. It may be toxic if swallowed.
4. Exercise care in handling battery(ies) in order not to short out the battery(ies) with conducting materials such as rings, bracelets, and keys. The battery(ies) or conductor may overheat and cause burns.
5. Do not attempt to recharge the battery(ies) provided with or identified for use with this product that are not intended to be charged. The battery(ies) may leak corrosive electrolyte or explode.
6. Do not attempt to rejuvenate the battery(ies) provided with or identified for use with this product by heating them. Sudden release of the battery(ies) electrolyte may occur causing burns or irritation to eyes or skin.
7. When replacing battery(ies), all batteries should be replaced at the same time. Mixing fresh and discharged batteries could increase internal cell pressure and rupture the discharged battery(ies). (Applies to products employing more than one separately replaceable primary battery.)
8. When inserting battery(ies) into this product, the proper polarity or direction must be observed. Reverse insertion of battery(ies) can cause charging, and that may result in leakage or explosion.
9. Remove battery(ies) from this product if storing over 30 days because the battery(ies) could leak and damage the product.
10. Discard "dead" battery(ies) as soon as possible since "dead" batteries are more likely to leak in a product.
11. Do not store this product, or the battery(ies) provided with or identified for use with this product, in high-temperature areas. Batteries that are stored in a freezer or refrigerator for the purpose of extending shelf life should be protected from condensation during storage and defrosting. Batteries should be stabilized at room temperature prior to use after cold storage.
12. If your product uses rechargeable battery(ies), charge the battery(ies) only in accordance with the instructions and limitation specified in the User Manual.

**SAVE THESE INSTRUCTIONS**

---

## 2 Important

This product is not designed for making emergency telephone calls when the power fails. Alternative arrangements should be made for access to emergency services.

---

### 2.1 Power requirements

- This product requires an electrical supply of 100-240 volts, single-phase alternating current, excluding IT installations defined in standard UL 60950.
- The electrical network is classified as dangerous according to criteria in the standard UL 60950. The only way to power down this product is by unplugging the power supply from the electrical outlet. Ensure the electrical outlet is located close to the apparatus and is always easily accessible.
- The voltage on the network is classified as TNV-3 (Telecommunication Network Voltages, as defined in the standard UL 60950). Following a power cut, the call in progress, as well as the date and time settings will be lost.
- Use only Class 2 Power Source or Limited Power Source (L.P.S.), rated of 7.5 V dc, 500 mA for Model CD455XY/ZZ and SE455XY/ZZ; rated of 7.5 V dc, 200 mA for Model CD455C and SE455C.

#### Warning

- Do not allow the handset to come into contact with liquids or moisture.

- Do not open the handset, base station or charger. This could expose you to high voltages.
- Do not allow the charging contacts or the battery to come into contact with conductive materials.
- There is a slight chance that your product could be damaged by an electrical storm. We recommend that you unplug the product from the power supply and telephone socket during a storm.
- Do not use the handset in an explosive hazard area such as where there is gas leaking.
- It is recommended that this product is not used near intensive care medical equipment or by persons with pacemakers.
- This product can interfere with electrical equipment such as answering machines, television, radio, and computers if placed too close. We recommend that you position the base station at least one meter from such appliances.
- Use only the main adapter supplied with this equipment. Incorrect adapter polarity or voltage can seriously damage the unit.
- **RISK OF EXPLOSION IF BATTERY IS REPLACED BY AN INCORRECT TYPE.** Never use non-rechargeable batteries. Use the recommended type supplied with this product. NiMH batteries must be disposed of in accordance with the applicable waste disposal regulations.
- Handsfree activation could suddenly increase the volume in the earpiece to



a very high level: make sure the handset is not too close to your ear.

- This equipment is not designed to make emergency calls when the power fails. An alternative has to be made available to allow emergency calls.
- Do not expose the phone to excessive heat caused by heating equipment or direct sunlight.
- Do not drop your phone or allow objects to fall on your phone.
- Do not use any cleaning agents containing alcohol, ammonia, benzene, or abrasives as these may harm the set.
- Do not use the product in places where there are explosive hazards.
- Do not let small metal objects come into contact with the product. This can deteriorate audio quality and damage the product.
- Active mobile phones in the vicinity may cause interference.

About operating and storage temperatures:

- Operate in a place where temperature is always between 0 and 40° C.
- Store in a place where temperature is always between -25 and 70° C.
- Battery life may be shortened in low temperature conditions.

### **Warning**

Metallic objects may be retained if placed near or on the handset receiver.

---

## **2.2 Conformity**

We, Philips declare that the product is in compliance with the essential requirements and other relevant

provisions of Directive 1999/5/EC. This product can only be connected to the analogue telephone networks of the countries mentioned on the packaging. You can find the Declaration of Conformity on [www.p4c.philips.com](http://www.p4c.philips.com).

---

## **2.3 Environmental**

Remember to observe local regulations regarding the disposal of your packaging materials, exhausted batteries and old equipment. Promote their recycling where possible.

---

## **2.4 Recycling & disposal**

Disposal instructions for batteries:

Batteries should not be disposed of with general household waste.



Packaging information:

Philips has marked the packaging with standard symbols designed to promote the recycling and appropriate disposal of your eventual waste.



A financial contribution has been paid to the associated national recovery & recycling system.



The labelled packaging material is recyclable.

---

## **2.5 Electric, Magnetic and Electromagnetic Fields ("EMF")**

1. Philips Royal Electronics manufactures and sells many consumer oriented products which usually, as with any electronic apparatus, have the ability to emit and receive electro magnetic signals.

2. One of Philips' leading Business Principles is to take all necessary health and safety precautions for our products, to comply with all applicable legal requirements and to stay well within the EMF standards applicable at the time of producing the products.
3. Philips is committed to develop, produce and market products that cause no adverse health effects.
4. Philips confirms that if its products are handled properly for their intended use, they are safe to use according to scientific evidence available today.
5. Philips plays an active role in the development of international EMF and safety standards, enabling Philips to anticipate further developments in standardisation for early integration in its products.

---

## 3 Your phone

Congratulations on your purchase and welcome to Philips!

To fully benefit from the support that Philips offers, register your product at [www.philips.com/welcome](http://www.philips.com/welcome).

---

### 3.1 What's in the box

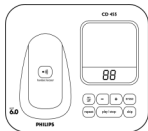

**Base station  
with Bracket**



**Handset**



**Battery door**



**Belt clip**



**Power supply**



**NiMH AAA Rechargeable  
Batteries x 2**



**Line Cord\***



**User Manual**



**Guarantee**



**Quick start  
guide**









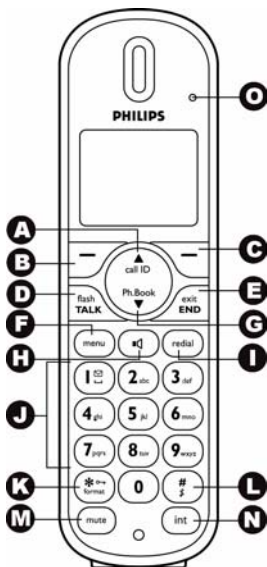



#### **Note**

\*The line adapter may not be attached to the line cord. You may find the line adapter in the box. In this case, you have to connect the line adapter to the line cord first before plugging the line cord to the line socket.

In multi-handset packs, you will find one or more additional handsets, chargers with power supply units and additional rechargeable batteries.

## 3.2 Overview of your phone





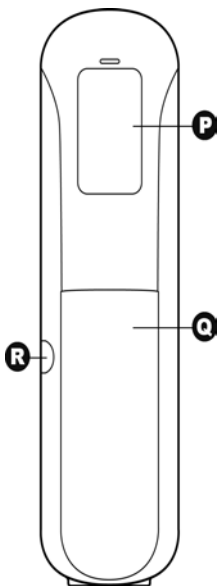



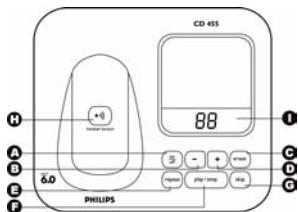

- A Call Log/Up key**   
Scroll up menu  
Increase earpiece volume  
Enter call log
- B OK key**   
Confirm selection  
Enter options menu
- C Back/Clear key**   
Delete text or digit(s)  
Cancel operation  
View more record information
- D Talk/Flash key**   
Make and receive calls  
Send flash signal
- E End /On/Off key**   
End call  
Exit menu / operation  
Turn handset on/off
- F Menu key**   
Access main menu
- G Phonebook/Down key**   
Scroll down menu  
Decrease earpiece volume  
Enter phonebook
- H Speaker key**   
Turn speaker on / off
- I Redial key**   
Enter redial list & dial last number
- J Digit keys**  
Dial digit and enter text  
Use as shortcut key for quick dial
- K Star/Keylock/Format key**   
Dial \*  
Lock / unlock keypad  
Edit caller's number in call log review
- L Ringer Off/Pause key**   
Dial # and enter pause  
Turn ringer on / off  
Switch between lower and upper case
- M Mute key**   
Mute / unmute microphone
- N Intercom/Conference key**   
Make intercom call  
Make conference call
- O New event LED**  
New calls, messages, voicemails



- P Loudspeaker**
- Q Battery door**
- R Headset jack**

### 3.3 Overview of the base station



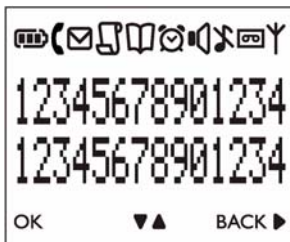

- A On/Off key**  Turn the answering machine on/off
- B Volume down**  Decrease speaker volume
- C Delete key**  Delete messages
- D Volume up**  Increase speaker volume
- E Previous key**  Skip backward during playback
- F Play/Stop key**  Play messages  
Stop message playback
- G Next key**  Skip forward during playback
- H Handset locator key**  Locate handset(s)
- I Message counter**  
Enter registration mode  
Display message number  
Display answering machine operation

### 3.4 Display icons



Each icon gives you a visual message of what is happening on your handset.

 Battery is fully charged

 Battery is fully discharged

 Signal strength

 Call in progress

 Alarm on

 Speaker on

 Ringer off

 Call log

 Phonebook

 Answering machine

 Voicemail indicator

 More options upward

 More options downward





### 3.5 The menus

Your phone offers a variety of features and functions grouped in the menus.

#### 3.5.1 Browsing the menus

The main menu includes the Phonebook, Personal Set, Clock & Alarm, Advanced Set, Network Service and Answering Machine menus.

From standby mode, you can,

- Press  to enter the main menu.
- Press  to enter the incoming call log.
- Press  to enter the phonebook.
- Press  to enter the redial list.

**\* Tip**  
Use  or  to navigate the menus.

**\* Tip**  
**Quick Exit.** Press and hold  to exit from any menu instantly. All unconfirmed changes will not be saved.

---

## 4 Getting started

---

### 4.1 Connect the base station

- 1 Connect the output plug of the main adapter to the bottom of the base station.



- 2 Connect the main adapter to a standard wall outlet.
- 3 Connect the telephone line cord to the phone socket at the bottom of the base station and the wall phone socket.

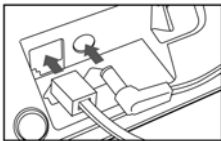

#### Note

The power adapter (for the phone and charger) are intended to be correctly orientated in a vertical or floor mount position.

---

### 4.2 Connect your charger (For multi-pack models only)

- 1 Connect the output plug of the main adapter to the bottom of the charger.

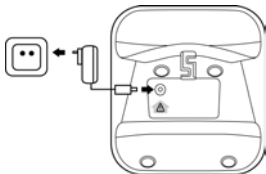

- 2 Connect the main adapter to a standard wall outlet.

---

#### 4.2.1 Wall mounting the base (CD455)

The base is designed to support wall mounting. To wall mount the base, follow the instructions below.

#### Warning

Other wall mounting methods are not recommended and may damage the product.

- 1 Remove the bracket from the back of the base station by pressing down the two latches on the top of the bracket.

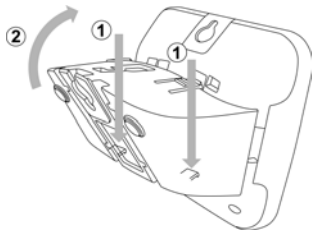

- 2 Turn the bracket around.

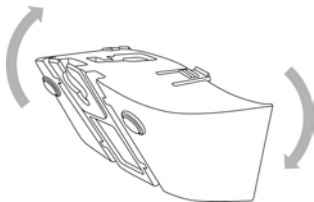

- 3 Re-insert the bracket to the back of the base station.

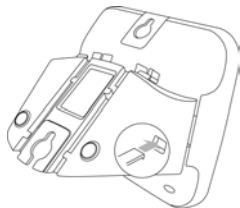

- 4 Align the mounting holes on the back of the base with a standard wall phone mounting jack.

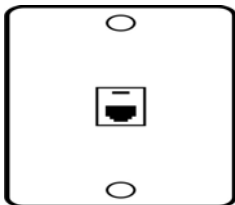

- 5 Slide the base down into place.

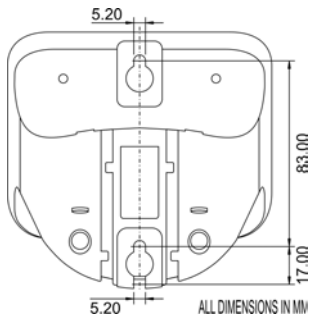

#### 4.2.2 Wall mounting the base (SE455)

The base is designed to support wall mounting. To wall mount the base, follow the instructions below.

##### **Warning**

Other wall mounting methods are not recommended and may damage the product.

- 1 Remove the bracket from the back of the base station by pressing down the two latches on the top of the bracket.



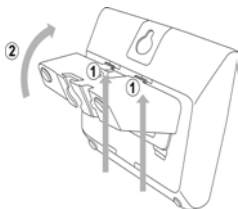

- 2** Turn the bracket around.

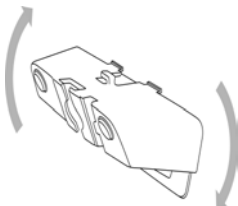

- 3** Re-insert the wall-mount bracket to the back of the base station.

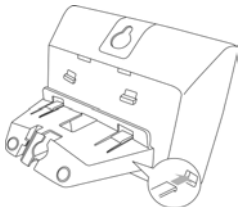

- 4** Align the mounting holes on the back of the base with a standard wall phone mounting jack.

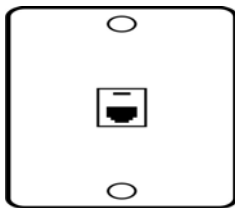

- 5** Slide the base down into place.

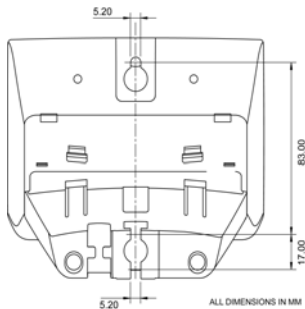

### 4.3 Install your handset

#### **Warning**

RISK OF EXPLOSION IF BATTERY IS REPLACED BY AN INCORRECT TYPE. Never use non-rechargeable batteries. Use recommended type supplied with this product. NiMH batteries must be disposed of in accordance with the applicable waste disposal regulations.

### Note

Charge the handset(s) for 24 hours before initial use!

### Warning

Check the battery polarity when inserting in the battery compartment. Incorrect polarity may damage the product.

- 1 Place the 2 rechargeable batteries (included) into the battery compartment.

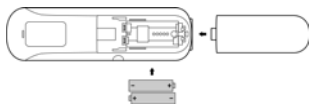

- 2 Slide the battery door firmly into place.
- 3 Place the handset on the base.





### Note

Handset may get warm during initial charging. This is normal. The handset may take a few seconds to power up.

## 4.4 Checking the battery level

The battery icon displays the current battery level.

	Battery full
	Battery empty. Require charging.

Your handset may power down shortly if it is not charged after the battery is empty. If you are on the phone when the battery is nearly empty, you will hear warning tones. Your call may be cut off shortly after the warning.

## 4.5 Setting the clock

Your phone has a digital clock. Set the clock before initial use of the phone.

### 4.5.1 Setting the date and time

- 1 Press **(menu)**.
- 2 Select **CLOCK & ALARM > SET DATE/TIME**. Press **OK**.
- 3 Use the digit keys to enter the date.
- 4 Press **OK**.
  - *The handset displays the time editing screen.*
- 5 Use digit keys to enter the time. Scroll to select **AM** or **PM** if the time is in 12-hour format.
- 6 Press **OK**.
  - *The setting is saved.*

### 4.5.2 Setting the date and time format

You can choose how your phone displays the date (DD/MM or MM/DD) and time (12-hour or 24-hour). Each handset can have different date and time format.

- 1 Press **(menu)**.
- 2 Select **CLOCK & ALARM > SET FORMAT**. Press **OK**.
- 3 Select **DATE FORMAT** or **TIME FORMAT**.
- 4 Select the setting you want.
- 5 Press **OK**.
  - *The setting is saved.*

---

#### 4.6 What is standby mode?

Your phone is in standby mode when it is idle. The standby screen displays the handset name, the handset number, the date and time, the signal icon, and the battery icon.

---

#### 4.7 Checking the signal strength

The signal icon  displays the link status between your handset and the base station. A steady icon means your handset and the base station are linked. A flashing icon means your handset and the base station are not linked.

If you move too far away from the base station while you are on the phone, you will hear warning tones notifying you that your handset is almost out of range - lost link. Take your handset closer to the base station or your call may be cut off shortly after the warning.

#### Note

If your handset has lost link, you will not be able to make or receive any calls. You will also not be able to carry out many of the phone's functions and features.

---

#### 4.8 Switching your handset ON/OFF

---

##### 4.8.1 Switching off your handset

**1** Press and hold . The handset's screen turns off.

#### Note

Your handset cannot receive any calls if the power is switched off.

---

##### 4.8.2 Switching on your handset

**1** Press . The handset may take a few seconds to power up.

## 4.9 Menu structure

The table below describes the menu tree of your phone. Press **menu** **MENU** in idle mode to enter each option. Use navigation keys  to navigate within the menus.

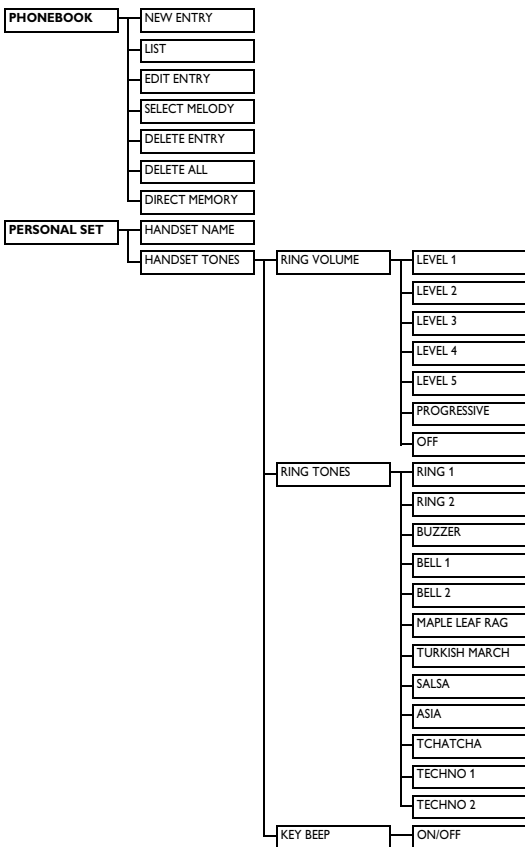

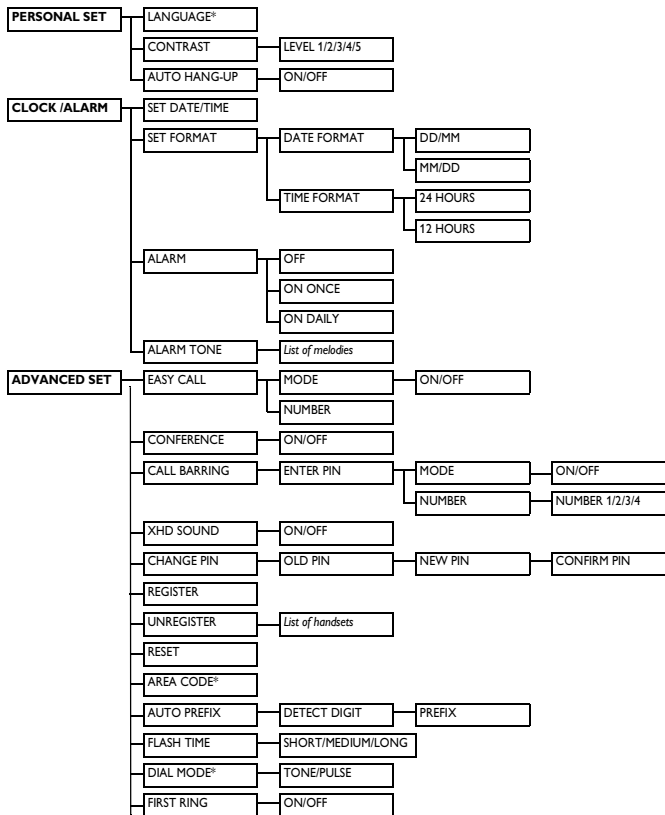

\*This menu item is country-dependent

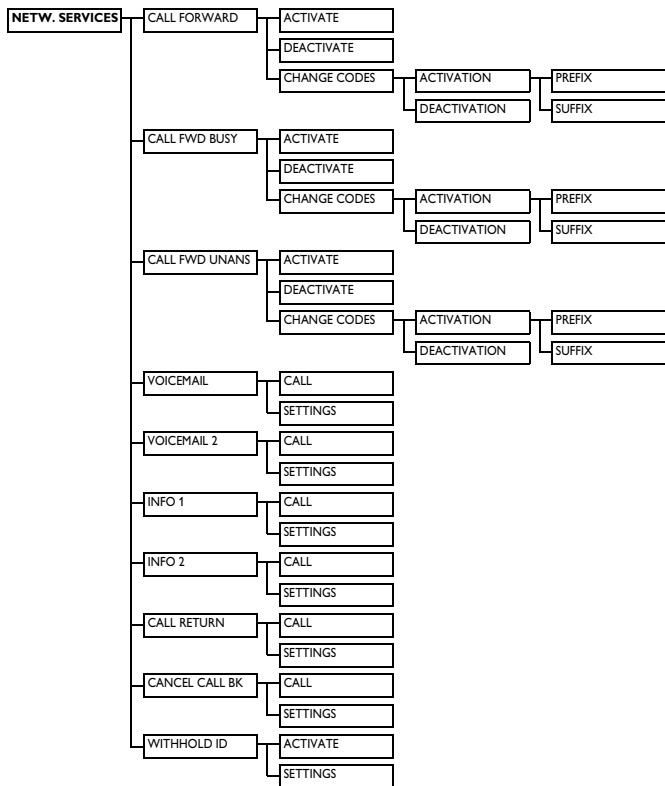

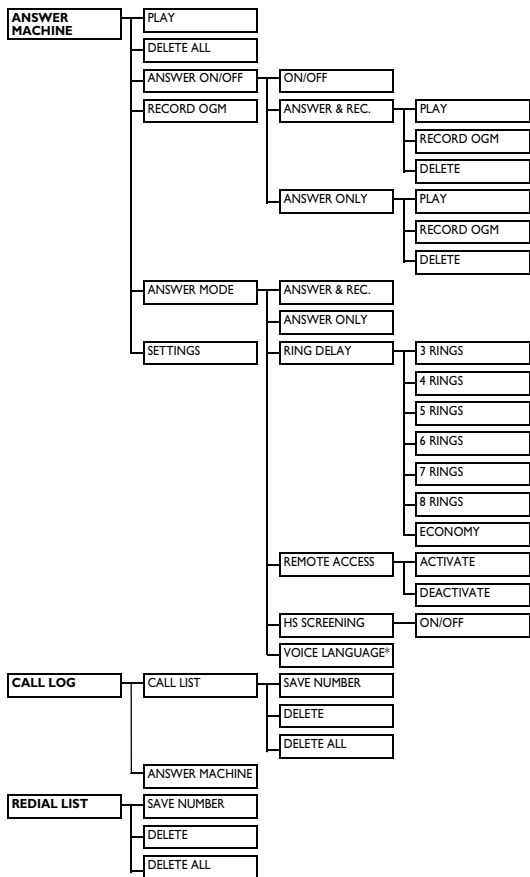

\*This menu item is country-dependent

---

## 5 Call

### Note

**Emergency Call.** This telephone is not designed for making emergency telephone calls when the power fails. Alternative arrangements should be made for access to emergency services.

---

### 5.1 Making a call

This section describes the different ways to make a call.

#### Note

**Signal Strength.** Check the signal strength before making a call and during a call. For details, see “Checking the signal strength” on page 17.

**1** Press .

**2** Dial the phone number. The number displays on the screen and is dialed out.

#### Note

**Call Timer.** The call timer displays the talk time of your current call.

#### Note

**Low Battery.** During a call, you will hear warning tones if your handset is almost out of battery. Charge your handset or your call may soon be cut off. For details, see “Checking the battery level” on page 16.

---

#### 5.1.1 Pre-dialing

Pre-dialing lets you view and edit the number before making the call.

**1** Enter the phone number. The number displays on the screen. You can make changes before dialing out.

**2** Press  to dial out the call.

#### Tip

Press **BACK** to erase a digit.

Press and hold  to enter a pause. P displays on the screen.

---

#### 5.1.2 Redialing the last number

**1** Press .

**2** Press . The last number displays on screen and is dialed out.

---

#### 5.1.3 Calling from the redial list

**1** Press .

**2** Select the record you want to call.

**3** Press . The number is dialed out.

---

#### 5.1.4 Calling from the phonebook

For details on the phonebook, see “Phonebook” on page 28.

**1** Press  to access the phonebook.

**2** Select the phonebook record you want to call.

**3** Press  to dial out the call.

---

#### 5.1.5 Calling from the call log

You can return a call from the incoming (received or missed) call log. For details, see “Call log” on page 31.

**1** Press .

**2** Select **CALL LIST**. Press **OK**.

**3** Select the call record you want to call.

**4** Press  to dial out the call.



---

## 5.2 Ending a call



**1** Press .

### \* Tip

**Auto hang up.** Place the handset on the base or charging cradle to end the call automatically. See “Auto hang up” on page 36.

---

## 5.3 Answering a call

When you receive a call, your phone rings. Press  or  to answer the call.

### ⚠ Warning

When the handset rings during an incoming call, do not put the handset too close to your ear as the ringer volume may damage your hearing.

### ⊖ Note

**Handsfree.** Handsfree activation can suddenly increase the earpiece volume to a very high level. Make sure the handset is not too close to your ear.

### ⊖ Note

**Caller ID Service.** Subscribe from your service provider.



### \* Tip

**Missed Call Alert.** When a call is missed, your handset displays a notification message. The handset's LED and  icon also flash.

---

### 5.3.1 Turning off the ringer

You can turn off the ringer for all incoming calls.

**1** Press and hold  during standby.  displays on the screen. For details on the ringer setting, see

“Personalizing your phone’s sounds” on page 34.

### \* Tip

**Silent Ringer.** When the phone is ringing, press  to turn off the ringer for the current call.



---

## 5.4 During a call

This section describes the features that are available during a call.

---

### 5.4.1 Adjusting the earpiece volume

**1** Press  or  to adjust the volume during a call. Press **OK** to confirm.

- *The earpiece volume is adjusted and the phone goes back to the call screen.*

---

### 5.4.2 Muting the microphone

The mute feature allows you to speak to someone in the house privately.

**1** Press  during a call. Your handset displays **MUTE ON**.

- *The caller cannot hear you, but you can still hear his voice.*

**2** Press  again to un-mute the microphone.

- *You can now communicate with the caller.*

---

## 5.5 Using the speaker or handsfree

**1** Press  to turn on/off the speaker.

---

## 5.6 Making a second call

### Note

**2nd Call Service.** Subscribe from your service provider.

### During a call,

**1** Press 

**OR**

Press **OK**. Select **START 2ND CALL**.

Press **OK** again.

- *Your first call will be put on hold.*

**2** Dial the number you want for the 2nd call. The number displays on the screen and is dialed out.

---

### 5.6.1 Answering a second call

#### Note

**2nd Call Service.** Subscribe from your service provider.

During a call, your phone sounds a short beep periodically to notify you of an incoming call.

**1** Press  to answer the call.

- *The first call is put on hold, and you are now connected to the second call.*

---

### 5.6.2 Toggling between two external calls

**1** Press 

**OR**

Press **OK** and select **SWITCH CALLS**. Press **OK**.

- *The current call is put on hold, and you are now connected to the other call.*

### Note

**Conference.** The conference feature may require additional charges from your service provider.

To start a conference call, while connected to two external calls, you can press **OK**, select **CONFERENCE**, and then press **OK** again. You can now talk to both parties at once.

---

## 6 Intercom and Conference Calls



An intercom call is a call to another handset that shares the same base station. A conference call involves a conversation between another handset and outside caller(s).

---

### 6.1 Calling another handset

#### Note

If the base station only has 2 handsets (yours and another handset) registered to it, you can press  to call the other handset instantly.

- 1 Press . The handset(s) available for intercom is displayed.
- 2 Select or press the desired handset number. Press **OK**.
  - *The desired handset rings.*
- 3 Press  on the desired handset.
  - *The intercom is established.*
- 4 Press  to cancel or end the intercom call.

#### Note

You will hear busy tone if the handset you are calling is not available.

---

#### 6.1.1 While you are on the phone

While talking on the phone, you can call another handset.

- 1 Press  during the call.
  - *The external caller is automatically being put on hold.*
- 2 Select or press the desired handset number. Press **OK**.

- 3 Wait for the called handset to answer your call.



---

#### 6.1.2 To toggle between the calls

- 1 Press  to switch between the outside call and the intercom call.

---

### 6.2 Transferring a call

- 1 Press  during a call.
- 2 Select or press the desired handset number. Press **OK**.
- 3 Press  after the called handset answers your call.
  - *The outside call is now transferred to the other handset.*

---



### 6.3 Making a conference call

A 3-way conference call is a call between you, outside caller(s), and another handset user in your house.

#### Note

A 3-way conference call requires 2 handsets that share the same base station.

#### During an external call,

- 1 Press  to initiate an internal call. The handset(s) available for intercom is displayed.
  - *The external caller is automatically being placed on hold.*
- 2 Select or press the desired handset number. Press **OK**.
  - *Your desired handset rings.*
- 3 Press  on the desired handset.
  - *The intercom is established.*
- 4 Press and hold  on your handset.

- *You are now on a 3-way conference call with the external call and the desired handset.*

**5** Press  to end the conference call.

**\* Tip**

**Auto Conference.** You can join an ongoing external call with another handset by pressing . See “Activating/Deactivating auto conference” on page 36.

**During the conference call,**

**1** Press  to put the external call on hold and go back to the internal call.

- *The external call is put on hold automatically.*

Press  to toggle between the external and internal call.

**2** Press and hold  to establish the conference call again.

**⊖ Note**

Any handset hangs up during a conference call will leave the other handset still in connection with the external call.



## 7 Text and Numbers

You can enter text and numbers for handset name, phonebook records, and other menu items.

### 7.1 Entering text and numbers

- Find the key with the character you want.
- Press it as many times as needed for the character you want.

#### \* Tip

**Editing.** Use **BACK** to delete and  or  to move the cursor.

Key	Characters (Lower case)
0	. 0 , / : ; " ' ! ; ? ; * + - % \ ^ ~
1	[Sp] 1 @ _ # = < > ( ) & € £ \$ ¥ [ ] { } □ § ...
2	a b c 2 â â Æ á ã ä å Æ ç ç Ć
3	d e f 3 d' d' é ë ê ë Ë Æ Δ Φ
4	g h i 4 ĝ î ï ï Ì Γ
5	j k l 5 λ ł Í Ĳ
6	m n o 6 ñ ñ ó ô õ ö ö Ö
7	p q r s 7 ř š š š ß Π Θ Σ
8	t u v 8 ț ț ù ú û ü ü ũ ũ Ů
9	w x y z 9 ý ž ž ž ı ø Ω Ξ Ψ

### Input table

Key	Characters (Upper case)
0	. 0 , / : ; " ' ! ; ? ; * + - % \ ^ ~
1	[Sp] 1 @ _ # = < > ( ) & € £ \$ ¥ [ ] { } □ § ...
2	A B C 2 Â Ã Ä Å Æ Á Ã Ä Å Æ Ā Ç Ć Ć
3	D E F 3 D' D' É Ê Ë Ë Ë Æ Δ Φ
4	G H I 4 Ğ Ĩ Ï Ï Ì Γ
5	J K L 5 λ ł Í Ĳ
6	M N O 6 Ñ Ñ Ó Ô Õ Ö Ö Ö
7	P Q R S 7 Ř Š Š Š ß Π Θ Σ
8	T U V 8 Ţ Ţ Ù Ú Û Ü Ü Ü Ů
9	W X Y Z 9 Ý Ž Ž Ž ı ø Ω Ξ Ψ

Example to write "PAUL"

Press 7 once: P

Press 2 once: A

Press 8 two times: U

Press 5 three times: L

### 7.2 Switching between uppercase and lowercase

By default, all characters entered will be in uppercase. You can press  to switch between uppercase and lowercase letters.

---

## 8 Phonebook



Your phone has a phonebook that can store up to 100 records. You can access the phonebook from your handset. Each record can have a name up to 14 characters long and a number up to 24 digits long.

---

### 8.1 Viewing the phonebook

#### Note

Only one handset can view the phonebook at one time.

- 1 Press .
- 2 Select the contact you want to view.
- 3 Press  to view the details of a record (name, number, VIP melody).

#### Tip

**Options Menu.** While viewing the phonebook, you can press **OK** to access the phonebook options menu.

---

#### 8.1.1 Searching a record

You can search the phonebook by scrolling or by searching the first character.

---

##### 8.1.1.1 Searching by scrolling

- 1 While in the phonebook, press  or  to scroll.

---

##### 8.1.1.2 Searching by the first character

- 1 While in the phonebook, press the digit key that contains the character you want to search by.

---

#### 8.1.2 During a call

You can access the phonebook and use the number during a call.

- 1 Press and hold  during a call  
**OR**  
Press **OK**. Select **PHONEBOOK**.  
Press **OK**.
- 2 Select the contact you want.
- 3 Press **OK**. The number displays on the screen and is dialed out.

---

### 8.2 Calling from the phonebook

See “Calling from the phonebook” on page 22.

---

### 8.3 Adding a record

#### Note

**Memory Full.** If your phonebook is full, the handset displays a notification message. Delete some records before adding new ones.

- 1 Press .
- 2 Select **PHONEBOOK > NEW ENTRY**. Press **OK**.

#### Note

**Text and Number Editing.** See “Text and Numbers” on page 27.

- 3 Enter the name. Press **OK**.
- 4 Enter the number.

#### Note

**Duplicate Record.** Contacts with identical number cannot be saved.

#### Tip

**Pause.** Press and hold  to insert a pause.

- 5 Press **OK** to confirm.
  - *Your new record is saved.*

---



## 8.4 Editing a record

- 1 Press .
- 2 Select **PHONEBOOK > EDIT ENTRY**. Press **OK**.
- 3 Select the contact you want to edit. Press **OK**.
- 4 Edit the name if necessary. Press **OK**.
- 5 Edit the number if necessary. Press **OK** to confirm.
  - *The record is saved.*

---

## 8.5 Setting VIP melodies

You can assign different ringer melodies for each phonebook contacts. Your phone will ring the selected melody when the caller ID matches the number in your phonebook.

- 1 Press .
- 2 Select **PHONEBOOK > SELECT MELODY**. Press **OK**.
- 3 Select the contact you want. Press **OK**.
  - *The current melody is displayed.*
- 4 Select a ring melody using  and . Press **OK**.
  - *The setting is saved.*

---

## 8.6 Deleting a record

- 1 Press .
- 2 Select **PHONEBOOK > DELETE ENTRY**. Press **OK**.
- 3 Select the contact you want to delete. Press **OK**.
  - *The handset displays a confirmation request.*
- 4 Press **OK** to confirm.
  - *The record is deleted.*

---

## 8.7 Deleting all records

- 1 Press .
- 2 Select **PHONEBOOK > DELETE ALL**. Press **OK**.
  - *The handset displays a confirmation request.*
- 3 Press **OK** to confirm.
  - *All records are deleted.*

---

## 8.8 Using quick dial

You can store up to 9 direct access memories (key 1 - 9). A long press on the keys in standby will automatically dial your stored phone number.

Depending on your country, key 1 and key 2 may be preset to the voice mail number and information service number of your network operator respectively. In this case, key 1 and key 2 will not be available for setting direct access memories.

---

### 8.8.1 Assigning a quick dial key

- 1 Press .
- 2 Select **PHONEBOOK > DIRECT MEMORY**. Press **OK**.
- 3 Select an available key from the list. Press **OK**.
- 4 Select the contact you want. Press **OK**.
  - *The setting is saved.*

---

### 8.8.2 Making a call

- 1 Press and hold an assigned quick dial key during standby. The programmed number is dialed out.

---

### 8.8.3 Editing a quick dial key

- 1 Press .
- 2 Select **PHONEBOOK > DIRECT MEMORY**. Press **OK**.
- 3 Select the quick dial key you want to change. Press **OK**.
- 4 Select **CHANGE**. Press **OK**.
- 5 Select a new contact. Press **OK**.
  - *The setting is saved.*

---

### 8.8.4 Cancelling a quick dial key

- 1 Press .
- 2 Select **PHONEBOOK > DIRECT MEMORY**. Press **OK**.
- 3 Select the quick dial key you want to cancel. Press **OK**.
- 4 Select **DELETE** to cancel the quick dial key. Press **OK**.
  - *The handset displays a confirmation request.*
- 5 Press **OK** to confirm.
  - *The quick dial key is cancelled.*



---

## 9 Call log

The call log stores the call history of all incoming (missed or received) calls. The incoming call history includes the caller name, number, call time and date. This feature is available if you have registered to the Caller ID service (CLI) with your service provider.

Your phone can store up to 50 call records. The call log icon  and the handset LED will blink to remind you of any unanswered calls received. If the identity of the caller is not withheld, the name (or number) of the caller will be displayed. The call records are displayed in chronological order with the most recent received call at the top of the list.

### Note

Call back from the call list may not work for all received numbers if the received number is not a valid number (e.g. Private).

---

### 9.1 Viewing the call records

- 1 Press .
- 2 Select **CALL LIST**, and then press **OK** to enter the incoming call log.
- 3 Select the record you want to view. Press **▶** for more information if available.

---





### 9.2 Editing the caller's number before returning a call

You must choose the correct format to dial the area code and number of the call

log record chosen. The original incoming number from the call log will appear as a 7, 10 or 11-digit number. If it is a long distance call, the prefix digit 1 will automatically appear in front of the 10-digit local calls.

- 1 Enter the call list.
- 2 Select the record you want while browsing the log.
- 3 Press  at the number screen repeatedly until you change the number to the desired format.

For example, if the call log number appears as "1-234-567-8901".

- Press  once to display "567-8901".
- Press  twice to display "1-567-8901".
- Press  3 times to display "234-567-8901".
- 4 Press  to dial the current displayed number. The call is initiated.

### Note

When saving the call list entry to phonebook, the original incoming number will be saved instead of the current displayed number.

---

### 9.3 Returning a call

To call from the incoming call log, see "Calling from the call log" on page 22.

---

### 9.4 Saving a call record to your phonebook

- 1 Enter the call list.
- 2 Select the record you want while browsing the log. Press **OK**.
- 3 Select **SAVE NUMBER**. Press **OK**.

- 4** Enter and edit the name if necessary.  
Press **OK**.
    - *The record is saved.*
- 

### 9.5 Deleting a call record

- 1** Enter the call list.
  - 2** Select the record you want while browsing the log. Press **OK**.
  - 3** Select **DELETE**. Press **OK**.
    - *The handset displays a confirmation request.*
  - 4** Press **OK** to confirm.
    - *The record is deleted.*
- 

### 9.6 Deleting all call records

- 1** Enter the call list.
- 2** Press **OK** to enter the options menu while browsing the log.
- 3** Select **DELETE ALL**. Press **OK**.
  - *The handset displays a confirmation request.*
- 4** Press **OK** to confirm.
  - *All records are deleted.*

---

## 10 Redial List

The redial list stores call history of dialed calls. The dialed call history includes the name and number called. Your phone can store up to 10 redial records.

---

### 10.1 Viewing the redial records

- 1 Press **(redial)** to enter the dialed call log.
- 2 Select the record you want to view. Press **▶** for more information if available.

---

### 10.2 Redialing a call

To call from the redial list, see “Calling from the redial list” on page 22.

---

### 10.3 Saving a redial record to your phonebook

- 1 Enter the redial list.
- 2 Select the record you want while browsing the list. Press **OK**.
- 3 Select **SAVE NUMBER**. Press **OK**.
- 4 Enter and edit the number if necessary. Press **OK**.
  - *The record is saved.*

---

### 10.4 Deleting a redial record

- 1 Enter the redial list.
- 2 Select the record you want while browsing the list. Press **OK**.
- 3 Select **DELETE**. Press **OK**.
  - *The handset displays a confirmation request.*
- 4 Press **OK** to confirm.
  - *The record is deleted.*

---

### 10.5 Deleting all redial records

- 1 Enter the redial list.
- 2 Press **OK** to enter the options menu while browsing the list.
- 3 Select **DELETE ALL**. Press **OK**.
  - *The handset displays a confirmation request.*
- 4 Press **OK** to confirm.
  - *All records are deleted.*

---

# 11 Custom Options

Make this your phone - change the look and sound of the handset to suit your needs and tastes.

---

## 11.1 Personalizing your phone's display

---

### 11.1.1 Naming your handset

Each handset can have its own name (up to 12 characters). It is displayed on the screen in standby.

- 1 Press .
- 2 Select **PERSONAL SET > HANDSET NAME**. Press **OK**.
- 3 Enter or edit the name. Use **BACK** to make corrections.
- 4 Press **OK** to confirm.
  - *The setting is saved.*

---

### 11.1.2 Setting the display language

This feature only applies to model(s) with multiple-language support.

#### **Note**

Available languages for selection vary with different countries.

- 1 Press .
- 2 Select **PERSONAL SET > LANGUAGE**. Press **OK**.
- 3 Select the new setting. Press **OK**.
  - *The setting is saved.*

---

### 11.1.3 Adjusting the screen contrast level

- 1 Press .
- 2 Select **PERSONAL SET > CONTRAST**. Press **OK**.

- 3 Select the new setting. The contrast effect will display while you are browsing through the different contrast levels. Press **OK** to confirm.
  - *The setting is saved.*

---

## 11.2 Personalizing your phone's sounds

---

### 11.2.1 Setting your handset's ringer melody

You can choose from 12 different ringer melodies.

- 1 Press .
- 2 Select **PERSONAL SET > HANDSET TONES > RING TONES**. Press **OK**.
- 3 Select the new setting. Press **OK**.
  - *The setting is saved.*



---

### 11.2.2 Setting your handset's ringer volume

There are 6 ringer volume levels (including ringer off) and a progressive setting.

- 1 Press .
- 2 Select **PERSONAL SET > HANDSET TONES > RING VOLUME**. Press **OK**.
- 3 Select the new setting. Press **OK**.
  - *The setting is saved.*

#### **Tip**

Press and hold  during standby to turn off the ringer.  displays on the screen.

---

### 11.2.3 Setting the key tone

Key tone is the sound you hear when you press a key on your handset.

- 1 Press .

- 2** Select **PERSONAL SET > HANDSET TONES > KEY BEEP**. Press **OK**.
  - 3** Select the new setting. Press **OK**.
    - *The setting is saved.*
- 

#### 11.2.4 Enhancing the audio quality

Enhanced High Def voice mode is an exclusive feature making your phone conversations sounding just like real-life conversations. When activated, the Enhanced High Def voice mode transmits with high fidelity all the emotions of the call, as if your correspondent was talking next to you.

- 1** Press .
  - 2** Select **ADVANCED SET > XHD SOUND**. Press **OK**.
  - 3** Select the new setting. Press **OK**.
    - *The setting is saved.*
- 

#### 11.2.5 During a call

- 1** Press **OK** to enter the options menu. The handset displays the Enhanced High Def voice setting you can change to.
- 2** Press **OK** to change the setting.
  - *The setting is saved.*

---

## 12 Calling Features

Your phone supports a number of call-related features to help you handle and manage your calls.

---

### 12.1 Auto hang up

Auto hang up allows you to end a call by placing the handset on the base or charging cradle without pressing any key.

---

#### 12.1.1 Activating/Deactivating auto hang up

- 1 Press .
- 2 Select **PERSONAL SET > AUTO HANG-UP**. Press **OK**.
- 3 Select the new setting. Press **OK**.
  - *The setting is saved.*

---

### 12.2 Auto conference

Auto conference lets you join an external call with another handset by simply pressing .

---

#### 12.2.1 Activating/Deactivating auto conference

- 1 Press .
- 2 Select **ADVANCED SET > CONFERENCE**. Press **OK**.
- 3 Select the new setting. Press **OK**.
  - *The setting is saved.*

---

### 12.3 Dial mode

This feature only applies to model(s) that support both tone and pulse dialing. Dial mode is the telephone signal used in your country. Your phone supports tone (DTMF) and pulse (rotary) dialing. Your

phone shall already be set up for use in your country. For details, consult your service provider.

---

#### 12.3.1 Setting the dial mode

- 1 Press .
- 2 Select **ADVANCED SET > DIAL MODE**. Press **OK**.
- 2 Select the new setting. Press **OK**.
  - *The setting is saved.*

#### \* Tip

**Temporary Tone.** If your phone is in pulse dialing, press and hold  during a call for temporary tone mode. 'd' displays. Digits entered after 'd' are sent out as tone signals (for this call only).

---

### 12.4 Flash selection

Flash is a signal that needs to be sent to the network when making or answering a second call. Your phone shall already be set up for use in your country. For details, consult your service provider.

---

#### 12.4.1 Setting the flash duration

There are 3 flash time options: Short, Medium, and Long. The number of available options varies with different countries.

- 1 Press .
- 2 Select **ADVANCED SET > FLASH TIME**. Press **OK**.
- 3 Select the new setting. Press **OK**.
  - *The setting is saved.*

---

### 12.5 Call barring

Call barring allows you to block selected numbers from dialing out.

---

### 12.5.1 Activating/deactivating call barring

- 1 Press .
- 2 Select **ADVANCED SET > CALL BARRING**. Press **OK**.
- 3 Enter the system PIN. Press **OK**.
- 4 Select **MODE**. Press **OK**.
- 5 Select the new setting. Go to step 6 if you selected **ON** or step 7 if you selected **OFF**.
- 6 Enter the barred number (if it is not set previously).
- 7 Press **OK**.
  - *The setting is saved.*

---

### 12.5.2 Setting barred numbers

You can set up to 4 numbers of 1 - 4 digits long. Outgoing calls starting with one of the 4 programmed numbers will be blocked from dialing out.

- 1 Press .
- 2 Select **ADVANCED SET > CALL BARRING**. Press **OK**.
- 3 Enter the system PIN. Press **OK**.
- 4 Select **NUMBER > NUMBER 1** (2, 3, 4). Press **OK**.
- 5 Enter the number you want to block. Press **OK**.
  - *The setting is saved.*

---

### 12.6 Area code management

This feature only applies to model(s) with area code support.

This feature automatically removes the area code of an incoming call. You can define an area code (up to 6 digits) you want to remove. The phone number will be saved in the call log without the area code.

---

### 12.6.1 Activating area code removal

- 1 Press .
- 2 Select **ADVANCED SET > AREA CODE**. Press **OK**.
- 3 Enter the area code. Press **OK**.
  - *The setting is saved.*

---

### 12.6.2 Deactivating area code removal

- 1 Press .
- 2 Select **ADVANCED SET > AREA CODE**. Press **OK**.
- 3 Use **BACK** to delete all the digits. Press **OK**.
  - *The setting is saved.*

---

### 12.7 Auto prefix

The auto prefix feature checks and formats your outgoing call number before it is dialed out. If the first few digits of the number match the detect number you set in the menu, they will be replaced by the prefix number you set in the menu. For example, you set the detect number as 604 and prefix number as 1250. When you have dialed out a number such as 6043338888, your phone will change the number to 12503338888 when it dials out.

#### Note

The maximum length of detect digits is 5 digits. The maximum length of auto prefix number is 10 digits.

- 1 Press .
- 2 Select **ADVANCED SET > AUTO PREFIX**. Press **OK**.
- 3 Enter the Detect number. Press **OK**.

- 4** Enter the Prefix number. (To enter a pause, press and hold ) Press **OK**.

- *The setting is saved.*

 **Note**

**Empty Detect Number.** If the user only sets the prefix number and leaves the detect number empty, the prefix number will be added to all outgoing calls.

 **Note**

**Dialed Number.** If the dialed number starts with \*, # or P, the handset will not do any reformatting.

---

## 12.8 First ring

This feature only applies to model(s) with first ring support.

If you have subscribed for Caller ID service with your service provider, your phone can suppress the first ring before the Caller ID. After resetting, your phone will automatically detect if Caller ID service is subscribed and start to suppress the first ring. You can change this setting to suit your preference.

---

### 12.8.1 Turning first ring on/off

- 1** Press .
- 2** Select **ADVANCED SET > FIRST RING**. Press **OK**.
- 3** Select the new setting. Press **OK**.
  - *The setting is saved.*

 **Note**

**Reset First Ring Status.** To reset the first ring status, you can reset the system from the Reset menu. See “Restoring default settings” on page 44.



---

## 13 Network Services

The network services feature allows you to listen to information provided by your network provider. The availability of this feature is dependent of your country and your subscription with the network provider. This information are stored by the network rather than in your handset itself. Contact your network provider for more information about this feature.

### Note

**Incorrect codes.** Network services may not work if the incorrect activation and/or deactivation codes are entered.

---

### 13.1 Call forward

This feature lets you forward your calls to another number. There are a few options:

- **CALL FORWARD:** forward all incoming calls.
- **CALL FWD BUSY:** forward calls only when the line is busy.
- **CALL FWD UNANS:** forward calls only when they are not answered.

---

#### 13.1.1 Activating call forward

- 1 Press .
- 2 Select **NETW. SERVICES**. Press **OK**.
- 3 Select **CALL FORWARD** options you want. Press **OK** to confirm.
- 4 Select **ACTIVATE**. Press **OK**.
- 5 Enter the number you want to forward your calls to. Press **OK**.
  - *A call is made to the service center.*

---

#### 13.1.2 Deactivating call forward

- 1 Press .
- 2 Select **NETW. SERVICES**. Press **OK**.
- 3 Select **CALL FORWARD** options you want. Press **OK** to confirm.
- 4 Select **DEACTIVATE**. Press **OK**.
  - *A call is made to the service center.*

---

#### 13.1.3 Editing the activation/ deactivation codes

You can make changes to the prefix and suffix to the call forward codes.

- 1 Press .
- 2 Select **NETW. SERVICES**. Press **OK**.
- 3 Select **CALL FORWARD** options you want. Press **OK** to confirm.
- 4 Select **CHANGE CODES**. Press **OK**.
- 5 Select **ACTIVATION > PREFIX (SUFFIX)**. Press **OK**  
**OR**  
Select **DEACTIVATION**. Press **OK**.
- 6 Enter or edit the code. Press **OK**.
  - *The setting is saved.*

---

### 13.2 Voicemail

You will see an envelope  icon on your handset when there is a voicemail waiting in your mailbox. When all the voicemail records are cleared from the call log, the envelope icon will turn off.

---

#### 13.2.1 Retrieving voicemail(s)

You can make a call to the voicemail service center to retrieve your voicemail(s). Your phone supports 2 voicemail service numbers.

- 1 Press .
- 2 Select **NETW. SERVICES**. Press **OK**.

- 3 Select the voicemail service you want. Press **OK**.
- 4 Select **CALL**. Press **OK**.
  - A call is made to the service center.

**\* Tip**

**Voicemail 1 Shortcut.** Press and hold  during standby to make a call to the voicemail 1 service center directly.

---

### 13.2.2 Editing the voicemail service numbers

- 1 Press .
- 2 Select **NETW. SERVICES**. Press **OK**.
- 3 Select the voicemail service you want. Press **OK**.
- 4 Select **SETTINGS**. Press **OK**.
- 5 Enter or edit the voicemail number. Press **OK**.
  - The setting is saved.

---

### 13.3 Info center

Your phone supports 2 info center numbers.

---

#### 13.3.1 Calling the info center

- 1 Press .
- 2 Select **NETW. SERVICES**. Press **OK**.
- 3 Select the info center you want. Press **OK**.
- 4 Select **CALL**. Press **OK**.
  - A call is made to the info center.

---

#### 13.3.2 Editing the info center numbers

- 1 Press .
- 2 Select **NETW. SERVICES**. Press **OK**.
- 3 Select the info center you want. Press **OK**.

- 4 Select **SETTINGS**. Press **OK**.
- 5 Enter or edit the number. Press **OK**.
  - The setting is saved.

---

### 13.4 Call return

The call return service allows you to check who called you last.

---

#### 13.4.1 Calling the call return service center

- 1 Press .
- 2 Select **NETW. SERVICES > CALL RETURN > CALL**. Press **OK**.
  - A call is made to the service center.

---

##### 13.4.1.1 Editing the call return service center number

- 1 Press .
- 2 Select **NETW. SERVICES > CALL RETURN > SETTINGS**. Press **OK**.
- 3 Enter or edit the number. Press **OK**.
  - The setting is saved.

---

### 13.5 Cancel call back

The call back service notifies you when a party you have tried to call becomes available. After activating this service from your service provider, you can choose to cancel it from the menu.

---

#### 13.5.1 Cancelling call back

- 1 Press .
- 2 Select **NETW. SERVICES > CANCEL CALL BK > CALL**. Press **OK**.
  - A call is made to the service center to cancel the call back option.

---

### 13.5.2 Editing the cancel call back service number

- 1 Press .
- 2 Select **NETW. SERVICES > CANCEL CALL BK > SETTINGS**. Press **OK**.
- 3 Enter or edit the number. Press **OK**.
  - *The setting is saved.*

---

## 13.6 Withholding ID

This feature enables you to prevent the person you are calling from seeing your name or number caller ID.

---

### 13.6.1 Activating withhold ID

- 1 Press .
- 2 Select **NETW. SERVICES > WITHHOLD ID > ACTIVATE**. Press **OK**.
  - *The withhold ID code is dialed out.*
- 3 Enter the number you want to call. The number is dialed out and your information is withheld from the other party.

---

### 13.6.2 Editing the withhold ID code

- 1 Press .
- 2 Select **NETW. SERVICES > WITHHOLD ID > SETTINGS**. Press **OK**.
- 3 Enter or edit the number. Press **OK**.
  - *The setting is saved.*

---

## 14 Extra Features

Discover and explore the additional features your phone offers! Find out how these features can benefit you and help you make the most of your phone.

---

### 14.1 Alarm clock

You can use your phone as an alarm clock to wake you up. You can set the alarm to ring once or daily.

---

#### 14.1.1 Setting the alarm

- 1 Press .
- 2 Select **CLOCK & ALARM > ALARM**. Press **OK**.
- 3 Select **ON ONCE** or **ON DAILY**. Press **OK**.
- 4 Enter the alarm time.

#### Tip

You can set the time format to 12-hour or 24-hour. See “Setting the date and time format” on page 16.

- 5 Press **OK**.
  - *The alarm is set and the  icon displays.*

---

#### 14.1.2 Turning off the alarm

---

##### 14.1.2.1 When the alarm rings

- 1 Press  or **OK** to turn off the alarm. Pressing other keys cannot stop the alarm.

#### Note

If you do not press any key after the alarm clock rings for 1 minute, it will turn off automatically.

---

##### 14.1.2.2 Before the alarm rings

- 1 Press .
- 2 Select **CLOCK & ALARM > ALARM**. Press **OK**.
- 3 Select **OFF**. Press **OK**.
  - *The setting is saved.*

---

##### 14.1.3 Setting the alarm melody

- 1 Press .
- 2 Select **CLOCK & ALARM > ALARM TONE**. Press **OK**.
- 3 Select the new setting. Press **OK**.
  - *The setting is saved.*

#### Note

**Alarm Volume.** The alarm volume is set to the same level as the ringer volume. If the ringer is off, the alarm volume is set to level 1.

---

### 14.2 Easy call

Easy call allows you to dial out a programmed number by pressing any handset key (except **BACK**).

---

#### 14.2.1 Activating easy call

- 1 Press .
- 2 Select **ADVANCED SET > EASY CALL > MODE**. Press **OK**.
- 3 Select **ON**. Press **OK**.
- 4 Enter the easy call number (if it is not set previously). Press **OK**.
  - *The setting is saved.*

#### Warning

When easy call is activated, you will not be able to make emergency calls.

---

### 14.2.2 Setting the easy call number

- 1 Press .
- 2 Select **ADVANCED SET > EASY CALL > NUMBER**. Press **OK**.
- 3 Enter the easy call number. Press **OK**.
  - *The setting is saved.*

---

### 14.2.3 Deactivating easy call

- 1 Press **BACK**  during standby.
  - *The easy call menu displays.*
- 2 Select **OFF**. Press **OK**.
  - *The setting is saved.*

---

## 14.3 Keypad lock

You can lock the keypad to prevent accidental presses on the handset while you are carrying it around.

---

### 14.3.1 Locking the keypad

- 1 Press and hold  during standby.  
The keypad is locked.
  - **KEYS LOCKED** is displayed.

#### **Note**

**Calls.** You will not be able to make any calls including emergency calls when the keypad is locked. You can still answer incoming calls. The keypad will be unlocked during the call, and then it will be re-locked automatically after you finish the call.



---

### 14.3.2 Unlocking the keypad

- 1 Press and hold .
  - *The keypad is unlocked.*

---

## 14.4 Missing handset(s)

- 1 Press  on the base station.
  - *All the handsets connected to this base station ring.*
- 2 Press  on the base station again to stop locating handsets.
  - *All the handsets stop ringing*

#### **OR**

Press any key on the handset to stop the ringing for that handset.

---

## 15 The System

---

### 15.1 Registering handset(s)

The procedures described below are the procedures you will find in your handset. The procedures may vary according to the handset you want to register. In this case, refer to the manufacturer's instruction of the additional handset. Additional handsets must be registered to the base station before you can use them. Your base station can register up to 5 handsets.

- 1 Press  on the handset you want to register.
- 2 Select **ADVANCED SET > REGISTER**. Press **OK**.
- 3 Follow the handset's screen instruction.
  - *Registration shall be completed in less than 2 minutes. The base automatically assigns a handset number to the handset.*

#### Note

If no base is found within a certain period, your handset displays a notification message. Repeat the above procedure if registration failed.

---

### 15.2 Un-registering a handset

Use one handset to unregister another handset that shares the same base station.

- 1 Press .
- 2 Select **ADVANCED SET > UNREGISTER**. Press **OK**.
- 3 Select the handset (number) you want to un-register.

#### Tip

**Handset Number.** The handset number displays beside the handset name during standby.

- 5 Press **OK**.

- *The handset is un-registered.*

---

### 15.3 Changing your PIN

The system PIN is used for protecting access rights to some of the menus and remote access. The pre-set PIN is 0000. You can personalize your PIN for greater security.

- 1 Press .
- 2 Select **ADVANCED SET > CHANGE PIN**. Press **OK**.
- 3 Enter the current system PIN. Use **BACK** to make corrections. Press **OK** to confirm the system PIN.
- 4 Enter the new system PIN. Press **OK**.
- 5 Enter the new system PIN again for verification. Press **OK**.
  - *The setting is saved.*

#### Note

**Forgotten PIN.** Write down your PIN and save it for future use. If you have forgotten the PIN, reset your phone and your PIN code will be restored to the factory pre-set PIN (0000). To reset your phone, see "Restoring default settings" on page 44.

---

### 15.4 Restoring default settings

You can reset your phone settings to the original factory settings.

- 1 Press .
- 2 Select **ADVANCED SET > RESET**. Press **OK**.

- *The handset displays a confirmation request.*

**3** Press **OK** to confirm.

- *All settings have been reset.*

 **Note**

After reset, your handset's power switches off. It will switch back on in a few seconds after updating all the settings. All handsets return to the standby mode after reset.

To see a list of default setting, see “Default (pre-programmed) settings” on page 51.

---

## 16 The Answering Machine

Your phone includes a telephone answering machine that records unanswered calls when it is on. Once switched on, your answering machine is ready to be used. By default, your answering machine is set to Answer and Record mode. You can also access the answering machine remotely.

The LED message counter (two digits 7-segment display) on the base will show the number of the messages when the answering machine is on.

--	Memory full
AA	The answering machine is being accessed remotely (on the handset or a touch tone phone)
[ ]	Recording
00	The 2-digit number shows: - The volume level during adjustment, or - The message number (blink for new messages)

You can use the answering machine menu on the handset to change the settings of the answering machine.

---

### 16.1 Turning on the answering machine

You can turn on the answering machine either through the base or the handset.

#### Through the handset,

- 1 Press .
- 2 Select **ANSWER MACHINE > ANSWER ON/OFF**. Press **OK**.
- 3 Select **ON**. Press **OK**.
  - *The setting is saved.*

#### Through the base,

- 1 Press  to turn on the answering machine during standby.

#### Note

Once switched on, your answering machine will answer incoming calls after a certain number of rings depending on the ring delay setting. See “Setting the ring delay” on page 49.

---

### 16.2 Turning off the answering machine

You can turn off the answering machine either through the base or the handset.

#### Through the handset,

- 1 Press .
- 2 Select **ANSWER MACHINE > ANSWER ON/OFF**. Press **OK**.
- 3 Select **OFF**. Press **OK**.
  - *The setting is saved.*

#### Through the base,

- 1 Press  to turn off the answering machine during standby.

#### Note

Once switched off, the message counter turns off.



---

### 16.3 Setting the answering machine language

This feature only applies to model(s) with multiple-language support.

The answering machine language is the language for the pre-recorded greeting message and voice prompt instructions announced by the answering machine.

- 1 Press .
- 2 Select **ANSWER MACHINE > SETTINGS > VOICE LANGUAGE**. Press **OK**.
- 3 Select the new setting. Press **OK**.
  - *The setting is saved.*

---

### 16.4 Setting the answer mode

By default, the answering machine is set to Answer & Rec mode (message can be left by the callers), this can be changed to Answer Only (no message can be left by the callers. The caller will be prompted to call back later.)

- 1 Press .
- 2 Select **ANSWER MACHINE > ANSWER MODE**. Press **OK**.
- 3 Select the new setting. Press **OK**.
  - *The setting is saved.*

#### Note

**Memory Full.** Answering machine automatically switches to answer only mode.

---

### 16.5 Greetings (OGM)

The greeting message is the message your caller hears when the answering machine picks up the call. Your answering machine comes with 2 pre-recorded greeting messages: one for Answer and Record mode and one for Answer Only mode.

---

#### 16.5.1 Recording a greeting message

The maximum length of the greeting message is 60 seconds. After recording, your new greeting message will automatically replace the old one.

- 1 Press .
- 2 Select **ANSWER MACHINE > RECORD OGM**. Press **OK**.
- 3 Select **ANSWER & REC.** or **ANSWER ONLY**. Press **OK**.
- 4 Select **RECORD OGM**. Press **OK**.
- 5 Start recording after the beep.
- 6 Press **OK** to stop recording or recording will stop after 60 seconds.
  - *The recorded greeting message will play back automatically for review.*

#### Tip

**Restore Pre-recorded greeting message.** If you want to restore the pre-recorded greeting message, simply delete your current greeting message.

---

#### 16.5.2 Listening to the current greeting message

- 1 Press .
- 2 Select **ANSWER MACHINE > RECORD OGM**. Press **OK**.
- 3 Select **ANSWER & REC.** or **ANSWER ONLY**. Press **OK**.
- 4 Select **PLAY**. Press **OK**.
  - *The handset plays the current greeting message.*

---

### 16.5.3 Deleting a greeting message

- 1 Press .
- 2 Select **ANSWER MACHINE > RECORD OGM**. Press **OK**.
- 3 Select **ANSWER & REC.** or **ANSWER ONLY**. Press **OK**.
- 4 Select **DELETE**. Press **OK**.
  - *The handset displays a confirmation request.*
- 5 Press **OK** to confirm.
  - *The pre-recorded greeting message is restored.*

#### Note

The pre-recorded greeting message cannot be deleted.

---

### 16.6 Incoming messages (ICM)

Each message can be up to 3 minutes long. When you have received new messages on your answering machine, the answering machine display will keep flashing the number of new messages received and the handset will display a notification message. If you pick up the phone when the caller is leaving a message, the recording will stop and you can talk to the caller directly.

#### Note









**Memory Full.** The answering machine automatically switches to answer only mode. Delete some messages to allow room for new messages.

---

#### 16.6.1 Playing incoming messages

Incoming messages will be played back in the sequence they were recorded.



#### From the base

- 1 Press . Press to start or stop message playback.
  - **Adjust the volume.** Press  to increase or  to decrease the speaker's volume.
  - **Skip backward.**
    - During message playback, press  to replay the message from the beginning.
    - During the first second of the current message, press  to play the previous message.
  - **Skip forward.** Press  to skip to the next message.
  - **Stop playback.** Press .
  - **Delete current message.** Press .

#### Note

Deleted message(s) cannot be recovered.

#### From the handset

- 1 Press .
- 2 Select **ANSWER MACHINE > PLAY**. Press **OK**. New messages start playing. Old messages start playing if there is no new message.
  - **Stop playback.** Press **BACK**.
  - **Enter options menu.** Press **OK**.
  - **Adjust the volume.** Press  to increase or  decrease the volume.

---

#### 16.6.2 Deleting an incoming message

##### From the base

- 1 Press  during message playback.
  - *The current message is deleted.*

### From the handset

- 1 During message playback, press **OK** to enter the options menu.
- 2 Select **DELETE**. Press **OK**.
  - *The current message is deleted.*

---

### 16.6.3 Deleting all old incoming messages

#### From the base

- 1 Press and hold  during standby.
  - *All old messages are permanently deleted.*

#### From the handset

- 1 Press .
- 2 Select **ANSWER MACHINE > DELETE ALL**. Press **OK**.
  - *The handset displays a confirmation request.*
- 3 Press **OK** to confirm.
  - *All old messages are permanently deleted.*

#### Note



Unread message(s) cannot be deleted, and deleted message(s) cannot be recovered.

---

### 16.7 Call screening

Call screening allows you to hear the caller while he is leaving a message. You can then decide if you want to talk to the caller directly.

#### From the base



You can use  and  to adjust the speaker's volume during call screening. The lowest volume level turns call screening off.

### From the handset

The call screening feature on the handset can be changed from the handset menu.

- 1 Press  on the handset.
- 2 Select **ANSWER MACHINE > SETTINGS > HS SCREENING**. Press **OK**.
- 3 Select the new setting. Go to step 4 if you selected **ON** or step 5 if you selected **OFF**.
- 4 Select the handset you want for screening.
- 5 Press **OK**.
  - *The setting is saved.*

#### Note

During call screening, use  and  to adjust the screening volume.

#### Tip

**Handset Call Screening.** Your handset automatically turns on the speaker for handset screening. To listen from the earpiece, press  to turn off the speaker.

#### Note

The call screening on/off setting cannot be changed during ICM recording.

---

### 16.8 Message alert

Message alert gives you an indication that the answering machine has new message(s). You will see the number of new messages flashing on the base, and you will also see the  icon flashing and a notification message on the handset.

---

### 16.9 Setting the ring delay

Ring delay is the number of times your phone will ring before the answering

machine picks up the call. This setting only applies when your answering machine is switched on. You can change this setting from 3 - 8 rings or economy.

- 1 Press .
- 2 Select **ANSWER MACHINE > SETTINGS > RING DELAY**. Press **OK**.
- 3 Select the new setting. Press **OK**.
  - *The setting is saved.*

#### \* Tip

**Economy.** This is a cost effective way to manage your messages when accessing your answering machine remotely. When economy is selected, your answering machine will pick up the call after 3 rings if you have new messages or 5 rings if you do not have any messages.

---

## 16.10 Remote access

You can operate your answering machine when you are away from home by calling your phone from a touch tone phone and entering your 4-digit PIN code.

#### Note

The remote access PIN code is the same as your system PIN. To change your PIN, see "Changing your PIN" on page 44.

---

### 16.10.1 Activating/deactivating remote access

You can allow or block remote access to your answering machine.

- 1 Press .
- 2 Select **ANSWER MACHINE > SETTINGS > REMOTE ACCESS**. Press **OK**.
- 3 Select the new setting. Press **OK**.
  - *The setting is saved.*

---

### 16.10.2 Accessing your answering machine remotely

- 1 Make a call to your home number from a touch tone phone.
- 2 Press  when the greeting message starts playing.
- 3 Enter your PIN code. You now have access to your answering machine, and new message(s) starts playing.

#### Note

You have 2 tries to enter the correct PIN code before your phone hangs up.

- 4 Press a key to carry out a function. See the Remote access commands table below for a list of available functions.

#### Note

When no message is playing, your phone will hang up automatically if no key is pressed for 8 seconds.

### Remote access commands

Key	Function
1	Repeat current or play previous message
2	Play messages
3	Skip to next message
6	Delete current message
7	Switch answering machine on (not available during playback)
8	Stop message playback
9	Switch answering machine off (not available during playback)

## 17 Default (pre-programmed) settings

Language	English
Handset Name	PHILIPS
Date	Unchanged
Date Format	MM/DD
Time	Unchanged
Time Format	12-hour
Alarm	Off
Phonebook List	Unchanged
Auto Hang Up	On
Flash Time	Long
Quick Dial	[Empty]
Easy Call Mode	Off
Easy Call Number	[Empty]
Call Barring Mode	Off
Call Barring Number	[Empty]
First Ring	On
Network Services	Reset
Contrast	Level 3
Conference	On
Dial Mode	Tone
Area Code	[Empty]
Auto Prefix	[Empty]
Handset Ring Melody	Ring 1

Alarm Tone	Bell 2
Receiver Volume	Level 3
Handset Ring Volume	Level 3
Handset Key Beep	On
XHD Sound	On
Incoming Call Log	[Empty]
Redial List	[Empty]
PIN Code	0000

### Answering Machine

Ans Machine Status	On
Ans Machine Mode	Ans & Rec
Base Call Screening	On
Handset Call Screening	Off
Greeting message memory	Pre-recorded greeting message
Incoming message memory	[Empty]
Remote Access	Off
Voice Language	English
Ring Delay	Economy
Speaker Volume	Level 3

---

## 18 Technical Data

---

### Display

- Blue LCD backlight

### General telephone features

- Caller name & number identification
- 9 phonebook memories with direct access
- Conference call and voicemails
- Intercom

### Phonebook list, Redial list and Call log

- Phonebook list with 100 entries
- Redial list with 10 entries
- Call log with 50 entries

### Battery

- 2 x AAA NiMH Rechargeable 750mAh batteries

### Power consumption

- Power consumption at idle mode: around 1.3W

### Weight and dimensions (CD455)

- Handset: 120 grams
- 163 x 26 x 46 mm (H x D x W)
- Base: 230 grams
- 82 x 115 x 134 mm (H x D x W)

### Weight and dimensions (SE455)

- Handset: 120 grams
- 161 x 25 x 46 mm
- Base: 230 grams
- 77 x 117 x 131 mm (H x D x W)

### Temperature range

- Operation: 0°C to +40°C
- Storage: -25°C to +70°C

### Relative humidity

- Operation: Up to 95% at 40°C
- Storage: Up to 95% at 40°C

---

## 19 Frequently asked questions

[www.philips.com/support](http://www.philips.com/support)

---

In this chapter, you will find the most frequently asked questions and answers about your phone.

### Connection

#### Signal icon flashing

- The handset may be out of range. Move closer.
- If the handset displays **UNREGISTERED**, register the handset. See page 44.

---

### Set-up

#### Registration fails continuously

- Your base memory may be full. Delete an un-used handset and try again. See page 44.

---

### Sound

#### No dialing tone

- Check your phone connections.
- The handset may be out of range. Move closer.

#### No parking tone

- The handset may not be placed properly on the cradle. Try again.
- Charging contacts may be dirty. Disconnect the power supply first and then clean contacts with a damp cloth.

---

### Product behaviour

#### I cannot change the settings of my voice mail

- Operator voice mail is managed by your operator and not the phone itself. Please contact your operator should you want to change the settings.

#### Handset on the charger does not charge

- Check that the batteries are inserted correctly.
- Make sure the handset is placed properly on the charger. The battery icon animates while charging.
- Batteries may be defective. Purchase new ones from your dealer.

#### No display

- Check that the batteries are charged.
- Check the power and phone connections.

#### Bad audio (crackles, echo, etc.)

- The handset may be nearly out of range. Move closer to the base.
- The phone may be receiving interference from nearby electrical appliances. Move the base.

- The phone may be at a location with thick walls. Move the base.

**Handset does not ring**

- Check that the handset ringer is turned on. See page 34.

**Caller ID does not display**

- Service may not be activated. Check with your service provider.
- The caller's information may be withheld or is unavailable.

**Cannot make / answer a 2nd call**

- Service may not be activated. Check with your service provider.
- Check that the flash selection is correct. See page 36.

 **Note**

If the above solutions do not help, remove the power from both the handset and the base. Wait for 1 minute and try again.



---

## 20 Appendix

---

### 20.1 Equipment approval Information

Your telephone equipment is approved for connection to the public switched telephone network and is in compliance with parts 15 and 68, FCC Rules and Regulations and the Technical Requirements for Telephone Terminal Equipment published by ACTA.

---

### 20.2 Notification to the local telephone company

On the bottom of this equipment is a label indicating, among other information, the US number and Ringer Equivalence Number (REN) for the equipment. You must, upon request, provide this information to your telephone company. The REN is useful in determining the number of devices you may connect to your telephone line and still have all of these devices ring when your telephone number is called. In most (but not all) areas, the sum of the RENs of all devices connected to one line should not exceed 5. To be certain of the number of devices you may connect to your line as determined by the REN, you should contact your local telephone company. A plug and jack used to connect this equipment to the premises wiring and telephone network must comply with the applicable FCC Part 68 rules and requirements adopted by the ACTA. A compliant telephone cord and modular

plug is provided with this product. It is designed to be connected to a compatible modular jack that is also compliant. See installation instructions for details.

---

### 20.3 Notes

- This equipment may not be used on coin service provided by the telephone company.
- Party lines are subject to state tariffs, and therefore, you may not be able to use your own telephone equipment if you are on a party line. Check with your local telephone company.
- Notice must be given to the telephone company upon permanent disconnection of your telephone from your line.
- If your home has specially wired alarm equipment connected to the telephone line, ensure the installation of this product does not disable your alarm equipment. If you have questions about what will disable alarm equipment, consult your telephone company or a qualified installer.

---

### 20.4 Rights of the Phone Company

Should your equipment cause trouble on your line which may harm the telephone network, the telephone company shall, where practicable, notify you that temporary discontinuance of service may be required. Where prior notice is not practicable and the circumstances warrant such action, the telephone company may temporarily discontinue service immediately. In case of such

temporary discontinuance, the telephone company must:

(1) promptly notify you of such temporary discontinuance; (2) afford you the opportunity to correct the situation; and (3) inform you of your right to bring a complaint to the Commission pursuant to procedures set forth in Subpart E of Part 68, FCC Rules and Regulations. The telephone company may make changes in its communications facilities, equipment, operations or procedures where such action is required in the operation of its business and not inconsistent with FCC rules and Regulations. If these changes are expected to affect the use or performance of your telephone equipment, the telephone company must give you adequate notice, in writing, to allow you to maintain uninterrupted service.

---

## 20.5 Interference Information

This device complies with Part 15 of the FCC Rules. Operation is subject to the following two conditions:

(1) this device may not cause harmful interference; and (2) this device must accept any interference received, including interference that may cause undesired operation.

This equipment has been tested and found to comply with the limits for a Class B digital device, pursuant to Part 15 of the FCC Rules. These limits are designed to provide reasonable protection against harmful interference in a residential installation.

This equipment generates, uses, and can

radiate radio frequency energy and, if not installed and used in accordance with the instructions, may cause harmful interference to radio communications. However, there is no guarantee that interference will not occur in a particular installation.

If this equipment does cause harmful interference to radio or television reception, which can be determined by turning the equipment off and on, the user is encouraged to try to correct the interference by one or more of the following measures:

- Reorient or relocate the receiving antenna (that is, the antenna for radio or television that is receiving the interference).
- Reorient or relocate and increase the separation between the telecommunications equipment and receiving antenna.
- Connect the telecommunications equipment into an outlet on a circuit different from that to which the receiving antenna is connected.

If these measures do not eliminate the interference, please consult your dealer or an experienced radio/television technician for additional suggestions. Also, the Federal Communications Commission has prepared a helpful booklet, "How To Identify and Resolve Radio/TV Interference Problems". This booklet is available from the U.S. Government Printing Office, Washington, D.C. 20402.

Please specify stock number 004-000-00345-4 when ordering copies.

---

## 20.6 Noise

Electrical pulse noise is present at one time or another. This is most intense during electrical storms. Certain kinds of electrical equipment, such as light dimmers, fluorescent bulbs, motors, fans, etc., also generate pulse noise. Because radio frequencies are susceptible to this, you may on occasion hear pulse noise through the receiver. This is usually only a minor annoyance and should not be interpreted as a defect of the unit.

---

## 20.7 FCC RF Radiation Exposure Statement

This equipment complies with FCC RF radiation exposure limits set forth for an uncontrolled environment. This equipment should be installed and operated with a minimum distance of 20 centimeters between the radiator and your body. This transmitter must not be co-located or operating in conjunction with any other antenna or transmitter. For hand held operation, this phone has been tested and meets the FCC RF exposure guidelines. For Body-worn operation, use only with the belt clip. Use of other accessories may not ensure compliance with FCC RF exposure guidelines.

---

## 20.8 Hearing Aid Compatibility (HAC)

This telephone system meets FCC and Industry Canada standards for Hearing Aid Compatibility.

---

## 20.9 Privacy

Privacy of communications may not be ensured when using this telephone.

---

## 20.10 Additional Information

I.C. Notice

---

## 20.11 Terminal Equipment

### Note

This equipment meets the applicable Industry Canada Terminal Equipment Technical Specifications.

This is confirmed by the registration number. The abbreviation, IC, before the registration number signifies that registration was performed based on a Declaration of Conformity indicating that Industry Canada technical specifications were met. It does not imply that Industry Canada approved the equipment.

### Note

The Ringer Equivalence Number (REN) for this terminal equipment is marked on the equipment itself. The REN assigned to each terminal equipment provides an indication of the maximum number of terminals allowed to be connected to a telephone interface. The termination on an interface may consist of any combination of devices subject only to the requirement that the sum of the Ringer Equivalence Numbers of all the devices does not exceed five.

---

## 20.12 Radio Equipment

The term "IC:" before the radio certification number only signifies that Industry Canada technical specifications RSS-213 and ICES-003 were met. This Class B digital apparatus complies with Canadian ICES-003. Operation is subject to the following two conditions: (1) this device may not cause interference, and (2) this device must accept any interference, including interference that may cause undesired operation of the device.

---

## 20.13 Do not attempt to repair or modify this equipment

Repairs to certified equipment should be made by an authorized maintenance facility designated by the supplier.

Any repairs or alterations made by the user to the equipment may render the equipment void in product warranty and compliance. This could also void the user's authority to operate the equipment.

## US / Canada Service Center

Philips Accessories & Computer  
Peripherals  
North America  
1881 Route 46 West  
Ledgewood, NJ 07852  
Phone: (800) 233-8413

---

## 20.14 The RBRC® seal



The RBRC® Seal on the nickel metal hydride battery indicates that Philips Royal Electronics is voluntarily participating in an industry program to collect and recycle these batteries at the end of their useful lives, when taken out of service within the United States and Canada. The RBRC® program provides a convenient alternative to placing used nickel metal hydride batteries into the trash or municipal waste, which may be illegal in your area.

Philips's participation in RBRC® makes it easy for you to drop off the spent battery at local retailers participating in the RBRC® program or at authorized Philips product service centers. Please call 1-800-8-BATTERY for information on Ni-MH battery recycling and disposal bans/restrictions in your area. Philips's involvement in this program is part of its commitment to protecting our environment and conserving natural resources.

RBRC® is a registered trademark of Rechargeable Battery Recycling Corporation.

---

## 21 Index

---

### **A**

Accessories 9  
Alarm clock 42  
Answering a call 23  
Answering Machine 46  
Area code 37  
Audio quality 35  
Auto conference 36  
Auto hang up 36  
Auto prefix 37

### **C**

Call 22  
Call barring 36  
Call forward 39  
Call log 31  
Call return 40  
Call screening 49  
Calling Features 36  
Calling from the call log 22  
Calling from the phonebook 22, 28  
Cancel call back 40  
Changing your PIN 44  
Clock and alarm 28  
Conference Calls 25  
Conformity 7  
Connect the base station 13  
Contrast 34

### **D**

Default settings 51  
Deleting a record 29  
Deleting all records 29  
Dial mode 36  
Display icons 12  
Display language 34

### **E**

Easy call 42  
Ending a call 23  
Entering text and numbers 27  
Extra Features 42

### **F**

First ring 38  
Flash selection 36  
Frequently asked questions 53

### **H**

Handset locator 43  
Handsfree 23

### **I**

Info center 40  
Intercom 25

### **K**

Key tone 34  
Keypad lock 43

### **M**

Making a call 22  
Making a conference call 25  
Making a second call 24  
Menu structure 18  
Message alert 49  
Muting the microphone 23

### **N**

Naming your handset 34  
Network Services 39

### **O**

Outgoing messages (OGM) 47  
Overview of the base 11  
Overview of the handset 10

**P**

- Personalizing your phone's display 34
- Personalizing your phone's sounds 34
- Phonebook 28
- Power requirements 6
- Pre-dialing 22

**Q**

- Quick dial 29

**R**

- Recycling & disposal 7
- Redial List 33
- Redialing a call 33
- Redialing the last number 22
- Registering handset 44
- Remote access 50
- Restoring default settings 44
- Ringer melody 34
- Ringer volume 34

**S**

- Setting the clock 16
- Setting the ring delay 49
- Switch calls 24

**T**

- Transferring a call 25

**U**

- Un-registering a handset 44

**V**

- Voicemail 39

**W**

- Wall mounting 13
- Withholding ID 41





© 2008 Koninklijke Philips Electronics N.V.

All rights reserved

Reproduction in whole or in part is prohibited without the written consent of the copyright owner

Document number: 3111 285 46303



Please Recycle

Printed in China



## Free Manuals Download Website

<http://myh66.com>

<http://usermanuals.us>

<http://www.somanuals.com>

<http://www.4manuals.cc>

<http://www.manual-lib.com>

<http://www.404manual.com>

<http://www.luxmanual.com>

<http://aubethermostatmanual.com>

Golf course search by state

<http://golfingnear.com>

Email search by domain

<http://emailbydomain.com>

Auto manuals search

<http://auto.somanuals.com>

TV manuals search

<http://tv.somanuals.com>