

Cucina

HR7745, HR7740



PHILIPS

Download from www.Somanuals.com. All Manuals Search And Download.

PHILIPS
Cucina



- EN** | English
- DE** | Deutsch
- FR** | Français
- NL** | Nederlands
- NO** | Norsk
- SV** | Svenska
- FI** | Suomi
- DK** | Dansk

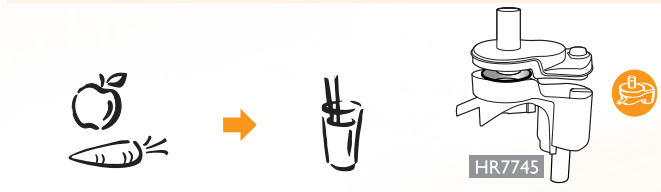

4



11



15



18



21



24



27



32



34



37



38



42



49



50



55





EN | Important

Read these instructions for use carefully before using the appliance and save them for future reference.

- ▶ Check if the voltage indicated on the appliance corresponds to the local mains voltage before you connect the appliance.
- ▶ In order to avoid a hazardous situation, this appliance must never be connected to a timer switch.
- ▶ Do not use the appliance if the mains cord, the plug or other parts are damaged.
- ▶ If the mains cord is damaged, it must be replaced by Philips, a service centre authorised by Philips or similarly qualified persons in order to avoid a hazard.
- ▶ Keep the appliance out of the reach of children.
- ▶ Never let the appliance run unattended.
- ▶ Always switch the appliance off by turning the control knob to 0.
- ▶ Switch the appliance off before detaching any accessory.
- ▶ Unplug the appliance immediately after use.
- ▶ Never immerse the motor unit in water or any other liquid, nor rinse it under the tap.
- ▶ Never use your fingers or an object (e.g. a spatula) to push ingredients down the feed tube while the appliance is running. Only the pusher is to be used for this purpose.
- ▶ Be very careful when handling the blades or inserts, especially when removing them from the bowl or jar, when emptying the bowl or jar and during cleaning. Their cutting edges are very sharp!
- ▶ Always unplug the appliance before reaching into the blender jar with your fingers or an object (e.g. a spatula).
- ▶ Wait until moving parts have stopped running before you remove the lid of the bowl or jar.
- ▶ Never use any accessories or parts from other manufacturers or that have not been specifically advised by Philips. Your guarantee will become invalid if such accessories or parts have been used.
- ▶ Do not exceed the maximum content indicated on the bowl or the blender jar.
- ▶ Consult the table in these directions for use for the correct processing times.

- ▶ Let hot ingredients cool down before processing them (max. temperature 80°C/175°F).
- ▶ The food-processing functions and the citrus press can only be used when the blender cap is attached.
- ▶ Note that it is not possible to use the food-processing functions when the blender is attached to the motor unit!
- ▶ Do not use the juicer if the rotating sieve is damaged.
- ▶ Thoroughly clean the parts that will come into contact with food before you use the appliance for the first time.

Thermal safety cut-out

This appliance is equipped with a thermal safety cut-out which will automatically cut off the power supply to the appliance in case of overheating.

If your appliance stops running:

- Pull the mains plug out of the socket.
- Let the appliance cool down for 60 minutes.
- Put the mains plug in the socket.
- Switch the appliance on again.

Please contact your Philips dealer or an authorised Philips service centre if the thermal safety cut-out is activated too often.

DE | Wichtig

Lesen Sie diese Bedienungsanleitung vor der ersten Benutzung des Geräts gründlich durch und bewahren Sie sie zur späteren Einsichtnahme auf.

- ▶ Prüfen Sie vor Inbetriebnahme, ob die Spannungsangabe auf dem Gerät mit der örtlichen Netzspannung übereinstimmt.
- ▶ Schließen Sie das Gerät niemals an eine Zeitschaltuhr an, um Gefährdungen zu vermeiden.
- ▶ Verwenden Sie das Gerät nicht, wenn das Netzkabel, der Netzstecker oder andere Geräteteile defekt sind.
- ▶ Wenn das Netzkabel defekt oder beschädigt ist, darf es nur von einem Philips Service-Center oder einer von Philips autorisierten Werkstatt ausgetauscht werden, um Gefährdungen zu vermeiden.



- ▶ Halten Sie das Gerät außer Reichweite von Kindern.
- ▶ Lassen Sie das eingeschaltete Gerät niemals unbeaufsichtigt.
- ▶ Stellen Sie zum Ausschalten des Geräts immer den Schalter auf 0.
- ▶ Schalten Sie das Gerät aus, bevor Sie einen Einsatz herausnehmen.
- ▶ Ziehen Sie nach jedem Gebrauch sofort den Netzstecker aus der Steckdose.
- ▶ Tauchen Sie die Motoreinheit niemals in Wasser oder in eine andere Flüssigkeit; spülen Sie sie auch nicht unter fließendem Wasser ab.
- ▶ Drücken Sie Lebensmittel niemals mit den Fingern oder irgendwelchen Gegenständen in den Einfüllstutzen, solange das Gerät läuft. Verwenden Sie hierzu nur den Stopfer.
- ▶ Vorsicht bei der Handhabung von Messer und Einsätzen - insbesondere beim Herausnehmen von Messer/Einsätzen aus der Schüssel bzw. dem Mixbecher, beim Leeren von Schüssel und Mixbecher sowie beim Reinigen! Die Klingen sind sehr scharf!
- ▶ Ziehen Sie stets den Netzstecker aus der Steckdose, bevor Sie mit den Fingern oder einem Gegenstand, z. B. mit dem Spatel, in den Mixbecher langen.
- ▶ Nehmen Sie den Deckel der Schüssel oder des Mixbechers erst ab, nachdem alle beweglichen Teile zum Stillstand gekommen sind.
- ▶ Verwenden Sie mit dieser Küchenmaschine keine Zubehör- oder Ersatzteile, die von Philips nicht ausdrücklich empfohlen werden. Andernfalls erlischt die Garantie.
- ▶ Füllen Sie die Schüssel bzw. den Mixbecher nicht über die jeweils oberste Markierung hinaus.
- ▶ Die richtigen Verarbeitungszeiten sind in der Tabelle dieser Bedienungsanleitung aufgeführt.
- ▶ Lassen Sie heiße Zutaten auf höchstens 80° C abkühlen, bevor Sie sie im Gerät verarbeiten.
- ▶ Schüssel und Zitruspresse funktionieren nur, wenn die Verschlusskappe des Mixers angebracht ist.
- ▶ Hinweis: Die Schüssel kann nicht zur Verarbeitung benutzt werden, solange der Mixer auf der Motoreinheit montiert ist!
- ▶ Benutzen Sie den Entsafter nicht, wenn das rotierende Sieb in irgendeiner Hinsicht beschädigt ist.

- ▶ Waschen Sie vor dem ersten Gebrauch sorgfältig alle Teile ab, die mit Lebensmitteln in Berührung kommen.

Automatischer Überhitzungsschutz

Das Gerät ist mit einem automatischen Überhitzungsschutz ausgestattet, der die Stromzufuhr bei Gefahr einer Überhitzung selbsttätig abschaltet.

Wenn Ihr Gerät nicht mehr läuft:

- Ziehen Sie den Netzstecker aus der Steckdose.
- lassen Sie das Gerät 60 Minuten abkühlen,
- stecken Sie den Stecker in die Steckdose und
- Schalten Sie das Gerät wieder ein.

Wenden Sie sich bitte an Ihren Philips-Händler oder ein Philips Service-Center, falls der automatische Überhitzungsschutz das Gerät zu häufig ausschaltet.

FR | Important

Lisez ces instructions avant d'utiliser l'appareil et conservez-les pour un usage ultérieur.

- ▶ Avant de brancher l'appareil, vérifiez que la tension indiquée sur l'appareil correspond à la tension du secteur de votre logement.
- ▶ Afin d'éviter tout accident causé par la remise en marche de l'interrupteur de sécurité thermique, l'appareil ne doit pas être connecté à un minuteur.
- ▶ N'utilisez pas l'appareil si le cordon d'alimentation, la fiche ou d'autres pièces sont détériorées.
- ▶ Si le cordon d'alimentation est endommagé, il ne doit être remplacé que par Philips ou par un Centre Service Agréé, pour éviter tout accident.
- ▶ Tenez l'appareil hors de portée des enfants.
- ▶ Ne laissez jamais l'appareil fonctionner sans surveillance.
- ▶ Arrêtez toujours l'appareil en tournant le bouton sur 0.
- ▶ Arrêtez toujours l'appareil avant de détacher un accessoire.
- ▶ Débranchez l'appareil immédiatement après utilisation.
- ▶ N'immergez jamais le bloc moteur dans l'eau ni dans autre liquide. Ne le rincez pas non plus.





- ▶ Ne mettez jamais vos doigts ou tout autre objet, (par ex. la spatule), dans la cheminée de remplissage pour pousser les ingrédients sans avoir au préalable arrêté l'appareil. Utilisez uniquement le poussoir.
- ▶ Faites attention en manipulant le couteau et les inserts, surtout lorsque vous les enlevez du bol ou du verre pour verser les ingrédients ou lors du nettoyage. Les bords des inserts et les lames du couteau sont très aiguisées!
- ▶ Débranchez toujours l'appareil avant de mettre vos doigts ou tout autre objet dans le bol mixeur (par ex. la spatule).
- ▶ Avant de retirer le couvercle, attendez que toutes les pièces mobiles soient à l'arrêt.
- ▶ N'utilisez jamais des accessoires ou des composants autres que ceux d'origine et recommandés par Philips. Philips décline toute responsabilité en cas de non respect de ces recommandations. La garantie dans ce cas ne pourrait s'appliquer.
- ▶ Ne dépassez pas le contenu maximum du bol pour préparer les aliments ou du bol mixeur.
- ▶ Consultez le tableau du mode d'emploi pour les temps de préparation corrects.
- ▶ Laissez les aliments cuits refroidir avant de les hacher (température maximale 80°C/ 175°F).
- ▶ Les fonctions du bol pour préparer les aliments et le presse-agrumes peuvent être utilisés seulement si le capuchon mixeur est attaché.
- ▶ Notez que si le mixeur est monté, vous ne pouvez pas utiliser les fonctions du bol.
- ▶ N'utilisez pas la centrifugeuse lorsque le tambour est endommagé.
- ▶ Avant la première utilisation, nettoyez toutes les pièces en contact avec les aliments.

Coupe-circuit thermique

L'appareil est équipé d'une coupure thermique de sécurité. En cas de surchauffe, ce dispositif coupe automatiquement l'alimentation électrique de l'appareil.

Si votre appareil s'arrête:

- Débranchez l'appareil.
- Laissez refroidir l'appareil 60 minutes.
- Branchez l'appareil à nouveau.
- Remettez l'appareil en marche.

Consultez votre revendeur ou un Centre Service Agréé Philips si l'interrupteur de sécurité se déclenche trop fréquemment.

NL | Belangrijk

Lees deze gebruiksaanwijzing zorgvuldig door voordat u het apparaat gaat gebruiken. Bewaar de gebruiksaanwijzing om hem indien nodig te kunnen raadplegen.

- ▶ Controleer of het voltage aangegeven op het apparaat overeenkomt met de plaatselijke netspanning voordat u de stekker in het stopcontact steekt.
- ▶ Om gevaarlijke situaties te voorkomen, mag u dit apparaat nooit op een timer aansluiten.
- ▶ Gebruik het apparaat niet indien het snoer, de stekker of andere onderdelen beschadigd zijn.
- ▶ Indien het netsnoer beschadigd is, moet het vervangen worden door Philips, een door Philips geautoriseerd servicecentrum of personen met vergelijkbare kwalificaties om gevaar te voorkomen.
- ▶ Houd het apparaat buiten het bereik van kinderen.
- ▶ Laat het apparaat nooit zonder toezicht werken.
- ▶ Schakel het apparaat altijd uit door de bedieningsknop naar 0 te draaien.
- ▶ Schakel het apparaat uit voordat u accessoires van het apparaat losmaakt.
- ▶ Haal na gebruik altijd gelijk de stekker uit het stopcontact.
- ▶ Dompel de motorunit nooit in water of een andere vloeistof en spoel hem niet af onder de kraan.
- ▶ Gebruik nooit uw vingers of voorwerpen (bijvoorbeeld een spatel) om etenswaren door de vultrechter naar beneden te duwen terwijl het apparaat werkt. Gebruik hiervoor alleen de stamper.



tilbehør/deler som ikke er spesielt anbefalt av Philips. Garantien gjelder ikke hvis slike deler eller slikt tilbehør brukes.

- ▶ Ikke overskrid maksimumsgrensen for innhold som er angitt på bollen eller muggen.
- ▶ Se tabellen i disse instruksjonene for riktige bearbeidingstider.
- ▶ Varme ingredienser må avkjøles før de bearbeides i maskinen (maks. temperatur: 80°C).
- ▶ Foodprocessorfunksjonene og sitruspressen kan bare brukes når mikserlokket er på.
- ▶ Legg merke til at det ikke er mulig å bruke foodprocessorfunksjonene når mikseren er koblet til motorenheten.
- ▶ Ikke bruk saftpressen hvis den roterende silen er skadet.
- ▶ Før du bruker apparatet for første gang, må alle deler som kommer i kontakt med mat, rengjøres grundig.

Sikkerhetsbryter

Dette apparatet er utstyrt med en sikkerhetsbryter som automatisk vil kutte strømmen til apparatet hvis det blir for varmt.

Hvis apparatet stanser:

- Trekk støpselet ut av stikkkontakten.
- La apparatet avkjøles i 60 minutter.
- Sett støpselet inn i stikkkontakten.
- Slå apparatet på igjen.

Kontakt en Philips-forhandler eller et autorisert Philips-servicesenter hvis sikkerhetsbryteren aktiveres for ofte.

SV | Viktigt

Läs följande instruktioner noggrant innan du använder apparaten, och spara dem för framtida referens.

- ▶ Kontrollera att den spänning som anges på apparaten motsvarar den i det lokala elnätet innan du ansluter apparaten.
- ▶ Denna apparat får aldrig anslutas till en tidströmställare. Detta för att undvika en farlig situation.

- ▶ Använd inte apparaten om nätsladden, stickkontakten eller någon annan del är skadad.
- ▶ Om nätsladden är skadad måste den bytas ut av Philips, ett av Philips auktoriserat servicecenter eller liknande kvalificerade personer för att undvika att fara uppstår.
- ▶ Håll apparaten utom räckhåll för barn.
- ▶ Lämna aldrig apparaten obevakad när den är igång.
- ▶ Stäng alltid av apparaten genom att vrida kontrollvredet till 0.
- ▶ Stäng av apparaten innan du tar av någon del från den.
- ▶ Ta ut skickkontakten ur vägguttaget när du är klar.
- ▶ Sänk aldrig ner motorenheten i vatten eller någon annan vätska och skölj den inte heller under kranen.
- ▶ Använd aldrig fingrarna eller något annat verktyg än påmataren, för att föra ner mat i mataröppningen medan apparaten är igång.
- ▶ Var mycket försiktig när du hanterar knivarna eller skivorna, särskilt när du tar ut dem ur skålen eller kannan, när du tömmer skålen eller kannan och vid rengöring. Kniveggarna är mycket vassa!
- ▶ Ta alltid ur stickkontakten ur vägguttaget innan du för ner fingrarna eller exempelvis degskrapan i blandarskålen.
- ▶ Vänta tills rörliga delar har slutat gå innan du tar bort locket på skålen eller kannan.
- ▶ Använd aldrig tillbehör eller delar från andra tillverkare, eller sådana som inte specifikt har anvisats av Philips. Din garanti gäller inte om du gör det.
- ▶ Överskrid inte maxinnehållet som anges på skålen eller mixerkannan.
- ▶ Läs tabellen i den här bruksanvisningen för att få reda på rätt beredningstider.
- ▶ Varma ingredienser ska svalna innan du bearbetar dem (maxtemperatur 80°C/175°F).
- ▶ Matberedningsfunktionerna och citruspressen kan endast användas när mixerlokket är påsatt.
- ▶ Tänk på att det inte går att använda matberedningsfunktionerna när mixern är fastsatt på motorenheten!
- ▶ Använd inte saftpressen om det roterande sållet är skadat.

- Rengör de olika delar som kommer i kontakt med maten innan du använder apparaten första gången.

Värmesäkring

Denna apparat är utrustad med en värmesäkring som automatiskt stänger av strömtillförseln till apparaten i händelse av överhettning.

Om din apparat slutar att fungera:

- Ta ut stickkontakten ur vägguttaget.
- Låt matberedaren svalna i 60 minuter.
- Sätt in stickkontakten i vägguttaget.
- Slå på apparaten igen.

Kontakta din Philips-återförsäljare eller ett av Philips auktoriserat servicecenter om värmesäkringens aktiveras för ofta.

FI | Tärkeää

Lue tämä käyttöohje huolellisesti ennen laitteen käyttöönottoa ja säilytä ohje vastaisen varalle.

- Tarkasta, että laitteeseen merkitty käyttöjännite vastaa paikallista verkkojännitettä (220-240 V), ennen kuin liität laitteen pistorasiaan.
- Vaaratilanteiden välttämiseksi laitetta ei saa koskaan liittää aikakyttimeen.
- Älä käytä laitetta, jos sen liitosjohto, pistotulppa tai jokin muu osa on viallinen.
- Tarkasta liitosjohdon kunto säännöllisesti. Jos tämän laitteen verkkoliitosjohto vaurioituu, vaihdata se oman turvallisuutesi vuoksi Philips Kodinkoneiden valtuuttamassa huoltoliikkeessä tai muuten ammattitaitoisella korjaajalla.
- Pidä laite poissa lasten ulottuvilta. Älä anna lasten käyttää laitetta ilman valvontaa.
- Älä jätä laitetta käyntiin ilman valvontaa.
- Katkaise aina laitteesta virta kääntämällä ohjauskytkin 0-asentoon.
- Katkaise laitteen toiminta ennen lisäosan irrotusta.
- Irrota pistotulppa pistorasiasta heti käytön jälkeen.
- Älä upota runkoa veteen tai muuhun nesteeseen. Älä myöskään huuhtelee sitä vesihanalla.

- Paina aineita syöttösuppiloissa alaspäin vain syöttöpainimella, ei koskaan sormilla tai esim. kaapimella.
- Käsittele teriä ja lisäosia varovasti erityisesti poistaessasi niitä kulhosta tai kannusta, tyhjentäessäsi kulhoa tai kannua ja puhdistuksen yhteydessä. Terät ovat hyvin teräviä.
- Irrota aina pistotulppa pistorasiasta, ennen kuin laitat tehosekoittimen kannuun sormiasi tai esim. kaapimen.
- Odota, kunnes liikkuvat osat ovat pysähtyneet, ennen kuin poistat kannen kulhosta tai kannusta.
- Älä käytä laitteessa muiden valmistajien lisäosia tai muita osia, ellei Philips ole näin erikseen neuvonut. Takuu ei korvaa vahinkoja, jos tällaisia osia on käytetty.
- Älä ylitä kulhoon tai kannuun merkittyä enimmäistilavuuden rajaa.
- Tarkista oikeat käsittelyajat tämän käyttöohjeen taulukosta.
- Anna kuumien aineiden jäähtyä ennen käsittelyä (maksimilämpötila 80°C).
- Monitoimikoneen toimintoja ja sitruspuristinta voidaan käyttää vain, kun tehosekoittimen kansi on paikallaan.
- Ota huomioon, että monitoimikoneen toimintoja ei voi käyttää, kun tehosekoitin on kiinnitetty runkoon.
- Älä käytä mehustinta, jos pyörivä siivilä on vaurioitunut.
- Pese kaikki ruuan kanssa kosketuksiin joutuvat osat ennen käyttöönottoa.

Lämpökytkin

Laitteessa on lämpökytkin, joka katkaisee laitteesta automaattisesti virran, jos laite kuumenee liikaa.

Jos laitteen toiminta keskeytyy, toimi seuraavasti:

- Vedä liitosjohto irti pistorasiasta.
- Anna laitteen jäähtyä 60 minuuttia.
- Työnnä pistotulppa pistorasiaan.
- Käynnistä laite uudelleen.

Jos lämpökytkin katkaisee laitteesta virran toistuvasti, ota yhteys Philipsin jälleenmyyjään tai Philipsin valtuuttamaan huoltoliikkeeseen.





DK | **Vigtigt**

Læs brugsvejledningen omhyggeligt igennem, inden apparatet tages i brug, og gem den til eventuelt senere brug.

- ▶ Før der slutes strøm til apparatet, skal du kontrollere, om spændingsangivelsen på apparatet svarer til den lokale netspænding.
- ▶ Apparatet må aldrig slutes til en timer, da det kan medføre farlige situationer.
- ▶ Brug ikke apparatet, hvis netledning, stik eller andre dele er beskadigede.
- ▶ Hvis netledningen beskadiges, må den kun udskiftes af Philips, et autoriseret Philips-serviceværksted eller en tilsvarende kvalificeret fagmand for at undgå enhver risiko.
- ▶ Hold apparatet uden for børns rækkevidde.
- ▶ Lad aldrig apparatet køre uden opsyn.
- ▶ Sluk altid for apparatet ved at stille kontrolknappen på 0.
- ▶ Sluk altid for apparatet, inden tilbehøret afmonteres.
- ▶ Tag altid stikket ud af stikkontakten straks efter brug.
- ▶ Motorenheden må ikke kommes ned i vand eller andre væsker eller skylles under vandhanen.
- ▶ Stik aldrig fingrene eller køkkenredskaber (f.eks. en spatel) ned i påfyldningstragten, mens apparatet kører. Brug kun nedstopperen til dette formål.
- ▶ Vær ekstra forsigtig, når du bruger knivenhed og indsætter, specielt når du tager dem ud af skål eller blenderglas - når du tømmer skål eller blenderglas, og når delene gøres rene. De skærende sider er meget skarpe!
- ▶ Tag altid stikket ud af stikkontakten, før du stikker fingrene eller køkkenredskaber (f.eks. en spatel) ned i blenderglasset.
- ▶ Vent, indtil de bevægelige dele er stoppet, før du fjerner låget fra skål eller blenderglas.
- ▶ Brug aldrig tilbehør eller dele af andre fabrikater eller tilbehør/dele, som ikke er anbefalet af Philips, da garantien i så fald bortfalder.
- ▶ Undlad at overskride maksimummarkeringerne på skål og blenderglas.

- ▶ I tabellen i denne brugsvejledning finder du en oversigt over de korrekte tilberedningstider.
- ▶ Varme ingredienser skal afkøles, før de tilberedes (maks. temperatur 80°C).
- ▶ Foodprocessor og citruspresser fungerer kun, når blenderdækslet er skruet på.
- ▶ Bemærk, at det ikke er muligt at bruge foodprocessor-funktionerne, når blenderen er monteret på motorenheden!
- ▶ Undlad at bruge saftpresseren, hvis den roterende si er beskadiget.
- ▶ Alle dele, der kommer i kontakt med fødevarer, skal vaskes grundigt af, før apparatet tages i brug første gang.

Overophedningssikring

Apparatet er udstyret med en overophedningssikring, som automatisk afbryder strømmen i tilfælde af overophedning.

Hvis apparatet stopper:

- Tag stikket ud af stikkontakten.
- Lad apparatet afkøle i 60 minutter.
- Sæt stikket i stikkontakten.
- Tænd for apparatet igen.

Kontakt Philips via din Philips-forhandler for eventuel eftersyn/reparation, hvis overophedningssikringen aktiveres for ofte.



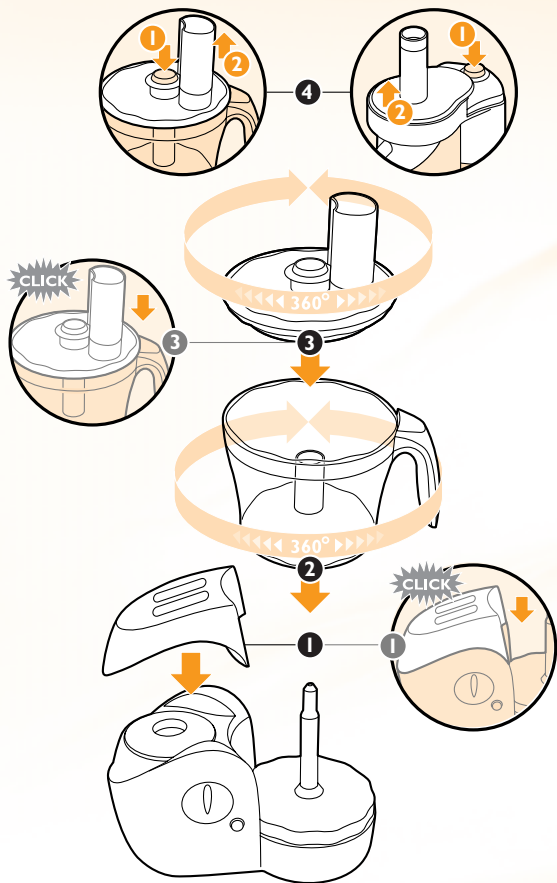

EN | Click & Go system - tips and warnings

- The patented 'Click & Go' assembly system of your new food processor allows you to assemble and disassemble your food processor in a very easy and safe way. Thanks to the flower-shaped rims, the bowl and the lid can be easily and securely attached in any position.
- The lid can be easily disconnected by pressing the Click & Go button in the centre of the lid.
- When using the appliance, make sure that the Click & Go button has been screwed into the lid properly to prevent ingredients from entering the Click & Go system.
- Built-in safety lock: This feature ensures that you can only switch the appliance on when the accessories have been placed on the motor unit in the correct position and the blender cap has been placed on the motor unit when the blender is not being used (see picture). In addition, when using the bowl, you can only switch the appliance on if you have secured the lid by clicking it onto the bowl. When all parts have been assembled correctly, the built-in safety lock will be unlocked.
- ▶ **Always clean the lid and the Click & Go button after use, preferably immediately.** See chapter 'Cleaning' for instructions on how to take the Click & Go system apart in order to clean it.
- ▶ *Note that it is not possible to use the food-processing functions when the blender is attached to the motor unit!*

DE | Click & Go-System: Tipps und Warnhinweise

- Mit dem patentierten "Click & Go"-System können Sie Ihre neue Küchenmaschine sehr leicht und sicher zusammensetzen und auseinandernehmen. Die wellenförmigen Ränder von Schüssel und Deckel machen das Anbringen in beliebiger Position einfach und sicher.
- Zum Abnehmen des Deckels drücken Sie einfach auf den Click & Go-Schalter in der Mitte des Deckels.
- Vergewissern Sie sich, dass der Click & Go-Schalter während des





Betriebs fest in den Deckel geschraubt ist, damit keine Zutaten in das Click & Co-System gelangen können.

- Integrierte Sicherheitssperre: Diese Funktion sorgt dafür, dass Sie das Gerät nur einschalten können, wenn die Aufsätze korrekt auf der Motoreinheit montiert sind bzw. bei Nichtbenutzung des Mixers der Verschluss auf der Motoreinheit angebracht ist (s. Abb. auf Seite 11). Wenn Sie die Schüssel verwenden, lässt sich das Gerät nur dann einschalten, wenn der Deckel fest auf der Schüssel eingerastet ist. Sind alle Teile ordnungsgemäß zusammengesetzt, entriegelt sich die integrierte Sicherheitssperre selbsttätig.

► **Reinigen Sie den Deckel und den Click & Go-Schalter möglichst unmittelbar nach jedem Gebrauch. Im Kapitel "Reinigung" finden Sie Anleitungen zum Auseinandernehmen und Reinigen des Click & Go-Systems.**

- *Hinweis: Die Schüssel funktioniert nicht, solange der Mixer auf der Motoreinheit angebracht ist!*

FR | Système Click & Go - suggestions et avertissements

- Le système breveté Click & Go de votre nouveau robot de cuisine vous permet de monter et démonter l'appareil facilement et en toute sécurité. Grâce aux rebords dentelés, le bol et le couvercle peuvent être fixés aisément en toute position.
- Le couvercle peut être facilement retiré en appuyant sur le bouton Click & Go au centre du couvercle.
- Lorsque vous utilisez le bol, assurez-vous que le bouton Click & Go a été vissé correctement sur le couvercle pour éviter que les ingrédients entrent dans le système Click & Go.
- Verrouillage de sécurité incorporé: Grâce à cette fonction, vous pouvez mettre l'appareil en marche seulement après avoir monté correctement les accessoires et que le capuchon du mixeur ait été placé sur le bloc moteur (voir figure à la page 11). De plus, lorsque vous voulez utiliser le mixeur, vous pouvez mettre l'appareil en marche seulement après avoir fixé le couvercle sur le bol (clic). Si tous les composants sont montés correctement, le verrouillage de sécurité incorporé se débloque.

► **Nettoyez toujours le couvercle et le bouton Click & Go après utilisation, de préférence immédiatement. Voir chapitre "Nettoyage" pour plus d'instructions sur la façon de désassembler le système Click & Go.**

- *Notez que si le mixer est monté, vous ne pouvez pas utiliser les fonctions du grand bol.*

NL | Click & Go systeem - tips en waarschuwingen

- Het gepatenteerde 'Click & Go' montagesysteem van uw nieuwe keukenmachine stelt u in staat het apparaat snel en veilig in elkaar te zetten en uit elkaar te halen. De kom en het deksel kunnen dankzij de geschulpte rand makkelijk en goed worden bevestigd in iedere stand.
- Het deksel kan makkelijk worden verwijderd door op de Click & Go knop midden op het deksel te drukken.
- Zorg er tijdens gebruik van het apparaat voor dat de Click & Go knop goed in het deksel is geschroefd om te voorkomen dat ingrediënten in het Click & Go systeem terechtkomen.
- Ingebouwde veiligheidsvergrendeling: Deze functie zorgt ervoor dat u het apparaat alleen kunt inschakelen als de accessoires in de juiste stand op de motorunit zijn gemonteerd en als de blenderkap op de motorunit is geplaatst wanneer de blender niet gebruikt wordt (zie plaatje op pagina 11). Wanneer u de kom gebruikt, kunt u het apparaat alleen inschakelen indien u het deksel goed heeft bevestigd door het op de kom vast te klikken. Alleen wanneer alle onderdelen op de juiste wijze zijn gemonteerd, zal de ingebouwde veiligheidsvergrendeling ontgrendeld worden.
- **Maak het deksel en de Click & Go knop altijd na gebruik schoon, bij voorkeur direct. Zie hoofdstuk 'Schoonmaken' voor instructies over hoe het Click & Go systeem uit elkaar moet worden genomen om het schoon te maken.**
- *Let op: Het is niet mogelijk de keukenmachinefuncties te gebruiken als de blender op de motorunit gemonteerd is.*



- ▶ Ota huomioon, että monitoimikoneen toimintoja ei voi käyttää, kun tehosekoitin on kiinnitetty runkoon.



DK | Click & Go-systemet - tips og advarsler



- Det patenterede Click & Go-system til samling af foodprocessoren sikrer, at du kan samle og skille foodprocessoren ad på en nem og sikker måde. Skål og låg har en blomsterformet kant, hvilket gør, at låget let og sikkert kan sættes på i enhver position.
- Låget kan let tages af ved at trykke på Click & Go-knappen på midten af låget.
- Når du bruger apparatet, skal du sikre, at Click & Go-knappen er skruet rigtigt fast på låget, så ingredienserne ikke kan trænge ind i Click & Go-systemet.
- Indbygget sikkerhedslås: Låsen sikrer, at du kun kan tænde for apparatet, når tilbehøret er monteret korrekt på motorenheden, og blenderdækslet er monteret på motorenheden, hvis blenderen ikke er i brug (se billedet på side 11). Når du bruger skålen, er det desuden kun muligt at tænde for apparatet, hvis du har sikret låget ved at klikke det fast på skålen. Når alle dele er samlet korrekt, deaktiveres den indbyggede sikkerhedslås.
- ▶ **Rengør altid låget og Click & Go-knappen efter brug, helst med det samme. I afsnittet 'Rengøring' kan du læse, hvordan du skiller Click & Go-systemet ad, når du skal rengøre det.**
- ▶ Bemærk, at det ikke er muligt at bruge foodprocessor-funktionerne, når blenderen er monteret på motorenheden!

- EN Nutmeg
- DE Muskat
- FR Muscade
- NL Nootmuskaat
- NO Muskat
- SV Muskot
- FI Muskottipähkinä
- DK Muskatnød

- EN Turmeric
- DE Kurkuma
- FR Curcuma
- NL Kurkuma
- NO Gurkemeie
- SV Gurkmeja
- FI Kurkuma
- DK Gurkemejerod

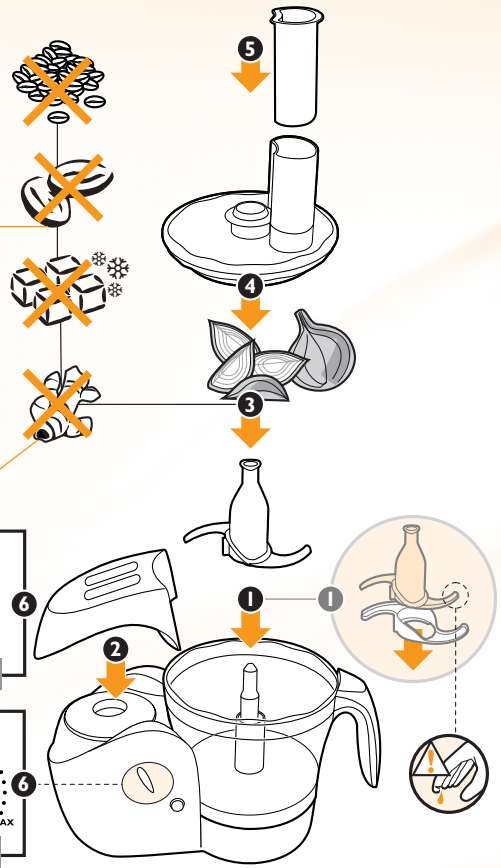
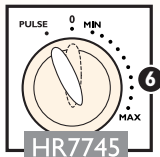
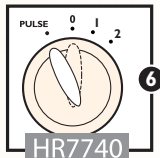

		
		≅ 100 g
		≅ 200 g
		≅ 500 g
		≅ 500 g
		≅ 500 g
		≅ 50 g
		150-300 g
		≅ 250 g
		≅ 500 g

- 
- 
- 
- 
- 
- 
- 
- 
- 
- 
- 
- 
- 
- 
- 



EN | Blade - tips and warnings

Always put the blade in the bowl before you start adding the ingredients.

- If you are chopping onions, use the pulse function a few times to prevent the onions from becoming too finely chopped.
- Do not let the appliance run too long when you are chopping (hard) cheese or chocolate. The ingredients will become too hot, will start to melt and will turn lumpy.
- The standard processing time for all chopping jobs is 30-60 seconds.

If food sticks to the blade or to the inside of the bowl:

- 1** Switch the appliance off.
- 2** Remove the lid from the bowl.
- 3** Remove the ingredients from the blade or from the wall of the bowl with a spatula.

DE | Messer: Tipps und Warnhinweise

Setzen Sie das Messer in die Schüssel, bevor Sie Zutaten hineingeben.

- Betätigen Sie beim Hacken von Zwiebeln mehrmals die Puls-Taste, um zu verhindern, dass die Zwiebeln zu fein gehackt werden.
- Lassen Sie das Gerät beim Raspeln von (Hart-)Käse oder Schokolade nicht zu lange laufen. Die Zutaten werden sonst zu warm, schmelzen und werden klumpig.
- Die normale Verarbeitungszeit zum Zerkleinern beträgt 30 bis 60 Sekunden.

Wenn Lebensmittel am Messer oder an der Innenseite der Schüssel haften:

- 1** Schalten Sie das Gerät aus.
- 2** Nehmen Sie den Deckel von der Schüssel.
- 3** Entfernen Sie die Zutaten vom Messer bzw. von der Schüsselwand mit einem Teigschaber.

FR | Couteau - suggestions et avertissements

Insérez toujours le couteau dans le bol avant d'ajouter les ingrédients.

- Si vous hachez des oignons, utilisez la touche éclair pour éviter de hacher les oignons trop fin.
- Ne laissez pas tourner l'appareil trop longtemps lorsque vous hachez du fromage (à pâte dure) ou du chocolat: les ingrédients chaufferaient trop, commenceraient à fondre et à devenir pâteux.
- La durée standard pour tout hachage est de 30-60 secondes.

Si les aliments collent à la paroi du bol:

- 1** Arrêtez l'appareil.
- 2** Retirez le couvercle du bol.
- 3** Enlevez ensuite les aliments collés au couteau ou à la paroi du bol avec la spatule.

NL | Mes - tips en waarschuwingen

Plaats het mes in de kom voordat u de ingrediënten erin doet.

- Als u uien hakt, gebruik dan een paar keer de pulsstand om te voorkomen dat de uien te fijn worden gehakt.
- Laat het apparaat niet te lang werken wanneer u (harde) kaas of chocolade aan het hakken bent. De kaas of chocolade wordt anders te heet, gaat smelten en wordt klontig.
- De standaardverwerkingstijd voor alle hakbewerkingen is 30 tot 60 seconden.

Als voedsel aan het mes of de binnenkant van de kom blijft kleven:

- 1** Schakel het apparaat uit.
- 2** Neem het deksel van de kom.
- 3** Verwijder de ingrediënten met een spatel van het mes en van de wand van de kom.



NO | Kniv - tips og advarsler

Sett alltid kniven i bollen før du har i ingrediensene.

- Hvis du hakker opp løk, bruker du pulseringsfunksjonen et par ganger; slik at løken ikke blir for finhakket.
- Ikke la apparatet gå for lenge når du hakker (hard) ost eller sjokolade. Ingrediensene vil bli for varme, vil begynne å smelte og vil bli klumpete.
- Standard bearbeidingstid for all opphakking er 30-60 sekunder.

Hvis maten fester seg på kniven eller innsiden av bollen:

- 1** Slå apparatet av.
- 2** Ta lokket av bollen.
- 3** Fjern ingrediensene fra kniven eller innsiden av bollen med en slikkepott.

SV | Kniv - tips och varningar

Sätt alltid kniven i skålen innan du börjar tillsätta ingredienserna.

- Om du hackar lök ska du använda pulsfunksjonen några gånger för att förhindra att löken blir för fint hackad.
- Låt inte apparaten köra för länge när du hackar (hård) ost eller choklad. Ingredienserna blir för varma, börjar smälta och blir ojämnta.
- Den normala beredningstiden för alla hackningsjobb är 30-60 sekunder.

Om mat fastnar på kniven eller på insidan av skålen:

- 1** Stäng av apparaten.
- 2** Ta av locket från beredningsskålen.
- 3** Avlägsna ingredienserna från kniven eller skålväggen med hjälp av en degskrapa.

FI | Terä - vihjeitä ja varoituksia

Aseta aina terä kulhoon ennen raaka-aineiden lisäämistä.

- Jos hienonnut sipuleita, käytä PULSE-toimintoa muutamia kertoja, jotta sipuli ei pilkkoutuisi liian hienoksi.
- Älä hienonna kovia juustoja tai suklaata liian pitkään. Aineet lämpiävät ja alkavat paakkuuntua.
- Normaaali käsittelyaika kaikessa hienonnuksessa on 30-60 sekuntia.

Jos ruoka tarttuu terään tai kulhon sisäpintaan, toimi seuraavasti:

- 1** Katkaise laitteen toiminta.
- 2** Poista kansi kulhon päältä.
- 3** Irrota aineet terästä tai kulhon reunoista kaapimella.

DK | Knivenhed - tips og advarsler

Sæt altid knivenheden ned i skålen, før du kommer ingredienserne i.

- Hvis du skal hakke løg, skal du bruge pulse-funktionen et par gange for at undgå, at løgene bliver hakket for fint.
- Undgå at hakke (hård) ost eller chokolade i for lang tid ad gangen, da ingredienserne kan blive for varme og begynde at klumpe.
- Standardtilberedningstiden for al hakning er 30-60 sekunder.

Hvis ingredienserne sidder fast på knivenheden eller skålens inderside:

- 1** Sluk for apparatet.
- 2** Tag låget af skålen.
- 3** Fjern ingredienserne fra knivenheden eller indersiden af skålen med en spatel.



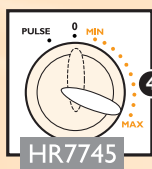
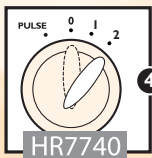
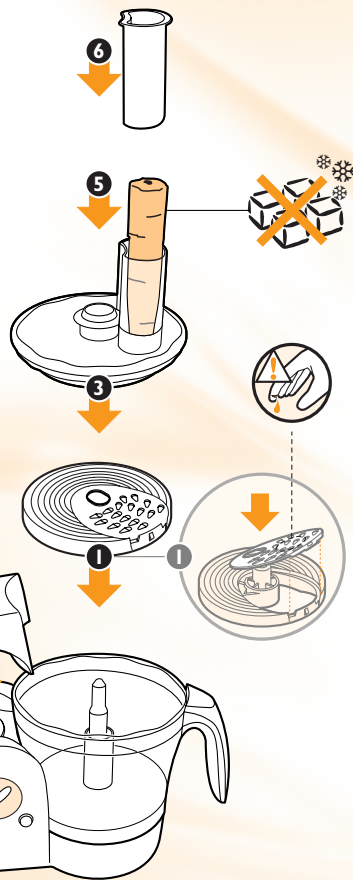

	≤ 500 g	≤ 200 g	≤ 2x	≤ 500 g	≤ 300 g

EN | Inserts - tips and warnings

Do not exert too much pressure on the pusher when pressing ingredients down the feed tube.

- Pre-cut large ingredients to make them fit into the feed tube.
- Fill the feed tube evenly for the best results.
- When shredding or granulating soft ingredients, use a low speed to prevent the ingredients from turning into a puree.
- When you have to process a large amount of ingredients, process small batches and empty the bowl between batches.
- Do not let the appliance run too long when you are shredding (hard) cheese. The cheese will become too hot, will start to melt and will turn lumpy. Do not use the insert to use shred chocolate. Only use the blade (page 15) for this purpose.

DE | Einsätze: Tipps und Warnhinweise

Üben Sie nicht zu viel Druck auf den Stopfer aus, wenn Sie Zutaten in den Einfüllstutzen drücken.

- Schneiden Sie größere Stücke vor, damit Sie in den Einfüllstutzen passen.
- Die besten Ergebnisse erhalten Sie, wenn Sie den Einfüllstutzen gleichmäßig füllen.
- Wählen Sie zum Zerkleinern weicher Zutaten eine niedrige Geschwindigkeit, damit sie nicht zu Brei werden.
- Verarbeiten Sie größere Mengen nicht auf einmal, sondern in mehreren kleinen Portionen nacheinander. Leeren Sie zwischendurch die Schüssel.
- Lassen Sie das Gerät beim Reiben von (Hart-)Käse nicht zu lange laufen. Der Käse wird sonst zu warm, schmilzt und wird klumpig. Verwenden Sie den Einsatz nicht zum Raspeln von Schokolade, sondern benutzen Sie zu diesem Zweck das Messer (Seite 15).

FR | Inserts - suggestions et avertissements

Appuyez légèrement sur les ingrédients avec le poussoir.

- Coupez les gros morceaux pour pouvoir les introduire dans la cheminée.
- Pour de meilleurs résultats remplissez la cheminée de façon régulière.
- Lorsque vous râpez ou grainez des ingrédients mous, utilisez une vitesse basse afin de ne pas réduire les ingrédients en purée.
- Si vous devez traiter d'importantes quantités d'aliments, ne traitez que des petites portions à la fois et videz le bol fréquemment.
- Ne laissez pas tourner l'appareil trop longtemps lorsque vous hachez du fromage (à pâte dure) : le fromage chaufferait trop, commencerait à fondre et à devenir pâteux. N'utilisez pas l'insert pour hacher du chocolat. Pour cela, utilisez le couteau (page 15).

NL | Inzetschijven - tips en waarschuwingen

Oefen niet te veel druk uit op de stamper wanneer u de ingrediënten door de vultrechter naar beneden duwt.

- Snijd grote stukken voedsel in kleinere stukjes die in de vultrechter passen.
- Plaats de ingrediënten gelijkmatig in de vultrechter voor het beste resultaat.
- Kies een lage snelheid wanneer u zachte ingrediënten raspt of granuleert om te voorkomen dat ze tot moes worden vormalen.
- Wanneer u een grote hoeveelheid voedsel wilt verwerken, verwerk dan kleine porties en maak de kom tussentijds regelmatig leeg.
- Laat het apparaat niet te lang werken wanneer u (harde) kaas aan het raspen bent. De kaas wordt anders te heet, gaat smelten en wordt klonterig. Gebruik de inzetschijven niet om chocolade te verwerken; gebruik hiervoor het mes (pagina 15).





NO | Tilbehør - tips og advarsler

Ikke legg for mye trykk på stapperen når du presser ingrediensene ned i materøret.

- Store ingredienser deler du opp på forhånd, slik at de passer i materøret.
- Fyll materøret jevnt for beste resultat.
- Når du rasper eller maler myke ingredienser, bør du bruke lav hastighet, slik at ingrediensene ikke blir most.
- Når du skal bearbeide store mengder ingredienser, deler du det opp i flere deler og tømmer bollen mellom hver gang.
- Ikke la apparatet gå for lenge når du rasper (hard) ost. Denne osten vil bli for varm, vil begynne å smelte og vil bli klumpete. Ikke bruk skivene for å raspe sjokolade, bruk kniven (side 15) til dette.

SV | Skivor - tips och varningar

Tryck inte för mycket på påmataren när du trycker ner ingredienser i mataröppningen.

- Skär stora ingredienser i förväg för att få dem att passa i mataröppningen.
- Fyll mataröppningen jämnt för bästa möjliga resultat.
- När du strimlar eller finfördelar mjuka ingredienser ska du använda en låg hastighet för att förhindra att ingredienserna blir puré.
- När du ska köra en stor mängd ingredienser ska du bereda små omgångar och tömma skålen mellan omgångarna.
- Låt inte apparaten köra för länge när du strimlar (hård) ost. Osten blir för varm, börjar smälta och blir ojämn. Använd inte skivan för att strimla choklad, använd kniven (sidan 15) för detta.

FI | Lisäosat - vihjeitä ja varoituksia

Älä käytä liikaa voimaa painaessasi raaka-aineita työntimen avulla syöttösuppiloon.

- Pilko suurina paloina olevat raaka-aineet siten, että ne mahtuvat syöttösuppiloon.
- Täytä syöttösuppilo mahdollisimman tasaisesti.
- Käytä pehmeitä raaka-aineita suikaloitaessa tai rakeistettaessa hidasta nopeutta, jotta raaka-aineet eivät soseudu.
- Kun käsiteltävänä on suuria raaka-ainemääriä, käsittele raaka-aineet pienissä erissä ja tyhjennä kulho erien välillä.
- Älä suikaloi kovia juustoja liian pitkään. Juusto lämpiää ja alkaa paakkuuntua. Älä käytä lisäosaa suklaan suikalointiin, käytä siihen tarkoitukseen terää (sivu 15).

DK | Skiver - tips og advarsler

Tryk ikke nedstopperen for hårdt ned, når ingredienserne presses ned i påfyldningstragten.

- Skær store ingredienser i passende stykker, inden du kommer dem ned i påfyldningstragten.
- Det bedste resultat opnås, når ingredienserne fordeles jævnt i påfyldningstragten.
- Når du river eller findeler bløde ingredienser, skal du bruge en lav hastighed for at undgå, at ingredienserne bliver til puré.
- Når du skal tilberede en stor mængde ingredienser, skal du gøre det af flere omgange og tømme skålen mellem hver portion.
- Lad ikke apparatet køre for længe, når du river (hård) ost. Osten kan blive for varm og begynde at smelte og klumpe. Brug ikke indsatsen til at rive chokolade - brug knivenheden (side 15) til dette formål.





EN | Balloon beater - tips and warnings

- You can use the balloon beater to whip cream and to whisk eggs, egg whites, instant pudding, mayonnaise and sponge cake mixtures.
 - Do not use the balloon beater to prepare cake mixtures with butter or margarine or to knead dough. Use the kneading accessory for these jobs (see page 32).
 - Make sure the bowl and the balloon beater are dry and free from grease when you whisk egg whites. The egg whites should be at room temperature.
- ▶ **Always clean the balloon beater after use. See section 'Cleaning' (page 38) for instructions on how to take the balloon beater apart in order to clean it.**

DE | Quirl: Tipps und Warnhinweise

- Der Quirl eignet sich zum Schlagen von Sahne und Eiern, für Eischnee, Desserts, Mayonnaise und Biskuitteig.
 - Verwenden Sie den Quirl nicht zur Zubereitung von Kuchenteig mit Butter/Margarine oder zum Kneten von schwerem Teig. Hierfür ist das Knetzubehör vorgesehen (s. Seite 32).
 - Achten Sie darauf, dass Schüssel und Quirl trocken und vollkommen fettfrei sind, wenn Sie Eischnee schlagen. Das Eiweiß sollte Zimmertemperatur haben.
- ▶ **Reinigen Sie den Quirl nach jedem Gebrauch. Im Abschnitt "Reinigung" (Seite 38) finden Sie Anleitungen zum Auseinandernehmen und Reinigen des Quirls.**

FR | Fouet - suggestions et avertissements

- Vous pouvez utiliser le fouet pour battre des oeufs ou faire de la crème fouettée, pour fouetter des blancs d'oeufs, des puddings, faire de la mayonnaise et pâtes à crêpes.
- N'utilisez pas le fouet pour les préparations pour gâteaux avec du beurre ou de la margarine ou pour pétrir de la pâte. Pour ces opérations utilisez l'accessoire de pétrissage. (voir page 32)
- Assurez-vous que le bol et le fouet sont propres et secs lorsque

vous fouettez des blancs d'oeufs. Les oeufs doivent être à température ambiante.

- ▶ **Nettoyez toujours le fouet après utilisation. Voir chapitre "Nettoyage" (page 38) pour les instructions sur la façon de retirer le fouet.**

NL | Mengaccessoire - tips en waarschuwingen

- U kunt het mengaccessoire gebruiken om eieren, eiwitten, instantpudding, mayonaise en biscuitdeeg te kloppen.
 - Gebruik het mengaccessoire niet om cakebeslag of deeg te kneden. Gebruik daarvoor het kneedaccessoire (zie pagina 32).
 - Zorg ervoor dat de kom en het mengaccessoire droog zijn en vrij van vet wanneer u eiwitten klopt. De eiwitten dienen op kamertemperatuur te zijn.
- ▶ **Maak het mengaccessoire altijd na gebruik schoon. Zie hoofdstuk 'Schoonmaken' (pagina 38) voor instructies over hoe het mengaccessoire uit elkaar moet worden genomen om het schoon te maken.**

NO | Ballongvisp - tips og advarsler

- Du kan bruke ballongvispen til å piske krem og vispe egg, eggehviter, posepudding, majones og kakeblandinger.
 - Ikke bruk ballongvispen til å lage kakeblandinger med smør eller margarin eller til å kna deig. Bruk elteutstyret til dette (se side 32).
 - Pass på at bollen og ballongvispen er tørre og fettfrie når du pisker eggehviter. Eggehviten skal ha romtemperatur.
- ▶ **Rengjør alltid ballongvispen etter bruk. Se "Rengjøring" (side 38) for instruksjoner om hvordan du demonterer ballongvispen for rengjøring.**

SV | Ballongvisp - tips och varningar

- Du kan använda ballongvispen för att vispa grädde och ägg, äggvitor, snabbgröt, majonnäs och sockerkaksblandningar.



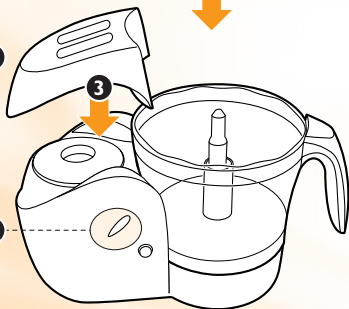
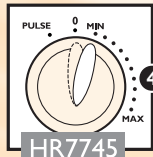
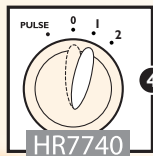
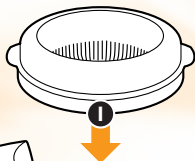
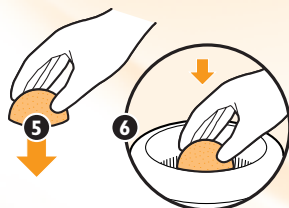

EN | Citrus press - tips and warnings

- ▶ **Built-in safety lock:** you can only use the citrus press when the blender cap has been correctly assembled onto the motor unit and the cone has been correctly assembled in the sieve (see picture on page 11).

If all parts have been assembled correctly, the cone will start rotating as soon as the appliance is switched on and the fruit is pressed onto the cone. It will stop rotating as soon as the citrus fruit is removed.

- First set the control knob to a low speed and then press the citrus fruit onto the cone.
- Stop pressing from time to time to remove the pulp from the sieve.
- When you have finished pressing or when you want to remove the pulp, switch the appliance off and remove the bowl with the sieve and cone on it from the appliance.

DE | Zitruspresse: Tipps und Warnhinweise

- ▶ **Integrierte Sicherheitssperre:** Sie können die Zitruspresse nur benutzen, wenn der Verschluss des Mixers richtig auf der Motoreinheit angebracht ist und der Kegel ordnungsgemäß im Sieb sitzt (s. Abb. auf Seite 11).

Vorausgesetzt alle Teile sind richtig montiert, dreht sich der Kegel, sobald Sie das Gerät einschalten und die Zitrusfrucht auf den Kegel drücken. Der Kegel kommt zum Stillstand, sobald Sie das Obst abnehmen.

- Stellen Sie erst eine niedrige Geschwindigkeit ein, und drücken Sie dann die Zitrusfrucht auf den Kegel.
- Unterbrechen Sie das Auspressen von Zeit zu Zeit, um das Fruchtfleisch vom Sieb zu entfernen.
- Wenn Sie mit dem Saftpressen fertig sind oder das Fruchtfleisch entfernen möchten, schalten Sie das Gerät aus und nehmen Sie die Schüssel mit Sieb und Kegel vom Gerät.

FR | Presse-agrumes - suggestions et avertissements

- ▶ **Verrouillage de sécurité incorporé:** vous pouvez utiliser le presse-agrumes seulement après avoir monté correctement le capuchon du mixeur et que le cône ait été placé correctement dans le tambour.

Si tous les composants sont montés correctement, le cône tourne lorsque l'appareil est mis en marche et le fruit est pressé sur le cône. Le tambour s'arrête lorsque le fruit est enlevé.

- Réglez le bouton sur une vitesse inférieure et ensuite pressez la moitié d'un fruit sur le cône.
- De temps en temps, arrêtez-vous de presser les fruits pour enlever la pulpe du tamis.
- Après avoir fini ou lorsque vous enlevez la pulpe, arrêtez l'appareil et retirez le bol avec le tambour et le cône attachés.

NL | Citruspers - tips en waarschuwingen

- ▶ **Ingebouwde veiligheidsvergrendeling:** de citruspers werkt alleen als de blenderkap goed op de motorunit gemonteerd is en de perskegel goed in de zeef gemonteerd is (zie plaatje op pagina 11).

Als alle onderdelen goed gemonteerd zijn, zal de perskegel beginnen te draaien zodra het apparaat ingeschakeld is en er een halve citrusvrucht op de perskegel geduwd wordt. De perskegel stopt met draaien zodra de vrucht van de perskegel verwijderd is.

- Stel de bedieningsknop eerst in op een lage snelheid en duw de citrusvrucht op de perskegel.
- Stop af en toe met persen om pulp uit de zeef te verwijderen.
- Schakel het apparaat uit en neem de kom met de zeef en perskegel van het apparaat af wanneer u klaar bent met persen of wanneer u vruchtvlies wilt verwijderen.

NO | Sitruspresse - tips og advarsler

- ▶ **Innebygd sikkerhetslås:** Du kan bare bruke sitruspressen når hurtigmikseren er korrekt koblet på motorenheten, og pressen er korrekt plassert på silen (se bilde side 11).

Hvis alle delene er korrekt plassert, vil pressen begynne å rotere når apparatet slås på og sitrusfrukten blir trykket på pressen. Den vil stoppe å rotere så fort frukten fjernes.

- Start med å sette kontrollknappen på lav hastighet, og trykk så sitrusfrukten på pressen.
- Stopp pressingen med jevne mellomrom for å fjerne fruktkjøttet fra silen.
- Når du er ferdig med pressingen eller når du ønsker å fjerne fruktkjøtt, slå av apparatet og fjern bollen med silen og pressen fra apparatet.

SV | Citruspress - tips och varningar

- ▶ **Inbyggt säkerhetslock:** du kan bara använda citruspressen när mixerlocket har satts på korrekt på motorenheten och konen har satts i på rätt sätt i sållet (se bilden på sidan 11).

Om alla delar har satts ihop korrekt börjar konen rotera så snart som apparaten slås på och frukten pressas mot konen. Den slutar rotera så snart som citrusfrukten tas bort.

- Ställ först in kontrollvredet på låg hastighet och pressa sedan citrusfrukten mot konen.
- Sluta pressa med jämna mellanrum för att ta bort fruktköttet från sållet.
- När du är klar med pressandet eller när du vill ta bort fruktköttet ska du stänga av apparaten och ta bort skålen med sållet och konen från apparaten.





FI | Sitruspuristin - vihjeitä ja varoituksia



- ▶ **Sisäänrakennettu turvalukko:** voit käynnistää sitruspuristimen vain, kun tehosekoittimen kansi on paikallaan rungon päällä ja kartio on asetettu siivilään asianmukaisesti (katso kuvaa sivulla XX).

Jos kaikki osat on koottu oikein, kartio alkaa pyöriä, kun laite käynnistetään ja hedelmää painetaan kartiota vasten. Kartio pysähtyy, kun hedelmä poistetaan.

- Aseta ensin säätönappi hiljaiselle nopeudelle ja paina sitten sitrushedelmää kartiota vasten.
- Keskeytä painaminen välillä ja poista hedelmäjäte siivilästä.
- Kun lopetat mehun puristamisen tai haluat poistaa hedelmäjätteen, katkaise laitteesta virta ja irrota kulho laitteesta siten, että siivilä ja kartio ovat paikallaan sen päällä.



DK | Citruspresser - tips og advarsler



- ▶ **Indbygget sikkerhedslås:** Citruspresseren kan kun anvendes, når blenderdækslet er korrekt monteret på motorenheden og pressekegle og si er korrekt sat sammen (se tegningen på side 11).

Hvis alle dele er korrekt samlet, begynder pressekeglen at rotere, når apparatet tændes og frugten presses mod keglen. Så snart citrusfrugten fjernes, standser rotationen.

- Sæt først kontrolknappen på lav hastighed og pres derefter citrusfrugten mod keglen.
- Stop presningen med jævne mellemrum for at fjerne frugtkødet fra sien.
- Når du er færdig med af presse frugt eller ønsker at fjerne mere frugtkød, skal du slukke for apparatet og løfte skålen med si og pressekegle af apparatet.



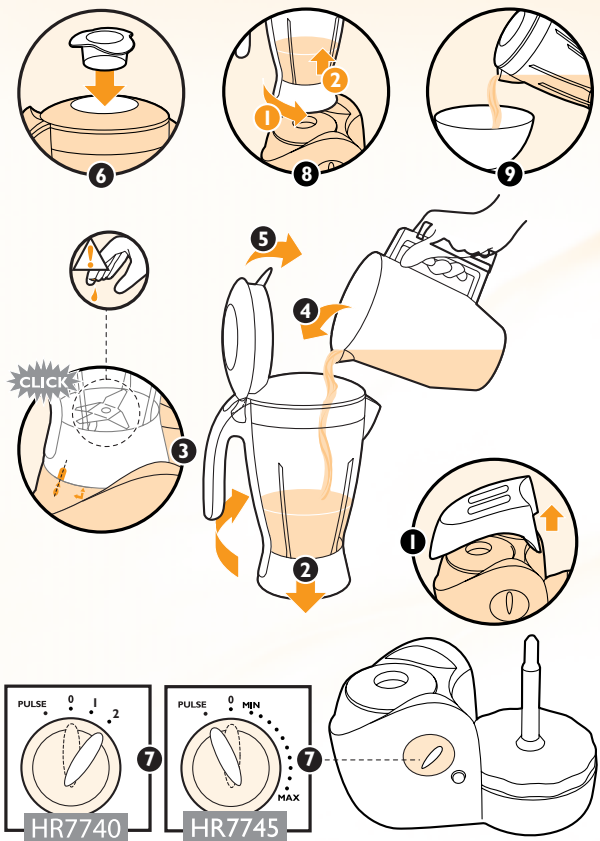

		≤ 750 ml
		≤ 500 ml
		≤ 500 ml
		≤ 500 ml
		≤ 250 g
		≤ 12





EN | Blender - tips and warnings

Do not let the appliance run more than twice without interruption. Let it cool down before you continue processing.

Do not exert too much pressure on the handle of the blender jar when assembling or disassembling it.

Never open the lid when the appliance is still running!

- ▶ **Built-in safety lock:** you can only use the blender when the rib on the blender jar is directly opposite the print on the motor unit.
 - To add liquid ingredients during processing, pour them into the blender jar through the hole in the lid.
 - Pre-cut solid ingredients into smaller pieces before processing them.
 - If you want to prepare a large quantity, process small batches of ingredients instead of a large quantity at once.
 - Soak hard ingredients, e.g. soy beans, in water before processing them.
 - Use cooked ingredients when blending a soup.
 - When processing a liquid that is hot or tends to foam (e.g. milk), do not put more than 1 litre in the blender jar to avoid spillage.
 - If you are not satisfied with the result, switch the appliance off and stir the ingredients with a spatula, remove some of the contents to process a smaller quantity or add some liquid.

If ingredients stick to the wall of the blender jar:

- 1** Switch the appliance off and unplug it.
- 2** Open the lid and use a spatula to remove the ingredients from the wall of the jar.
- 3** Keep the spatula at a safe distance of approx. 2 cm from the blade.

- ▶ *Note that it is not possible to use the food-processing functions when the blender is attached to the motor unit!*

DE | Mixer: Tipps und Warnhinweise

Lassen Sie das Gerät höchstens zweimal ohne Unterbrechung laufen. Lassen Sie es abkühlen, bevor Sie es wieder einschalten.

Üben Sie beim Aufsetzen und Abnehmen des Mixbechers nicht zu viel Druck auf den Handgriff aus.

Öffnen Sie bei laufendem Gerät niemals den Deckel!

- ▶ **Integrierte Sicherheitssperre:** Der Mixer arbeitet nur, wenn die Rippe am Mixbecher genau gegenüber der Schrift auf der Motoreinheit steht.
 - Gießen Sie bei laufendem Gerät flüssige Zutaten durch die Öffnung im Deckel in den Mixbecher.
 - Schneiden Sie feste Zutaten vor der Verarbeitung in kleinere Stücke.
 - Verarbeiten Sie größere Mengen nicht auf einmal, sondern in mehreren kleinen Portionen nacheinander.
 - Weichen Sie harte Zutaten, z. B. Sojabohnen, vor der Verarbeitung in Wasser ein.
 - Verwenden Sie zum Mixen von Suppen gekochte Zutaten.
 - Wenn Sie heiße oder leicht schäumende Flüssigkeiten (z. B. Milch) mixen, sollten Sie höchstens 1 Liter in den Mixbecher füllen, damit der Inhalt nicht überläuft.
 - Sind Sie mit dem Ergebnis unzufrieden, schalten Sie das Gerät aus und rühren Sie die Zutaten um; entnehmen Sie einen Teil des Inhalts, um eine kleinere Menge zu verarbeiten, oder fügen Sie etwas Flüssigkeit hinzu.

Wenn Zutaten an der Wand des Mixbechers haften:

- 1** Schalten Sie das Gerät aus und ziehen Sie den Netzstecker aus der Steckdose.
- 2** Öffnen Sie den Deckel und entfernen Sie die Zutaten mit einem Spatel von der Wand des Mixbechers.
- 3** Halten Sie den Spatel in einem sicheren Abstand von ca. 2 cm vom Messer.



- *Hinweis: Die Schüssel arbeitet nicht, solange der Mixer auf der Motoreinheit angebracht ist!*

FR | Blender - suggestions et avertissements

Ne laissez pas l'appareil fonctionner deux fois de suite sans interruption. Laissez-le refroidir avant de continuer.

N'exercez trop de pression sur la poignée du bol mixeur lorsque vous le montez ou démontez.

N'ouvrez jamais le couvercle pendant le fonctionnement de l'appareil!

- **Verrouillage de sécurité incorporé: vous pouvez utiliser le mixeur uniquement lorsque la nervure sur le bol mixeur coïncide avec le repère sur le bloc moteur.**
 - Versez les ingrédients liquides dans le bol mixeur par l'ouverture du couvercle.
 - Coupez les aliments en morceaux pour les introduire dans le bol mixer.
 - Si vous devez traiter d'importantes quantités d'aliments, ne traitez que des petites portions à la fois.
 - Faites tremper les ingrédients durs tels que les germes de soja avant de les préparer:
 - Utilisez des ingrédients cuits pour préparer une soupe.
 - Si vous préparez un liquide chaud ou qui peut mousser (par ex. du lait), n'ajoutez pas plus d'un litre dans le bol mixeur pour éviter tout débordement.
 - Si vous n'êtes pas satisfait des résultats, arrêtez l'appareil, mélangez les ingrédients avec une spatule, versez un peu du contenu dans un autre bol afin de préparer une quantité plus faible ou ajouter un peu de liquide.

Si des aliments collent à la paroi du bol mixeur:

1 Arrêtez l'appareil et débranchez-le.

2 Ouvrez le couvercle et enlevez les aliments de la paroi du bol mixeur avec une spatule.

3 Faites attention à tenir la spatule à une distance sûre d'environ 2 cm des couteaux.

- *Notez que si le mixeur est monté, vous ne pouvez pas utiliser les fonctions du bol.*

NL | Blender - tips en waarschuwingen

Laat het apparaat niet vaker dan twee keer zonder onderbreking werken. Laat het afkoelen voordat u verder gaat.

Oefen niet te veel druk uit op het handvat van de blenderkan wanneer u hem bevestigt of verwijdert.

Open het deksel nooit terwijl het apparaat nog draait!

- **Ingebouwde veiligheidsvergrendeling: u kunt de blender alleen gebruiken wanneer de ribbel op de blenderkan tegenover de opdruk op de motorunit zit.**
 - Als u tijdens de de bewerking vloeibare ingrediënten wilt toevoegen, giet deze dan in de kan via de opening in het deksel.
 - Snijdt vaste ingrediënten in kleinere stukjes voordat u ze in de blenderkan doet om ze te verwerken.
 - Wanneer u een grote hoeveelheid voedsel wilt bereiden, doe dan niet alle ingrediënten in één keer in de kom, maar verwerk steeds kleine hoeveelheden.
 - Laat harde ingrediënten zoals sojabonen in water weken voordat u ze verwerkt.
 - Gebruik gekookte ingrediënten wanneer u een soep wilt bereiden in de blender.
 - Als u een vloeistof verwerkt die heet is of nogal snel gaat schuimen, doe dan niet meer dan 1 liter in de blenderkan om morsen te voorkomen.
 - Als u niet tevreden bent met het resultaat, schakel het apparaat dan uit en roer de ingrediënten met een spatel of giet een deel van de ingrediënten uit de kan en verwerk een kleinere hoeveelheid of voeg wat vloeistof toe.

Als de ingrediënten aan de wand van de blenderkan blijven kleven:





1 Schakel het apparaat uit en haal de stekker uit het stopcontact.



2 Open het deksel en gebruik een spatel om de ingrediënten van de wand van de kan te verwijderen.



3 Houd de spatel op een veilige afstand van ongeveer 2 cm van de snijkanten van het blendermes.



▶ *Let op: Het is niet mogelijk de keukenmachinefuncties te gebruiken als de blender op de motorunit gemonteerd is.*



NO | Hurtigmikser - tips og advarsler

Ikke la apparatet kjøre mer enn to ganger uten avbrudd. La det kjøles ned før du fortsetter å bruke det.



Ikke legg for mye trykk på håndtaket på hurtigmikserkannen når du monterer eller demonterer det.



Åpne aldri lokket når apparatet er i gang.



▶ **Innebygd sikkerhetslås:** Du kan bare bruke hurtigmikseren når riflen på hurtigmikserkannen er plassert rett mot merket på motorenheten.



- Hvis du vil legge til flytende ingredienser i løpet av bearbeidingen, heller du dem ned i hurtigmikseren gjennom hullet i lokket.



- Del store ingredienser i mindre deler før du bearbeider dem.



- Når du skal bearbeide store mengder ingredienser, deler du det opp i flere deler og bearbeider litt om gangen.



- Legg harde ingredienser, som for eksempel soyabønner, i bløt i vann før du bearbeider dem.



- Bruk kokte ingredienser når du lager en suppe i hurtigmikseren.



- Når du bearbeider en flytende ingrediens som er varm, eller som det lett dannes skum på, ikke bruk mer en 1 liter i hurtigmikserkannen. På den måten unngår du at noe går til spille.



- Hvis du ikke er fornøyd med resultatet, slå av apparatet og rør i ingrediensene med en slikkepott, fjern litt av innholdet slik at det blir mindre å bearbeide, eller legg til noe flytende.



- Hvis du ikke er fornøyd med resultatet, slå av apparatet og rør i ingrediensene med en slikkepott, fjern litt av innholdet slik at det blir mindre å bearbeide, eller legg til noe flytende.



Dersom ingrediensene sitter fast i kannen:



1 Slå apparatet av og trekk støpselet ut av stikkkontakten.



2 Åpne lokket, og bruk en slikkepott til å fjerne ingrediensene på innsiden av kannen.

3 Hold slikkepotten i sikker avstand fra kniven (ca. 2 cm).

▶ *Legg merke til at det ikke er mulig å bruke foodprocessorfunksjonene når hurtigmikseren er koblet til motorenheten*

SV | Mixer - tips och varningar

Låt inte apparaten köra mer än två gånger utan avbrott. Låt den svalna innan du fortsätter beredningen.

Tryck inte för mycket på handtaget till mixerkannen när du sätter ihop eller tar isär den.

Öppna aldrig locket när apparaten fortfarande kör!

- ▶ **Inbyggt säkerhetslås:** du kan bara använda mixern när kanten på mixerkannen är direkt mottrycket på motorenheten.
- Du tillsätter flytande ingredienser under beredning genom att hålla dem i mixerkannen genom hålet i locket.
- Skär fasta ingredienser i mindre bitar innan du bereder dem.
- Om du vill bereda en stor mängd ska du köra små omgångar med ingredienser istället för en stor mängd på en gång.
- Blötlägg hårda ingredienser, t.ex. soyabönor, i vatten innan du bereder dem.
- Använd kokta ingredienser när du mixar en soppa.
- När du bereder en vätska som är varm eller tenderar att skumma (t.ex. mjölk) ska du inte hålla mer än 1 liter i mixerkannen för att undvika spill.
- Om du inte är nöjd med resultatet, stäng av apparaten och rör ingredienserna med en degskrapa, avlägsna lite av innehållet för att bereda en mindre mängd eller för att tillsätta lite vätska.

Gör så här om ingredienserna fastnar på mixerns insida:

1 Stäng av matberedaren och ta ut stickkontakten ur vägguttaget.

2 Öppna locket och använd en degskrapa för att ta bort ingredienserna från kannans vägg.

3 Håll degskrapan på ett säkert avstånd på cirka 2 cm från kniven.

- ▶ *Tänk på att det inte går att använda matberedningsfunktionerna när mixern är fästsatt på motorenheten!*

FI | Tehosekoitin - vihjeitä ja varoituksia

Älä käytä laitetta yli kahta kertaa peräkkäin keskeytyksettä. Anna laitteen jäähtyä, ennen kuin jatkat sen käyttöä.

Älä kohdista tehosekoittimen kannun kahvaan liikaa voimaa kootessasi tai purkaessasi tehosekoitinta.

Älä avaa kantta laitteen ollessa toiminnassa.

- ▶ **Sisäänrakennettu turvalukko: voit käynnistää tehosekoittimen vain, kun tehosekoittimen kannussa oleva harjanne on tarkalleen vastakkaisella puolella kuin rungossa oleva merkki.**
- Voit lisätä nestemäisiä aineita käsittelyn aikana kaatamalla ne tehosekoittimen kannuun kannessa olevasta reiästä.
- Leikkaa kiinteät aineet pieniksi paloiksi ennen tehosekoittimeen laittamista.
- Käsittele suuret ainemäärät pienissä erissä.
- Liota soijapavut ja muut kovat raaka-aineet vedessä ennen käsittelyä.
- Käytä keitettyjä raaka-aineita valmistaessasi sosekeittoa.
- Kun käsittelet kuumaa tai vaahtoavaa nestettä, esimerkiksi maitoa, laita tehosekoittimen kannuun enintään 1 litra nestettä, jotta vaahdo ei kuohu kannun reunan yli.
- Jos et ole tyytyväinen tulokseen, sammuta laite ja sekoita aineita lastalla, poista osa sisällöstä ja käsittele aineet pienemmissä erissä tai lisää nestettä.

Jos aineet tarttuvat tehosekoittimen kannun seinään:

1 Katkaise laitteen toiminta ja vedä pistotulppa irti pistorasiasta.

2 Avaa kansi ja irrota aineet kannun seinästä lastalla.

3 Älä vie lastaa 2:ta senttimetriä lähemmäksi terää.

- ▶ *Ota huomioon, että monitoimikoneen toimintoja ei voi käyttää, kun tehosekoitin on kiinnitetty runkoon.*

DK | Blender - tips og advarsler

Lad ikke apparatet køre mere end to gange uden afbrydelser. Lad apparatet køle af, før du fortsætter.

Tag ikke for hårdt fat i håndtaget, når blenderglasset påsættes og aftages.

Åbn aldrig låget, mens apparatet kører!

- ▶ **Indbygget sikkerhedslås: Du kan kun bruge blenderen, når ribben på blenderglasset sidder lige ud for mærkerne på motorenheden.**
- Hvis du vil tilsætte flydende ingredienser, mens du blender, skal du hælde dem ned gennem hullet i blenderglassets låg.
- Skær store ingredienser i passende stykker, før du blender dem.
- Hvis du skal blende en stor mængde ingredienser, skal du gøre det af flere omgange i stedet for at lave det hele på én gang.
- Opblød hårde ingredienser, f.eks. sojabønner, i vand, inden de blendes.
- Brug kogte ingredienser, når du skal blende en suppe.
- Når du blender en væske, som er varm eller har tendens til at skumme (f.eks. mælk), må du ikke hælde mere end 1 liter i blenderglasset for at undgå spild.
- Hvis du ikke er tilfreds med resultatet, skal du slukke for apparatet og røre i ingredienserne med en spatel. Fjern en del af indholdet, så der bliver en mindre mængde at blende, eller tilsæt lidt væske.

Hvis ingredienserne sætter sig fast på indersiden af blenderglasset, skal du gøre følgende:

1 Sluk for apparatet, og tag stikket ud af stikkontakten.

2 Åbn låget, og fjern ingredienserne fra blenderglassets inderside med en spatel.

3 Hold spatlen på en sikker afstand af ca. 2 cm fra knivenheden.

- ▶ *Bemærk, at det ikke er muligt at bruge foodprocessor-funktionerne, når blenderen er monteret på motorenheden!*

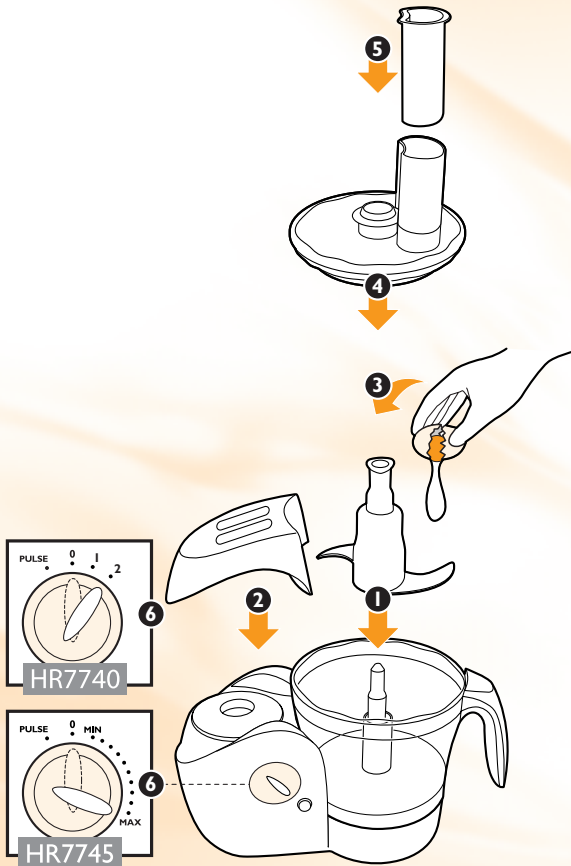

	
	 ≤ 500 g
	 ≤ 750 g
	 ≤ 300 g
	 ≤ 4 

EN | Kneading accessory - tips and warnings

- Always put the kneading accessory in the bowl before adding the ingredients.
- The standard processing time for all kneading jobs is 30-180 seconds.

DE | Knethaken: Tipps und Warnhinweise

- Setzen Sie stets den Knethaken in die Schüssel, bevor Sie die Zutaten einfüllen.
- Die normale Verarbeitungszeit beim Kneten beträgt 30 bis 180 Sekunden.

FR | Accessoire de pétrissage - suggestions et avertissements

- Mettez toujours l'accessoire de pétrissage dans le bol avant d'ajouter les ingrédients.
- La durée standard de préparation pour toute opération de pétrissage est de 30-180 secondes.

NL | Kneedaccessoire - tips en waarschuwingen

- Plaats het kneedaccessoire in de kom voordat u de ingrediënten toevoegt.
- De standaardverwerkingstijd voor alle kneedbewerkingen is 30 tot 180 seconden.

NO | Elteutstyr - tips og advarsler

- Sett alltid elteutstyret i bollen før du legger til ingrediensene.
- Standard bearbeidingstid for all elting er 30-180 sekunder.

SV | Knådningstillbehör - tips och varningar

- Sätt alltid knådningstillbehöret i skålen innan du tillsätter ingredienserna.
- Den normala beredningstiden för alla knådningsjobb är 30-180 sekunder.

FI | Vaivauslisälaite - vihjeitä ja varoituksia

- Aseta aina vaivauslisälaite kulhoon ennen aineiden lisäämistä.
- Normaali käsittelyaika kaikessa vaivauksessa on 30-180 sekuntia.

DK | Ælteindsats - tips og advarsler

- Monter altid ælteindsatsen i skålen, før du kommer ingredienserne i.
- Standardtilberedningstiden for al æltning er 30-180 sekunder.



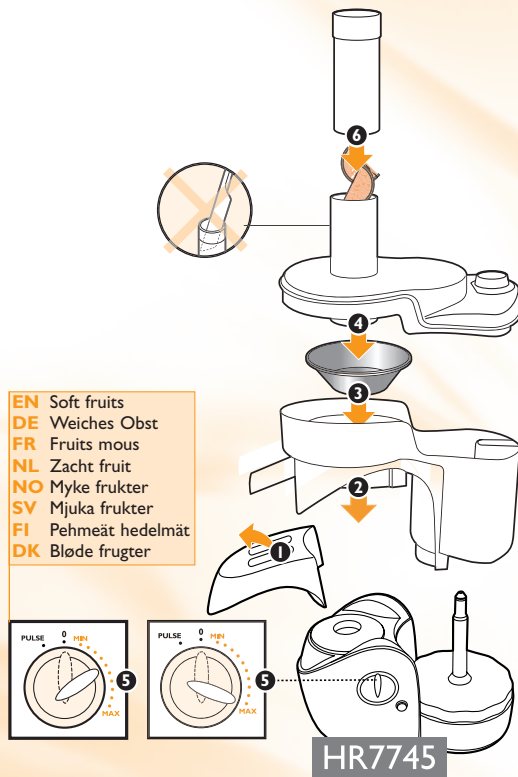

EN | Juicer - tips and warnings

Never insert your hand or another object (e.g. a fork, knife, spoon or spatula) into the feed tube. Only use the pusher supplied with the appliance for this purpose.

Wait until the sieve has completely stopped rotating before you remove the lid.

- Always switch the appliance on before putting the fruit in the juicer.
- Do not use the juicer if the sieve is damaged.
- ▶ *Built-in safety lock: the juicer will only function if all parts have all been assembled correctly.*
- ▶ **Before using the juicer:**
 - cut carrots, white radish etc.
 - peel citrus fruits, pineapples, melons, etc.
 - stone cherries, plums, apricots, peaches, etc.

DE | Entsafter: Tipps und Warnhinweise

Stecken Sie niemals Ihre Hand oder Gegenstände (z. B. Gabel, Messer, Löffel oder Spatel) in den Einfüllstutzen. Verwenden Sie zu diesem Zweck ausschließlich den mitgelieferten Stopfer.

Nehmen Sie den Deckel erst ab, wenn das Sieb ganz zum Stillstand gekommen ist.

- Schalten Sie das Gerät ein, bevor Sie Obst in den Entsafter füllen.
- Benutzen Sie den Entsafter nicht, wenn das Sieb beschädigt ist.
- ▶ *Integrierte Sicherheitssperre: Der Entsafter arbeitet nur, wenn alle Teile ordnungsgemäß zusammengesetzt sind.*
- ▶ **Vor dem Gebrauch des Entsafters:**
 - Möhren, Rettich usw. schneiden.
 - Zitrusfrüchte, Ananas, Melonen usw. schälen.
 - Kirschen, Pflaumen, Aprikosen, Pfirsiche usw. entsteinen.

FR | Centrifugeuse - suggestions et avertissements

Ne mettez jamais vos doigts ou tout autre objet (par ex. une fourchette, un couteau, une cuillère ou une spatule) dans la cheminée de remplissage. Utilisez toujours le poussoir fourni.

Attendez jusqu'à ce que le tambour s'arrête avant de retirer le couvercle.

- Mettez toujours l'appareil en marche avant de mettre les fruits dans la centrifugeuse.
- N'utilisez pas la centrifugeuse si le tambour est endommagé.
- ▶ *Verrouillage de sécurité incorporé: la centrifugeuse fonctionnera seulement si tous les composants ont été correctement montés.*
- ▶ **Avant d'utiliser la centrifugeuse:**
 - coupez les carottes, les radis, etc.
 - écorcez les agrumes, les ananas, les melons, etc.
 - dénoyotez les cerises, prunes, abricots, pêches, etc.

NL | Sapcentrifuge - tips en waarschuwingen

Steek nooit uw hand of een voorwerp (bijv. een vork, mes, lepel of spatel) in de vultrechter. Gebruik alleen de meegeleverde stamper voor dit doel.

Wacht tot de zeef volledig tot stilstand is gekomen voordat u het deksel verwijdert.

- Schakel het apparaat altijd in voordat u fruit in de sapcentrifuge doet.
- Gebruik de sapcentrifuge niet als de zeef beschadigd is.
- ▶ *Ingebouwde veiligheidsvergrendeling: de sapcentrifuge werkt alleen als alle onderdelen op de juiste wijze zijn gemonteerd.*
- ▶ **Voordat u de sapcentrifuge gaat gebruiken:**
 - snijd wortels, rettich enz.
 - schil citrusvruchten, ananas, meloen enz.
 - ontpit kersen, pruimen, abrikozen, perziken enz.

NO | Saftpresse - tips og advarsler

Putt aldri hånden eller en annen gjenstand (for eksempel en kniv, gaffel, skje eller slikkepott) ned i materøret. Bare stapperen som kom sammen med apparatet, skal brukes til dette.

Vent til silen har stanset helt før du fjerner lokket.

- Slå alltid på apparatet før du putter frukten i saftpressen.
- Ikke bruk saftpressen hvis silen er skadet.
- ▶ *Innebygd sikkerhetslås: Saftpressen vil bare fungere hvis alle delene er montert på riktig måte.*
- ▶ **Før du bruker saftpressen:**
 - Hakk opp gulrøtter, hvit reddik osv.
 - Skrell sitrusfrukt, ananas, meloner osv.
 - Fjern steiner fra kirsebær, plommer, aprikos, fersken osv.

SV | Saftpress - tips och varningar

För aldrig in handen eller något annat föremål (t.ex. en gaffel, kniv, sked eller degskrapa) i mataröppningen. Använd endast påmataren som medföljer apparaten för detta ändamål.

Vänta tills sållet helt har slutat rotera innan du tar bort locket.

- Slå alltid på apparaten innan du lägger frukt i saftpressen.
- Använd inte saftpressen om sållet är skadat.
- ▶ *Inbyggt säkerhetslås: saftpressen fungerar endast om alla delar har satts ihop på rätt sätt.*
- ▶ **Innan du använder saftpressen:**
 - skär morötter, vita rädisor o.s.v.
 - skala citrusfrukter, ananas, meloner o.s.v.
 - kärna ur körsbär, plommon, aprikoser, persikor o.s.v.





FI | Mehustin - vihjeitä ja varoituksia

Älä koskaan työnnä kättäsi tai mitään apuvälinettä syöttösuppiloon. Käytä tähän tarkoitukseen vain laitteen mukana toimitettavaa työnnintä.

Odot, että siivilä pysähtyy kokonaan, ennen kuin poistat kannen.

- Kytke aina laitteeseen virta, ennen kuin laitat hedelmiä mehustimeen.
- Älä käytä mehustinta, jos siivilä on vahingoittunut.
- ▶ *Sisäänrakennettu turvalukko: mehustin toimii vain, jos kaikki osat on koottu oikein.*
- ▶ **Ennen mehustimen käyttöä:**
 - paloittele porkkanat, retiisit ym.
 - kuori sitruhedelmät, ananakset, melonit ym.
 - poista siemenet kirsikoista, luumuista, aprikooseista, persikoista ym.



DK | Saftpresser - tips og advarsler

Stik aldrig din hånd eller andre genstande (f.eks. gaffel, kniv, ske eller spatel) ned i påfyldningstragten. Brug kun den medfølgende nedstopper til dette formål.

Vent, indtil sien er holdt helt op med at rotere, før du fjerner låget.

- Sluk altid for apparatet, før du kommer frugt i saftpresseren.
- Undlad at bruge saftpresseren, hvis filteret er beskadiget.
- ▶ *Indbygget sikkerhedslås: Saftpresseren fungerer kun, hvis alle dele er samlet korrekt.*
- ▶ **Før du tager saftpresseren i brug:**
 - Skær gulerødder, kinaradiser mv. i passende stykker
 - Skræl citrusfrugter, ananas, meloner mv.
 - Fjern stenene fra kirsebær, blommer, abrikoser, ferskner mv.



HR7745



EN | Storage

Storage

DE | Kompakte Aufbewahrung

Kompakte Aufbewahrung

FR | Rangement

Rangement

NL | Opbergen

Opbergen

NO | Oppbevaring

Oppbevaring

SV | Förvaring

Förvaring

FI | Säilytys













Säilytys

DK | Opbevaring

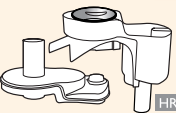
Opbevaring

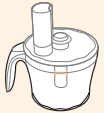



			
	✓	✓	
 HR7745	✓	✓	
	✓	✓	
	✓	✓	
 HR7745	✓	✓	
	✓	✓	
	✓	✓	
			✓

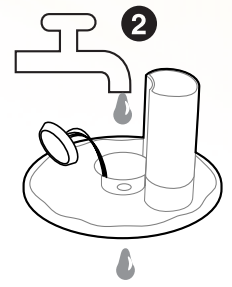
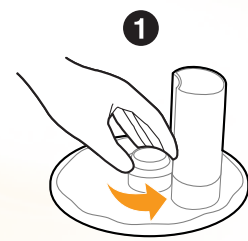
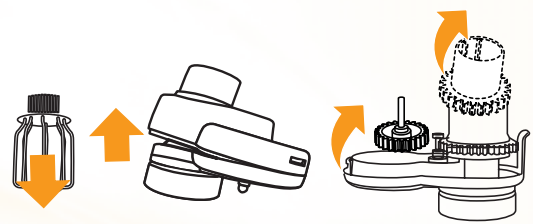

EN | Cleaning

- Always unplug the appliance before removing accessories or cleaning the motor unit.
- To clean the Click & Go button, you can unscrew it by turning it anticlockwise. Clean the lid in the dishwasher or let it soak in warm water with some washing-up liquid for a while and rinse it under the tap with clean water. If the Click & Go housing is still dirty after cleaning in the dishwasher, clean it in the dishwasher a second time.
- You can quickly and easily clean the food processor bowl and blender jar by means of the Clean button. Simply add some water and washing-up liquid to the dirty bowl or jar, secure the lid and press the Clean button until the bowl or jar is clean.
- When cleaning the food processor bowl in this way, make sure either the blade or the kneading accessory has been assembled in the bowl.
- To clean the balloon beater, pull the beater out of the gear housing. Then open the housing by pulling the latch sideways and take out the two gearwheels. Clean the gearwheels and the beater in hot water with some washing-up liquid.
- The gearwheels and the beater can also be cleaned in the dishwasher. The gear housing can be wiped with a moist cloth.

DE | Reinigung

- Ziehen Sie stets den Netzstecker aus der Steckdose, bevor Sie Zubehör abnehmen oder die Motoreinheit reinigen.
- Zum Reinigen des Click & Go-Schalters schrauben Sie ihn gegen den Uhrzeigersinn auf. Reinigen Sie den Deckel im Geschirrspüler oder weichen Sie ihn eine Weile in warmem Spülwasser ein und spülen Sie ihn dann unter klarem Leitungswasser ab. Sollte das Click & Go-Gehäuse nach dem Spülen in der Maschine noch schmutzig sein, säubern Sie es ein zweites Mal im Geschirrspüler.
- Schüssel und Mixbecher lassen sich schnell und einfach mit Hilfe der Clean-Taste reinigen: Füllen Sie etwas Wasser und Spülmittel in die schmutzige Schüssel oder den Mixbecher, befestigen Sie den Deckel und drücken Sie die Clean-Taste, bis die Schüssel bzw. der Mixbecher sauber ist.

- Beim Reinigen der Schüssel muss entweder das Messer oder das Knetzubehör in die Schüssel eingesetzt sein.
- Den Quirl reinigen Sie, indem Sie ihn aus dem Zahnradgehäuse ziehen. Öffnen Sie dann das Gehäuse, indem Sie den Riegel zur Seite ziehen und die beiden Zahnräder herausnehmen. Reinigen sie Zahnräder und Quirl in heißem Spülwasser.
- Sie können die Zahnräder und den Quirl auch im Geschirrspüler reinigen. Das Zahnradgehäuse lässt sich mit einem feuchten Tuch abwischen.

FR | Nettoyage

- Débranchez toujours l'appareil avant de retirer les accessoires et de nettoyer le bloc moteur.
- Pour nettoyer le bouton Click & Go, dévissez-le en tournant dans le sens inverse des aiguilles d'une montre. Nettoyez le couvercle au lave-vaisselle ou faites-le tremper dans de l'eau savonneuse pendant quelque temps, puis rincez-le à l'eau claire. Si la carcasse du système Click & Go est encore sale après l'avoir nettoyée au lave-vaisselle, nettoyez-la à nouveau.
- Vous pouvez nettoyer rapidement et facilement le bol pour préparer les aliments et le bol mixeur à l'aide du bouton Nettoyage. Ajoutez de l'eau et un peu de produit vaisselle dans le bol, verrouillez le couvercle et maintenez appuyé le bouton Nettoyage jusqu'à ce que le bol soit nettoyé.
- Lorsque vous nettoyez le bol pour préparer les aliments de cette façon, assurez-vous d'avoir inséré le couteau ou l'accessoire de pétrissage dans le bol.
- Pour nettoyer le fouet, tirez-le de l'engrenage. Ouvrez la carcasse en débloquant les loquets et otez les deux pignons. Nettoyez les pignons et le fouet à l'eau chaude savonneuse.
- Les pignons et le fouet sont résistants au lave-vaisselle. Vous pouvez essuyer la carcasse avec un chiffon humide.





NL | Schoonmaken

- Haal altijd de stekker uit het stopcontact voordat u accessoires verwijdert of de motorunit gaat schoonmaken.
- Om de Click & Go knop schoon te maken, kunt u hem losschroeven door hem linksom te draaien. Reinig het deksel in de vaatwasmachine of laat het een tijdje in warm water met wat afwasmiddel weken en spoel het vervolgens af onder de kraan. Als de behuizing van de Click & Go knop nog vuil is wanneer hij uit de vaatwasmachine komt, reinig hem dan nog een keer in de vaatwasmachine.
- U kunt de kom en de blenderkan makkelijk en snel reinigen door de 'Clean'-knop te gebruiken. Doe wat water en afwasmiddel in de vuile kom of kan, sluit het deksel en druk op de 'Clean'-knop totdat de kom of kan schoon is.
- Wanneer u de kom op deze manier reinigt, zorg er dan voor dat óf het mes óf het mengaccessoire in de kom zit.
- Trek de klopper uit het tandwielhuis om het mengaccessoire te reinigen. Open het tandwielhuis door de grendel opzij te trekken en de twee tandwielen uit te nemen. De tandwielen en de klopper kunnen in heet water met wat afwasmiddel worden gereinigd.
- De tandwielen en de klopper kunnen ook in de vaatwasmachine worden gereinigd. Het tandwielhuis kan met een vochtige doek schoon worden gemaakt.

NO | Rengjøring

- Koble alltid fra apparatet før du fjerner tilbehør eller rengjør motorenheten.
- For å rengjøre Click & Go-knappen kan du ta den av ved å skru mot klokken. Rengjør lokket i oppvaskmaskin, eller la det ligge en stund i varmt vann med litt oppvaskmiddel i, og rengjør det deretter under rennende vann. Hvis Click & Go-beholderen fremdeles er skitten når du har rengjort den i oppvaskmaskinen, rengjør du den en gang til i oppvaskmaskinen.

- Du kan raskt og enkelt rengjøre foodprocessorbollen og hurtigmikserkannen ved hjelp av Clean knappen. Bare tilsett litt vann og oppvaskmiddel i den skitne bollen eller kannen, sikre at lokket sitter og trykk på Clean knappen til bollen eller kannen er ren.
- Når du rengjør foodprocessorbollen på denne måten, vær sikker på at hverken kniven eller eltetilbehøret er montert i bollen.
- For å rengjøre ballongvispen drar du den ut av vispeenheten. Deretter åpner du enheten ved å dra sperrelåsen til siden og ta ut de to tannhjulene. Rengjør tannhjulene og ballongvispen i varmt vann med litt oppvaskmiddel i.
- Tannhjulene og vispen kan også rengjøres i oppvaskmaskinen. Vispeenheten kan tørkes med en fuktig klut.

SV | Rengöring

- Koppla alltid ur apparaten innan du tar bort tillbehör eller rengör motorenheten.
- Du kan rengöra Click & Go-knappen genom att skruva av den moturs. Diska locket i diskmaskinen eller blötlägg det i varmt vatten med lite diskmedel en stund och skölj det med rent vatten under kranen. Om Click & Go-höljet fortfarande är smutsigt efter du har diskat det i diskmaskinen ska du diska det i diskmaskinen en andra gång.
- Du kan snabbt och lätt rengöra matberedarskålen och mixerkannen med knappen Clean. Häll helt enkelt lite vatten och diskmedel i den smutsiga skålen eller kannan, säkra locket och tryck på knappen Clean tills skålen eller kannan är ren.
- När du rengör matberedarskålen på detta sätt ska du se till att kniven eller knådningstillbehöret har satts i skålen.
- Dra ut ballongvispen ur drivhjulshöljet om du ska rengöra den. Öppna sedan höljet genom att dra spärrhaken sidledes och ta ut de två drivhjulen. Rengör drivhjulen och vispen i varmt vatten med lite diskmedel.
- Drivhjulen och vispen kan också diskas i diskmaskinen. Drivhjulshöljet kan torkas av med en fuktad trasa.

FI | Puhdistus

- Irrota aina pistotulppa pistorasiasta ennen lisävarusteiden poistamista tai rengon puhdistusta.
- Voit irrottaa Click & Go -painikkeen puhdistusta varten kiertämällä sitä vastapäivään. Pese kansi astianpesukoneessa tai anna sen liota hetki lämpimässä vedessä, johon on lisätty astianpesuainetta, ja huuhtele se vesihanalla. Jos Click & Go -painikkeen kiinnityskohta on edelleen likainen konepesun jälkeen, voit uusia konepesun.
- Voit puhdistaa monitoimikoneen kulhon ja tehosekoittimen kannun nopeasti ja vaivattomasti Clean-painikkeen avulla. Lisää vain vettä ja astianpesuainetta likaiseen kulhoon tai kannuun, kiinnitä kansi ja paina Clean-painiketta, kunnes kulho tai kannu on puhdas.
- Kun puhdistat monitoimikoneen kulhoa tällä tavoin, varmista, että kulhoon on asetettu paikalleen joko terä tai vaivuslisälaite.
- Voit puhdistaa pallovatkaimen vetämällä vatkaimeen irti vaihteiston kotelosta. Avaa sitten kotelo kääntämällä vipua sivulle ja irrota siinä olevat kaksi hammaspyörää. Puhdista hammaspyörät ja vatkaimeen kuumalla vedellä ja astianpesuaineella.
- Hammaspyörät ja vatkaimeen kestävät myös konepesun. Vaihteiston kotelo voidaan pyyhkiä kostealla kankaalla.

DK | Rengøring

- Tag altid stikket ud af stikkontakten, før du fjerner tilbehøret fra apparatet eller rengør motorenheden.
- Når du skal rengøre Click & Go-knappen, kan du skrue den af ved at dreje den venstre om. Vask låget i opvaskemaskinen, eller læg det i blød i varmt vand tilsat lidt opvaskemiddel og skyl det derefter under vandhanen. Hvis Click & Go-kabinettet stadig er snavset efter en tur i opvaskemaskinen, vaskes det blot en gang til.
- Foodprocessorskål og blenderglas kan hurtigt rengøres ved hjælp af Clean-knappen. Hæld blot lidt vand og en smule opvaskemiddel i den snavsede skål eller blenderglas - fastgør låget og tryk på Clean-knappen, indtil skålen eller blenderglasset er rent.
- Når foodprocessor-skålen rengøres, må knivenheden eller æltetilbehøret ikke sidde i skålen.

- Når du skal rengøre ballonpiskeriset, skal det tages ud af gearhuset. Åbn derefter gearhuset ved at trække låsen sidelæns og tage de to gearhjul ud. Rengør gearhjul og piskeris i varmt vand tilsat lidt opvaskemiddel.
- Gearhjul og piskeris kan også vaskes i opvaskemaskinen. Gearhuset kan aftørres med en fugtig klud.



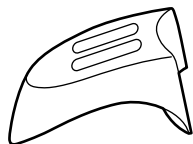

- EN** Blender cap
- DE** Verschlusskappe (Mixer)
- FR** Capuchon de sécurité
- NL** Blenderkap
- NO** Lokk på hurtigmikser
- SV** Mixerlock
- FI** Tehosekoittimen kansi
- DK** Blenderdæksel

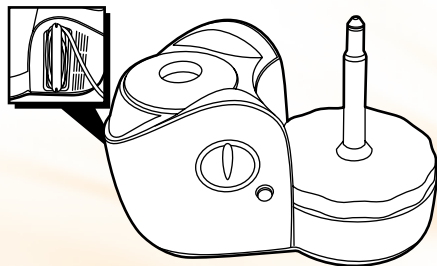

- EN** Motor unit with cord wind facility on the back
- DE** Motoreinheit mit rückseitiger Kabelaufwicklung
- FR** Bloc moteur avec range-cordon à l'arrière
- NL** Motorunit met snoeropbergmogelijkheid aan de achterzijde
- NO** Motorenhet med ledningsholder på baksiden
- SV** Motorenhet med sladdförvaring på baksidan
- FI** Runko, jonka takaosassa on johtokela
- DK** Motorenhed med oprulningskrog til ledning på bagsiden



- EN** Stopper
- DE** Deckeinsatz
- FR** Bouchon
- NL** Stop
- NO** Stopper
- SV** Propp
- FI** Pysäytin
- DK** Prop

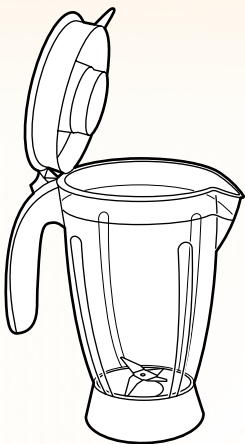

- EN** Blender jar with lid
- DE** Mixbecher mit Deckel
- FR** Bol mixeur avec couvercle
- NL** Blenderkan met deksel
- NO** Hurtigmikserkanne med lokk
- SV** Mixerkanna med lock
- FI** Tehosekoittimen kannu ja sen kansi
- DK** Blenderglas med låg

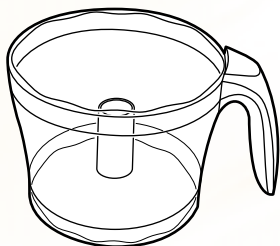

- EN** Food processor bowl
- DE** Schüssel
- FR** Bol pour préparer les aliments
- NL** Keukenmachinekom
- NO** Foodprocessorbolle
- SV** Matberedarskål
- FI** Monitoimikoneen kulho
- DK** Foodprocessorskål

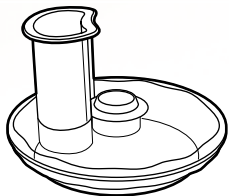

- EN** Food processor lid with Click & Go button
- DE** Deckel (Küchenmaschine) mit Click & Go-Schalter
- FR** Couvercle du bol avec bouton Click & Go
- NL** Deksel van keukenmachinekom met Click & Go knop
- NO** Foodprocessorlokk med Click & Go-knapp
- SV** Matberedarlock med Click & Go-knapp
- FI** Monitoimikoneen kansi ja Click & Go -painike
- DK** Låg til foodprocessorskål med Click & Go-knap





- EN** Pusher of food processor
- DE** Stopfer (Küchenmaschine)
- FR** Pousoir du bol
- NL** Stamper voor keukenmachine
- NO** Stapper for foodprocessor
- SV** Pämatare till matberedaren
- FI** Monitoimikoneen työnnin
- DK** Nedstopper til foodprocessor



- EN** Cone of citrus press
- DE** Kegel (Zitruspresse)
- FR** Cône du presse-agrumes
- NL** Perskegel van citruspers
- NO** Kjedge i sitruspresse
- SV** Kon till citruspress
- FI** Sitruspuristimen kartio
- DK** Pressekegle til citruspresser

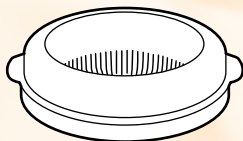

- EN** Sieve of citrus press
- DE** Sieb (Zitruspresse)
- FR** Tambour du presse-agrumes
- NL** Zeef van citruspers
- NO** Sil i sitruspresse
- SV** Säll till citruspress
- FI** Sitruspuristimen siivilä
- DK** Si til citruspresser

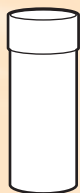

HR7745

- EN** Pusher of juicer
- DE** Stopfer (Entsafter)
- FR** Pousoir de la centrifugeuse
- NL** Stamper van sapcentrifuge
- NO** Stapper for saftpresse
- SV** Pämatare till saftpress
- FI** Mehustimen työnnin
- DK** Nedstopper til saftpresser

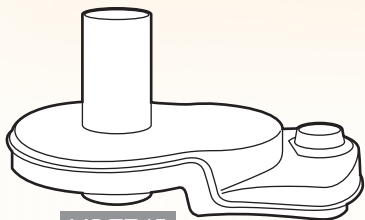

HR7745

- EN** Lid of juicer
- DE** Deckel (Entsafter)
- FR** Couvercle de la centrifugeuse
- NL** Deksel van sapcentrifuge
- NO** Løkk på saftpresse
- SV** Lock till saftpress
- FI** Mehustimen kansi
- DK** Låg til saftpresser



HR7745

- EN** Filter of juicer
- DE** Filter (Entsafter)
- FR** Filtre de la centrifugeuse
- NL** Filter van sapcentrifuge
- NO** Filter i saftpresse
- SV** Filter till saftpress
- FI** Mehustimen suodatin
- DK** Filter til saftpresser

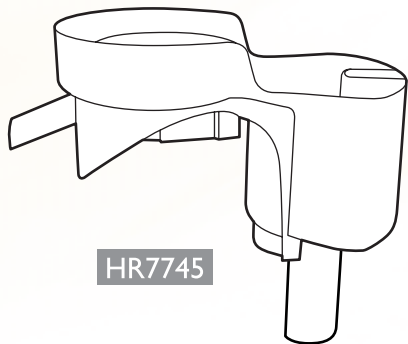

HR7745

- EN** Juicer
- DE** Entsafter
- FR** Centrifugeuse
- NL** Sapcentrifuge
- NO** Saftpresse
- SV** Saftpress
- FI** Mehustin
- DK** Saftpresser





- EN** Kneading hook
- DE** Knethaken
- FR** Accessoire de pétrissage
- NL** Kneedaccessoire
- NO** Eltekrok
- SV** Degkrok
- FI** Taikinakoukku
- DK** Ælteindsats

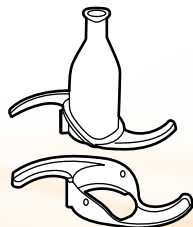

- EN** Blade with precision cap
- DE** Messer mit Schneidschutz
- FR** Couteau avec gaine de protection
- NL** Mes met beschermkap
- NO** Kniv med beskyttelsesdeksel
- SV** Kniv med precisionslock
- FI** Terä ja tarkennusosa
- DK** Knivenhed med beskyttelseskappe

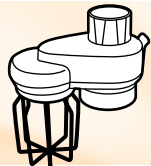

- EN** Balloon beater
- DE** Quirl
- FR** Fouet
- NL** Mengaccessoire
- NO** Ballongvisp
- SV** Ballongvisp
- FI** Pallovatkain
- DK** Ballonpiskeris



HR7745

- EN** Slicing insert fine
- DE** Schneideinsatz (fein)
- FR** Insert à trancher fin
- NL** Fijne snijschijf
- NO** Kutter, fin
- SV** Skärskiva, fint
- FI** Viipalointiosa hieno
- DK** Snitteplade, fin



- EN** Slicing insert medium
- DE** Schneideinsatz (mittel)
- FR** Insert à trancher moyen
- NL** Middelfijne snijschijf
- NO** Kutter, medium
- SV** Skärskiva, medium
- FI** Viipalointiosa keskikoko
- DK** Snitteplade, medium



- EN** Granulating insert
- DE** Mahleinsatz
- FR** Insert pour grainer
- NL** Granuleerschijf
- NO** Maler
- SV** Finfördelningsskiva
- FI** Rakeistusosa
- DK** Findelingsplade



- EN** Shredding insert fine
- DE** Raspeleinsatz (fein)
- FR** Insert à râper fin
- NL** Fijne raspschijf
- NO** Rasp, fin
- SV** Strimmelskiva, fint
- FI** Suikalointiosa hieno
- DK** Riveplade, fin





- EN** Shredding insert medium
- DE** Raspeleinsatz (mittel)
- FR** Insert à râper moyen
- NL** Middelfijne raspschijf
- NO** Rasp, medium
- SV** Strimmelskiva, medium
- FI** Suikalointiosa keskikoko
- DK** Riveplade, medium



- EN** Insert holder
- DE** Trägerscheibe
- FR** Axe support
- NL** Inzetschijfhouder
- NO** Holder for tilleggsutstyr
- SV** Skivhållare
- FI** Osateline
- DK** Holder til plader

EN | Guarantee & service

If you need information or if you have a problem, please visit the Philips website at www.philips.com or contact the Philips Customer Care Centre in your country (you will find its phone number in the worldwide guarantee leaflet). If there is no Customer Care Centre in your country, turn to your local Philips dealer or contact the Service Department of Philips Domestic Appliances and Personal Care BV.

DE | Garantie und Kundendienst

Benötigen Sie weitere Informationen oder treten Probleme auf, wenden Sie sich bitte an Ihren Philips-Händler oder setzen Sie sich mit einem Philips Service-Center in Ihrem Land in Verbindung (Tel. Nr. 0180/5356767). Besuchen Sie auch die Philips Website (www.philips.com).

FR | Garantie et service

Pour plus d'informations, visitez notre site Internet : www.philips.com ou veuillez contacter le Service Consommateurs Philips de votre pays (vous trouverez le numéro de téléphone dans le dépliant sur la garantie internationale). S'il n'y a aucun Service Consommateurs Philips dans votre pays, contactez votre distributeur ou le Service Department of Philips Domestic Appliances and Personal Care BV.

NL | Garantie & service

Als u informatie nodig heeft of als u een probleem heeft, bezoek dan de Philips website (www.philips.com), of neem contact op met het Philips Customer Care Centre in uw land (u vindt het telefoonnummer in het 'worldwide guarantee' vouwblad). Als er geen Customer Care Centre in uw land is, ga dan naar uw Philips dealer of neem contact op met de afdeling Service van Philips Domestic Appliances and Personal Care BV.

NO | Garanti og service

Hvis du trenger service eller informasjon, kan du se Philips' Web-område på www.philips.com eller kontakte Philips Kundetjeneste (se telefonnummer i garantiheftet). Hvis det ikke er noe Philips Kundetjenestесenter i landet hvor du befinner deg, kan du kontakte ditt lokale Philips-forhandler eller serviceavdelingen ved Philips Domestic Appliances and Personal Care BV.

SV | Garanti & service

Om du behöver information eller har något problem ska du söka upp Philips webbsida på adressen www.philips.com, eller kontakta Philips kundtjänst i ditt land (rätt telefonnummer finner du i världsgarantibroschyren). Om det inte finns någon kundtjänst i ditt land ska du vända dig till din lokala återförsäljare, eller kontakta serviceavdelningen på Philips Domestic Appliances and Personal Care BV.

FI | Takuu & huolto

Jos haluat lisätietoja tai laitteen kanssa tulee ongelmia, katso Philipsin www.sivustoa osoitteesta www.philips.com tai kysy neuvoa Philipsin asiakaspalvelusta (puhelinnumero on kansainvälisessä takuulehtisessä). Voit myös kääntyä Philips-myyjän tai Philips Kodinkoneiden valtuuttaman huoltoliikkeen puoleen.

DK | Reklamationsret og service

For alle yderligere oplysninger eller ved eventuelle problemer med apparatet henvises venligst til Philips' hjemmeside på adressen: www.philips.com eller det lokale Philips Kundecenter (telefonnummeret findes i vedlagte "World-Wide Guarantee"-folder). Hvis der ikke findes et Kundecenter i dit land, bedes du venligst kontakte din lokale Philips-forhandler eller serviceafdelingen i Philips Domestic Appliances and Personal Care BV. Dette apparat overholder de gældende EU-direktiver vedrørende sikkerhed og radiostøj.





EN | Troubleshooting guide



Problem	Solution
The food processor does not work.	Check whether the lid has properly locked into place on the bowl with a click and whether the blender cap has been properly assembled onto the motor unit (see page 11). All functions except the blender can only be used when the blender cap is attached to the motor unit.
Both the blender jar and the food processing bowl are attached, but only the blender works.	If both the blender jar and the food processing bowl have been mounted correctly, only the blender will work. If you want to use the food processing bowl, remove the blender jar and assemble the blender cap onto the motor unit (see page 11).
The appliance suddenly stopped running	The thermal safety cut-out has probably cut off the power supply to the appliance because it has overheated. 1) Unplug the appliance. 2) Let the appliance cool down for 60 minutes. 3) Put the mains plug in the socket. 4) Switch the appliance on again.
The citrus press does not work	Check whether the blender cap has been properly assembled onto the motor unit (see page 11). All functions except the blender can only be used when the blender cap is attached to the motor unit.
The appliance cannot be switched on.	Check whether the lid has properly locked into place on the bowl with a click and whether the blender cap has been properly assembled onto the motor unit (see page 11). All functions except the blender can only be used when the blender cap is attached to the motor unit.
Dirt has entered the Click & Go button. What can I do?	Take the lid off the bowl, unscrew the Click & Go button by turning it anticlockwise and clean the lid in the dishwasher. If there is still dirt in the Click & Go button after this, clean the lid in the dishwasher a second time. If you do not have a dishwasher you can also let the lid soak in warm water with some washing-up liquid for a while and then rinse it with clean water.

DE | Hilfe bei Schwierigkeiten

Problem	Lösung
Die Küchenmaschine funktioniert nicht.	Prüfen Sie, ob der Deckel mit einem Klicken auf der Schüssel eingerastet ist und die Verschlusskappe des Mixers fest auf der Motoreinheit sitzt (s. Seite 11). Mit Ausnahme des Mixers lassen sich die Gerätefunktionen nur aktivieren, wenn die Verschlusskappe des Mixers auf der Motoreinheit angebracht ist.
Die Schüssel und der Mixbecher sind beide auf die Motoreinheit aufgesetzt, aber nur der Mixer funktioniert.	Wenn sowohl Mixbecher und Schüssel richtig montiert sind, läuft nur der Mixer. Wenn Sie die Schüssel benutzen möchten, nehmen Sie den Mixbecher ab und setzen Sie die Verschlusskappe auf die Motoreinheit (s. Seite 11).
Das Gerät ist plötzlich zum Stillstand gekommen.	Vermutlich hat der automatische Überhitzungsschutz die Stromzufuhr unterbrochen, weil das Gerät überhitzt war: 1) Ziehen Sie den Stecker aus der Steckdose. 2) Lassen Sie das Gerät 60 Minuten lang abkühlen. 3) Stecken Sie den Netzstecker in die Steckdose. 4) Schalten Sie das Gerät wieder ein.
Die Zitruspresse funktioniert nicht	Prüfen Sie, ob Sie die Verschlusskappe richtig auf der Motoreinheit gesetzt haben (s. Seite 11). Mit Ausnahme des Mixers lassen sich die Gerätefunktionen nur aktivieren, wenn die Verschlusskappe auf der Motoreinheit befestigt ist.
Das Gerät lässt sich nicht einschalten.	Prüfen Sie, ob der Deckel richtig auf der Schüssel eingerastet ist und die Verschlusskappe ordnungsgemäß auf der Motoreinheit angebracht ist (s. Seite 11). Mit Ausnahme des Mixers lassen sich die Gerätefunktionen nur aktivieren, wenn die Verschlusskappe auf der Motoreinheit befestigt ist.

Problem	Lösung
Schmutz ist in den Click & Go-Schalter geraten. Was kann ich tun?	Nehmen Sie den Deckel von der Schüssel, schrauben Sie den Click & Go-Schalter gegen den Uhrzeigersinn auf und reinigen Sie den Deckel im Geschirrspüler. Wenn der Click & Go-Schalter danach immer noch schmutzig ist, säubern Sie den Deckel ein zweites Mal im Geschirrspüler. Haben Sie keinen Geschirrspüler, können Sie den Deckel auch eine Weile in warmem Spülwasser einweichen und anschließend unter klarem Wasser abspülen.

FR | Guide de dépannage

Problème	Solution
Le robot de cuisine ne fonctionne pas.	Vérifiez si le couvercle a été correctement fixé sur le bol (clic) et si le capuchon du mixeur a été vissé sur le bloc moteur (voir page 11). Toutes les fonctions, sauf le mixeur, peuvent être utilisées lorsque le capuchon est fixé sur le bloc moteur.
Le bol mixeur et le bol pour préparer les aliments sont attachés, mais le mixeur seul fonctionne.	Si le bol mixeur et le bol pour préparer les aliments ont été correctement attachés, seul le mixeur fonctionnera. Si vous voulez utiliser le bol pour préparer les aliments, détachez le bol mixeur et montez le capuchon sur le bloc moteur (voir page 11).
L'appareil s'est arrêté brusquement.	La coupure thermique de sécurité a probablement coupé l'alimentation suite à une surchauffe. 1) Débranchez l'appareil. 2) Laissez l'appareil refroidir pendant 60 minutes. 3) Branchez à nouveau l'appareil. 4) Remettez l'appareil en marche.
Le presse-agrumes ne fonctionne pas.	Vérifiez si vous avez vissé correctement le capuchon sur le bloc moteur (voir page 11). Toutes les fonctions, sauf le mixeur, peuvent être utilisées lorsque le capuchon est fixé sur le bloc moteur.

Problème	Solution
L'appareil ne peut pas être mis en marche.	Vérifiez si le couvercle a été correctement fixé sur le bol (clic) et que le capuchon du mixeur ait été vissé sur le bloc moteur (voir page 11). Toutes les fonctions, sauf le mixeur, peuvent être utilisées lorsque le capuchon est fixé sur le bloc moteur.
Il y a des particules de saleté dans le bouton Click & Go. Que puis-je faire?	Retirez le couvercle, dévissez le bouton Click & Go en tournant dans le sens inverse des aiguilles d'une montre et nettoyez-le au lave-vaisselle. Si le bouton est encore sale, nettoyez-le au lave-vaisselle pour la seconde fois. Si vous n'avez pas de lave-vaisselle, faites tremper le couvercle dans de l'eau chaude savonneuse pendant quelque temps, puis rincez-le à l'eau claire.

NL | Problemen oplossen

Probleem	Oplossing
De keukenmachine doet het niet.	Controleer of het deksel goed met een klik vergrendeld is op de kom en of de blenderkap goed gemonteerd zit op de motorunit (zie pagina 11). Alle functies met uitzondering van de blender kunnen alleen gebruikt worden wanneer de blenderkap op de motorunit gemonteerd is.
Zowel de blenderkan als de kom is gemonteerd, maar alleen de blender werkt.	Als zowel de blenderkan als de kom is gemonteerd, werkt inderdaad alleen de blender. Als u de kom wilt gebruiken, dan moet u de blenderkan verwijderen en de blenderkap op de motorunit monteren (zie pagina 11).
Het apparaat is plotseling gestopt.	De automatische oververhittingsbeveiliging heeft de stroomtoevoer naar het apparaat waarschijnlijk afgesneden omdat het apparaat oververhit was geraakt. 1) Trek de stekker uit het stopcontact. 2) Laat het apparaat 60 minuten afkoelen. 3) Steek de stekker weer in het stopcontact. 4) Schakel het apparaat weer in.





Probleem	Oplossing
----------	-----------

De citruspers doet het niet.	Controleer of de blenderkap goed op de motorunit gemonteerd zit (zie pagina 11). Alle functies met uitzondering van de blender kunnen alleen gebruikt worden wanneer de blenderkap op de motorunit gemonteerd is.
------------------------------	---

Het apparaat kan niet worden ingeschakeld.	Controleer of het deksel goed met een klik vergrendeld is op de kom en of de blenderkap goed gemonteerd is op de motorunit (zie pagina 11). Alle functies met uitzondering van de blender kunnen alleen gebruikt worden wanneer de blenderkap op de motorunit gemonteerd is.
--	--

Er is vuil binnengedrongen in de Click & Go knop. Wat moet ik doen?	Neem het deksel van de kom, schroef de Click & Go knop los uit het deksel door hem linksom te draaien en reinig het deksel in de vaatwasmachine. Als er hierna nog steeds vuil zit in de Click & Go knop, reinig het deksel dan nogmaals in de vaatwasmachine. Als u geen vaatwasmachine heeft, kunt u het deksel ook in warm water met wat afwasmiddel laten weken en het vervolgens met schoon water afspoelen.
---	---

NO | Feilsøking

Problem	Løsning
---------	---------

Foodprocessoren virker ikke.	Kontroller at lokket er festet skikkelig på bollen (med et klikk) og at hurtigmikserdekslet er riktig montert på motorenheten (se side 11). Alle funksjoner unntatt hurtigmikseren kan bare brukes når dette dekslet er festet på motorenheten.
------------------------------	---

Både hurtigmikserkannen og foodprocessorbollen er riktig montert, vil bare hurtigmikseren virke. Hvis du vil bruke foodprocessorbollen, fjerner du hurtigmikserkannen og fester hurtigmikserdekslet på motorenheten (se side 11).	Hvis både hurtigmikserkannen og foodprocessorbollen er riktig montert, vil bare hurtigmikseren virke. Hvis du vil bruke foodprocessorbollen, fjerner du hurtigmikserkannen og fester hurtigmikserdekslet på motorenheten (se side 11).
---	--

Problem	Løsning
---------	---------

Apparatet stanset	Sikkerhetsbryteren har sannsynligvis brutt strømmen fordi apparatet ble for varmt. 1) Koble fra apparatet. 2) La det kjøres ned i 1 time. 3) Sett støpselet i stikkontakten. 4) Slå apparatet på igjen.
-------------------	---

Sitruspressen virker ikke	Sjekk om hurtigmikserdekslet er skikkelig festet på motorenheten (se side 11). Alle funksjoner unntatt hurtigmikseren kan bare brukes når dette dekslet er festet på motorenheten.
---------------------------	--

Apparatet kan ikke slås på.	Kontroller at lokket er festet skikkelig på bollen (med et klikk) og at hurtigmikserdekslet er riktig montert på motorenheten (se side 11). Alle funksjoner unntatt hurtigmikseren kan bare brukes når dette dekslet er festet på motorenheten.
-----------------------------	---

Det har kommet smuss i Click & Go-knappen. Hva kan jeg gjøre?	Ta lokket av bollen, ta av Click & Go-knappen ved å skru den mot klokken, og rengjør lokket i oppvaskmaskin. Hvis Click & Go-knappen fremdeles er skitten, rengjør du den en gang til i oppvaskmaskinen. Hvis du ikke har en oppvaskmaskin, lar du den ligge en stund i varmt vann med litt oppvaskmiddel i, og rengjør den deretter under rennende vann.
---	---

SV | Felsökningsguide

Problem	Lösning
---------	---------

Matberedaren fungerer inte.	Kontrollera om locket har låsts ordentligt på plats på skålen med ett klick och om mixerlocket har satts på ordentligt på motorenheten (se sidan 11). Alla funktioner utom mixern kan endast användas när mixerlocket är fastsatt på motorenheten.
-----------------------------	--

Både mixerkannen och matberedarskålen har satts ihop på rätt sätt fungerar endast mixern. Om du vill använda matberedarskålen måste du ta bort mixerkannen och sätta på mixerlocket på motorenheten (se sidan 11).	Om både mixerkannen och matberedarskålen har satts ihop på rätt sätt fungerar endast mixern. Om du vill använda matberedarskålen måste du ta bort mixerkannen och sätta på mixerlocket på motorenheten (se sidan 11).
--	---

Problem	Lösning
Apparaten slutar plötsligt att fungera	Värmesäkringen har förmodligen stängt av strömtilförseln till apparaten därför att den har överhettats. 1) Koppla ur apparaten. 2) Låt apparaten svalna i 60 minuter. 3) Sätt i stickkontakten i uttaget. 4) Slå på apparaten igen.
Citruspressen fungerar inte	Kontrollera om mixerlocket har satts på ordentligt på motorenheten (se sidan 11). Alla funktioner utom mixern kan endast användas när mixerlocket är påsatt på motorenheten.
Apparaten kan inte slås på.	Kontrollera om locket har låsts ordentligt på plats på skålen med ett klick och om mixerlocket har satts på ordentligt på motorenheten (se sidan 11). Alla funktioner utom mixern kan endast användas när mixerlocket är påsatt på motorenheten.
Smuts har trängt in i Click & Go-knappen. Vad kan jag göra?	Ta av locket på skålen, skruva av Click & Go-knappen genom att vrida den moturs och diska locket i diskmaskinen. Om det fortfarande finns smuts i Click & Go-knappen efter detta ska du diska locket i diskmaskinen en andra gång. Om du inte har diskmaskin kan du också blötlägga locket i varmt vatten med lite diskmedel en stund och sedan skölja det med rent vatten.

FI | Tarkistusluettelo

Ongelma	Ratkaisu
Monitoimikone ei toimi.	Tarkista, että kansi on lukittu asianmukaisesti paikalleen ja tehosekoittimen kansi on asianmukaisesti kiinnitetty rungon päälle (katso sivu 11). Kaikki toiminnot tehosekoitinta lukuun ottamatta ovat käytettävissä vain, kun tehosekoittimen kansi on kiinnitetty runkoon.
Sekä tehosekoitin että kulho ovat paikallaan, mutta vain tehosekoitin toimii.	Jos sekä tehosekoittimen kannu että monitoimikoneen kulho on asennettu oikein, vain tehosekoitin toimii. Jos haluat käyttää monitoimikoneen kulhoa, poista tehosekoittimen kannu ja aseta tehosekoittimen kansi paikalleen rungon päälle (katso sivu 11).

Ongelma	Ratkaisu
Laitteen toiminta keskeytyy odottamatta	Lämpökytkin on todennäköisesti katkaissut laitteesta virran, koska laite on kuumentunut liikaa. 1) Irrota pistotulppa pistorasiasta. 2) Anna laitteen jäähtyä 60 minuuttia. 3) Liitä pistotulppa pistorasiaan. 4) Kytke laitteeseen uudelleen virta.
Sitruspuristin ei toimi	Tarkista, että tehosekoittimen kansi on asianmukaisesti kiinnitetty rungon päälle (katso sivu 11). Kaikki toiminnot tehosekoitinta lukuun ottamatta ovat käytettävissä vain, kun tehosekoittimen kansi on kiinnitetty runkoon.
Laitte ei käynnisty.	Tarkista, että kulhon kansi on lukittu asianmukaisesti paikalleen ja tehosekoittimen kansi on asianmukaisesti kiinnitetty rungon päälle (katso sivu 11). Kaikki toiminnot tehosekoitinta lukuun ottamatta ovat käytettävissä vain, kun tehosekoittimen kansi on kiinnitetty runkoon.
Click & Go -painikkeeseen on päässyt likaa. Mitä voin tehdä?	Ota kansi pois kulhosta, irrota Click & Go -painike kiertämällä sitä vastapäivään ja puhdista kansi astianpesukoneessa. Jos Click & Go -painikkeessa on edelleen likaa, toista konepesu. Voit myös antaa kannen liota lämpimässä vedessä, johon on lisätty astianpesuainetta, ja huuhdella sitten kannen puhtaalla vedellä.





DK | Fejlsøgning

Problem	Løsning
Foodprocessoren fungerer ikke.	Kontrollér, om låget er klikket ordentligt fast på skålen, og om blenderdækslet er monteret korrekt på motorenheden (se side 11). Alle funktioner med undtagelse af blenderen kan kun anvendes, når blenderdækslet er monteret på motorenheden.
Både blenderglas og skål er sat på, men det er kun blenderen, der fungerer.	Hvis både blenderglas og foodprocessorskål er monteret korrekt, er det kun blenderen, som fungerer. Hvis du vil bruge foodprocessorskålen, skal du først fjerne blenderglasset og skrue blenderdækslet på motorenheden (se side 11).
Apparatet stopper pludselig.	Overophedningssikringen har sandsynligvis afbrudt strømmen til apparatet på grund af overophedning. 1) Tag stikket ud af stikkontakten. 2) Lad apparatet køle af i 60 minutter. 3) Sæt stikket i stikkontakten. 4) Tænd for apparatet igen.
Citruspresseren fungerer ikke.	Kontrollér, om blenderdækslet er monteret korrekt på motorenheden (se side 11). Alle funktioner med undtagelse af blenderen kan kun anvendes, når blenderdækslet er skruet på motorenheden.
Apparatet tænder ikke.	Kontrollér, at låget er klikket ordentligt på plads på skålen, og at blenderdækslet er monteret korrekt på motorenheden (se side 11). Alle funktioner med undtagelse af blenderen kan kun bruges, når blenderdækslet er monteret på motorenheden.
Der er snavs under Click & Go-knappen. Hvad gør jeg?	Tag låget af skålen, skru Click & Go-knappen af ved at dreje den venstre om, og vask låget i opvaskemaskinen. Hvis der herefter stadig sidder snavs under Click & Go-knappen, skal du give låget en tur mere i opvaskemaskinen. Hvis du ikke har en opvaskemaskine, kan du lægge låget i blød i varmt vand tilsat lidt opvaskemiddel og derefter skylle det under vandhanen.



Soy milk

This recipe can only be prepared with the filter. Do not process more than one batch in a row. Let the appliance cool down to room temperature before you continue processing.

- ▶ *Filters are available under type number HR2938. Contact your Philips dealer.*

Ingredients:

- 110g dried soy beans
- 1100ml water
- ▶ *Soak the soy beans for 4 hours before processing them. Set aside to drain.*
- ▶ *Put the soaked soy beans in the filter. Pour 1100ml of water into the blender jar and blend for 30 seconds.*
- ▶ *Pour the soy milk into a pan.*
- ▶ *Bring the soy milk to the boil, then add sugar to taste and leave to simmer until all the sugar has melted.*
- ▶ *Serve hot or cold.*

Fresh fruit milkshake

Do not process more than one batch in a row. Let the appliance cool down to room temperature before you continue processing.

Ingredients:

- 100g bananas or strawberries
- 200ml fresh milk
- 50g vanilla ice cream
- granulated sugar to taste
- ▶ *Peel the bananas or rinse and hull the strawberries. Cut fruit into smaller pieces. Put all the ingredients in the blender jar. Blend until smooth.*
- ▶ *You can use any fruit you like to make your favourite fresh fruit milkshake.*

Chocolate cake

Ingredients for the dough:

- 140 g butter, softened
- 110g icing sugar
- 140g chocolate
- 6 egg whites
- 6 egg yolks
- 110g granulated sugar
- 140g wheat flour
- 1 packet baking powder

Filling:

- 200g apricot jam

Icing:

- 125ml water
- 300g sugar
- 250g grated chocolate
- whipped cream, if desired

- ▶ *Heat oven to 160°C. Cream butter with icing sugar using the blade. Melt the chocolate and mix in. Add egg yolks one by one to the mixture and mix until creamy. Whip the egg whites with the granulated sugar until stiff and foamy using the blade. Add the egg white foam to the mixture and stir in gently. Then fold in flour with a spatula. Put the cake mixture in a greased baking tin (24 cm). Bake for one hour at 160°C. The first 15 minutes the oven door should be kept slightly ajar.*
- ▶ *Allow the cake to cool for a while in the baking tin, then turn it onto a wire rack to cool further. Cut the cake horizontally in half, spread one half with apricot jam and put the two halves together again. Heat the rest of the jam until syrupy and spread it over the top of the cake. Prepare the icing. Boil water, add sugar and chocolate and cook over low heat. Stir continuously until it has a smooth and spreadable consistency. Put the icing on the cake and allow it to cool. Serve the cake with some whipped cream.*





DE | Rezepte



Sojamilch

Dieses Rezept kann nur mit Hilfe des Filters zubereitet werden. Verarbeiten Sie jeweils nur eine Portion und lassen Sie das Gerät auf Raumtemperatur abkühlen, bevor Sie weitere Mengen zubereiten.

- ▶ *Ersatzfilter sind unter der Typennummer HR2938 über Ihren Philips-Händler erhältlich.*

Zutaten:

- 110 g getrocknete Sojabohnen
- 1100 ml Wasser
- ▶ *Weichen Sie die Sojabohnen vor dem Verarbeiten 4 Stunden ein. Lassen Sie sie abtropfen.*
- ▶ *Geben Sie die eingeweichten Sojabohnen in den Filter. Gießen Sie 1100 ml Wasser in den Mixbecher und lassen Sie den Mixer 30 Sekunden lang laufen.*
- ▶ *Gießen Sie die Sojamilch in einen Topf.*
- ▶ *Lassen Sie die Sojamilch aufkochen, fügen Sie dann Zucker hinzu und lassen Sie die Milch köcheln, bis sich der Zucker vollständig aufgelöst hat.*
- ▶ *Servieren Sie die Milch warm oder kalt.*

Obst-Milchshake

Verarbeiten Sie jeweils nur eine Portion und lassen Sie das Gerät auf Raumtemperatur abkühlen, bevor Sie weitere Mengen zubereiten.

Zutaten:

- 100 g Bananen oder Erdbeeren
- 200 ml frische Milch
- 50 g Vanille-Eiscreme
- Nach Belieben: Kristallzucker
- ▶ *Bananen schälen bzw. Erdbeeren abspülen und entstielen. Das Obst in kleine Stücke schneiden. Alle Zutaten in den Mixbecher geben und glatt mixen.*
- ▶ *Sie können jedes beliebige Obst zum Mixen Ihres bevorzugten Milchshakes verwenden.*

Schokoladekuchen

Zutaten für den Teig:

- 140 g weiche Butter
- 110 g Puderzucker
- 140 g Schokolade
- 6 Eiweiß
- 6 Eigelb
- 110 g Zucker
- 140 g Weizenmehl
- 1 Päckchen Backpulver

Füllung:

- 220 g Aprikosenmarmelade

Schokoladenguss:

- 125 ml Wasser
- 300 g Zucker
- 250 geraspelte Schokolade
- Schlagsahne, nach Belieben
- ▶ *Den Backofen auf 160° C vorheizen. Butter und Puderzucker mit dem Messereinsatz cremig rühren. Die Schokolade schmelzen und untermischen. Eigelb einzeln zugeben und cremig rühren. Eiweiß und Zucker mit der Messereinheit steif und schaumig schlagen. Den Eiweißschaum vorsichtig unter die Mischung rühren. Dann das Mehl mit einem Teigschaber unterheben. Die Kuchenmischung in eine gefettete Springform (24 cm) geben und 1 Stunde bei 160° C backen. Während der ersten 15 Minuten sollte die Backofentür leicht geöffnet sein.*
- ▶ *Den Kuchen eine Weile in der Backform abkühlen lassen und dann zum Auskühlen auf ein Kuchengitter stürzen. Den Kuchen waagrecht in der Mitte durchschneiden, eine Hälfte mit Aprikosenmarmelade bestreichen und die andere Hälfte wieder darauf legen. Die restliche Marmelade zu Sirup erhitzen und den Kuchen damit bestreichen. Für den Zuckerguss das Wasser aufkochen, Zucker und Schokolade hinzugeben und die Mischung bei geringer Hitze unter ständigem Rühren köcheln lassen, bis sie eine glatte und streichbare Konsistenz hat. Den Schokoladenguss über den Kuchen verteilen und abkühlen lassen. Mit Schlagsahne servieren.*



Lait de soja

Pour préparer cette recette vous devez utiliser le filtre. Ne traitez pas deux portions de suite sans laisser l'appareil refroidir avant de continuer.

- ▶ Les filtres sont disponibles sous le code HR2938. Contactez votre revendeur Philips.

Ingrédients:

- 110 g germes de soja
- 1100 ml d'eau
- ▶ Faites tremper les germes de soja pendant au moins 4 heures. Laissez s'égoutter.
- ▶ Mettez les germes de soja dans le filtre. Versez 1100 ml de l'eau dans le bol mixer et mélangez pendant 30 secondes.
- ▶ Versez le lait dans une casserole.
- ▶ Faites bouillir le lait de soja, ajoutez du sucre et laissez cuire à feu doux jusqu'à ce que le sucre soit fondu.
- ▶ Servir chaud ou froid.

Milkshake aux fruits frais

Ne traitez pas plus d'une portion sans interruption. Laissez l'appareil refroidir à la température ambiante avant de continuer.

Ingrédients:

- 100 g bananes ou fraises
- 200 ml lait frais
- 50g glace à la vanille
- sucre semoule au goût
- ▶ Pelez les bananes et rincez les fraises. Coupez-les en petits morceaux. Mettez tous les ingrédients dans le bol mixeur. Mélangez jusqu'à ce qu'ils deviennent mousseux.
- ▶ Vous pouvez utiliser votre fruits préférés pour préparer un milkshake aux fruits frais à votre goût.

Gâteau au chocolat

Ingrédients pour la pâte:

- 140 g beurre ramolli
- 110 g sucre glace
- 140 g chocolat
- 6 blancs d'oeufs
- 6 jaunes d'oeufs
- 110 g sucre semoule
- 140 g farine de blé
- 1 sachet de levure chimique

Garniture:

- 200 g confiture d'abricots

Glaçage:

- 125 ml d'eau
- 300 g sucre
- 250 g chocolat râpé
- crème fouettée, si vous le souhaitez
- ▶ Chauffez le four à 160°C. Mélangez le beurre avec le sucre glace à l'aide du couteau. Faites fondre le chocolat et incorporez-le. Ajoutez-y les jaunes d'oeufs un à un et fouettez le tout jusqu'à ce que vous obteniez une pâte crémeuse. Mélangez les blancs d'oeufs avec le sucre semoule jusqu'à ce que le mélange devienne blanc et mousseux à l'aide du couteau. Incorporez la mousse de blancs d'oeufs au mélange et remuez doucement. Terminez par incorporer la farine avec une spatule. Versez la pâte dans le moule à gâteau beurré (24 cm). Faites cuire une heure à 160°C. Pendant les premières 15 minutes, il est conseillé de tenir la porte du four entrouverte.
- ▶ Laissez le gâteau refroidir pendant quelque temps dans le moule, ensuite retournez-le sur une grille pour refroidir complètement. Coupez le gâteau en deux dans le sens de la longueur, nappez une moitié de gâteau de la confiture d'abricots et recouvrez avec l'autre moitié. Faites bouillir le reste de la confiture jusqu'à ce que vous obteniez un sirop et enduisez le gâteau. Préparez le glaçage. Faites bouillir l'eau, ajoutez le sucre et le chocolat et laissez cuire à feu doux. Remuez sans cesse jusqu'à ce que vous obteniez un glaçage uniforme et consistant. Couvrez le gâteau du glaçage et laissez-le refroidir. Servez le gâteau avec un peu de crème fouettée.





NL | Recepten



Sojamelk

Voor dit recept heeft u het filter nodig. Verwerk nooit meerdere porties achterelkaar. Laat na het verwerken van een portie het apparaat eerst afkoelen tot kamertemperatuur voordat u een volgende portie gaat verwerken.

► *Filters zijn verkrijgbaar onder typenummer HR2938. Neem contact op met uw Philips dealer.*

Ingrediënten:

- 110 g gedroogde sojabonen
- 1100 ml water
- *Week de sojabonen 4 uur voordat u ze gaat verwerken en laat ze daarna uitlekken.*
- *Plaats de geweekte sojabonen in het filter. Giet 1100 ml water in de blenderkan en laat het apparaat 30 seconden werken.*
- *Giet de sojamelk in een pan.*
- *Breng de sojamelk aan de kook, voeg suiker toe en laat de melk zachtjes koken totdat alle suiker gesmolten is.*
- *Warm of koud serveren.*

Milkshake van verse vruchten

Verwerk nooit meerdere porties achterelkaar. Laat na het verwerken van een portie het apparaat eerst afkoelen tot kamertemperatuur voordat u een volgende portie gaat verwerken.

Ingrediënten

- 100 g bananen of aardbeien
- 200 ml verse melk
- 50 g vanilleijs
- kristalsuiker naar smaak
- *Pel de bananen of spoel de aardbeien en verwijder de kroontjes. Snijd de vruchten in kleinere stukken. Doe alle ingrediënten in de blenderkan en laat het apparaat werken tot er een gladde vruchtenpuree is ontstaan.*
- *U kunt elk fruit dat u lekker vindt gebruiken om een verse milkshake te maken.*

Chocoladetaart

Ingrediënten voor het deeg:

- 140 g zachte boter
- 110 g poedersuiker
- 140 g chocolade
- 6 eiwitten
- 6 eidooiers
- 110 g kristalsuiker
- 140 g tarwebloem
- 1 zakje bakpoeder

Vulling:

- 200 g abrikozenjam

Glazuur:

- 125 ml water
- 300 g suiker
- 250 g geraspte chocolade
- geklopte slagroom, indien gewenst
- *Verwarm de oven voor op 160°C. Gebruik het mes om de boter en de poedersuiker zacht en schuimig te roeren. Smelt de chocolade en meng door het boter-suikermengsel. Voeg de eierdooiers één voor één toe en meng totdat er een romig mengsel is ontstaan. Klop vervolgens de eiwitten met kristalsuiker stijf en schuimig met behulp van het mes. Voeg dit schuim toe aan het mengsel en roer het er voorzichtig door. Schep vervolgens de bloem er met een spatel doorheen. Doe het deeg in een beboterd bakblik (24 cm). Bak één uur op 160°C. Laat de ovendeur de eerste 15 minuten op een kier staan.*
- *Laat de taart even afkoelen in het bakblik. Stort de taart dan op een taartrooster en laat hem verder afkoelen. Snijd de taart horizontaal door. Smeer de ene helft in met abrikozenjam en plaats de twee helften weer op elkaar. Verwarm de rest van de jam totdat deze siroopachtig is en smeer de bovenkant er mee in. Ga nu het glazuur klaarmaken. Kook het water, voeg de suiker en de chocolade toe en laat dit op laag vuur koken. Roer voortdurend tot een glad, smeerbaar mengsel ontstaat. Breng het glazuur aan op de taart en laat het afkoelen. Dien de taart op met toefjes geklopte slagroom.*



Soyamelk

Denne oppskriften kan bare lages med filter. Ikke lag mer enn én porsjon om gangen. La apparatet kjøles ned til romtemperatur før du fortsetter å bruke det.

- ▶ *Filtere er tilgjengelige under typenummer HR2938. Kontakt en Philips-forhandler.*

Ingredienser:

- 110 g tørkede soyabønner
- 1100 ml vann
- ▶ *Legg soyabønnene i bløt 4 timer før de skal tilberedes. La dem renne av seg.*
- ▶ *Legg soyabønnene i filteret. Hell 1100 ml vann i hurtigmikserkannen, og bland i 30 sekunder.*
- ▶ *Hell soyamelken i en kjele.*
- ▶ *Kok opp, tilsett sukker etter smak og la småkoke til alt sukkeret er smeltet.*
- ▶ *Serveres varm eller kald.*

Frisk fruktmilkshake

Ikke tilbered mer enn ett parti om gangen. La apparatet avkjøles til romtemperatur før du fortsetter tilberedningen.

Ingredienser:

- 100 g bananer eller jordbær
- 2 dl søtmelk
- 50 g vaniljeis
- smakes til med farin
- ▶ *Skrell bananene eller rens og fjern stilkene på jordbærene. Del frukten opp i mindre biter. Legg alle ingrediensene i hurtigmikserkannen. Bland til du får en jevn blanding.*
- ▶ *Du kan bruke den frukten du liker best til å lage frisk fruktmilkshake slik du vil ha den.*

Sjokoladecake

Ingredienser til deigen:

- 140 g mykt smør
- 110 g melis
- 140 g sjokolade
- 6 eggehviter
- 6 eggeplommer
- 110 g farin
- 140 g hvetemel
- 1 pakke bakepulver

Fyll:

- 200 g aprikosylltetøy

Glasur:

- 125 ml vann
- 300 g farin
- 250 g sjokolade
- eventuelt vispet krem

- ▶ *Varm ovnen til 160°C. Pisk smøret med melis ved hjelp av kniven. Smelt sjokoladen og ha den oppi. Legg til én og én eggeplomme, og bland til det er kremaktig. Pisk eggehviten sammen med farinen til det blir stivt og skumaktig ved hjelp av kniven. Ha den piskede eggehviten oppi blandingen, og rør forsiktig. Rør deretter i melet ved hjelp av slikkepotten. Ha kakeblandingen over i en smurt kakeform (24 cm). Stek i én time på 160°C. De første 15 minuttene kan ovnsdøren stå litt på gløtt.*

▶





SV | Recept



Sojamjöll

Detta recept kan endast tillagas med filtret. Bered inte mer än en omgång i taget. Låt apparaten svalna till rumstemperatur innan du fortsätter köra mixern.

- ▶ Filter finns att köpa med typnummer HR2938. Kontakta din Philips-återförsäljare.

Ingredienser:

- 110 gram torra sojaböner
- 1100 ml vatten
- ▶ Blötlägg sojabönorna i fyra timmar innan de tillreds. Låt dem rinna av.
- ▶ Lägg de blötlagda sojabönorna i filtret. Häll 1100 ml vatten i mixerkanan och mixa i 30 sekunder.
- ▶ Häll sojamjölken i en panna.
- ▶ Låta sojamjölken koka upp, tillsätt sedan socker tills det smakar gott och låt den sjuda tills allt socker har smält.
- ▶ Serveras varm eller kall.

Milkshake på färsk frukt

Kör inte mer än en omgång i taget. Låt apparaten svalna till rumstemperatur innan du fortsätter köra mixern.

Ingredienser:

- 100 gram bananer eller jordgubbar
- 2 dl färsk mjölk
- 50 gram vaniljglass
- grovt socker efter smak
- ▶ Skala bananerna eller skölj och noppa jordgubbarna. Skär frukt i mindre bitar. Lägg alla ingredienserna i mixerkanan. Mixa tills det är jämnt.
- ▶ Du kan använda vilken frukt du vill för att göra din favoritmilkshake på färsk frukt.

Chokladkaka

Till degen:

- 140 gram mjukt smör
- 110 gram florsocker
- 140 gram choklad
- 6 äggvitor
- 6 äggulor
- 110 gram strösocker
- 140 gram vetemjöl
- 1 paket bakpulver

Fyllningen:

- 200 gram aprikossylt

Glasyr:

- 125 ml vatten
- 300 gram socker
- 250 gram riven choklad
- vispgräddde, om så önskas
- ▶ Värm ugnen till 160°C. Rör smöret med florsockret med hjälp av kniven. Smält chokladen och blanda in. Tillsätt äggulorna en och en till smeten och blanda tills den är krämig. Vispa äggvitorna med strösockret med hjälp av kniven tills det är fast och skummigt. Tillsätt äggviteskummet till smeten och blanda sakta in det. Vänd sedan i mjöl med en degskrapa. Häll kaksmeten i en smord bakform (24 cm). Grädda i en timme vid 160°C. De första 15 minuterna bör ugnsluckan stå något på glänt.
- ▶ Låt kakan svalna en stund i bakformen och vänd den sedan på ett galler för att svalna ytterligare. Skär kakan horisontellt i två halvor, bre aprikossylt på ena halvan och lägg samman de två halvorna igen. Värm resten av sylten tills den blir sirapsaktig och bre ut den på ovensidan av kakan. Tillaga glasyren. Koka vatten, tillsätt socker och choklad, och koka på svag värme. Rör oavbrutet tills den har en jämn och utbredningsbar konsistens. Lägg glasyren på kakan och låt den svalna. Servera kakan med lite vispad gräddde



Soijamaito

Tämä resepti edellyttää suodattimen käyttöä. Käsittele vain yksi erä kerrallaan. Anna laitteen jäähtyä huoneenlämpöiseksi, ennen kuin jatkat käsittelyä.

- ▶ *Suodattimia on saatavana Philipsin jälleenmyyjiltä mallinumerolla HR2938.*

Aineet:

- 110 g kuivattuja soijapapuja
- 1 100 ml vettä
- ▶ *Liota soijapapuja 4 tuntia ennen käsittelyä. Valuta liika vesi pois.*
- ▶ *Laita liotetut soijapavut suodattimeen. Kaada 1 100 ml vettä tehosekoittimen kannuun ja sekoita 30 sekunnin ajan.*
- ▶ *Kaada soijamaito kattilaan.*
- ▶ *Kuumenna soijamaito kiehuksi, lisää sokeria maun mukaan ja anna kiehua hiljalleen, kunnes sokeri on sulanut.*
- ▶ *Tarjoa kuumana tai jäähdytettynä.*

Pirtelö

Käsittele vain yksi annos kerrallaan. Anna laitteen jäähtyä huoneenlämpöiseksi ennen jatkamista.

Aineet:

- 100 g banaania tai mansikoita
- 2 dl maitoa
- 50 g vaniljajäätelöä
- sokeria maun mukaan
- ▶ *Kuori banaanit tai huuhtelee mansikat ja poista niistä kannat. Leikkaa hedelmät pieniksi paloiksi. Laita kaikki aineet tehosekoittimen kannuun. Sekoita, kunnes juoma on tasaisesti vaahdotunut.*
- ▶ *Voit halutessasi käyttää pirtelössä myös muita tuoreita hedelmiä.*

Sacherkaku

Pohja:

- 150 g pehmeää voita
- 110 g tomusokeria
- 140 g suklaata
- 6 munanvalkuaista
- 6 munankeltuista
- 110 g kidesokeria
- 140 g vehnä jauhoja
- 1,5 tl leivinjauhetta

Täyte:

- 200 g aprikoosihilloa

Kuoritus:

- 125 ml vettä
- 300 g sokeria
- 250 g raastettua suklaata
- Lisänä: kermavaahtoa

- ▶ *Kuumenna uuni 160 °C:n lämpötilaan. Vatkaa voi ja tomusokeri terän avulla. Sulata suklaa ja sekoita se joukkoon. Lisää munankeltuaiset seokseen yksi kerrallaan ja sekoita, kunnes seos on kermamaista. Vaahdota munanvalkuiset ja kidesokeri kovaksi vaahdoksi terän avulla. Lisää valkuaisvahto seokseen ja sekoita varovasti. Sekoita jauhot lastan avulla. Laita taikina voideltuun kakkuvuokaan (24 cm). Paista tunnin ajan 160 °C:n lämpötilassa. Pidä uunin luukku hiukan raollaan ensimmäisten 15 minuutin ajan.*
- ▶ *Anna kakun jäähtyä hetken ajan vuoassa ja käännä se sitten ritilän päälle jäähtymään. Halkaise kakku vaakasunnassa, levitä alaosan päälle aprikoosihilloa ja yhdistä osat uudelleen. Kuumenna loppu hillo siirappimaiseksi ja levitä se kakun päälle. Valmista kuoritus. Kiehauta vesi, lisää sokeri ja suklaa ja hauduta miedolla lämmöllä. Sekoita jatkuvasti, kunnes kuoritus on rakenteeltaan tasaista ja helposti levitettävää. Levitä kuoritus kakun päälle ja anna sen jäähtyä. Tarjoile kakku kermavaahdon kera.*





Sojamælk

Denne opskrift kan kun tilberedes med brug af filteret. Tilbered ikke mere end én portion uden pause. Lad apparatet køle af til stuetemperatur, før du fortsætter med næste portion.

► *Filter fås hos din Philips-forhandler (typenr. HR2938).*

Ingredienser:

- 110 g tørrede sojabønner
- 1 l vand
- *Læg sojabønnerne i blød i 4 timer, inden de forarbejdes. Sæt dem til side, og lad dem dryppe godt af.*
- *Hæld de opblødte sojabønner i filteret. Hæld 1 l vand i blenderglasset, og blend i 30 sekunder.*
- *Hæld sojamælken op i en gryde.*
- *Varm sojamælken op, til den koger, tilsæt lidt sukker, og lad blandingen simre, indtil sukkeret er smeltet.*
- *Serveres varm eller kold.*

Milkshake med frisk frugt

Tilbered kun én portion ad gangen. Lad blenderen køle ned til stuetemperatur, inden du fortsætter med næste portion.

Ingredienser:

- 100 g bananer eller jordbær
- 2 dl frisk mælk
- 50 g vaniljeis
- sukker efter behag
- *Skræl bananerne, eller skyl jordbærrene og fjern stilken. Skær frugten i mindre stykker. Kom alle ingredienserne i blenderglasset. Blend, indtil blandingen har en blød konsistens.*
- *Du kan lave milkshake af enhver slags frugt.*

Chokoladekage

Ingredienser til dejen:

- 140 g blødgjort smør
- 110 g flormelis
- 140 g chokolade
- 6 æggehvider
- 6 æggeblommer
- 110 g sukker
- 140 g hvedemel
- 1 brev bagepulver

Fyld:

- 200 g abrikosmarmelade

Glasur:

- 1 1/4 dl vand
- 300 g sukker
- 250 g revet chokolade
- Flødeskum (kan udelades)
- *Opvarm ovnen til 160°C. Rør smør og flormelis sammen med knivenheden. Smelt chokoladen, og mix den i. Tilsæt æggeblommerne én ad gangen, og rør indtil blandingen er cremet. Pisk æggehvider og sukker ved hjælp af knivenheden, indtil de bliver stive og luftige. Vend de piskede æggehvider i blandingen. Vend derefter melet i med en spatel. Hæld dejen i en smurt kageform (24 cm) og bag den i en time ved 160°C. Lad ovnlågen stå lidt på klem de første 15 minutter.*
- *Lad kagen køle lidt af i formen, og vend den derefter ud på en bagerist for yderligere afkøling. Flæk kagen på langs, smør abrikosmarmelade på den ene halvdel, og læg kagen sammen igen. Opvarm resten af marmeladen, indtil den bliver sirupsagtig, og smør den ud over kagens overflade. Lav glasuren. Bring vandet i kog, tilsæt sukker og chokolade, og lad det simre ved svag varme under konstant omrøring, indtil konsistensen er blød og smørbar. Smør glasuren på kagen, og lad den køle af. Serveres med flødeskum.*







www.philips.com

Download from www.Somanuals.com. All Manuals Search And Download.

 100% recycled paper
100% papier recyclé

4203 064 14362

Free Manuals Download Website

<http://myh66.com>

<http://usermanuals.us>

<http://www.somanuals.com>

<http://www.4manuals.cc>

<http://www.manual-lib.com>

<http://www.404manual.com>

<http://www.luxmanual.com>

<http://aubethermostatmanual.com>

Golf course search by state

<http://golfingnear.com>

Email search by domain

<http://emailbydomain.com>

Auto manuals search

<http://auto.somanuals.com>

TV manuals search

<http://tv.somanuals.com>