

Projection Television

Instructions for use

9P5031C1

9P5531C1

9P6031C1

9P5034C1

9P5534C1

9P6034C1



Let's make things better.

PHILIPS **MAGNAVOX**

Return your Warranty Registration card today to ensure you receive all the benefits you're entitled to.

Once your PHILIPS MAGNAVOX purchase is registered, you're eligible to receive all the privileges of owning a PHILIPS MAGNAVOX product. So complete and return the Warranty Registration Card enclosed with your purchase at once. And take advantage of these important benefits.

Warranty Verification

Registering your product within 10 days confirms your right to maximum protection under the terms and conditions of your PHILIPS MAGNAVOX warranty.

Owner Confirmation

Your completed Warranty Registration Card serves as verification of ownership in the event of product theft or loss.

Model Registration

Returning your Warranty Registration Card right away guarantees you'll receive all the information and special offers which you qualify for as the owner of your model.

Congratulations on your purchase, and welcome to the "family!"

PHILIPS MAGNAVOX



Dear PHILIPS MAGNAVOX product owner:

Thank you for your confidence in PHILIPS MAGNAVOX. You've selected one of the best-built, best-backed products available today. And we'll do everything in our power to keep you happy with your purchase for many years to come.

As a member of the PHILIPS MAGNAVOX "family," you're entitled to protection by one of the most comprehensive warranties and outstanding service networks in the industry.

What's more, your purchase guarantees you'll receive all the information and special offers for which you qualify, plus easy access to accessories from our convenient home shopping network.

And most importantly you can count on our uncompromising commitment to your total satisfaction.

All of this is our way of saying welcome—and thanks for investing in a PHILIPS MAGNAVOX product.

Sincerely,

Robert Minkhorst
President and Chief Executive Officer

P.S. Remember, to get the most from your PHILIPS MAGNAVOX product, you must return your Warranty Registration Card within 10 days. So please mail it to us right now!

Know these safety symbols



This "bolt of lightning" indicates uninsulated material within your unit which may cause an electrical shock. For the safety of everyone in your household, please do not remove the product covering.

The "exclamation point" calls attention to features for which you should read the enclosed literature closely to prevent operating and maintenance problems.

WARNING: TO PREVENT FIRE OR SHOCK HAZARD, DO NOT EXPOSE THIS EQUIPMENT TO RAIN OR MOISTURE.

CAUTION: To prevent electric shock, match wide blade of plug to wide slot, and fully insert.

ATTENTION: Pour éviter les chocs électriques, introduire la lame la plus large de la fiche dans la borne correspondante de la prise et pousser jusqu'au fond.

PHILIPS MAGNAVOX Visit our World Wide Web Site at <http://www.philipsmagnavox.com>

SAFETY INSTRUCTIONS - Read before operating equipment

This product was designed and manufactured to meet strict quality and safety standards. There are, however, some installation and operation precautions which you should be particularly aware of.

1. **Read Instructions** - All the safety and operating instructions should be read before the appliance is operated.
2. **Retain Instructions** - The safety and operating instructions should be retained for future reference.
3. **Heed Warnings** - All warnings on the appliance and in the operating instructions should be adhered to.
4. **Follow Instructions** - All operating and use instructions should be followed.
5. **Water and Moisture** - The appliance should not be used near water - for example, near a bathtub, washbowl, kitchen sink, laundry tub, in a wet basement or near a swimming pool, etc.
6. **Carts and Stands** - The appliance should be used only with a cart or stand that is recommended by the manufacturer.
- 6A.  An appliance and cart combination should be moved with care. Quick stops, excessive force, and uneven surfaces may cause the appliance and cart combination to overturn.
- 6B. **Tilt/Stability** - All televisions must comply with recommended international global safety standards for tilt and stability properties of its cabinet design.
 - Do not compromise these design standards by applying excessive pull force to the front, or top, of the cabinet which could ultimately overturn the product.
 - Also, do not endanger yourself, or children, by placing electronic equipment/toys on the top of the cabinet. Such items could unsuspectingly fall from the top of the set and cause product damage and/or personal injury.
7. **Wall or Ceiling Mounting** - The appliance should be mounted to a wall or ceiling only as recommended by the manufacturer.
8. **Ventilation** - The appliance should be situated so that its location or position does not interfere with its proper ventilation. For example, the appliance should not be situated on a bed, sofa, rug, or similar surface that may block the ventilation openings; or, placed in a built-in installation, such as a bookcase or cabinet that may impede the flow of air through the ventilation openings.
9. **Heat** - The appliance should be situated away from heat sources such as radiators, heat registers, stoves, or other appliances (including amplifiers) that produce heat.
10. **Power Sources** - The appliance should be connected to a power supply only of the type described in the operating instructions or as marked on the appliance.

11. **Power-Cord Protection** - Power supply cords should be routed so that they are not likely to be walked on or pinched by items placed upon or against them, paying particular attention to cords and plugs, convenience receptacles, and the point where they exit from the appliance.
12. **Cleaning** - The appliance should be cleaned only as recommended by the manufacturer.
13. **Power Lines** - An outdoor antenna should be located away from power lines.
14. **Outdoor Antenna Grounding** - If an outside antenna is connected to the receiver, be sure the antenna system is grounded so as to provide some protection against voltage surges and built up static charges.

Section 810 of the National Electric Code, ANSI/NFPA No. 70-1984, provides information with respect to proper grounding of the mats and supporting structure grounding of the lead-in wire to an antenna discharge unit, size of grounding connectors, location of antenna-discharge unit, connection to grounding electrodes and requirements for the grounding electrode. See Fig. below.
15. **Non-use Periods** - The power cord of the appliance should be unplugged from the outlet when left unused for a long period of time.
16. **Object and Liquid Entry** - Care should be taken so that objects do not fall and liquids are not spilled into the enclosure through openings.
17. **Damage Requiring Service** - The appliance should be serviced by qualified service personnel when:
 - A. The power supply cord or the plug has been damaged; or
 - B. Objects have fallen, or liquid has been spilled into the appliance; or
 - C. The appliance has been exposed to rain; or
 - D. The appliance does not appear to operate normally or exhibits a marked change in performance; or
 - E. The appliance has been dropped, or the enclosure damaged.
18. **Servicing** - The user should not attempt to service the appliance beyond that described in the operating instructions. All other servicing should be referred to qualified service personnel.

Note to the CATV system installer: This reminder is provided to call the CATV system installer's attention to Article 820-40 of the NEC that provides guidelines for proper grounding and, in particular, specifies that the cable ground shall be connected to the grounding system of the building, as close to the point of cable entry as practical.

Example of Antenna Grounding as per NEC - National Electric Code

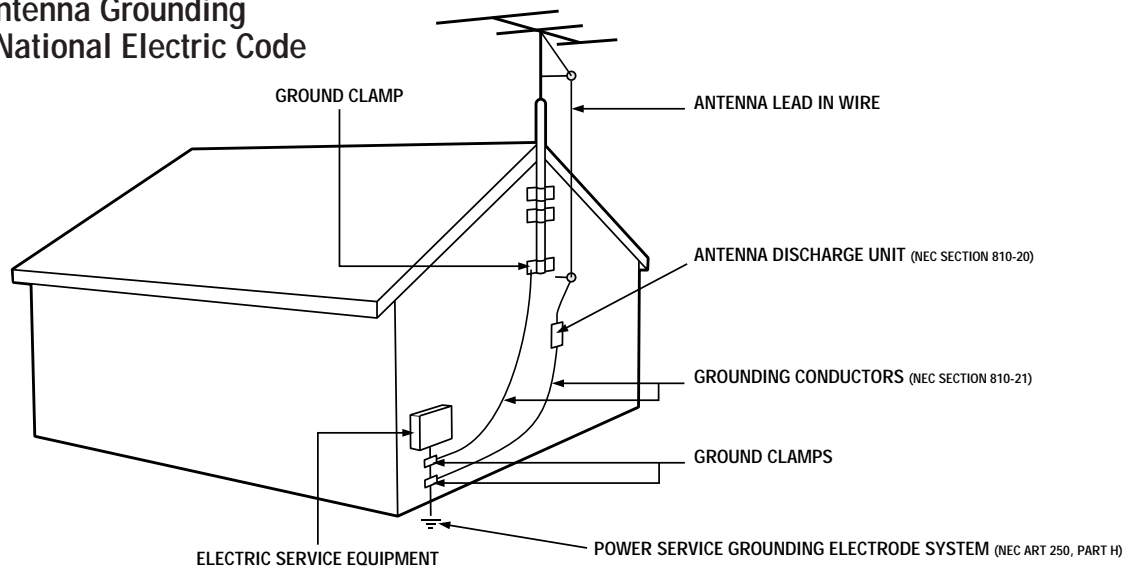

TABLE OF CONTENTS



Getting Started

Welcome/Product Registration	2
Safety/Precautions	3
Table of Contents	4
Features and Model Information.....	5



On-Screen Features

PICTURE MENU

◇ Adjusting Color, Brightness, Sharpness, Tint, and Picture Controls	6
◇ Using the Clearview Control.....	7
◇ Using the Flesh Correction Control	7
◇ Adjusting the TV's Convergence Control	8

FEATURES MENU

◇ Selecting a Picture Source	9
◇ Setting the TV for Closed Captioning.....	10
◇ Setting the TV for Cable or Antenna Signals....	11
◇ Adding Channels in Memory (Automatically) .	12
◇ Adding Channels in Memory (Manually)	13
◇ Setting the TV Clock.....	14
◇ Using the Time/Channel Reminder Control.....	14
◇ Turn-On Timer	15
◇ Using the Sleep Timer Control	15
◇ Using Parental Control/Content Advisory:	
• Code Setup/Blocking Channels.....	16-17
• Content Advisory - Movie Ratings	18-19
• Parental Guidelines.....	20
• Blocking Options/Review Settings.....	21
◇ Adjusting the Channel Display Control.....	22
◇ Using the Language Control	22

SOUND MENU

◇ Adjusting Bass, Treble, and Balance Sound Controls.....	23
◇ Setting the Bass Boost Control	23
◇ Setting the TV for Stereo and SAP Programs ..	24
◇ Using the Sound Image Control.....	25
◇ Using the Volume Display Control.....	25
◇ Using the TV Speaker On/Off Control with the Audio Output jacks	26
◇ Surround Sound Speaker Connections and Variable Audio Output Control	27
◇ Using the TV's Audio/Video Input and Output Jacks	28-31



Remote Control Operation

Using the Smart Picture Control	32
Using the Smart Sound Control	32
Using the Smart Surf Control and the Surf button...	33
Setting the TV Remote to Work Optional Accessory Devices:	
• Direct Entry/Code Number Method	34-35
• Search and Identify Method	36
• Remote Control Direct Entry Code Lists	37-38
Using the Remote's VCR buttons	39



Picture-In-Picture (PIP)

How to Use PIP (Connections)	40-41
How to Use PIP with the TV Remote.....	42
Selecting the Picture Source for PIP.....	43
Adjusting Picture-in-Picture Color and Tint.....	44
More PIP Connections (Cable Converter)	45



General Information

Tips if Something Isn't Working	46
TV Help Menu	47
Glossary of TV Terms	48
Index	49
Factory Service Locations	50-51
Warranty	52

SET-UP AND QUICK USE GUIDE

Use the simple Set-Up Guide (supplied with your TV information packet) for details on:

- Antenna Hook-ups
- First Time Set-Up (Automatic Settings)
- Basic TV and Remote Control Operation
- On-Screen Menu Use

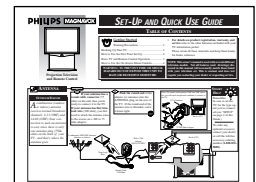

NOTE: This owner's manual is used with several different television models. Not all features (and drawings) discussed in this manual will necessarily match those found with your television set. This is normal and does not require you contacting your dealer or requesting service.

Because of continuous product improvements, the information mentioned in the documents accompanying your product are subject to change without notice.



First Time Set Up - automatically sets the TV for local channels and the correct picture signal (antenna or cable). See your Set-up and Quick Use Guide for details.

Infrared Remote Control - operates your TV set and a variety of wireless remote control VCRs, Cable TV Converters, and other accessory equipment.

Standard TV broadcast (VHF/UHF) or Cable TV (CATV) channel capability.

Closed Captioning - allows the viewer to read TV program dialogue or voice conversations as on-screen text.

Automatic Programming of channels - for quick and easy selection of favorite stations available in your area.

Picture-In-Picture (PIP) - can show a TV program and the direct video output from an accessory (VCR, etc.) onto the TV screen at the same time.

Stereo TV - with a built-in audio amplifier and a twin speaker system, reception of TV programs in both broadcast stereo sound or (SAP) bilingual broadcast are available.

On-Screen Features - display helpful information for the setting of TV controls (such as help messages, operating tips and glossary).

Parental Controls - for “censoring” or blocking out channels to keep children from watching undesirable programming.

Audio/Video Jacks - for direct connections with VCRs (and other accessories) for quality TV picture and sound playback. Component video Input connectors are also available for high fidelity color and picture resolution when using digital video source material, such as DVD.

Surround Sound - this TV set contains external audio speaker connections for a more dynamic sound effect.

Sleep-Timer - automatically turns the TV OFF at preset time intervals.

Smart Button - for the control of TV Sound and Picture levels. Use the Smart Button on the remote to quickly adjust Smart Sound (to set TV Volume levels during program changes or commercial breaks); Smart Picture (for programmed video level adjustments on a variety of program sources); and Smart Surf (for quick one button channel selection of up to 10 of your favorite channels).

Digital Ready - Projection Television capable of connecting to both the current analog television signals of today as well as interfacing with new upcoming digital source playback products and devices. This TV includes multiple signal connectors (Component Video, S-Video, Composite Video) which give you a variety of equipment playback options for digital set top boxes, satellite receivers, cable boxes, and other digital devices.

While there may exist some digital devices with connections not available on this television, you should be adequately prepared for the vast majority of products coming onto the digital consumer electronics' market. Note: You should always use the connection output on digital devices that gives the highest level of picture quality possible. As listed above the Component Video (or Y PB PR) input delivers the best color and picture reproduction; followed by S-Video; and then Composite Video. In addition to the above listed inputs, your television also includes the standard 75ohm cable signal connector for use with antennas or analog cable boxes.

As you unpack your TV please note that the following items have been included with your set:

- Owner's Manual
 - Safety Tip Information
 - Factory Service Center Locations
- Warranty Registration Card
- Remote Control Transmitter
- Batteries for Remote Control Use

Please take a few minutes to complete your registration card. The serial number for the TV is on the back of the set.

Refer to the back of this manual for instructions on the cleaning and care of the TV.

End-of-Life disposal

Your new projection television and its packaging contain materials that can be recycled and reused. Specialized companies can recycle your product to increase the amount of reusable materials and minimize the amounts which need to be properly disposed.

Your product also uses batteries which should not be thrown away when depleted, but should be handed in and disposed of as small chemical waste.

Please find out about the local regulations on how to dispose of your old television, batteries, and packaging materials whenever you replace existing equipment.

PICTURE MENU CONTROL ADJUSTMENTS

COLOR, BRIGHTNESS, SHARPNESS, TINT, PICTURE

To adjust your TV color and picture controls, select a TV channel and follow the steps shown below:

BEGIN

- 1 Select **BRIGHTNESS, PICTURE, COLOR, TINT, or SHARPNESS** picture control.

With the PICTURE MENU on screen, move the RED highlight with the MENU  buttons. Then press the MENU (M) button.

- 2 Press the (+) or (-) buttons to adjust the selected control.

- 3 Press the STATUS button to clear the screen.



SMART HELP



Remember. When the bar scale is centered, control settings are at normal mid-range levels.

BRIGHTNESS Press (-) or (+) until dark parts of the picture show good detail.

PICTURE Press (-) or (+) until whitest parts of the picture are as bright as you prefer.

COLOR Press (-) or (+) to add or eliminate color.

TINT Press (-) or (+) to obtain natural skin tones. (Also see Flesh Correction on page 7 for more information).

SHARPNESS Press (-) or (+) to improve detail in the picture.

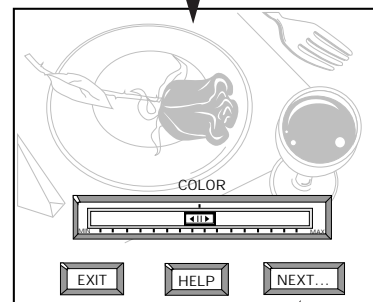
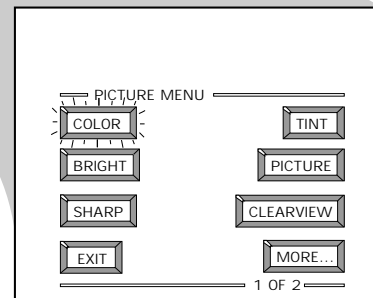
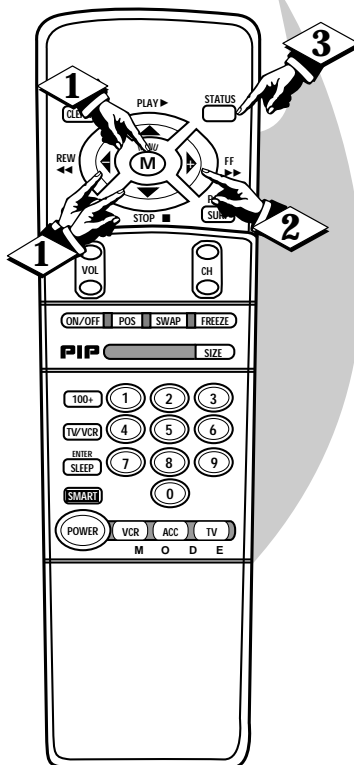
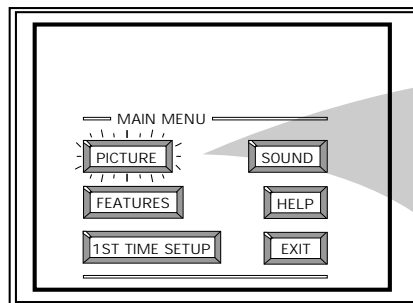

Select and then press MENU (M) button to view an explanation of the selected feature.

Select and then press MENU (M) button to view additional controls grouped under same feature heading. For Example: Tint, Brightness, Picture, etc.

CLEARVIEW

*C*learview is a sharpness feature which smoothes out background snow (or picture noise) without losing picture image detail or crispness.

(BEGIN)

- 1 Select **CLEARVIEW** control.

With the PICTURE MENU on screen, move the RED highlight with the MENU $\blacktriangle/\blacktriangledown$ buttons. Then press the MENU (M) button.

- 2 Press the MENU $\blacktriangle/\blacktriangledown$ buttons to move the RED highlight. Press the MENU button to select (✓) the ENHANCED mode.

- 3 Press the **STATUS** button to clear the screen.

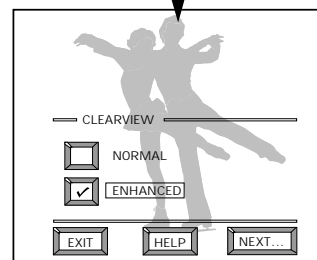
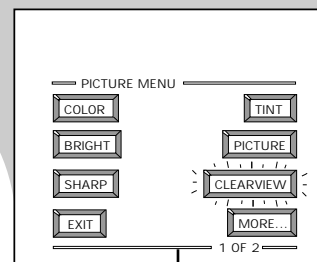
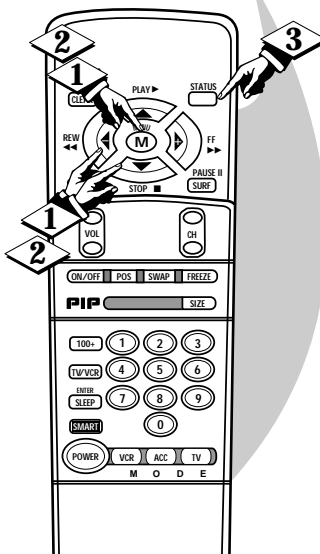
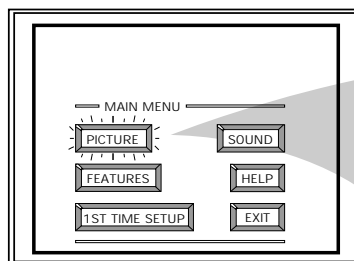

FLESH CORRECTION

*U*se the Flesh Correction control to keep skin tone hues (or facial tint) from varying from TV channel to TV channel.

(BEGIN)

- 1 Select **FLESH CORRECTION** control.

With PICTURE MENU (2 of 2) on screen, move the RED highlight with the MENU $\blacktriangle/\blacktriangledown$ buttons. Then press the MENU (M) button.

- 2 Press the MENU $\blacktriangle/\blacktriangledown$ buttons to move the RED highlight. Press the MENU button to turn (✓) the FLESH CORRECTION control ON.

- 3 Press the **STATUS** button to clear the screen.

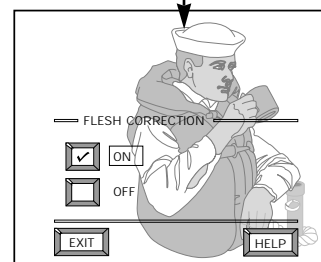
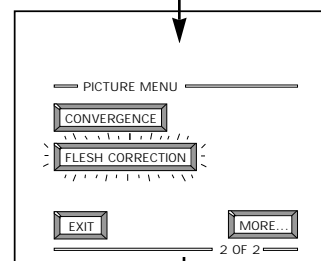
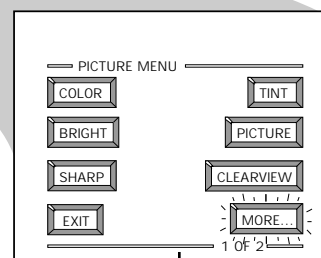
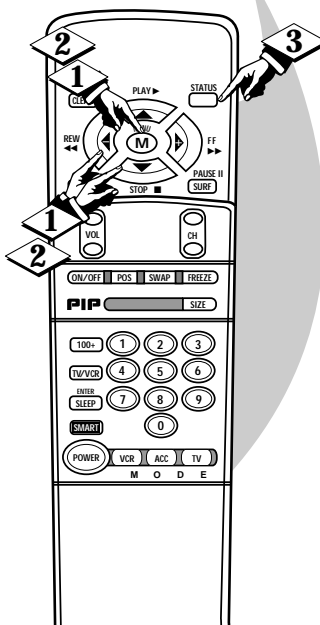
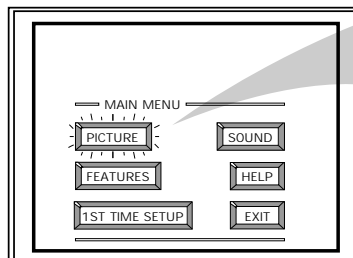

RED/BLUE CONVERGENCE

Convergence is the correct lining up of the red and blue light paths on the TV screen.

NOTE: If no color fringing (see Smart Help) shows, then no Convergence adjustments are necessary for your TV.

BEGIN

- 1 Select **CONVERGENCE** control.

With PICTURE MENU (2 of 2) on screen, move the RED highlight with the MENU  buttons. Then press the MENU (M) button.

- 2 If there is **RED or BLUE** color fringing on the White cross, press the MENU button to continue.

- 3 Press the MENU  buttons to move the red or blue cross directly over the white cross on the TV screen.

The red or blue cross is properly adjusted when it is completely merged with the white cross. (No color appears around the edge of the white cross).

- 4 Press the **STATUS** button to clear the screen when convergence adjustments are complete.



SMART HELP

 Remember. Convergence has been set at the factory for best viewing, but if one or more of the (red or blue) colors appear around the edges of objects (color fringing) follow the steps given in this section.

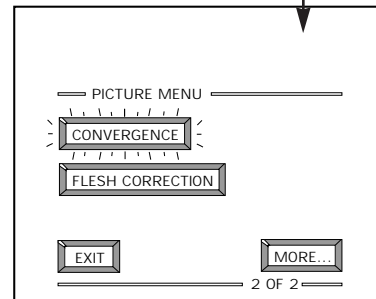
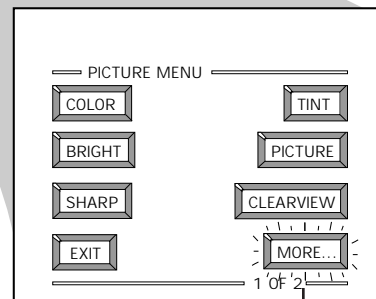
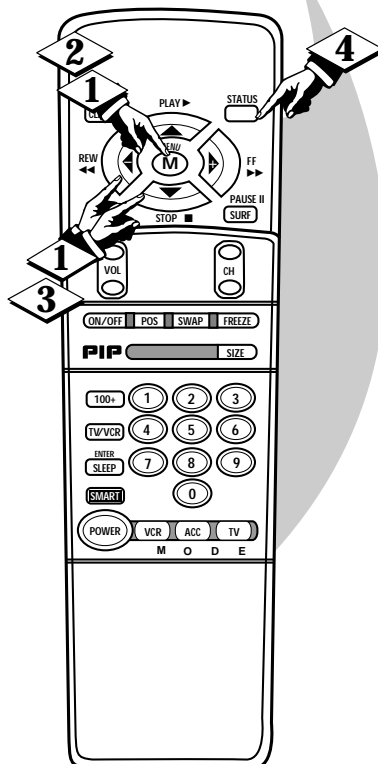
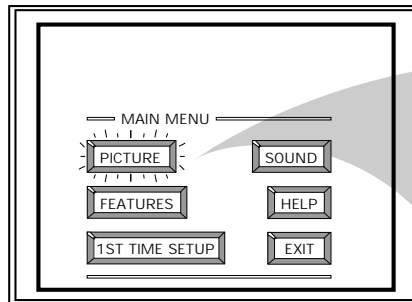

If there is **RED or BLUE** fringe on the **WHITE** cross, use this adjustment to improve the picture.

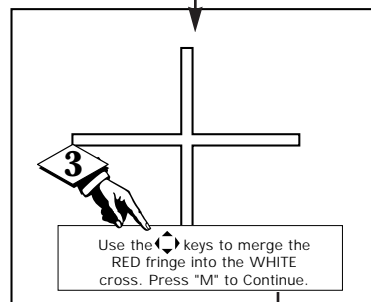
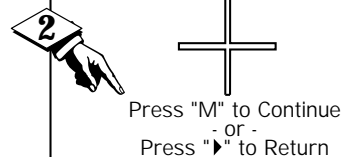

NOTE: Adjustments for "Multi-Point" on-screen color fringing can also be made as part of the TV's Convergence control system. Follow the TV's on-screen menu directions to select individual screen areas that can be readjusted and set for varying red/blue color fringing conditions. These multi-point settings can then be "Saved" to memory for the specific areas of the TV screen (or Factory Settings for convergence can be recalled and put back into place for use).

MULTI-POINT CONVERGENCE

Use the  keys to adjust

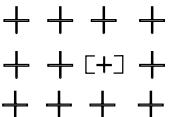
 Press "M" to Adjust or
 Press "STATUS" to Continue

Press "M" to Save
Press "▶" to Undo

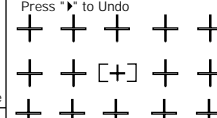
 Press "▲" to
 recall Factory Settings

PICTURE SOURCE

The picture for the TV can come through either the ANTENNA plug or the AUDIO/VIDEO Input jacks (on the rear of the TV). The Picture Source control simply tells the TV which one of these picture sources it is to show on the TV screen.

BEGIN

- 1 Select **PICTURE SOURCE SELECT** control.

With the FEATURES MENU on screen, move the RED highlight with the MENU $\blacktriangle/\blacktriangledown$ buttons. Then press the MENU (M) button.

- 2 Press the MENU $\blacktriangle/\blacktriangledown$ buttons to move the RED highlight. Press the MENU button to turn the desired PICTURE SOURCE control ON (\checkmark).

ANTENNA- for a picture signal coming from the ANTENNA plug on the TV.

AUX 1 VIDEO- for a picture signal coming from the AUX 1 Video Input jack on the rear of the TV.

AUX 1 Y Pb Pr- for picture signals coming from the component (Y Pb Pr) luminance and color input jacks on the rear of the TV.

AUX 2 VIDEO- for a picture signal coming from the AUX 2 Video Input jack on the rear of the TV.

- 3 Press the **STATUS** button to clear the screen.

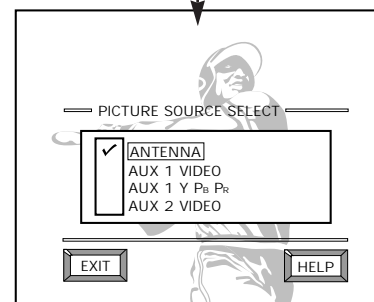
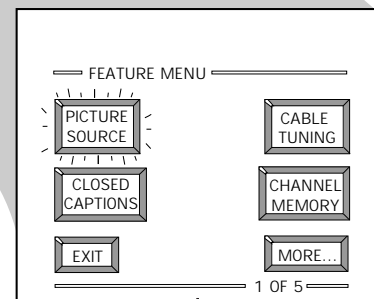
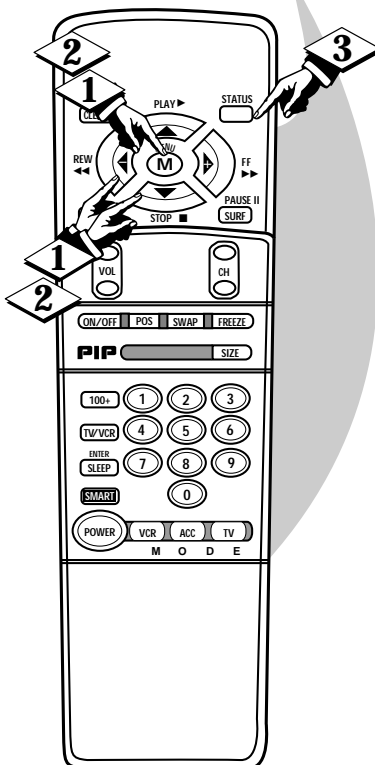
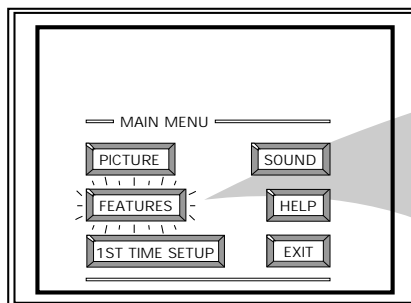

SMART HELP



Remember, the Auxiliary Input modes (AUX 1 VIDEO, etc.) must have a compatible video signal source properly connected (to the INPUT plug on the rear of the TV), or the TV screen will be blank.

FEATURE MENU CONTROLS (CONTINUED)

CLOSED CAPTION

Closed Captioning (CC) allows you to read the voice content of television programs on the TV screen. Designed to help the hearing impaired this feature uses on-screen "text boxes" to show dialogue and conversations while the TV program is in progress.

(BEGIN)

- 1 Select **CLOSED CAPTIONING** control.

With the FEATURES MENU on screen, move the RED highlight with the MENU \blacktriangle / \blacktriangledown buttons. Then press the MENU (M) button.

- 2 Press the MENU \blacktriangle / \blacktriangledown buttons to move the RED highlight. Press the MENU button to select (\checkmark) the desired Closed Caption mode - For Example: "ALWAYS ON" and "CAPTION 1".

CAPTION 1, 2, 3, 4:

dialogue (and descriptions) for the action on the captioned TV program shows on-screen. (See Important Note on this page.)

TEXT 1, 2, 3, 4:

often used for channel guide, schedules, or bulletin board information for CC programs.

- 3 After making your Caption mode selection, press the **STATUS** button to clear the TV screen. The selected Closed Caption mode will be active.

To cancel, set the Closed Captioned feature to OFF when finished viewing.



SMART HELP



Remember. Broadcast stations will often use spelling abbreviations, symbols, dropouts and other grammatical shortcuts in order to keep pace with the on-screen action. These type factors vary upon the source of the captioned text material and do not indicate a need for service on the part of the TV.

NOTE: Not all TV programs and product commercials are made for broadcast with Closed Caption (CC) information included. Neither are all Closed Caption modes (CAPTION 1-4; or TEXT 1-4) necessarily being used by a broadcast station during the transmission of a closed caption program. Usually "CAPTION 1" is the most used mode to view captioned material. Refer to your area's TV program listings for the stations and times of Closed Caption shows.

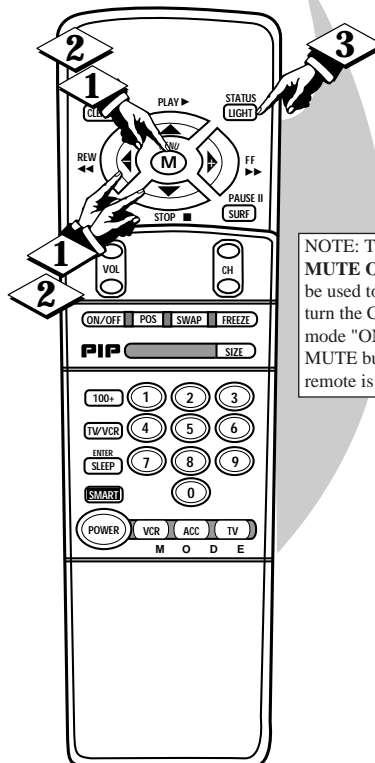
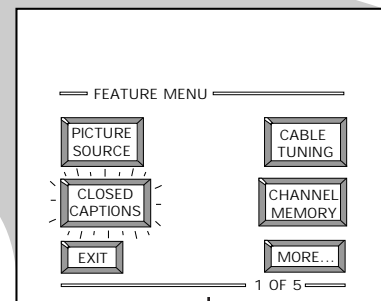
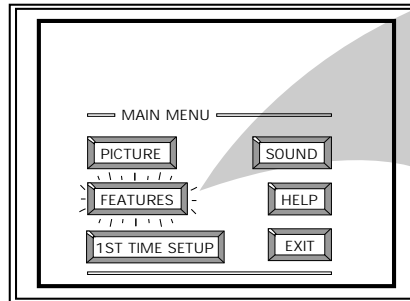

NOTE: The **ON DURING MUTE ONLY** control can be used to set the TV to turn the Closed Caption mode "ON" whenever the MUTE button on the remote is pressed.

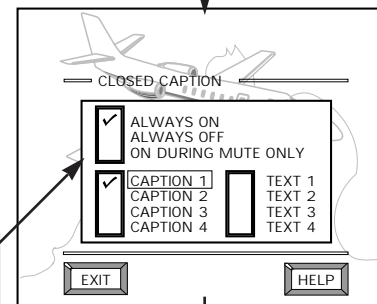

CAPTION 1 mode
Example Screen Display

Closed Caption information will usually appear in black and white (although some broadcasters or networks may occasionally use color to highlight or draw attention to certain areas.)

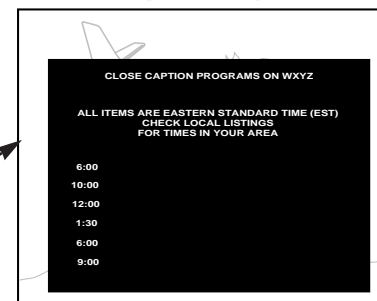

FULL SCREEN TEXT
will block TV screen from viewing

This symbol will appear on channels that contain Closed Captioning material whenever the status display is shown.



CABLE TUNING

NOTE: If you went through *First Time Setup* (in your *Quick Use Guide*), this task has already been completed for you. You need to make sure the TV is set to pick up either *Cable TV* or *Antenna* signals. In other words, the TV needs to know if you connected a *Cable TV* signal or a normal antenna to its **ANTENNA** plug.

BEGIN

1 Select **CABLE CHANNEL TUNING** control.

With the **FEATURES** MENU on screen, move the **RED** highlight with the **MENU**  buttons. Then press the **MENU (M)** button.

2 Press the **MENU** buttons to move the **RED** highlight. Press the **MENU** button to select () the desired mode - For Example: **CABLE**.

CABLE- If you **DO** have **Cable TV** connected to the TV. Channels 1-125 are available.

NORMAL- If you have an **Antenna** connected to the TV. Channels 2-69 are available.

3 Press the **STATUS** button to clear the screen.

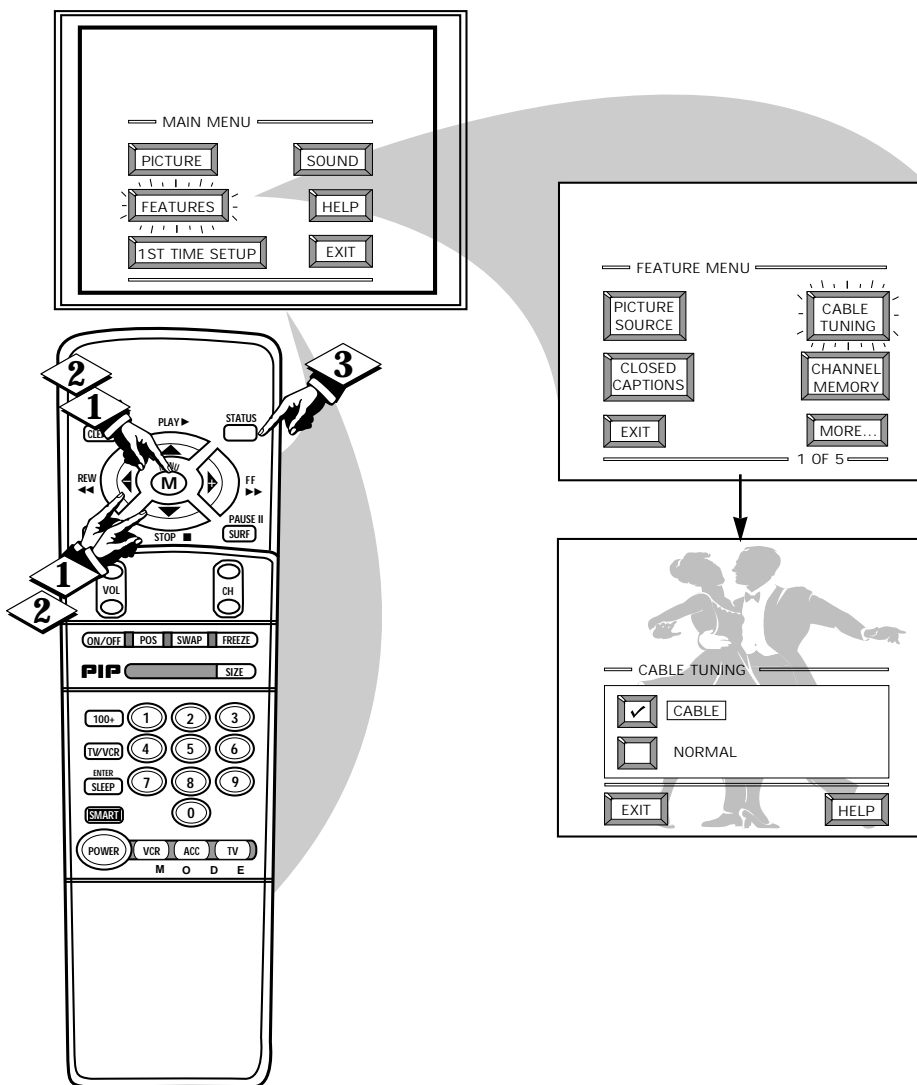

CHANNEL MEMORY

AUTO-PROGRAMMING

NOTE: If you went through First Time Setup (in your Quick Use Guide), this task has already been completed for you.

Your TV can automatically set itself for local area (or Cable TV) channels. This makes it easy for you to select only the TV stations in your area when the CHANNEL ▲▼ buttons are pressed.

BEGIN

- 1 Select CHANNEL MEMORY (START AUTO-PROGRAMMING) control.

With the FEATURES MENU on screen, move the RED highlight with the MENU ▲▼ buttons. Then press the MENU (M) button.

- 2 Press the MENU button to turn AUTO-PROGRAMMING ON.

The TV shows which channel numbers are "SAVED" (✓) as they are added into memory.

"Auto-programming CHANNEL MEMORY is finished" shows when the TV is through adding channels.

- 3 Press the STATUS or Menu (M) button to clear the screen.



SMART HELP



Try it out. Press the CHANNEL ▲▼ buttons and see which channels you can select.

Remember. An Antenna or Cable TV signal must first be connected to your TV so that channels can be saved.

If you want to delete any unwanted channels from the TV's memory, see "ADD/DELETE CHANNELS" on the next page.

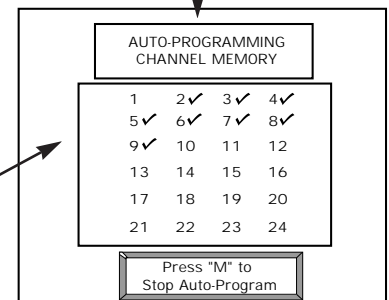
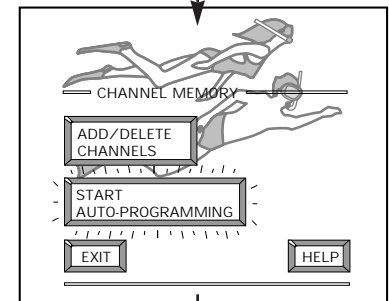
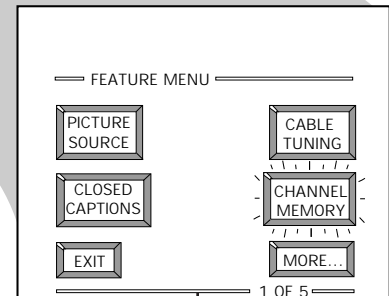
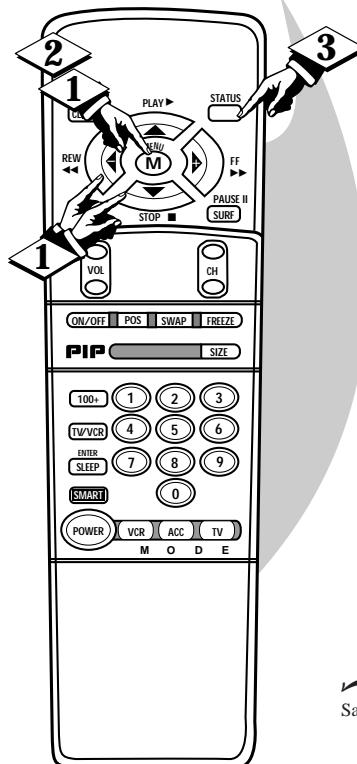
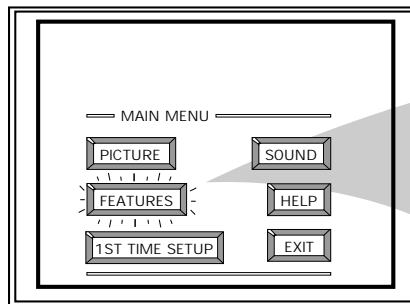

✓ Channel Numbers are Saved in Memory

ADD/DELETE CHANNELS

Auto-Programming (see previous page) adds all the channels it can find (on your Antenna or Cable TV system) into the TV's memory. Add/Delete Channels makes it easy for you to add other channels, or drop unwanted channels, from the list of channels in the TV's memory.

BEGIN

- 1 Select **CHANNEL MEMORY (ADD/DELETE CHANNELS)** control.

With the **FEATURES MENU** on screen, move the **RED** highlight with the **MENU**  buttons. Then press the **MENU (M)** button.

- 2 Press the **CHANNEL ▲▼** or **number buttons** to select the channel you want to add or delete.

- 3 Press the **MENU ►** button to **ADD** the channel into the TV's memory.

Press the **MENU ◀** button to **DELETE** the channel from memory.

Repeat steps 2 and 3 for each channel you wish to add or delete.

- 4 Press the **STATUS** or **MENU** button to clear the screen.

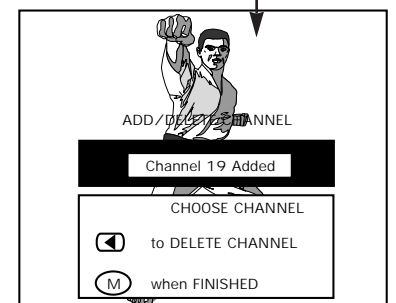
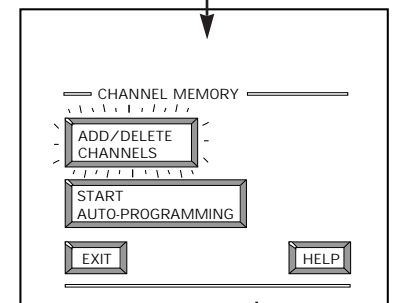
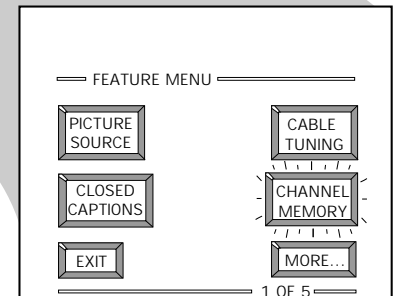
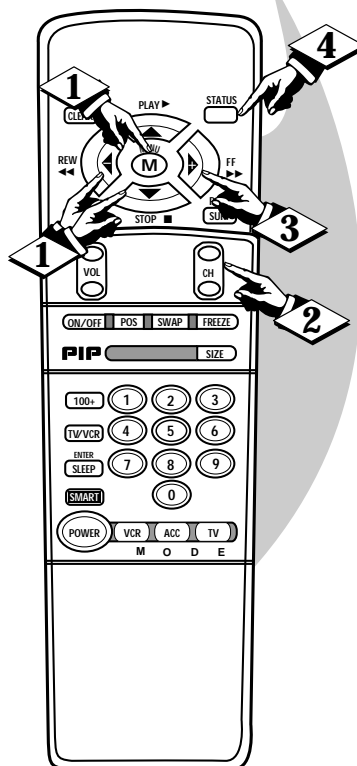
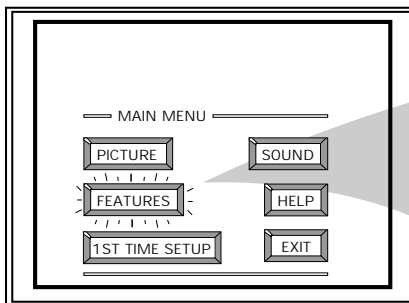

SMART HELP



Remember. You can also add the **AUX 1 VIDEO**, **AUX 2 VIDEO**, or **AUX 1 Y Pb Pr**, modes just like a channel. Then by pressing the **CHANNEL ▲▼** buttons the **AUX(i)ary** mode can quickly be selected to use the desired set of Input jacks (see page 28).

Note: **AUX(i)ary VIDEO** modes are located between the lowest and highest channel numbers within the **ADD/DELETE CHANNEL** control screen.

FEATURE MENU CONTROLS (CONTINUED)

SET CLOCK

NOTE: If you went through *First Time Setup* (in your *Quick Use Guide*), this task has already been completed for you.

Your TV comes with an on-screen clock. During normal operation the clock appears on the screen with every channel change (and when the **STATUS** button is pressed).

BEGIN

- 1 Select **SET CLOCK** control. With **FEATURES MENU** (2 of 5) on screen, move the **RED** highlight with the **MENU** buttons. Then press the **MENU** (M) button.
- 2 Press the remote's **number buttons** to set the time clock. The remote's **MENU** buttons can also be used to set the hours, minutes and AM/PM portions of the clock.
- 3 Press the **STATUS** button to set the clock in operation and clear the screen.

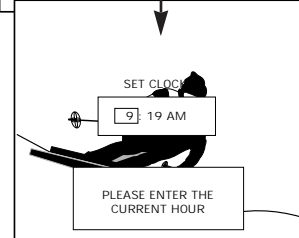
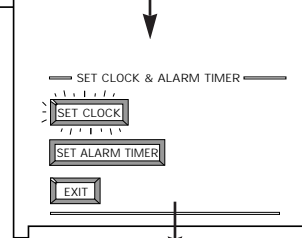
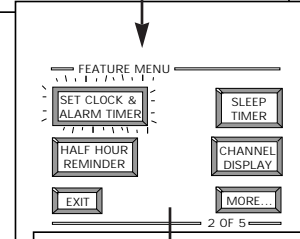
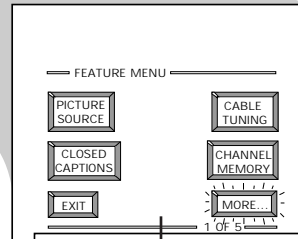
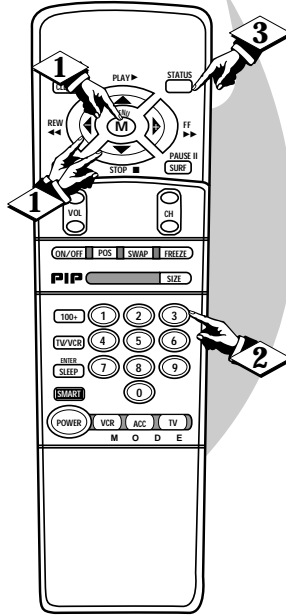
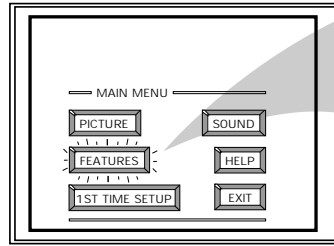

SMART HELP



Remember, be sure to press "0" first and then the hour number for single digit entries. TV Clock settings may be lost when the TV is unplugged (or AC power to the set is interrupted).

HALF HOUR REMINDER

With the *Half Hour Reminder* control the TV automatically shows you the current time and channel every thirty minutes.

BEGIN

- 1 Select **HALF HOUR REMINDER** control. With **FEATURES MENU** (2 of 5) on screen, move the **RED** highlight with the **MENU** buttons. Then press the **MENU** (M) button.
- 2 Press the **MENU** and **MENU** (M) buttons to highlight and select (✓) the **EVERY HALF HOUR** item.
- 3 Press the **STATUS** button to clear the screen.

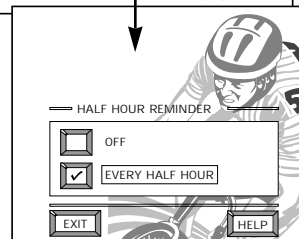
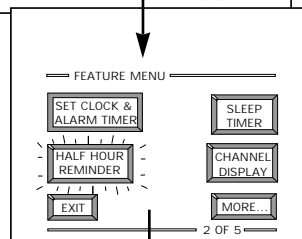
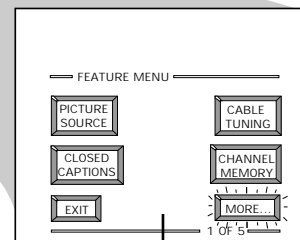
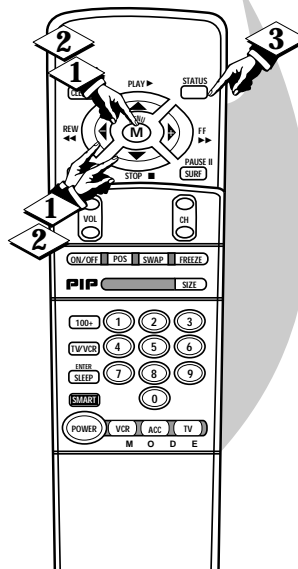
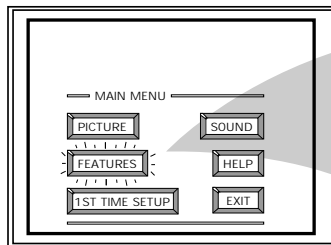

SMART HELP



Remember, the Time and Channel Reminders will show on the hour and the half-hour for several seconds.

SET ALARM TIMER

Just like an alarm clock you can set the TV to turn itself on at the same time everyday.

BEGIN

- 1 Select **SET ALARM TIMER** control.

With FEATURES MENU (2 of 5) on screen, move the RED highlight with the MENU (M) buttons. Then press the MENU button.

- 2 Press the MENU and MENU (M) buttons to highlight and select "ON" ().

- 3 Press the MENU and then the MENU (M) buttons to select "SET ALARM TIME".

- 4 Press the remote's number buttons to set the "TURN ON" time for the TV. (Press MENU for AM or PM.)

- 5 Press the STATUS button to set the "ALARM TIME" and clear the screen.

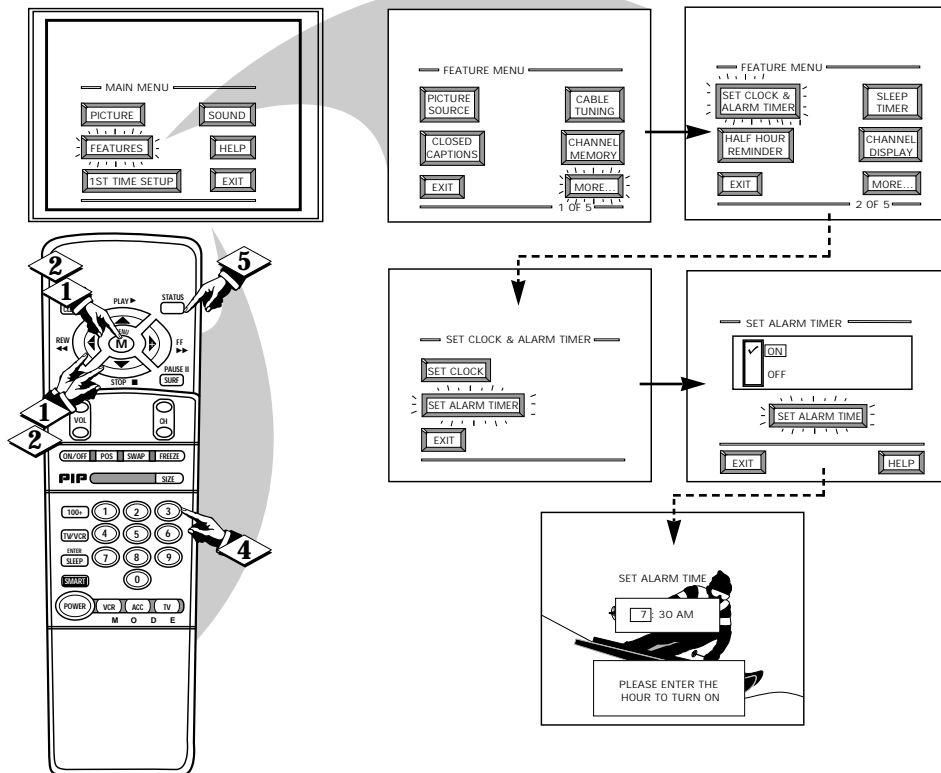

SLEEP TIMER

Have you ever fallen asleep in front of the TV only to have it wake you up at two in the morning with a test pattern screeching in your ears? Well, your TV can save you all that trouble by automatically turning itself off.

BEGIN

- 1 Press the **SLEEP** button on the remote control.

Note: you can also select the SLEEP control with the TV's on-screen FEATURES MENU (2 of 5). Move the RED highlight with the MENU (M) buttons. Then press the MENU button.

- 2 Press the **SLEEP** button repeatedly to pick the amount of time (15 minutes to 2 hours ahead) before the TV will turn itself off.

The (+), (-) buttons can also be used to set the amount of time.

- 3 Press the **STATUS** or MENU (M) button to clear the screen after you have set the time for the TV to turn off.

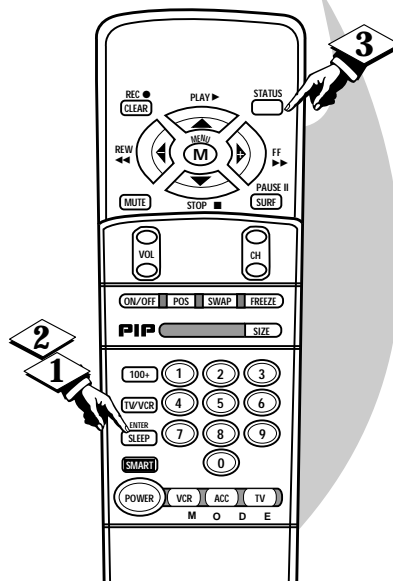
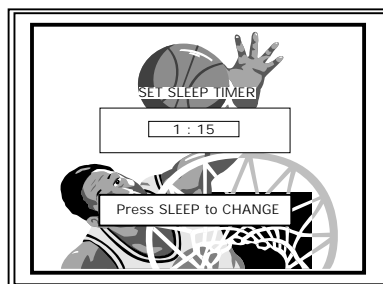

SMART HELP



Remember, to see how many minutes are left before the TV shuts itself off, reselect the SLEEP TIMER control screen.

To stop a SLEEP TIMER setting, reset the timer back to OFF. (Turning the TV off and on, or pressing a button during the last minute of a timer setting, will also cancel a setting.)

A few seconds before the TV is to shut off a message will come on the screen telling you **GOOD NIGHT**.

PARENTAL CONTROL SETUP CODE NUMBER

Parental Control allows parents to block out, or "censor", any channels they think children should not watch. A channel placed under Parental Control cannot be viewed until a correct access code is used to unlock the channel for viewing.

First let's set your Parental Code:

(BEGIN)

1 Select the PARENTAL CONTROL.

With FEATURES MENU (3 of 5) on screen, move the RED highlight with the MENU \blacktriangledown buttons. Then press the MENU (M) button.

2 Press the MENU \blacktriangle and MENU (M) buttons to highlight and select the SETUP CODE item.

3 Press 0, 7, 1, 1 on the remote.

"XXXX" shows on the ACCESS CODE SETUP screen as you press the number buttons.

"INCORRECT ACCESS CODE - TRY AGAIN" will also show on the screen.

4 Press 0, 7, 1, 1 on the remote again.

"Next Enter Your New Access Code" shows on the screen.

5 Enter a new four digit number code using the remote.

"Access Code Changed" shows on the screen to let you know the new code has been set.

Continue to the next page to find out how to "BLOCK" channels from viewing.

NOTE: Your TV left the factory with the Parental Code set to "0000". If you are using your TV and the Parental Control for the first time, and don't want to SETUP a new Access code number, you can use the "0000" number to block channels - see next page. The "0711" Parental Code (shown on this page) is given as a default or way to reset the Code when the current Access number is not known.

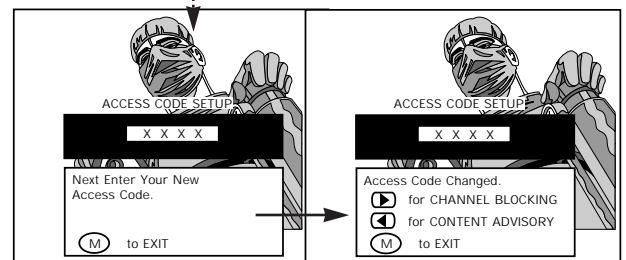
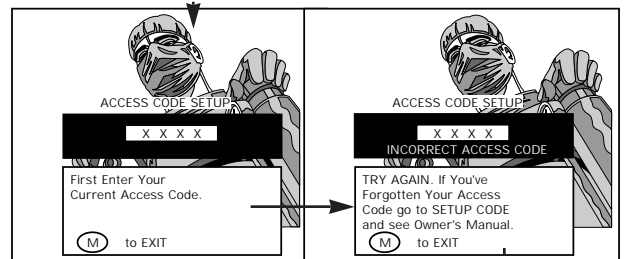
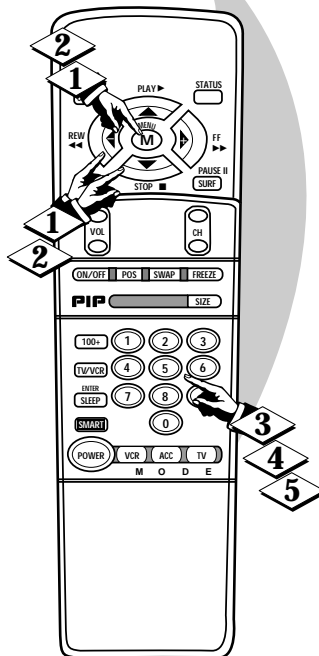
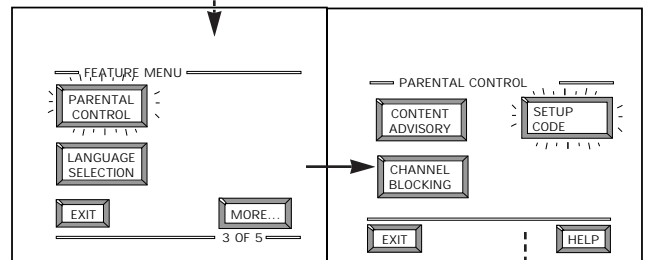
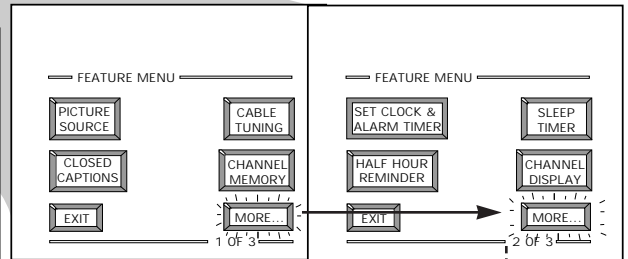
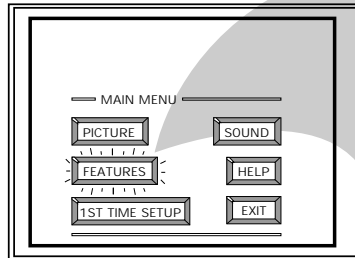

- Press MENU \blacktriangleright to go on and start to "block" channels.
- Press MENU \blacktriangleleft to go to "Content Advisory" (or TV and Movie Ratings system of channel blocking).
- Press MENU to return to the Parental Control Menu screen.
- Press STATUS to clear the screen.

SMART HELP

Note to Parents - it isn't possible to unlock or defeat your Censor Access Code without changing to a new code number. So if your Code number changes, and you didn't change it yourself, then you will know that someone has altered the code and the blanked out channel has been viewed.

PARENTAL CONTROL CHANNEL BLOCKING

After you Setup your personal Parental Access Code number (see previous page), you are now ready to select the channels you want to block out or censor from viewing.

BEGIN

1 Select the CHANNEL BLOCKING control.

With FEATURES MENU (3 of 5) on screen, move the RED highlight with the MENU \blacktriangledown buttons. Then press the MENU (M) button.

2 Press the MENU \blacktriangle and MENU (M) buttons to highlight and select the CHANNEL BLOCKING Menu item.

3 Enter the correct Parental Code number (see previous page).

4 Press Channel \blacktriangle or Channel Number buttons to select the channel you want to block.

5 Press the MENU \blacktriangleright button to "BLOCK VIEWING" on the selected channel. Press the MENU \blacktriangleleft button to "ALLOW VIEWING" on a blocked channel.

Repeat steps 4 and 5 for any other channels you wish to block out.

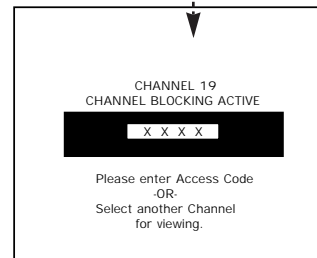
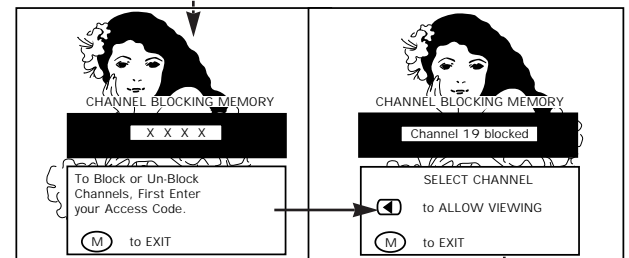
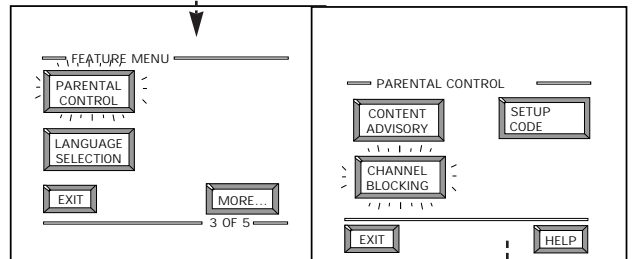
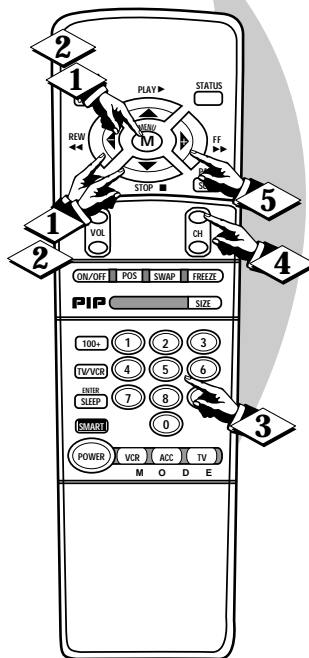
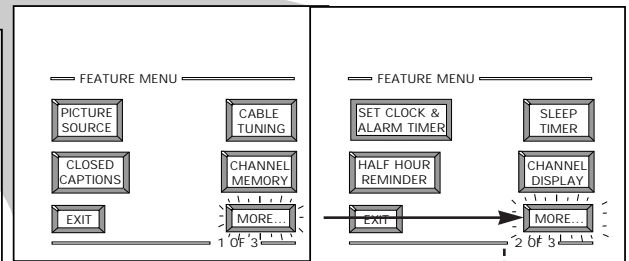
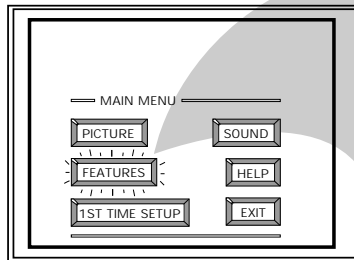

Note: You can also block out the use of the Audio/Video Input jacks on the rear of the TV. This stops the viewing of VCR programs which can be shown through the A/V IN jacks. Just select AUX 1 or AUX 2 VIDEO (located between the lowest and highest channel numbers) on the Channel Blocking screen, and select "blocked".

BLOCKED CHANNEL SCREEN MESSAGE
(Appears when an attempt to select a blocked channel is made and Parental Control is ON.)

SMART HELP



Remember, to make TV viewing easier all channels (and Audio/Video Input jacks) will be unblocked, once the correct Parental Code number has been entered.

When the TV is turned OFF and then back ON again, Parental Control is back in place for all channels.

PARENTAL CONTROL CONTENT ADVISORY

Another new area available to parents for the censoring of program material is through the TV Guidelines and Movie Ratings system. Program Content Advisory data will soon be contained within the broadcast signals of received TV programs. When setup by the parent or viewer, the TV can respond to transmitted advisory data by blocking out or denying access to TV shows (based on whether the program meets or exceeds the limitations you select as viewable). The TV program can then only be viewed by entering the correct and current Parental Code Access number.

The Content Advisory system uses both "Movie Ratings" and a "Parental Guidelines" form of censoring. Refer to the following page sections for explanations on the different Rating system levels and their uses.

BEGIN

1 Select the CONTENT ADVISORY Menu option

With PARENTAL CONTROL Menu on screen, move the RED highlight with the MENU  buttons. Then press the MENU (M) button.

A Parental Guideline/Movie Rating status screen will appear with a review of currently BLOCKED Content Advisory categories.

2 Press the MENU button to select the ENTER ACCESS CODE Menu item.

3 Enter the correct Parental Code number (see note at the top of this page).

"CONTENT ADVISORY" Menu screen appears. Parental Guidelines, Movie Ratings and other blocking control items are ready for selection and use.



Note: Please remember that a valid and current Access Code number will be required in the setup and use of the TV's "Content Advisory" system. Review the previous **SETUP CODE** section on how to obtain a valid Parental Access Code number before attempting to make adjustments within the Movie Ratings and Parental Guidelines system.

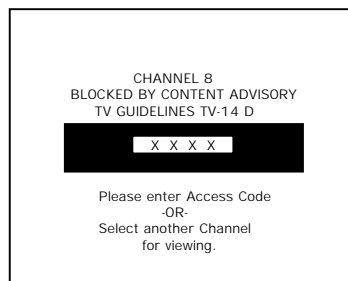
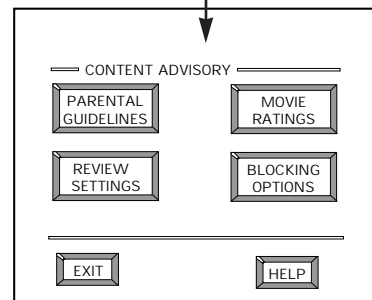
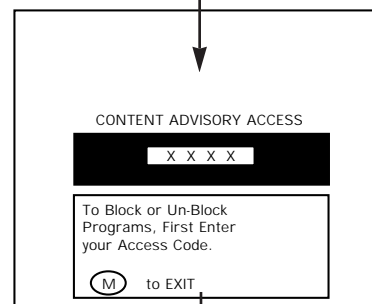
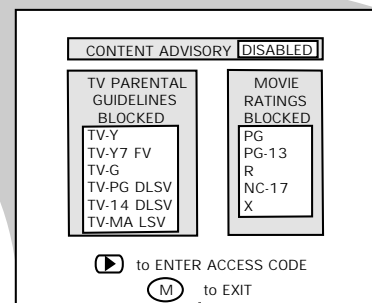
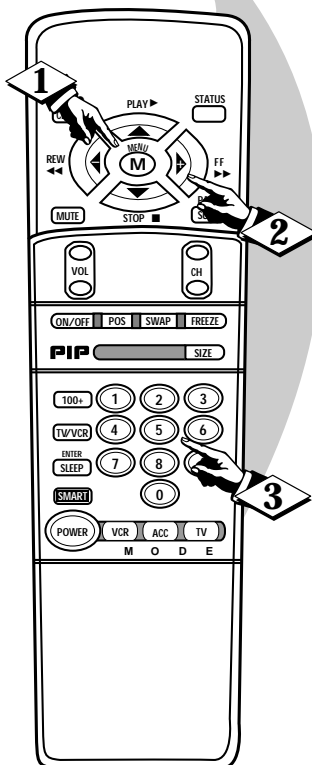
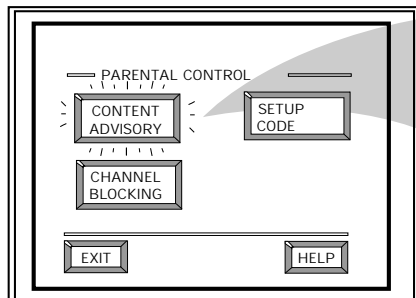

NOTE: In normal Content Advisory system operation the TV screen will display a message when programming is blocked by a Movie Rating, Parental Guideline, or Blocking Option control feature. Entering the correct ACCESS CODE number will unblock all the blocked Content Advisory Rated channels until the TV is turned Off. The blocked Advisory Ratings will be back in place when the TV is turned back On again.

CONTENT ADVISORY MOVIE RATINGS

Movie Ratings set viewing access levels for TV programming according to current Motion Picture Association of America (MPAA) ratings. These ratings are similar to the categories used with the rated movies appearing in cinema theaters and with video rental material.

BEGIN

1 Select the **MOVIE RATINGS** Menu option.

With **CONTENT ADVISORY** Menu on screen, move the **RED** highlight with the **MENU**  buttons. Then press the **MENU** (M) button.

2 Press the **MENU**  and **MENU (M)** buttons to highlight and select (✓) the desired **MOVIE BLOCKING** level.

When in operation a “Blocked - Movie Rating” TV screen appears when movies are received which include the same selected rating as the Movie Blocking setting(s). Only the correct Access Code number, entered by the viewer, will unblock or allow the viewing of a block rated program.



SMART HELP



Note: When a Movie Rating is selected (✓) all higher level ratings are automatically blocked (although each individual Movie Rating can be manually selected and turned On or Off as desired). Programs with lower than the selected rating level are allowed for viewing or unblocked.

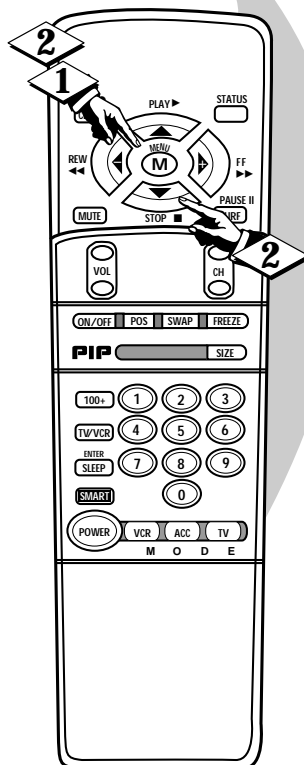
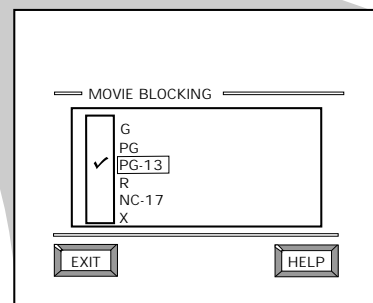
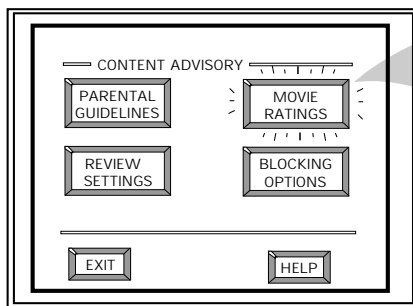

- **G - General Audience:** Most parents would find this program suitable for all ages. This type of programming contains little or no violence, no strong language, and little or no sexual dialogue or situations.
- **PG - Parental Guidance:** This programming contains material that parents may find unsuitable for younger children. It may contain one or more of the following: Moderate violence, some sexual situations, infrequent coarse language, or some suggestive dialogue.
- **PG-13:** This programming contains material that parents may find unsuitable for children under the age of 13. It contains one or more of the following: violence, sexual situations, coarse language, or suggestive dialogue.
- **R - Restricted:** This programming is specifically designed for adults. Anyone under the age of 17 should only view this programming with an accompanying parent or adult guardian. It contains one or more of the following: intense violence, intense sexual situations, strong coarse language, or intensely suggestive dialogue.
- **NC-17 - No one under 17 admitted:** This type of programming should be viewed by adults only. It contains graphic violence, explicit sex, or crude indecent language.
- **X - Mature audience only:** This type of programming contains one or more of the following: very graphic violence, very graphic and explicit or indecent sexual acts, very coarse and intensely suggestive language.

CONTENT ADVISORY PARENTAL GUIDELINES

Parental Guidelines can be even more defined and specific in the degree and extent of material parents may allow for TV program viewing. Sub-settings for Language, Violence, and other blocking factors can be manually switched On or Off for use within the major Parental Guideline categories (TV-Y7, TV-PG, etc.).

BEGIN

1 Select the PARENTAL GUIDELINES Menu option.

With CONTENT ADVISORY Menu on screen, move the RED highlight with the MENU \blacktriangleleft buttons. Then press the MENU (M) button.

2 Press the MENU \blacktriangleleft \blacktriangleright to highlight and select the desired PARENTAL GUIDELINE rating level (TV-Y, TV-Y7, etc.).

3 Press the MENU \blacktriangleup \blacktriangledown and MENU (M) buttons to Block (\checkmark) the selected Parental Guideline category (or to set other individual blocking feature items available within that Guideline category (L, V, S, D, etc.) as desired).

Note: Selecting "ALWAYS BLOCKED" (or individually adjusting the L, V, S, D settings) for any one rating will set all other higher level ratings to be automatically blocked as well.

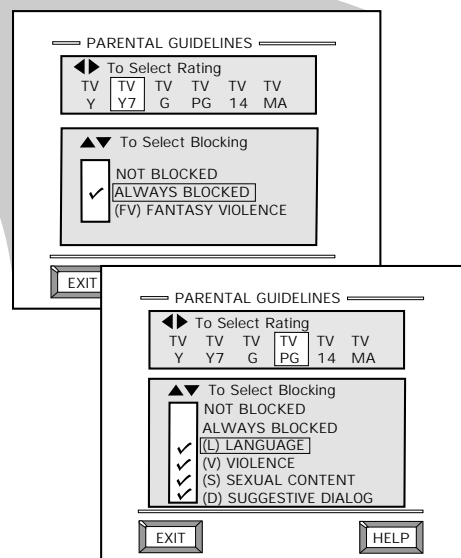
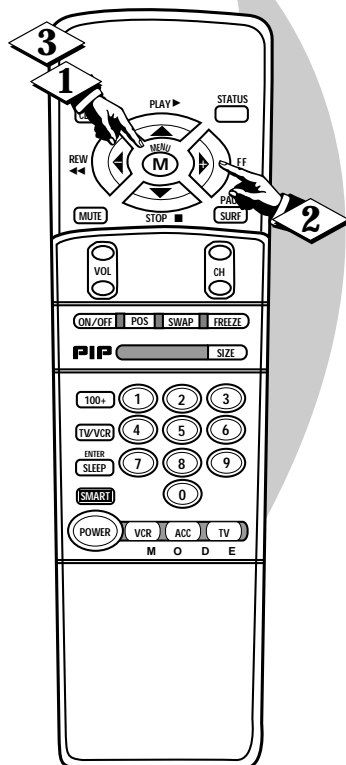
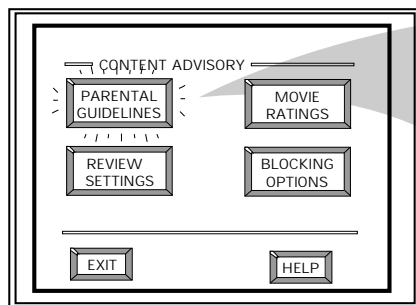

- **TV-Y - Appropriate for all children:** Designed for a very young audience, including children ages 2-6. This type of programming is not expected to frighten younger children.
- **TV-Y7 - Appropriate for children seven and older:** It may be more appropriate for children who have acquired the development skills needed to distinguish between make-believe and reality. This programming may include mild fantasy and comic violence (FV).
- **TV-G - General Audience:** This type of programming contains little or no violence, no strong language, and little or no sexual dialogue or situations.
- **TV-PG - Parental Guidance suggested:** This type of programming contains one or more of the following: Moderate violence (V), some sexual situations (S), infrequent coarse language (L), or some suggestive dialogue (D).
- **TV-14 - Unsuitable for children under 14:** This type of programming contains one or more of the following: intense violence (V), intense sexual situations (S), strong coarse language (L), or intensely suggestive dialogue (D).
- **TV-MA - Mature audience only:** This type of programming contains one or more of the following: graphic violence (V), explicit sexual situations (S), or crude indecent language (L).

- **(V) - Violence**
- **(S) - Sexual situations**
- **(L) - Language**
- **(D) - Inappropriate dialogue**
- **(FV) - Fantasy Violence** may frighten children under seven. Some cartoons may have this rating. Available in the TV-Y7 category only.

SMART HELP

The TV-Y7; TV-PG; TV-14; and TV-MA guidelines also include customized settings for various additional items such as V (violence), S (sexual situations), L (coarse language), D (suggestive dialogue), and FV (fantasy violence). These additional settings are category specific and can be individually selected for use as desired.

CONTENT ADVISORY BLOCKING OPTIONS

The Content Advisory system also has "Blocking Option" controls which can be used to deny viewing access for channel programs and movies even when they are "unrated", or contain "no rating" information as broadcasted.

BEGIN

1 Select the **BLOCKING OPTIONS** Menu control.

With CONTENT ADVISORY Menu on screen, move the RED highlight with the MENU \blacktriangledown buttons. Then press the MENU (M) button.

2 Press the MENU \blacktriangle and MENU (M) buttons to turn the Blocking System On (highlight and select \blacktriangleright ENABLED). Then use the remote Menu buttons to select the desired programming and information blocking options.

Please refer to Note shown with this page section for details on "unrated" and "no rating" program control options.

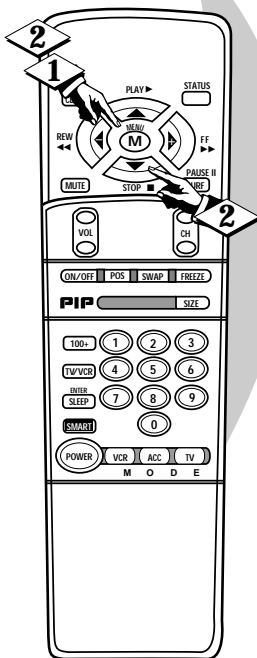
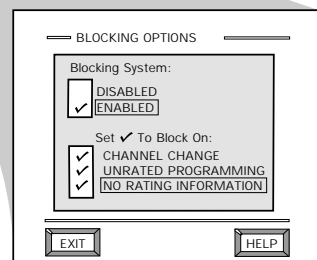
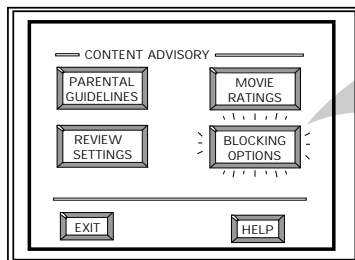

Note: Remember that Content Advisory data or encoded information is not available with all received TV programming (this also includes commercials, and other program spot announcements). Broadcaster's can decide **not to encode** any kind of content advisory ratings with their programming, or they can actually choose to **encode programs to be "unrated."**

The TV Blocking Options allow the viewer to block any program without content advisory data with the use of its "NO RATING INFORMATION" control. And to block programs that are encoded as "unrated" with its "UNRATED PROGRAMMING" control option.

Since the reception of Content Advisory data can take a few seconds, you may want to use the "CHANNEL CHANGE" option to be sure no viewing is allowed during blocked program channel changes. This can eliminate the display of a few seconds of undesirable video on the TV, or receiving scenes from a Ratings blocked channel source.

CONTENT ADVISORY REVIEW SETTINGS

Use the Review Settings control to quickly check the status for Content Advisory system Parental Guidelines and Movie Rating "Blocked" program levels.

BEGIN

1 Select the **REVIEW SETTINGS** Menu option.

With CONTENT ADVISORY Menu on screen, move the RED highlight with the MENU \blacktriangledown buttons. Then press the MENU (M) button.

The TV screen will display the current Parental Guideline and Movie Ratings Blocked program settings. Content Advisory system status will also be shown (Enabled -On, or Disabled - Off).

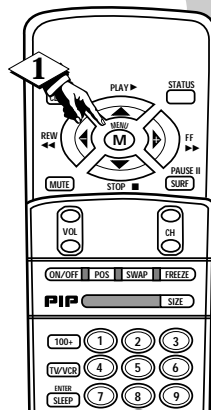
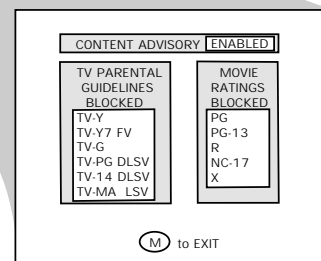
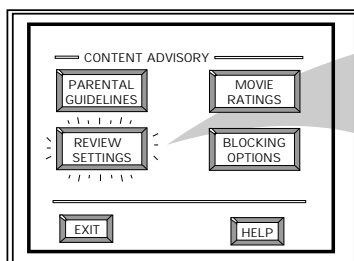

FEATURE MENU CONTROLS (CONTINUED)

CHANNEL DISPLAY

With the Channel Display control you can change the size and location of the on screen channel and clock information.

BEGIN

- 1 Select **CHANNEL DISPLAY** control.

With FEATURES MENU (2 of 5) on screen, move the RED highlight with the MENU $\blacktriangle/\blacktriangledown$ buttons. Then press the MENU (M) button.

- 2 Press the MENU $\blacktriangle/\blacktriangledown$ and MENU (M) buttons to highlight and select (✓) the LARGE or SMALL display control.

- 3 Press the STATUS button to clear the screen.

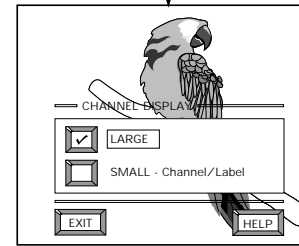
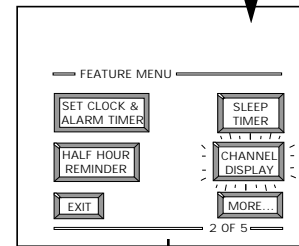
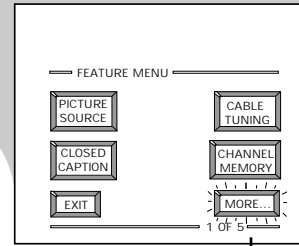
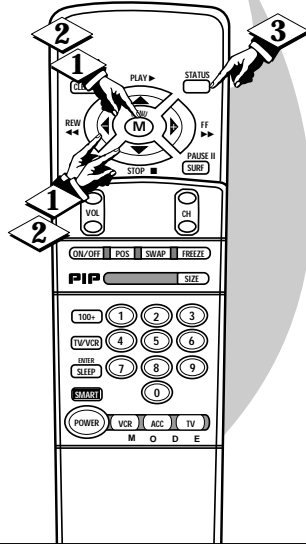
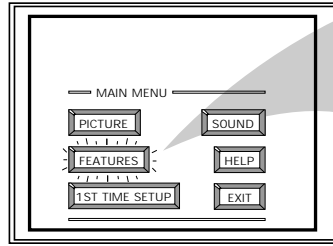

SMART HELP



Try it out. Press the CHANNEL $\blacktriangle/\blacktriangledown$ buttons and you should see the Display Size you selected.

Remember. The SMALL SIZE display shows only the channel number, not the time (or clock).

LANGUAGE

Note: If you went through First Time Setup, This task has already been completed for you.

For our Spanish and French speaking TV owners an on-screen LANGUAGE option is present. With the LANGUAGE control you can set the TV's on-screen features to be shown in either English, Spanish or French.

BEGIN

- 1 Select the **LANGUAGE DISPLAY** control.

With FEATURES MENU (3 of 5) on screen, move the RED highlight with the MENU $\blacktriangle/\blacktriangledown$ buttons. Then press the MENU (M) button.

- 2 Press the MENU $\blacktriangle/\blacktriangledown$ and MENU (M) buttons to highlight and select (✓) English, Spanish (ESPAÑOL), or French (FRANCAIS) on the display control.

Text for the on-screen Menu will change to the selected language.

- 3 Press the STATUS button to clear the screen.

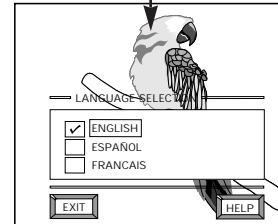
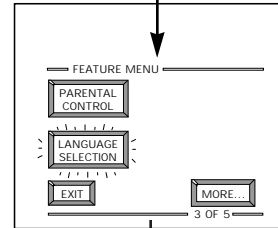
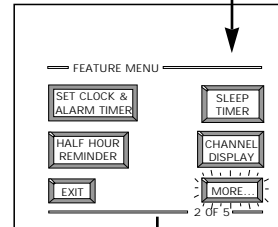
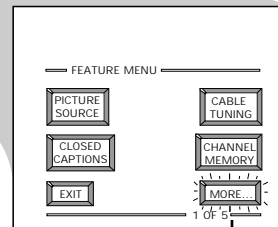
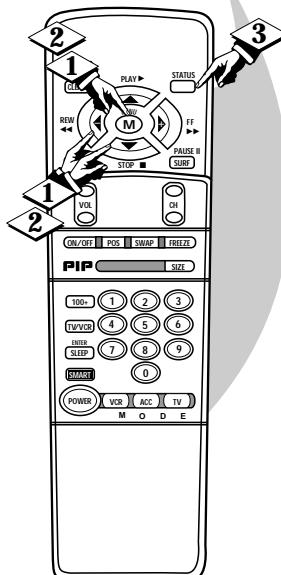
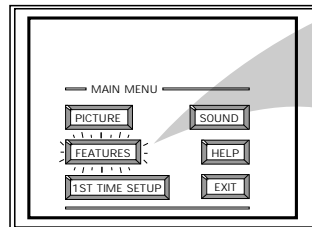

SMART HELP



Remember, the Language control only makes the TV's on-screen (MENU) items appear in English, Spanish, or French text. It does not change the other on-screen text features such as Closed Captioned (CC) TV shows.

BASS, TREBLE, BALANCE

Your TV also has individual sound adjustment controls. The **BASS** (low frequency), **TREBLE** (high frequency), and **Speaker BALANCE** may all be used to adjust the sound playback of TV programs.

BEGIN

- 1 Select **BASS**, or **TREBLE**, or **BALANCE** sound control.

With the **SOUND MENU** on the screen, move the **RED** highlight with the **MENU**  buttons. Then press the **MENU (M)** button.

- 2 Press the **(+)** or **(-)** buttons to adjust the sound control to levels you prefer.

- 3 Press the **STATUS** button to clear the screen.

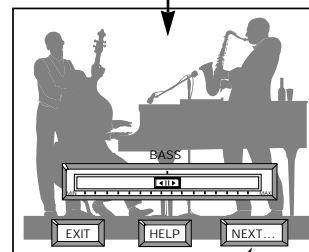
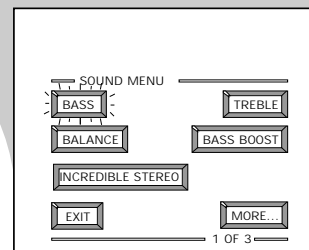
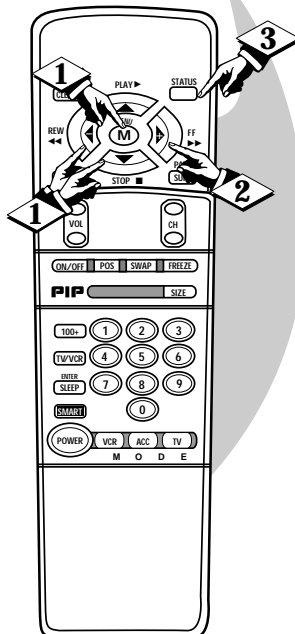
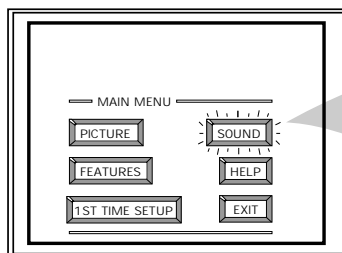

Select and then press **MENU (M)** button to view additional controls grouped under same feature heading. For Example: Treble, Balance, Bass Boost, Stereo, etc.

BASS BOOST

The **BASS BOOST** control increases the low frequency audio range of the TV. This creates a deeper, fuller playback sound which can be heard through the TV's speakers.

BEGIN

- 1 Select **BASS BOOST** sound control.

With the **SOUND MENU** on the screen, move the **RED** highlight with the **MENU**  buttons. Then press the **MENU (M)** button.

- 2 Press the **MENU**  and **MENU (M)** buttons to highlight and turn **ON** (✓) the **BASS BOOST** control.

- 3 Press the **STATUS** button to clear the screen.

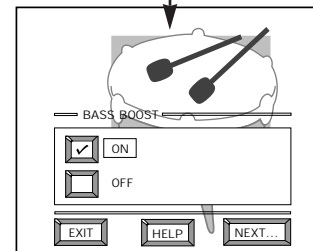
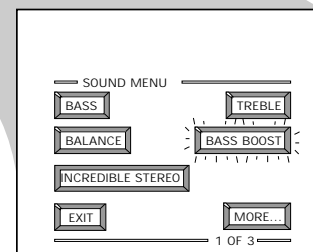
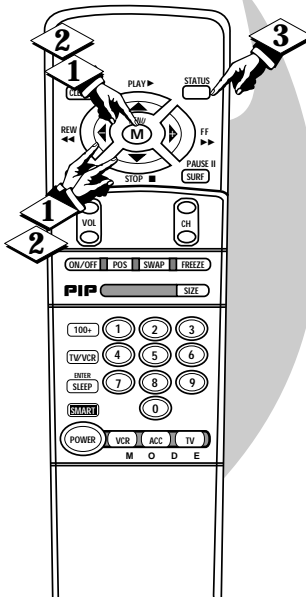
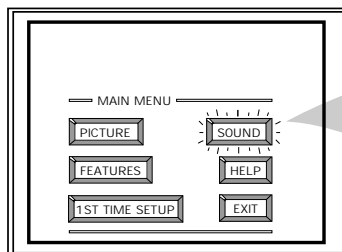

STEREO

Your TV is able to receive broadcast stereo TV programs. The TV is equipped with an amplifier and twin speaker system through which the stereo sound can be heard.

Note: STEREO will appear on the TV's channel status screen to indicate when a stereo broadcast signal is available and received.

BEGIN

1 Select STEREO sound control.

With the SOUND MENU on the screen, move the RED highlight with the MENU (M)  buttons. Then press the MENU button.

2 Press the MENU and MENU (M) buttons to highlight and turn ON (✓) the STEREO mode.

3 Press the STATUS button to clear the screen.

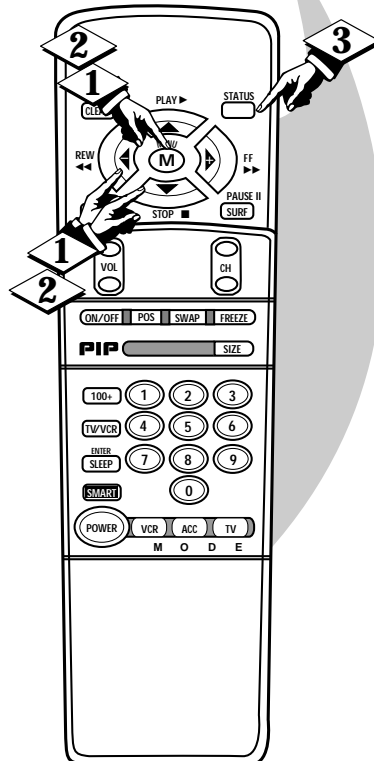
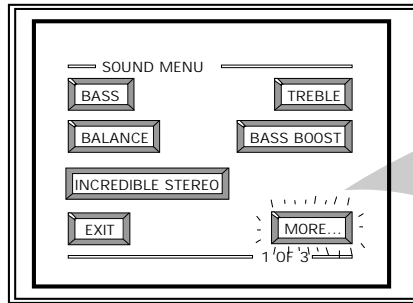

SMART HELP



Remember. If a stereo signal is not available and the TV is placed in the STEREO mode, sound coming from the TV will remain monaural (mono).

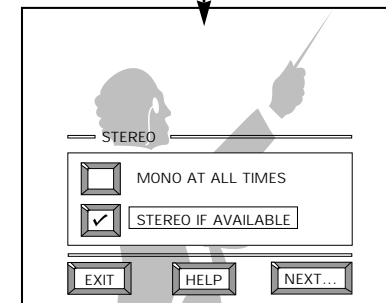
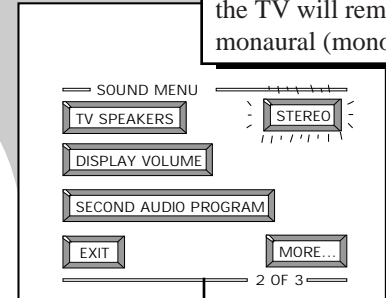

SECOND AUDIO PROGRAM

Second Audio Program (SAP) is part of the stereo broadcast system. Sent as a third audio channel SAP can be heard apart from the current TV program sound. TV stations are free to use SAP for any number of purposes, but many experts believe it will be used for foreign language translations of TV shows (or for weather and news bulletins.)

NOTE: If a SAP signal is not present with a selected program, the SAP option can not be selected. "This program does not contain SAP information" will show on the TV screen.

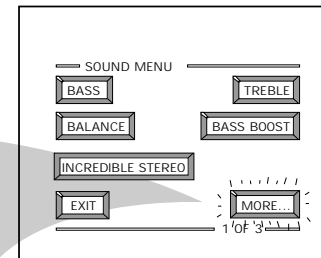
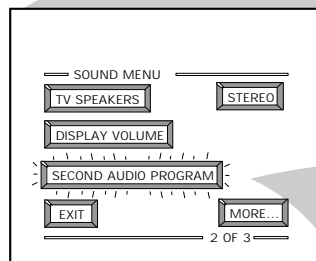

SECOND PROGRAM SOUND CAN ONLY BE SELECTED (✓) WHEN SAP INFORMATION IS PRESENT ON CURRENT CHANNEL.

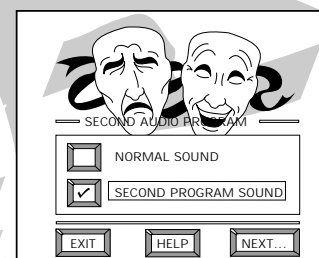





INCREDIBLE STEREO

The Incredible Stereo control can be used to add greater depth and dimension to both monaural (MONO) and STEREO TV sound.

BEGIN

- 1 Select **INCREDIBLE STEREO** control.

With the SOUND MENU on the screen, move the RED highlight with the MENU (M)  buttons. Then press the MENU button.

- 2 Press the MENU  and MENU (M)  buttons to highlight and turn ON  the INCREDIBLE STEREO mode.

For Example: "MAXIMUM" spreads the Incredible Stereo effect as wide as possible.

- 3 Press the **STATUS** button to clear the screen.

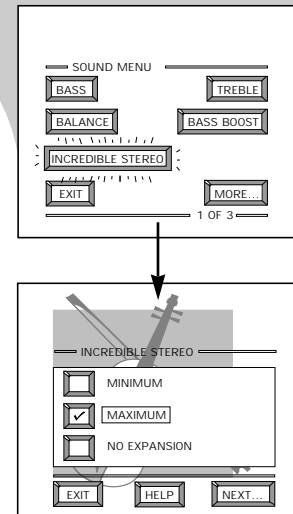
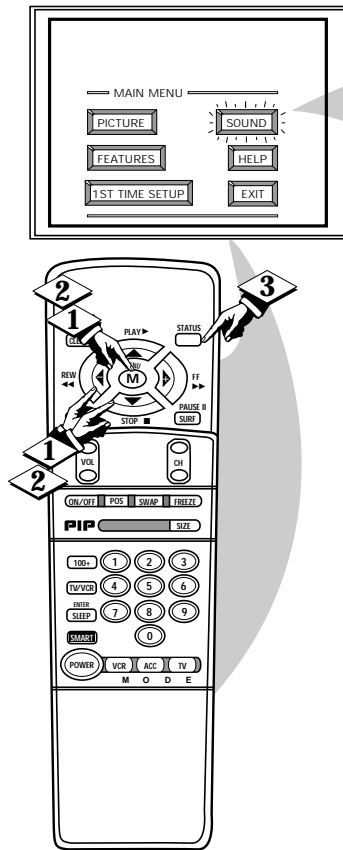

SMART HELP



Remember, with the Incredible Stereo control turned ON even monaural (mono) audio source material can be heard through rear Surround Sound speaker connections (see page 27). Note: The monaural version of Surround Sound may be louder at the rear set of speakers than what is normally heard with true stereo signal Surround Sound, but this is normal.



DISPLAY VOLUME

Use the DISPLAY VOLUME control to see the TV's volume level settings on the TV screen. Once set, the Volume Display will be seen each time the VOLUME buttons (on the TV or remote) are pressed.

BEGIN

- 1 Select **DISPLAY VOLUME** control.

With SOUND MENU (2 of 3) on screen, move the RED highlight with the MENU (M)  buttons. Then press the MENU (M) button.

- 2 Press the MENU  and MENU (M)  buttons to highlight and turn ON  the DISPLAY VOLUME control.

- 3 Press the **STATUS** button to clear the screen.

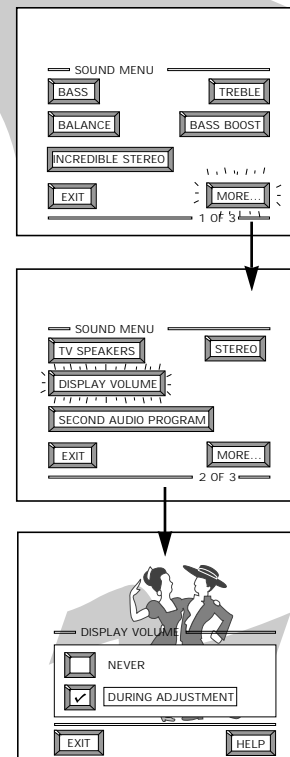
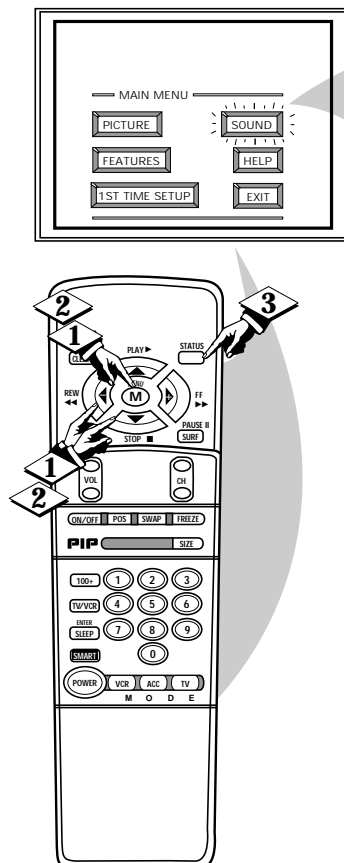

SMART HELP



Remember, "DURING ADJUSTMENT" means the volume level will be on screen whenever the Volume buttons are pressed.

TV SPEAKERS

Would you like to hear TV programs through your audio hi-fi system? The TV's Variable Audio Output jacks and TV Speaker On/Off control work together to offer you this TV sound option.

BEGIN

- 1 **Connect the R(ight) and L(eft) VARIABLE AUDIO OUT** jacks on the TV to the R and L Audio Input jacks on your amplifier or sound system.

Set the audio system's volume to normal listening level.

- 2 **Turn the TV and audio system ON.** You can now adjust the sound level coming from the audio system with the Volume \blacktriangle / \blacktriangledown buttons on the TV or remote.

- 3 To hear the TV sound from only the audio system speakers, **select TV SPEAKERS** control.

With SOUND MENU (2 of 3) on screen, move the RED highlight with the MENU \blacktriangledown buttons. Then press the MENU (M) button.

- 4 **Press the MENU \blacktriangle / \blacktriangledown and MENU (M) buttons** to highlight and turn OFF (\swarrow) the TV SPEAKERS control.

You should now only hear TV sound coming from the audio system speakers.

- 5 **Press the STATUS** button to clear the screen.

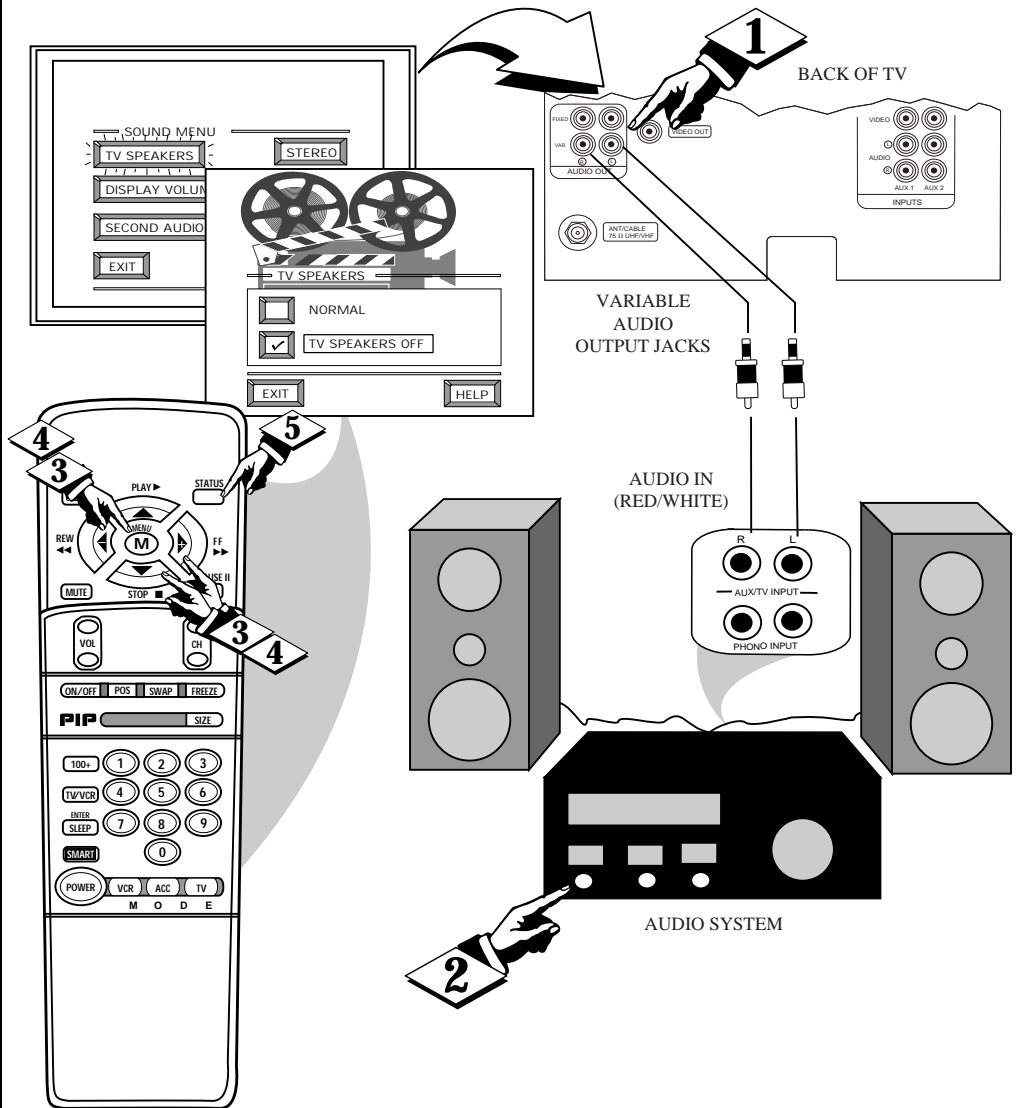

SMART HELP



Remember, the audio system may have to be in AUX(iliary) mode to play sound from the TV (Outputs).

Note: When the TV SPEAKER control is set to "NORMAL" (for TV speaker operation) make sure the VARIABLE AUDIO OUTPUT control (see next page) is also set to "STEREO" in order for the TV's AUDIO OUTPUT jacks to work properly.

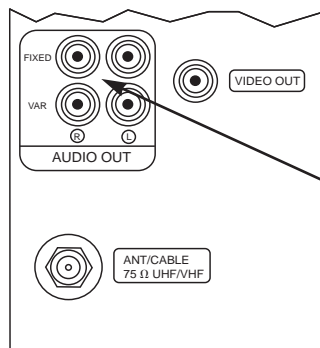

NOTE: The TV's FIXED AUDIO OUTPUT jacks can also be used for the playback of TV program sound with an external audio amplifier, or home theater hi-fi system. Connection of the FIXED AUDIO OUT(puts) is similar

to the Variable Audio Outputs (as shown above). However, specific sound level adjustments will be made with the controls at the external amplifier or home sound system (instead of through the TV's audio level controls.)

SURROUND SOUND

By adding optional external speakers to the TV's sound system, you can create the feeling of reflected sound that surrounds you at a movie theater or concert hall.

BEGIN

- 1 Connect both external speakers to the speaker wire terminals on the TV.

Recommended speakers: 8ohm, 15 watt minimum. Be sure the (+) and (-) speaker wires are connected to the correct R(ight) and L(eft) speaker terminals on the TV.

- 2 Place the speakers so the viewing area is between the TV and the rear surround speakers. (See overhead view drawing.)

- 3 Turn TV ON and place the STEREO control to the "STEREO IF AVAILABLE" (✓) position.

After setup whenever a stereo signal is received the audio will be heard in Surround Sound.

STOP

REAR SURROUND SOUND SPEAKER TERMINALS

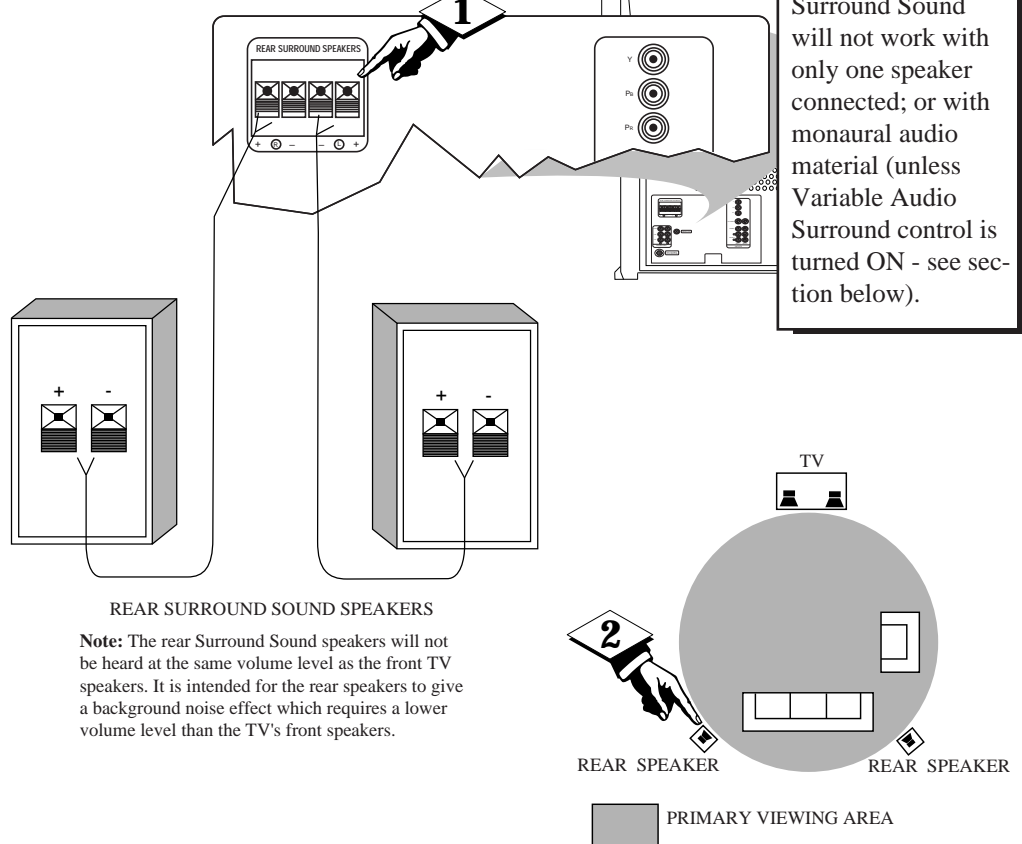

REAR SURROUND SOUND SPEAKERS

Note: The rear Surround Sound speakers will not be heard at the same volume level as the front TV speakers. It is intended for the rear speakers to give a background noise effect which requires a lower volume level than the TV's front speakers.

VARIABLE AUDIO OUTPUT

The TV's Variable Audio Output jacks can also be used for Surround Sound. Once they are connected an external hi-fi system its speakers can be used for the playback of Surround Sound.

BEGIN

- 1 Connect the R(ight) and L(eft) VARIABLE AUDIO OUT jacks on the TV to the R and L Audio Input jacks on your amplifier or sound system.

- 2 Turn TV ON and place the VARIABLE AUDIO OUTPUT on screen control to the SURROUND (✓) position. (Select the Main Menu Sound option, screen 3 of 3).

STOP

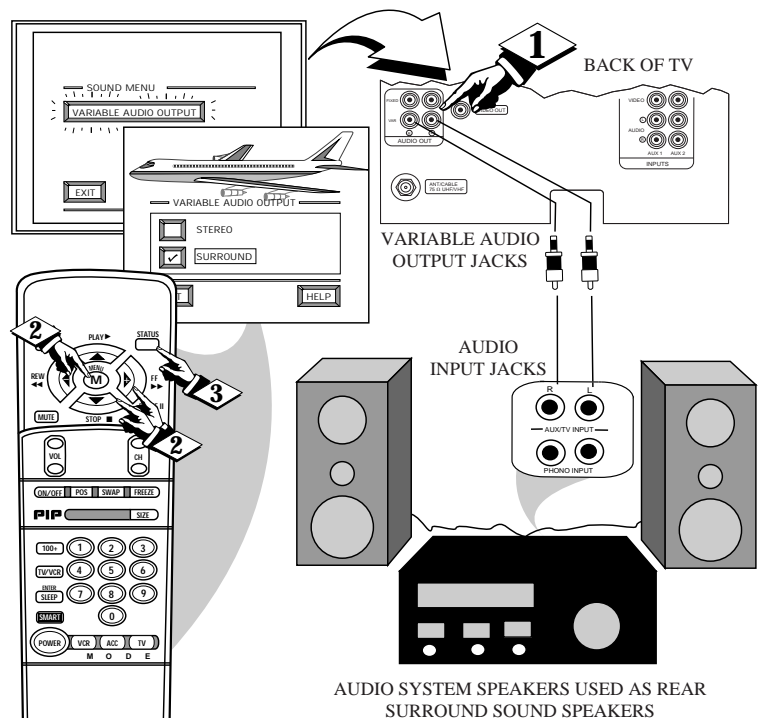

USING THE AUDIO/VIDEO INPUT JACKS

AUX 1 VIDEO INPUTS

The TV's Audio/Video Input jacks are for direct picture and sound connections between the TV and a VCR (or Video Disc Player, etc.) that has Audio/Video Output jacks.

To view the playback of a VCR tape by using the Audio/Video Input jacks on the TV:

BEGIN

- 1 Connect the VIDEO OUT jack from the VCR to the AUX 1 VIDEO IN jack on the TV.
- 2 Connect the AUDIO OUT jacks R(ight) and L(eft) from the VCR to the AUX 1 AUDIO IN jacks on the TV.
- 3 Select the "AUX 1 VIDEO" PICTURE SOURCE SELECT control on the TV.
With the FEATURES MENU on screen, move the RED highlight with the MENU (M) buttons. Then press the MENU button.
- 4 Press the MENU ▲▼ and MENU (M) buttons to highlight and select (✓) the AUX 1 VIDEO mode.
- 5 Turn the VCR ON and press PLAY to view the tape on the TV.



SMART HELP



Remember, after it is connected an easy way to select the AUX 1 VIDEO mode is to press the TV/VCR button on the remote. AUX 2 VIDEO; AUX 1 Y Pb Pr; and the last channel viewed can also be selected in this way.

Also, if you have added AUX 1 VIDEO to the TV's channel memory (see page 13), you can just press the CHANNEL ▲▼ buttons to select the AUX 1 mode.

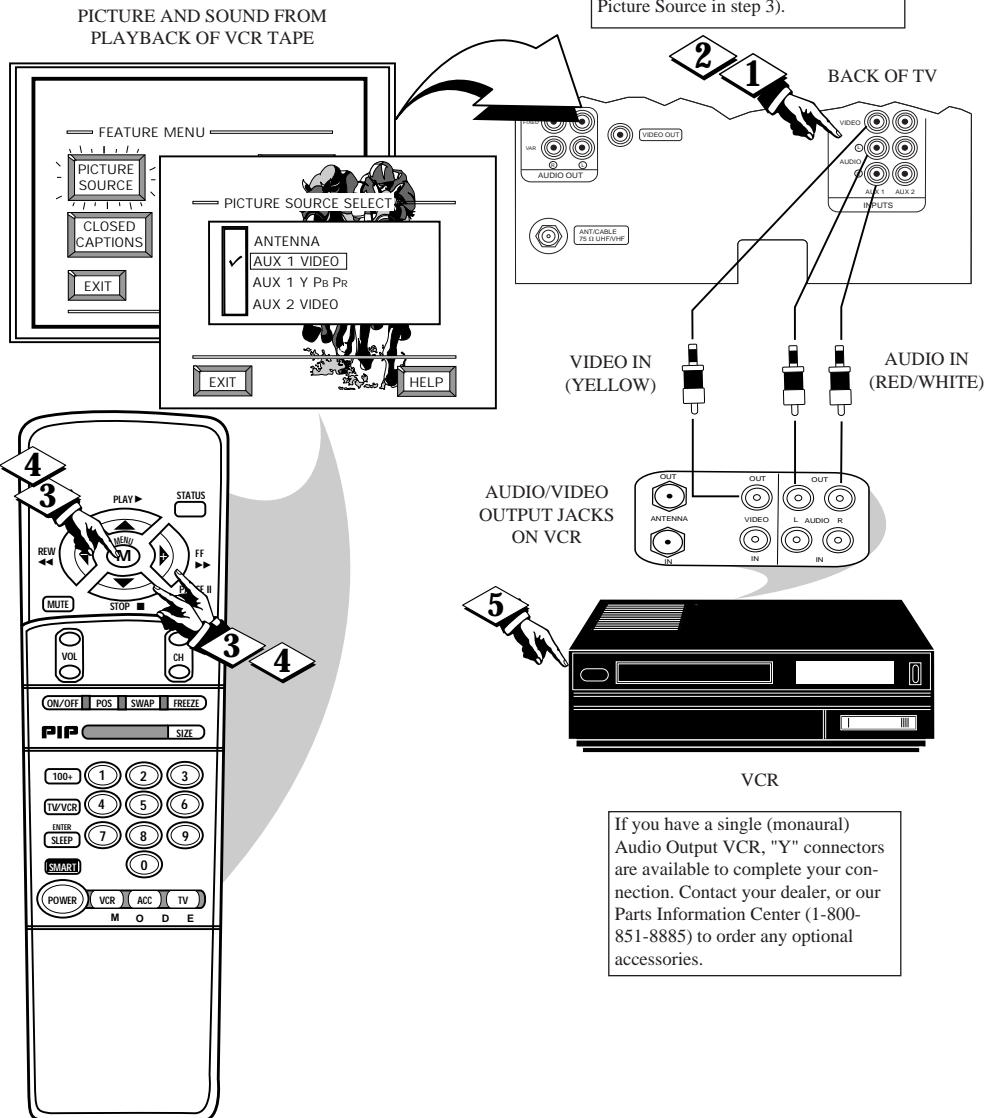

AUX1 - S-VIDEO INPUTS

The S(uper)-Video connection on the rear of the TV can give you better picture detail and clarity, for the playback of S-VHS VCR tapes or Video Discs, than the normal antenna picture connections.

Note: The VCR (or Video Disc Player) must have a S-VIDEO OUT(put) jack in order for you to complete the connections shown on this page.

BEGIN

1 Connect the S-VIDEO (S-VHS) OUT jack from the VCR to the S-VIDEO AUX 1 IN(put) jack on the TV.

The S-VIDEO connecting cable will be supplied with the S-VHS VCR (or Video Disc Player).

2 Connect the AUDIO OUT jacks R(ight) and L(ef) from the VCR to the AUDIO AUX 1 IN(put) jacks on the TV.

3 Select the "AUX 1 S-VIDEO" PICTURE SOURCE control.

With the FEATURES MENU on screen, move the RED highlight with the MENU (M)  buttons. Then press the MENU button.

The "AUX 1 S VIDEO" picture source option appears only when a S-VIDEO cable has been connected to the TV's AUX 1 IN(puts).



4 Turn the VCR ON and place it in the S-VIDEO (or S-VHS) playback mode. Insert S-VHS cassette tape and playback in a normal manner.



SMART HELP



Remember, after it is connected an easy way to select the AUX 1 S-VIDEO mode is to press the TV/VCR button on the remote.)

Also, if you have added AUX 1 to the TV's channel memory, you can just press the CHANNEL   buttons to select the S-VIDEO mode (when active).

PICTURE AND SOUND FROM PLAYBACK OF S-VHS VCR TAPE PLAYBACK

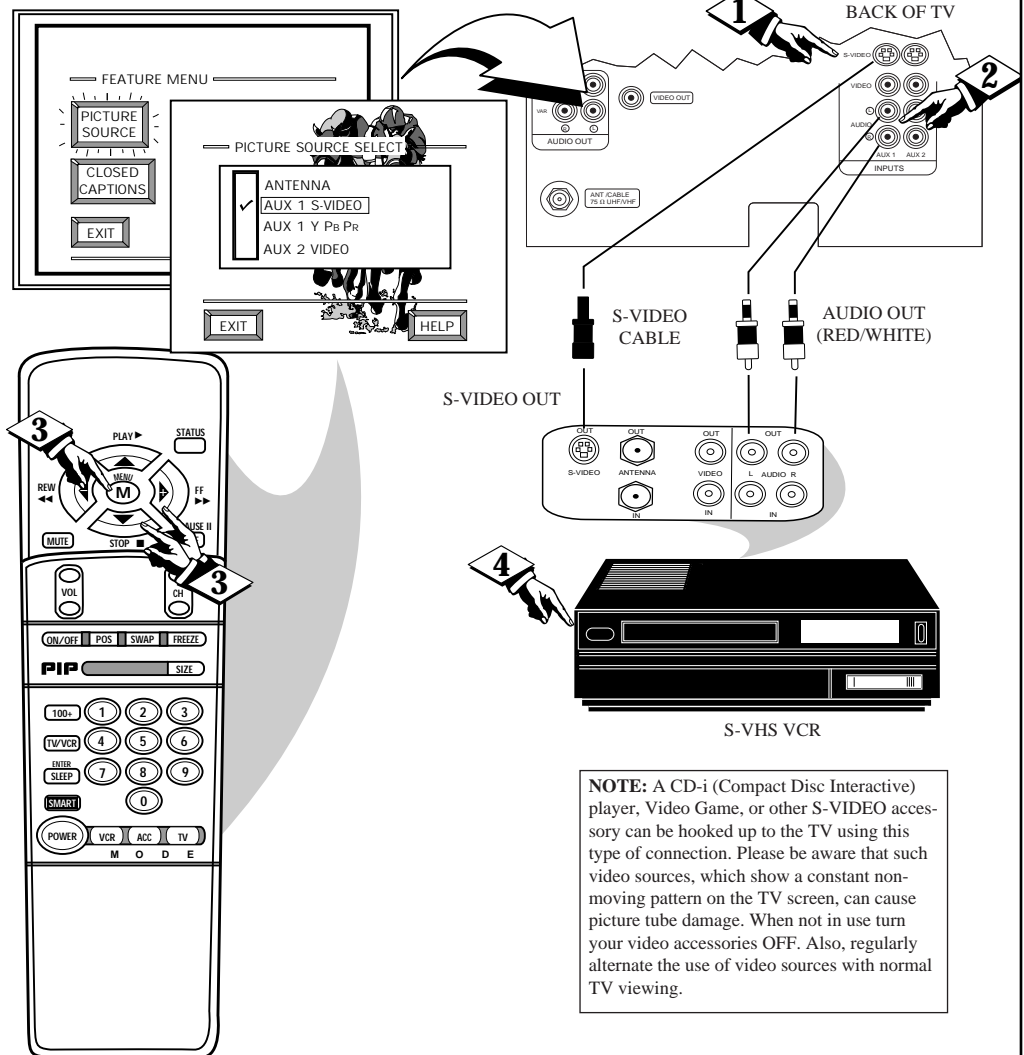

NOTE: A CD-i (Compact Disc Interactive) player, Video Game, or other S-VIDEO accessory can be hooked up to the TV using this type of connection. Please be aware that such video sources, which show a constant non-moving pattern on the TV screen, can cause picture tube damage. When not in use turn your video accessories OFF. Also, regularly alternate the use of video sources with normal TV viewing.

COMPONENT VIDEO INPUTS

Component Video Inputs provide for the highest possible color and picture resolution in the playback of digital signal source material such as with DVD players. The color difference signals (PB, PR) and the luminance (Y) signal are connected and received separately which permits for improved color bandwidth information (not possible when using composite video or S-Video connections).

BEGIN

- 1 Connect the Component (Y PB PR) VIDEO OUT jacks from the DVD player to the (Y Pb Pr) VIDEO IN(put) jacks on the TV.
- 2 Connect the AUDIO OUT jacks R(ight) and L(ef) from the DVD player to the AUX 1 AUDIO IN jacks on the TV.
- 3 Select the "AUX 1 Y Pb Pr" PICTURE SOURCE control on the TV.
With the FEATURES MENU on screen, move the RED highlight with the MENU (M) buttons. Then press the MENU button.
- 4 Press the MENU ▲▼ and MENU (M) buttons to highlight and select (↙) the AUX 1 Y Pb Pr mode.
- 5 Turn the DVD player ON and press PLAY to view the source material playback on the TV.



SMART HELP



The description for the component video connectors may differ depending on the DVD player or accessory digital source equipment used (e.g. Y Pb Pr; R-Y/B-Y/Y; Cr/Cb/Y, etc.). Although abbreviations and terms may vary, the letters "B" and "R" stand for the blue and red color component signal connectors and "Y" indicates the luminance signal. Refer to your DVD or digital accessory Owner's Manual for definitions and connection details.

PICTURE AND SOUND FROM PLAYBACK OF DVD SOURCE MATERIAL

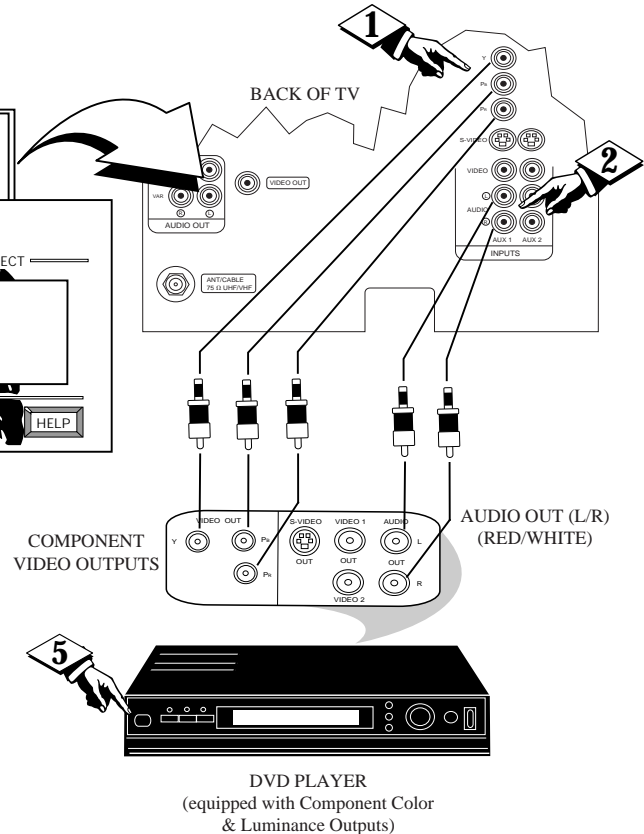
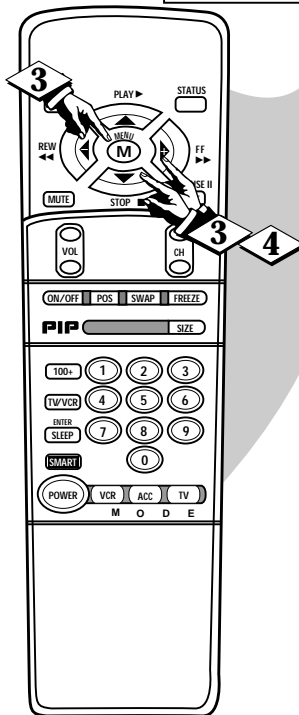
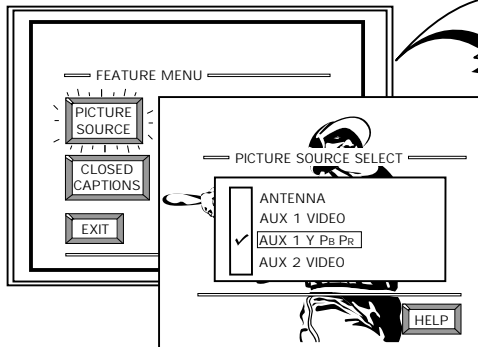

DVD PLAYER
(equipped with Component Color & Luminance Outputs)

Optional Video/Audio Cables (with standard RCA plug connectors) are available to complete your Component Input Jack connections. Contact your dealer, or our Parts Information Center (1-800-851-8885) to order any optional accessories.

AUDIO/VIDEO OUTPUTS

The Audio/Video Output jacks on the TV can be used to record TV programs on VCRs which have Audio/Video Input jacks.

To record TV programs by using the Audio/Video jacks on the TV:

BEGIN

- 1 Connect the VIDEO OUT jack from the TV to the VIDEO IN jack on the VCR.
- 2 Connect the AUDIO OUT jacks R(ight) and L(ef) from the TV to the AUDIO IN jacks on the VCR.
- 3 Select the "ANTENNA" PICTURE SOURCE control on the TV.

With the FEATURES MENU on screen, move the RED highlight with the MENU  buttons. Then press the MENU (M) button.

Select the channel on the TV that you want to record.
- 4 Turn the VCR ON. Put a cassette tape in the unit and place the VCR in the RECORD mode.



SMART HELP



Remember, if the VCR has an INPUT SELECTOR switch, place it in the LINE or CAMERA position.

Unattended Timer Recordings with a VCR are possible, but not recommended with this connection since the TV must be left ON for the VCR to record.

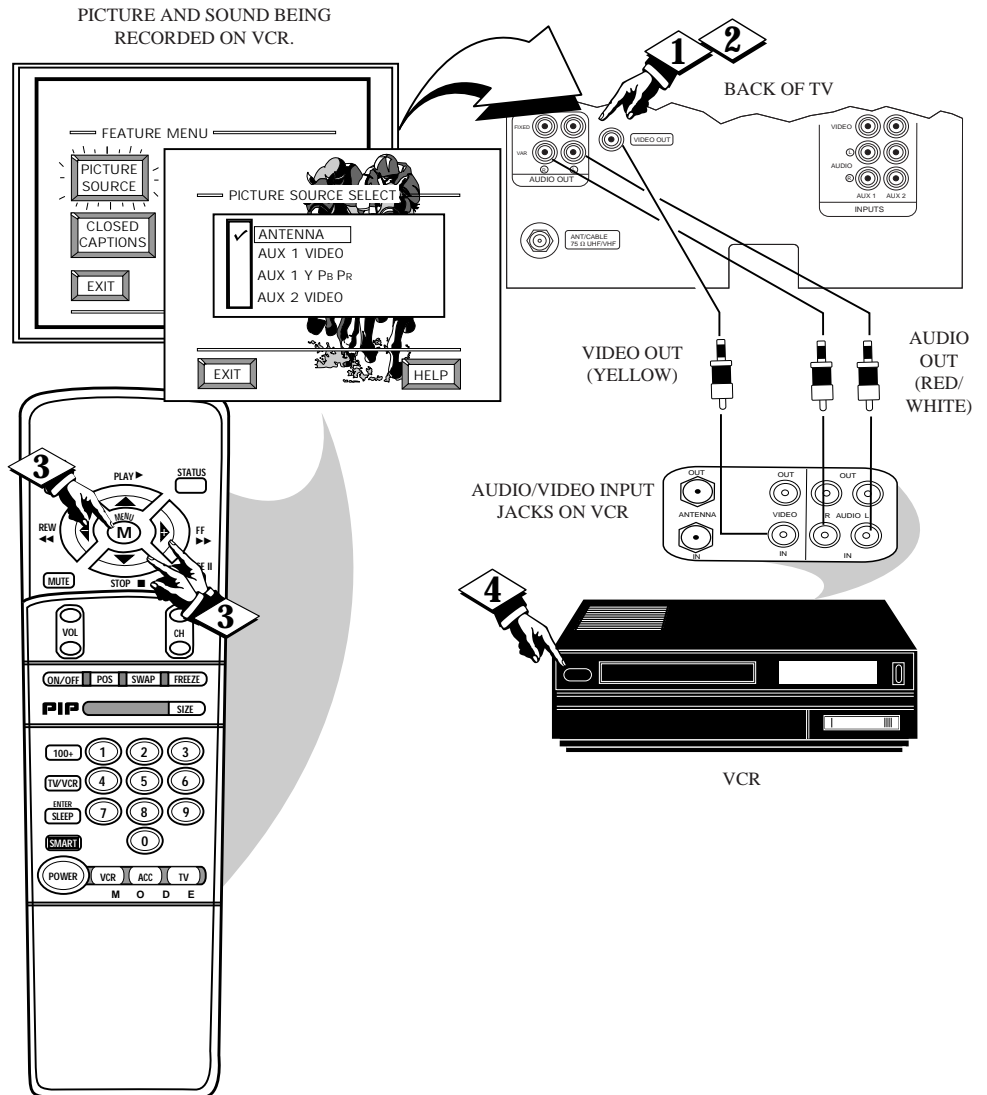

SMART PICTURE

Regardless of what type of program you are watching, your TV has automatic video control settings matched for your current program source or content. The Smart Picture feature quickly resets your TV's video controls for a number of different types of programs and viewing conditions you may have in your home.

BEGIN

- 1** Press the **Smart** button on the remote.
- 2** Press the **Menu (M)** button to select the Smart Picture feature (highlighted in red).
- 3** Press the **Menu (M) ▲ or ▼** buttons to choose any of the preset viewing categories (Example: Sports, Movies, etc.). Then press the **Menu (M)** button to select the highlighted control.
- 4** Press **STATUS** button on the remote control to clear the screen.



SMART HELP



Remember, with the Smart Picture "CUSTOM" mode selected you can set a number of video controls to your own preference. Use the remote's SMART button to reselect these personally adjusted Custom settings contained within the Smart Picture feature.

The video control settings for the Smart Picture categories (except CUSTOM) are memorized into the TV at the factory and can only be reset by field and service technicians.

SMART SOUND

Are you tired of the sound of commercials following you throughout the house? Smart Sound allows you to preset a desired volume level that the TV sound will not go above. This makes for an even, more consistent sound by reducing the "peaks" and "valleys" that can occur during commercials.

BEGIN

- 1** Press the **Smart** button on the remote.
- 2** With the **SMART Menu** on screen, move the **RED** highlight with the **Menu ▼** buttons. Then press the **MENU (M)** button to select the highlighted Smart Sound control.
- 3** Press the **Menu ▲ or ▼** and then the **Menu (M)** button to turn the Smart Sound control **ON** (or **OFF**.)
- 4** Press the **STATUS** button to clear the screen when completed.



SMART HELP



Remember, Smart Sound works for sound levels coming from either the Antenna/Cable input on the rear of the TV (RF audio); or the Auxiliary (VCR/AUX IN) audio inputs. When using a Cable Converter Box with the Smart Sound Control ON, the TV's volume level may take up to ten seconds to gradually increase to normal listening levels (when the TV's first turned on). This is considered NORMAL with various Cable Converter Box use.



2-CHANNEL SURF/SMART SURF

A "list" or series of previously viewed channels can be selected with the SURF button on your remote control. With this feature you can easily switch between different TV programs that currently interest you. The Smart Surf control allows you to set up to 10 channels in its quick viewing "list".

BEGIN

- 1 Press the **Smart** button on the remote.
- 2 With the **SMART Menu** on screen, move the **RED** highlight with the **Menu (M)** buttons. Press the **MENU** button to select the highlighted Smart Surf control.
- 3 Press the **Menu** or , then the **Menu (M)** button to select either Smart Surf or 2-Channel Surf. (See explanation of Surf options with the illustration on this page.)
- 4 Press **STATUS** button on the remote control to clear the screen.



SMART HELP



To Use 2-Channel Surf:

With the **2-Channel Surf control ON**, select the **two desired channels** for viewing with the number buttons on the remote control.

Press the **SURF** button on the remote to "toggle" between the two selected channels.

2 CHANNEL SURF- Current and one previous channel in the ring.

SMART SURF - Current and up to nine additional channels available in the ring. Note: The Channel Surf ring can be used with fewer than ten channels. In this way, the number of Surf channels can match or fit your present viewing interests.

HOW TO USE SMART SURF

BEGIN

- 1 With the **Smart Surf control ON** (see above), select a **desired channel** for viewing. You can use the number buttons on the remote (or the Channel buttons).
- 2 Press the **SURF** button on the remote. (Some channel numbers may already appear within the Surf channel list.)
- 3 Press the **Menu** button to "ADD" the selected channel to the Surf list. Select the next desired channel and repeat steps 2 and 3. Continue until all desired channels are on the Surf list.
- 4 Press the **SURF** button on the remote to quickly review current action on channels contained within the Surf list.

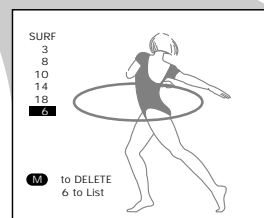
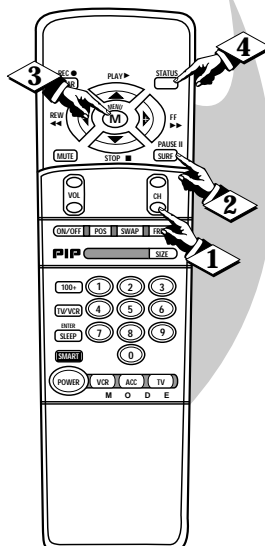
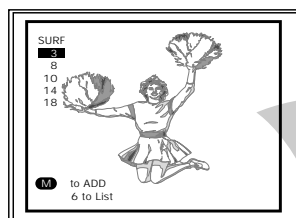

Note: To Delete a channel from the Surf list just press the SURF button to select the desired channel. Then press the Menu button and the channel will be immediately dropped from the on screen Surf list.

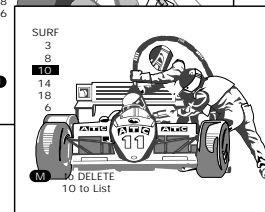
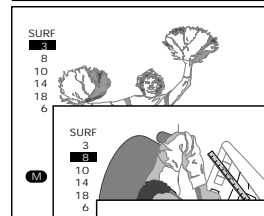

Your remote control is set to work your TV and many infrared remote (IR) control VCRs, Cable TV Converter Boxes, DVD players, Home Satellite receivers, etc. However, an easy one-time step may be necessary before the remote will work with your accessory device.

To begin, try this initial check to see if going on to the following section is necessary.

BEGIN

- 1 Press the **VCR** or **ACC(essory)** System button on the TV remote for the desired accessory device category.

Note: The ACC(essory) system button contains product codes for Cable TV Converters, DVD players, and Satellite receivers.

- 2 Point the TV remote toward the desired accessory device and press the **POWER** button.

- 3 Does the remote turn the accessory device ON?

IF YES, **STOP** and try other function buttons on the TV remote. If they also work the accessory device, then the remote is ready and no further steps are needed.

IF NO, continue...

- 1 First look up a **THREE-DIGIT remote code number** for your brand of Accessory Device before going through the simple Direct Access Method steps shown on the following page.

Find your Three Digit Code Number on pages 37-38.

SMART HELP



Remember, if more than one number is listed, you may have to try more than the first three-digit code given in order to locate your device's correct code.

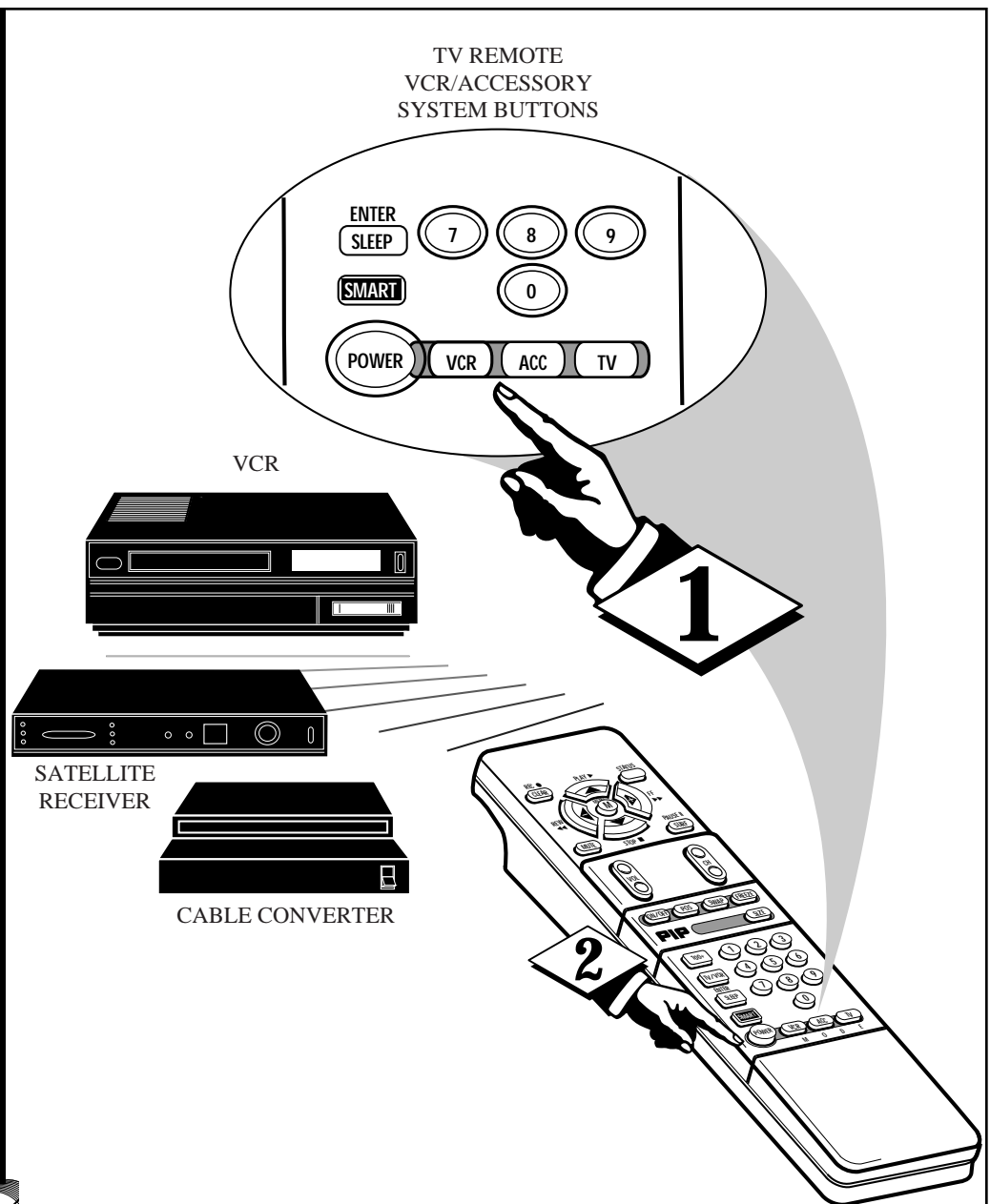



DIRECT ACCESS METHOD

Now that you have looked up the three-digit Remote Code Number for your brand of accessory device (see page 37-38), you are ready to follow the simple steps shown below.

Please read through all the steps before beginning.

(BEGIN)

- 1** Press and release the REC (RECORD) button.
- 2** Within three seconds after releasing the REC button, press and release the correct VCR or ACC(essory) System button.
- 3** Within thirty seconds after releasing the VCR or ACC System button, ENTER THE THREE DIGIT CODE NUMBER for the desired device. The remote is now ready to send commands to the accessory.
- 4** Point the remote at the accessory device. Press the POWER button on the remote to turn the device ON.



SMART HELP



Remember, if this does not work the first time, repeat steps using the same remote code number.

If after a second try the remote does not operate your accessory device, and there are more code numbers listed for your brand, use the next listed code number.

If after repeated attempts the code number method does not work your accessory device, try the "SEARCH METHOD" shown on the following page.

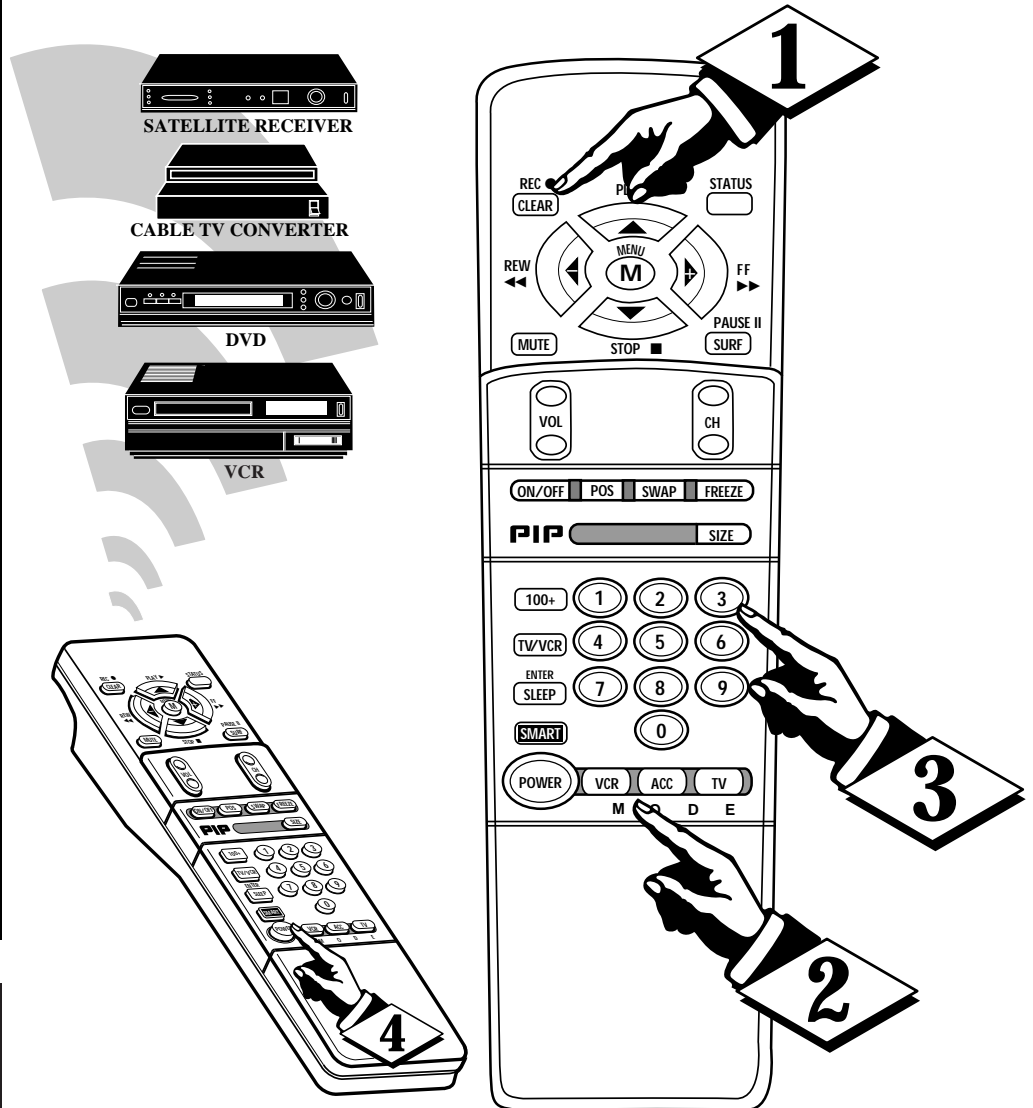



SETTING THE REMOTE TO WORK OTHER DEVICES - SEARCH

SEARCH METHOD

Your TV remote can be set to work various accessory devices (VCRs, Cable Converters, Satellite Receivers) by what is called the SEARCH method.

Note: The Search Method only works with devices equipped with Channel Display Indicators or capability. If the "Direct Access" code number method (shown in the previous section) did not set your remote to work your accessory device, then follow the easy steps listed below.

BEGIN

- 1** Turn ON the desired device. Press the correct VCR or ACC system button on the remote.
- 2** Stand at least six feet away from the front of the accessory device. Point the remote toward the unit. HOLD DOWN the SURF and the desired System (VCR or ACC) buttons at the same time. KEEP HOLDING BUTTONS DOWN.
- 3** Watch the Channel Indicator on the unit. Channel Numbers will SCAN UP when the unit has been identified. This may take up to two minutes.
- 4** Release the SURF and System (VCR or ACC) buttons as soon as channel numbers start to scan up. The code has been identified and the remote is ready to operate with the accessory device.



SMART HELP



Remember, a minute or two can seem very long, but the code should be located within two minutes.

Don't let the accessory device scan up more than five channels. The remote may pass up the right code and another two minute search cycle will have to be repeated.

If no channel change happens within two minutes, repeat steps 1-4. Should a channel change still not occur, the remote will not work with the desired unit.

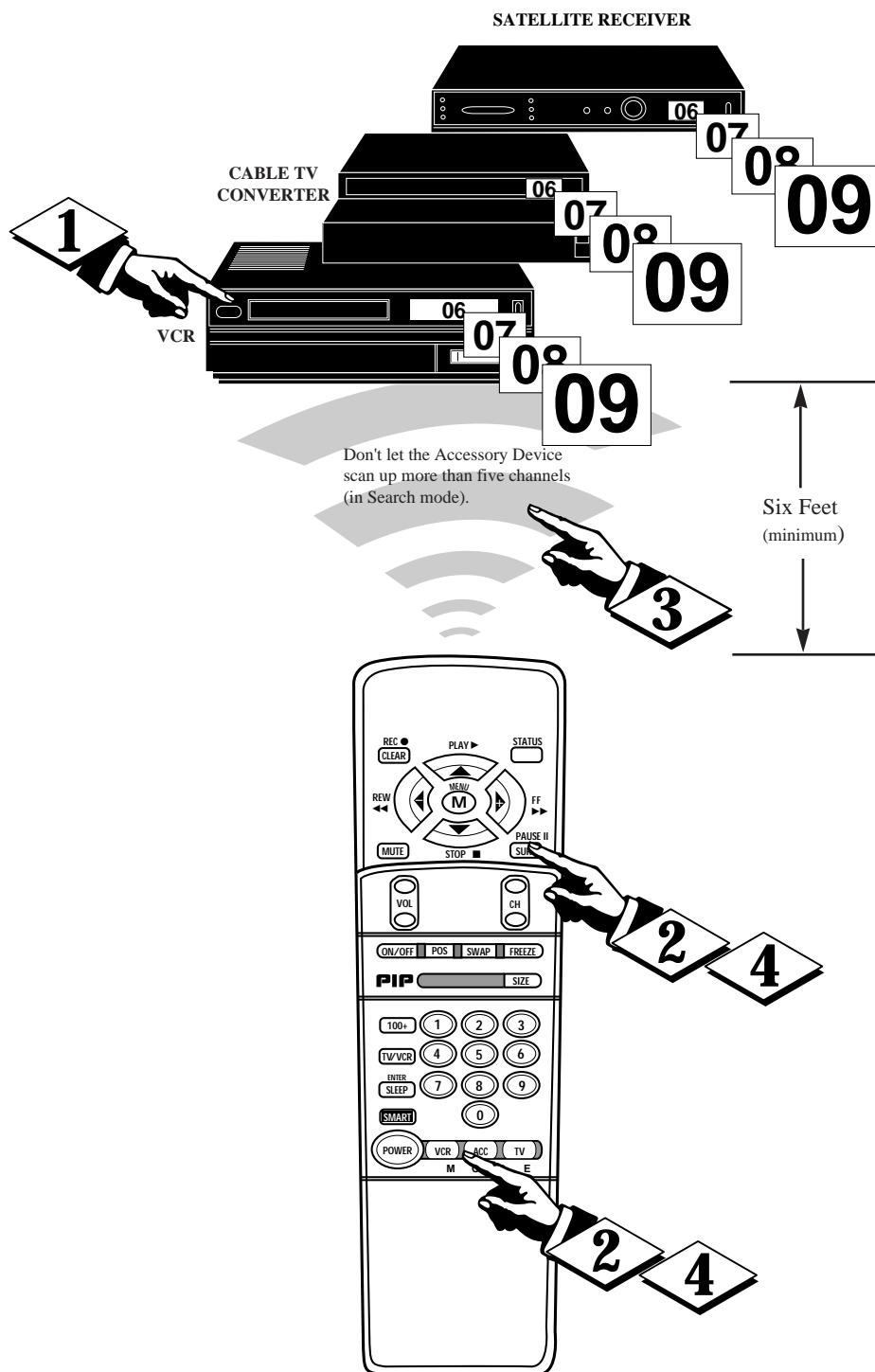

REMOTE CONTROL DIRECT ENTRY CODES FOR ACCESSORY DEVICES



<u>VCR BRAND</u>	<u>REMOTE CODE NO.</u>
Action	.317
Admiral	.048
Advantz	.356
Adventura	.000
Aiko	.278
Aiwa	.406, 307, 468, 000, 037
Akai	.106, 053, 041, 049, 061, 156, .242, 315
American High	.035
Asha	.240
Audiovox	.037
Beaumont	.240
Bell & Howell	.104
Broksonic	.121, 184, 002, 209, 211, .295, 361, 479
CCE	.072, 278
Calix	.037
Canon	.167, 035
Capehart	.020, 554
Carver	.081
Cineral	.278
Citizen	.278, 037
Colt	.072
Craig	.037, 072, 047, 240, 271
Curtis Mathes	.035, 041, 060, 162
Cybernex	.051, 240
Daewoo	.278, 561, 020, 554, 017, .045, 087
Daytron	.020, 554
Denon	.042
Dynatech	.000
Electrohome	.037
Electrophonic	.037
Emerex	.032
Emerson	.184, 002, 209, 278, 036, 121, 211, 208, 294, 479, 561, 061, 088, .212, 000, 037, 043, 068, 295, 361, 510
Fisher	.047, 104, 054, 066
Fuji	.033, 035
Fujitsu	.000
Funai	.000
GE	.035, 060, 048, 065, 202, 240
Garrard	.000
Go Video	.279, 432, 526, 350, 232
GoldStar	.037, 018, 038, 471, 480
Gradiente	.008, 000, 408
Grundig	.195
HI-Q	.047
Harley Davidson	.000
Harman/Kardon	.038, 075, 081
Harwood	.068, 072
Headquarter	.046
Hitachi	.042, 166, 105, 065, 292, .000, 041, 082, 235
JVC	.067, 008, 206, 207, 041, 384
Jensen	.041

<u>VCR BRAND</u>	<u>REMOTE CODE NO.</u>
KEC	.037, 278
KLH	.072
Kenwood	.041, 067, 384, 038
Kodak	.035, 037
LXI	.037
Lloyd's	.000, 208
Logik	.072
MEI	.035
MGA	.043, 061, 240
MGN Technology	.240
MTC	.000, 240
Magnasonic	.278
Magnavox	.035, 081, 000, 039, 149
Magnin	.240
Marantz	.081, 035
Marta	.037
Matsushita	.035, 162
Memorex	.104, 047, 000, 037, 048, .035, 046, 240, 307, 039, 162, 299
Minolta	.105, 042
Mitsubishi	.043, 173, 061, 075, 214, .242, 048, 067, 443
Motorola	.035, 048
Multitech	.000, 072
NAD	.058, 104
NEC	.038, 040, 041, 050, 067, 082, 104
Nikko	.037
Nikon	.034, 253
Noblex	.240
Olympus	.035, 226
Optimus	.048, 058, 037, 104, 162, 432
Optonica	.062
Orion	.479, 002, 184, 295
Panasonic	.035, 226, 077, 162, 378, .225, 227, 246
Penney	.035, 240, 037, 042, 038, .040, 054
Pentax	.042, 065, 105
Philco	.035, 209, 479
Philips	.081, 035, 062, 403
Pilot	.037
Pioneer	.058, 168, 067
Portland	.020, 554
Profitronic	.240
Proscan	.060, 202
Protec	.072
Pulsar	.039, 051
Quarter	.046
Quartz	.046, 155
Quasar	.035, 162, 077
RCA	.060, 149, 202, 042, 105, .035, 048, 065, 077, 106, 240, 277
Radio Shack	.000
Radix	.037
Randex	.037

<u>VCR BRAND</u>	<u>REMOTE CODE NO.</u>
Realistic	.000, 104, 047, 048, 037, .035, 062, 046, 066
Ricoh	.034, 253
Runco	.039
STS	.042
Salora	.075
Samsung	.045, 051, 053, 240
Sanky	.039, 048
Sansui	.041, 479, 000, 067, 082, 271
Sanyo	.047, 046, 104, 240
Scott	.184, 211, 121, 043, 045, 210, 212
Sears	.054, 105, 037, 042, 000, .035, 046, 047, 057, 066, 104
Semp	.045
Sharp	.048, 062
Shintom	.072
Shogun	.051, 240
Singer	.072
Sony	.033, 034, 032, 253, 000, 011, 035
Sunpak	.253
Sylvania	.035, 081, 000, 043
Symphonic	.000
TMK	.036, 208, 240
Tandy	.000, 104
Tatung	.041
Teac	.000, 041
Technics	.035, 162, 246
Teknika	.000, 035, 037, 052
Thomas	.000
Toshiba	.045, 057, 210, 212, 043, .066, 366
Totevision	.037, 240
Unitech	.240
Vector	.045
Vector Research	.038, 040
Video Concepts	.040, 045, 061, 221
Videosonic	.240
Wards	.035, 060, 062, 000, 047, 212, .240, 042, 048, 072, 081, 149
White Westinghouse	.278
XR-1000	.072, 000, 035
Yamaha	.038
Zenith	.039, 000, 033, 034

Continued on Next Page



REMOTE CONTROL DIRECT ENTRY CODES FOR ACCESSORY DEVICES

CABLE CONVERTER REMOTE CODE NO.

ABC003, 001, 007, 008, 011, 013,
014, 017, 047, 206
 ABC Cable033
 Allegro153, 315
 Antronix022, 207
 Archer022, 039, 153, 207, 797
 BBT267
 Belcor056
 Bell & Howell014
 Cable Star056
 Cabletenna022
 Cableview022
 Century153
 Citizen153, 315
 Colour Voice025, 031
 Comband232, 233
 Comtec274
 Comtronics040, 060
 Contec019
 Digi637
 Eastern002, 274
 Electricord078
 Emerson797
 Everquest015, 040
 Focus400
 GC Electronics056, 207
 GE232, 233
 GMI057
 Garrard153
 Gemini015, 057, 070, 242
 General Instrument .276, 476, 011, 810
 GoldStar040, 144
 Goodmind797
 Hamlin . .020, 009, 259, 034, 206, 273
 Hitachi011
 Hytex007
 Jasco015, 153, 315
 Jerrold003, 012, 276, 014, 011,
024, 476, 015, 047, 098, 810
 Linsay440
 Macom033
 Magnavox027, 334
 Memorex000
 Movie Time063, 078, 156, 203
 NSC156, 063, 070, 203
 Northcoast314
 Novaplex618
 Oak019, 007, 248
 Optimus021
 Panasonic021, 107, 000
 Panther637
 Paragon000
 Philips025, 030, 031, 242, 290,
027, 028, 029, 153, 334, 652
 Pioneer44, 023, 260, 533
 Popular Mechanics400

CABLE CONVERTER REMOTE CODE NO.

Prelude770
 Pulsar000
 Quasar000
 RCA021
 RK304
 Radio Shack015, 315, 797, 883
 Realistic207
 Recoton400
 Regal273, 279, 020, 259
 Regency002
 Rembrandt011, 070
 Runco000
 SL Marx040
 Samsung040, 144
 Scientific Atlanta . .008, 017, 006, 477
 Seam510
 Signal015, 040
 Signature011
 Sprucer307, 021
 Standard Components096
 StarSight542, 422
 Starcom003, 015, 047, 098
 Stargate040, 015, 770, 797
 Starquest015
 Sylvania001
 TFC310
 TV86063
 Tandy258
 Tatung097
 Teknika146
 TeleCaption221
 Teleview040
 Texscan096, 001
 Timeless274, 418
 Tocom012, 013, 059
 Toshiba000
 Tusa015
 Uniden225
 Unika153, 207, 022
 United Artists007
 Universal207, 022, 039, 056, 077,
078, 153, 191, 322
 Videoway250
 Vidtech244
 Viewstar258, 027, 060, 063, 111,
211, 289
 Zenith000, 525, 054
 Zentek400

SATELLITE RECEIVER REMOTE CODE NO.

AlphaStar772
 Echostar775
 Expressvu775
 General Instrument . . .361, 869, 627
 HTS775
 Hitachi819
 Hughes Network Systems749
 JVC775
 Jerrold361, 627
 Magnavox722, 724
 Memorex724
 Next Level869
 Panasonic701
 Philips200, 722, 724
 Primestar627, 361
 RCA566, 143, 855
 Sony639
 Star Choice869
 Toshiba790
 Uniden724, 722
 Zenith856

DVD BRAND REMOTE CODE NO.

Harman/Kardon818
 JVC814
 Kenwood807
 Magnavox802
 Mitsubishi803
 Onkyo802
 Panasonic800, 801
 Philips802, 808
 Pioneer805, 815
 Proscan804
 RCA804
 Samsung816
 Sony806
 Technics800
 Toshiba802
 Yamaha800, 813
 Zenith822, 802



When using the TV remote with a VCR, first make certain it is set to control your VCR (by the REMOTE CODE or SEARCH method - see earlier sections).

BEGIN

1 Press the VCR System button on the remote.

2 Point the top of the remote toward the front of the VCR (remote sensor window) when pressing buttons.



Record Button

Hold the RECORD button down, and then press the PLAY button to begin a VCR recording.

Rewind Button

Press to rewind tapes. For some VCRs you may need to press STOP button first then REWIND. In playback mode, hold button down to view picture moving rapidly in reverse.

Pause Button

Press to temporarily stop the tape during a playback or recording. Press again to release Pause.

TV-VCR Button

Press to the VCR position ("VCR" indicator on the VCR will light) to view the playback of a tape. Press again to place in the TV position ("VCR" indicator on the VCR will go OFF) to view one program while recording another program. When used with the TV the TV/VCR button works as a source button. Each press cycles the TV between the AUX(iliary) Input modes, Antenna input, and the the last view channel. It is a quick one-button way to select these channels and modes (without directly entering the TV's Menu system.)

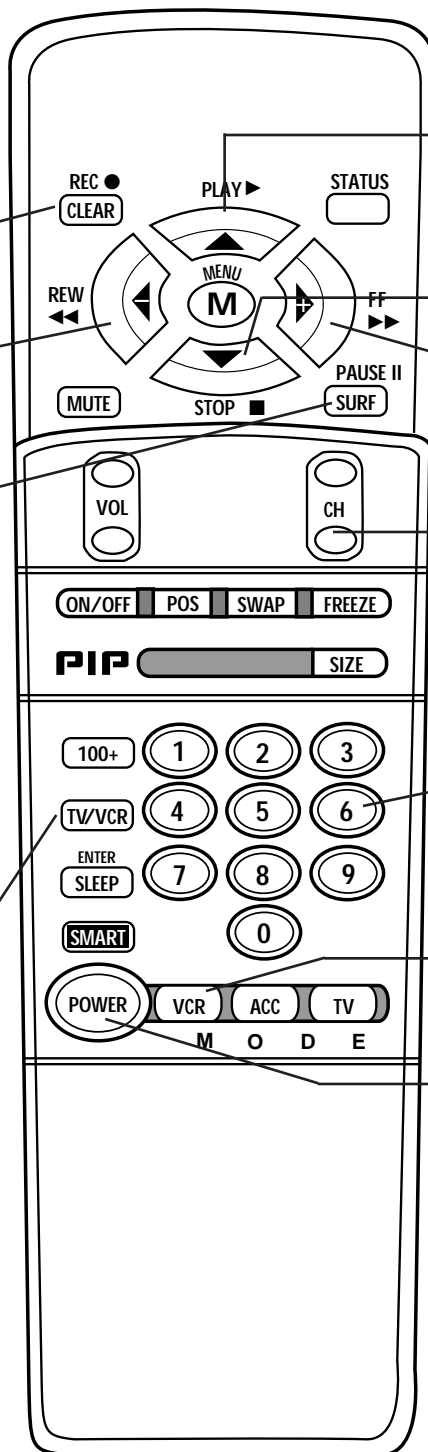

Play Button

Press to playback a tape. Hold down after pressing the RECORD button to start a recording.

Stop Button

Press to stop the tape.

Fast Forward Button

Press to rapidly advance the tape. For some VCRs you may need to press STOP first then FF. In Playback mode hold button down to view the picture moving rapidly in the forward direction.

Channel Scan Buttons

Press to scan up or down through VCR channel numbers.

Number Buttons

Press buttons for direct VCR channel selections .

VCR System Button

Press to send remote commands to the VCR.

Power Button

Press to turn the VCR ON and OFF.

SMART HELP



Remember, the VCR buttons on the remote will not operate your VCR if those features are not already found on your VCR remote control.

Note: All VCR functions (particularly Search, Rewind, Fast Forward, etc.) will operate the same as with the original VCR remote control provided with the VCR.

HOW TO USE THE PICTURE-IN-PICTURE (PIP) FEATURE

Picture in Picture (PIP) is the showing of two pictures on the TV screen at the same time. (One main screen picture and one small inset picture - or PIP).

Note: The PIP picture must be supplied by a VCR (or other accessory equipped with a VIDEO OUTPUT jack).

To see how channels selected on a VCR can be shown as PIP:

BEGIN

- 1** Connect the VIDEO OUT jack on the VCR to the AUX 1 VIDEO IN jack (yellow) on the TV.

Also connect the AUDIO OUT (R and L) jacks from the VCR to the AUX 1 AUDIO IN jacks (red and white) on the TV.

Also be sure the normal antenna connection between the VCR and TV are in place.

- 2** Move to the next page after the VCR to TV PIP connections are completed.

SMART HELP

For other possible PIP connections see page 45 for the "More PIP Connections" section.

If you need any accessories or parts to complete the described PIP connections, contact your dealer, or our Parts Information Center at (1-800-851-8885) for details.

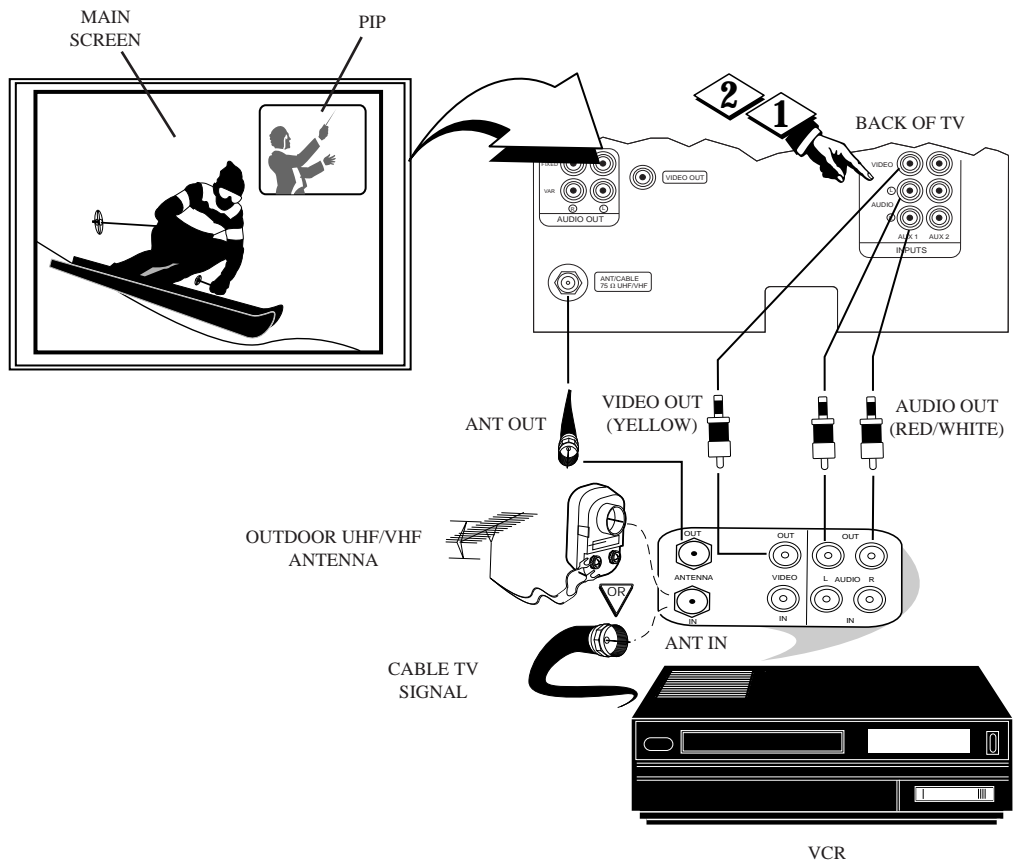



Now that you have completed the required connections on the previous page you are ready to follow the simple steps shown below.

3 Turn the VCR and TV ON.

Place the VCR in the TV mode - Use the **TV/VCR** button on the VCR (or on the TV remote if it has been set to work with your VCR - see page 34.)

Set the TV's PIP SOURCE SELECT control to AUX1 VIDEO With FEATURES MENU (4 of 5) on screen, move the RED highlight with the MENU (M) buttons. Then press the MENU button.

Press the MENU ▲▼ and MENU (M) buttons to highlight and select the "AUX 1 VIDEO" (✓) item.

4 Select the channel on the VCR to view in the PIP window.

Select the channel on the TV to view on the main screen.

5 Press the PIP ON/OFF button on the remote.

The PIP window should show in one of the corners of the TV screen.



SMART HELP



Remember, if you see the same picture on the main screen and in the PIP window, you need to be sure the TV's PIP Picture Source control (page 43) is set to "AUX 1 VIDEO".

No sound will be heard with the PIP picture. See the next page on how to "SWAP" the PIP picture with the main screen picture so that sound can be heard.

Also see the following page on how to operate other PIP features with the remote controls.

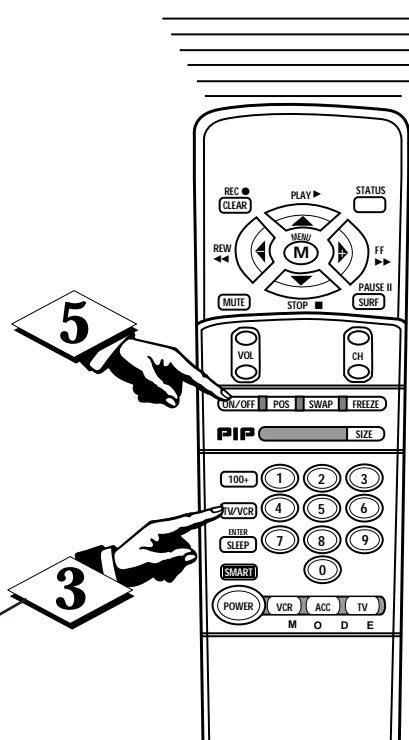
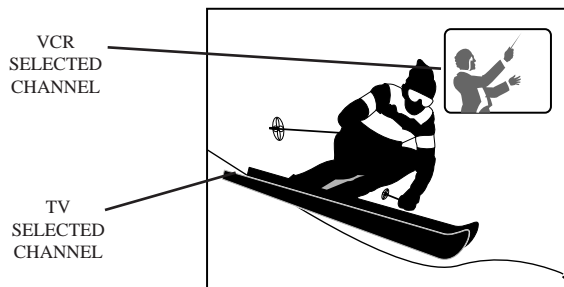
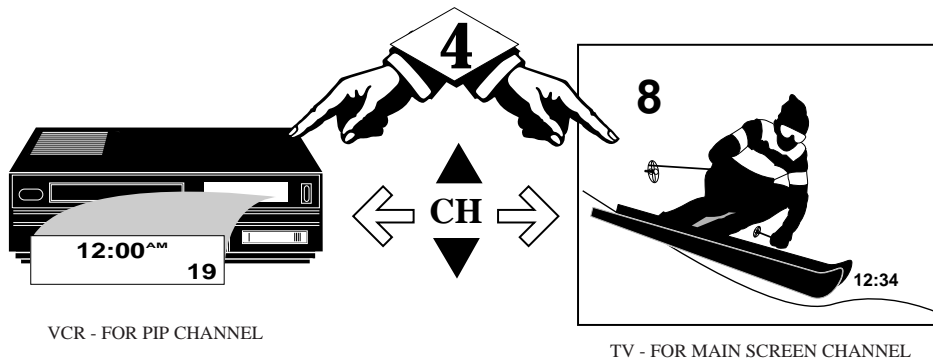
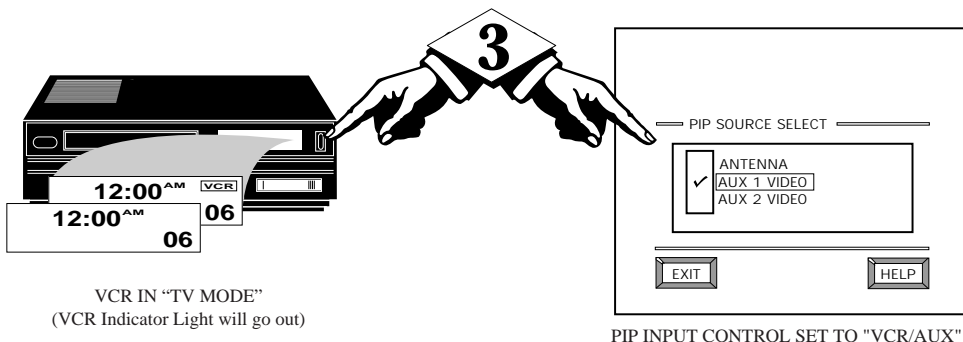

By using the PIP buttons on the remote the PIP picture can be moved and swapped with the main screen. The main screen picture can also be frozen in the PIP window.

BEGIN

- 1 Press the **PIP ON/OFF** button to show the PIP picture.

PIP appears in a corner of TV screen. Press PIP ON/OFF again to remove PIP from the main screen.

- 2 Press the **PIP POSITION** button to move the PIP picture (from corner-to-corner on the TV screen.)

This feature allows you to move PIP and avoid blocking off any main screen action.

- 3 With PIP on the TV screen, press the **SWAP** button to swap the main screen picture with the PIP picture. See "Smart Help" note on this page.

- 4 Press **FREEZE** to hold the current MAIN screen picture in the PIP window (Main picture is still active).

If PIP is currently OFF, the PIP window will automatically appear.

Press FRZ repeatedly to update the frozen PIP with current pictures from the Main screen.

You cannot reposition a frozen PIP picture.

Press the PIP ON/OFF button to drop the frozen PIP picture from the screen.

- 5 Press the **PIP SIZE** button to change the size of the PIP window shown on the TV screen.

Press the PIP SIZE button again to see and compare the large and small size PIP windows.

You cannot change the size of a frozen PIP picture.

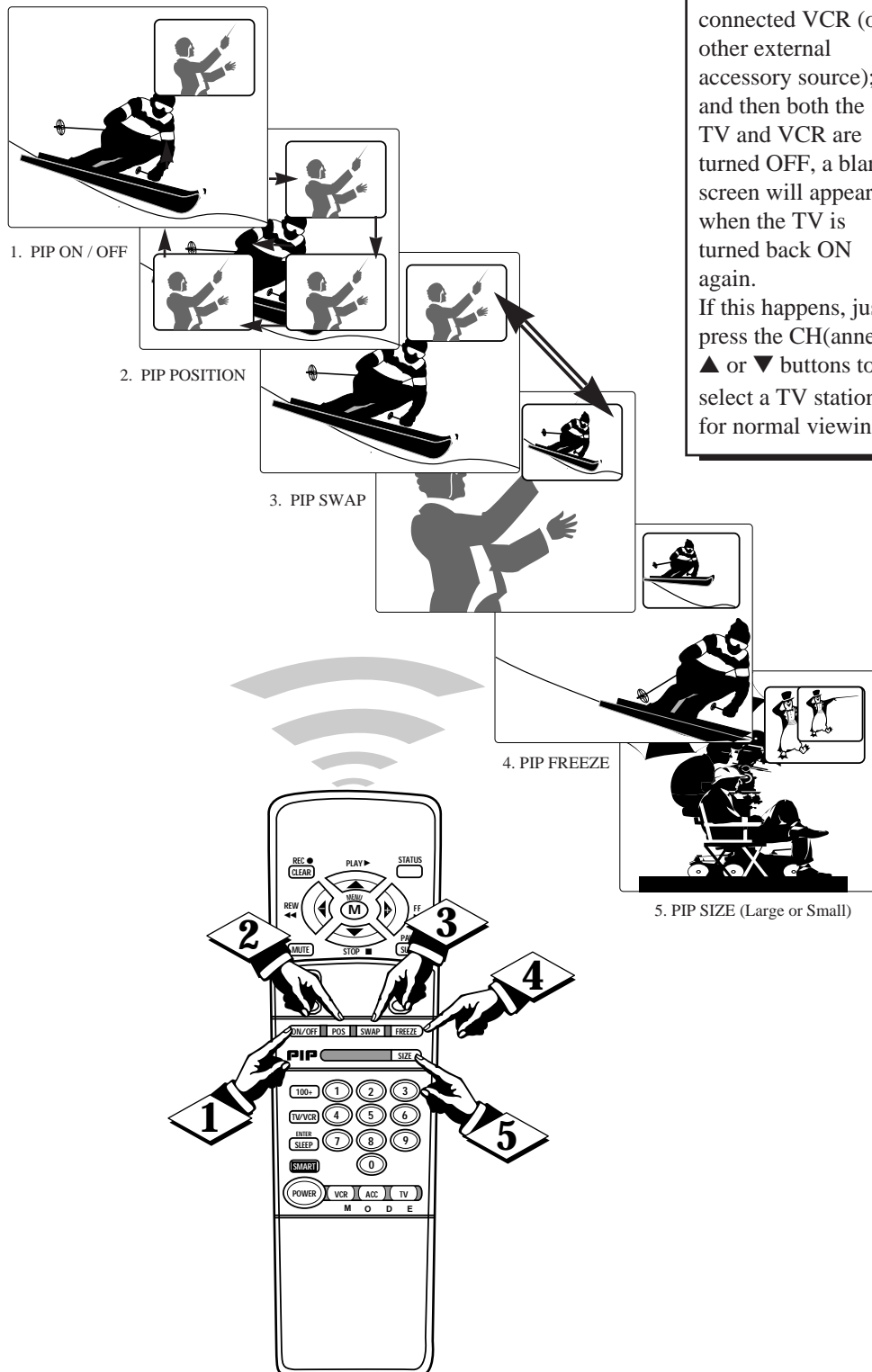

SMART HELP



Remember, if the TV's Main screen picture is being supplied by an AUX VIDEO connected VCR (or other external accessory source); and then both the TV and VCR are turned OFF, a blank screen will appear when the TV is turned back ON again.

If this happens, just press the CH(annel) ▲ or ▼ buttons to select a TV station for normal viewing.



PIP SOURCE

The picture for the PIP window can come through either the ANT/CABLE or AUX VIDEO Inputs (on the rear of the TV). PIP Picture Source simply tells the TV which one of these sources it is to show in the PIP window.

BEGIN

1 Select PIP SOURCE control.

With FEATURES MENU (4 of 5) on screen, move the RED highlight with the MENU \blacktriangle \blacktriangledown buttons. Then press the MENU (M) button.

2 Press the MENU \blacktriangle \blacktriangledown and MENU (M) buttons to highlight and select the desired (✓) AUX VIDEO or ANTENNA item.

ANTENNA- for a picture signal coming from the ANTENNA plug on the rear of the TV.

AUX 1 VIDEO- for a picture signal coming from the AUX 1 Video Input jack on the rear of the TV.

AUX 2 VIDEO- for a picture signal coming from the AUX 2 Video Input jack on the rear of the TV.

3 Press the STATUS button to clear the screen.



SMART HELP



Remember. The PIP screen will be blank unless a signal is connected to the selected source (either ANT/CABLE or AUX VIDEO Inputs) on the rear of the TV.

Note: The Component Video Inputs (AUX 1 Y Pb Pr) can not be selected as a source for PIP.

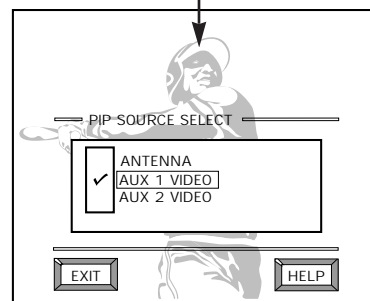
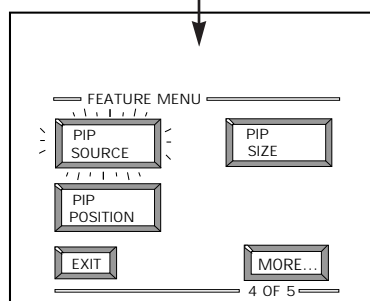
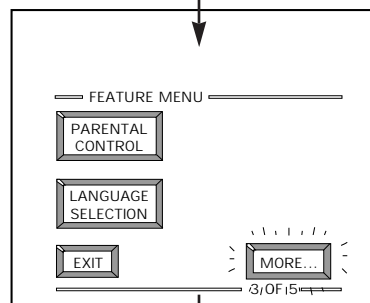
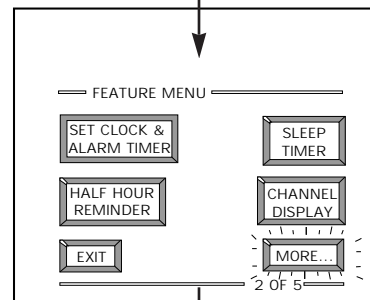
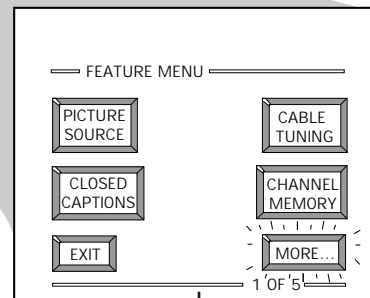
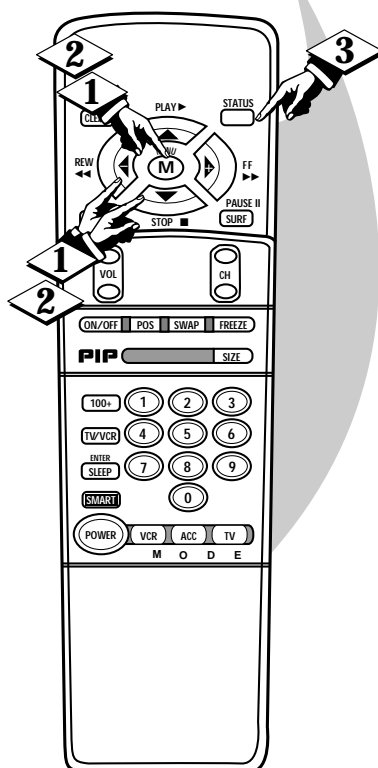
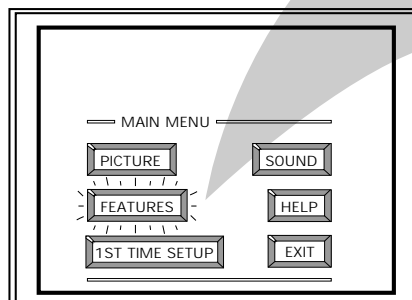

ADJUSTING PICTURE-IN-PICTURE COLOR AND TINT

PIP COLOR / PIP TINT

The Picture-In-Picture (PIP) Color and Tint controls are used to make fine tune adjustments to the color settings for PIP (when it is shown on the TV screen).

BEGIN

- 1 Select PIP COLOR (or PIP TINT) control.

With PICTURE MENU (5 of 5) on screen, move the RED highlight with the MENU \blacktriangle \blacktriangledown buttons. Then press the MENU (M) button.

- 2 Press the MENU \blacktriangle \blacktriangledown buttons to move the RED highlight. Press the MENU button to turn the PIP COLOR or TINT control ON.

The PIP automatically comes on to show the PIP window on the TV screen.

- 3 Press the (+) and (-) buttons to adjust the PIP for Color (or Tint) levels you prefer.

- 4 Press the STATUS button to clear the screen.



SMART HELP

Remember. Although there are separate COLOR and TINT controls for PIP, the adjustment levels for these controls depend on the TV's main picture. For example: If the main screen is showing a black and white picture, PIP would also be in black and white (even though its source is in color).

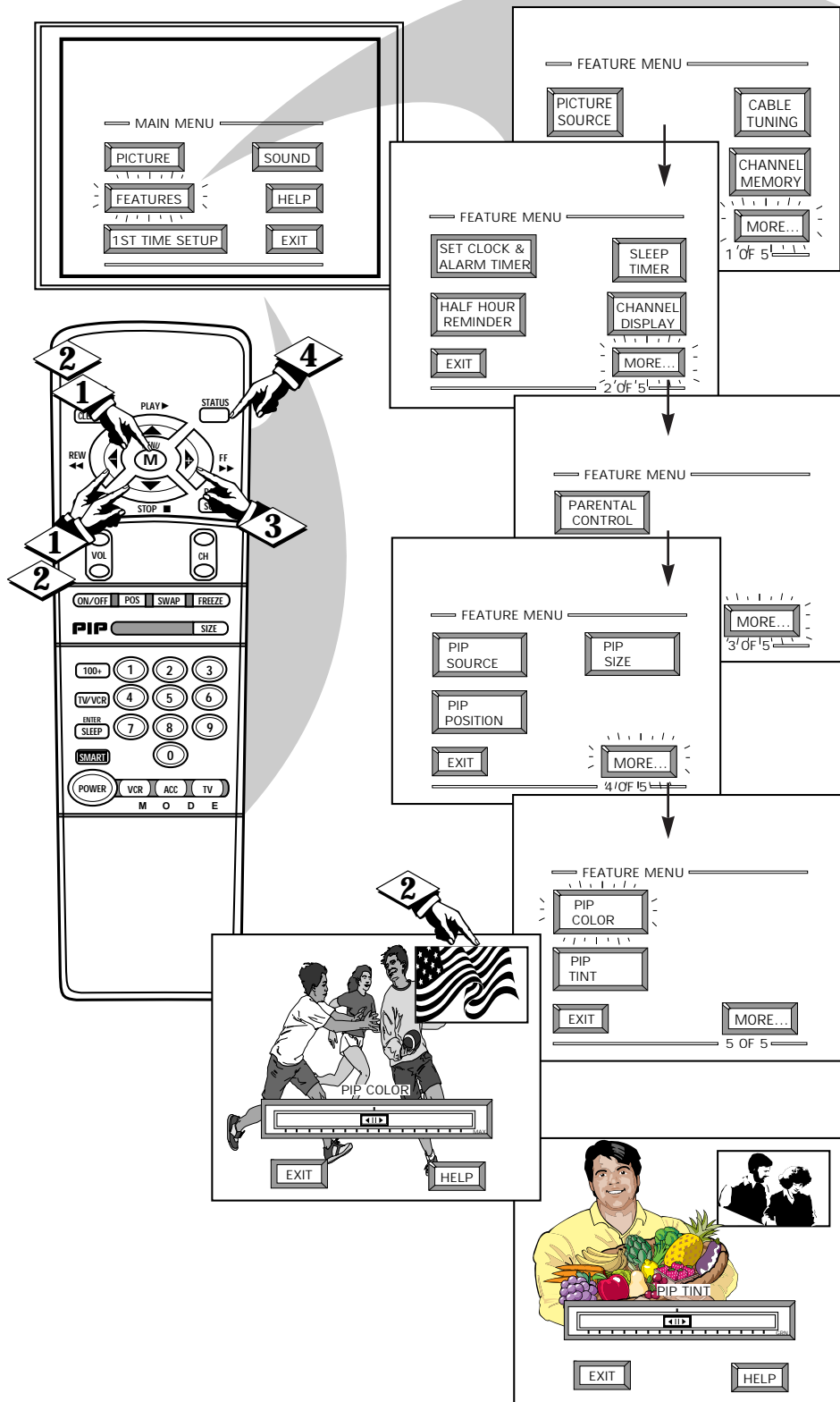

MORE PIP CONNECTIONS

The following example is for an alternative PIP hookup using an external Cable Converter Box and a VCR (as the picture source for the PIP window).

BEGIN

1 First use an optional signal splitter and connect the original cable TV signal to both the CABLE IN on the Cable Converter and the ANTENNA A plug on the rear of the TV.

2 Connect the CABLE OUT on the Converter to the ANT. IN on the VCR.

3 Connect the VIDEO OUT jack on the VCR to the VIDEO IN jack on the TV. Also connect the AUDIO OUT (R and L) jacks from the VCR to the AUDIO IN jacks on the TV.



SMART HELP 

Remember to use the Cable TV Converter Box to select channels for PIP, the VCR must be set to the same channel as the channel selection switch on the rear of the Cable Converter (either channel 3 or 4).

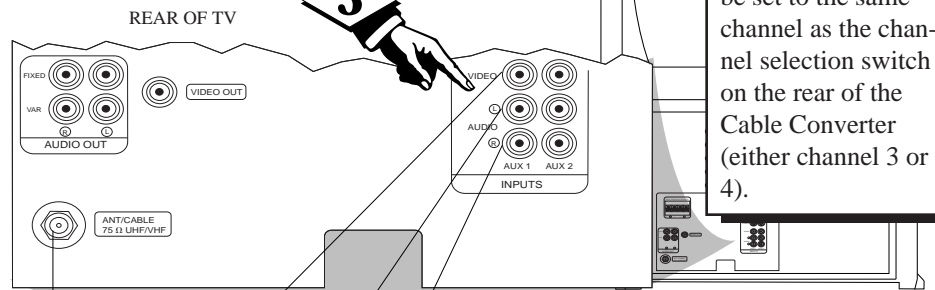

The ANTENNA signal input supplies the TV's Main screen picture, and the AUX 1 VIDEO Input connection from the VCR serves as the picture source for PIP. Be sure to set the TV's PIP SOURCE SELECT control to the "AUX 1 VIDEO" mode in order to display the Audio/Video Input signals within the PIP window.

AUDIO VIDEO CABLES (RCA Plug Cables - optional)

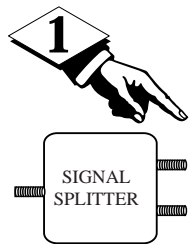

Contact the Parts Information Center 1 800 851-8885 to order any optional accessories

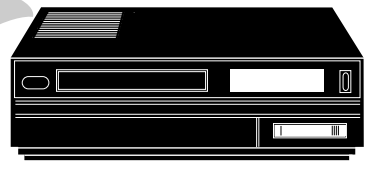
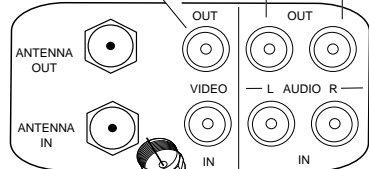

VCR

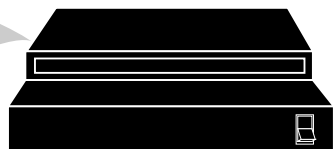
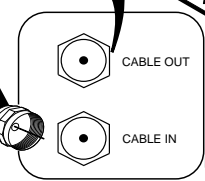

CABLE TV CONVERTER



The on screen *HELP* menu offers both *Operating Tips* and a list of *Glossary* definitions for different features on your TV. These items are given to provide you with more information and details on a select group of feature operations.

BEGIN

- 1 Select "HELP" on the TV's Main Menu.

Press the remote's Menu  buttons to move UP/DOWN and from SIDE-TO-SIDE within the list of on-screen features.

Press MENU (M) to select the highlighted "HELP" item.

- 2 Press the MENU  and then the MENU (M) buttons to select either the OPERATING TIPS or GLOSSARY item.

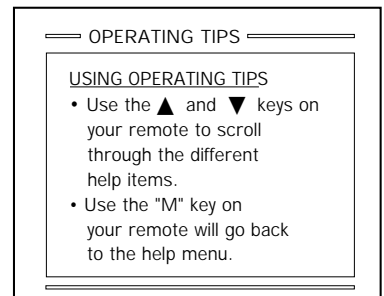
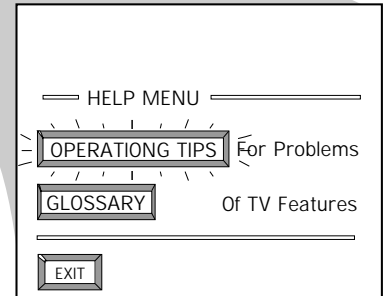
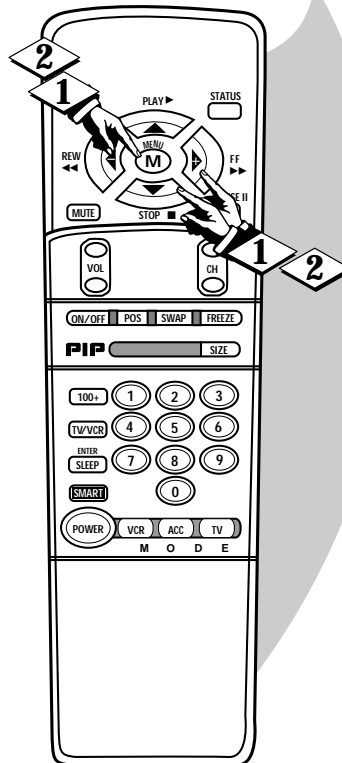
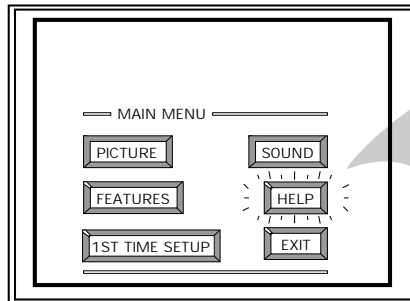

FOLLOW THE ON SCREEN DIRECTIONS TO VIEW OPERATING TIPS



Please make these simple checks before calling for service. These tips can save you time and money since charges for TV installation and adjustment of customer controls are not covered under your warranty.

No Power

CAUTION: A video source (such as a video game, Compact Disc Interactive - CDI, or TV information channel) which shows a constant non-moving pattern on the TV screen, can cause picture tube damage. When your TV is continuously used with such a source the pattern of the non-moving portion of the game (CDI, etc.) could leave an image permanently on the picture tube. When not in use, turn the video source OFF. Regularly alternate the use of such video sources with normal TV viewing.

- Check the TV power cord. Unplug the TV, wait 1 minute, then reinsert plug into outlet and push POWER button again.
- Check to be sure outlet is not on a wall switch.

No Picture

- Check antenna connections on the rear of the TV. Are they properly secured to the antenna plug on the TV?
- Check the CABLE TUNING control for correct position.
- Check PICTURE SOURCE control for correct position ANTENNA; AUX 1/AUX2 VIDEO; or AUX Y Pb Pr position without a signal source connection will result in a blank screen.
- Check the CLOSED CAPTIONS control. Some TEXT modes could block the screen.

No Sound

- Check the VOLUME buttons.
- Check the MUTE button on the remote control.
- Check the TV SPEAKER ON/OFF control for the correct position.
- If attempting auxiliary equipment hook-ups, check audio jack connections and that the auxiliary equipment is on and in the proper operating modes.

Remote Does Not Work

- Check VCR-ACC-TV "System" buttons on the remote. Press the remote's TV System button to send commands to the TV; VCR System to send to VCR; etc.
- Check batteries. Replace with AA Heavy Duty (Zinc Chloride) or Alkaline batteries if necessary.
- Clean the remote and the remote sensor window on the TV.

TV Displays Wrong Channel or No Channels Above 13

- Repeat channel selection.
- Add desired channel numbers (ADD/DELETE CHANNELS control) into TV memory.
- Check CABLE TUNING control for correct position.

This TV is equipped with protective circuitry that shuts the TV off in case of moderate power surges. Should this occur turn the TV back on by pressing the POWER button once or twice, or unplug and then replug the power cord at the AC outlet. This feature is NOT designed to prevent damage due to high power surges such as those caused by lightning, which is not covered by your warranty.

Cleaning and Care

- To avoid possible shock hazard be sure the TV is unplugged from the electrical outlet before cleaning.
- When cleaning the TV screen take care not to scratch or damage the screen surface (avoid wearing jewelry or using anything abrasive- do not use household cleaners). Wipe the front screen with a clean cloth dampened with water. Use even, easy, vertical strokes when cleaning.
- Specially designed screen cleaning kits are also available which contain anti-static cleaners and cloths designed to get into the ridges of the TV screen. If interested, ask your dealer about an optional Projection TV Screen Cleaning Kit or call our toll-free Accessory Parts ordering number 1-800-851-8885.
- Gently wipe the cabinet surfaces with a clean cloth or sponge dampened in a solution of cool clear water and a mild soap or detergent. Use a clean dry cloth to dry the wiped surfaces.
- Occasionally vacuum the ventilation holes or slots in the cabinet back.
- Never use thinners, insecticide sprays, or other chemicals on or near the cabinet, as they might cause permanent marring of the cabinet finish.



Audio/Video Inputs * Located on the rear of the TV these connectors (RCA phono type plug) are used for the input of audio and video signals. Designed for use with VCRs (or other accessories) in order to receive higher picture resolution and offer sound connection options.

Coaxial Cable * A single solid antenna wire normally matched with a metal plug (F-type) end connector that screws (or pushes) directly onto a 75 Ohm input found on the Television or VCR.

Display * An on screen message or graphics that help the user operate and adjust TV feature controls. See On Screen Displays (OSD).

Identify* Method by which a remote control searches and finds an operating code for another product (such as a VCR or Cable Converter). Once the code has been "identified" then the TV remote can operate and send commands to the other product.

LED * Light Emitting Diode or indicator.

Menu * An on-screen listing of feature controls shown on the TV screen that are made available for user adjustments.

Multichannel Television Sound (MTS) * The broadcast standard that allows for stereo sound to be transmitted with the TV picture.

On Screen Displays (OSD) * Refers to the wording or messages generated by the TV to help the user with specific feature controls (color adjustment, programming, etc.).

Picture -In-Picture (PIP) * Term used when two pictures are shown on the TV screen at the same time. The smaller PIP picture is supplied by a VCR (or other tuner/video playback source). The PIP picture can also be moved and swapped with the TV's main screen picture.

Pre-Amplifier * The control center of a hi-fi system. Not only amplifies source inputs, but also allows for source selection, volume, tone, balance and all other controls that affect the sound.

Programming * The procedure of adding or deleting channel numbers into the TV's memory circuits. In this way the TV "remembers" only the locally available or desired channel numbers and skips over any unwanted channel numbers.

PTV * Projection Television (Rear and/or Front projection design systems are available.)

Remote Sensor Window * A window or opening found on the TV control panel through which infrared remote control command signals are received.

RF * Radio Frequency or modulated signal design used as the carrier for television broadcasts.

Second Audio Program (SAP) * Another or additional audio channel provided for in the Multichannel Television Sound (MTS) broadcast standard. A monaural soundtrack included within the recorded or video signal (usually containing a second language translation for the displayed programming.)

Status * Allows the user to quickly confirm what channel number is currently being viewed. Status can also be used to clear the TV of on-screen displays or information (rather than waiting for the displays to "time out" or automatically disappear from the screen).

S-Video Input * Allows direct connection of high-resolution video sources, such as a Super VHS videocassette recorder, Laser Disc player, etc. Provides improved picture resolution, sharpness, and clarity.

Twin Lead Wire * The more commonly used name for the two strand 300 Ohm antenna wire used with many indoor and outdoor antenna systems. In many cases this type of antenna wire requires an additional adapter (or balun) in order to connect to the 75 Ohm Input terminals designed into the more recent Televisions and VCRs.

Variable Audio Output * An adjustable audio output which allows for volume variations at the source.



Accessories/Optional	26-27, 28-31, 45	*Q/U-1	Picture-In-Picture (PIP)	40-45
Adapter Connector	40, 45,	*Q/U-1	Power Light Indicator	*Q/U-3
Add/Delete Channels	12-13,	*Q/U-2	Precautions/Safety	2, 3, 46, 52, *Q/U-1
Audio Controls	23-26		Programming Channels	12, *Q/U-2
Audio/Video Input	28-30, 40, 45,	*Q/U-2	Remote Control	32-39, 42, *Q/U-2, 3, 4
Automatic Programming	12,	*Q/U-2	Remote with VCRs	34-39
Battery Installation		*Q/U-3	Requesting Service	46, 50-51
Cable TV Connections/Settings	11, 40, 45,	*Q/U-1, 2	RF Coaxial Cable	40, 45, *Q/U-1
Channel/Time Display	14, 22,	*Q/U-3	Reminder/Time and Channel	14
Channel Memory	12-13,	*Q/U-2	Safety/Precautions	2, 3, 46, *Q/U-1
Channel/Time Reminder	14		Second Audio Program (SAP)	24
Clock Setting	14		Sensor Remote	*Q/U-3
Clock Timer	15		Sleep Timer	15
Closed Captioning	10		Smart Button	32-33
Color Controls	6,	*Q/U-4	Smart Picture	32
Component Video Input	30		Smart Sound	32
Content Advisory	18-21		Smart Surf	33
Controls/TV		*Q/U-2, 3, 4	Sound Image	25
Controls/Remote	32-39, 42,	*Q/U-2, 3, 4	Surf Button	33
Convergence	8		Status Button	*Q/U-3, 4
Exit		*Q/U-4	Surround Sound	27
Features	5		Speaker Terminals	27
First Time Set Up		*Q/U-2	Time/Channel Display	14, 22, *Q/U-3
Glossary/TV Terms	48		Timer (Turn On)	15
Help Menu	47,	*Q/U-2, 4	TV/VCR Button	39, *Q/U-3
Inputs/Audio and Video	28-30, 40, 45		VCR/TV Connections	28-31, 40, 45, *Q/U-1
Language Control	22,	*Q/U-2	Tips for Service	46, 50-51
Menu		*Q/U-2, 4	TV Speaker Control	26
Minus(-)/Plus (+) Buttons		*Q/U-3, 4	Warranty	52
Parental Control	16-21			

* Information contained in Quick-Use (Q/U) Guide - page listed

Philips Consumer Electronics Company Factory Service Center Locations

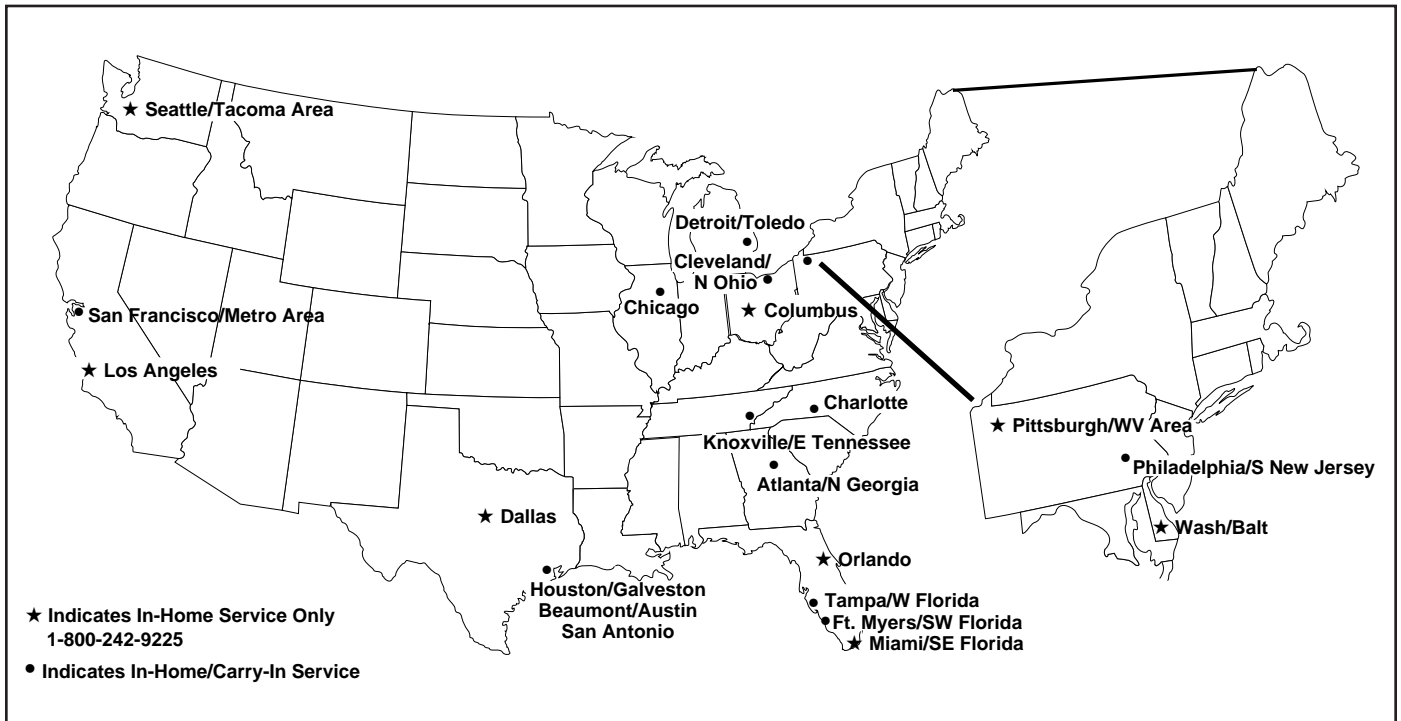

NOTE: If you reside in one of our Philips Factory Service Branch areas (see directory on back), you can contact the nearest Service Branch to obtain efficient and expedient repair for your product. If your product is In-Warranty, you should have proof-of-purchase to ensure No Charge Service. For Out-of-Warranty service, call the location nearest you.

NOTA: Si vous résidez dans une des régions desservies par une succursale de service après vente du fabricant Philips (voir liste ci-dessous), vous pourrez contacter la branche de service après vente la plus près de chez vous pour obtenir un service après vente rapide et efficace. Si le produit est sous garantie, il suffira de présenter une preuve d'achat pour bénéficier d'un service sans frais. Pour les produits non couverts par la garantie, contactez le centre le plus près de chez vous.

NOTA: Si Ud. reside en una de nuestras zonas para sucursales Philips de servicio al de fábrica (ver directorio más abajo), Ud. puede comunicarse con la sucursal de servicio más cercana para obtener una reparación oportuna y eficaz de su producto. Si su producto está todavía bajo garantía, Ud. debe presentar comprobante de compra para no ocasionar ningunos cargos por servicio. Para servicio después del vencimiento de la garantía, llame al lugar más cercano de los abajo indicados.

In Canada

How you can obtain efficient and expedient carry-in, mail-in, or in-home service for your product

Please contact Philips at

1-800-661-6162 (French speaking)

1-800-363-7278 (English speaking)

Au Canada

Comment obtenir le service après-vente pour les produits apportés ou envoyés par la poste à notre centre de service ou le service à domicile

Veillez contacter philips à:

1-800-661-6162 (Francophone)

1-800-363-7278

En el Canadá

Cómo recibir servicio eficiente para su producto, en persona, por correo o a domicilio

Favor de comunicarse con Philips al:

1-800-661-6162 (francófono)

1-800-363-7278 (anglófono)

QUALITY SERVICE IS AS CLOSE AS YOUR TELEPHONE! SIMPLY LOOK OVER THE LIST BELOW FOR THE NUMBER OF A FACTORY SERVICE CENTER NEAR YOU. YOUR PRODUCT WILL RECEIVE EFFICIENT AND EXPEDIENT CARRY-IN, MAIL-IN, OR IN-HOME SERVICE, AND YOU WILL RECEIVE PEACE OF MIND, KNOWING YOUR PRODUCT IS BEING GIVEN THE EXPERT ATTENTION OF PHILIPS' FACTORY SERVICE. AND, IF THE PHONE NUMBER LISTED FOR YOUR AREA IS LONG DISTANCE, CALL 1-800-242-9225 FOR FACTORY SERVICE.

COMMENT OBTENIR NOTRE SERVICE APRÈS VENTE RAPIDE ET EFFICACE SOIT PAR COURRIER, À DOMICILE, OU EN SE PRÉSENTANT À UN CENTRE DE SERVICE PHILIPS. PLUS DE 600 CENTRES DE RÉCEPTION DE PRODUITS À RÉPARER À TRAVERS LE PAYS: CONTACTER LE CENTRE DE SERVICE AUX CONSOMMATEURS LE PLUS PROCHE POUR SAVOIR L'EMPLACEMENT DE CES DÉPÔTS DANS UN RAYON DE 50 À 75 MILES (80 KM À 120 KM) DU CENTRE DE SERVICE LOCAL.

CÓMO OBTENER UN SERVICIO OPORTUNO Y EFICIENTE POR CORREO, EN CASA O EN PERSONA PARA SU PRODUCTO A TRAVÉS DE UN CENTRO PHILIPS DE SERVICIO. MAS DE 600 SITIOS POR TODO EL PAIS PARA LA RECEPCION DE PRODUCTOS NECESITADOS DE REPARACIONES: COMUNICARSE CON EL CENTRO DE SERVICIO DE FABRICA MAS CERCAÑO PARA ESTOS LUGARES DENTRO DE UN RADIO DE 80 A 120 KM (50 A 75 MILLAS) DEL CENTRO DE SERVICIO LOCAL.

GEORGIA Philips Factory Service of Georgia 200 N. Cobb Pkwy., Suite 120 Marietta, GA 30062 (770) 795-0085	CENTRAL U.S.A. Philips Factory Service Central US 950 Keynote Circle Brooklyn Heights, OH 44131 (216) 741-3334	ILLINOIS Philips Factory Service of Illinois 1279 W. Hamilton Pkwy. Itasca, IL 60143 (630) 775-0990
FLORIDA Philips Factory Service of Florida 1911 US Highway 301 North Tampa, FL 33619 (813) 621-8181	MICHIGAN Philips Factory Service of Michigan 25173 Dequindre Madison Heights, MI 48071 (248) 544-2110	TENNESSEE Philips Factory Service of East Tennessee 6700 D Papermill Rd. Knoxville, TN 37919 (423) 584-6614
WESTERN U.S.A. Philips Factory Service Western Region 681 East Brokaw Rd. San Jose, CA 95112 (408) 436-8566	DALLAS AREA Philips Factory Service of Dallas 415 N. Main Street, #107 Euless, TX 76040 (713) 682-3990	MID-ATLANTIC Philips Factory Service Mid-Atlantic 352 Dunks Ferry Rd. Bensalem, PA 19020 (215) 638-7500
TEXAS Philips Factory Service of Texas 1110 N. Post Oak Rd., Suite 100 Houston, TX 77055 (713) 682-3990		

LIMITED WARRANTY

PROJECTION TELEVISION

One Year Free Labor

One Year Free Service on Parts

Two Years Free Service on Cathode Ray Tube Parts / 30 days Free Service on Projection TV Screen

This product can be repaired in-home.

WHO IS COVERED?

You must have proof of purchase to receive warranty service. A sales receipt or other document showing that you purchased the product is considered proof of purchase.

WHAT IS COVERED?

Warranty coverage begins the day you buy your product. For one year thereafter (30 days for the projection TV screen), all parts will be repaired or replaced, and labor and transportation are free. From one to two years from the day of purchase, you pay for the replacement or repair of all parts except the cathode ray tube and the "Clear-Vu" lens, and for all labor and transportation charges. After two years from the day of purchase, you pay for the replacement or repair of all parts except the "Clear-Vu" lens (which is guaranteed against manufacturer's defects for the life of the product), and for all labor and transportation charges.

All parts, including repaired and replaced parts, are covered only for the original warranty period. When the warranty on the product expires, the warranty on all replaced and repaired parts also expires.

WHAT IS EXCLUDED?

Your warranty does not cover:

- labor charges for installation or setup of the product, adjustment of customer controls on the product, and installation or repair of antenna systems outside of the product.
- product repair and/or part replacement because of misuse, accident, unauthorized repair or other cause not within the control of Philips Consumer Electronics Company.
- reception problems caused by signal conditions or cable or antenna systems outside the unit.
- a product that requires modification or adaptation to enable it to operate in any country other than the country for which it was designed, manufactured, approved and/or authorized, or repair of products damaged by these modifications.
- incidental or consequential damages resulting from the product. (Some states do not allow the exclusion of incidental or consequential damages, so the above exclusion may not apply to you. This includes, but is not limited to, prerecorded material, whether copyrighted or not copyrighted.)
- a product used for commercial or institutional purposes.

WHERE IS SERVICE AVAILABLE?

Warranty service is available in all countries where the product is officially distributed by Philips Consumer Electronics Company. In countries where Philips Consumer Electronics Company does not distribute the product, the local Philips service organization will attempt to provide service (although there may be a delay if the appropriate spare parts and technical manual(s) are not readily available).

MAKE SURE YOU KEEP...

Please keep your sales receipt or other document showing proof of purchase. Attach it to this owner's manual and keep both nearby. Also keep the original box and packing material in case you need to return your product.

BEFORE REQUESTING SERVICE...

Please check your owner's manual before requesting service. Adjustments of the controls discussed there may save you a service call.

TO GET WARRANTY SERVICE...

Repair must be performed by an authorized service center or a factory service center. *If you do not live near a factory service center, contact your dealer.* If your dealer is an authorized service center, he will arrange repair. If your dealer is not an authorized service center, he will direct you to the authorized service center engaged by him to service the products he sells.

(In U.S.A., Puerto Rico and U.S. Virgin Islands, all implied warranties, including implied warranties of merchantability and fitness for a particular purpose, are limited in duration to the duration of this express warranty. But, because some states do not allow limitations on how long an implied warranty may last, this limitation may not apply to you.)

(In Canada, this warranty is given in lieu of all other warranties. No other warranties are expressed or implied, including any implied warranties of merchantability or fitness for a particular purpose. Philips is not liable under any circumstances for any direct, indirect, special, incidental or consequential damages, howsoever incurred, even if notified of the possibility of such damages.)

IF YOU HAVE QUESTIONS...

Please contact Philips at:

1-800-661-6162 (French Speaking)

1-800-363-7278 (English Speaking)

REMEMBER...

Please record the model and serial numbers found on the product below. Also, please fill out and mail your warranty registration card promptly. It will be easier for us to notify you if necessary.

MODEL # _____

SERIAL # _____



This warranty gives you specific legal rights. You may have other rights which vary from state/province to state/province.

Philips Service Company, P.O. Box 2976, Longview, TX 75606, (903) 242-4800

Free Manuals Download Website

<http://myh66.com>

<http://usermanuals.us>

<http://www.somanuals.com>

<http://www.4manuals.cc>

<http://www.manual-lib.com>

<http://www.404manual.com>

<http://www.luxmanual.com>

<http://aubethermostatmanual.com>

Golf course search by state

<http://golfingnear.com>

Email search by domain

<http://emailbydomain.com>

Auto manuals search

<http://auto.somanuals.com>

TV manuals search

<http://tv.somanuals.com>