

# Always there to help you

Register your product and get support at  
[www.philips.com/welcome](http://www.philips.com/welcome)

MCD2160



# User Manual

# PHILIPS

# Contents

---

<b>1 Important</b>	<b>3</b>
Safety	3

---

<b>2 Your micro system</b>	<b>5</b>
Introduction	5
What's in the box	5
Overview of the main unit	6
Overview of the remote control	7

---

<b>3 Connect</b>	<b>8</b>
Place the unit	8
Connect speakers	8
Connect video cables	8
Connect an external audio device	9
Connect power	9

---

<b>4 Get started</b>	<b>10</b>
Prepare the remote control	10
Set clock	10
Turn on	10
Find the correct viewing channel	11
Select the correct TV system	11
Change system menu language	11
Turn on Progressive Scan	11

---

<b>5 Play</b>	<b>12</b>
Play from disc	12
Play from USB or recored discs	12
Play a slideshow with background music	13
Resume video play from last stopped point	13
Control play	13
Play options	14
Change the audio channel	14

---

<b>6 Enjoy karaoke</b>	<b>15</b>
Adjust Karaoke settings	15

---

<b>7 Listen to the radio</b>	<b>16</b>
Tune to a radio station	16
Program radio stations automatically	16
Program radio stations manually	16
Select a preset radio station	16

---

<b>8 Other features</b>	<b>17</b>
Set the alarm timer	17
Set the sleep timer	17
Listen to an external device	17

---

<b>9 Adjust settings</b>	<b>18</b>
General setup	18
Video setup	18
Audio setup	18
Preferences	19

---

<b>10 Product information</b>	<b>20</b>
Specifications	20
Supported disc formats	21
USB playability information	21

---

<b>11 Troubleshooting</b>	<b>22</b>
---------------------------	-----------

---

<b>12 Notice</b>	<b>24</b>
------------------	-----------

# 1 Important

## Safety



This 'bolt of lightning' indicates uninsulated material within the device may cause an electrical shock. For the safety of everyone in your household, please do not remove the covering.

The 'exclamation mark' calls attention to features for which you should read the enclosed literature closely to prevent operating and maintenance problems.

**WARNING:** To reduce the risk of fire or electric shock, the device should not be exposed to rain or moisture and objects filled with liquids, such as vases, should not be placed on the device.

**CAUTION:** To prevent electric shock, fully insert the plug. (For regions with polarized plugs: To prevent electric shock, match wide blade to wide slot.)

## Important Safety Instructions

- Follow all instructions.
- Heed all warnings.
- Do not use this device near water.
- Clean only with dry cloth.
- Do not block any ventilation openings. Install in accordance with the manufacturer's instructions.
- Do not install near any heat sources such as radiators, heat registers, stoves, or other devices (including amplifiers) that produce heat.

- Protect the power cord from being walked on or pinched, particularly at plugs, convenience receptacles, and the point where they exit from the device.
- Only use attachments/accessories specified by the manufacturer.
- Use only with the cart, stand, tripod, bracket, or table specified by the manufacturer or sold with the device. When a cart is used, use caution when moving the cart/device combination to avoid injury from tip-over.



- Unplug this device during lightning storms or when unused for long periods of time.
- Refer all servicing to qualified service personnel. Servicing is required when the device has been damaged in any way, such as power-supply cord or plug is damaged, liquid has been spilled or objects have fallen into the device, the device has been exposed to rain or moisture, does not operate normally, or has been dropped.
- Battery usage **CAUTION** – To prevent battery leakage which may result in bodily injury, property damage, or damage to the unit:
  - Install all batteries correctly, + and - as marked on the unit.
  - Do not mix batteries (old and new or carbon and alkaline, etc.).
  - Batteries (packed or installed) shall not be exposed to excessive heat such as sunshine, fire or the like.
  - Remove batteries when the unit is not used for a long time.
- The device shall not be exposed to dripping or splashing.
- Do not place any sources of danger on the device (e.g. liquid filled objects, lighted candles).

- Where the MAINS plug or an appliance coupler is used as the disconnect device, the disconnect device shall remain readily operable.



### Warning

- Never remove the casing of this device.
- Never lubricate any part of this device.
- Never place this device on other electrical equipment.
- Keep this device away from direct sunlight, naked flames or heat.
- Never look into the laser beam inside this device.
- Ensure that you always have easy access to the power cord, plug, or adaptor to disconnect this device from the power.

## 2 Your micro system

Congratulations on your purchase, and welcome to Philips! To fully benefit from the support that Philips offers, register your product at [www.philips.com/welcome](http://www.philips.com/welcome).

### Introduction

With this unit, you can:

- Watch video from DVD/VCD/SVCD, or USB storage devices;
- enjoy audio from discs, USB storage devices, or other external devices;
- enjoy Karaoke by connecting a microphone.
- view pictures from discs or USB storage devices;
- listen to FM radio stations.

You can enrich sound output with below sound effect:

- Digital Sound Control (DSC)
  - DSC 1: Balanced
  - DSC 2: Clear
  - DSC 3: Powerful
  - DSC 4: Warm
  - DSC 5: Bright

The unit supports these media formats:



DVD region code	Countries
	Europe

### What's in the box





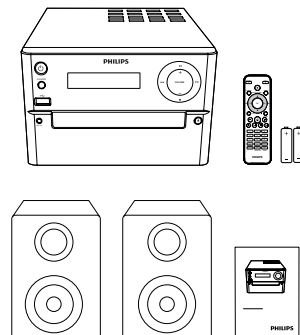

Check and identify the contents of your package:

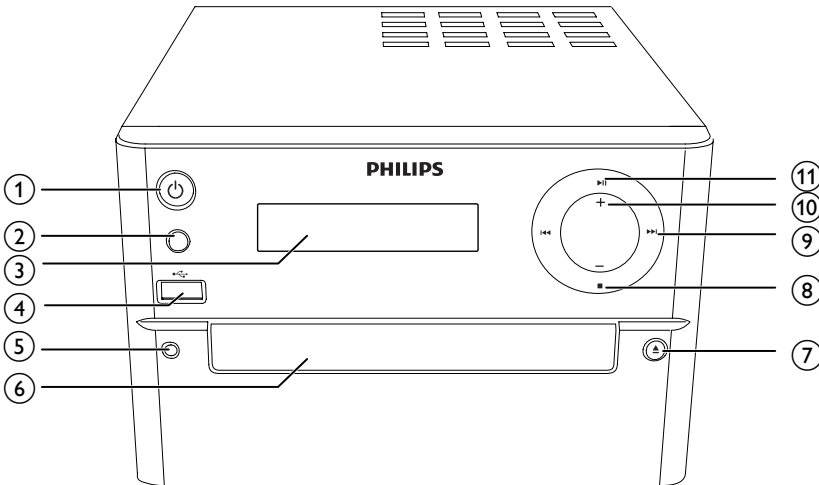
- Main unit
- 2 x speakers
- 1 x composite video cable (yellow)
- Remote control (with two AAA batteries)
- User manual



## Overview of the main unit



- ① 
  - Turn the unit on or off.
  - Switch to standby mode or Eco standby mode.
- ② **SOURCE**
  - Select a source: DISC, USB, FM, AUX.
- ③ **Display panel**
  - Show current status.
- ④ 
  - Jack for a USB device.
- ⑤ **MIC IN**
  - Connect a microphone.
- ⑥ **Disc compartment**
- ⑦ 
  - Open/close the disc compartment.
- ⑧ 
  - Stop play.
- ⑨ 
  - Skip to the previous/next track.
  - Press to tune to a radio station.
  - Press and hold to search for radio stations automatically.
- ⑩ **VOLUME +/-**
  - Adjust volume.
- ⑪ 
  - Start, pause, or resume play.

## Overview of the remote control

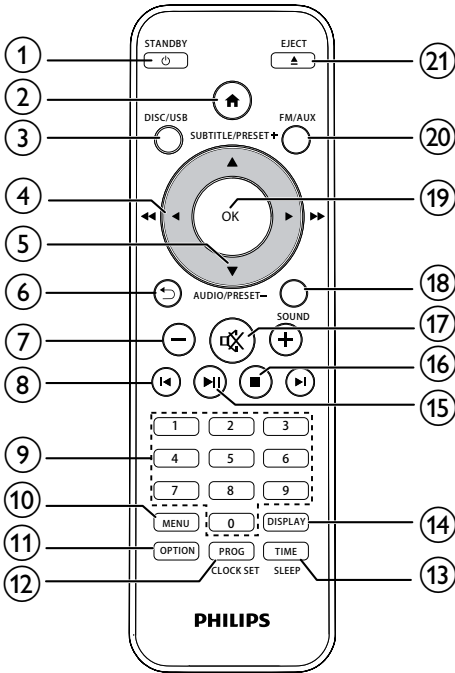

### ① **⏻/STANDBY**

- Turn the unit on or off.
- Switch to standby mode or Eco standby mode.

### ② **🏠**

- Access the system menu.

### ③ **DISC/USB**

- Select DISC or USB source.

### ④ **◀/▶ (◀◀/▶▶)**

- Navigate through the menu.
- Search within a track/disc/USB.
- Tune to a radio station.

### ⑤ **▲/▼**

- Navigate through the menu.
- Skip to previous/next album.
- Select a preset radio station.
- Set subtitle or audio language.
- Set time.

### ⑥ **↶**

- Return to previous display menu.

### ⑦ **+/-**

- Adjust volume.

### ⑧ **◀|▶**

- Skip to previous or next title, chapter, track, or file.

### ⑨ **Numeric buttons**

- Select a title/chapter/track to play.
- Select a preset number.

### ⑩ **MENU**

- Access the DISC/USB menu.

### ⑪ **OPTION**

- In DISC/USB play mode, press to select preferred play options.

### ⑫ **PROG/CLOCK SET**

- Program radio stations.
- Set the clock.
- View clock information.

### ⑬ **TIME/SLEEP**

- Set alarm timer or sleep timer.

### ⑭ **DISPLAY**

- View playback information.

### ⑮ **▶||**

- Start, pause, or resume play.

### ⑯ **■**

- Stop play.
- During scanning, press to stop the process.

### ⑰ **🔇**

- Mute or restore volume.

### ⑱ **SOUND**

- Enrich sound effect with Digital Sound Control (DSC).

### ⑲ **OK**

- Confirm a selection.

### ⑳ **FM/AUX**

- Select FM or AUX source.

### ㉑ **EJECT ▲**

- Press to open or close the disc compartment.

# 3 Connect

## Place the unit

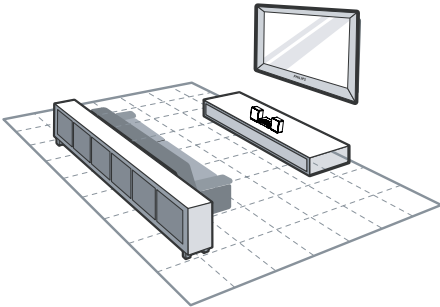

- 1 Place the unit near to the TV.
- 2 Place the left and right speakers at equal distance from the TV and at an angle of approximately 45 degrees from the listening position.

### Note

- To avoid magnetic interference or unwanted noise, never place this apparatus and speakers too close to any radiation devices.
- Place this unit on top of a table or mount it on the wall.
- Never place this unit in an enclosed cabinet.
- Install this unit near the AC outlet where the AC power plug can be easily reached.

## Connect speakers

### Note

- For optimal sound, use the supplied speakers only.
- Connect only speakers with impedance that is the same or higher than the supplied speakers. Refer to the Specifications section of this manual.

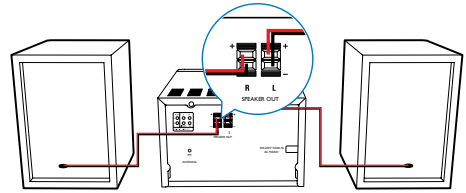

## Connect video cables

You can select the best video connection that your TV supports.

- **Option 1:** Connect through a composite video (CVBS) cable (for a standard TV).
- **Option 2:** Connect through component video cables (for a standard TV or Progressive Scan TV).

### Option 1: Connect through a composite video cable

Connect the composite video cable (supplied) to:

- the **VIDEO** socket on the back of the unit.
- the video input socket on the TV.

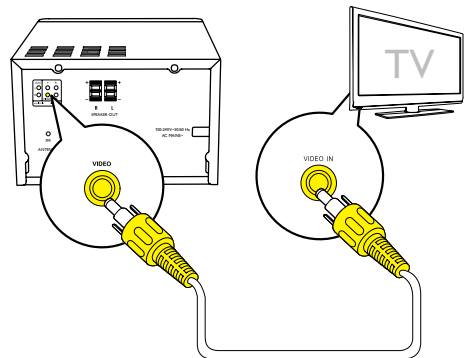



## Option 2: Connect through component video cables

### Note

- The progressive scan video quality is only available when a progressive scan TV is connected.
- If your TV does not support progressive scan, you cannot view the picture.
- For how to activate progressive scan on your TV, refer to the TV user manual.

Connect a progressive scan TV through component video for higher quality video. Connect component video cables (green/red/blue - not supplied) to:

- the component (**Y**, **Pr**, and **Pb**) sockets on the back of the unit.
- the component input sockets on the TV.

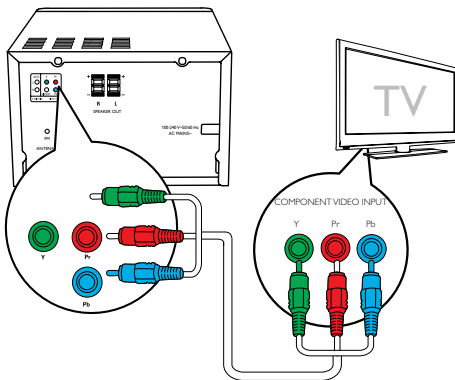

## Connect an external audio device

Connect audio cables (red/white - not supplied) to:

- the **AUDIO IN** (**L** and **R**) sockets on the back of the unit.
- the audio output sockets on the external audio device.

## Connect power

### Caution

- Risk of product damage! Ensure that the power supply voltage corresponds to the voltage printed on the back or the underside of the unit.
- Risk of electric shock! When you unplug the AC power cord, always pull the plug from the socket. Never pull the cord.
- Before you connect the AC power cord, ensure that you have completed all other connections.

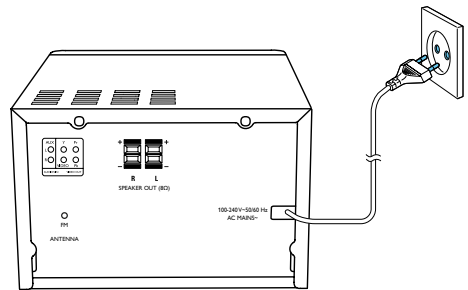

## 4 Get started

### ! Caution

- Use of controls or adjustments or performance of procedures other than herein may result in hazardous radiation exposure or other unsafe operation.

Always follow the instructions in this chapter in sequence.

If you contact Philips, you will be asked for the model and serial number of this apparatus. The model number and serial number are on the back of the apparatus. Write the numbers here:

Model No. \_\_\_\_\_

Serial No. \_\_\_\_\_

## Prepare the remote control

### ! Caution

- Risk of explosion! Keep batteries away from heat, sunshine or fire. Never discard batteries in fire.
- Risk of decreased battery life! Never mix different brands or types of batteries.
- Risk of product damage! When the remote control is not used for long periods, remove the batteries.

To insert the remote control battery:

- 1 Open the battery compartment.
- 2 Insert the supplied AAA batteries with correct polarity (+/-) as indicated.
- 3 Close the battery compartment.

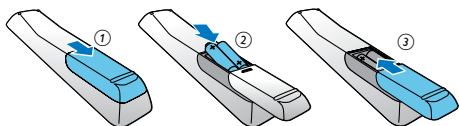

## Set clock

- 1 In standby mode, press and hold **CLOCK SET** on the remote control for more than two seconds.  
↳ [24H] or [12H] hour format is displayed.
- 2 Press **▲ / ▼** (or **+/-**) to select [24H] or [12H] hour format, and then press **CLOCK SET**.  
↳ The hour digits are displayed and begin to blink.
- 3 Press **▲ / ▼** (or **+/-**) to set hour; and then press **CLOCK SET**.  
↳ The minute digits are displayed and begin to blink.
- 4 Repeat step 3 to set minute.

### ≡ Note

- If no button is pressed in 90 seconds, the system exits clock setting mode automatically.

### ✦ Tip

- You can view clock information in Eco power mode by pressing **CLOCK SET**.

## Turn on

- Press **⏻**.
- ↳ The unit switches to the last selected source.

## Switch to standby mode

- Press **⏻** again to switch the unit to standby mode.
- ↳ The clock (if set) is displayed on the panel.

## Switch to ECO standby mode:

- Press and hold **⏻** for more than two seconds.
- ↳ The display panel is dimmed.

## Note

- The unit switches to Eco Power Standby mode after 15 minutes in standby mode.

### Switch between standby mode and ECO standby mode:

Press and hold  for more than two seconds.

## Find the correct viewing channel

- 1 Press **DISC** to switch to disc mode.
- 2 Turn on the TV and switch to the correct video-in channel in one of the following ways:
  - Go to the lowest channel on your TV, and then press the Channel Down button until you see the blue screen.
  - Press the source button repeatedly on the remote control of your TV.



## Tip

- The video-in channel is between the lowest and highest channels and may be called FRONT, A/V IN, VIDEO etc. See the TV user manual on how to select the correct input on the TV.



## Select the correct TV system

Change this setting if the video is not displayed correctly. By default, this setting matches the most common setting for TVs in your country.

- 1 Press .
- 2 Select **[Setup]** (Setup) -> **[Video]** (Video) -> **[TV System]**(TV System).
- 3 Select a setting and press **OK**.
  - **[PAL]** (PAL) - For TV with PAL color system.
  - **[Multi]** (Multi) - For TV that is compatible with both PAL and NTSC.
  - **[NTSC]** (NTSC) - For TV with NTSC color system.

- 4 To return to the previous menu, press .
- 5 To exit the menu, press .

## Change system menu language

- 1 Press .
- 2 Select **[Setup]** (Setup) -> **[General]** (General) -> **[OSD Language]** (OSD Language), and press **OK**.
- 3 Select a setting and then press **OK**.
- 4 To exit the menu, press .

## Turn on Progressive Scan

Progressive scan displays twice the number of frames per seconds than interlaced scanning (ordinary TV system). With nearly double the number of lines, progressive scan offers higher picture resolution and quality.

Before you turn on this feature, make sure that:

- the TV supports progressive scan signals.
- you have connected the unit with the TV through component video.

- 1 Turn on the TV.
- 2 Make sure that the TV progressive scan mode is deactivated (see the TV user manual).
- 3 Switch the TV to the correct viewing channel for this unit.
- 4 Press **DISC**, and then press .
- 5 Select **[Setup]** (Setup) -> **[Video]** (Video) -> **[Progressive]** (Progressive) -> **[On]** (on), and then press **OK**.
  - ↳ The progressive setup is complete.

# 5 Play

## Play from disc

### ! Caution

- Risk of product damage! Never play discs with accessories such as disc stabilizer rings or disc treatment sheets.
- Never put any objects other than discs into the disc compartment.

- 1 Press **DISC** repeatedly to select **DISC** source. [Fig. 9]
- 2 Press **▲** to open the disc compartment.
- 3 Insert a disc with the printed side facing upward.
- 4 Press **▲** to close the disc compartment.  
↳ Play starts automatically.

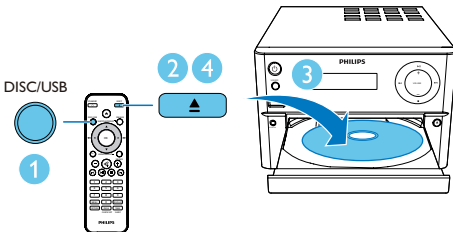

**If play does not start automatically:**  
Select a title/chapter/track and then press **▶||**.

### \* Tip

- To play a locked DVD, enter the 6-digit parental control password.

## Use the disc menu

When you load a DVD/(S)VCD disc, a menu may be displayed on the TV screen. Press **MENU** to access or exit disc menu manually.

## For VCD with PlayBack Control (PBC) feature (version 2.0 only):

With the PBC feature, you can play VCD interactively according to the menu screen. During play, press **MENU** to enable/disable PBC.

- ↳ When PBC is enabled, the menu screen is displayed.
- ↳ When PBC is disabled, normal play is resumed.

## Select an audio language

During disc play, press **AUDIO** to select an audio language for a DVD or DivX (Home Theater 3.1) video.

- ↳ The language options are displayed. If the selected audio channel is unavailable, the default disc audio channel is used.

### ≡ Note

- For some DVDs, the language can only be changed from the disc menu. Press **MENU** to access the menu.

## Select a subtitle language

During play, press **SUBTITLE** repeatedly to select a subtitle language for a DVD or DivX (Home Theater 3.1) video.

### ≡ Note

- For some DVDs, the language can only be changed from the disc menu. Press **MENU** to access the disc menu.

## Play from USB or recorded discs

You can play DivX (Home Theater 3.1)/MP3/JPEG picture files copied onto a CD-R/RW, recordable DVD, or USB storage device.

- 1 Select a source.
  - Press **DISC/USB** repeatedly to select DISC or USB source.
- 2 Insert the USB storage device or disc.
  - ↳ The play starts automatically.

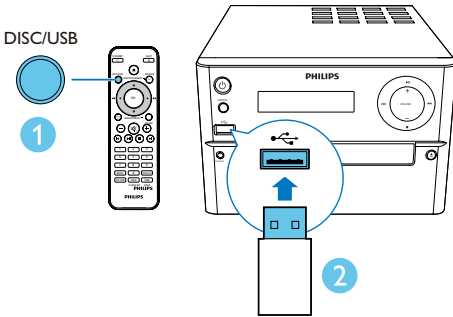

To select a specified file to play:

- 1 Press **■** to stop play.
- 2 Press **▲** / **▼** to select a folder, and then press **OK** to confirm.
  - To return to the previous menu, press **↶**.
- 3 Press **▲** / **▼** to select a file from the folder.
- 4 Press **▶||** to start play.

#### Note

- You can only play DivX (Home Theater 3.1) videos rented or purchased through the DivX registration code of this unit.
- Subtitle files with the following filename extensions (.srt, .smi, .sub, .ssa, .ass) are supported but do not appear on the file navigation menu.
- The subtitle filename has to be the same as the file name of the video.

## Play a slideshow with background music

This device can play MP3 files and JPEG photos simultaneously.

#### Note

- The MP3 and JPEG files must be stored on the same disc or USB storage device.

- 1 Play an MP3 file.
- 2 Navigate to the photo folder/album and press **▶||** to start the slideshow.
  - ↳ Slideshow begins and continues till the end of the photo folder or album.
  - ↳ Audio continues till the end of the last file.
    - To return to the previous menu, press **↶**.
    - To stop the slideshow, press **■**.

## Resume video play from last stopped point

#### Note

- This feature is only available for CD/DVD/VCD/DivX play.

In stop mode and when the disc has not been removed, press **▶||**.

To cancel resume mode and stop play completely:

In stop mode, press **■**.

## Control play

<b>▲</b> / <b>▼</b>	Select a folder.
<b>◀</b> / <b>▶</b> ( <b>&lt;&lt;</b> / <b>&gt;&gt;</b> )	Fast backward/forward.
<b>◀</b> / <b>▶</b>	Skip to previous or next title/ chapter/track/file.
<b>▶  </b>	Pause or resume play.
<b>■</b>	Stop play.
<b>+/-</b>	Increase or decrease the volume.
<b>⊗</b> (mute)	Mute or restore sound.

<b>SOUND</b> (sound)	Enrich sound effect with DSC: balanced, clear, powerful, warm, and bright.
<b>DISPLAY</b> (display)	View playback information.

## Play options

In **DISC/USB** play mode, press **OPTION** (option) to select different play options.

- **[PBC]** (PBC): turn PlayBack Control on/off.
- **[Aspect Ratio]**(Aspect ratio): select a picture display format to fit the TV screen.
- **[Angle]** (Angle): switch between camera angles.

### Note

- Some DVDs contain alternate scenes, such as scenes recorded from different camera angles. For such DVDs, you can select from the available alternate scenes.

- **[Microphone]** (Microphone): turn on or off the microphone sound output.
- **[Karaoke Setup]**(karaoke Setup): set different volumes of karaoke disc.
- **[Vocal]** (Vocal): select various Karaoke audio modes, or turn off original vocal.
- **[Zoom]** (Zoom): during video play, zoom in/out to pan through the image.
- **[Repeat]** (Repeat): choose a repeat play option or turn off the repeat function.
- **[GOTO]** (Goto): during video play, specify a position to start play by entering the desired time or number.
- **[Slow Backward]** (Slow Backward) & **[Slow Forward]** (Slow forward): during video play, select a slow backward/forward speed.

## Change the audio channel

### Note

- This feature is only available for VCDs and DivX (Home Theater 3.1) videos.

During play, press **AUDIO** repeatedly to select an audio channel available on the disc:

- **[Mono Left]** (mono left)
- **[Mono Right]** (mono right)
- **[Mix-Mono]** (mix-mono)
- **[Stereo]** (stereo)

# 6 Enjoy karaoke

You can connect a microphone (not supplied) to sing along with a music source.

## Note

- Before you connect a microphone, set the microphone volume to the minimum to prevent howling.

- 1 Insert a Karaoke disc.
- 2 Connect a microphone to the **MIC IN** jack on this product.
- 3 Press **▲**, and then select **[Karaoke]** (Karaoke).
- 4 Turn on the microphone sound output (see "**Adjust karaoke settings**").
- 5 Play a Karaoke disc and sing through the microphone.

## Adjust Karaoke settings

- **[Microphone]** (Microphone): turn on or off the microphone sound output.
- **[Mic Volume]** (Mic Volume): adjust the microphone volume.
- **[Echo Level]** (Echo Level): adjust echo level.
- **[Karaoke Scoring]** (Karaoke Scoring): turn off the function of Karaoke scoring or select a scoring level (basic/intermediate/advance). If a level is selected, the score is displayed after each song ends.
- **[Karaoke Idol]** (Karaoke Idol): compete for singing up to 4 songs among different signers, and the contest result is displayed.

- 1) In the **[Karaoke Scoring]** (Karaoke Scoring) option, select a level (basic/intermediate/advance).
- 2) In the **[Karaoke Idol]** (Karaoke Idol) option, turn on the contest.
  - ↳ The song selection menu is displayed.
- 3) Input a track (VCD/SVCD) or a title/chapter (DVD) as the first song. Up to 4 songs can be selected.
- 4) Then select **[Start]** (Start), and press **OK** to start play selected songs.
  - ↳ After all the selected songs end, a contest result is displayed.

- **[Key Shift]** (Key Shift): adjust the pitch level that matches your voice.
- **[Vocal]** (Vocal): select various Karaoke audio modes, or turn off original vocal.

# 7 Listen to the radio

## Tune to a radio station



Tip

- Position the antenna as far as possible from TV,VCR, or other radiation source.
- For optimal reception, fully extend and adjust the position of the antenna.

- 1 Press **FM** repeatedly to select FM source.
- 2 Press and hold **◀/▶** ( **◀◀/▶▶** ) for more than two seconds.  
↳ The radio tunes to a station with strong reception automatically.
- 3 Repeat step 2 to tune to more stations.

### To tune to a weak station:

Press **◀/▶** ( **◀◀/▶▶** ) repeatedly until you find optimal reception.

## Program radio stations automatically



Note

- You can program a maximum of 20 preset radio stations (FM).

In tuner mode, press and hold **PROG** for more than two seconds to activate automatic programming.

- ↳ **[AUTO]** (auto) is displayed.
- ↳ All available stations are programmed in the order of waveband reception strength, and the first programmed radio station is broadcast automatically.

## Program radio stations manually

- 1 Tune to a radio station.
- 2 Press **PROG**, and then press **▲/▼** to select a number from 1–20.
- 3 Press **PROG** to confirm.  
↳ **[SAVE]** (save) is displayed.
- 4 Repeat steps 2–3 to program more stations.



Note

- To overwrite a programmed station, store another station in its place.

## Select a preset radio station

In tuner mode, press **▲/▼** (or press a number directly) to select a preset radio station.



# 8 Other features

## Set the alarm timer

This unit can be used as an alarm clock. You can select CD, FM, or USB as alarm source.

### Note

- Make sure that you have set the clock correctly.

- 1 In standby mode, press and hold **TIME/SLEEP** for more than two seconds.  
↳ The hour digits are displayed and begin to blink.
- 2 Press **▲ / ▼** (or **+/-**) repeatedly to set hour, and then press **TIME/SLEEP**.  
↳ The minute digits are displayed and begin to blink.
- 3 Repeat step 2 to set minute, select a source (disc, USB, or tuner), and adjust volume.

### Note

- If no button is pressed in 90 seconds, the system exits timer setting mode automatically.

### To activate or deactivate the alarm timer:

Press **TIME/SLEEP** repeatedly to activate or deactivate the alarm.

↳ If timer is activated,  is displayed.

### Tip

- If disc/USB source is selected, but no disc is placed or no USB connected, the system switches to the tuner source automatically.

## Set the sleep timer

To set the sleep timer; in turn on mode, press **TIME/SLEEP** repeatedly to select a set period of time (in minutes).

↳ When sleep timer is activated, **zZ** is displayed.

### To deactivate sleep timer:

Press **TIME/SLEEP** repeatedly until **[SLP OFF]** (sleep off) is displayed.

↳ When sleep timer is deactivated, **zZ** disappears.

## Listen to an external device

You can listen to an external device through this unit with an MP3 link cable (not supplied).

- 1 Make sure that the external audio device is connected to this device. (see 'Connect an external audio device' on page 8)
- 2 Press **FM/AUX** repeatedly to select **AUX** source.
- 3 Start to play the external device (see the device user manual).

# 9 Adjust settings

- 1 Press **▲**.
- 2 Select the **[Setup]** (Setup) page.
- 3 Select a setting and press **OK**.
  - To return to the previous menu, press **↶**.
  - To exit the menu, press **▲**.

## General setup

On the **[General]** (general) page, you can set the following options:

### **[Disc Lock]** (disc lock)

Lock or unlock a disc.

### **[OSD Language]** (OSD language)

Select the preferred language for on-screen display.

### **[DivX(R) VOD Code]** (DivX(R) VOD Code)

Display the DivX(R) registration code.

### Note

- Enter this DivX registration code when you rent or purchase a video from <http://vod.divx.com/>. The DivX videos rented or purchased through the DivX® VOD (Video On Demand) service can be played only on the device to which it is registered.

## Video setup

On the **[Video]** (Video) page, you can set the following options:

### **[TV System]** (TV System)

Change this setting if the video is not displayed correctly. By default, this setting matches the most common setting for TVs in your country.

- **[PAL]** (PAL) - For TV with PAL color system.
- **[Multi]** (Multi) - For TV that is compatible with both PAL and NTSC.

- **[NTSC]** (NTSC) - For TV with NTSC color system.

### **[TV Display]** (TV Display)

The TV format determines the aspect ratio of display according to the type of TV you have connected.



4:3 Pan Scan (PS)

4:3 Letter Box (LB)

16:9 (Wide Screen)

- **[4:3 Pan Scan]** (4:3 Pan Scan) – For 4:3 screen TV: full-height display with the trimmed sides.
- **[4:3 Letter Box]** (4:3 Letter Box) – For 4:3 screen TV: wide-screen display with black bars on the top and bottom of the screen.
- **[16:9]** (16:9 Wide Screen) – For wide-screen TV: display ratio 16:9.

### **[Progressive]** (Progressive)

Set the video output according to the video connection. If the composite connection is used, this setting is not required.

- **[On]** (On) – turn on progressive scan.
- **[Off]** (Off) – turn off progressive scan.

### **[Picture Setting]** (Picture Setting)

Select a predefined set of picture color settings.

- **[Standard]** (Standard) – Original color setting.
- **[Bright]** (Bright) – Vibrant color setting.
- **[Soft]** (Soft) - Soft color setting.
- **[Personal]** (Personal) – Customizes the color setting. Set the level of brightness, contrast, tint, and color saturation, and then press **OK**.

## Audio setup

On the **[Audio]** (Audio) page, you can set the following options:

### [Surround Mode] (Surround Mode)

- [Stereo] (Stereo)
- [LT/RT] (left/right)

### [Sound Mode] (Sound Mode)

Turn off or select your preferred sound mode.

- [3D] (3D)
- [Movie Mode] (Movie Mode)
- [Music Mode] (Music Mode)

### [Night Mode] (Night Mode)

Make loud sound level softer and soft sound level louder so that you can watch the DVD movies at a low volume, without disturbing others.

- [On] (On) – enjoy quiet viewing at night (DVDs only).
- [Off] (Off) – enjoy surround sound with its full dynamic range.

---

## Preferences

On the [Preference] (Preference) page, you can set the following options:

### [Audio] (Audio)

Select the preferred audio language for disc play.

### [Subtitle] (Subtitle)

Select the preferred subtitle language for disc play.

### [Disc Menu] (Disc Menu)

Select the preferred disc menu language.

#### Note

- If the language you have set is not available on the disc, the disc uses its own default language.
- For some discs, the subtitle/audio language can only be changed from the disc menu.

### [Parental Control] (Parental Control)

Restrict access to discs that are unsuitable for children. These types of discs must be recorded with ratings.

---

1) Press **OK**.

2) Select a rating level, and then press **OK**.

3) Press the numeric keys to enter the password.

---

#### Note

- Rated discs above the level you set in [Parental Control] (Parental Control) require a password to be played.
- The ratings are country-dependent. To allow all discs to play, select [8 Adult] (8 Adult).
- Some discs have ratings printed on them but are not recorded with ratings. This function has no effect on such discs.

### [PBC] (PBC)

Play VCD interactively according to the menu screen.

- [On] (On): the menu screen is displayed.
- [Off] (Off): normal play is resumed.

### [Password] (Password)

This setting allows you to change the password for parental control. The default password is 000000.

---

1) Press the numeric keys to enter '000000' or your last set password at [Old Password] (Old Password) field.

2) Enter the new password at [New Password] (New Password) field.

3) Enter the new password again at [Confirm PWD] (Confirm PWD) field.

4) Press **OK** to exit the menu.

---

#### Note

- If you forget the password, enter '000000' before you set a new password.

### [DivX Subtitle] (DivX Subtitle)

Select a character set that supports the DivX subtitle.

## Note

- Ensure that the subtitle file has the exact same file name as the movie file. If for example the file name of the movie is 'Movie.avi', and then you will need to name the text file 'Movie.sub' or 'Movie.srt'.

### [Version Info] (Version Information)

Display the software version of this device.

### [Default] (Default)

Reset all the settings to factory default, except for the password and parental settings.

# 10 Product information

## Note

- Product information is subject to change without prior notice.

## Specifications

### Amplifier

Maximum Output Power	70 W
Frequency Response	60 Hz - 16 kHz; ±3 dB
Signal to Noise Ratio	≥70 dB
Total Harmonic Distortion	<1%
Aux Input	600 mV RMS

### Speakers

Speaker Impedance	8 ohm
Speaker Driver	3.5" + 20 mm
Sensitivity	>84 dB/m/W

### Tuner (FM)

Tuning Range	87.5-108 MHz
Tuning grid	50 KHz
Sensitivity	
- Mono, 26dB S/N Ratio	<22 dBf
- Stereo, 46dB S/N Ratio	<45 dBf
Search Selectivity	<30 dBf
Total Harmonic Distortion	<3%
Signal to Noise Ratio	>45 dB

---

## USB

USB Direct Version	2.0 full speed
USB 5 V Power	≤500 mA

---

## Disc

Laser Type	Semiconductor
Disc Diameter	12 cm/8 cm
Video Decoding	MPEG-1 / MPEG-2 / DivX
Video DAC	12 Bits
Signal System	PAL / NTSC
Video Format	4:3 / 16:9
Video S/N	>57 dB
Audio DAC	24 Bits / 96 kHz
Total Harmonic Distortion	<1% (1 kHz)
Frequency Response	4 Hz - 20 kHz (44.1 kHz) 4 Hz - 22 kHz (48 kHz) 4 Hz - 24 kHz (96 kHz)
Frequency Response	60 Hz - 16 kHz; ±3 dB
S/N Ratio	>70 dBA

---

## General information

AC power	100-240 V, 50/60 Hz
Operation Power Consumption	28 W
Eco Standby Power Consumption	<0.5 W
Dimensions	
- Main Unit (W × H × D)	180 × 121 × 239 mm
- Speaker Box (W × H × D)	140 × 260 × 185 mm
Weight	
- Main Unit	1.6 kg
- Speaker Box	2 × 2.1 kg

---

## Supported disc formats

- Digital Video Discs (DVDs)
- Video CDs (VCDs)
- SuperVideo CDs (SVCDs)
- Digital Video Discs + Rewritable (DVD+RW)
- Compact Discs (CDs)
- Picture (Kodak, JPEG) files on CDR(W)
- DivX(R) disc on CD-R(W):
- DivX 3.11, 4.x and 5.x

### Supported MP3-CD formats:

- ISO 9660
- Max. title/album name: 12 characters
- Max. title number plus album: 255.
- Max. nested directory: 8 levels.
- Max. album number: 32.
- Max. MP3 track number: 999.
- Supported sampling frequencies for MP3 disc: 32 kHz, 44.1 kHz, 48 kHz.
- Supported Bit-rates of MP3 disc are: 32, 64, 96, 128, 192, 256 (kbps).
- The following formats are not supported:
  - Files like \*.VMA, \*.AAC, \*.DLF, \*.M3U,
  - \*.PLS, \*.WAV
  - Non-English Album/Title name
  - Discs recorded in Joliet format
  - MP3 Pro and MP3 with ID3 tag

---

## USB playability information

### Compatible USB devices:

- USB flash memory (USB2.0 or USB1.1)
- USB flash players (USB2.0 or USB1.1)
- memory cards (requires an additional card reader to work with this unit)

### Supported formats:

- USB or memory file format: FAT12, FAT16, FAT32 (sector size: 512 bytes)
- MP3 bit rate (data rate): 32-320 Kbps and variable bit rate
- Directory nesting up to a maximum of 8 levels
- Number of albums/ folders: maximum 99

- Number of tracks/titles: maximum 999
- ID3 tag v2.0 or later
- File name in Unicode UTF8 (maximum length: 32 bytes)

#### Unsupported formats:

- Empty albums: an empty album is an album that does not contain MP3/WMA files, and will not be shown in the display.
- Unsupported file formats are skipped. For example, word documents (.doc) or MP3 files with extension .dlf are ignored and not played.
- WMA, AAC, WAV, PCM audio files
- DRM protected WMA files (.wav, .m4a, .m4p, .mp4, .aac)
- WMA files in Lossless format

# 11 Troubleshooting



#### Warning

- Never remove the casing of this device.

To keep the warranty valid, never try to repair the system yourself.

If you encounter problems when using this device, check the following points before requesting service. If the problem remains unsolved, go to the Philips Web page ([www.philips.com/support](http://www.philips.com/support)). When you contact Philips, make sure that the device is nearby and the model number and serial number are available.

#### No power

- Make sure that the AC power cord of the device is connected properly.
- Make sure that there is power at the AC outlet.
- As a power-saving feature, the system switches off automatically 15 minutes after track play reaches the end and no control is operated.

#### No sound or poor sound

- Adjust the volume.
- Check that the speakers are connected correctly.
- Check if the stripped speaker wires are clamped.

#### Remote control does not work

- Before you press any function button, first select the correct source with the remote control instead of the main unit.
- Reduce the distance between the remote control and the unit.
- Insert the battery with its polarities (+/- signs) aligned as indicated.
- Replace the battery.
- Aim the remote control directly at the sensor on the front of the unit.

**No disc detected**

- Insert a disc.
- Check if the disc is inserted upside down.
- Wait until the moisture condensation at the lens has cleared.
- Replace or clean the disc.
- Use a finalized CD or correct format disc.

**Disc does not play**

- Check the disc type, color system and regional code. Check for any scratches or smudges on the disc.
- Press  to exit the system setup menu.
- Disable the password for parental control or change the rating level.
- Moisture has condensed inside the system. Remove the disc and leave the system turned on for about an hour. Disconnect and reconnect the AC power plug, and then turn on the system again.

**No picture**

- Check the video connection.
- Turn on the TV to the correct Video-In channel.
- Progressive scan is activated but the TV does not support progressive scan.

**Black and white or distorted picture**

- The disc does not match the TV color system standard (PAL/NTSC).
- Sometimes a slight picture distortion may appear. This is not a malfunction.
- Clean the disc.
- A distorted picture may appear during progressive scan setup.

**The aspect ratio of the TV screen cannot be changed even though you have set the TV display format.**

- The aspect ratio is fixed on the loaded DVD disc.
- The aspect ratio may not be changed for some TV systems.

**DivX video files cannot be played.**

- Ensure that the DivX video file is complete.
- Ensure that the file extension is correct.
- Due to Digital Rights issue, the DRM-protected video files cannot be played through an analog video connection (e.g. composite, component and scart). Transfer the video content onto the Disc Media and play these files.

**Audio or subtitle languages cannot be set**

- The disc is not recorded with sound or subtitles in multiple languages.
- The audio or subtitle language setting is prohibited on the disc.

**Cannot display some files in USB device**

- The number of folders or files in the USB device has exceeded a certain limit. This phenomenon is not a malfunction.
- The formats of these files are not supported.

**USB device not supported**

- The USB device is incompatible with the unit. Try another one.

**Poor radio reception**

- Increase the distance between the apparatus and your TV or VCR.
- Fully extend the FM antenna.

**Timer does not work**

- Set the clock correctly.
- Switch on the timer.

**Clock/timer setting erased**

- Power has been interrupted or the power cord has been disconnected.
- Reset the clock/timer.

# 12 Notice

Any changes or modifications made to this device that are not expressly approved by Philips Consumer Lifestyle may void the user's authority to operate the equipment.



This product complies with the radio interference requirements of the European Community.



Your product is designed and manufactured with high quality materials and components, which can be recycled and reused.



When this crossed-out wheeled bin symbol is attached to a product it means that the product is covered by the European Directive 2002/96/EC.

Please inform yourself about the local separate collection system for electrical and electronic products.

Please act according to your local rules and do not dispose of your old products with your normal household waste. Correct disposal of your old product helps to prevent potential negative consequences for the environment and human health.



Your product contains batteries covered by the European Directive 2006/66/EC, which cannot be disposed with normal household waste. Please inform yourself about the local rules on separate collection of batteries

because correct disposal helps to prevent negative consequences for the environmental and human health.

## Environmental information

All unnecessary packaging has been omitted. We have tried to make the packaging easy to separate into three materials: cardboard (box), polystyrene foam (buffer) and polyethylene (bags, protective foam sheet.)

Your system consists of materials which can be recycled and reused if disassembled by a specialized company. Please observe the local regulations regarding the disposal of packaging materials, exhausted batteries and old equipment.



The making of unauthorized copies of copy-protected material, including computer programs, files, broadcasts and sound recordings, may be an infringement of copyrights and constitute a criminal offence. This equipment should not be used for such purposes.



Manufactured under license from Dolby Laboratories.

"Dolby" and the double-D symbol are trademarks of Dolby Laboratories.



'DVD Video' is a trademark of DVD Format/Logo Licensing Corporation.



ABOUT DIVX VIDEO: DivX® is a digital video format created by DivX, LLC, a subsidiary of Rovi Corporation. This is an official DivX Certified® device that plays DivX video. Visit



divx.com for more information and software tools to convert your files into DivX videos. ABOUT DIVX VIDEO-ON-DEMAND: This DivX Certified® device must be registered in order to play purchased DivX Video-on-Demand (VOD) movies. To obtain your registration code, locate the DivX VOD section in your device setup menu. Go to vod.divx.com for more information on how to complete your registration.

DivX®, DivX Certified® and associated logos are trademarks of Rovi Corporation or its subsidiaries and are used under license.

**This apparatus includes this label:**

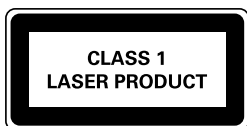

 Note

- The type plate is located on the back of the device.



Specifications are subject to change without notice  
© 2013 Koninklijke Philips Electronics N.V.  
All rights reserved.

MCD2160\_12\_UM\_V1.0



## Free Manuals Download Website

<http://myh66.com>

<http://usermanuals.us>

<http://www.somanuals.com>

<http://www.4manuals.cc>

<http://www.manual-lib.com>

<http://www.404manual.com>

<http://www.luxmanual.com>

<http://aubethermostatmanual.com>

Golf course search by state

<http://golfingnear.com>

Email search by domain

<http://emailbydomain.com>

Auto manuals search

<http://auto.somanuals.com>

TV manuals search

<http://tv.somanuals.com>