

Always there to help you

Register your product and get support at
www.philips.com/welcome

MCM129



User manual

PHILIPS

Contents

1 Important	2	8 Troubleshooting	12
Safety	2		

2 Your Micro Hi-Fi System	3	9 Notice	13
Introduction	3		
What's in the box	3		
Overview of the main unit	4		
Overview of the remote control	5		

3 Get started	6		
Connect speakers	6		
Connect power	6		
Prepare the remote control	7		
Turn on	7		

4 Play	7		
Play from disc	7		
Play from USB	7		
Control play	8		
Program tracks	8		

5 Listen to radio	9		
Tune to a radio station	9		
Program radio stations automatically	9		
Program radio stations manually	9		
Select a preset radio station	9		

6 Other features	10		
Listen to an external device	10		

7 Product information	10		
Specifications	10		
USB playability information	11		
Supported MP3 disc formats	11		

1 Important

Safety



This 'bolt of lightning' indicates uninsulated material within the device may cause an electrical shock. For the safety of everyone in your household, please do not remove the covering.

The 'exclamation mark' calls attention to features for which you should read the enclosed literature closely to prevent operating and maintenance problems.

WARNING: To reduce the risk of fire or electric shock, the device should not be exposed to rain or moisture and objects filled with liquids, such as vases, should not be placed on the device.

CAUTION: To prevent electric shock, fully insert the plug. (For regions with polarized plugs: To prevent electric shock, match wide blade to wide slot.)

Important Safety Instructions

- Follow all instructions.
- Heed all warnings.
- Do not use this device near water.
- Clean only with dry cloth.
- Do not block any ventilation openings. Install in accordance with the manufacturer's instructions.
- Do not install near any heat sources such as radiators, heat registers, stoves, or other devices (including amplifiers) that produce heat.

- Protect the power cord from being walked on or pinched, particularly at plugs, convenience receptacles, and the point where they exit from the device.
- Only use attachments/accessories specified by the manufacturer.
- Use only with the cart, stand, tripod, bracket, or table specified by the manufacturer or sold with the device. When a cart is used, use caution when moving the cart/device combination to avoid injury from tip-over.



- Unplug this device during lightning storms or when unused for long periods of time.
- Refer all servicing to qualified service personnel. Servicing is required when the device has been damaged in any way, such as power-supply cord or plug is damaged, liquid has been spilled or objects have fallen into the device, the device has been exposed to rain or moisture, does not operate normally, or has been dropped.
- Battery usage **CAUTION** – To prevent battery leakage which may result in bodily injury, property damage, or damage to the unit:
 - Install all batteries correctly, + and - as marked on the unit.
 - Do not mix batteries (old and new or carbon and alkaline, etc.).
 - Batteries (packed or installed) shall not be exposed to excessive heat such as sunshine, fire or the like.
 - Remove batteries when the unit is not used for a long time.
- The device shall not be exposed to dripping or splashing.
- Do not place any sources of danger on the device (e.g. liquid filled objects, lighted candles).

- Where the MAINS plug or an appliance coupler is used as the disconnect device, the disconnect device shall remain readily operable.



Warning

- Never remove the casing of this device.
- Never lubricate any part of this device.
- Never place this device on other electrical equipment.
- Keep this device away from direct sunlight, naked flames or heat.
- Never look into the laser beam inside this device.
- Ensure that you always have easy access to the power cord, plug, or adaptor to disconnect this device from the power.

Risk of swallowing coin battery

- The product/remote control may contain a coin/button type battery, which can be swallowed. Keep the battery out of reach of children at all times! If swallowed, the battery can cause serious injury or death. Severe internal burns can occur within two hours of ingestion.
- If you suspect that a battery has been swallowed or placed inside any part of the body, seek immediate medical attention.
- When you change the batteries, always keep all new and used batteries out of reach of children. Ensure that the battery compartment is completely secure after you replace the battery.
- If the battery compartment cannot be completely secured, discontinue use of the product. Keep out of reach of children and contact the manufacturer.

2 Your Micro Hi-Fi System

Congratulations on your purchase, and welcome to Philips! To fully benefit from the support that Philips offers, register your product at www.Philips.com/welcome.

Introduction

With this unit, you can:

- enjoy audio from discs and other external devices;
- listen to radio stations.

You can enrich sound output with the following sound effect:

- Dynamic Bass Boost (DBB)

The unit supports the following media format:



What's in the box

Check and identify the contents of your package:

- Main unit
- 2 x speakers
- Remote control (with one CR2025 cell battery)
- Short user manual
- Safety & Notice

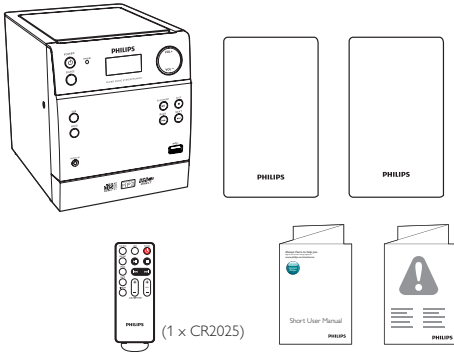

Overview of the main unit

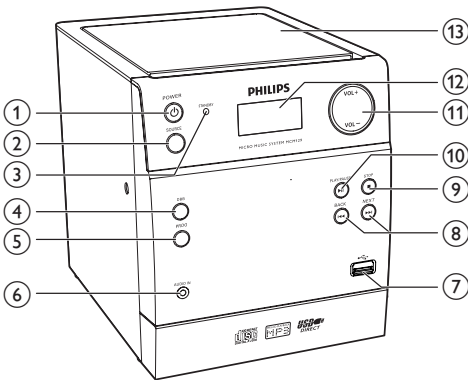

- ① **POWER**
 - Turn on or off the unit.
 - Switch to standby mode.
- ② **SOURCE**
 - Select a source: DISC, USB, AUX, or FM.
- ③ **STANDBY**
 - Indicate the standby mode.
- ④ **DBB**
 - Turns on or off dynamic bass enhancement.
- ⑤ **PROG**
 - Program tracks.
 - Program radio stations.

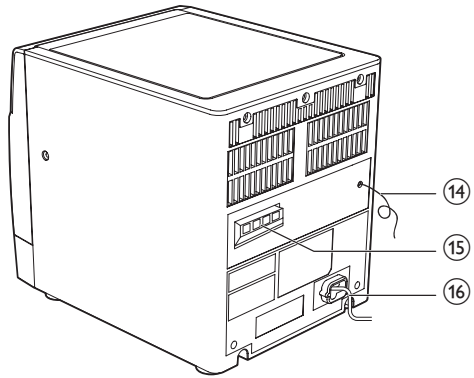

- ⑥ **AUDIO IN**
 - Jack for an external audio device.
- ⑦
 - Jack for a USB device.
- ⑧
 - Skip to the previous or next track.
 - Search within a track or disc.
 - Tune to a radio station.
- ⑨
 - Stop play or erase a program.
- ⑩
 - Start or pause play.
- ⑪ **VOL +/-**
 - Adjust volume.

- ⑫ **Display panel**
 - Show current status.
- ⑬ **Disc compartment**
- ⑭ **FM ANTENNA**
 - Improve FM reception.
- ⑮ **SPEAKER**
 - Connect speakers.
- ⑯ **Power cord**
 - Connect AC power.

Overview of the remote control

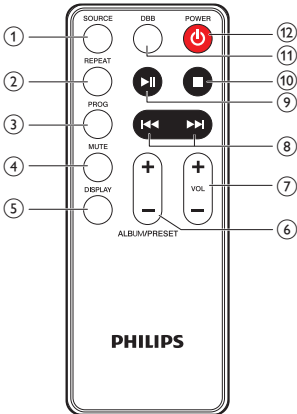

- ⑥ **ALBUM/PRESET +/-**
 - Select a folder.
 - Select a preset radio station.
- ⑦ **VOL +/-**
 - Adjust volume.
- ⑧ **◀▶**
 - Skip to the previous or next track.
 - Search within a track or disc.
 - Tune to a radio station.
- ⑨ **▶||**
 - Start or pause play.
- ⑩ **■**
 - Stop play or erase a program.
- ⑪ **DBB**
 - Turns on or off dynamic bass boost.
- ⑫ **POWER**
 - Turn on or off the unit.
 - Switch to standby mode.

- ① **SOURCE**
 - Select a source: DISC, USB, AUX, or FM tuner.
- ② **REPEAT**
 - Play a track or all tracks repeatedly.
- ③ **PROG**
 - Program tracks.
 - Program radio stations.
- ④ **MUTE**
 - Mute or restore volume.
- ⑤ **DISPLAY**
 - Show current status.

3 Get started

! Caution

- Use of controls or adjustments or performance of procedures other than herein may result in hazardous radiation exposure or other unsafe operation.

Always follow the instructions in this chapter in sequence.

If you contact Philips, you will be asked for the model and serial number of this apparatus. The model number and serial number are on the back of the apparatus. Write the numbers here:

Model No. _____

Serial No. _____

Connect speakers

≡ Note

- For optimal sound, use the supplied speakers only.
- Connect only speakers with impedance that is the same or higher than the supplied speakers. Refer to the Specifications section of this manual.

1 For one speaker, insert the red wire to the red (R+) socket on the back of the main unit, and the black wire into the black (R-) socket.

2 Repeat step 1 to connect another speaker.

To insert each speaker wire:

1 Hold down the socket flap.

2 Insert the speaker wire fully.

3 Release the socket flap.

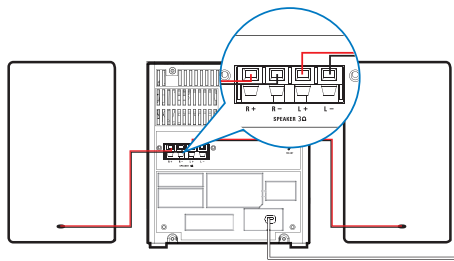

Connect power

! Caution

- Risk of product damage! Make sure that the power supply voltage corresponds to the voltage printed on the back or the underside of the Micro Hi-Fi system.
- Risk of electric shock! When you unplug the AC power cord, always pull the plug from the socket. Never pull the cord.
- Before connecting the AC power cord, make sure that you have completed all other connections.

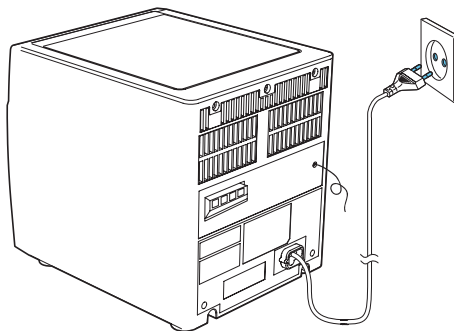

Prepare the remote control

! Caution

- Risk of explosion! Keep batteries away from heat, sunshine or fire. Never discard batteries in fire.
- Risk of decreased battery life! Never mix different brands or types of batteries.
- Risk of product damage! When the remote control is not used for long periods, remove the batteries.
- Danger of explosion if battery is incorrectly replaced. Replace only with the same or equivalent type.

For first-time use:

Remove the protective tab to activate the remote control battery.

To replace the remote control battery:

- 1 Open the battery compartment.
- 2 Insert one CR2025 battery with correct polarity (+/-) as indicated.
- 3 Close the battery compartment.

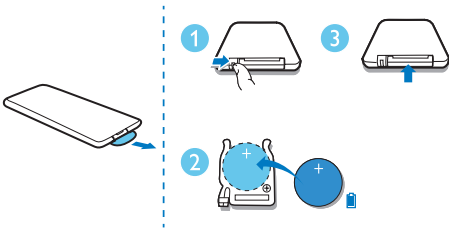

Turn on

Press **POWER**.

- ↳ The unit switches to the last selected source.

Switch to standby

Press **POWER** again to switch the unit to standby mode.

- ↳ The red standby indicator turns on.
↳ The backlight on the display panel turns off.

4 Play

Play from disc

- 1 Press **SOURCE** repeatedly to select the **DISC** source.
- 2 Pull to open the disc compartment on the top of the device.
- 3 Insert a disc with printed side facing upward.
- 4 Close the disc compartment.
↳ Play starts automatically. If not, press **▶||**.

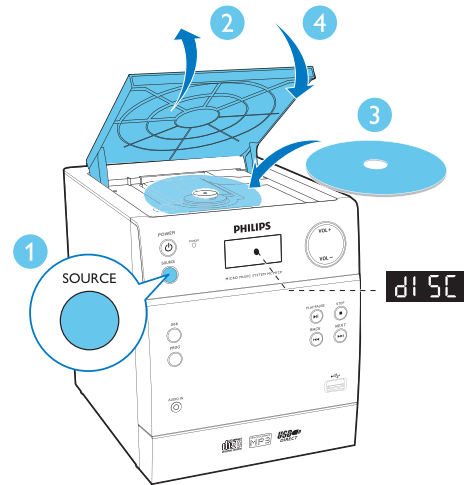



Play from USB

≡ Note

- Make sure that the USB device contains playable audio content.



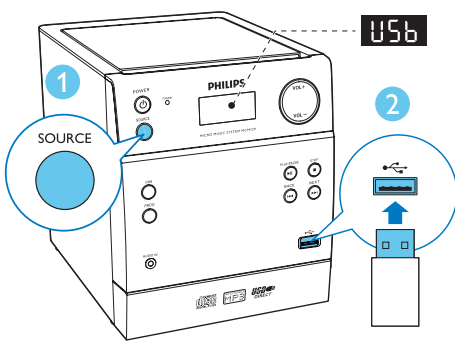

- 1 Press **SOURCE** repeatedly to select the **USB** source.

- 2 Insert a USB device into the  socket.
↳ Play starts automatically. If not, press .







Program tracks

You can program a maximum of 20 tracks.

- 1 In DISC or USB mode, in the stop position, press **PROG** to activate the program mode.
↳ [P-01] is displayed.
- 2 Press  /  to select a track number, and then press **PROG** to confirm.
- 3 Repeat steps 1-2 to select and store more tracks.
- 4 Press  to play the programmed tracks.
 - To erase the program, in the stop position, press .

Control play

	Pause or resume play.
	Stop play.
 / 	Press to skip to another track. Press and hold for two seconds to search within a track.
ALBUM/ PRESET +/-	Skip to previous or next album.
VOL +/-	Increase or decrease the volume.
MUTE	Mute or restore sound.
DBB	[HBS-0]: DBB off [HBS-1]: DBB on
REPEAT	[r1]: Play the current track repeatedly. [rA]: Play all tracks repeatedly. [rn]: Play all tracks randomly. [rF]: For DISC or USB with MP3 format tracks, play the current folder repeatedly.
DISPLAY	Show current status.

5 Listen to radio

Tune to a radio station

Tip

- Position the antenna as far as possible from TV, VCR, or other radiation source.
- For optimal reception, fully extend and adjust the position of the antenna.

- 1 Press **SOURCE** repeatedly to select the **FM tuner** source.
↳ **[tuner]** (tuner) is displayed.
- 2 Press and hold **◀◀ / ▶▶** for two seconds.
↳ The radio tunes to a station with strong reception automatically.
- 3 Repeat step 2 to tune to more stations.

To tune to a weak station:

Press **◀◀ / ▶▶** repeatedly until you find optimal reception.

Program radio stations automatically

Note

- You can program a maximum of 20 preset FM radio stations.

In FM tuner mode, press and hold **PROG** for two seconds.

- ↳ **[AUTO]** (auto) is displayed.
- ↳ The device stores all available FM radio stations and broadcasts the first available station automatically.

Program radio stations manually

Note

- You can program a maximum of 20 preset radio stations.

- 1 Tune to a radio station.
- 2 Press **PROG** to activate program mode.
↳ The preset number is displayed.
- 3 Press **PRESET +/-** to select a number, and then press **PROG** to confirm.
↳ The frequency of the preset station is displayed.
- 4 Repeat steps 2-3 to program more stations.

Tip

- To overwrite a programmed station, store another station in its place.

Select a preset radio station

In FM tuner mode, press **PRESET +/-** to select a preset number.

6 Other features

Listen to an external device

You can listen to an external device through this unit.

- 1 Press **SOURCE** repeatedly to select the **AUX** source.
- 2 Connect an MP3 link cable (not supplied) between:
 - **AUDIO IN** jack (3.5 mm) on the unit,
 - and the headphone jack on an external device
- 3 Start to play the device (see the device user manual).

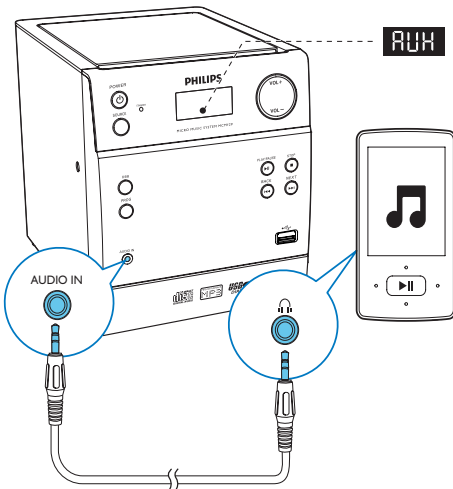

7 Product information

Note

- Product information is subject to change without prior notice.

Specifications

Amplifier

Maximum Output Power	5 W RMS
Frequency Response	60-16 kHz, ± 3 dB
Signal to Noise Ratio	>50 dBA
Aux Input	0.5 V RMS 20 kohm

Speakers

Speaker Impedance	3 ohm
Speaker Driver	3.5" full range
Sensitivity	>82 dB/m/W

Disc

Laser Type	Semiconductor
Disc Diameter	12 cm/8 cm
Support Disc	CD-DA, CD-R, CD-RW
Audio DAC	24 Bits / 44.1 kHz
Total Harmonic Distortion	<1%
Frequency Response	60 Hz -16 kHz (44.1 kHz), ± 3 dB
S/N Ratio	>50 dBA

USB

USB Direct Version	V1.1 or 2.0
USB 5 V Power	≤500 mA

Tuner

Tuning Range	FM: 87.5-108 MHz
Tuning grid	50 kHz

Sensitivity

- Mono, 26dB S/N Ratio	<22 dBf
- Stereo, 46dB S/N Ratio	<43 dBf

Search Selectivity	>28 dBf
--------------------	---------

Total Harmonic Distortion	<3%
---------------------------	-----

Distortion

Signal to Noise Ratio	≥ 50 dB
-----------------------	---------

General information

AC power	220-240 V~, 50/60 Hz
----------	----------------------

Operation Power Consumption	10 W
-----------------------------	------

Consumption

Standby Power Consumption	<0.5 W
---------------------------	--------

Consumption

Dimensions:

- Main Unit (W × H × D)	152 × 174 × 206 mm
- Speaker Box (W × H × D)	132 × 175 × 158 mm

Weight:

- Main Unit	1.1 kg
- Speaker Box	2 × 0.9 kg

Supported formats:

- USB or memory file format: FAT12, FAT16, FAT32 (sector size: 512 bytes)
- MP3 bit rate (data rate): 32-320 Kbps and variable bit rate
- Directory nesting up to a maximum of 8 levels
- Number of albums/ folders: maximum 99
- Number of tracks/titles: maximum 999
- File name in Unicode UTF8 (maximum length: 32 bytes)

Unsupported formats:

- Empty albums: an empty album is an album that does not contain MP3/WMA files, and will not be shown in the display.
- Unsupported file formats are skipped. For example, word documents (.doc) or MP3 files with extension .dlf are ignored and not played.
- WMA, AAC, WAV, PCM audio files
- DRM protected WMA files (.wav, .m4a, .m4p, .mp4, .aac)
- WMA files in Lossless format

Supported MP3 disc formats

- ISO9660, Joliet
- Maximum title number: 128 (depending on file name length)
- Maximum album number: 99
- Supported sampling frequencies: 32 kHz, 44.1 kHz, 48 kHz
- Supported Bit-rates: 32~256 (kbps), variable bit rates

USB playability information

Compatible USB devices:

- USB flash memory (USB2.0 or USB1.1)
- USB flash players (USB2.0 or USB1.1)
- memory cards (requires an additional card reader to work with this unit)

8 Troubleshooting



Warning

- Never remove the casing of this device.

To keep the warranty valid, never try to repair the system yourself.

If you encounter problems when using this device, check the following points before requesting service. If the problem remains unsolved, go to the Philips Web page (www.philips.com/support). When you contact Philips, make sure that the device is nearby and the model number and serial number are available.

No power

- Make sure that the AC power cord of the device is connected properly.
- Make sure that there is power at the AC outlet.
- As a power-saving feature, the system switches off automatically 15 minutes after track play reaches the end and no control is operated.

No response from the unit

- Disconnect and reconnect the AC power plug, and then turn on the system again.

No sound or poor sound

- Adjust the volume.
- Check if the speakers are connected correctly.
- Check if the stripped speaker wires are clamped.

Remote control does not work

- Before you press any function button, first select the correct source with the remote control instead of the main unit.
- Reduce the distance between the remote control and the unit.
- Insert the battery with its polarities (+/- signs) aligned as indicated.
- Replace the battery.

- Aim the remote control directly at the sensor on the front of the unit.

No disc detected

- Insert a disc.
- Check if the disc is inserted upside down.
- Wait until the moisture condensation at the lens has cleared.
- Replace or clean the disc.
- Use a finalized CD or correct format disc.

Poor radio reception

- Increase the distance between the unit and your TV or VCR.
- Fully extend the antenna.

9 Notice

Any changes or modifications made to this device that are not expressly approved by Philips Consumer Lifestyle may void the user's authority to operate the equipment.

Any changes or modifications made to this device that are not expressly approved by Philips Consumer Lifestyle may void the user's authority to operate the equipment.



Your product is designed and manufactured with high quality materials and components, which can be recycled and reused.



When this crossed-out wheeled bin symbol is attached to a product it means that the product is covered by the European Directive 2002/96/EC.

Please inform yourself about the local separate collection system for electrical and electronic products.

Please act according to your local rules and do not dispose of your old products with your normal household waste. Correct disposal of your old product helps to prevent potential negative consequences for the environment and human health.



Your product contains batteries covered by the European Directive 2006/66/EC, which cannot be disposed with normal household waste. Please inform yourself about the local rules on separate collection of batteries because correct disposal helps to prevent negative consequences for the environmental and human health.

Environmental information

All unnecessary packaging has been omitted. We have tried to make the packaging easy to separate into three materials: cardboard (box), polystyrene foam (buffer) and polyethylene (bags, protective foam sheet.)

Your system consists of materials which can be recycled and reused if disassembled by a specialized company. Please observe the local regulations regarding the disposal of packaging materials, exhausted batteries and old equipment.



**Be responsible
Respect copyrights**

This item incorporates copy protection technology that is protected by U.S. patents and other intellectual property rights of Rovi Corporation. Reverse engineering and disassembly are prohibited.

This apparatus includes this label:



Class II equipment symbol:



This symbol indicates that this product has a double insulation system.



Note

- The type plate is located on the back of the device.



Specifications are subject to change without notice
© 2013 Koninklijke Philips Electronics N.V.
All rights reserved.

MCM129_12_UM_V1.1



Free Manuals Download Website

<http://myh66.com>

<http://usermanuals.us>

<http://www.somanuals.com>

<http://www.4manuals.cc>

<http://www.manual-lib.com>

<http://www.404manual.com>

<http://www.luxmanual.com>

<http://aubethermostatmanual.com>

Golf course search by state

<http://golfingnear.com>

Email search by domain

<http://emailbydomain.com>

Auto manuals search

<http://auto.somanuals.com>

TV manuals search

<http://tv.somanuals.com>