

Always there to help you

Register your product and get support at
www.philips.com/welcome



OR2200



User manual

PHILIPS

Contents

1	Safety	2	8	Listen to an external device	14
2	Your clock radio	3	9	Use system menus	15
	Introduction	3		Check the current software version	15
	What's in the box	3		Upgrade the software	15
	Overview of the product	4		Reset the product	15
	Know about the LCD display	5			
3	For the first time use	6	10	Adjust volume	16
	Assemble the AC power adaptor	6			
	Connect power	6	11	Use the sleep timer	17
	Power on	6			
	Adjust brightness	6	12	Use the countdown timer	18
4	Set time and date	7			
5	Use the alarm timer	8	13	Troubleshooting	19
	Set an alarm	8			
	Deactivate a preset alarm	8	14	Product information	20
	Snooze the alarm	8		General information	20
	Stop the alarm	8		Tuner	20
				Speakers	20
				Amplifier	20
6	Listen to FM radio stations	9	15	Notice	21
	Switch to FM mode	9		Compliance	21
	Search for a radio station automatically	9		Care of the environment	21
	Search for a radio station manually	9		Copyright	21
	Store radio stations automatically	9			
	Program radio stations manually	9			
	Display RDS information	10			
	Adjust FM settings	10			
7	Listen to DAB radio stations	11			
	Switch to DAB mode	11			
	For the first time use	11			
	Tune to a stored radio station	11			
	Program radio stations	11			
	Display DAB information	12			
	Use DAB menus	12			

1 Safety

Read and understand all instructions before you use this product. If damage is caused by failure to follow the instructions, the warranty does not apply.

Risk of electric shock or fire!

- Never remove the casing of the product.
- Never expose the product and accessories to rain or water. Never place liquid containers, such as vases, near the product. If liquids are spilt on or into the product, disconnect it from the power outlet immediately. Contact the Consumer Care to have the product checked before use.
- Never place the product and accessories near naked flames or other heat sources, including direct sunlight.
- Never insert objects into the ventilation slots or other openings on the product.
- Where the mains plug or an appliance coupler is used as the disconnect device, the disconnect device shall remain readily operable.
- Disconnect the product from the power outlet before lightning storms.
- When you disconnect the power cord, hold the plug securely, never the cable.

Risk of short circuit or fire!

- Use only power supplies listed in the user manual
- Before you connect the product to the power outlet, make sure that the power voltage matches the value printed on the back of the product. Never connect the product to the power outlet if the voltage is different.
- Never expose the product to rain, water, sunshine, or excessive heat.
- Avoid force coming onto power plugs. Loose power plugs can cause arcing or fire.

Risk of injury or damage to the product!

- This product shall not be exposed to dripping or splashing!
- Do not place any sources of danger on this product (e.g. liquid filled objects, lighted candles).
- Never place the product or any objects on power cords or on other electrical equipment.
- If the product is transported in temperatures below 5°C, unpack the product and wait until its temperature matches room temperature before connecting it to the power outlet.

Risk of overheating!

- Never install this product in a confined space. Always leave a space of at least four inches around the product for ventilation.
- Make sure that curtains or other objects never cover the ventilation slots on the product.



Note

- The rated power voltage is printed on the back of the product. The model number and serial number are printed on the bottom.

2 Your clock radio

Congratulations on your purchase, and welcome to Philips! To fully benefit from the support that Philips offers, register your product at www.philips.com/welcome.

Introduction

With this product, you can:

- listen to FM radio stations (RDS supported),
- listen to DAB radio stations,
- listen to an external device through the **AUDIO IN** socket, and
- wake up to alarms.

What's in the box

Check and identify the contents of the package:

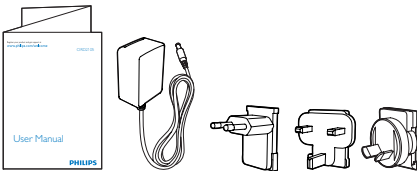
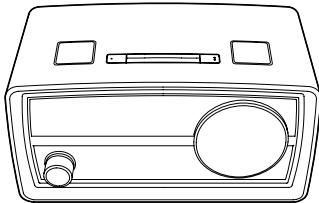

- ① Digital radio
- ② User manual
- ③ AC power adaptor
- ④ Plug converter for AC power adaptor X 3

Overview of the product

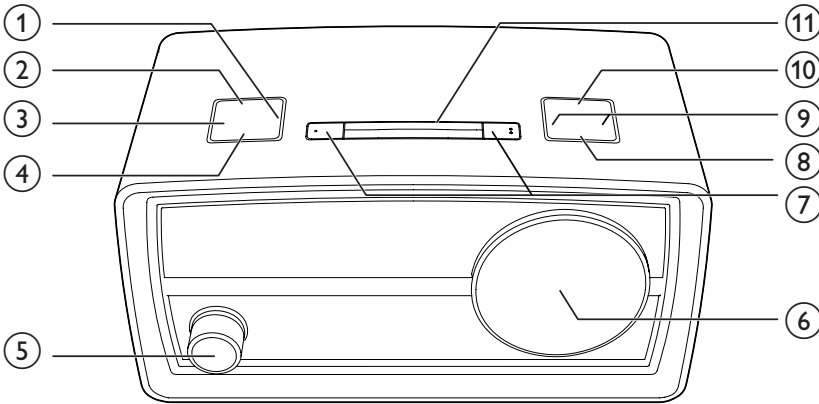

① TIMER

- Press and hold to start setting countdown timer.

② MENU / INFO

- In standby mode, press and hold to start setting time and date.
- In FM or DAB mode, press and hold to access the menus.
- When listening to an RDS or DAB station, press repeatedly to display available information.

③ SLEEP

- Press repeatedly to set the sleep timer.

④ SOURCE

- Press repeatedly to select a source.

⑤ Power and volume knob

- Press to power on or off the product.
- Rotate to adjust volume.

⑥ LCD display

⑦ AL1/AL2

- Press and hold to start setting an alarm timer.
- When an alarm rings, press to stop the alarm.

- Press to view the alarm settings.
- Press repeatedly to deactivate or activate the alarm timer.

⑧ PRESET

- Press to access the list of stored radio stations.

⑨ ▲ / ▼

- Press repeatedly to tune to a station.
- Press and hold to tune to the previous or next strong station automatically.
- Press to toggle through menus or options.

⑩ SCAN / SELECT

- Press and hold to start storing available radio stations automatically.
- Press to confirm an option.

⑪ SNOOZE/BRIGHTNESS

- Press to adjust the brightness of LCD display.
- When an alarm rings, press to snooze the alarm.

Know about the LCD display

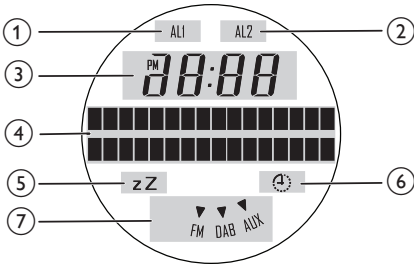

- ① The first alarm is activated.
- ② The second alarm is activated.
- ③ The clock
- ④ Text information
- ⑤ The sleep timer is activated.
- ⑥ The countdown timer is activated.
- ⑦ The current source

3 For the first time use

Assemble the AC power adaptor

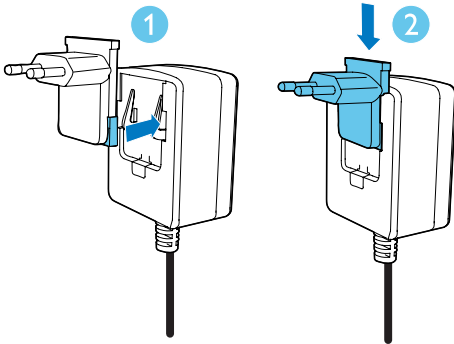

- 1 Align the plug converter to the holes on the power adaptor.
- 2 Push the plug converter downwards until you hear a "click".

Replace a plug converter

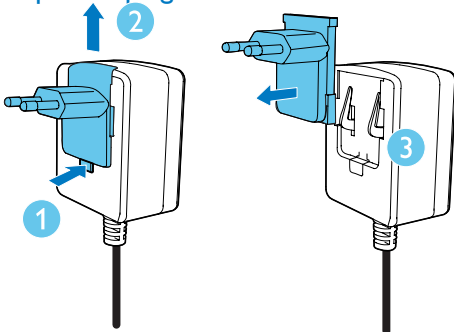

- 1 Press down the clip.
- 2 Slide the plug converter outwards.
- 3 Pull the plug converter out.
- 4 Fix another plug converter to the power adaptor.

Connect power

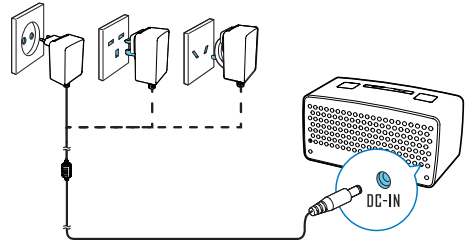

Connect the AC power adaptor between

- the **DC-IN** socket on the back panel, and
 - the AC power outlet.
- ↳ The product switches to standby mode.
- ↳ [0:00] blinks.

Power on

Press the power and volume knob.

- ↳ The product is powered on and switches to the last mode.

Switch to standby mode

Press the power and volume knob again.

- ↳ If the clock is neither manually set nor automatically synchronized with a DAB radio station, [0:00] blinks.
- ↳ If the clock is manually set or automatically synchronized with a DAB radio station, the time and date is displayed.











Adjust brightness

Press **BRIGHTNESS** repeatedly to adjust the brightness of the LCD display.

4 Set time and date

Note

- To manually set the clock, switch the product to standby mode first.

- 1 In standby mode, press and hold **MENU / INFO** until **[Set time]** is displayed.
↳ The hour digits blink.
- 2 Press  /  to set the hour, and then press **SCAN / SELECT** to confirm.
↳ The minute digits blink.
- 3 Press  /  to set the minute, and then press **SCAN / SELECT** to confirm.
↳ The date is displayed with the day digits blink.
- 4 Press  /  to set the day, and then press **SCAN / SELECT** to confirm.
↳ The month digits blink.
- 5 Press  /  to set the month, and then press **SCAN / SELECT** to confirm.
↳ The year digits blink.
- 6 Press  /  to set the year, and then press **SCAN / SELECT** to confirm.
↳ **[Time saved]** flashes, and then the set clock and date are displayed.

Tip

- When a DAB radio station that transmits time signals is broadcast, the product synchronizes its clock with the DAB radio station automatically.









5 Use the alarm timer



Note

- Make sure that you have set the clock correctly.

Set an alarm

You can set **two** alarms.

- 1 Press and hold **AL1** (or **AL2**) for two seconds.
 - ↳ **[Alarm 1]** (or **[Alarm 2]**) is displayed with **AL1** (or **AL2**) blinking.
 - ↳ The current alarm time is displayed with hour digits blinking.
- 2 Press  /  to set the hour, and then press **SCAN / SELECT** to confirm.
 - ↳ The minute digits begin to blink.
- 3 Press  /  to set the minute, and then press **SCAN / SELECT** to confirm.
 - ↳ The alarm source name begins to blink: **[DAB]**, **[FM]**, or **[Buzzer]**.
- 4 Press  /  to select an alarm source, and then press **SCAN / SELECT** to confirm.
 - If **[DAB]** or **[Buzzer]** is selected as the alarm source, press **SCAN / SELECT** to select a preset radio station or the last listened station.
 - ↳ The alarm frequency blinks: **[Daily]** (daily), **[Weekdays]** (weekdays), **[Weekends]** (weekends), or **[Once]** (once).
- 5 Press  /  to select a frequency, and then press **SCAN / SELECT** to confirm.
 - ↳ The alarm volume level blinks.

- 6 Press  /  to select the volume level, and then press **SCAN / SELECT** to confirm.
 - ↳ **[Alarm Saved]** flashes.

Deactivate a preset alarm

- 1 Press **AL1** (or **AL2**) to view alarm settings.
- 2 Press **AL1** (or **AL2**) again.
 - ↳ **[Alarm 1]** (or **[Alarm 2]**) and **[On]** is displayed.
- 3 Press **AL1** (or **AL2**) repeatedly to select **[On]** or **[Off]**.
 - **[On]**: The preset alarm is activated.
 - **[Off]**: The preset alarm is deactivated.
 - ↳ **AL1** (or **AL2**) is displayed when the preset alarm is activated.
 - ↳ **AL1** (or **AL2**) disappears when the preset alarm is deactivated.

Snooze the alarm

When an alarm sounds, press **SNOOZE**.

- ↳ The alarm repeats after 9 minutes.

Stop the alarm

When the first (or second) alarm sounds, press **AL1** (or **AL2**).

- ↳ The alarm stops and then repeats at the set time.

6 Listen to FM radio stations

Note

- For optimal reception, fully extend the antenna and adjust its position.
- You can store a maximum of 20 FM radio stations.

Switch to FM mode



Press **SOURCE** repeatedly until **[FM Mode]** is displayed.

- ↳ **FM** is highlighted.
- ↳ The current frequency is displayed.

Search for a radio station automatically

Press and hold / until **[Scanning...]** is displayed.

- ↳ After a strong radio station is detected, the search stops and the radio station is broadcast.

Search for a radio station manually

Press / repeatedly until the frequency of target radio station is displayed.

Store radio stations automatically

Press and hold **SCAN / SELECT** until **[Auto]** is displayed.

- ↳ After the search is complete, the first stored radio station is broadcast.

- To tune to a stored radio station, press **PRESET** to access the list of stored radio stations, and then press / repeatedly.

Program radio stations manually

- 1 Tune to a radio station.
 - 2 Press and hold **PRESET** until **[Preset store]** is displayed.
 - 3 Press / repeatedly to select a preset sequence number.
 - 4 Press **PRESET** to confirm.
 - ↳ The radio station is stored with the selected sequence number.
 - 5 Repeat steps 1-4 to program more radio stations.
- To tune to a stored radio station, press **PRESET** to access the list of stored radio stations, and then press / repeatedly.

Note

- If you store a radio station with the sequence number of another one, the earlier one is overwritten.

Display RDS information

Radio Data System (RDS) is a service that allows FM stations to transmit additional information. When you tune to an FM radio station that transmits RDS signals, the station name is displayed.





- 1 Tune to an RDS station.
- 2 Press **MENU / INFO** repeatedly to scroll through the following information (if available):
 - Station name
 - Radio text
 - Program type such as **[NEWS]** (news), **[SPORT]** (sport), **[POP M]** (pop music)...
 - Stereo/Mono

RDS program types

NOTYPE	No RDS programme type
NEWS	News services
AFFAIRS	Politics and current affairs
INFO	Special information programs
SPORT	Sports
EDUCATE	Education and advanced training
DRAMA	Radio plays and literature
CULTURE	Culture, religion and society
SCIENCE	Science
VARIED	Entertainment programs
POP M	Pop music
ROCK M	Rock music
MOR M	Light music
LIGHT M	Light classical music
CLASSICS	Classical music
OTHER M	Special music programs
WEATHER	Weather
FINANCE	Finance
CHILDREN	Children's programs
SOCIAL	Social Affairs
RELIGION	Religion
PHONE IN	Phone In

TRAVEL	Travel
LEISURE	Leisure
JAZZ	Jazz Music
COUNTRY	Country Music
NATION M	National Music
OLDIES	Oldies Music
FOLK M	Folk Music
DOCUMENT	Documentary
TES	Alarm Test
ALARM	Alarm

Adjust FM settings

- 1 Press and hold **MENU / INFO** to access the FM menu.
- 2 Press  /  to display the **[Scan setting]** menu.
- 3 Press **SCAN / SELECT** to access sub-menus.
- 4 Press  /  to select an option.
 - **[Strong stations]**: Search for strong stations only.
 - **[All stations]**: Search for all stations no matter whether the signal strength of a station is strong or weak.
- 5 Press **SCAN / SELECT** to confirm the option.

7 Listen to DAB radio stations

Note

- For optimal reception, fully extend the antenna and adjust its position.
- You can program a maximum of 20 DAB radio stations.
- Check with local retailer or go to www.WorldDAB.org for applicable DAB radio frequencies in your area.

Switch to DAB mode



Press **SOURCE** repeatedly until **[DAB Mode]** is displayed.

↳ **DAB** is highlighted.

For the first time use

- 1 Press **SOURCE** repeatedly to switch the product to DAB mode.
- 2 Press **▲** / **▼** repeatedly until the **[Full scan]** menu is displayed.
- 3 Press **SCAN / SELECT** to activate the automatic search.
 - ↳ This product automatically stores radio stations with sufficient signal strength.
 - ↳ After the search is complete, the first stored radio station is broadcast automatically.

- 4 Press **▲** / **▼** repeatedly to select a station, and then press **PRESET** to start listening.

Tip

- You can re-scan to update the list of stored stations (see 'Re-scan for stations' on page 13).
- You can tune to a station manually (see 'Tune to a station manually' on page 13).

About special symbols

Some symbol may be displayed before the name of a station.

- **H**: The station is one of your 10 favorite stations.
- **?**: The station is unavailable or inactive.
- **>>**: The station is a primary station with secondary service.
- **<<**: The station is a secondary station.

Tune to a stored radio station

- 1 Press **▲** / **▼** repeatedly to select a station.
- 2 Press **PRESET** to start listening.

Program radio stations

- 1 Tune to a DAB radio station.
- 2 Press and hold **PRESET** to activate the programming.
- 3 Press **▲** / **▼** repeatedly to select a preset sequence number.
 - ↳ The radio station is stored with the selected sequence number.
- 4 Press **PRESET** to confirm.
 - ↳ Repeat steps 1-4 to program more radio stations.
- 5 To tune to a stored radio station, press **PRESET** to access the list of stored radio stations, and then press **▲** / **▼** repeatedly.

Note

- If you store a radio station with the sequence number of another one, the earlier one is overwritten.

Display DAB information

The name of current DAB station is displayed. You can also view the other information.

To cycle through available information, press **MENU / INFO** repeatedly.

- Dynamic label segment (DLS)
- Signal strength
- Program type (PTY)
- Ensemble name
- Frequency
- Signal error rate
- Bitrate codec

Use DAB menus

- 1 Press and hold **MENU / INFO** to access the DAB menus.
- 2 Press **↔** / **↔** repeatedly to toggle through the menus.

Re-scan for stations

Full scan is used to perform a wide range search for DAB radio stations.

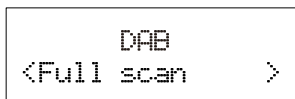

Press **SCAN / SELECT** to start scanning for available DAB stations.

- ↳ After the scanning is complete, the first stored station is broadcast.

Tune to a station manually

With this feature, you can tune to a specific channel/frequency manually. In addition to antenna orientation for better radio reception, the optimal reception can also be obtained with this feature.

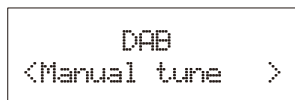

- 1 Press **SCAN / SELECT** to access the station list.
- 2 Press **↔** / **↔** repeatedly to select a station from 5A to 13F.



- 3 Press **SCAN / SELECT** to confirm the option.

DRC (Dynamic Range Control)

DRC adds or removes a degree of compensation for the differences in the dynamic range between radio stations.

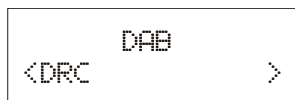



- 1 Press **SCAN / SELECT** to access the sub-menus.
- 2 Press **↔** / **↔** repeatedly to select an option. (The asterisk behind the option indicates the current setting.)
 - **[DRC off]**: No compensation applied.
 - **[DRC low]**: Medium compensation applied.
 - **[DRC high]**: Maximum compensation applied.
- 3 Press **SCAN / SELECT** to confirm the option.

Remove invalid stations

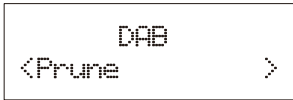

Some stations in the list have no service when you travel to another area. In front of the station name of an invalid station, a question mark (?) is displayed.

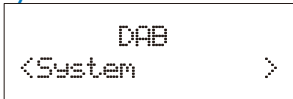

- 1 Press **SCAN / SELECT** to access the sub-menus.
- 2 Press  /  repeatedly to select an option.
 - **[No]**: Return to the previous menu.
 - **[Yes]**: Remove invalid stations from the station list.
- 3 Press **SCAN / SELECT** to confirm the option.

System menus



- 1 Press **SCAN / SELECT** to access system menus.
- 2 Press  /  repeatedly to select a sub-menu.
 - For details, refer to the section '**Use system menus**'.

8 Listen to an external device

You can also listen to an external audio device, for example, MP3 player, through this product.

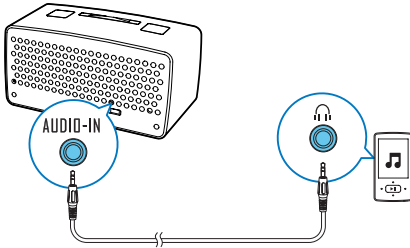

- 1 Press **SOURCE** repeatedly to switch the source to **[AUX IN]**.
↳ **AUX** is highlighted.
- 2 Connect an audio input cable with a 3.5 mm connector on both ends to
 - the **AUDIO-IN** socket on the back panel of this product, and
 - the headphone socket on the external device.
- 3 Play audio on the external device (refer to its user manual).

9 Use system menus

Use the system menus to

- check the version of current software of this product,
- upgrade the software, and
- reset the product to factory default status.

Check the current software version

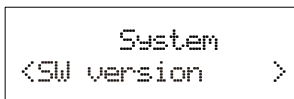

Press **SCAN / SELECT** to display the version of current software.

Upgrade the software

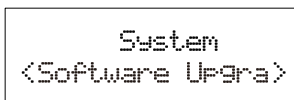

- 1 Go to www.philips.com/support.
- 2 Search for support information about this product with "OR2200/10" / "OR2200M/10" as the keyword.
 - ↳ When an upgrade packet is available, the link of "Installation instructions" under "Software & drivers" is accessible. The exact wording of link names may vary in different languages.
- 3 Click the link of "Installation instructions".
- 4 Read and understand the instructions on software upgrade.
- 5 Follow the instructions to complete the upgrade.

Reset the product

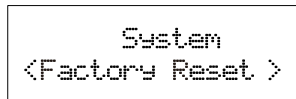

- 1 Press **SCAN / SELECT** to display the options.
- 2 Press **DOWN** / **UP** repeatedly to select an option.
 - **[No]**: Return to the previous menu.
 - **[Yes]**: Reset the product to factory default status.
- 3 Press **SCAN / SELECT** to confirm the option.

10 Adjust volume

- To increase the volume, turn the power and volume knob clockwise.
- To decrease the volume, turn the power and volume knob anti-clockwise.

11 Use the sleep timer

You can set a time period after which the product switches to standby mode automatically.

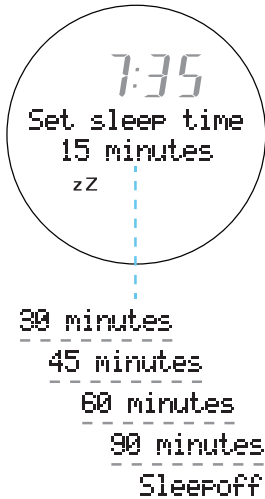









Press **SLEEP** repeatedly to select a time period (in minutes).

- ↳ When the sleep timer is activated, **zZ** appears.
- ↳ After the set period, the product switches to standby mode.
- To deactivate the sleep timer, press **SLEEP** repeatedly until [**Sleep off**] appears.

12 Use the countdown timer

You can set a time period after which the product buzzes.

- 1 Press and hold **TIMER** until  blinks.
↳ The hour digits blink.
- 2 Press  /  repeatedly to set the hour, and then press **SCAN / SELECT** to confirm.
↳ The minute digits blink.
- 3 Press  /  repeatedly to set the minute, and then press **SCAN / SELECT** to confirm.
↳ The second digits blink.
- 4 Press  /  repeatedly to set the second, and then press **SCAN / SELECT** to confirm.
↳  stops blink.
 - To stop the buzzer, press **TIMER** or the power and volume knob.

13 Troubleshooting



Warning

- Never remove the casing of this product.

To keep the warranty valid, never try to repair the product yourself.

If you encounter problems when using this product, check the following points before requesting service. If the problem remains unsolved, go to the Philips Web page (www.philips.com/support). When you contact the Consumer Care, make sure that the product is nearby and the model number and serial number are available.

No power

- Make sure that the AC power cord is properly connected.
- Make sure that there is power at the AC power outlet.

No sound

- Adjust the volume.
- When listening to an external device, make sure that the external device is not muted.

No response from the product

- Make sure that the power is available.
- Turn off the product, and then turn it on again.

Poor radio reception

- Due to the interference from other electrics or building obstacles, the signals become weak. Move the product to a place free of interference.
- Make sure that the antenna is fully extended. Adjust the position of the antenna.

Clock/alarm setting is erased.

- Power has been interrupted, or the AC power adaptor has been disconnected.
- Set the clock/alarm again.

14 Product information



Note

- Product information is subject to change without prior notice.

General information

AC power adaptor	Model No.: OH-1015E0591500U1 Brand name: Philips Input: 100-240 V~, 50/60Hz, 350 mA; Output: 5.9V \approx 1.5 A
------------------	--

Operation power consumption	2 W
-----------------------------	-----

Standby power consumption	< 1 W
---------------------------	-------

Dimensions: - Main unit (W x H x D)	245 x 123 x 122 mm
---	--------------------

Weight: - Main unit	1.1 kg
------------------------	--------

Tuner

Tuning Range	FM: 87.50 - 108.00 MHz; DAB: 174.928-239.200 MHz
--------------	---

Tuning grid	50 kHz
-------------	--------

DAB sensitivity (EN50248)	< -95 dbm
---------------------------	-----------

Total Harmonic Distortion	< 2%
---------------------------	------

Signal to Noise Ratio	> 50 dBA
-----------------------	----------

Number of preset radio stations	20 (FM), 20 (DAB)
---------------------------------	-------------------

Speakers

Speaker Impedance	4 Ohm
Speaker Driver	3" full range
Sensitivity	> 82x dB/m/W

Amplifier

Output Power	3 W RMS
Frequency Response	60 Hz - 16 kHz, \pm 3 dB
Signal to Noise Ratio	> 65 dBA
Audio Input	0.5V RMS 20 kOhm

15 Notice

Any changes or modifications made to this device that are not expressly approved by WOOX Innovations may void the user's authority to operate the equipment.

Compliance



This product complies with the radio interference requirements of the European Community.



This is CLASS II apparatus with double insulation, and no protective earth provided.

Care of the environment



Your product is designed and manufactured with high quality materials and components, which can be recycled and reused.



When this crossed-out wheeled bin symbol is attached to a product it means that the product is covered by the European Directive 2002/96/EC. Please inform yourself about the local separate collection system for electrical and electronic products.

Please act according to your local rules and do not dispose of your old products with your normal household waste.

Correct disposal of your old product helps to prevent potential negative consequences for the environment and human health.

Environmental information

All unnecessary packaging has been omitted. We have tried to make the packaging easy to separate into three materials: cardboard (box), polystyrene foam (buffer) and polyethylene (bags, protective foam sheet.)

Your system consists of materials which can be recycled and reused if disassembled by a specialized company. Please observe the local regulations regarding the disposal of packaging materials, exhausted batteries and old equipment.

Copyright

2014 © WOOX Innovations Limited. All rights reserved.

Philips and the Philips' Shield Emblem are registered trademarks of Koninklijke Philips N.V. and are used by WOOX Innovations Limited under license from Koninklijke Philips N.V.®

Specifications are subject to change without notice. WOOX reserves the right to change products at any time without being obliged to adjust earlier supplies accordingly.



Specifications are subject to change without notice.
2014 © WOOX Innovations Limited. All rights reserved.
Philips and the Philips' Shield Emblem are registered
trademarks of Koninklijke Philips N.V. and are used by WOOX
Innovations Limited under license from Koninklijke Philips N.V.

OR2200_10_UM_V2.0



Free Manuals Download Website

<http://myh66.com>

<http://usermanuals.us>

<http://www.somanuals.com>

<http://www.4manuals.cc>

<http://www.manual-lib.com>

<http://www.404manual.com>

<http://www.luxmanual.com>

<http://aubethermostatmanual.com>

Golf course search by state

<http://golfingnear.com>

Email search by domain

<http://emailbydomain.com>

Auto manuals search

<http://auto.somanuals.com>

TV manuals search

<http://tv.somanuals.com>