

SAFETY AND
TROUBLESHOOTING

ABOUT
THIS MANUAL

PRODUCT
INFORMATION

INSTALLING
YOUR MONITOR

ON-SCREEN
DISPLAY

REMOTE CONTROL

CUSTOMER CARE
AND WARRANTY

DOWNLOAD
AND PRINT

EXIT

ELECTRONIC USER'S MANUAL



300WN5

LCD MONITOR/TV

Safety and Troubleshooting Information

[Safety Precautions and Maintenance](#) • [Installation Locations](#) • [FAQs](#) • [Troubleshooting](#) • [Regulatory Information](#) • [Other Related Information](#)

Safety precautions and maintenance



WARNING: Use of controls, adjustments or procedures other than those specified in this documentation may result in exposure to shock, electrical hazards and/or mechanical hazards.

Read and follow these instructions when connecting and using your computer monitor:

- Unplug the monitor if you are not going to use it for an extensive period of time.
- Unplug the monitor if you need to clean it with a slightly damp cloth. The screen may be wiped with a dry cloth when the power is off. However, never use alcohol, solvents or ammonia-based liquids.
- Consult a service technician if the monitor does not operate normally when you have followed the instructions in this manual.
- The casing cover should be opened only by qualified service personnel.
- Keep the monitor out of direct sunlight and away from stoves or any other heat source.
- Remove any object that could fall into the vents or prevent proper cooling of the monitor's electronics.
- Do not block the ventilation holes on the cabinet.
- Keep the monitor dry. To avoid electric shock, do not expose it to rain or excessive moisture.
- If turning off the monitor by detaching power cable or DC power cord, wait for 6 seconds before attach the power cable or DC power cord for normal operation.
- To avoid the risk of shock or permanent damage to the set do not expose the monitor to rain or excessive moisture.
- When positioning the monitor, make sure the power plug and outlet are easily accessible.
- **IMPORTANT:** Always activate a screen saver program during your application. If a still image in high contrast remains on the screen for an extended period of time, it may leave an 'after-image' or 'ghost image' on the front of the screen. This is a well-known phenomenon that is caused by the shortcomings inherent in the LCD technology. In most cases the after-image will disappear gradually over a period of time after the power has been switched off. Be aware that the after-image symptom cannot be repaired and is not covered under warranty.

Consult a service technician if the monitor does not operate normally when the operating instructions given in this manual have been followed.

[RETURN TO TOP OF THE PAGE](#)

Installation Locations

- Avoid exposure to heat and extreme cold
- Do not store or use the product in locations exposed to heat, direct sunlight or extreme cold.
- Avoid moving the product between locations with large temperature differences. Choose a site that falls within the following temperature and humidity ranges.
 - Temperature: 0-35°C 32-95°F
 - Humidity: 20-80% RH
- Do not subject the product to severe vibration or high impact conditions. Do not place the product inside a car boot.
- Take care not to mishandle this product by either knocking or dropping during operation or transportation.
- Do not store or use the product in locations where there is a high level of humidity or in dusty environments. Do not allow water or other liquids to spill on or into the product.

[RETURN TO TOP OF THE PAGE](#)

About This Manual

[About This Guide](#) • [Notational Descriptions](#)

About This Guide

This electronic user's guide is intended for anyone who uses the Philips LCD Monitor TV. It describes the features, setup, operation and other important information.

It includes the following sections:

- [Safety and Troubleshooting Information](#) provides tips and solutions for common problems as well as other related information you may need.
- About This Electronic User's Manual gives an overview of information included, along with notation icon descriptions and other documentation for your reference.
- [Product Information](#) gives an overview of the monitor's features as well as the technical specifications for this monitor.
- [Installing Your Monitor](#) describes the initial setup process and gives an overview of how to use the monitor.
- [On-Screen Display](#) provides information on adjusting the settings on your monitor.
- [Remote Control](#) provides information on adjusting the settings for your TV function.
- [Customer Care and Warranty](#) contains a list of worldwide Philips Consumer Information Centres along with help desk phone numbers and information on the warranty applicable to your product.
- [Download and Print Option](#) transfers this entire manual to your hard drive for easy reference.

[RETURN TO TOP OF THE PAGE](#)

Notational Descriptions

The following subsections describe notational conventions used in this document.

Notes, Cautions and Warnings

Throughout this guide blocks of text may be accompanied by an icon and printed in bold or italic type. These blocks contain notes, cautions or warnings. They are used as follows:



NOTE: This icon indicates important information and tips that help you make better use of your computer system.



CAUTION: This icon indicates information that tells you how to avoid either potential damage to hardware or loss of data.



WARNING: This icon indicates the potential for bodily harm and tells you how to avoid the problem.

Some warnings may appear in alternate formats and may not be accompanied by an icon. In such cases, the specific presentation of the warning is mandated by the relevant regulatory authority.

[RETURN TO TOP OF THE PAGE](#)

©2004 Koninklijke Philips Electronics N.V.

All rights reserved. Reproduction, copying, use, modification, hiring, renting, public performance, transmission and/or broadcasting in whole or in part is prohibited without written consent of Philips Electronics N.V.

Product Information

[Product Features](#) •
 [Technical Specifications](#) •
 [Resolution & Preset Modes](#) •
 [Philips Pixel Defect Policy](#) •
 [Automatic Power Saving](#) •
 [Physical Specification](#) •
 [Pin Assignment](#) •
 [Product Views](#)

Product Features

300WN5

- 29.5-inch WXGA (1280x768 resolution, 170 degree viewing angle) LCD all-in-one Monitor TV with excellent display performance
- Multiple video input allowing display of PC, TV, HDTV, VCD, DVD, Progressive DVD and Camcorder
- Network controllability via RS232 interface for managing the performances, setting, etc.
- Digital High Definition Picture (1080i, 720p, 576p, 576i, 480p, 480i)
- DCDi™ de-interlacing technology for superior depiction of motion
- Picture-in-Picture (PIP) function in PC VGA mode
- Light sensor to adjust brightness automatically
- Teletext (available only in Asia Pacific and Western Europe)
- Digital Nicam/2CS stereo (available only in Asia Pacific and Western Europe)
- Component Video Input (YPbPr/YCbCr) for DVD (available in AV and TV models only)
- Euroconnector (SCART) (available in Western Europe)
- MultiSystem TV tuner-PAL/NTSC/SECAM (available in TV model only)

[RETURN TO TOP OF THE PAGE](#)

Technical Specifications*

LCD PANEL

• Type	TFT LCD
• Screen size	29.53 inch

• Pixel Pitch	0.5025 x 0.5025 mm
• LCD Panel type	1280 x 768 pixels R.G.B. vertical stripe Hard coating surface, anti-glare polarizer
• Effective viewing area	(H) 643.2 x (V) 385.92mm
• Display Colors	8 bits interface (16.7M colors)

PC SCANNING

• Vertical refresh rate	58Hz-60Hz
• Horizontal frequency	31kHz-49kHz

PC VIDEO

• Video dot rate	< 80 MHz
• Input impedance	
- Video	75 ohm
- Sync	2.2K ohm
• Input signal levels	0.7 Vpp
• Sync input signal	Separate sync
• Sync polarities	Positive and negative
• Input Frequency	WXGA Hsync 48 kHz, Vsync 60 Hz (N.I.) SVGA Hsync 38 kHz, Vsync 60 Hz (N.I.) VGA Hsync 31 kHz, Vsync 60 Hz (N.I.)
• Video interface	D-sub, S-Video, TV-RF, SCART (Europe) or composite and components video (others)

AUDIO

• Input level for PC/SVHS/SCART	500 mV nominal
• Loudspeaker	5W Stereo Audio (2.5W/channel RMS x2, 200Hz~10kHz, 4 ohm, 10% THD)

OPTICAL CHARACTERISTICS

• Contrast ratio	800:1 (typ.)
• Brightness	600 cd/m ² (typ.)
• Peak contrast angle	6 o'clock
• White Chromaticity	x: 0.283 y: 0.297 (at 9300°K) x: 0.313 y: 0.329 (at 6500°K) x: 0.328 y: 0.344 (at 5700°K)
• Viewing Angle (C/R >5)	Upper ≥85° (typ.) Lower ≥85° (typ.) Left ≥85° (typ.) Right ≥85° (typ.)
• Response time	≤16ms (typ.)

sRGB

sRGB is a standard for ensuring correct exchange of colors between different devices (e.g. digital cameras, monitors, printers, scanners, etc.)

Using a standard unified color space, sRGB will help represent pictures taken by an sRGB compatible device correctly on your sRGB enabled Philips monitors. In that way, the colors are calibrated and you can rely on the correctness of the colors shown on your screen.

Important with the use of sRGB is that the brightness and contrast of your monitor is fixed to a predefined setting as well as the color gamut. Therefore it is important to select the sRGB setting in the monitor's OSD.

To do so, at PC mode, open the OSD by pressing the MENU button of your monitor. Use the down button to go to COLOR SETTINGS and press MENU again. Then move the down button to go to NORMAL COLOR and press MENU again.

** This data is subject to change without notice.*

[RETURN TO TOP OF THE PAGE](#)

Resolution & Preset Modes

- Recommended 1280 x 768 at 60Hz

10 factory preset modes:

Resolution	Mode	H. freq (kHz)	V. freq (Hz)
------------	------	---------------	--------------

PC

640*480	VGA VESA 60	31.469	59.940
800*600	SVGA VESA 60	37.879	60.317
1024*768	XGA VESA 60	48.363	60.004
1280*768	GTF 60	47.700	60.000

Video

EDTV	480P	31.470	60.000
SDTV	480i	15.734	59.940
EDTV	576P	31.250	50.000
SDTV	576i	15.625	50.000
HDTV	1080i	33.750	60.000
HDTV	720P	45.000	60.000

[RETURN TO TOP OF THE PAGE](#)

Automatic Power Saving

If you have VESA DPMS compliance display card or software installed in your PC, the monitor can automatically reduce its power consumption when not in use. If an input from a keyboard, mouse or other input device is detected, the monitor will then 'wake up' automatically. The following table shows the power consumption and signaling of this automatic power saving feature:

Power Management Definition					
VESA Mode	Video	H-sync	V-sync	Power Used	LED color
ON	Active	Pulse	Pulse	130W (typ.)	Blue

OFF	Blanked	No	No	< 5W	Amber
AC OFF	Blanked	No	No	< 2W	Off

This monitor is ENERGY STAR® compliant. As an ENERGY STAR® Partner, PHILIPS has determined that this product meets the ENERGY STAR® guidelines for energy efficiency.

[RETURN TO TOP OF THE PAGE](#)

Physical Specifications

• Dimension (WxHxD) *	867.7mm x 505mm x 183mm (incl. Pedestal, Speakers) 726.7mm x 469.3mm x 115mm (w/o Pedestal, Speakers)
• Weight	16.0 kg (incl. Pedestal, Speakers) 14.0 kg (w/o Pedestal, Speakers) 15.0 kg (w/o Pedestal, Speakers; with protective cover)
• Power supply	90 — 264 VAC, 50/60 Hz
• Power consumption	PC Mode: 130 W (typ.) TV Mode: 150 W (typ.)
• Temperature (operating)	0° C to 35° C
• Relative humidity	20% to 80%
• System MTBF	50K hrs (excluding CCFL 40Khrs)

* This data is subject to change without notice.

[RETURN TO TOP OF THE PAGE](#)

Pin Assignment

1. The digital only connector contains 24 signal contacts organized in three rows of eight contacts. Signal pin assignments are listed in the following table:

Pin No.	Signal Assignment	Pin No.	Signal Assignment	Pin No.	Signal Assignment
1	T.M.D.S. Data2-	9	T.M.D.S. Data1-	17	T.M.D.S. Data0-
2	T.M.D.S. Data2+	10	T.M.D.S. Data1+	18	T.M.D.S. Data0+
3	T.M.D.S. Data2/4 Shield	11	T.M.D.S. Data1/3 Shield	19	T.M.D.S. Data0/5 Shield
4	No connect	12	No connect	20	No connect
5	No connect	13	No connect	21	No connect
6	DDC Clock	14	+5V Power	22	T.M.D.S. Clock Shield
7	DDC Data	15	Hot Plug Detect	23	T.M.D.S. Clock+
8	No connect	16	Ground (for +5V)	24	T.M.D.S. Clock-

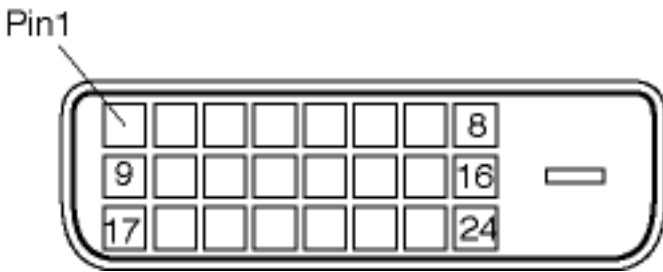

2. The 15-pin D-sub connector (male) of the signal cable:

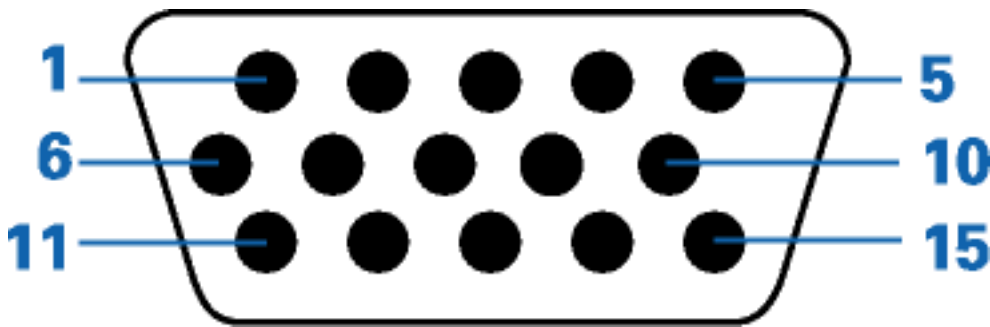

Pin No.	Assignment	Pin No.	Assignment
1	Red video input	9	DDC +5V

2	Green video input	10	Cable detect
3	Blue video input	11	Identical output, connected to pin 10
4	Ground	12	Serial data line (SDA)
5	NC	13	H. Sync / H+V
6	Red video ground	14	V. Sync
7	Green video ground	15	Data clock line (SCL)
8	Blue video ground		

3. RS232 Connector

D-sub 9-pin male connector for communication with plasma engine or PC.

RS232 DB9 (EIA/TIA 574)



(view into male end)

Pin No.	RS-232 (EIA-232-A) Function
3	Transmit Data (TD) from DTE to DCE
2	Receive Data (RD) from DCE to DTE
7	Request to Send (RTS)
8	Clear to Send (CTS)
6	DCE Ready (DSR)
5	Signal Ground (SG)
1	Received Line Signal Detector (DCD)
4	DTE Ready (DTR)
9	Ring Indicator

4. SCART Connector

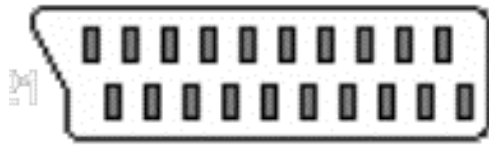

Pin No.	Signal	Pin No.
1	Audio right channel output (0.5 Vrms, < 1K ohms)	2
2	Audio right channel input (0.5 Vrms, > 10K ohms)	1
3	Audio left channel output (0.5 Vrms, < 1K ohms)	6
4	Audio ground	4
5	Blue signal ground	5
6	Audio left channel input (0.5 Vrms, > 10K ohms)	3
7	Blue signal I/O (0.7 Vp-p, 75 ohms)	7
8	Function switching I/O (L: < 2V, H: > 10V, 10K ohms)	8
9	Green signal ground	9
10	Intercommunication data line No. 1	10
11	Green signal I/O (0.7 Vp-p, 75 ohms)	11
12	Intercommunication data line No. 2	12
13	Red signal ground	13
14	Blanking signal ground	14
15	Red signal I/O (0.7 Vp-p, 75 ohms)	15
16	Blanking signal I/O (L: < 0.4V, H: >1.0V, 75 ohms)	16
17	Composite video signal ground	18
18	Blanking signal ground	17

19	Composite video signal output (1 Vp-p, 75 ohms, sync: negative)	20
20	Composite video signal input (1 Vp-p, 75 ohms, sync: negative)	19
21	Plug shield (common ground)	21

[RETURN TO TOP OF THE PAGE](#)

[Product Views](#)

Follow the links to see various views of the monitor and its components.

[Product Description](#)

[RETURN TO TOP OF THE PAGE](#)



Installing your LCD Monitor/TV

[Product Description](#) • [Connecting to Your PC, TV antenna, DVD/VCR etc.](#) • [Getting Started](#) • [Optimizing Performance](#)

Product Description

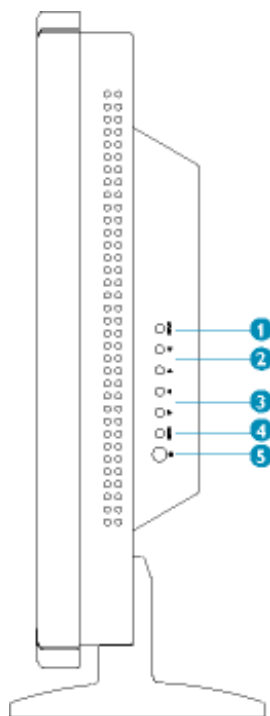
Side View (Left)



- | | | |
|---|---|--|
| 1 | INPUT | Selecting input source |
| 2 |  | Increase or decrease the channel number
or
moving up or down to highlight the function in OSD |
| 3 |  | Increase or decrease the level of audio volume
or
moving left or right to highlight the sub-menu in the selected function of OSD |
| 4 | MENU | Open the OSD or confirm the selected function |
| 5 |  | DC power switch On/Off |

[RETURN TO TOP OF THE PAGE](#)

Rear View

TV version

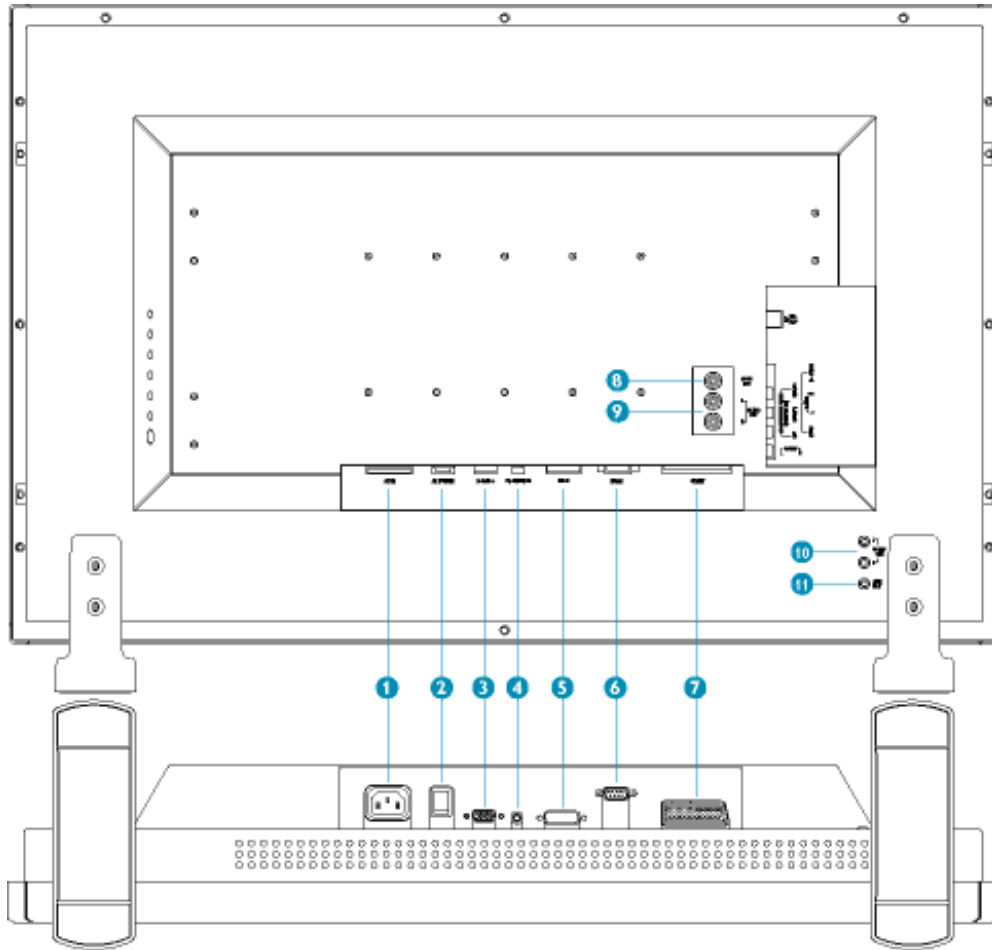

- | | | |
|---|------------------------|------------------------------------|
| 1 | AC IN | AC power in |
| 2 | AC Power | AC power switch |
| 3 | D-Sub | PC analog D-Sub input |
| 4 | PC - Audio | PC Stereo input |
| 5 | DVI-D | PC digital input |
| 6 | RS232 | RS232 network connection |
| 7 | External/
EURO-AV | SCART connection (for Europe only) |
| 8 | Composite Video Output | Composite video CVBS output |

- | | | |
|----|------------------|---|
| 9 | Audio (L) Output | Audio (L) output |
| | Audio (R) Output | Audio (R) output |
| 10 | Audio (L) Output | Audio (L) output for the detachable speaker (L) |
| | Audio (R) Output | Audio (R) output for the detachable speaker (R) |
| 11 | Line out | Audio output for external speakers |

RETURN TO TOP OF THE PAGE

Audio/Video version

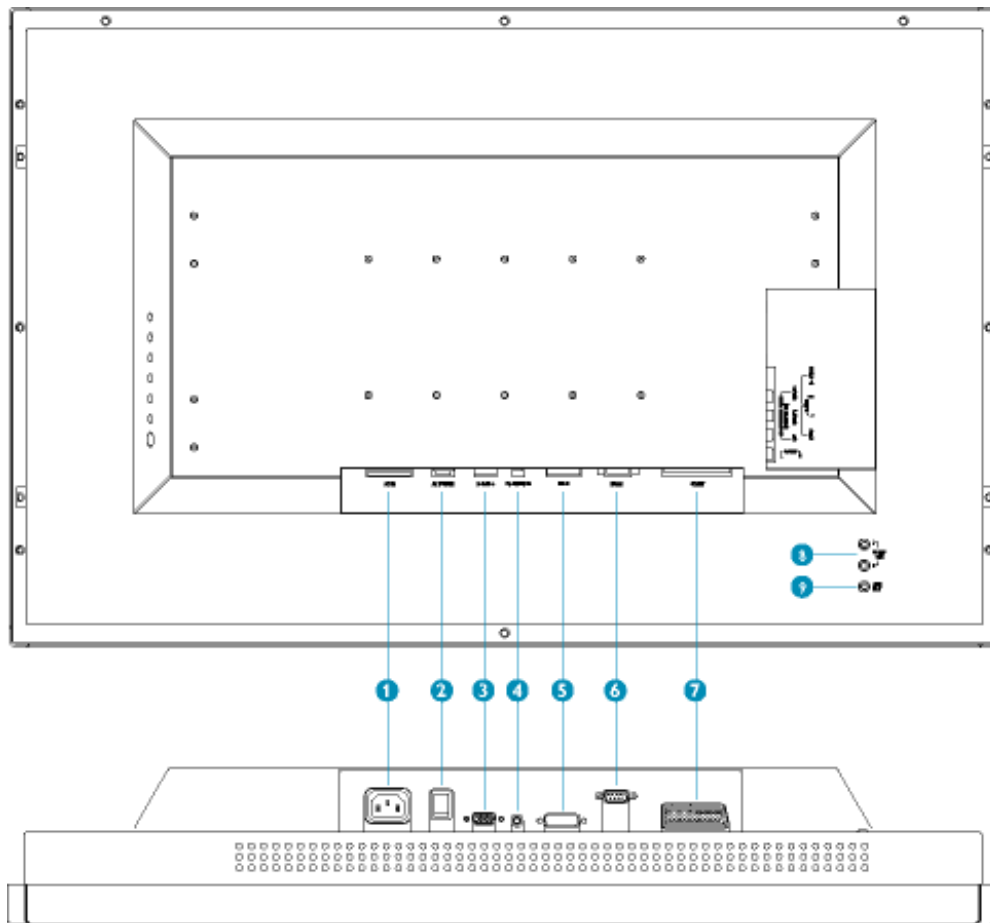

- | | | |
|---|----------|-----------------------|
| 1 | AC IN | AC power in |
| 2 | AC Power | AC power switch |
| 3 | D-Sub | PC analog D-Sub input |

- | | | |
|---|----------------------|---|
| 4 | PC - Audio | PC Stereo input |
| 5 | DVI-D | PC digital input |
| 6 | RS232 | RS232 network connection |
| 7 | External/
EURO-AV | SCART connection (for Europe only) |
| 8 | Audio (L) Output | Audio (L) output for the detachable speaker (L) |
| | Audio (R) Output | Audio (R) output for the detachable speaker (R) |
| 9 | Line out | Audio output for external speakers |

[RETURN TO TOP OF THE PAGE](#)

Monitor version

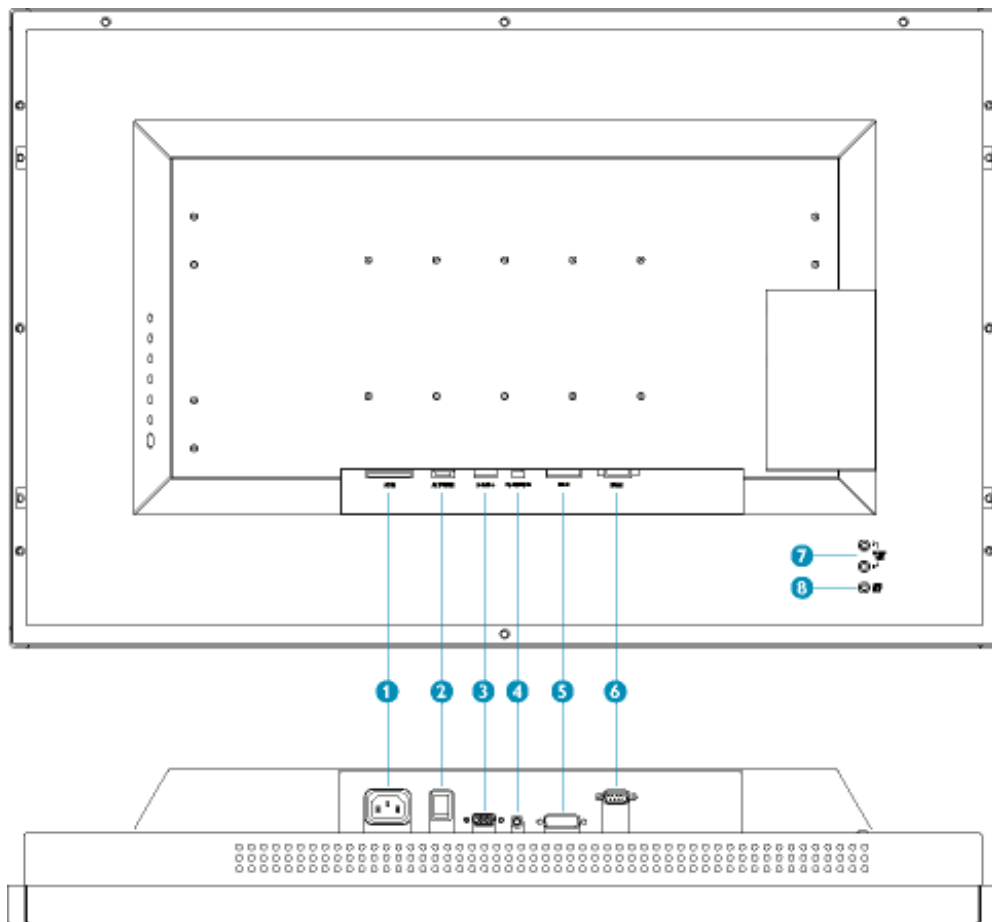

1 AC IN AC power in

2	AC Power	AC power switch
3	D-Sub	PC analog D-Sub input
4	PC - Audio	PC Stereo input
5	DVI-D	PC digital input
6	RS232	RS232 network connection
7	Audio (L) Output	Audio (L) output for the detachable speaker (L)
	Audio (R) Output	Audio (R) output for the detachable speaker (R)
8	Line out	Audio output for external speakers

[RETURN TO TOP OF THE PAGE](#)

[Side View \(Right\)](#)

[TV version](#)

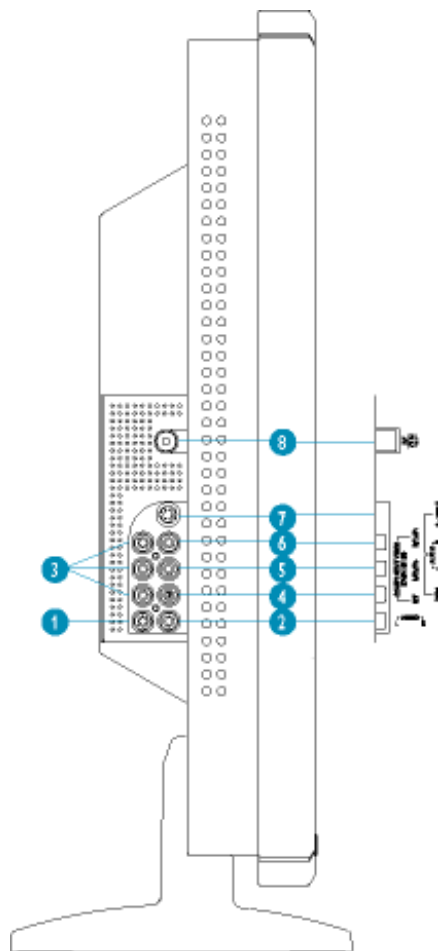

- | | | |
|---|-----------------|--------------------------------|
| 1 | Audio (L) | Audio (L) for component video |
| 2 | Audio (R) | Audio (R) for component video |
| 3 | Component Video | Component video Y/Pb/Pr input |
| 4 | Composite Video | Composite video CVBS input |
| 5 | Audio (L) | Audio (L) for CVBS and S-Video |
| 6 | Audio (R) | Audio (R) for CVBS and S-Video |
| 7 | S-Video | S-Video input |
| 8 | RF 75 Ω | TV Antenna or CATV cable in |

[RETURN TO TOP OF THE PAGE](#)

Audio/Video version

[Downloaded From TV-Manual.com Manuals](#)

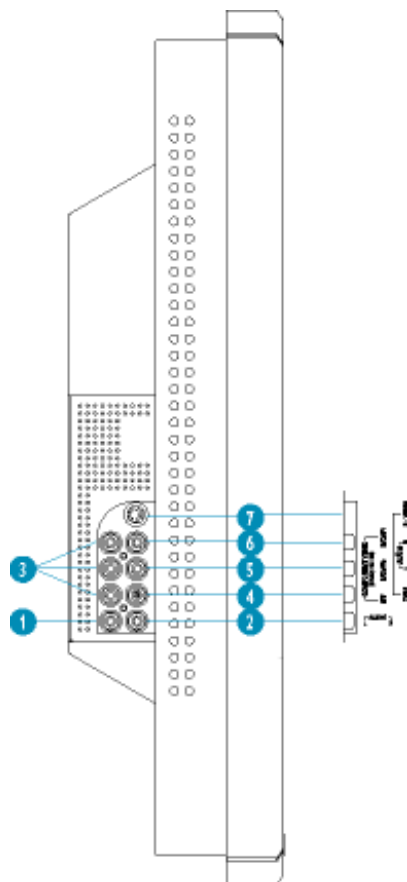

- | | | |
|---|-----------------|--------------------------------|
| 1 | Audio (L) | Audio (L) for component video |
| 2 | Audio (R) | Audio (R) for component video |
| 3 | Component Video | Component video Y/Pb/Pr input |
| 4 | Composite Video | Composite video CVBS input |
| 5 | Audio (L) | Audio (L) for CVBS and S-Video |
| 6 | Audio (R) | Audio (R) for CVBS and S-Video |
| 7 | S-Video | S-Video input |

[RETURN TO TOP OF THE PAGE](#)

Optimising Performance

- For best performance, ensure that your display settings are set at 1280x768, 60Hz.



Note: You can check the current display settings by pressing the 'MENU' button once.

- You can also install the Flat Panel Adjust (FP Adjust) program, a program for getting the best performance out of your monitor. This is included on this CD. Step-by-step instructions are provided to guide you through the installation process. Click on the link to find out more about this program.



More about [FP_setup04.exe](#)

[RETURN TO TOP OF THE PAGE](#)

On Screen Display

On Screen Display Control • Using Your Remote Control

On Screen Display Controls

An overall view of the On-Screen Display (OSD) structure is shown below. You can use it as a reference for further adjusting your Monitor/TV.

There are three different modes of OSD available for different models:

- PC Mode
- Audio/Video Mode
- TV Mode



PC Mode



A Main Menu **B** Sub-Menu name **C** Menu icon

1. With the menu off, push the MENU button to enter OSD system and display the main menu.

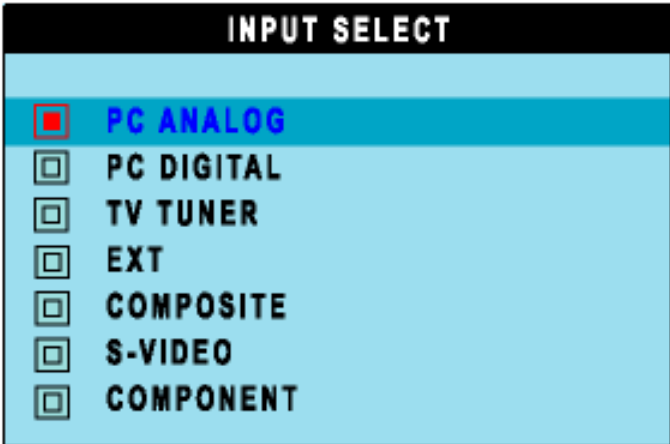

2. Push the ▲ and ▼ buttons to move between the function icons. As you move from one icon to another, the function name will be highlighted.
3. Push the MENU button once to activate the highlighted function. Push ◀ / ▶ to select the preferred parameter, push the **MENU** button to enter the selected one, then use the ◀ and ▶ buttons making your changes.
4. Push the **MENU** button to return the main menu or select another function.

Icon	Menu Name and Sub-menus	Description
	EXIT	This is used to exit out of the Main menu.
	INPUT SELECT	<p>Select video source for main display:</p> <ul style="list-style-type: none"> ● PC ANALOG: PC VGA input ● PC DIGITAL: PC DIGITAL input ● TV TUNER: Antenna or cable TV input ● EXT: Scart input ● COMPOSITE: Composite video input ● S-VIDEO: S-video input ● COMPONENT: Component video input 





BRIGHTNESS/ CONTRAST

The Brightness function :

Push the  button to increase luminance;
push the  button to decrease luminance (min 0 ~ max. 100).

The Contrast function :

Push the  button to increase the contrast;
push the  button to decrease the contrast (min 0 ~ max. 100).

The Light Sensor function:

Push the  buttons to toggle Light Sensor function.
This function automatically finetunes the brightness of the monitor according to the environment.

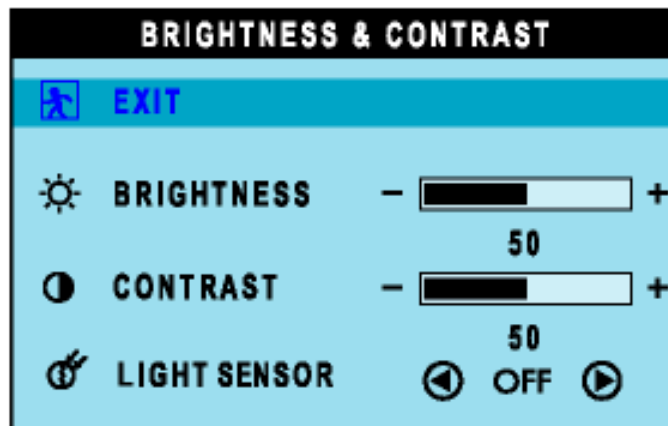

Select your preferred function.

EXIT: Exit this menu

TREBLE: Adjustable from 0 to 100

BASS: Adjustable from 0 to 100

BALANCE: Adjustable from 0 to 100

VOLUME: Adjustable from 0 to 100



AUDIO

SURROUND: ON/OFF

MUTE: ON/OFF

AUDIO SOURCE: Only in PC TV/VIDEO mode

POWER SAVING:ON/OFF



Positioning moves the viewing area around on the monitor screen.

EXIT: Exit this menu

H.POSITION /V.POSITION: When making changes to either the 'Horizontal' or 'Vertical' settings, the image will simply be shifted in response to your selection/change.

Minimum is '0' (◀). Maximum is '100' (▶).

4:3 ASPECT RATIO: Select 4:3 image display

FULL SCREEN: Select full screen (16:9) image display

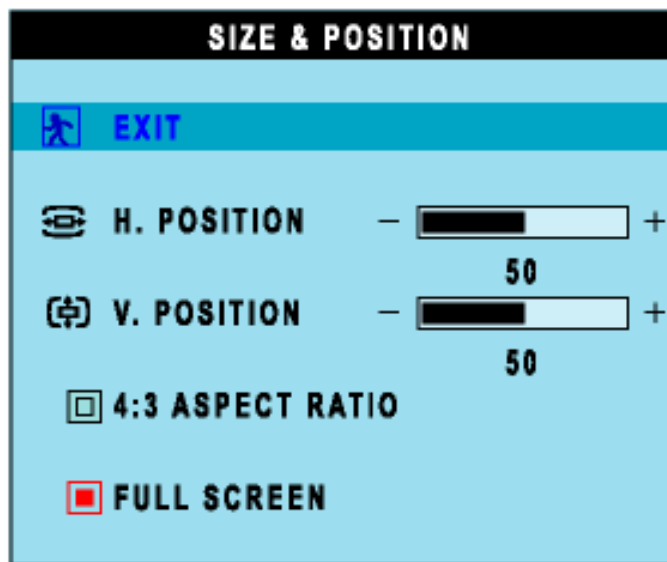

SIZE & POSITION

**NOTE:**

1. When operating in DVI mode, the positioning adjustments are not available.

2. The 4:3 Aspect Ratio and Full Screen items are not available in WXGA 1280x768 modes.

To adjust the image settings.

EXIT: Exit this menu

AUTO ADJUST: Press to select automatic adjustment .

PHASE : Use the ◀ and ▶ buttons to adjust from 0 to 100.

PIXEL CLOCK: Use the ◀ and ▶ buttons to adjust from 0 to 100.

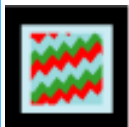

IMAGING SETTINGS

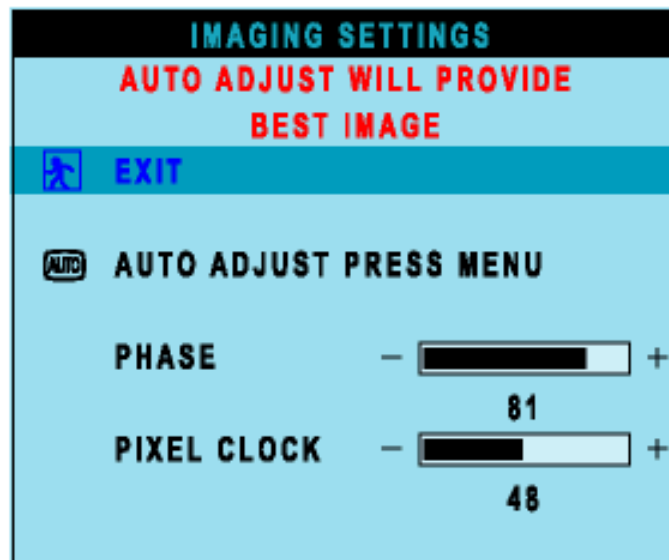

Note: Operating in DVI mode, the Pixel Clock and Phase adjustments are not available.

Color Settings adjusts the color temperature.

EXIT: Exit this menu

NATURE COLOR: Equivalent to original panel color.

NORMAL COLOR: 6500K (Same as sRGB) default from FACTORY

BLUE PRESET: Equivalent to 9300K

RED PRESET: Equivalent to 5700K

USER PRESET: Adjust red, green, blue three colors from 0 to 100.



**COLOR
SETTINGS**

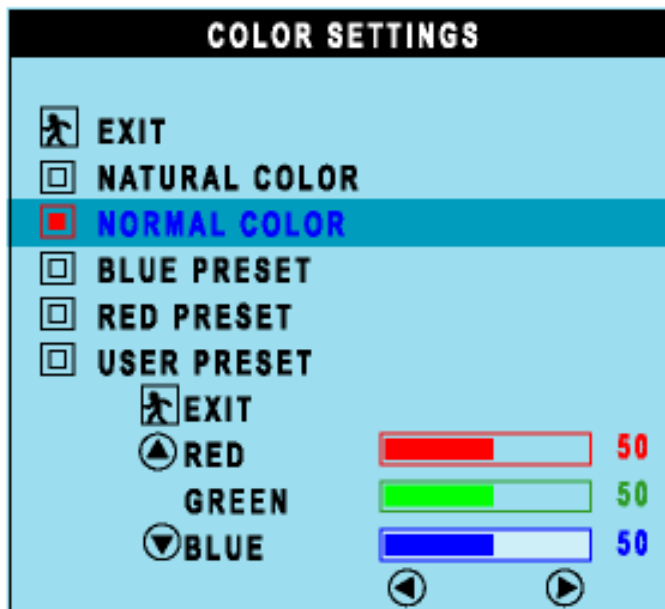

Each time the OSD opens, it displays in the same location on the screen. 'OSD Settings' (horizontal/vertical) provides control over this location.

EXIT: Exit this menu

HORIZONTAL: Adjustable from 0 to 100.

VERTICAL: Adjustable from 0 to 100.

OSD HOLD TIME: The OSD stays active for as long as it is in use. The range of time setting is from 5 to 60 seconds.

OSD LOCK: Controls user access to adjustments. Show key icon after selecting lock.



**OSD
SETTINGS**

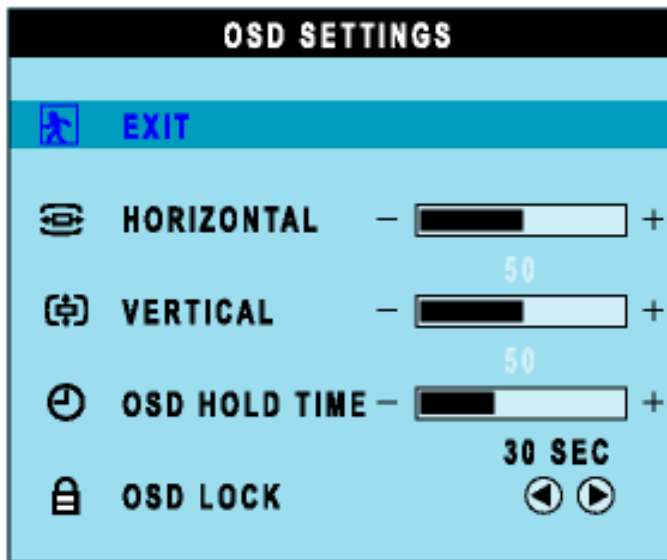

Note:
When the OSD is locked, press menu button on the monitor, and the OSD LOCK menu will appear. Press (+) to unlock and allow user access to all applicable settings.

Language sets the OSD to display in one of the five or six languages provided. That is, English, Spanish, French, German, Italian (not available in NAFTA model) and Simplified Chinese (China models only).



LANGUAGE





FACTORY RESET

Reset the settings to the factory default values.

EXIT: Exit this menu

POSITION SETTINGS ONLY: Resume position setting to factory default.

COLOR SETTINGS ONLY: Resume color setting to factory default.

ALL SETTINGS: Load all factory default settings.

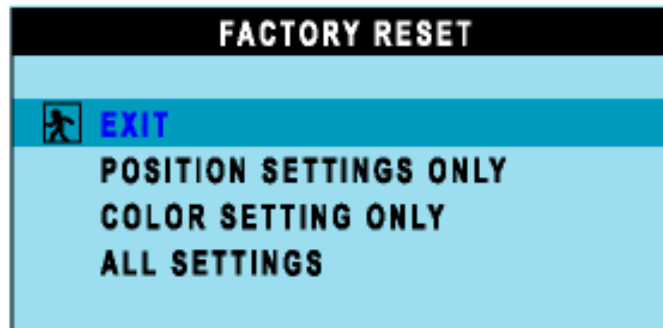

PICTURE IN PICTURE

Adjust picture in picture preferences.

SIZE: Turn off and set the size of PIP. Users can chose your preferred size.

- OFF
- SMALL
- MEDIUM
- LARGE

H POSITION: Adjust the Horizontal position of PIP.

V POSITION: Adjust the Vertical position of PIP.

VIDEO SOURCE: Select video source of PIP:

- EXIT
- TV TUNER
- EXT
- COMPOSITE VIDEO
- S-VIDEO
- COMPONENT VIDEO

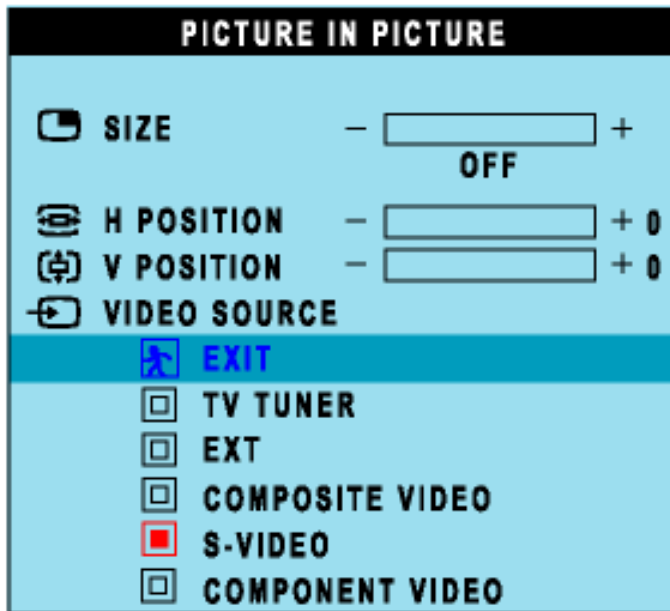

RETURN TO TOP OF THE PAGE

Audio/Video Mode

Exit from this menu.

EXIT



Use up and down arrow button to highlight the "INPUT SELECT".

Select video source for main display:

- **PC ANALOG:** PC VGA input
- **PC DIGITAL:** PC DIGITAL input
- **TV TUNER:** Antenna or cable TV input
- **EXT:** Scart input
- **COMPOSITE:** Composite video input
- **S-VIDEO:** S-video input
- **COMPONENT:** Component video input

INPUT SELECT

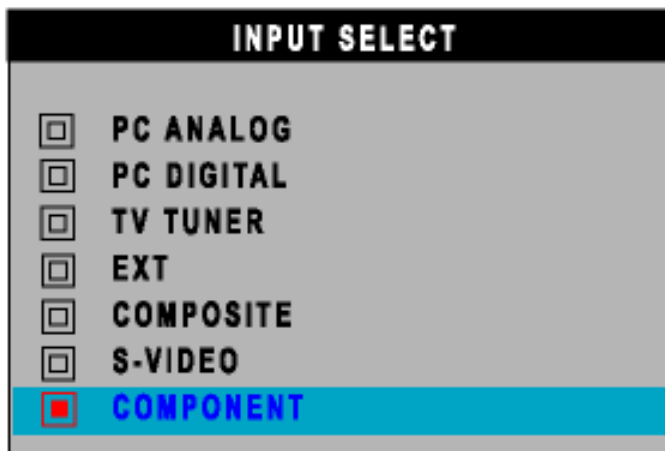

Adjust picture characteristics to suit personal preference.

EXIT: Exit from this menu

BRIGHTNESS: Adjustable from 0 to 100

CONTRAST: Adjustable from 0 to 100

COLOR: Adjustable from 0 to 100

SHARPNESS: Adjustable from 0 to 100

TINT: Not available in component input in all models.
Adjustable from 0 to 100

HORIZONTAL SHIFT: Adjustable from 0 to 100

PICTURE

COLOR TEMP: Select from Normal, Cool or Warm by "-" and "+" buttons.

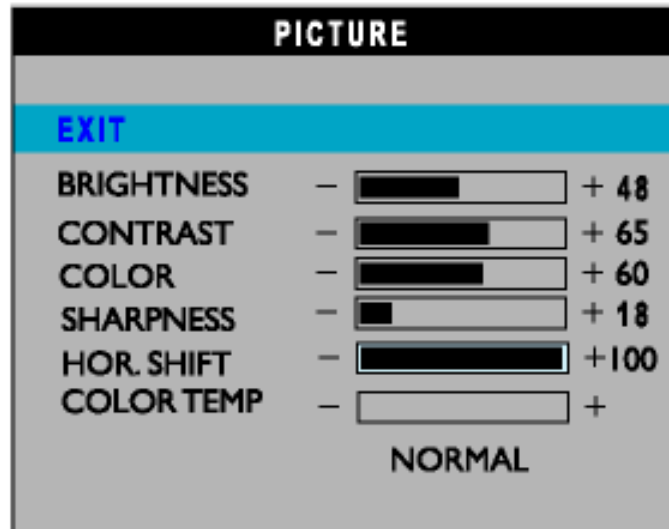
**NOTE:**

1. "TINT" is not available in component input in all models.
2. "TINT" is available in NAFTA model only.
3. "HOR SHIFT" only function in component input.

Adjust audio characteristics to suit personal preference.

EXIT: Exit from this menu.

TREBLE: Adjustable from 0 to 100

BASS: Adjustable from 0 to 100

BALANCE: Adjustable from 0 to 100

VOLUME: Adjustable from 0 to 100

SURROUND: Switch Surround Sound On/ Off

MUTE: Switch Mute On/ Off

AUDIO



Set language for OSD.

There are 6 languages of OSD display.

- ENGLISH
- ESPAÑOL
- FRANÇAIS
- DEUTSCH
- ITALIANO
- 中文

LANGUAGE



NOTE: In AP/China models, Simplified Chinese is supported.

Activate special control features:

EXIT: Exit from this menu.

SLEEP TIMER: Slide bar to select off/15/30/60/90/120/150/180.

OSD LOCK: Show key icon after selecting lock.

LIGHT SENSOR: Push the  buttons to toggle Light Sensor function.

VIDEO MODE: Set the screen scaling mode to suit personal preference:

- STANDARD MODE
- 4:3
- FULL SCREEN
- NONLINEAR SCALING

SPECIAL FEATURES

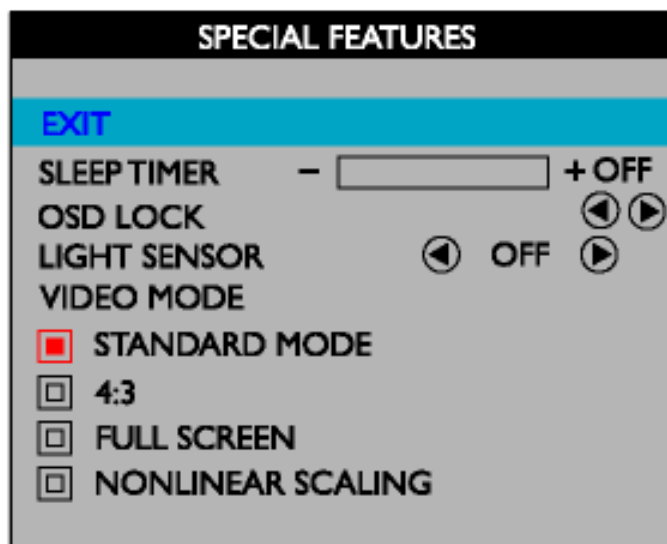

1) When users first enter the PARENTAL CONTROLS, the screen will show the window asking user key in the code.

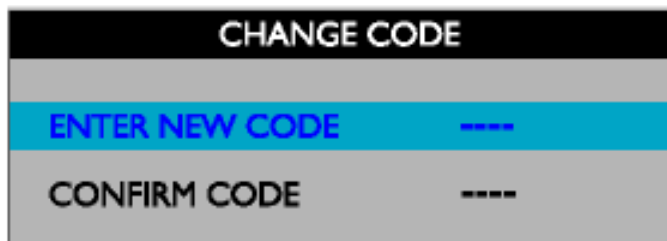

PARENTAL CONTROLS

2) Users will see the window "Access code" when they enter this function.

- EXIT
- LOCK
- CHANGE CODE
- CLEAR ALL

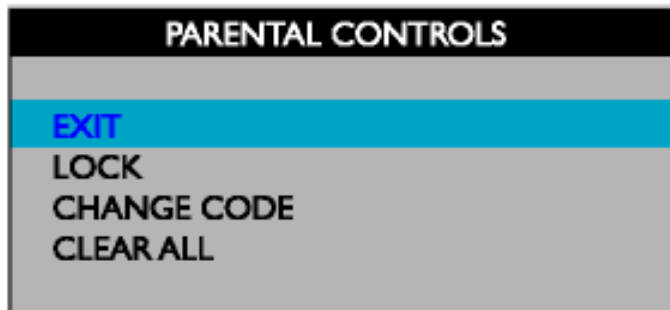

3) Enter Master code "0711" twice or the code entered in step 1.

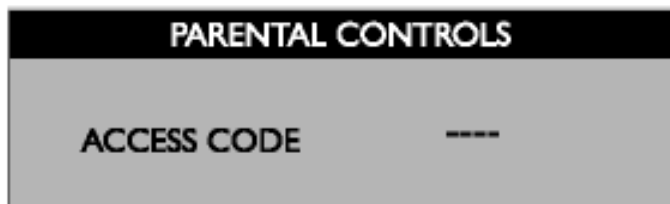
**FACTORY RESET**

Reset the setting to default values.

NO: Keep the setting as current.

YES: Load factory setting



TV Mode

Exit from this menu

EXIT

Select video source for main display:

- **PC ANALOG:** PC VGA input
- **PC DIGITAL:** PC DIGITAL input
- **TV TUNER:** Antenna or cable TV input
- **EXT:** Scart input
- **COMPOSITE:** Composite video input
- **S-VIDEO:** S-video input
- **COMPONENT:** Component video input

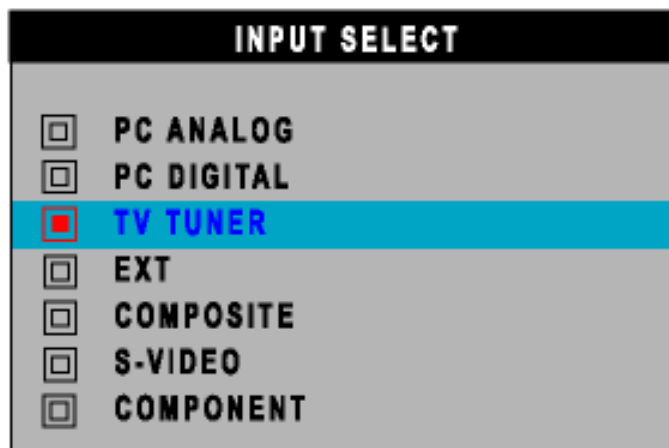
**INPUT
SELECT**

Adjust picture characteristics to suit personal preference.

EXIT: Exit from this menu

BRIGHTNESS: Adjustable from 0 to 100

CONTRAST: Adjustable from 0 to 100

COLOR: Adjustable from 0 to 100

SHARPNESS: Adjustable from 0 to 100

TINT: Not available in component input.

Adjustable from 0 to 100

COLOR TEMP: Select from Normal, Cool or Warm by "-" and "+" buttons.

PICTURE

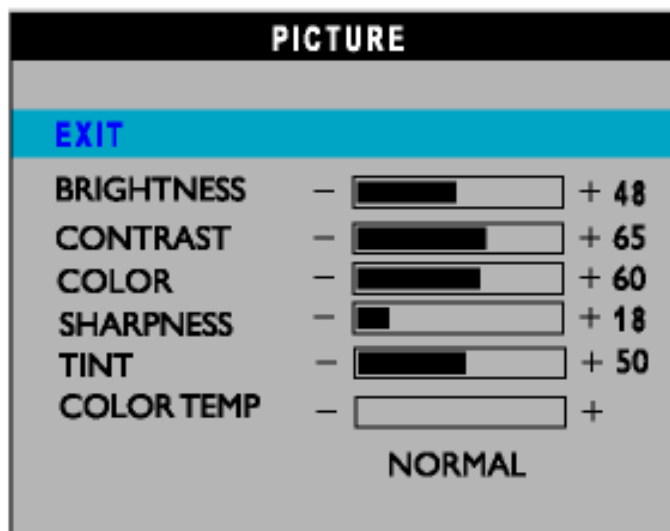

NOTE:

1. "TINT" is not available in component input in all models.
2. "TINT" is available in NAFTA model only.

AUDIO

Adjust audio characteristics to suit personal preference.

EXIT: Exit from this menu.

TREBLE: Adjustable from 0 to 100

BASS: Adjustable from 0 to 100

BALANCE: Adjustable from 0 to 100

VOLUME: Adjustable from 0 to 100

SURROUND: Switch Surround Sound On/ Off

MUTE: Switch Mute On/ Off

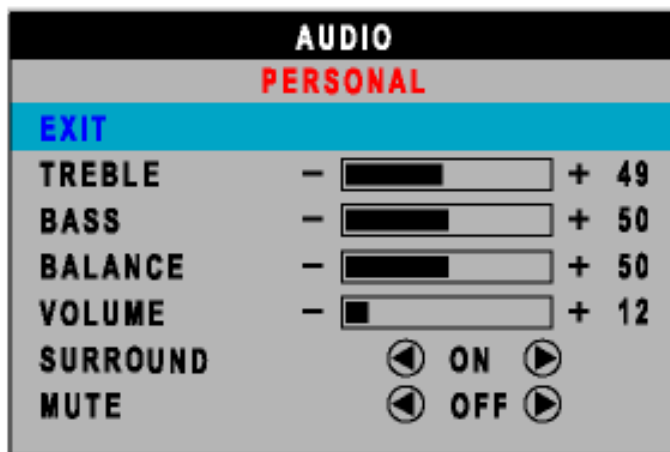
**LANGUAGE**

Set language for OSD.

There are 6 languages of OSD display.

- ENGLISH
- ESPAÑOL
- FRANÇAIS
- DEUTSCH
- ITALIANO
- 中文



Note: In AP/China models, Simplified Chinese is supported.

Activate special control features:

EXIT: Exit from this menu.

SLEEP TIMER: Slide bar to select off/15/30/60/90/120/150/180.

OSD LOCK: Show key icon after selecting lock.

LIGHT SENSOR: Push the  buttons to toggle Light Sensor function.

VIDEO MODE: Set the screen scaling mode to suit personal preference:

- STANDARD MODE
- 4:3
- FULL SCREEN
- NONLINEAR SCALING

SPECIAL FEATURES

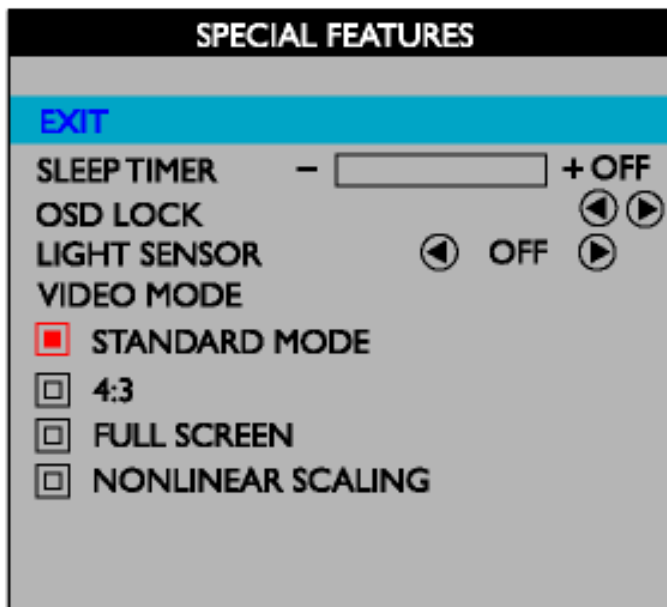

1) When users first enter the PARENTAL CONTROL, the screen will show the window asking user key in the code.

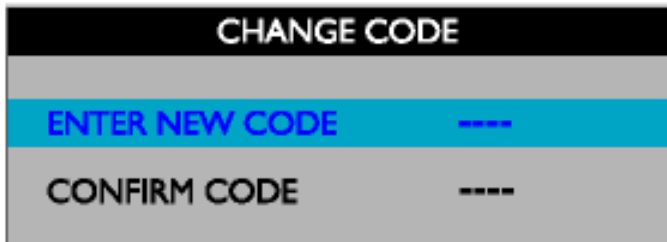

2) Users will see the window " Access code" when they enter this foundation.

- EXIT
- LOCK
- CHANGE CODE
- CLEAR ALL

PARENTAL CONTROLS

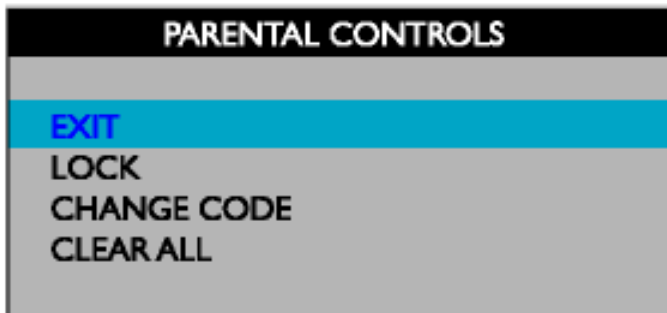

3) Enter Master code "0711" twice or the code entered in step 1.



SYSTEM:

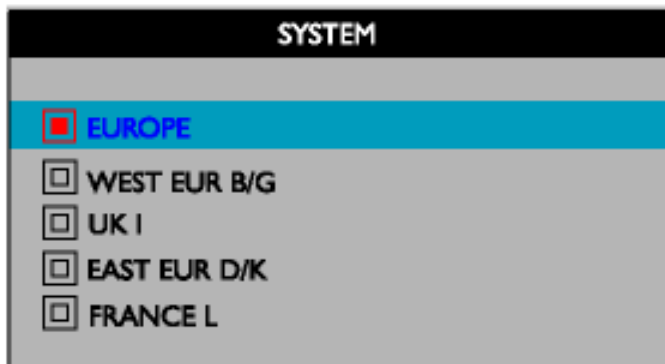

 **NOTE: The SYSTEM item is only available in Western Europe model.**

CHANNEL SEARCH:

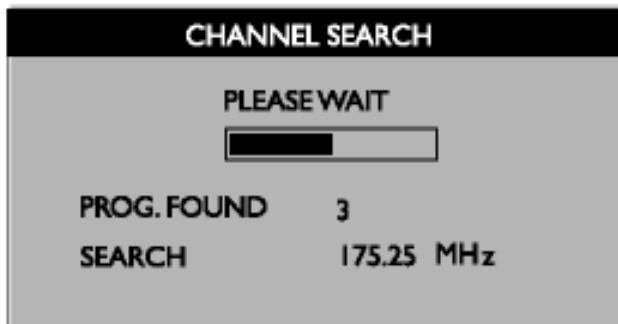

SETUP

MANUAL STORE:

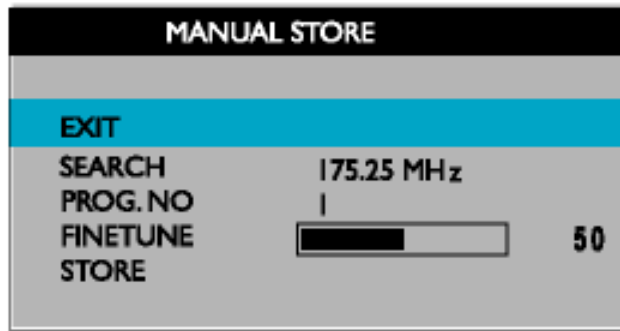

CHANNEL SKIP:



CHANNEL SWAP:

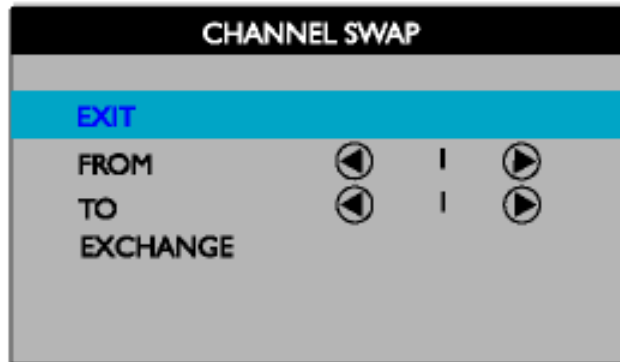

FACTORY RESET

Reset the setting to default values.

NO: Keep the setting as current.

YES: Load factory setting



[RETURN TO TOP OF THE PAGE](#)

Remote Control

On Screen Display • Using Your Remote Control

Using Your Remote Control

For Europe and most of Asia Pacific countries

For Europe and most of Asia Pacific countries

Remote Control Diagram

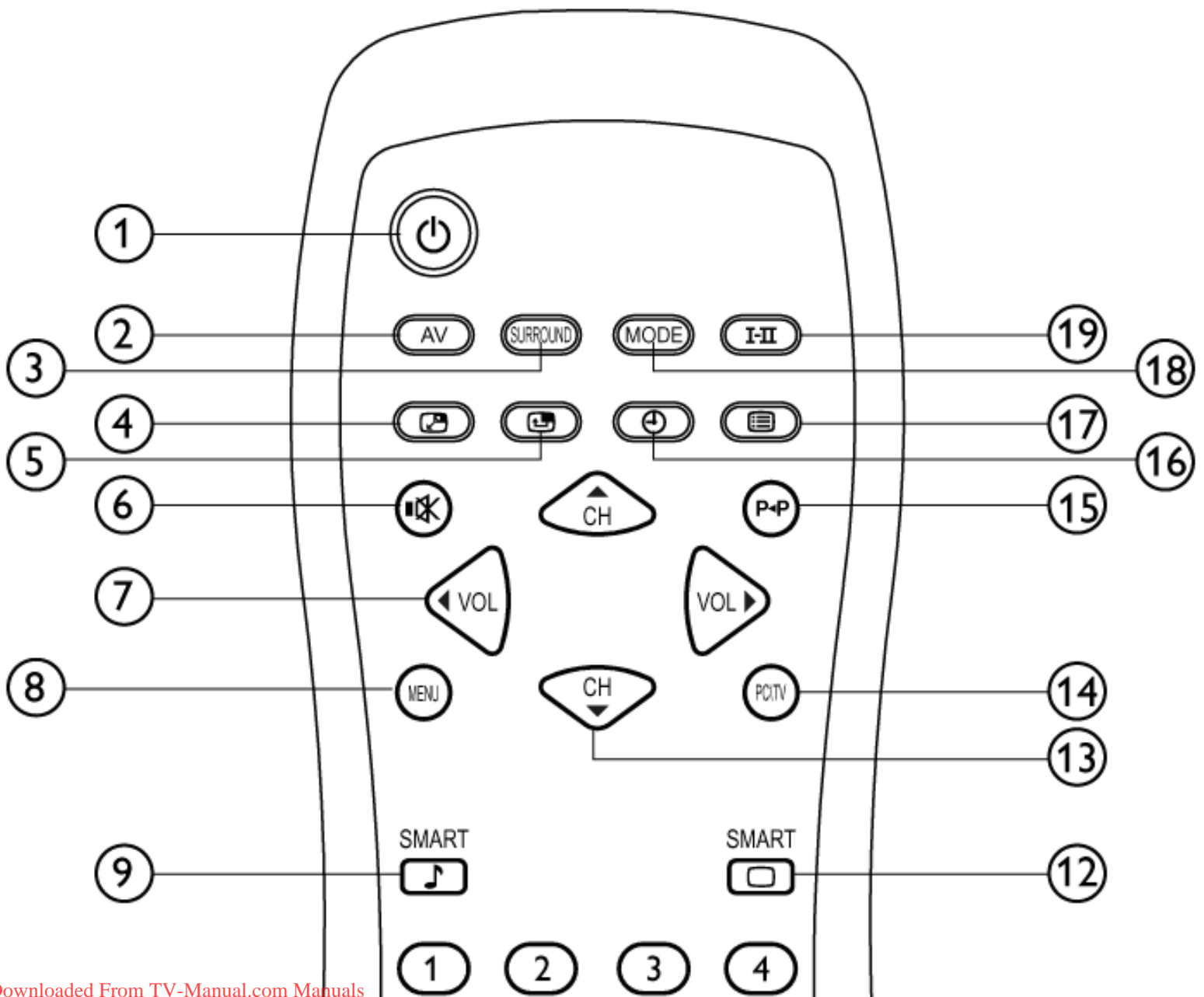

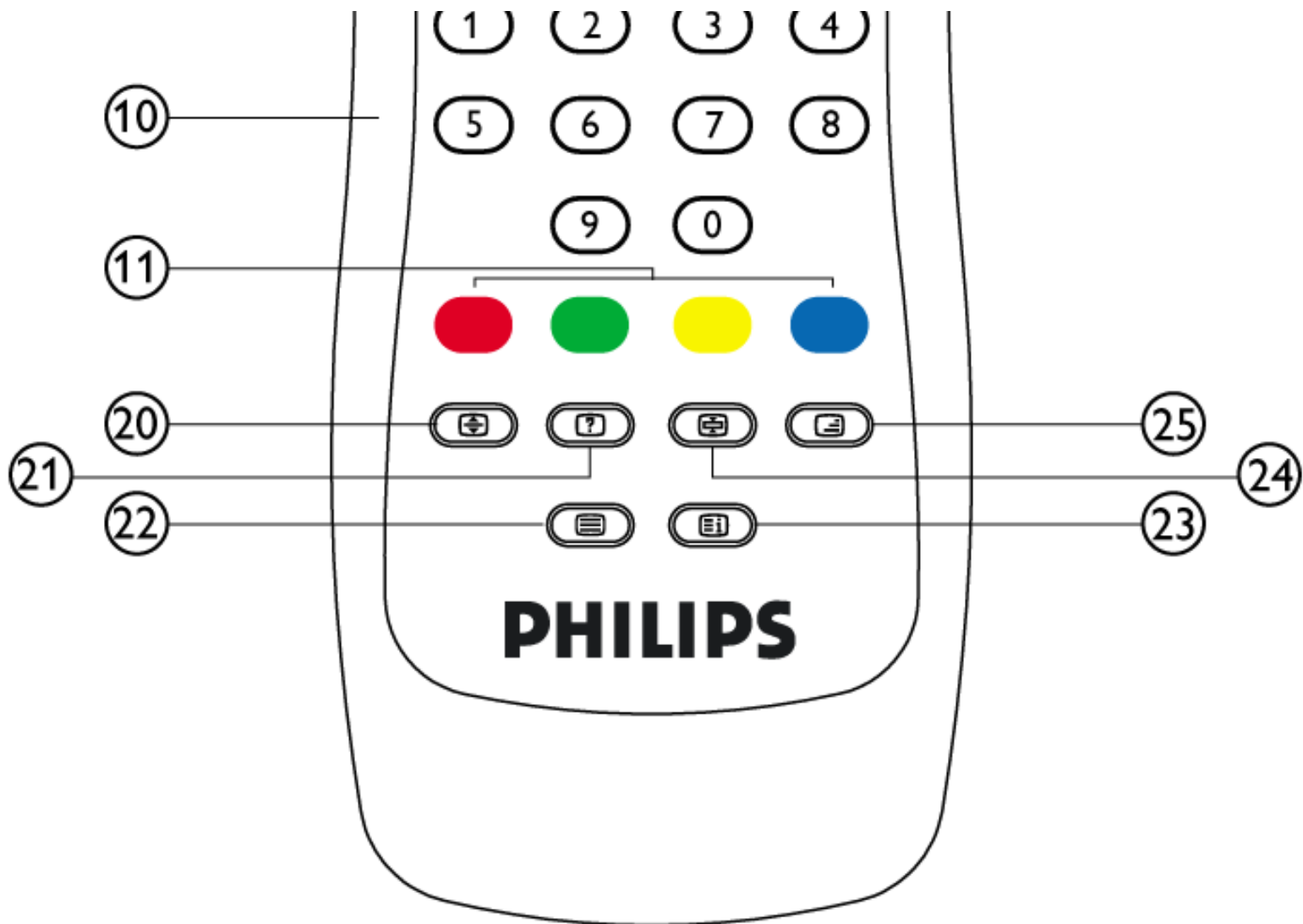

1	Standby	To set the TV temporarily to standby mode. To switch on the TV set, press Programme button (p -, +), any digit between 0 and 9 or AV source button (The amber light indicates when set is in standby mode)
2	AV source	<ul style="list-style-type: none"> • To select TV/Video sources in PIP mode and TV mode • If using TV 'STANDBY', press this button to return to 'ON'
3	Surround sound ON/OFF	Turn on/off virtual surround sound.
4	PIP On/Off, Size	To activate or close the 'Picture in Picture' function in PC mode and to enlarge or reduce the PIP window size using the same button.

5	PIP Shift	To change 'Picture in Picture' window position in PC mode
6	Mute	To disable sound. To restore sound, press button again.
7	Volume/Cursor control	1. Volume level up/down 2. cursor left/right (When in menu)
8	Menu	To turn on or off the OSD (On-Screen Display). To select function in OSD.
9	Smart sound controls	To access a series of settings: VOICE, MUSIC, THEATRE and PERSONAL
10	Numerical keys	<ul style="list-style-type: none"> • For direct access to programmes For a 2-digit programme number, the 2nd digit must be entered before the dash disappears. • If using TV 'STANDBY', press any of number keys to return to 'ON'
11	Teletext features	Works only in areas where the Teletext service is available
12	Smart picture controls	To select your desired picture setting from 5 settings: MOVIES, SPORTS, WEAK SIGNAL, MULTIMEDIA and PERSONAL.
13	TV programmes /Cursor control	1. To move up or down a programme. The number and the sound mode are displayed for a few seconds. 2. Cursor up/down, when in menu.
14	PC/TV mode selection	To select PC or TV mode.
15	Previous programme	To access the last programme viewed.
16	Sleep timer	To select the period of time after which the set will switch automatically to standby mode (up to 180 minutes)
17	OSD	To show OSD status.
18	Mode	Screen format 4:3, 16:9, non-linear, or automatic.

19	Sound mode	<ul style="list-style-type: none"> To switch from STEREO to MONO or to choose between Dual I and Dual II for bilingual transmissions. For TV sets fitted with NICAM reception, depending on the transmission, you can switch from NICAM STEREO to MONO or choose between NICAM DUAL I, NICAM DUAL II and MONO. If using Teletext, press this button to display dual pages on screen.
20	TXT Enlarge	Enlarge teletext context to two times larger.
21	TXT Reveal	Reveal or conceal hidden content in teletext.
22	TXT ON/OFF	Teletext ON or OFF.
23	TXT OSD/Index	Calling out teletext index page.
24	TXT Hold	Freeze teletext, no refresh.
25	TXT Mix	Teletext background become transparent, content mixes with images.

The Teletext related color buttons (#11) and the above six buttons (#20 ~ 25) are functionless in monitor, video models, and non PAL system TV.

[RETURN TO TOP OF THE PAGE](#)

Customer Care & Warranty

PLEASE SELECT YOUR COUNTRY/AREA TO REVIEW DETAILS OF YOUR WARRANTY COVERAGE

WESTERN EUROPE: Austria • Belgium • Cyprus • Denmark • France • Germany • Greece • Finland • Ireland • Italy • Luxembourg • the Netherlands • Norway • Portugal • Sweden • Switzerland • Spain • United Kingdom

EASTERN EUROPE: Czech Republic • Hungary • Poland • Russia • Slovakia • Slovenia • Turkey

LATIN AMERICA: Antilles • Argentina • Brasil • Chile • Colombia • Mexico • Paraguay • Peru • Uruguay • Venezuela

NORTH AMERICA: Canada • USA

PACIFIC: Australia • New Zealand

ASIA: Bangladesh • China • Hong Kong • India • Indonesia • Japan • Korea • Malaysia • Pakistan • Philippines • Singapore • Taiwan • Thailand

AFRICA: Morocco • South Africa

MIDDLE EAST: Dubai • Egypt

Download and Print

[Installing your LCD monitor driver](#) • [Download and Printing Instructions](#) • [Installing FPadjust Program](#)

Installing Your LCD monitor driver

System requirements:

- PC running Windows® 95, Windows® 98, Windows® 2000 , Windows® Me, Windows® XP or later
- Find your driver ".inf/.icm/.cat" at : /PC/drivers/

Read the "Driver_install02.txt" file before installing.

This page provides an option to read the manual in .pdf format. PDF files can be downloaded into your hard disk, then viewed and printed with Acrobat Reader or through your browser.

If you do not have Adobe® Acrobat Reader installed, click on the link to install the application.
[Adobe® Acrobat Reader for PC](#) / [Adobe® Acrobat Reader for Mac](#).

Download instructions:

To download the file:

1. Click-and-hold your mouse over the icon below. (Win95/98/2000/Me/XP users right-click)

Download



300WN5.pdf

2. From the menu that appears, choose 'Save Link As...', 'Save Target As...' or 'Download Link to Disk'.
3. Choose where you would like to save the file; click 'Save' (if prompted to save as either 'text' or 'source', choose 'source').

Printing instructions:

To print the manual:

1. With the manual file open, follow your printer's instructions and print the pages you need.

[RETURN TO TOP OF THE PAGE](#)

Installing FPadjust Program

The FP Adjust program generates alignment patterns which will help you adjust monitor settings such as CONTRAST, BRIGHTNESS, HORIZONTAL & VERTICAL POSITION, PHASE and CLOCK.

System requirements:

- PC running Windows® 95, Windows® 98, Windows® 2000, Windows® Me, Windows® XP or later

To install FPadjust Program:

- Click on the link or icon to install FPadjustment Program.
or
- Click-and-hold your mouse over the icon. (Win95/98/2000/Me/XP users right-click)

Download



FP_setup04.exe

- From the menu that appears, choose 'Save Link As...', 'Save Target As...' or 'Download Link to Disk'.
- Choose where you would like to save the file; click 'Save' (if prompted to save as either 'text' or 'source', choose 'source').
- Exit your browser and install the FPadjust Program.

Read the "FP_Readme04.txt" file before installing.

[RETURN TO TOP OF THE PAGE](#)

FAQs (Frequently Asked Questions)

[Safety and Troubleshooting](#) • [General FAQs](#) • [Screen Adjustments](#) • [Compatibility with Other Peripherals](#) • [LCD Panel Technology](#) • [Ergonomics, Ecology and Safety Standards](#) • [Troubleshooting](#) • [Regulatory Information](#) • [Other Related Information](#)

General FAQs

Q: When I install my monitor what should I do if the screen shows 'Cannot display this video mode'?

A: Recommended video mode is 1280x768 @60Hz.

1. Unplug all cables, then connect your PC to the monitor you used previously, which displayed correctly.
2. In the Windows Start Menu, select Settings/Control Panel. In the Control Panel Window, select the Display icon. Inside the Display Control Panel, select the 'Settings' tab. Under the settings tab, in a box labeled 'desktop area', move the slider to 1280x768 pixels.
3. Open 'Advanced Properties' and set the Refresh Rate to 60Hz, then click OK.
4. Restart your computer and repeat steps 2 and 3 to verify that your PC is set at 1280x768@60Hz.
5. Shut down your computer, disconnect your old monitor and reconnect your Philips LCD monitor.
6. Turn on your monitor and then turn on your PC.

Q: What are the .inf and .icm files on the set-up disk & CD-ROM? How do I install the drivers (.inf and lcm)?

A: These are the driver files for your monitor. Follow the instructions in your user manual to install the drivers. The computer may ask you for monitor drivers (.inf and lcm files) or a driver disk when you first install your monitor. Follow the instructions to insert the driver disk (either floppy or CD-ROM) included in this package. Monitor drivers (.inf and lcm files) will be installed automatically.

Q: How do I adjust the resolution?

A: Your video card/graphic driver and monitor together determine the available resolutions. You can select the desired resolution under the Control Panel of Windows® 95/98, Me, 2000 or XP, and with the 'Display properties/Settings'.

Q: What if I get lost while I am making monitor adjustments?

A: Simply press the MENU button, then select 'Factory Reset/All Settings' to recall all of the original factory settings.

Q: My Monitor has no power (Power LED does not light up). What should I do?

A: Make sure the power cord is connected to the Monitor. Also, be sure the AC power switch at the rear of the monitor is at 'ON' position.

Q: Will the product accept an Interlace signal?

A: No. If an Interlace signal is used, the screen displays both odd and even horizontal scanning lines at the same time, thus distorting the picture.

Q: What does the Refresh Rate mean for LCD?

A: Unlike CRT display technology, in which the speed at which the electron beam is swept from the top to the bottom of the screen determines flicker, an active matrix display uses an active element (TFT) to control each individual pixel and the refresh rate is therefore not really applicable to LCD technology.

Q: Will the LCD screen be resistant to scratches?

A: A protective coating is applied to the surface of the LCD, which is durable to a certain extent (up to 3H in this Philips 30" LCD monitor). In general, it is recommended that the panel surface is not subjected to any excessive shocks or scratches. An optional protective cover with greater scratch resistance is also available.

Q: How should I clean the LCD surface?

A: For normal cleaning, use a clean, soft cloth. For extensive cleaning, please use isopropyl alcohol. Do not use other solvents such as ethyl alcohol, ethanol, acetone, hexane, etc.

Q: Can the Philips LCD Monitor be mounted on the wall or used as a touch panel?

A: Yes, Philips LCD monitors have this optional feature. The standard VESA mount holes on the back cover allow the user to mount the Philips monitor on any VESA standard ARM or accessories. Touch panels are being developed for future applications. Check with your Philips sales representative for more information.

[RETURN TO TOP OF THE PAGE](#)

Screen Adjustments

Q: What is the FPadjust program on the setup disk and CD-ROM?

A: The FPadjust program generates alignment patterns that help you adjust monitor settings such as Contrast, Brightness, Horizontal Position, Vertical Position, Phase and Clock for optimal performance.

Q: When I install my monitor, how do I get the best performance from the monitor?

A:

1. For best performance, make sure your display settings are set at 1280x768@60Hz. Note: You can check the current display settings by pressing the OSD OK button once. The current display mode is shown in the product information in the OSD main controls.
 2. To install the Flat Panel Adjust (FPadjust) program located on the monitor setup CD-ROM, open the CD-ROM and double click the FP_setup04.exe icon. This will install FP Adjust automatically and place a shortcut on your desktop.
 3. Run FPadjust by double clicking the shortcut. Follow the instructions step by step to optimise image performance with your system's video controller.
-

Q: How do LCDs compare with CRTs in terms of radiation?

A: Unlike CRT, the LCDs do not use an electron gun, so they do not generate the same amount of radiation at the screen surface.

[RETURN TO TOP OF THE PAGE](#)

Compatibility with other Peripherals

Q: Can I connect my LCD monitor to any PC, workstation or Mac?

A: Yes, all Philips LCD monitors are fully compatible with standard PCs, Macs and workstations. You may need a cable adapter to connect the monitor to your Mac system. Please contact your dealer/retailer for more information.

Q: Are Philips LCD monitors Plug-and-Play?

A: Yes, the monitors are Plug-and-Play compatible with Windows® 95, 98, 2000, XP

platforms.

Q: What is a TV System?

A: Television pictures are not broadcast in the same way in all countries. There are different standards: BG, DK, I and L L'. The SYSTEM setting is used to select these different standards. This is not to be confused with PAL or SECAM colour coding. PAL is used in the majority of European countries, Secam in France, the CIS and the majority of African countries.

The United States and Japan use a different system called NTSC.

Q: What is SCART?

A: The SCART is a 20-pin rectangular connector fitted to the vast majority of PAL market TV receivers. It provides composite video inputs and outputs, stereo audio in and out, and RGB input. It is also known as Euro connector and PERI-tel.

Q: What are S-VIDEO Signals?

A: These are 2 separate Y/C video signals from the S-VIDEO and Hi-8 recording standards. The luminance signals Y (black and white) and chrominance signals C (colour) are recorded separately on the tape. This provides a better picture quality than is achieved with standard video (VHS and 8 mm) where the Y/C signals are combined to provide only one video signal.

[RETURN TO TOP OF THE PAGE](#)

LCD Panel Technology

Q: What is a Liquid Crystal Display?

A: A Liquid Crystal Display (LCD) is an optical device that is commonly used to display ASCII characters and images on digital items such as watches, calculators, portable game consoles, etc. LCD is the technology used for displays in notebooks and other small computers. Like light-emitting diode and gas-plasma technologies, LCD allows displays to be much thinner than cathode ray tube (CRT) technology. LCD consumes much less power than LED and gas-display displays because it works on the principle of blocking light rather than emitting it.

Q: How are LCDs made?

A: LCDs are created from two glass plates separated from each other at a distance of a few microns. The plates are filled with liquid crystal and then sealed together. The top plate is coloured with an RGB pattern to make the colour filter. Polarizers are then glued to both plates. This combination is sometimes called 'glass' or 'cell.' The LCD cell is assembled into a 'module' by adding the backlight, driver electronics and frame.

Q: What is polarization ?

A: Polarization is basically directing light to shine in one direction. Light is electromagnetic waves. Electric and magnetic fields oscillate in a direction perpendicular to the propagation of the light beam. The direction of these fields is called the 'polarization direction'. Normal or non-polarized light has fields in several directions; polarized light has a field in only one direction.

Q: What differentiates passive matrix LCDs from active matrix LCDs?

A: An LCD is made with either a passive matrix or an active matrix display grid. An active matrix has a transistor located at each pixel intersection, requiring less current to control the luminance of a pixel. For this reason, the current in an active matrix display can be switched on and off more frequently, improving the screen refresh time (your mouse pointer will appear to move more smoothly across the screen, for example). The passive matrix LCD has a grid of conductors with pixels located at each intersection in the grid.

Q: How does a TFT LCD Panel work?

A: On each column and row of the TFT LCD panel a data source drive and a gate drive and attached, respectively. The TFT drain of each cell is connected to the electrode. The molecular arrangement of liquid crystal elements differs according to whether it is impressed with voltage or not. It varies the direction of polarized light and the amount of light by letting it through different arrays of liquid crystal elements. When two polarized filters are arranged vertically on a polarized light pole, the light that passes through the upper polarized panel is turned 90 degrees along with the spiral structure of the liquid crystal molecules and goes through the polarized filter at the bottom. When impressed with voltage, liquid crystal molecules are arranged vertically from the original spiral structure and the direction of the light is not turned through 90 degrees. In this case, light that comes through the top polarized panel may not go through the polarized panel at the bottom.

Q: What are the advantages of TFT LCD compared with CRT?

A: In a CRT monitor, a gun shoots electrons and general light by colliding polarized electrons on fluorescent glass. Therefore, CRT monitors basically operate with an analog RGB signal. A TFT LCD monitor is a device that displays an input image by operating a liquid crystal panel. The TFT has a fundamentally different structure than a CRT: Each cell has an active matrix structure and independent active elements. A TFT LCD has two glass panels and the space between them is filled in with liquid crystal. When each cell is connected with electrodes and impressed with voltage, the molecular structure of the liquid crystal is altered and controls the amount of inlet lighting to display images. A TFT LCD has several advantages over a CRT, since it can be very thin and no flickering occurs because it does not use the scanning method.

Q: Why is a vertical frequency of 60Hz optimal for an LCD monitor?

A: Unlike a CRT monitor, the TFT LCD panel has a fixed resolution. For example, an XGA monitor has 1024x3 (R, G, B) x 768 pixels and a higher resolution may not be available without additional software processing. The panel is designed to optimise the display for a 65MHz dot clock, one of the standards for XGA displays. Since the vertical/horizontal frequency for this dot clock is 60Hz/48kHz, the optimum frequency for this monitor is 60Hz.

Q: What kind of wide-angle technology is available? How does it work?

A: The TFT LCD panel is an element that controls/displays the inlet of a backlight using the dual-refraction of a liquid crystal. Using the property that the projection of inlet light refracts toward the major axis of the liquid element, it controls the direction of inlet light and

displays it. Since the refraction ratio of inlet light on liquid crystal varies with the inlet angle of the light, the viewing angle of a TFT is much narrower than that of a CDT. Usually, the viewing angle refers to the point where the contrast ratio is 10. Many ways to widen the viewing angle are currently being developed and the most common approach is to use a wide viewing angle film, which widens the viewing angle by varying the refraction ratio. IPS (In Plane Switching) or MVA (Multi Vertical Aligned) is also used to give a wider viewing angle.

Q: Why is there no flicker on an LCD Monitor?

A: Technically speaking, LCDs do flicker, but the cause of the phenomenon is different from that of CRT monitor -- and it has no impact of the ease of viewing. Flickering in an LCD monitor relates to usually undetectable luminance caused by the difference between positive and negative voltage. On the other hand, CRT flickering that can irritate the human eye occurs when the on/off action of the fluorescent object becomes visible. Since the reaction speed of liquid crystal in an LCD panel is much slower, this troublesome form of flickering is not present in an LCD display.

Q: Why is an LCD monitor virtually free of Electro Magnetic Interference?

A: Unlike a CRT, an LCD monitor does not have key parts that generate Electro Magnetic Interference, especially magnetic fields. Also, since an LCD display utilizes relatively low power, its power supply is extremely quiet.

[RETURN TO TOP OF THE PAGE](#)

[Ergonomics, Ecology and Safety Standards](#)

Q: What is the CE mark?

A: The CE (Conformité Européenne) mark is required to be displayed on all regulated products offered for sale on the European market. This 'CE' mark means that a product complies with the relevant European Directive. A European Directive is a European 'Law' that relates to health, safety, environment and consumer protection, much the same as the U. S. National Electrical Code and UL Standards.

Q: Does the product conform to general safety standards?

A: Yes. Philips LCD monitors conform to the guidelines of MPR-II standards for the control of radiation, electromagnetic waves, energy reduction, electrical safety in the work environment and recyclability. The specification page provides detailed data on safety standards.

More information is provided in the [Regulatory Information](#) section.

[RETURN TO TOP OF THE PAGE](#)



Troubleshooting

[Safety and Troubleshooting](#) •
 [FAQs](#) •
 [Common Problems](#) •
 [TV and Audio Problems](#) •
 [Video Problems](#) •
 [Remote Control Problems](#) •
 [Product Specific Problems](#) •
 [OSD Warning Message](#) •
 [Self-Test Feature Check \(STFC\)](#) •
 [Regulatory Information](#) •
 [Other Related Information](#)

This page deals with problems that can be corrected by the user. If the problem still persists after you have tried these solutions, contact your nearest Philips dealer.

Common Problems

Symptoms	Having this problem?	Check these items
No Video/ Power LED off	No picture, the LCD Monitor TV is dead	<ul style="list-style-type: none"> • Check connection integrity at both ends of the video cable and/or power cord. • Electric outlet verification • Ensure AC power at the rear of the monitor TV is switched on.
No Video/ Power LED on	No picture or no brightness	<ul style="list-style-type: none"> • Increase brightness and contrast controls. • Perform the LCD Monitor TV self-test feature check. • Check for bent or broken pins in video cable connector.
Poor Focus	Picture is fuzzy, blurry or ghosting	<ul style="list-style-type: none"> • Auto adjust image through Menu -> Image Setting -> Auto Adjust. • Adjust Phase and Clock controls via OSD. • Eliminate video extension cables. • Perform the LCD Monitor TV factory reset (via Menu -> Factory Reset -> All Settings). • Lower video resolution or increase font size.

<p>Shaky/Jittery Video</p>	<p>Wavy picture or fine movement</p>	<ul style="list-style-type: none"> • Auto adjust image through Menu -> Image Setting -> Auto Adjust • Adjust Phase and Clock controls via OSD • Perform the LCD Monitor TV factory reset (via Menu -> Factory Reset -> All Settings) • Check environmental factors • Relocate and test in other room
<p>Missing Pixels</p>	<p>LCD screen has spots</p>	<ul style="list-style-type: none"> • Cycle power on-off • These are pixels that are permanently off and is a natural defect that occurs in LCD technology
<p>Stuck-on Pixels</p>	<p>LCD screen has bright spots</p>	<ul style="list-style-type: none"> • Cycle power on-off • These are pixels that are permanently on and is a natural defect that occurs in LCD technology
<p>Brightness Problems</p>	<p>Picture too dim or too bright</p>	<ul style="list-style-type: none"> • Perform the LCD Monitor TV factory reset (via Menu -> Factory Reset -> All Settings) • Auto adjust image through Menu -> Image Setting -> Auto Adjust • Adjust brightness & contrast controls <p> Note: When operating in DVI mode, the contrast adjustment is not available.</p>
<p>Geometric Distortion</p>	<p>Screen not centered correctly</p>	<ul style="list-style-type: none"> • Perform the LCD Monitor TV reset on "Position Settings Only" • Auto adjust image through Menu -> Image Setting -> Auto Adjust • Adjust the centering controls • Ensure the LCD Monitor TV is in proper video mode <p> Note: When operating in DVI mode, the positioning adjustments are not available.</p>

<p>Horizontal/Vertical Lines</p>	<p>Screen has one or more lines</p>	<ul style="list-style-type: none"> ● Perform the LCD Monitor TV reset ● Auto adjust image through Menu -> Image Setting -> Auto Adjust ● Adjust Phase and Clock controls via OSD ● Perform the LCD Monitor TV self-test feature check and determine if these lines are also in self-test mode ● Check for bent or broken pins in the video cable connector <div style="text-align: right;">  <p>Note: When operating in DVI mode, the Pixel Clock and Phase adjustments are not available.</p> </div>
<p>Sync Problems</p>	<p>Screen is scrambled or appears torn</p>	<ul style="list-style-type: none"> ● Perform the LCD Monitor TV reset ● Push Auto Adjust button ● Adjust Phase and Clock controls via OSD ● Perform the LCD Monitor TV self-test feature check to determine if scrambled screen appears in self-test mode ● Check for bent or broken pins ● Boot up in the "safe mode"
<p>LCD Scratched</p>	<p>Screen has scratches or smudges</p>	<ul style="list-style-type: none"> ● Turn the LCD Monitor TV off and clean the screen
<p>Safety Related Issues</p>	<p>Visible signs of smoke or sparks</p>	<ul style="list-style-type: none"> ● Do not perform any troubleshooting steps ● The LCD Monitor TV needs to be replaced
<p>Intermittent Problems</p>	<p>The LCD Monitor TV malfunctions on & off</p>	<ul style="list-style-type: none"> ● Ensure the LCD Monitor TV is in proper video mode ● Ensure video cable connection between computer and the LCD monitor TV is secured ● Perform the LCD Monitor TV factory reset (via Menu -> Factory Reset -> All Settings) ● Perform the LCD Monitor TV self-test feature check to determine if the intermittent problem occurs in self-test mode

TV and Audio Problems

<p>Poor TV signal reception</p>	<p>Abnormal picture seen from the screen</p>	<ul style="list-style-type: none"> • The proximity of mountains or high buildings may be responsible for ghost pictures, echoing or shadows. In this case, try manually adjusting your pictures: see 'fine tuning' or adjust the direction of the outside aerial. For Asia users in non-NTSC area: Does your antenna enable you to receive broadcasts in this frequency range (UHF or VHF band)? In the event of difficult reception (snowy pictures) switch the NR on the PICTURE menu to ON.
<p>No TV picture</p>	<p>No picture when TV input was selected</p>	<ul style="list-style-type: none"> • Have you connected the aerial socket properly? Have you chosen the right system? Poorly connected SCART cables or aerial sockets are often the cause of picture or sound problems (sometimes the connectors can become half disconnected if the LCD Monitor TV set is moved or turned). Check all connections.
<p>No sound</p>	<p>No sound output when a program with sound was playing</p>	<ul style="list-style-type: none"> • Ensure that the audio cables are firmly connected to both the audio input connectors on your the LCD Monitor TV and audio output connectors on your PC or Video player. • If on certain TV channels you receive a picture but no sound, this means that you do not have the correct TV system. Modify the SYSTEM setting.

Video Problems

<p>No Video</p>	<p>No signal indicator is displayed.</p>	<ul style="list-style-type: none"> ● Check Video Input Selection <ul style="list-style-type: none"> ○ Composite: Yellow colored RCA jack ○ S-Video: Typically a round 4 pin jack ○ Component: Typically 3 RCA jacks of Green, Red and Blue. ● Make sure you did not plug the video cable to video output port behind the LCD monitor TV.
<p>Low Quality DVD playback</p>	<p>Picture not crisp and some color distortion</p>	<ul style="list-style-type: none"> ● Check DVD connection <ul style="list-style-type: none"> ○ Composite gives good picture ○ S-Video gives better picture ○ Component gives best picture
<p>No sound</p>	<p>See video but no audio</p>	<ul style="list-style-type: none"> ● Check if the LCD Monitor TV volume is turn off of muted. ● Connect the audio cable securely. ● Audio cable is connected incorrectly. ● Verify that the audio source is selected correctly in the OSD.

Remote Control Problems

<p>Remote control does not work properly</p>	<p>No response from the LCD Monitor TV when remote is pressed</p>	<ul style="list-style-type: none"> ● Point the remote control directly at the remote sensor on the LCD Monitor TV. ● Replace both batteries with new ones. ● Make sure the remote control is not disabled (for disable/enable the remote control, please refer to the section of Remote Control).
--	---	--

Product Specific Problems

<p>Screen image is too small</p>	<p>Image is centered on screen, but does not fill entire viewing area</p>	<ul style="list-style-type: none"> ● Perform the LCD Monitor TV factory reset (via Menu -> Factory Reset -> All Settings).
----------------------------------	---	---

Cannot adjust the LCD Monitor TV with the buttons at the side of the unit

OSD does not appear on the screen

- Turn the LCD Monitor TV off and unplug the power cord and then plug back and power on.

For further assistance, refer to the [Consumer Information Centers](#) list and contact your local Philips distributor.

[RETURN TO TOP OF THE PAGE](#)

OSD Warning Messages

A warning message may appear on the screen indicating the LCD Monitor TV current status.

ATTENTION

**AUTO ADJUSTMENT IN
PROGRESS**



When user sees this warning message, it means that the LCD Monitor TV is in adjustment process.

ATTENTION

**CANNOT DISPLAY THIS VIDEO
MODE, CHANGE COMPUTE DISPLAY
INPUT TO 1280X768@60Hz**

A warning message may appear on the screen indicating that the LCD Monitor TV is out of sync range.

See Specifications for the Horizontal and Vertical frequency ranges addressable by this the LCD Monitor TV. Recommended mode is 1280x 768 @ 60Hz.

<div style="background-color: red; color: white; text-align: center; padding: 5px;">ATTENTION</div> <div style="text-align: center; padding: 20px;">NO VIDEO INPUT SIGNAL</div>	<p>This message means that there is no video input signal.</p>
<div style="background-color: red; color: white; text-align: center; padding: 5px;">ATTENTION</div> <div style="text-align: center; padding: 20px;">IN POWER SAVING MODE PRESS ANY KEY ON KEYBOARD OR MOVE MOUSE</div>	<p>The LCD Monitor TV is in a power saving mode (in PC mode).</p>
	<p>The main OSD menu is unlocked.</p>
	<p>The main OSD menu is locked.</p>

[RETURN TO TOP OF THE PAGE](#)

Self-Test Feature Check (STFC)

Your the LCD Monitor TV when used as a computer display through DVI and/or VGA connection provides a self-test feature that allows you to check whether your the LCD Monitor TV is functioning properly. If your the LCD Monitor TV and computer are properly connected but the LCD Monitor TV screen remains dark, run the LCD Monitor TV self-test by performing the following steps:

1. Turn off both your computer and the LCD Monitor TV.
2. Unplug the video cable from the back of the computer. To ensure proper Self-Test operation, remove both Digital(white connector) and the Analog(blue connector) cables from the back of computer.
3. Turn on the LCD Monitor TV.

The floating 'Philips - self-test Feature Check' dialog box should appear on-screen (against a black background) if the LCD Monitor TV cannot sense a video signal and is working correctly. While in self-test mode, the power LED remains green and the self-test pattern will scroll through the screen continually.

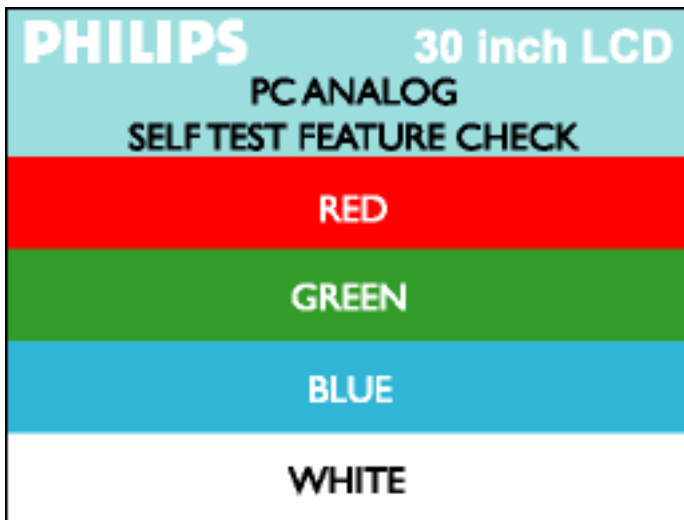

This box also appears during normal system operation if the video cable becomes disconnected or damaged.

4. Turn off your the LCD Monitor TV and reconnect the video cable; then turn on both your computer and the LCD Monitor TV. If your the LCD Monitor TV screen remains blank after you use the previous procedure, check your video controller and computer system; your LCD Monitor TV is functioning properly.

[RETURN TO TOP OF THE PAGE](#)

Regulatory Information

[CE Declaration of Conformity](#) • [Energy Star Declaration](#) • [Federal Communications Commission \(FCC\) Notice \(U.S. Only\)](#) • [Commission Federale de la Communication \(FCC Declaration\)](#) • [EN 55022 Compliance \(Czech Republic Only\)](#) • [VCCI Class 2 Notice \(Japan Only\)](#) • [MIC Notice \(South Korea Only\)](#) • [Polish Center for Testing and Certification Notice](#) • [North Europe \(Nordic Countries\) Information](#) • [BSMI Notice \(Taiwan Only\)](#) • [Ergonomie Hinweis \(nur Deutschland\)](#) • [Philips End-of-Life Disposal](#) • [Information for UK only](#)

[Safety and Troubleshooting](#) • [Troubleshooting](#) • [Other Related Information](#) • [Frequently Asked Questions \(FAQs\)](#)

CE Declaration of Conformity

Philips Consumer Electronics declare under our responsibility that the product is in conformity with the following standards

- EN60950:2000 (Safety requirement of Information Technology Equipment)
 - EN55022:1998 (Radio Disturbance requirement of Information Technology Equipment)
 - EN55024:1998 (Immunity requirement of Information Technology Equipment)
 - EN61000-3-2:2000 (Limits for Harmonic Current Emission)
 - EN61000-3-3:1995 (Limitation of Voltage Fluctuation and Flicker)
 - EN55013:1990+A12+A13+A14 (Radio Disturbance requirement of Sound and Television Receivers and associated)
 - EN55020:1994+A12 (Immunity requirement of Sound and Television Receivers and associated)
 - IEC Guide 112:2000 (Guide on the Safety of Multimedia Equipment) following provisions of directives applicable
 - 73/23/EEC (Low Voltage Directive)
 - 89/336/EEC (EMC Directive)
 - 93/68/EEC (Amendment of EMC and Low Voltage Directive)
- and is produced by a manufacturing organization on ISO9000 level.

The product also comply with the following standards

- ISO9241-3, ISO9241-7, ISO9241-8 (Ergonomic requirement for Visual Display)
- ISO13406-2 (Ergonomic requirement for Flat panels)
- GS EK1-2000 (GS specification)
- prEN50279:1998 (Low Frequency Electric and Magnetic fields for Visual Display)
- MPR-II (MPR:1990:8/1990:10 Low Frequency Electric and Magnetic fields)

- TCO99, TCO03 (Requirement for Environment Labelling of Ergonomics, Energy, Ecology and Emission, TCO: Swedish Confederation of Professional Employees) for TCO versions

[RETURN TO TOP OF THE PAGE](#)

Energy Star Declaration

PHILIPS 300WN5

This monitor is equipped with a function for saving energy which supports the VESA Display Power Management Signaling (DPMS) standard. This means that the monitor must be connected to a computer which supports VESA DPMS to fulfill the requirements in the NUTEK specification 803299/94. Time settings are adjusted from the system unit by software.

NUTEK	VESA State	LED Indicator	Power Consumption
Normal operation	ON	Blue	130 W (typical)
Power Saving Alternative 2 One step	OFF(Sleep)	Amber	< 5 W
	Switch OFF	OFF	< 2 W



As an ENERGY STAR® Partner, PHILIPS has determined that this product meets the ENERGY STAR® guidelines for energy efficiency.



We recommend you switch off the monitor when it is not in use for quite a long time.

[RETURN TO TOP OF THE PAGE](#)

Federal Communications Commission (FCC) Notice (U.S. Only)



This equipment has been tested and found to comply with the limits for a Class B digital device, pursuant to Part 15 of the FCC Rules. These limits are designed to provide reasonable protection against harmful interference in a residential installation. This equipment generates, uses and can radiate radio frequency energy and, if not installed and used in accordance with the instructions, may cause harmful interference to radio communications. However, there is no guarantee that interference will not occur in a particular installation. If this equipment does cause harmful interference to radio or television reception, which can be determined by turning the equipment off and on, the user is encouraged to try to correct the interference by one or more of the following measures:

- Reorient or relocate the receiving antenna.
- Increase the separation between the equipment and receiver.
- Connect the equipment into an outlet on a circuit different from that to which the receiver is connected.
- Consult the dealer or an experienced radio/TV technician for help.



Changes or modifications not expressly approved by the party responsible for compliance could void the user's authority to operate the equipment.

Use only RF shielded cable that was supplied with the monitor when connecting this monitor to a computer device.

To prevent damage which may result in fire or shock hazard, do not expose this appliance to rain or excessive moisture.

THIS CLASS B DIGITAL APPARATUS MEETS ALL REQUIREMENTS OF THE CANADIAN INTERFERENCE-CAUSING EQUIPMENT REGULATIONS.

[RETURN TO TOP OF THE PAGE](#)

Commission Federale de la Communication (FCC Declaration)

[Downloaded From TV-Manual.com Manuals](#)



Cet équipement a été testé et déclaré conforme aux limites des appareils numériques de class B, aux termes de l'article 15 Des règles de la FCC. Ces limites sont conçues de façon à fournir une protection raisonnable contre les interférences nuisibles dans le cadre d'une installation résidentielle. CET appareil produit, utilise et peut émettre des hyperfréquences qui, si l'appareil n'est pas installé et utilisé selon les consignes données, peuvent causer des interférences nuisibles aux communications radio. Cependant, rien ne peut garantir l'absence d'interférences dans le cadre d'une installation particulière. Si cet appareil est la cause d'interférences nuisibles pour la réception des signaux de radio ou de télévision, ce qui peut être décelé en fermant l'équipement, puis en le remettant en fonction, l'utilisateur pourrait essayer de corriger la situation en prenant les mesures suivantes:

- Réorienter ou déplacer l'antenne de réception.
- Augmenter la distance entre l'équipement et le récepteur.
- Brancher l'équipement sur un autre circuit que celui utilisé par le récepteur.
- Demander l'aide du marchand ou d'un technicien chevronné en radio/télévision.



Toutes modifications n'ayant pas reçu l'approbation des services compétents en matière de conformité est susceptible d'interdire à l'utilisateur l'usage du présent équipement.

N'utiliser que des câbles RF armés pour les connections avec des ordinateurs ou périphériques.

CET APPAREIL NUMERIQUE DE LA CLASSE B RESPECTE TOUTES LES EXIGENCES DU REGLEMENT SUR LE MATERIEL BROUILLEUR DU CANADA.

[RETURN TO TOP OF THE PAGE](#)

EN 55022 Compliance (Czech Republic Only)

This device belongs to category B devices as described in EN 55022, unless it is specifically stated that it is a Class A device on the specification label. The following applies to devices in Class A of EN 55022 (radius of protection up to 30 meters). The user of the device is obliged to take all steps necessary to remove sources of interference to telecommunication or other devices.

Pokud není na typovém štítku počítače uvedeno, že spadá do třídy A podle EN 55022, spadá automaticky do třídy B podle EN 55022. Pro zařízení zařazená do třídy A (chranné pásmo 30m) podle EN 55022 platí následující. Dojde-li k rušení telekomunikačních nebo jiných zařízení je uživatel povinen provést taková opatření, aby rušení odstranil.

[RETURN TO TOP OF THE PAGE](#)

VCCI Notice (Japan Only)

This is a Class B product based on the standard of the Voluntary Control Council for Interference (VCCI) for Information technology equipment. If this equipment is used near a radio or television receiver in a domestic environment, it may cause radio Interference. Install and use the equipment according to the instruction manual.



Class B ITE

この装置は、情報処理装置等電波障害自主規制協議会 (VCCI) の基準に基づくクラス B 情報技術装置です。この装置は家庭環境で使用することを目的としていますが、この装置がラジオやテレビジョン受信機に近接して使用されると、受信障害を引き起こすことがあります。取扱説明書に従って正しい取り扱いをして下さい。

[RETURN TO TOP OF THE PAGE](#)

MIC Notice (South Korea Only)

Class B Device

장치 종류	사용자 안내문
B급 기기	이 장치는 가정용으로 전자파 적합등록을 한 장치로서 주거지역에서는 물론 모든 지역에서 사용할 수 있습니다.



Please note that this device has been approved for non-business purposes and may be used in any environment, including residential areas.

[RETURN TO TOP OF THE PAGE](#)

Polish Center for Testing and Certification Notice

The equipment should draw power from a socket with an attached protection circuit (a three-prong socket). All equipment that works together (computer, monitor, printer, and so on) should have the same power supply source.

The phasing conductor of the room's electrical installation should have a reserve short-circuit protection device in the form of a fuse with a nominal value no larger than 16 amperes (A).

To completely switch off the equipment, the power supply cable must be removed from the power supply socket, which should be located near the equipment and easily accessible.

A protection mark "B" confirms that the equipment is in compliance with the protection usage requirements of standards PN-93/T-42107 and PN-89/E-06251.

Wymagania Polskiego Centrum Badań i Certyfikacji

Urządzenie powinno być zasilane z gniazda z przyłączonym obwodem ochronnym (gniazdo z kolkiem). Współpracujące ze sobą urządzenia (komputer, monitor, drukarka) powinny być zasilane z tego samego źródła.

Instalacja elektryczna pomieszczenia powinna zawierać w przewodzie fazowym rezerwową ochronę przed zwarciami, w postaci bezpiecznika o wartości znamionowej nie większej niż 16A (amperów).

W celu całkowitego wyłączenia urządzenia z sieci zasilania, należy wyjąć wtyczkę kabla zasilającego z gniazdka, które powinno znajdować się w pobliżu urządzenia i być łatwo dostępne.

Znak bezpieczeństwa "B" potwierdza zgodność urządzenia z wymaganiami bezpieczeństwa użytkownika zawartymi w PN-93/T-42107 i PN-89/E-06251.

Pozostałe instrukcje bezpieczeństwa

- Nie należy używać wtyczek adapterowych lub usuwać kolka obwodu ochronnego z wtyczki. Jeżeli konieczne jest użycie przedłużacza to należy użyć przedłużacza 3-żyłowego z prawidłowo połączonym przewodem ochronnym.
- System komputerowy należy zabezpieczyć przed nagłymi, chwilowymi wzrostami lub spadkami napięcia, używając eliminatora przepięć, urządzenia dopasowującego lub bezzakłóceniewego źródła zasilania.
- Należy upewnić się, aby nic nie leżało na kablach systemu komputerowego, oraz aby kable nie były umieszczone w miejscu, gdzie można byłoby na nie nadeptywać lub potykać się o nie.
- Nie należy rozlewać napojów ani innych płynów na system komputerowy.
- Nie należy wpychać żadnych przedmiotów do otworów systemu komputerowego, gdyż może to spowodować pożar lub porażenie prądem, poprzez zwarcie elementów wewnętrznych.
- System komputerowy powinien znajdować się z dala od grzejników i źródeł ciepła. Ponadto, nie należy blokować otworów wentylacyjnych. Należy unikać kładzenia luźnych papierów pod komputer oraz umieszczania komputera w ciasnym miejscu bez możliwości cyrkulacji powietrza wokół niego.

[RETURN TO TOP OF THE PAGE](#)

North Europe (Nordic Countries) Information

Placering/Ventilation

VARNING:

FÖRSÄKRA DIG OM ATT HUVUDBRYTARE OCH UTTAG ÄR LÄTÅTKOMLIGA, NÄR DU STÄLLER DIN UTRUSTNING PÅPLATS.

Placering/Ventilation

ADVARSEL:

SØRG VED PLACERINGSFOR, AT NETLEDNINGENS STIK OG STIKKONTAKT ER NEMT TILGÆNGELIGE.

Paikka/Ilmankierto

VAROITUS:

SIJOITA LAITE SITEN, ETTÄ VERKKOJOHTO VOIDAAN TARVITTAESSA HELPOSTI IRROTTAA PISTORASIESTA.

Plassering/Ventilasjon

ADVARSEL:

NÅR DETTE UTSTYRET Plasseres, MÅ DU PASSE PÅ AT KONTAKTENE FOR STØMTILFØRSEL ER LETTE Å NÅ.

[RETURN TO TOP OF THE PAGE](#)

BSMI Notice (Taiwan Only)

符合乙類資訊產品之標準

[RETURN TO TOP OF THE PAGE](#)

Ergonomie Hinweis (nur Deutschland)

Damit Ihr Monitor immer den in der Zulassung geforderten Werten entspricht, ist darauf zu achten, daß

1. Reparaturen nur durch Fachpersonal durchgeführt werden.
2. nur original-Ersatzteile verwendet werden.
3. bei Ersatz der Bildröhre nur eine bauartgleiche eingebaut wird.

Aus ergonomischen Gründen wird empfohlen, die Grundfarben Blau und Rot nicht auf dunklem Untergrund zu verwenden (schlechte Lesbarkeit und erhöhte Augenbelastung bei zu geringem Zeichenkontrast wären die Folge).

Der arbeitsplatzbezogene Schalldruckpegel nach DIN 45 635 beträgt 70dB (A) oder weniger.



ACHTUNG: BEIM AUFSTELLEN DIESES GERÄTES DARAUFGAHTEN, DAß NETZSTECKER UND NETZKABELANSCHLUß LEICHT ZUGÄNGLICH SIND.

[RETURN TO TOP OF THE PAGE](#)

End-of-Life Disposal

Your new monitor contains materials that can be recycled and reused. Specialized companies can recycle your product to increase the amount of reusable materials and to minimize the amount to be disposed of.

Please find out about the local regulations on how to dispose of your old monitor from your local Philips dealer.

(For customers in Canada and U.S.A.)

This product may contain lead and/or mercury. Dispose of in accordance to local-state and federal regulations.

For additional information on recycling contact www.eia.org (Consumer Education Initiative)

[RETURN TO TOP OF THE PAGE](#)

Information for UK only

WARNING - THIS APPLIANCE MUST BE EARTHED.

Important:

This apparatus is supplied with an approved moulded 13A plug. To change a fuse in this type of plug proceed as follows:

1. Remove fuse cover and fuse.
2. Fit new fuse which should be a BS 1362 5A, A.S.T.A. or BSI approved type.
3. Refit the fuse cover.

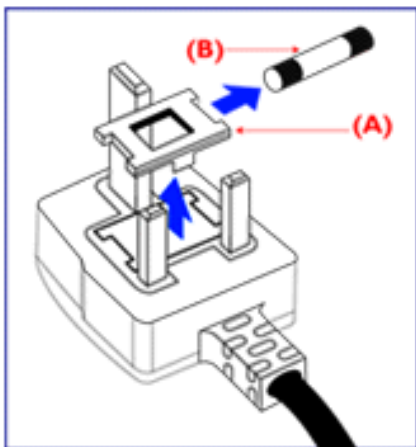

If the fitted plug is not suitable for your socket outlets, it should be cut off and an appropriate 3-pin plug fitted in its place.

If the mains plug contains a fuse, this should have a value of 5A. If a plug without a fuse is used, the fuse at the distribution board should not be greater than 5A.

Note: The severed plug must be destroyed to avoid a possible shock hazard should it be inserted into a 13A socket elsewhere.

How to connect a plug

The wires in the mains lead are coloured in accordance with the following code:

BLUE - "NEUTRAL" ("N")

BROWN - "LIVE" ("L")

GREEN & YELLOW - "EARTH" ("E")

1. The GREEN AND YELLOW wire must be

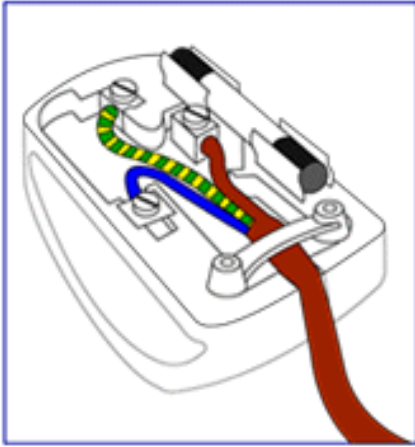

connected to the terminal in the plug which is marked with the letter "E" or by the Earth symbol  or coloured GREEN or GREEN AND YELLOW.

2. The BLUE wire must be connected to the terminal which is marked with the letter "N" or coloured BLACK.

3. The BROWN wire must be connected to the terminal which marked with the letter "L" or coloured RED.

Before replacing the plug cover, make certain that the cord grip is clamped over the sheath of the lead - not simply over the three wires.

[RETURN TO TOP OF THE PAGE](#)

Other Related Information

[Safety and Troubleshooting](#) • [FAQs](#) • [Troubleshooting](#) • [Regulatory Information](#) • [Information for Users in the U. S.](#) • [Information for Users Outside the U.S](#)

Information for Users in the U. S.

For units set at 115 V :

Use a UL Listed Cord Set consisting of a minimum 18 AWG, Type SVT or SJT three conductor cord a maximum of 15-feet long and a parallel blade, grounding type attachment plug rated 15 A, 125 V.

For units set at 230 V:

Use a UL Listed Cord Set consisting of a minimum 18 AWG, Type SVT or SJT three conductor cord a maximum of 15-feet long and a tandem blade, grounding type attachment plug rated 15 A, 250 V.

Information for Users outside the U.S.

For units set at 230 V:

Use a Cord Set consisting of a minimum 18 AWG cord and grounding type attachment plug rated 15 A, 250 V. The Cord Set should have the appropriate safety approvals for the country in which the equipment will be installed and / or be marked HAR.

[RETURN TO TOP OF THE PAGE](#)

Philips Pixel Defect Policy

[Product Features](#) • [Technical Specifications](#) • [Resolution and Preset Modes](#) • [Automatic Power Saving](#) • [Physical Specification](#) • [Pin Assignment](#) • [Product Views](#)

Philips' LCD Panel Pixel Defect Policy

Philips strives to deliver the highest quality products. We use some of the industry's most advanced manufacturing processes and practise stringent quality control. However, pixel or sub pixel defects on the TFT LCD panels used in flat panel monitors are sometimes unavoidable. No manufacturer can guarantee that all panels will be free from pixel defects, but Philips guarantees that any monitor with an unacceptable number of defects will be repaired or replaced under warranty. This notice explains the different types of pixel defects and defines acceptable defect levels for each type. In order to qualify for repair or replacement under warranty, the number of pixel defects on a TFT LCD panel must exceed these acceptable levels. For example, no more than 0.0004% of the sub pixels on a 15" XGA monitor may be defective. Furthermore, Philips sets even higher quality standards for certain types or combinations of pixel defects that are more noticeable than others. This policy is valid worldwide.

Pixels and Sub pixels

A pixel, or picture element, is composed of three sub pixels in the primary colors of red, green and blue. Many pixels together form an image. When all sub pixels of a pixel are lit, the three colored subpixels together appear as a single white pixel. When all are dark, the three colored sub pixels together appear as a single black pixel. Other combinations of lit and dark sub pixels appear as single pixels of other colors.



Types of Pixel Defects

Pixel and sub pixel defects appear on the screen in different ways. There are two categories of pixel defects and several types of sub pixel defects within each category.

Bright Dot Defects appear as pixels or sub pixels that are always lit or 'on'. These are the types of bright dot defects:

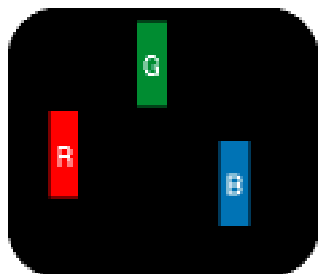

One lit red, green or blue sub pixel



Two adjacent lit sub pixels:

- Red + Blue = Purple
- Red + Green = Yellow
- Green + Blue = Cyan (Light Blue)



Three adjacent lit sub pixels (one white pixel)

Black Dot Defects appear as pixels or sub pixels that are always dark or 'off'. These are the types of black dot defects:

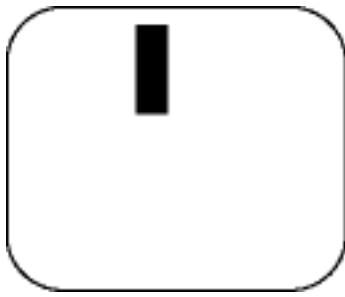

One dark sub pixel

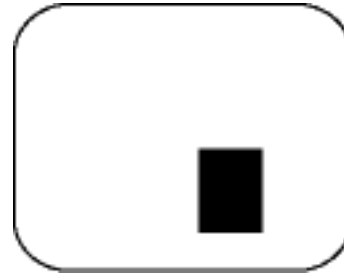

Two or three adjacent dark sub pixels

Proximity of Pixel Defects

Because pixel and sub pixel defects of the same type that are near to one another may be more noticeable, Philips also specifies tolerances for the proximity of pixel defects.

Pixel Defect Tolerances

In order to qualify for repair or replacement due to pixel defects during the warranty period, a TFT LCD panel in a Philips flat panel monitor must have pixel or sub pixel defects exceeding the tolerances listed in the following tables.

BRIGHT DOT DEFECTS	ACCEPTABLE LEVEL
<i>MODEL</i>	300WN5
1 lit sub pixel	0
2 adjacent lit sub pixels	0
3 adjacent lit sub pixels (one white pixel)	0
Distance between two bright dot defects*	N/A
Total bright dot defects of all types	0
Tiny bright dots less then 50% R/B, 30% G	Max 4

* Bright Dot is defined as dots (sub-pixels) which appeared brightly in the screen when the LCM displayed with whole pattern & Bright Dot's brightness is defined over 50% of the brightness against around. (but, Green bright dot is over 30% of brightness against around)

* Here in Tiny Bright Dot is defined as "for Red and Blue" the bright area should be no longer than 1/2 sub-pixel and for green the bright area should be no larger than 1/3 sub-pixel.

BLACK DOT DEFECTS	ACCEPTABLE LEVEL
<i>MODEL</i>	300WN5
1 dark sub pixel	5 or fewer
2 adjacent dark sub pixels	1 or fewer
3 adjacent dark sub pixels	0
Distance between two black dot defects*	15 mm or more
Total black dot defects of all types	5 or fewer

TOTAL DOT DEFECTS	ACCEPTABLE LEVEL
<i>MODEL</i>	300WN5
Total bright or black dot defects of all types	5 or fewer

Note:

* 1 or 2 adjacent sub pixel defects = 1 dot defect

All Philips monitors are ISO13406-2 Compliant

RETURN TO TOP OF THE PAGE

Connecting to Your PC, TV Antenna, DVD/VCR etc.

Product Description • Accessory Pack • Connecting to Your PC, TV Antenna, DVD/VCR etc. • Getting Started • Optimizing Performance

Accessory Pack

Unpack all the parts.



Power cable

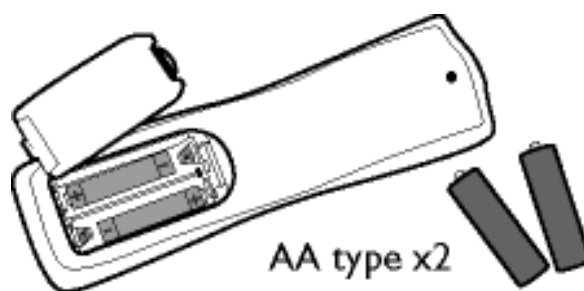

Remote control & batteries



DVI-D cable



VGA signal cable



E-DFU pack

Accessories below are available for TV model only.

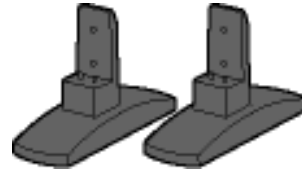

S-video cable

Base

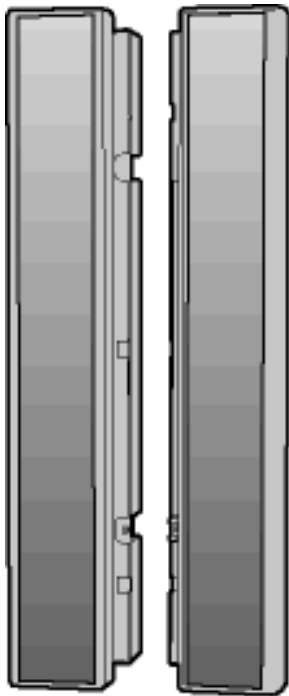

2x 5W Detachable Speakers

[RETURN TO TOP OF THE PAGE](#)

Setting up and connecting your monitor/TV



CAUTION: Ensure that the power to the monitor/TV is switched off before the installation.

- Connecting the monitor/TV

- Connect the cables to the rear of your monitor/TV according to the numbers:

TV model

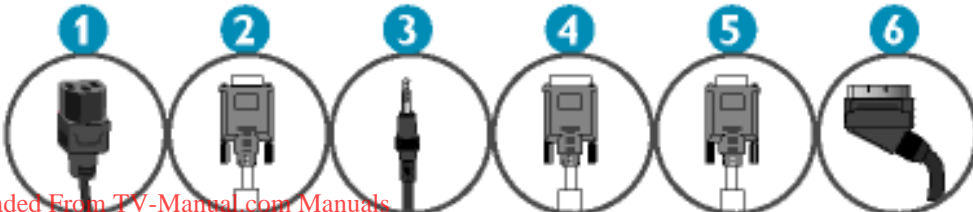
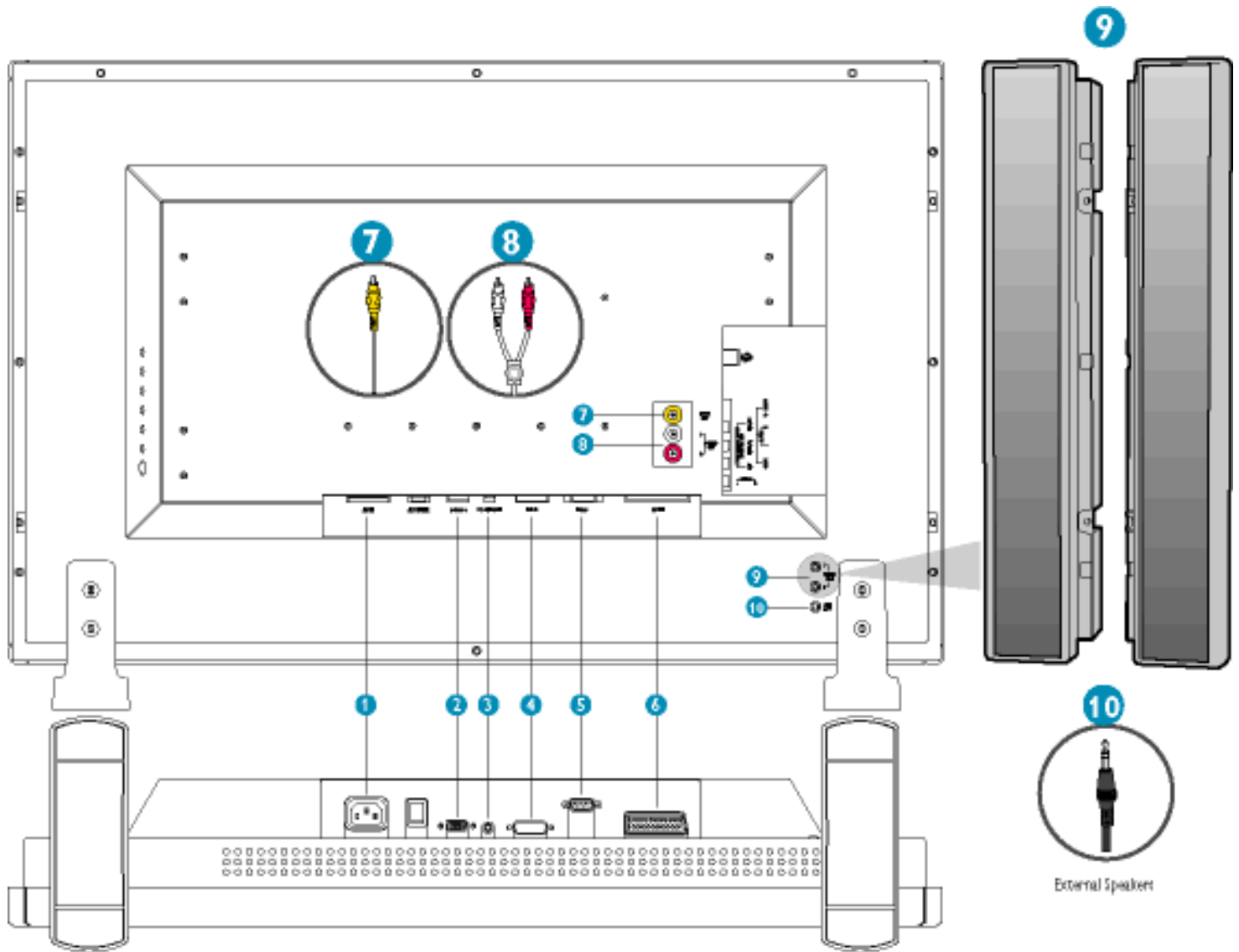



Audio/Video model

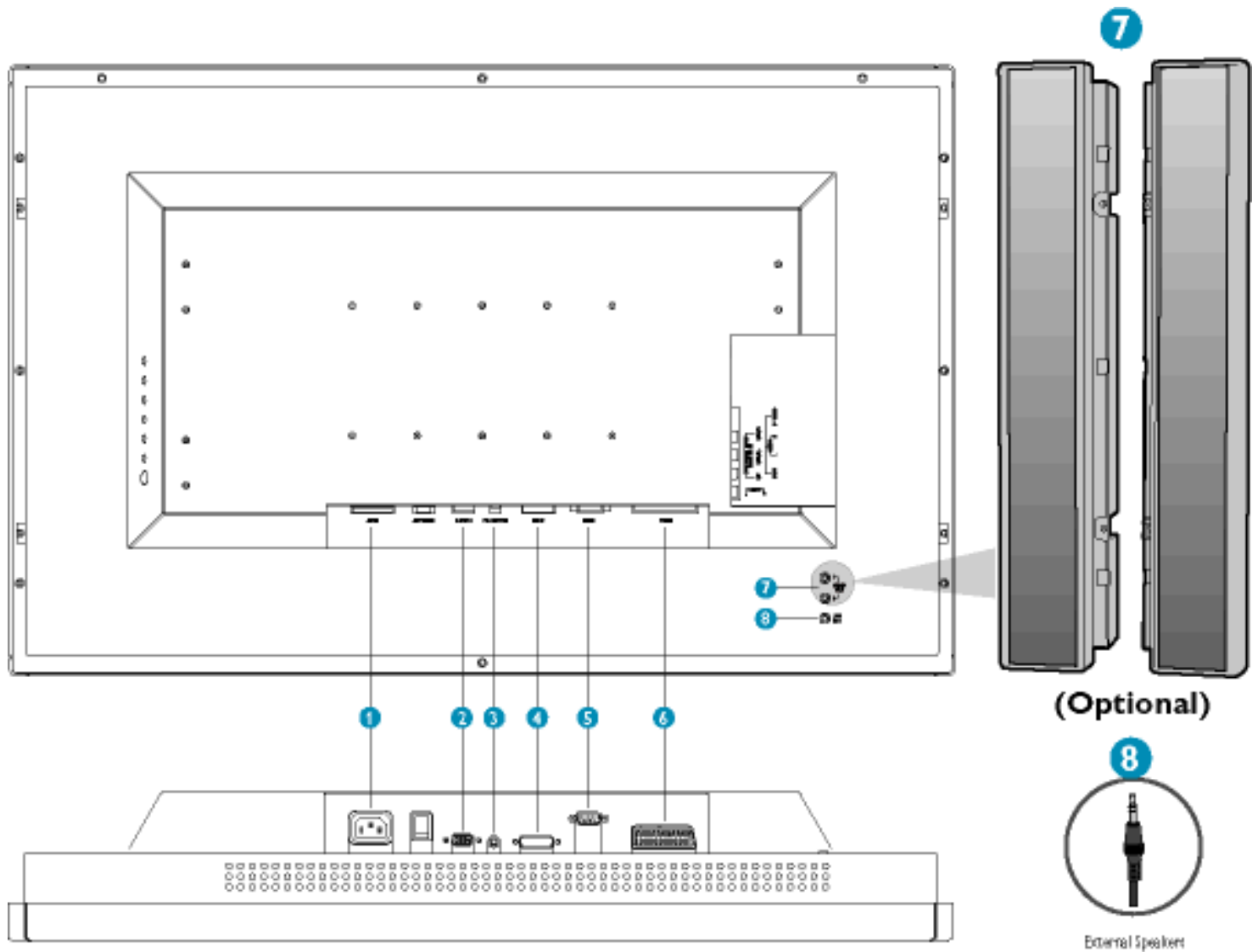

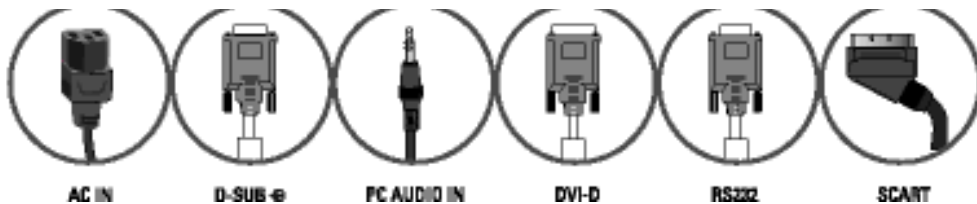

Monitor model

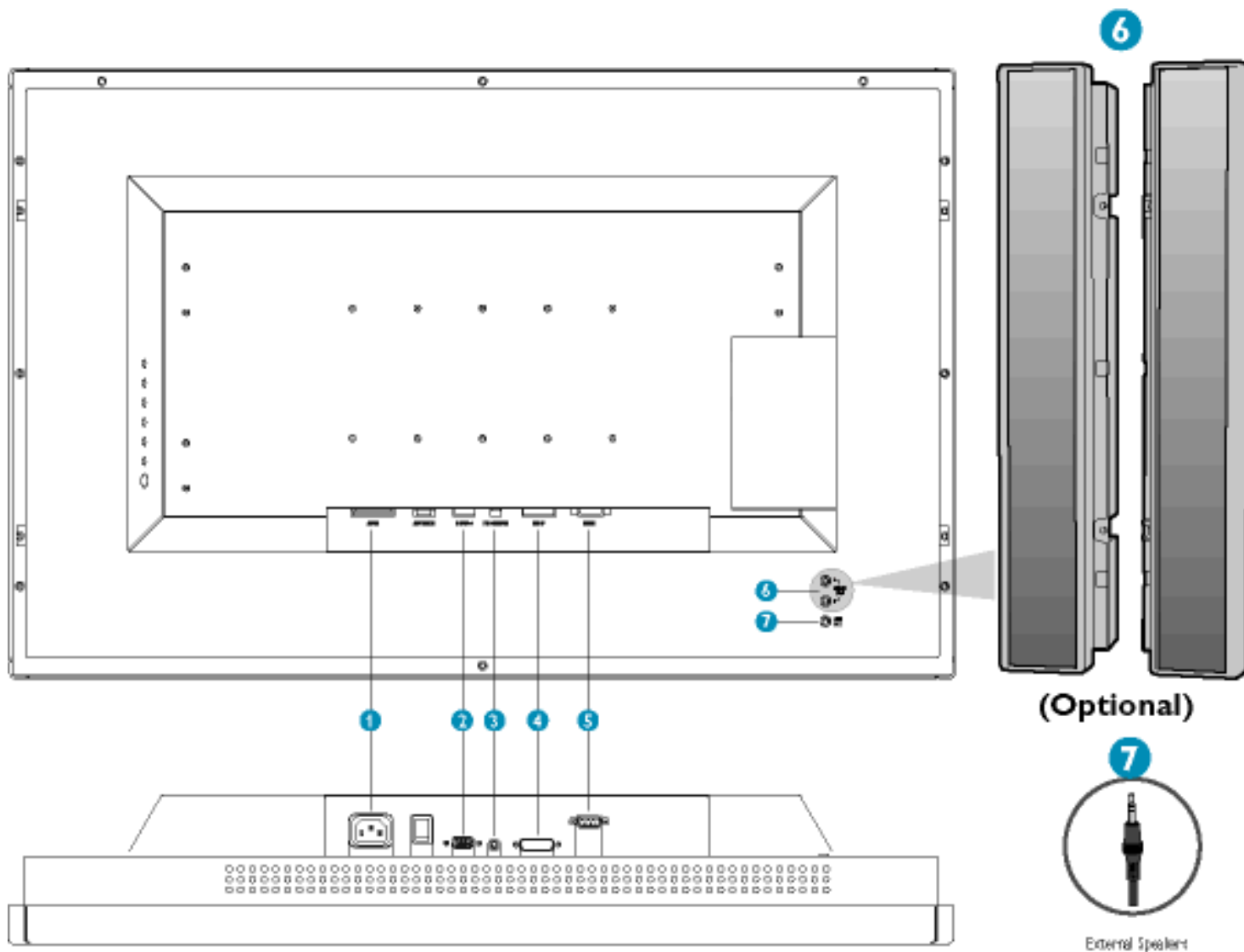



[RETURN TO TOP OF THE PAGE](#)

- Connect to PC

- Connect the cables to the back of your computer by following step 1~3.
- If your monitor displays the computer image the installation has been completed successfully.
- If installation was not successful, see the [Troubleshooting](#) section.
- For installation of the monitor driver for Microsoft Windows®, see the Monitor Driver Installation section ([Getting Started](#)).

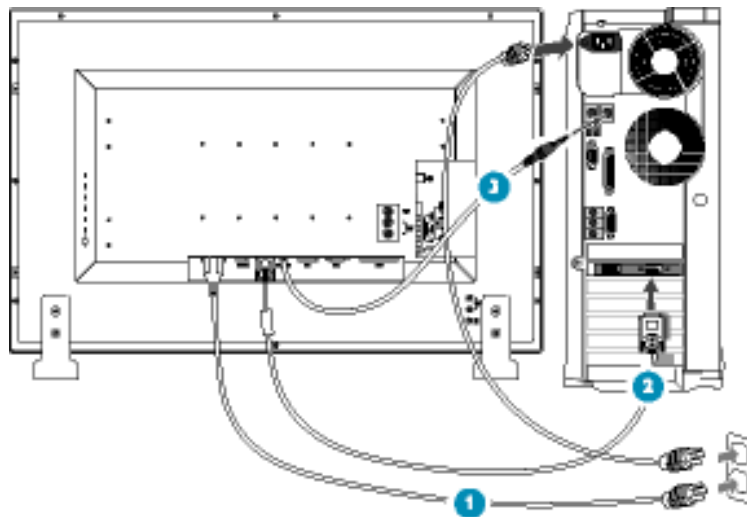

[RETURN TO TOP OF THE PAGE](#)

- Connect to DVD/VCD/VCR

Connect to DVD/VCR/VCD through S-VIDEO

- Connect to DVD/VCR/VCD through S-VIDEO

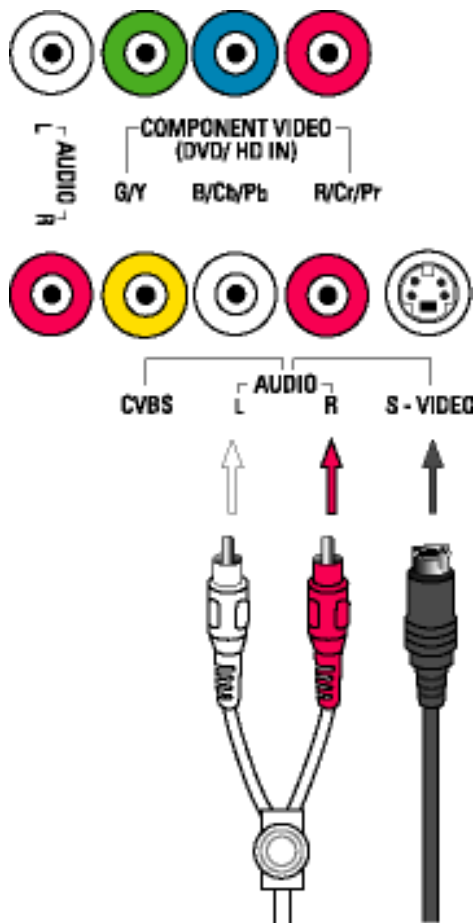

- Connect to DVD/VCR /VCD through SCART (for Europe only)

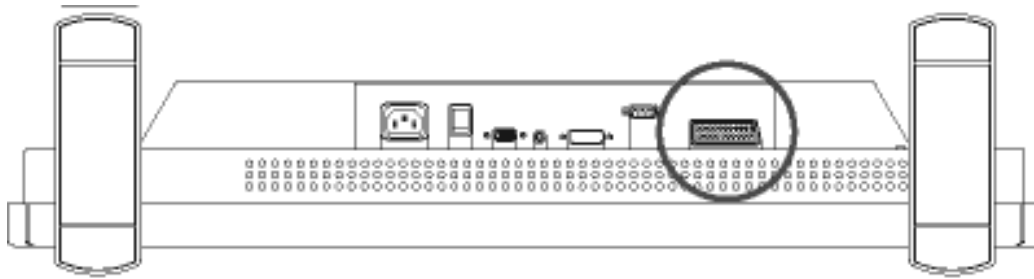

- Connect to DVD/VCR /VCD through composite video (CVBS)

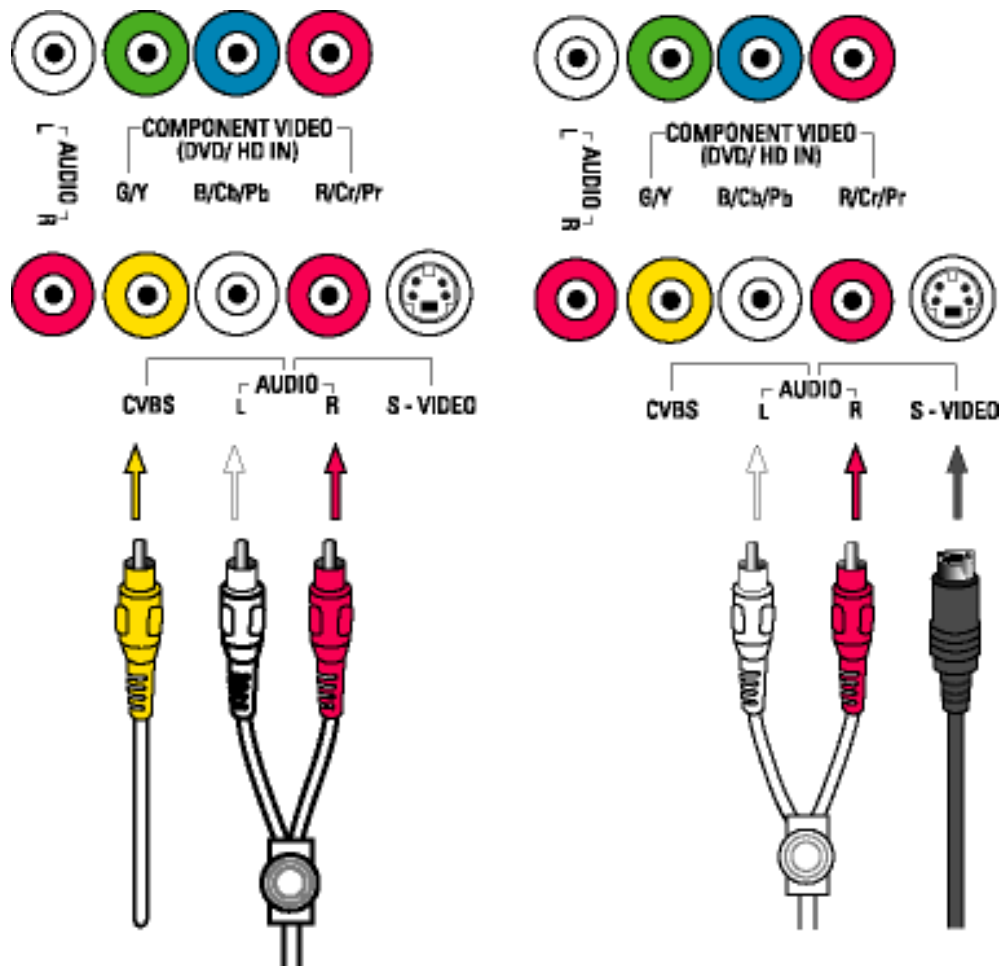

- Connect to DVD/VCR /VCD through component video (YPbPr)

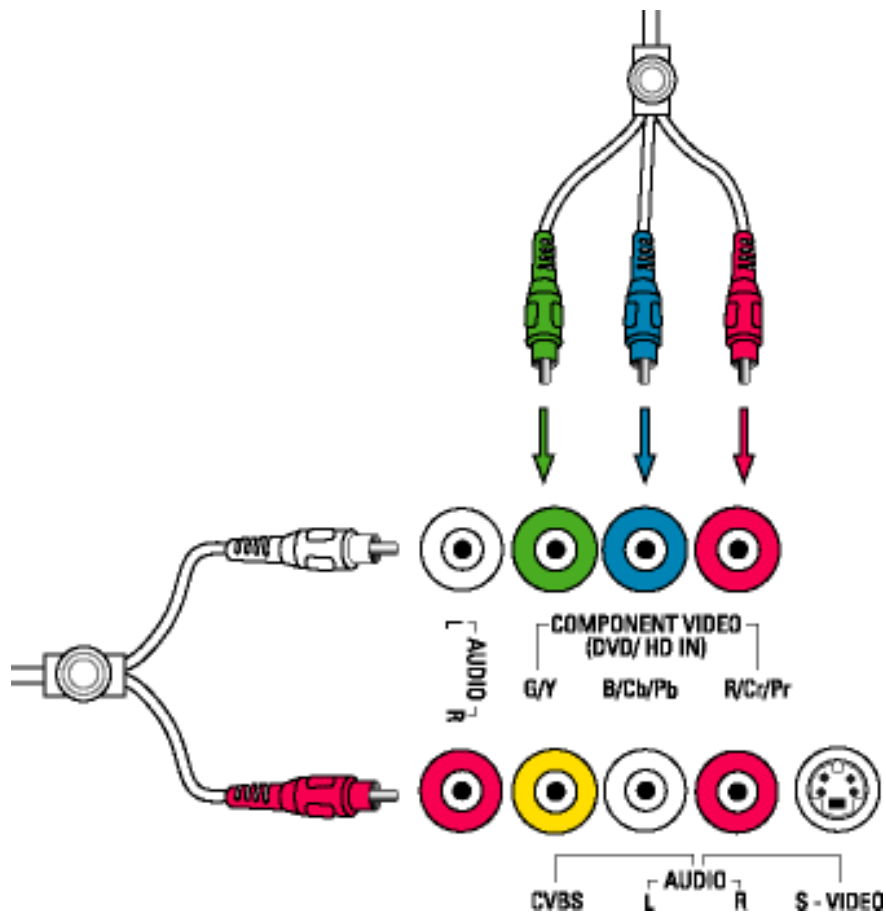

[RETURN TO TOP OF THE PAGE](#)

Connecting to Cable TV

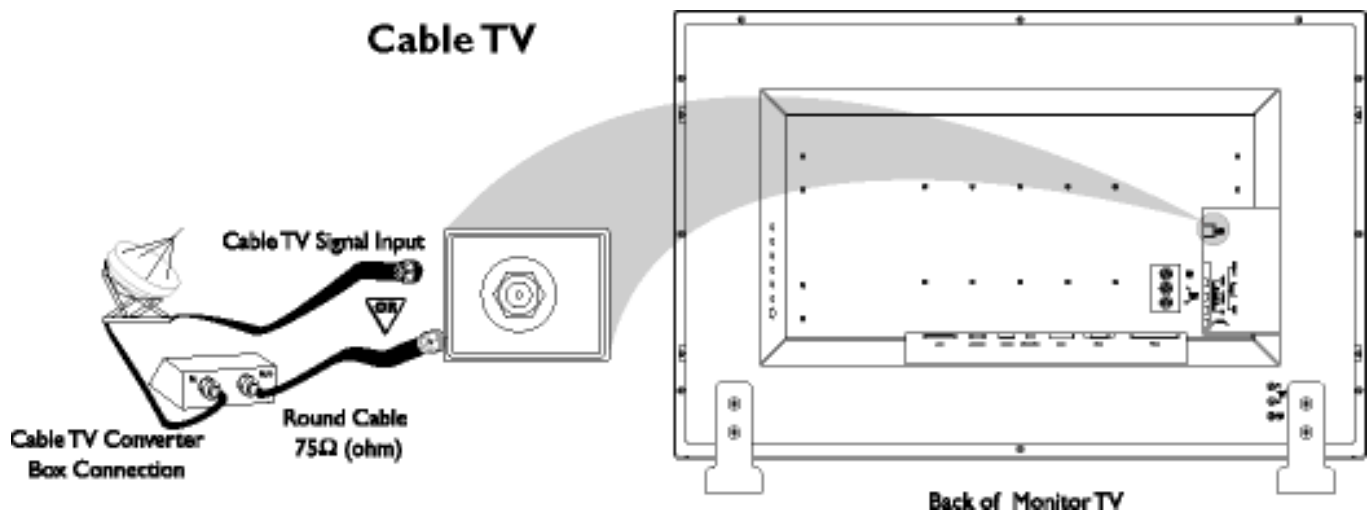

Antenna

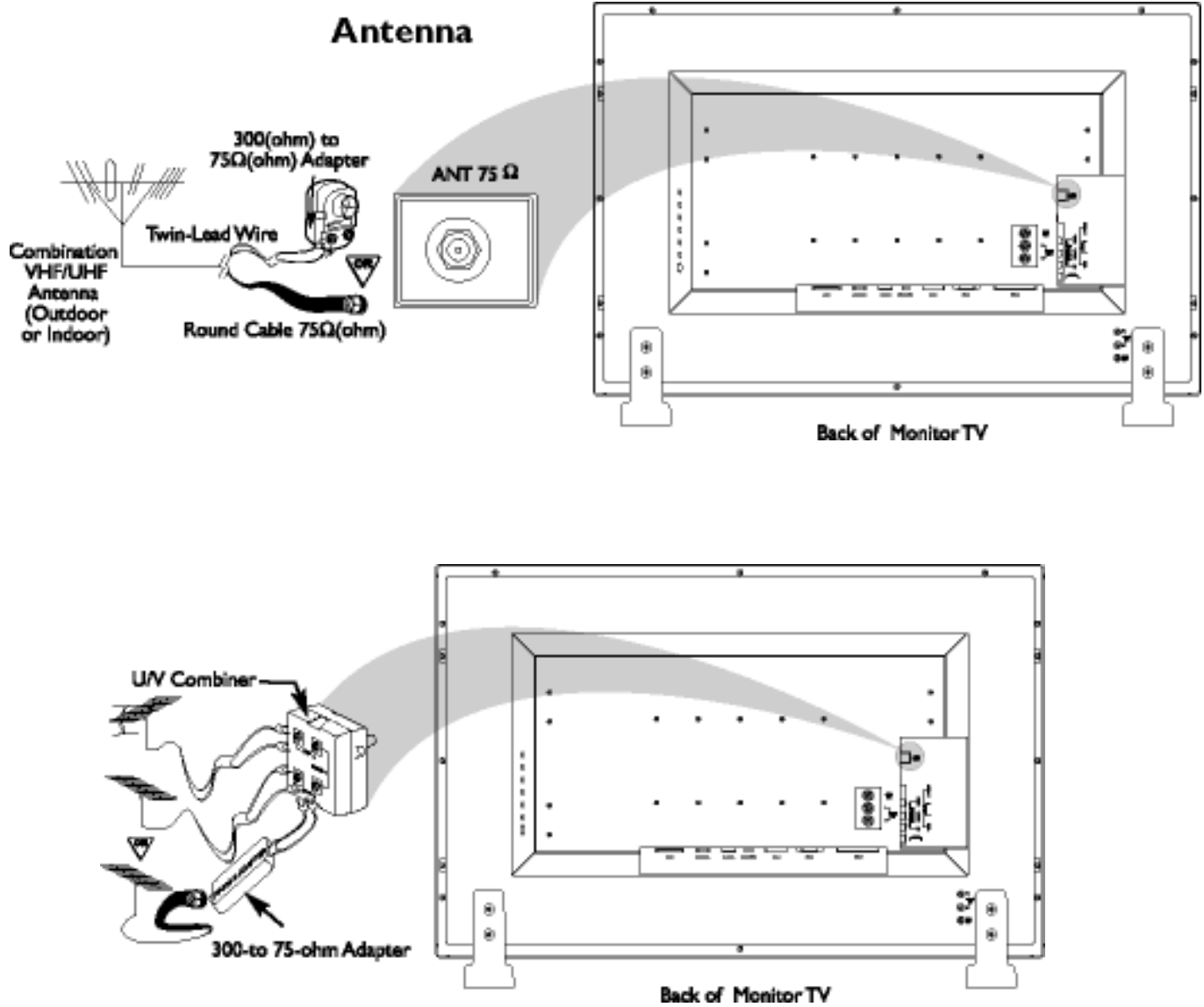

Progressive video and HDTV connections for digital high-definition picture

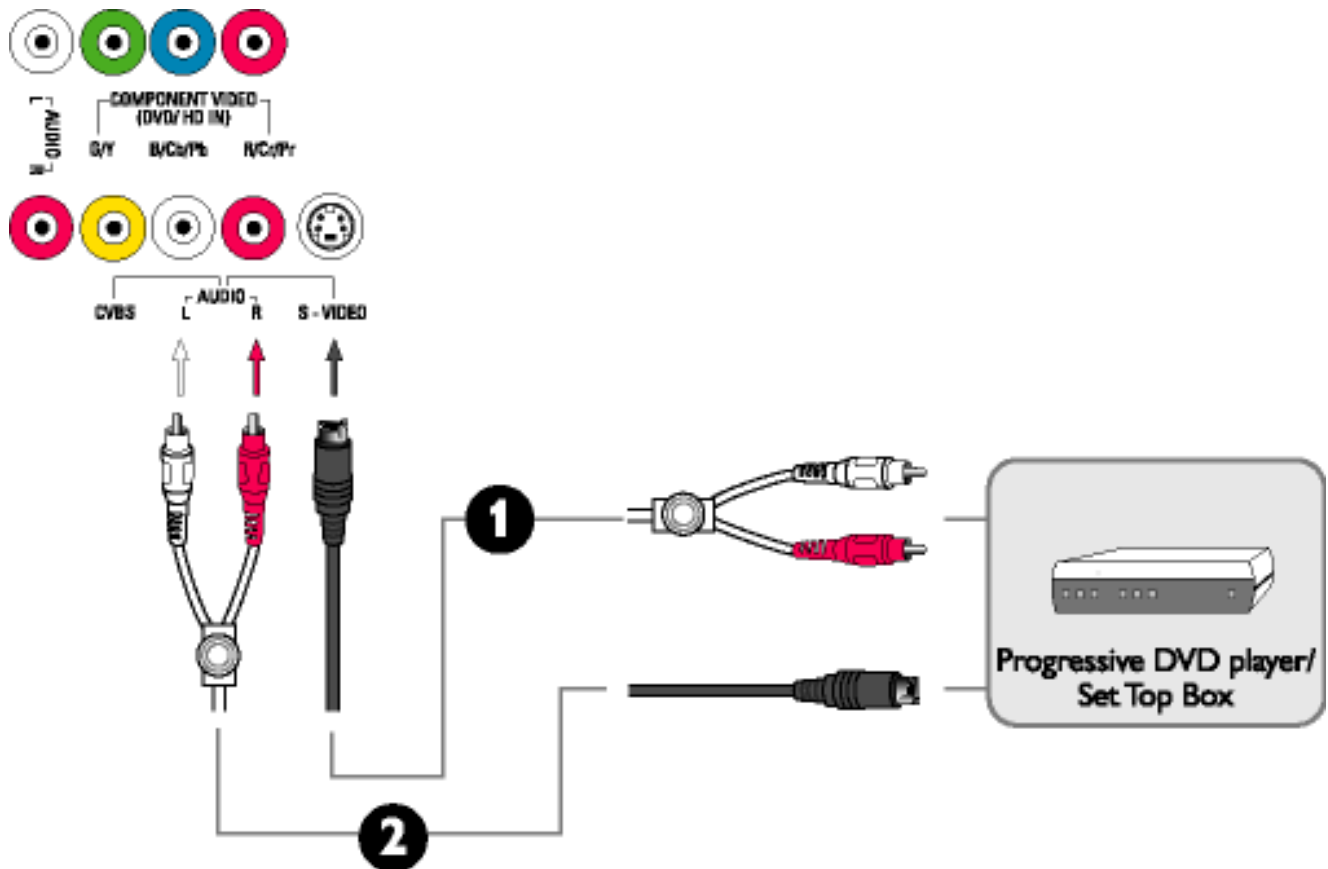
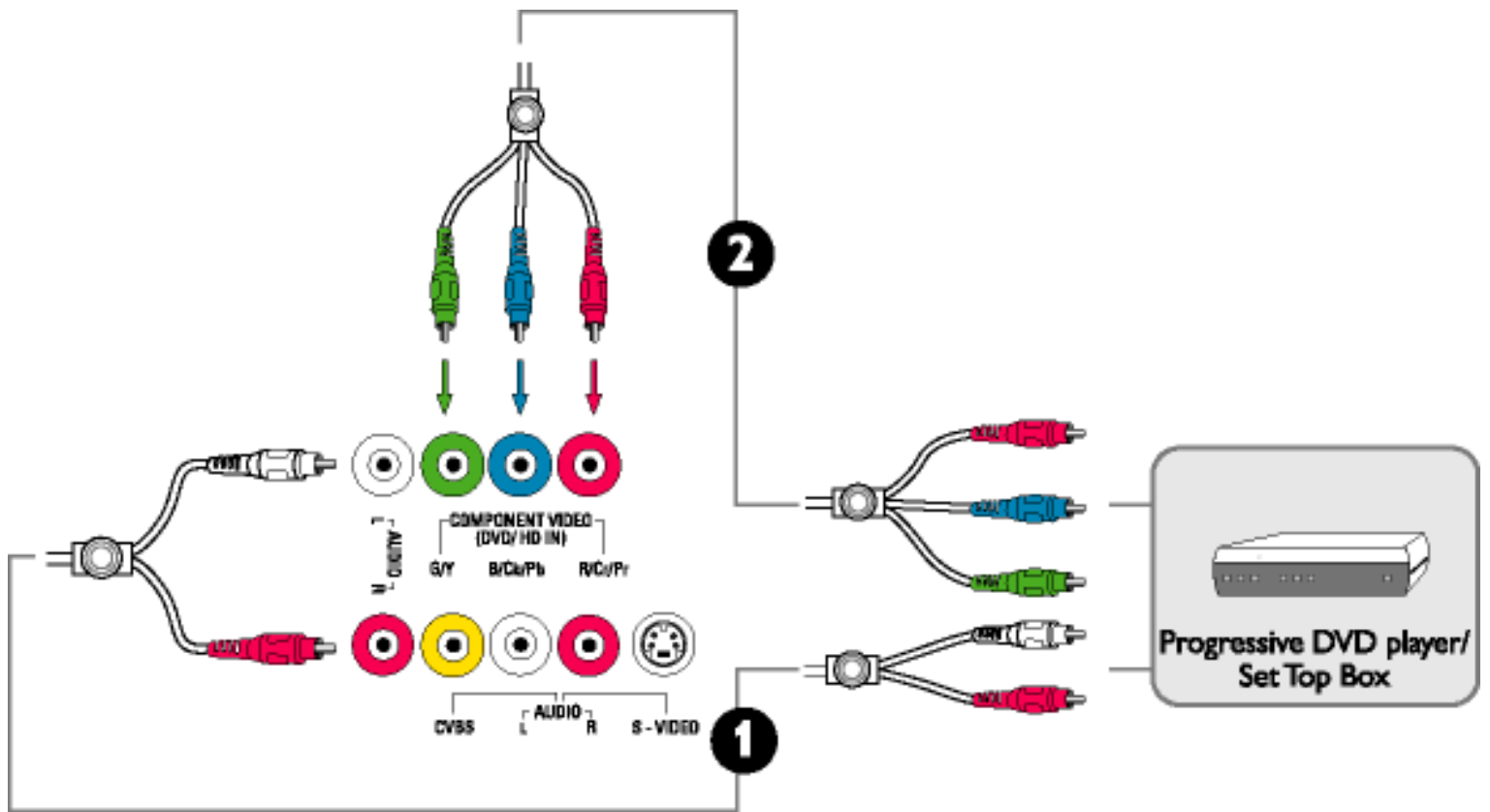

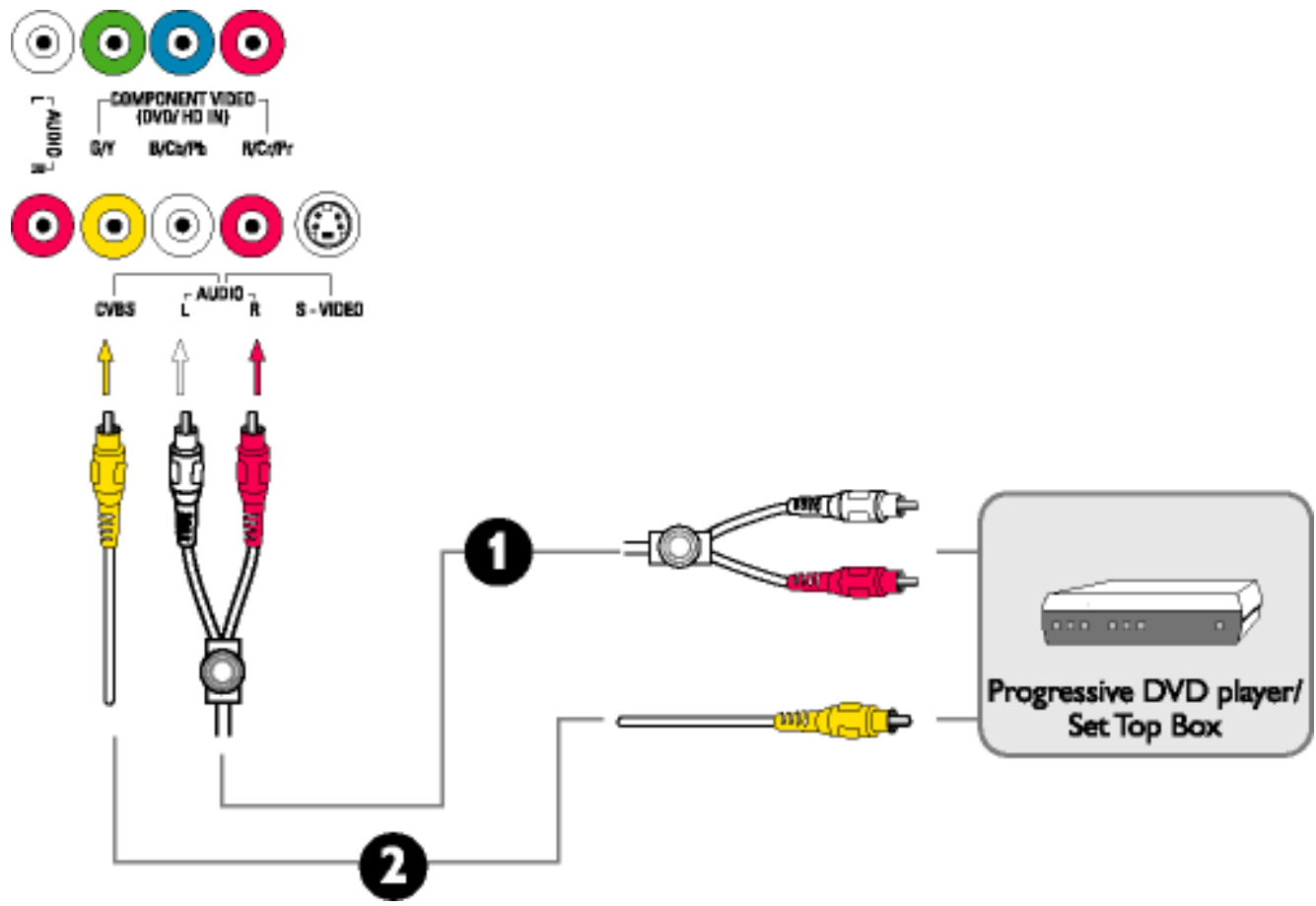

[RETURN TO TOP OF THE PAGE](#)

Getting Started

[Product Description](#) • [Connecting to Your PC, TV Antenna, DVD/VCR etc.](#) • [Getting Started](#) • [Optimizing Performance](#)

Getting Started

Use the information file (.inf) for Windows® 95/98/2000/Me/XP or later

The built-in VESA DDC2B feature in Philips Monitors supports Plug & Play requirements for Windows® 95/98/2000/Me/XP. This information file (.inf) should be installed in order that your Philips monitor can be enabled from the 'Monitor' dialog box in Windows® 95/98/2000/Me/XP and the Plug & Play application can be activated. The installation procedure based on Windows® '95 OEM Release 2 , 98 , Me, XP and 2000 is specified as follows.

For Windows® 95

1. Start Windows® '95
2. Click on the 'Start' button, point to 'Settings', and then click on 'Control Panel'.
3. Double click on the 'Display' Icon.
4. Select the 'Settings' tab then click on 'Advanced...'
5. Select the 'Monitor' button, point to 'Change...' then click on 'Have Disk...'
6. Click on the 'Browse...' button, select the appropriate drive F: (CD-ROM Drive) then click on the 'OK' button.
7. Click on the 'OK' button then select your monitor model and click on the 'OK'.
8. Click on the 'Close' button.

For Windows® 98

1. Start Windows® 98
2. Click on the 'Start' button, point to 'Settings', and then click on 'Control Panel'.
3. Double click on the 'Display' Icon.
4. Select the 'Settings' tab then click on 'Advanced...'
5. Select the 'Monitor' button, point to 'Change...' then click on 'Next'
6. Select 'Display a list of all the drivers in a specific location, so you can choose the driver you want.' then click on 'Next' and then click on 'Have Disk...'
7. Click on the 'Browse...' button, select the appropriate drive F: (CD-ROM Drive) then click on the 'OK' button.
8. Click on the 'OK' button then select your monitor model and click on the 'Next' button.
9. Click on the 'Finish' button then the 'Close' button.

For Windows® Me

1. Start Windows® Me
2. Click on the 'Start' button, point to 'Settings', and then click on 'Control Panel'.
3. Double click on the 'Display' Icon.
4. Select the 'Settings' tab then click on 'Advanced...'
5. Select 'Monitor' button, then click on 'Change...' button.
6. Select 'Specify the location of the driver(Advanced)' and click on the 'Next' button.
7. Select 'Display a list of all the drivers in a specific location, so you can choose the driver you want', then click on 'Next' and then click on 'Have Disk...'
8. Click on 'Browse...' button, select the appropriate drive F: (CD-ROM Drive) then click on the 'OK' button.
9. Click on the 'OK' button, select your monitor model and click on the 'Next' button.
10. Click on 'Finish' button then the 'Close' button.

For Windows® 2000

1. Start Windows® 2000
2. Click on the 'Start' button, point to 'Settings', and then click on 'Control Panel'.
3. Double click on the 'Display' Icon.
4. Select the 'Settings' tab then click on 'Advanced...'
5. Select 'Monitor'
 - If the 'Properties' button is inactive, it means your monitor is properly configured. Please stop installation.
 - If the 'Properties' button is active. Click on 'Properties' button. Please follow the steps given below.
6. Click on 'Driver' and then click on 'Update Driver...' then click on the 'Next' button.
7. Select 'Display a list of the known drivers for this device so that I can choose a specific driver', then click on 'Next' and then click on 'Have disk...'
8. Click on 'Browse...' button then select the appropriate drive F: (CD-ROM Drive).
9. Click on the 'Open' button, then click on the 'OK' button.
10. Select your monitor model and click on the 'Next' button.
11. Click on the 'Finish' button then the 'Close' button.
 - If you can see the 'Digital Signature Not Found' window, click on the 'Yes' button.

For Windows® XP

1. Start Windows® XP
2. Click on the 'Start' button and then click on 'Control Panel'.
3. Select and click on the category 'Printers and Other Hardware'
4. Click on the 'Display' Icon.
5. Select the 'Settings' tab then click on the 'Advanced' button.
6. Select 'Monitor' tab
 - If the 'Properties' button is inactive, it means your monitor is properly configured. Please stop installation.

- If the 'Properties' button is active, click on 'Properties' button.

Please follow the steps below.

7. Click on the 'Driver' tab and then click on 'Update Driver...' button.
8. Select the 'Install from a list or specific location [advanced]' radio button and then click on the 'Next' button.
9. Select the 'Don't Search. I will choose the driver to install' radio button. Then click on the 'Next' button.
10. Click on the 'Have disk...' button, then click on the 'Browse...' button and then select the appropriate drive F: (CD-ROM Drive).
11. Click on the 'Open' button, then click the 'OK' button.
12. Select your monitor model and click on the 'Next' button.
 - If you can see the 'has not passed Windows® Logo testing to verify its compatibility with Windows® XP' message please click on the 'Continue Anyway' button.
13. Click on the 'Finish' button then the 'Close' button.
14. Click on the 'OK' button and then the 'OK' button again to close the Display_Properties dialog box.

If your Windows® 95/98/2000/Me/XP version is different or you need more detailed installation information, please refer to Windows® 95/98/2000/Me/XP user's manual.

[RETURN TO TOP OF THE PAGE](#)

Your Philips F1rst Choice Warranty

Thank you for purchasing this Philips monitor.



All Philips monitors are designed and manufactured to high standards and deliver high-quality performance, ease of use and ease of installation. Should you encounter any difficulties while installing or using this product, please contact the Philips helpdesk directly to benefit from your Philips F1rst Choice Warranty. This three-year service warranty entitles you to a swap model on-site if your monitor turns out to be faulty or defective. Philips aims at a swap within 48 hours of your call being received.

What is covered?

The Philips F1rst Choice Warranty applies within Andorra, Austria, Belgium, Cyprus, Denmark, France, Germany, Greece, Finland, Ireland, Italy, Liechtenstein, Luxembourg, Monaco, the Netherlands, Norway, Portugal, Sweden, Switzerland, Spain and the United Kingdom and only for monitors originally designed, manufactured, approved and/or authorized for usage within these countries.

Warranty coverage begins as from the day you buy your monitor. *For three years thereafter*, your monitor will be swapped by at least an equivalent monitor in case of defects provided for under the warranty coverage.

The swap monitor remains yours and Philips keeps the defective/original monitor. For the swap monitor the warranty period remains equal to that of your original monitor, being 36 months as from the purchase date of your original monitor.

What is excluded?

The Philips F1rst Choice Warranty applies provided the product is handled properly for its intended use, in accordance with its operating instructions and upon presentation of the original invoice or cash receipt, indicating the date of purchase, dealer's name and model and production number of the product.

The Philips F1rst Choice Warranty may not apply if:

- The documents have been altered in any way or made illegible;
- The model or production number on the product has been altered, deleted, removed or made illegible;
- Repairs or product modifications and alterations have been executed by unauthorized service organizations or persons;

- Damage is caused by accidents including but not limited to lightning, water or fire, misuse or neglect;
- Reception problems caused by signal conditions or cable or antenna systems outside the unit;
- Defects caused by abuse or misuse of the monitor;
- Product requires modification or adaptation to enable it to comply with local or national technical standards, which apply in countries for which the product was not originally designed, manufactured, approved and/or authorized. Therefore always check whether a product can be used in a specific country.
- Note that products that are not originally designed, manufactured, approved and/or authorized for usage within the Philips F1rst Choice countries, do not apply to the Philips F1rst Choice Warranty. In these cases the Philips global warranty terms are valid.

Just a click away

In case of any problems, we advise you to read the operating instructions carefully or go to the www.philips.com/support website for additional support.

Just a phone call away

In order to avoid unnecessary inconvenience, we advise you to read the operating instructions carefully or go to the www.philips.com/support website for additional support before contacting the Philips helpdesk.

To solve your problem quickly, please prepare the following details before contacting the Philips helpdesk:

- Philips type number
- Philips serial number
- Purchase date (copy of purchase may be required)
- PC environment Processor:
 - 286/386/486/Pentium Pro/Internal memory
 - Operating system (Windows, DOS, OS/2, MAC)
 - Fax/Modem/Internet program?
- Other cards installed

Having the following information available will also help speed up the process:

- Your proof of purchase indicating: date of purchase, dealer name, model and product serial number.
- The full address to which the faulty monitor has to be collected and the swap model should be delivered.

Philips' customer help desks are located worldwide. Click here to access the [F1rst Choice Contact](#)

[Information.](#)

Or you can reach us via:

Website: <http://www.philips.com/support>

Your International Guarantee

Dear Customer,

Thank you for purchasing this Philips product which has been designed and manufactured to the highest quality standards.

If, unfortunately, something should go wrong with this product Philips guarantees free of charge labor and replacement parts irrespective of the country where it is repaired during a period of 12 months from date of purchase. This international Philips guarantee complements the existing national guarantee obligations to you of dealers and Philips in the country of purchase and does not affect your statutory rights as a customer.

The Philips guarantee applies provided the product is handled properly for its intended use, in accordance with its operating instructions and upon presentation of the original invoice or cash receipt, indicating the date of purchase, dealer's name and model and production number of the product.

The Philips guarantee may not apply if:

- the documents have been altered in any way or made illegible;
- the model or production number on the product has been altered, deleted, removed or made illegible;
- repairs or product modifications and alterations have been executed by unauthorized service organizations or persons;
- damage is caused by accidents including but not limited to lightning, water or fire, misuse or neglect.

Please note that the product is not defective under this guarantee in the case where modifications become necessary in order for the product to comply with local or national technical standards which apply in countries for which the product was not originally designed and/or manufactured. Therefore always check whether a product can be used in a specific country.

In case your Philips product is not working correctly or is defective, please contact your Philips dealer. In the event you require service whilst in another country a dealer address can be given to you by the Philips Consumer Help Desk in that country, the telephone and fax number of which can be found in the relevant part of this booklet.

In order to avoid unnecessary inconvenience, we advise you to read the operating instructions carefully before contacting your dealer. If you have questions which your dealer cannot answer or any related question please contact the [Philips Consumer Information Centers](#) or via:

Website: <http://www.philips.com>

PHILIPS LIMITED WARRANTY

One (1) Year Labor and Parts Repair

PHILIPS CONSUMER ELECTRONICS warrants this product against defect in material or workmanship, subject to any conditions set forth as follows:

PROOF OF PURCHASE:

You must have proof of the date of purchase to receive warranted repair on the product. A sales receipt or other document showing the product and the date that you purchased the products as well as the authorized retailer included, is considered such proof.

COVERAGE:

(If this product is determined to be defective)

LABOR: For a period of one (1) year from the date of purchase, Philips will repair or replace the product, at its option, at no charge, or pay the labor charges to any Philips authorized repair facility. After the period of one (1) year, Philips will no longer be responsible for charges incurred.

PARTS: For a period of one (1) year from the date of purchase, Philips will supply, at no charge, new or rebuilt replacement parts in exchange for defective parts, through a Philips authorized service center.

Note: If Philips is unable to provide service in your area, receipt of the paid service can be submitted for consideration of adjustment or full reimbursement at Philips discretion.

EXCLUDED FROM WARRANTY COVERAGE

Your warranty does not cover:

- Labor charges for installation or setup of the product, adjustment of customer controls on the product, and installation or repair of antenna systems outside of the product.
- Product repair and/or part replacement because of improper installation, connections to improper voltage supply, abuse, neglect, misuse, accident, unauthorized repair or other cause not within the control of Philips.
- A product that requires modification or adaptation to enable it to operate in any country other than the country for which it was designed, manufactured, approved and/or authorized, or repair of products damaged by these modifications.
- Damage occurring to product during shipping when improperly packaged or cost associated with packaging.
- Product lost in shipment and no signature verification of receipt can be provided.
- Products sold AS IS or RENEWED.

CARRY-IN / SHIP-IN WARRANTY

For Carry-In warranty repair, take the product to a Philips authorized service center for repair. When the product has been repaired, you must pick up the unit at the center. For Ship-In warranty repair, ship the product to a Philips authorized service center for repair in its original carton and packing material. If you do not have the original carton or packing material, have your product professionally packed for shipping. Ship product via a traceable carrier. When it is necessary for you to ship the product to Philips for repair, you will pay the shipping cost for shipment to Philips. Philips will pay the shipping costs when returning the product to you.

TO OBTAIN WARRANTY SERVICE IN THE U.S.A., PUERTO RICO, OR U.S. VIRGIN ISLANDS...

Contact Philips Customer Care Center at:
[1-888-PHILIPS \(1-888-744-5477\)](tel:1-888-PHILIPS)

TO OBTAIN WARRANTY SERVICE IN CANADA...

[1-800-661-6162](tel:1-800-661-6162) (French Speaking)
[1-888-PHILIPS \(1-888-744-5477\)](tel:1-888-PHILIPS) - (English or Spanish Speaking)

REPAIR OR REPLACEMENT AS PROVIDED UNDER THIS WARRANTY IS THE EXCLUSIVE REMEDY FOR THE CONSUMER. PHILIPS SHALL NOT BE LIABLE FOR ANY INCIDENTAL OR CONSEQUENTIAL DAMAGES FOR BREACH OF ANY EXPRESS OR IMPLIED WARRANTY ON THIS PRODUCT. EXCEPT TO THE EXTENT PROHIBITED BY APPLICABLE LAW, ANY IMPLIED WARRANTY OF MERCHANTABILITY OR FITNESS FOR A PARTICULAR PURPOSE ON THIS PRODUCT IS LIMITED IN DURATION TO THE DURATION OF THIS WARRANTY.

Some states do not allow the exclusions or limitation of incidental or consequential damages, or allow limitations on how long an implied warranty lasts, so the above limitations or exclusions may not apply to you. In addition, if you enter into a service contract agreement with the PHILIPS partnership within ninety (90) days of the date of sale, the limitation on how long an implied warranty lasts does not apply.

This warranty gives you specific legal rights. You may have other rights which vary from state/province to state/province.

Philips, P.O. Box 671539, Marietta, GA. 30006-0026

(Warranty: 4835 710 27175)

F1rst Choice Contact Information

Country	Telephone number	Tariff
Austria	01 546 575 603	Local call tariff
Belgium	070 253 010	€ 0.17
Cyprus	800 92256	Free of Charge
Denmark	3525 8761	Local call tariff
Finland	09 2290 1908	Local call tariff
France	08 9165 0006	€ 0.23
Germany	0180 5 007 532	€ 0.12
Greece	00800 3122 1223	Local call tariff
Ireland	01 601 1161	Local call tariff
Italy	199 404 042	€ 0.25
Luxembourg	26 84 30 00	Local call tariff
The Netherlands	0900 0400 063	€ 0.20
Norway	2270 8250	Local call tariff
Portugal	2 1359 1440	Local call tariff
Spain	902 888 785	€ 0.15
Sweden	08 632 0016	Local call tariff
Switzerland	02 2310 2116	Local call tariff
United Kingdom	0207 949 0069	Local call tariff

Consumer Information Centers

Antilles • Argentina • Australia • Bangladesh • Brasil • Canada • Chile • China • Colombia • Belarus • Bulgaria • Croatia • Czech Republic • Estonia • Dubai • Hong Kong • Hungary • India • Indonesia • Korea • Latvia • Lithuania • Malaysia • Mexico • Morocco • New Zealand • Pakistan • Paraguay • Peru • Philippines • Poland • Romania • Russia • Serbia & Montenegro • Singapore • Slovakia • Slovenia • South Africa • Taiwan • Thailand • Turkey • Ukraine • Uruguay • Venezuela

Eastern Europe

BELARUS

Technical Center of JV IBA
M. Bogdanovich str. 155
BY - 220040 Minsk
Tel: +375 17 217 33 86

BULGARIA

LAN Service
140, Mimi Balkanska Str.
Office center Translog
1540 Sofia, Bulgaria
Tel: +359 2 960 2360
www.lan-service.bg

CZECH REPUBLIC

Xpectrum
Lužná 591/4
CZ - 160 00 Praha 6 Tel: 800 100 697
Email: info@xpectrum.cz
www.xpectrum.cz

CROATIA

Renoprom d.o.o.
Mlinska 5, Strmec
HR - 41430 Samobor
Tel: +385 1 333 0974

ESTONIA

FUJITSU SERVICES OU
Akadeemia tee 21G
EE-12618 Tallinn
Tel: +372 6519900
www.ee.invia.fujitsu.com

HUNGARY

Serware Szerviz
Vizimolnár u. 2-4
HU - 1031 Budapest
Tel: +36 1 2426331
Email: inbox@serware.hu
www.serware.hu

LATVIA

ServiceNet LV
Jelgavas iela 36
LV - 1055 Riga,
Tel: +371 7460399
Email: serviss@servicenet.lv

LITHUANIA

ServiceNet LT
Gaiziunu G. 3
LT - 3009 KAUNAS
Tel: +370 7400088
Email: servisas@servicenet.lt
www.servicenet.lt

ROMANIA

Blue Ridge Int'l Computers SRL
115, Mihai Eminescu St., Sector 2
RO - 020074 Bucharest
Tel: +40 21 2101969

SERBIA & MONTENEGRO

Tehnicom Service d.o.o.
Bulevar Vojvode Misica 37B
YU - 11000 Belgrade
Tel: +381 11 3060 886

SLOVAKIA

Datalan Servisne Stredisko
Puchovska 8
SK - 831 06 Bratislava
Tel: +421 2 49207155
Email: servis@datalan.sk

SLOVENIA

PC HAND
Brezovce 10
SI - 1236 Trzin
Tel: +386 1 530 08 24
Email: servis@pchand.si

POLAND

Zolter
ul.Zytnia 1
PL - 05-500 Piaseczno
Tel: +48 22 7501766
Email: servmonitor@zolter.com.pl
www.zolter.com.pl

RUSSIA

Tel: +7 095 961-1111
Tel: 8-800-200-0880
Website: www.philips.ru

TURKEY

Türk Philips Ticaret A.S.
Yukari Dudullu Org.San.Bolgesi
2.Cadde No:22
34776-Umraniye/Istanbul
Tel: (0800)-261 33 02

UKRAINE

Comel
Shevchenko street 32
UA - 49030 Dnepropetrovsk
Tel: +380 562320045
www.csp-comel.com

Latin America

ANTILLES

Philips Antillana N.V.
Kaminda A.J.E. Kusters 4
Zeelandia, P.O. box 3523-3051
Willemstad, Curacao
Phone: (09)-4612799
Fax : (09)-4612772

ARGENTINA

Philips Antillana N.V.
Vedia 3892 Capital Federal
CP: 1430 Buenos Aires
Phone/Fax: (011)-4544 2047

BRASIL

Philips da Amazônia Ind. Elet. Ltda.
Rua Verbo Divino, 1400-São Paulo-SP
CEP-04719-002
Phones: 11 21210203 -São Paulo & 0800-701-0203-Other Regions without São Paulo City

CHILE

Philips Chilena S.A.
Avenida Santa Maria 0760
P.O. box 2687 Santiago de Chile
Phone: (02)-730 2000
Fax : (02)-777 6730

COLOMBIA

Industrias Philips de Colombia
S.A.-Division de Servicio
CARRERA 15 Nr. 104-33
Bogota, Colombia
Phone:(01)-8000 111001 (toll free)
Fax : (01)-619-4300/619-4104

MEXICO

Consumer Information Centre
Norte 45 No.669
Col. Industrial Vallejo
C.P.02300, -Mexico, D.F.
Phone: (05)-3687788 / 9180050462
Fax : (05)-7284272

PARAGUAY

Av. Rca. Argentina 1780 c/Alfredo Seiferheld
P.O. Box 605
Phone: (595 21) 664 333
Fax: (595 21) 664 336
Customer Desk:
Phone: 009 800 54 1 0004

PERU

Philips Peruana S.A.
Customer Desk
Comandante Espinar 719
Casilla 1841
Limab18
Phone: (01)-2136200
Fax : (01)-2136276

URUGUAY

Rambla O'Higgins 5303 Montevideo
Uruguay
Phone: (598) 619 66 66
Fax: (598) 619 77 77
Customer Desk:
Phone: 0004054176

VENEZUELA

Industrias Venezolanas Philips S.A.
Apartado Postal 1167
Caracas 1010-A
Phone: (02) 2377575
Fax : (02) 2376420

Canada

CANADA

Philips Electronics Ltd.
281 Hillmount Road
Markham, Ontario L6C 2S3
Phone: (800) 479-6696

Pacific

AUSTRALIA

Philips Consumer Electronics
Consumer Care Center
Level 1, 65 Epping Rd
North Ryde NSW 2113
Phone: 1300 363 391
Fax : +61 2 9947 0063

NEW ZEALAND

Philips New Zealand Ltd.
Consumer Help Desk
2 Wagener Place, Mt. Albert
P.O. box 1041
Auckland
Phone: 0800 477 999 (toll free)
Fax : 0800 288 588

Asia

BANGLADESH

Philips Service Centre
100 Kazi Nazrul Islam
Avenue Kawran Bazar C/A
Dhaka-1215
Phone: (02)-812909
Fax : (02)-813062

CHINA

SHANGHAI
Rm 1007, Hongyun Building, No. 501 Wuning road,
200063 Shanghai P.R. China
Phone: 4008 800 008
Fax: 21-52710058

HONG KONG

Philips Electronics Hong Kong Limited
Consumer Service
Unit A, 10/F. Park Sun Building
103-107 Wo Yi Hop Road
Kwai Chung, N.T.
Hong Kong
Phone: (852)26199663
Fax: (852)24815847

INDIA

Phone: 91-20-712 2048 ext: 2765
Fax: 91-20-712 1558

BOMBAY

Philips India
Customer Relation Centre
Bandbox House
254-D Dr. A Besant Road, Worli
Bombay 400 025

CALCUTTA

Customer Relation Centre
7 justice Chandra Madhab Road
Calcutta 700 020

MADRAS

Customer Relation Centre
3, Haddows Road
Madras 600 006

NEW DELHI

Customer Relation Centre
68, Shivaji Marg
New Dehli 110 015

INDONESIA

Philips Group of Companies in Indonesia
Consumer Information Centre
Jl.Buncit Raya Kav. 99-100
12510 Jakarta
Phone: (021)-7940040 ext: 2100
Fax : (021)-794 7511 / 794 7539

KOREA

Philips Korea Ltd.
Philips House
C.P.O. box 3680
260-199, Itaewon-Dong.
Yongsan-Ku, Seoul 140-202
Phone: 080 600 6600 (toll free)
Fax : (02) 709 1210

MALAYSIA

After Market Solutions Sdn Bhd,
Philips Authorised Service Center,
Lot 6, Jalan 225, Section 51A,
46100 Petaling Jaya,
Selangor Darul Ehsan,
Malaysia.
Phone: (603)-7954 9691/7956 3695
Fax: (603)-7954 8504
Customer Careline: 1800-880-180

PAKISTAN

Philips Consumer Service
Mubarak manzil,
39, Garden Road, Saddar,
Karachi-74400
Tel: (9221) 2737411-16
Fax: (9221) 2721167
E-mail: care@philips.com
Website: www.philips.com.pk

PHILIPPINES

PHILIPS ELECTRONICS & LIGHTING, INC.

Consumer Electronics

48F PBCOM tower

6795 Ayala Avenue cor VA Rufino St.

Salcedo Village

1227 Makati City, PHILS

Phone: (02)-888 0572, Domestic Toll Free: 1-800-10-PHILIPS or 1-800-10-744 5477

Fax: (02)-888 0571

SINGAPORE

Accord Customer Care Solutions Ltd

Authorized Philips Service Center

Consumer Service

620A Lorong 1 Toa Rayoh

Singapore 319762

Tel: +65 6882 3999

Fax: +65 6250 8037

TAIWAN

Philips Taiwan Ltd.

Consumer Information Centre

13F, No. 3-1 Yuan Qu St., Nan Gang Dist.,

Taipei 115, Taiwan

Phone: 0800-231-099

Fax : (02)-3789-2641

THAILAND

Philips Electronics (Thailand) Ltd.

26-28th floor, Thai Summit Tower

1768 New Petchburi Road

Khwaeng Bangkokkapi, Khet Huaykhwang

Bangkok10320 Thailand

Tel: (66)2-6528652

E-mail: cic Thai@philips.com

Africa

MOROCCO

Philips Electronique Maroc
304,BD Mohamed V
Casablanca
Phone: (02)-302992
Fax : (02)-303446

SOUTH AFRICA

PHILIPS SA (PTY) LTD
Customer Care Center
195 Main Road
Martindale, Johannesburg
P.O. box 58088
Newville 2114
Telephone: +27 (0) 11 471 5194
Fax: +27 (0) 11 471 5123
E-mail: phonecare.za@philips.com

Middle East

DUBAI

Philips Middle East B.V.
Consumer Information Centre
P.O.Box 7785
DUBAI
Phone: (04)-335 3666
Fax : (04)-335 3999

Free Manuals Download Website

<http://myh66.com>

<http://usermanuals.us>

<http://www.somanuals.com>

<http://www.4manuals.cc>

<http://www.manual-lib.com>

<http://www.404manual.com>

<http://www.luxmanual.com>

<http://aubethermostatmanual.com>

Golf course search by state

<http://golfingnear.com>

Email search by domain

<http://emailbydomain.com>

Auto manuals search

<http://auto.somanuals.com>

TV manuals search

<http://tv.somanuals.com>