

# DAT850

GB

Digital audio tape deck

F

Platine à cassette audio numérique

D

DAT-Deck

NL

DAT-deck

I

Registratore DAT

English page3

Français page26

Deutsch seite49

Nederlande pagina72

Italiano pagina95

## FEATURES

1. **Five 2-channel modes**
  - 48 kHz mode: Sampling frequency of 48 kHz, 16-bit linear quantization
  - 44 kHz mode: Sampling frequency of 44.1 kHz, 16-bit linear quantization
  - 32 kHz mode: Sampling frequency of 32 kHz, 16-bit linear quantization
  - 32 kHz LP (Long Play) mode: Sampling frequency of 32 kHz, 12-bit non-linear quantization
  - 44 kHz WT (Wide Track, playback only) mode: Sampling frequency of 44.1 kHz, 16-bit linear quantization
2. **SCMS (Serial Copy Management System)**
  - Only one digital recording can be made of CD software
3. **High-precision fine-tracking digital servo mechanism**
  - Philips's high-precision mechanism makes possible the LP (Long Play) mode
4. **Fourth-order delta sigma type 1-bit ADC (Analog to Digital Converter)**
5. **1-bit DAC (PEM DD converter)**
6. **AUTO ID EDIT function**
  - The optimum START ID position is automatically shown in the display
7. **Sampling monitor facility**
8. **20-dot digital meter (with peak hold function)**
  - The digital peak display shows the margin
9. **Tray type cassette loading**
10. **Direct access playback with 10-key remote control**
11. **Separate sub code keys**  
(with Renumber function)
12. **10-key wireless remote control**
13. **Digital input/output terminals (Coaxial/Optical)**
  - Meeting digital audio interface standards
14. **SOURCE selector (Digital/Analog)**

### • Types of DAT cassettes

Mode	Maximum recording time	
	48k/44k/32k mode	32k-LP mode
Cassette		
R-120	2 hours	4 hours
R-90	1h.30 min.	3 hours
R-60	1 hour	2 hours
R-46	46 minutes	1h.32 min.

### Notes:

1. Cassettes recorded in the 32k-LP mode by this unit cannot be played back using DAT decks exclusively for the 48k or 32k mode.  
The 44k-WT mode is used only when DAT prerecorded tapes made from master tapes by the contact printing process are played.
2. DAT: abbreviation of Digital Audio Tape  
LP: abbreviation of Long play  
WT: abbreviation of Wide track

## REMOTE CONTROL SYSTEM

This is a convenient system which has been originated and developed by Philips. Before starting operation, connect the remote cable as shown on page 7. The followings are the brief explanation of its major performances:

### Synchronized Recording

Synchronized recording refers to the process in which the DAT deck starts recording in synchronism with the CD player.

Please study these instructions carefully before starting to operate the unit, to use the unit correctly. We take no responsibility for any problems resulting from misuse of this unit if it is operated by methods other than those given in this manual.

### On operating this unit:

Since this unit incorporates a microprocessor which controls various functions, please read the description and cautions (notes) for each item carefully before use.

If operated incorrectly, the required functions may not be performed. In this case, turn the power OFF then turn it ON again and see if correct operation has become possible.

### Important note for users in U.K.:

The U.K. version is not fitted with a mains plug.

When fitting a mains plug to the mains lead note that the wires in the mains lead are coloured with the following code: Blue = Neutral, Brown = Live.

As these colours may not correspond with the colour markings identifying the terminals in your plug proceed as follows: the Brown wire must be connected to the terminal which is marked with the letter L or coloured Red.

The Blue wire must be connected to the terminal which is marked with the letter N or coloured Black.

Note: This apparatus must be protected by a 3 Amp Fuse if a 13 Amp plug is used or, if any other type of plug is used, by a 5 Amp Fuse either in the plug or adapter or at the distribution board. If in doubt consult a qualified electrician.

DO NOT CONNECT EITHER WIRE TO THE EARTH TERMINAL IN THE PLUG WHICH IS MARKED BY THE LETTER E OR BY THE SAFETY EARTH SYMBOL OR COLOURED GREEN OR GREEN - AND - YELLOW

# CAUTIONS

## 1. Safety hints

1. Be sure to pull the plug, not the cord. (Fig. 1)
2. Do not handle the power cord with wet hands.
3. Do not damage the power cord. (Fig. 2)
4. If the deck is not to be used for an extended period, unplug the power cord.
5. Do not remove the cabinet. To avoid electric shocks, do not touch parts inside the deck. Consult a dealer for repairs.
6. Do not permit any liquids or objects to get inside the deck. The deck could be damaged if water or flammable or metallic objects get inside.

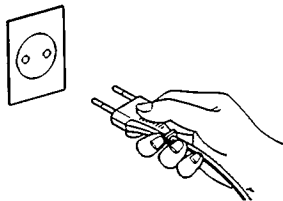

Pull the plug when disconnecting the cord.

### Note:

This diagram does not represent a U.K. mains plug.

Fig. 1

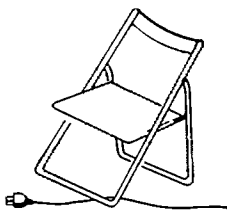

Take care not to damage the power cord.

Fig. 2

## 2. Installation

1. Avoid placing the unit on or adjacent to an amplifier, to prevent hum which is produced by some types of amplifiers. Move the unit to a place where it will not be affected by the amplifier. Keep the unit as far as possible from a TV set.
2. Avoid installing the unit in a location subject to excessively high temperatures (e.g. direct sunlight, near a heater, etc.), excessive humidity, dust, vibrations or magnetic fields.

## 3. Cleaning the heads

If this unit is used for a long period of time, its heads will become dirty. When they become excessively dirty, recording and playback will not be satisfactory. Because of this, clean the heads every 30 hours of playing time with a cleaning cassette available from your audio store.

**Press the ●/○ REC and ► PLAY buttons then, after another 10 seconds, press the ■ STOP button.**

## 4. Volume setting

In DAT, digital signals are recorded and played back; because of this, it is difficult to set the appropriate volume using the level of noise as a reference. Do not raise the volume excessively even if the beginning of a tune seems quiet. Otherwise, when the level of the sound rises, it could damage the speakers or other equipment.

## 5. Condensation

1. If condensation forms on the head drum, the heart of a DAT unit, the tape may stick to the head drum and may be damaged.
2. Condensation may occur in the following cases:
  - When the unit is moved from a cold place to a warm place.
  - In a room immediately after its heating has been switched ON, or in a place where the deck is exposed to cold air from a cooler.
  - In a place which is excessively humid.
3. When condensation could have occurred in the DAT deck such as when it is moved from a cold place to a warm place, turn the POWER switch ON and leave it for about one hour before using it.

When condensation is likely to occur, do not leave a cassette in the deck. It is recommended that you always remove cassette tapes from the deck when it is not in use.

  - Use the deck where the ambient temperature is from 5°C(41°F) to 35°C(95°F).

When the deck is used in a cold place, condensation may occur more frequently.

## 6. Timer switch setting

Set the TIMER switch to "REC" or "PLAY" when performing timer recording or playback. At other times, be sure to set the TIMER switch to OFF.

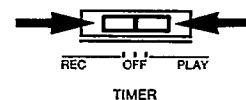

## 7. Heat radiation

Be careful not to block the ventilation holes so that the temperature inside the deck does not rise excessively. Do not install the unit in a badly ventilated place.

## SELECTING THE AC SUPPLY VOLTAGE

When this deck is used in an area where the supply voltage is different from the preset voltage, reset the voltage selector to the correct position.

Slide the voltage selector with a screwdriver so that the desired voltage marking is in the window.

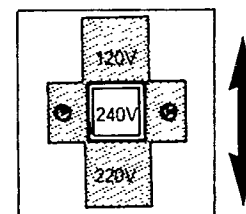

### Caution:

Disconnect supply cord before changing the voltage.

## NAMES OF PARTS AND THEIR FUNCTIONS (Refer to page 118.)

### ● Front panel

#### ① ON/OFF switch

#### ② Cassette tray

#### ③ REMOTE SENSOR

Receives infrared signals transmitted from the remote control unit.

#### ④ Sub code buttons

- Start ID erase (ERASE)
- START ID
- END/RENUMBER

Press during recording to record the End code.

If pressed in the stop mode, it is possible to set new program numbers.

- AUTO ID EDIT

#### ⑤ Display window

- Ⓐ Start ID detect/memory/erase indicator
- Ⓑ RENUMBER indicator
- Ⓒ Program number indicator (PRGM NO)
- Ⓓ Absolute time indicator (A TIME)
- Ⓔ Mode indicator
- Ⓕ Sampling frequency indicator
- Ⓖ Digital input indicator (DIGITAL INPUT)
- Ⓗ Tape/sampling monitor indicator (TAPE SAMPLING MONITOR)
- ① REPEAT indicator
- ② 32k-LP mode indicator
- Ⓚ Next number indicator (NEXT NO)
- ① Level meter indicators
- Ⓜ Digital counter
- ① Copy prohibit indicator (COPY PHBT)
- Ⓞ Emphasis indicator (EMPHASIS)
- Ⓟ Digital peak display

- When the following operations are performed, these indications are displayed.

**TOP:** When the deck is set to the rec-pause mode or rec mode at the beginning of tape.

**-00:01:** After TOP has been displayed and a tape is recorded and then rewound, this is displayed.

**EE:** When an End code is detected or recorded, the deck stops automatically and this is displayed.

**no TAPE:** When the cassette tray is closed without a cassette tape loaded.

#### ⑥ REPEAT button

Used to repeat all the tunes on the tape.

#### ⑦ DISPLAY button

Used to select the mode of the display.

When the power is first switched on, "A TIME" (absolute time) is displayed. Every time this button is pressed, the display alternates between the counter mode and "A TIME".

#### ⑧ Tape counter reset button (RESET)

#### ⑨ REC LEVEL control (Analog)

Adjust the recording level with this control.

The inner knob is for the left channel and the outer knob, the right channel.

#### ⑩ TIMER switch

Used when timer recording or playback is to be performed using an audio timer. Normally set to the OFF position.

#### ⑪ SOURCE switch

Set to according to the type of input signal. (Analog/optical/coaxial).

#### ⑫ REC TIME switch

Select the recording time in different recording modes.

Recording mode Switch position	Analog recording	Digital recording	
	Standard (STD)	48k mode	32k mode
LONG	32k-LP mode	32k-LP mode	

- The REC TIME switch is not used when recording a digital signal in the 48k and 44k modes. The source signal is recorded as it is.

#### ⑬ Tape operations buttons

- /▲ STOP/OPEN-CLOSE:

Press to stop the tape.

Press to open and close the cassette tray.

#### PREVIOUS/AUTO SEARCH: NEXT

Used to designate the number of tunes.

#### REWIND/SEARCH: WIND

When pressed in the stop mode, the fast-forward or rewind operation starts, and speeded-up sound can be heard at a lower level (cue, review function).

#### ▶ PLAY:

Press to start recording and playback.

#### ■ PAUSE:

Press to stop the tape temporarily.

To release this mode, press the ▶ PLAY button.

#### ●/○ REC/REC MUTE:

When recording, press the ▶ PLAY button while pressing this button. To enter the "rec-pause" mode, press together with the ■ PAUSE button. When this is pressed during recording, the rec mute operation is engaged.

#### ⑭ PHONES jack and PHONES LEVEL control

### ● Rear panel

#### Ⓐ ANALOG (LINE) IN/OUT terminals

(Refer to page 7.)

#### Ⓑ REMOTE INTERNAL/EXTERNAL switch

Set this switch to INTERNAL when using this unit alone, and set to EXTERNAL when using this unit together with other component, which bears "RC-5" logo and is equipped with a remote sensor, such as the Philips amplifier.

#### Ⓒ REMOTE CONT. terminals

When connected to a CD player, cassette deck or amplifier with REMOTE CONT. terminals using the remote cable and synchro recording are possible.

(Refer to page 7.)

#### Ⓓ DIGITAL OPTICAL IN/OUT terminals

Connect to an amplifier with optical digital in/out connectors using exclusive optical fiber cables.

#### Ⓔ DIGITAL COAXIAL IN/OUT terminals

Connect to an amplifier with coaxial digital in/out connectors using coaxial connecting cables (75 ohms).

#### Ⓕ Voltage selector

#### Ⓖ AC cord

# REMOTE CONTROL OPERATIONS

## Correct use of the remote control

- Press the button(s) while pointing the top of the remote control unit at the remote sensor on the front panel of the main unit.
- The operable range is about 7 meters away from the main unit. If operated at an angle, the range will be shorter.
- Do not allow direct sunlight or strong light from a fluorescent light, etc. to strike the remote sensor, as far as possible.

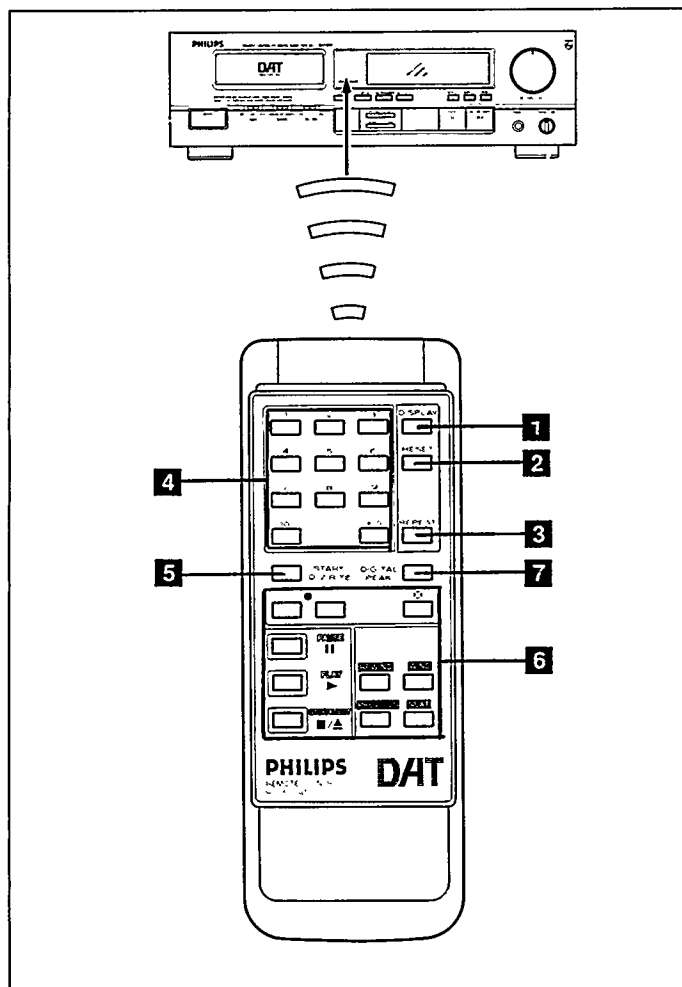

## Name of parts and their functions

- 1 DISPLAY button**
- 2 RESET button**
- 3 REPEAT button**
- 4 Numeric keys ("1" — "10", "+10")**  
Used to designate the desired tune directly.
- 5 START ID-WRITE button**  
Used to write a start ID.
- 6 Tape operations buttons**
- 7 DIGITAL PEAK button**  
Used to recall or reset the maximum value stored in the digital peak memory.

\* Other control buttons have the same functions as those on the front panel of the main unit.

## Battery replacement

1. Open the battery compartment cover.
2. Insert two "R03" batteries.
3. Close the battery compartment cover.

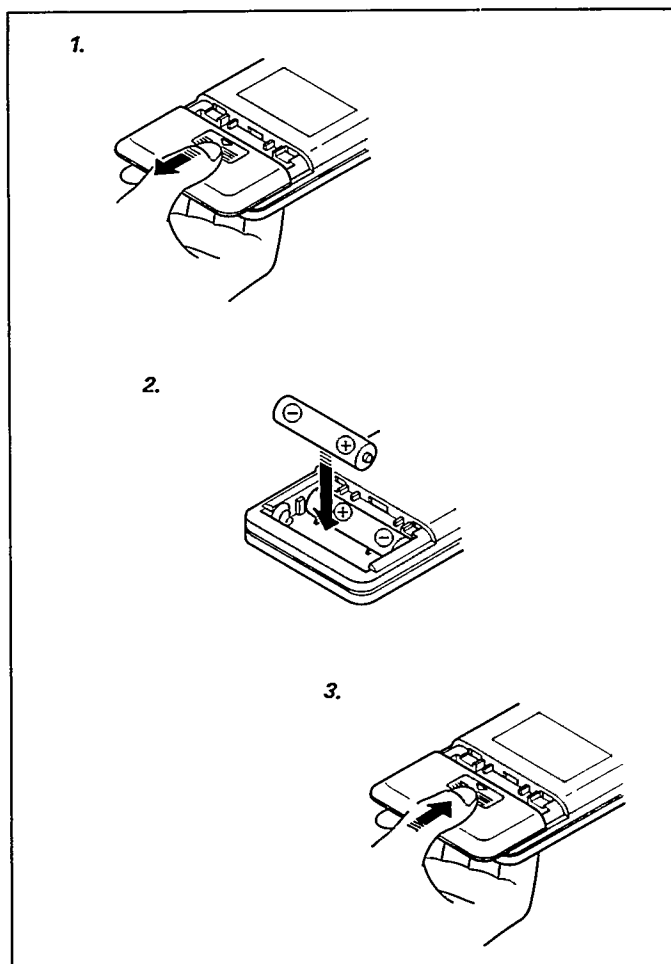

### Notes:

1. When the distance from which the remote control unit is effective becomes shorter, the batteries are almost exhausted. Replace the batteries with new ones.
2. Be sure to use two "R03" batteries in the remote control. Incorrect use of batteries may cause corrosion or an explosion.
  - Insert the batteries into the battery compartment with correct positive (+) and negative (-) polarities.
  - Do not use old and new batteries together.
  - When the unit is not to be used for an extended period of time, remove the batteries to prevent damage due to corrosion.

# CONNECTIONS

- Do not switch the power on until all connections are completed.
- Insert the plugs firmly; poor contact can cause noise.
- When RCA pin-plug cords are employed, always connect the white plug to the left channel terminal. This helps avoid reversed connections.

## 1. Connection to stereo components (Analog signal lines)

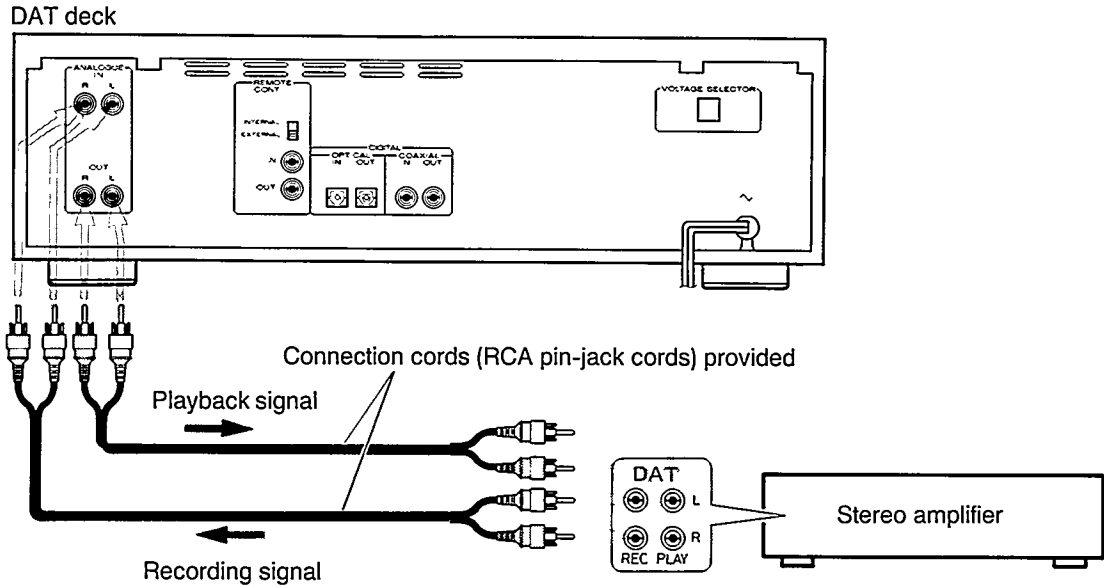

- When the stereo amplifier is not provided with DAT terminals, refer to its instruction manual.

## 2. Remote cable connection for REMOTE CONT.

- By connecting a remote cable, REMOTE CONT. functions (synchro recording) can be performed.
- When making synchro recordings with a CD player, connect the remote cable to the REMOTE CONT. jacks.

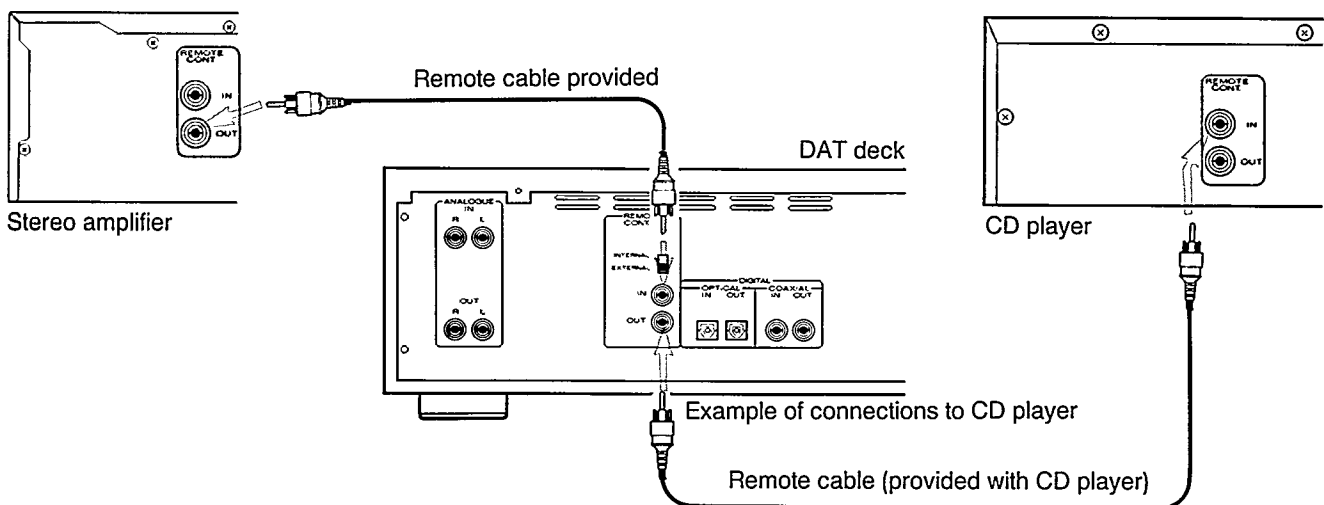

- Connect the REMOTE CONT. jack of the deck to the REMOTE CONT. jack of the amplifier using the remote cable provided.

### Note:

When installing this unit, leave an appropriate distance between it and your stereo amplifier, tuner and television set. If they are too close, noise (induced hum) may occur. We recommend that you use outdoor FM and TV antennas.

### 3. Connections to stereo components (Digital signal lines)

- To transmit digital signals between the DAT deck and an amplifier with digital in/out terminals exclusively for DAT, use the DIGITAL IN/OUT terminals on the rear panel of the deck. For the transmission of digital signals, two types of cables can be used; COAXIAL (for electrical signals) and OPTICAL

(for optical signals). Either of these can be used for digital signal transmission.

- With digital signals, only one cable is used for the transmission of both the left and right channel signals.

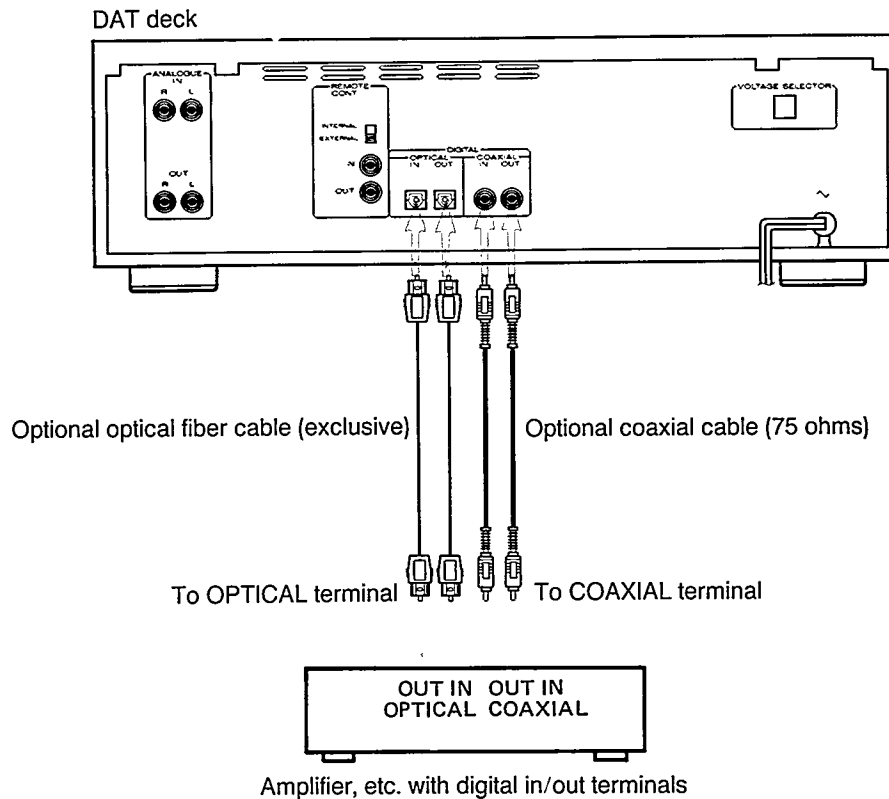

#### • OPTICAL connection

Remove the caps from the OPTICAL terminals and connect the DIGITAL OPTICAL IN/OUT terminals to the amplifier, etc. using exclusive optical fiber cables.

#### Note:

Clean the tip of the plug of the optical cable before connecting it.

#### • Synchro recording with CD player

When making a synchro recording with a CD player, as well as connecting the optical fiber or coaxial cable, perform the following connections.

1. Connect the REMOTE CONT. terminals with the remote cable. (See page 7.)
2. Connect the OUTPUT terminal (analog) of the CD player and the ANALOG IN terminal with a RCA pin cord.

#### • Red light in the OPTICAL OUT terminal:

When the power is turned on, a red light appears inside the terminal. This is used to transmit the digital signal. Although it is not dangerous even when it strikes the eyes directly, do not remove the cap covering the terminal when not in use.

#### Notes:

1. When a digital program is encoded with a "copy prohibit" code (except in case of SCMS), it cannot be copied digitally. To copy such a program, perform analog connection. (Refer to page 12.)
2. Never connect the digital coaxial cable to the analog input terminals of an amplifier, etc. as this could seriously damage the amplifier.
3. When the OPTICAL terminals are used for digital connection, check that the optional exclusive optical fiber cables can be inserted into the terminals of the amplifier.
4. Do not bend optical fiber cable sharply. For details, refer to its instructions.
5. When both the ANALOG and COAXIAL terminals of the DAT deck are used for the connection of certain components (amplifiers, tuners, cassette decks, etc.), noise (induced hum) may occur. In this case, disconnect any unused IN/OUT terminals.



# DAT CASSETTES

## Concerning DAT cassettes

- Use cassette tapes with the DAT logotype shown here.



- When a tape on which a recording has previously been made is used for recording, the previously recorded signals will be erased automatically, and the tape will contain only the new recording.

- DAT cassettes have sliding safety tabs to prevent accidental erasure. Be sure to open the tabs of cassettes containing important recordings which you want to protect against accidental erasure.



Recording is impossible when this is opened.



Recording is made possible again when it is closed.

- DAT cassettes cannot be used upside down.
- DAT cassettes have a lid (cover) to prevent the accumulation of dust or dirt on the surface of the tape. Do not open this forcibly.

- DAT cassette shells are constructed so that the tape cannot be touched by accident.

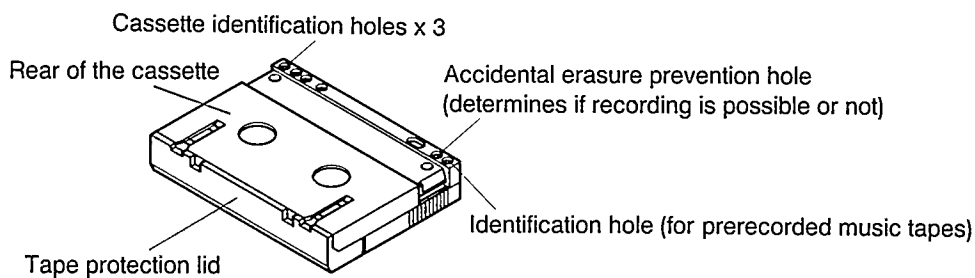

## Cautions on storage of DAT cassettes

- Do not leave cassettes in a place exposed to direct sunlight or near a heater, etc.
- Do not leave cassettes in a place subject to excessive humidity.
- Do not drop cassettes or expose them to excessive vibrations or shocks.

- Do not leave cassettes in a place subject to excessive dust.
- Do not store cassettes where there is a strong magnetic field, such as near a motor, transformer or permanent magnet, etc.
- When not using them, always replace cassettes in their plastic cases.

## Loading DAT cassettes

1.

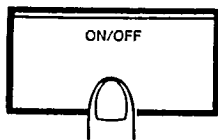

2.

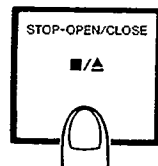

3. With the cassette's window facing up

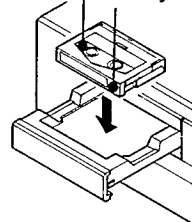

4.

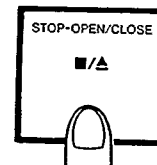

1. Set the ON/OFF switch on.
2. Press the ■ / ▲ STOP/OPEN-CLOSE button to open the cassette tray.
3. Insert the cassette with its window facing up.
4. Press the ■ / ▲ STOP/OPEN-CLOSE button to close the cassette tray.

# SUB CODES

"Sub codes" are codes recorded on the tape separately from the music signals. They are mainly used to provide various functions which make the DAT system more convenient. These codes are necessary for search operations (direct access playback), etc.

## Types of sub codes and details

Name		Details	Functions
Information data	A TIME	Shows the elapsed recording time from the beginning of the tape. (Absolute Time)	The absolute time is marked together with the music signal and allows the elapsed time from the start of tape to be displayed.
	PRGM NO	Shows the tune number, counting from the beginning of the tape. (Program Number)	With this code, direct access playback using the remote control unit is possible.
ID (Identification) Data	START ID	Indicates the beginning of a tune	Using the AUTO SEARCH buttons, the beginning of any tune can be found easily.
	END code	Indicates the point at which the previous recording ended.	When a tape is played back or fast forwarded, the deck stops automatically at the beginning of the End code.

## Relationship between the music signal and sub codes

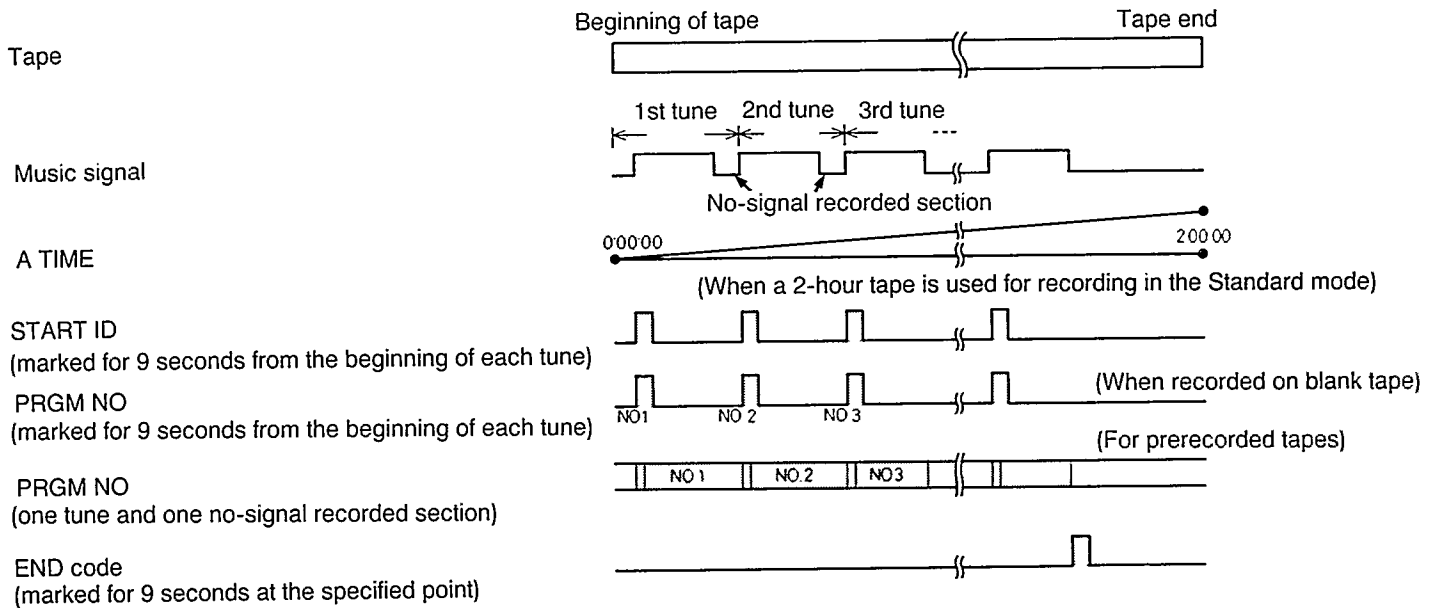

- The sub code recording time shows the time when the tape is recorded in the 48k, 44k or 32k mode. When recorded in the 32k-LP mode, the recording time will be doubled.

### Note:

When the deck is set to the 32k-LP mode, the A TIME is marked at half the speed compared with other modes. This is to match the A TIME and the position of the tape with a one-to-one relationship.

# TECHNICAL INFORMATION ABOUT DAT

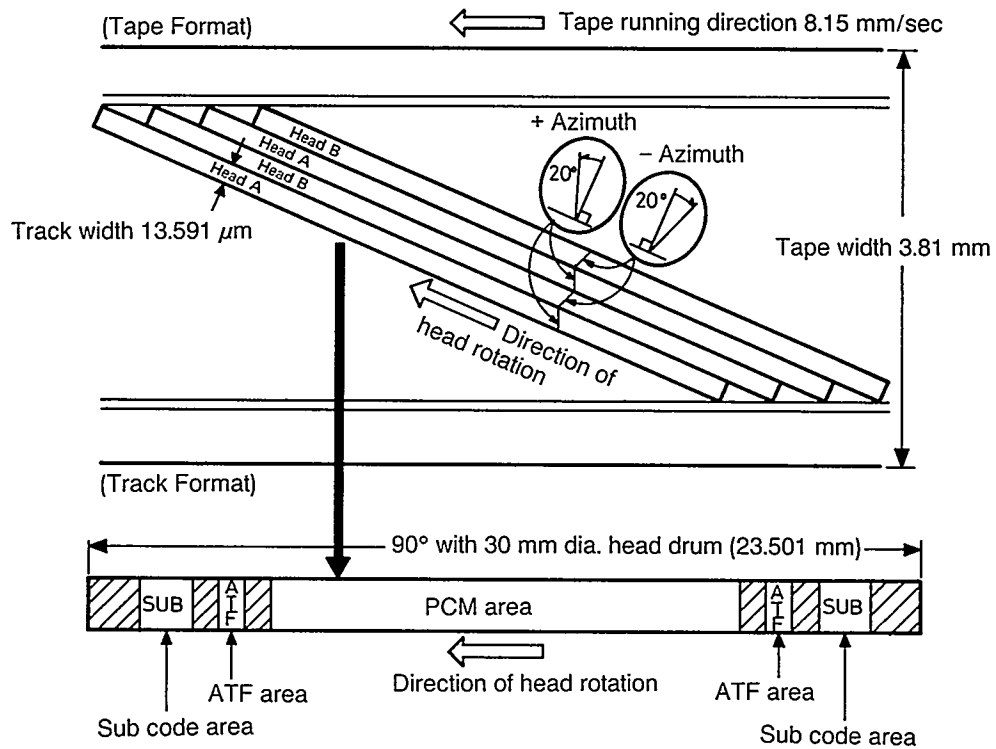

## DAT recording system

- In a DAT deck, heads mounted in the head drum rotate at high speed to record digitally-encoded signals on the tape at an angle to the tape. This system is called "helical scanning".
- **PCM (music signal) area:**  
Digitally-encoded music signals are recorded in this area.
- **ATF (Automatic Track Finding) area:**  
This area is used for recording ATF signals which control the heads so that they trace the recorded signal for accurate and stable tracking and the correct signals are picked up by the rotating heads.
- **Sub code area:**  
This area is for recording the signals which enable various functions such as high-speed search and editing. With the DAT850, A TIME (absolute time), Program No., Start ID and End codes can be recorded.

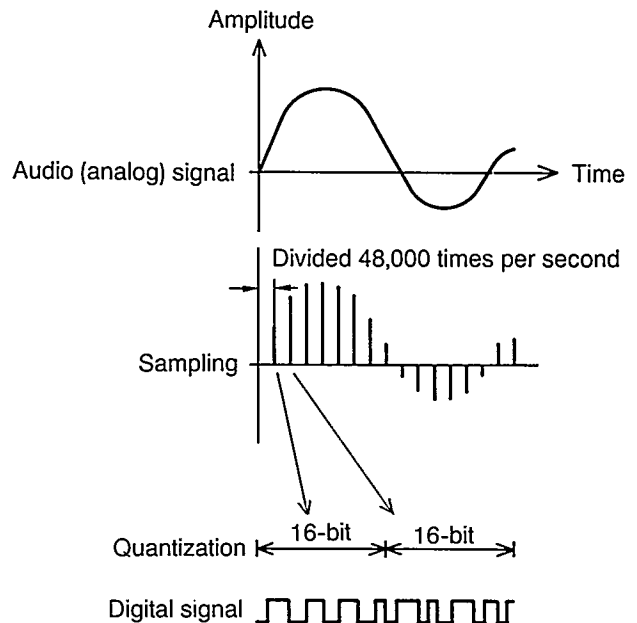

## Digital signal processing

- **Digital recording in the 48 kHz standard mode**  
Signals are converted from analog to digital before being recorded. This is called A/D conversion.

1. The amplitude of the analog audio signal to be recorded is detected 48,000 times per second by "slicing" the signal. This is called "sampling at a frequency of 48 kHz".
  2. The length of each slice is rearranged as 16 data bits. This is called "16-bit quantization".
  3. Each quantized signal is encoded as a binary number (0s and 1s) for digital recording.
- **Digital playback**  
The quantized digital signals recorded on the DAT tape are reconverted to analog signals through a D/A converter which performs the reverse operations to those performed in A/D conversion.

## SCMS (Serial Copy Management System)

- SCMS controls the DAT's serial copy with the digital signal.

It is possible for a SCMS-compatible DAT deck to record digital sources including CDs, DAT prerecorded tapes, DSR (Digital Satellite Radio) programs onto DAT tape with a direct digital input. For sources such as CDs, DAT tapes and DSR programs covered by SCMS regulations, copy-permitted programs can be recorded on DAT tape whether or not they contain a copy-prohibit code. When the copied (recorded) tape is played back

by a DAT deck and the digital output is input to the another DAT deck, digital recording can be performed if there is no copy prohibit code, however, digital recording cannot be performed if there is a copy prohibit code. Namely, one — and only one — copy can be made of a digital source with a copy prohibit code, and second-generation, third-generation and serial copying is not possible. SCMS applies in any DAT mode, regardless the sampling frequency. The following illustrations show the principles of the SCMS system.

### • Copying digital sources

With copy prohibit code

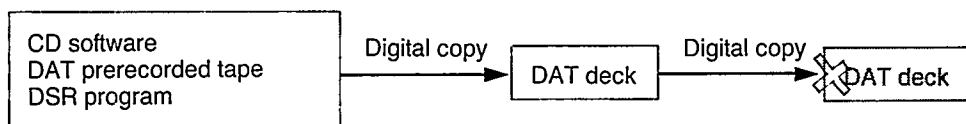

Without copy prohibit code

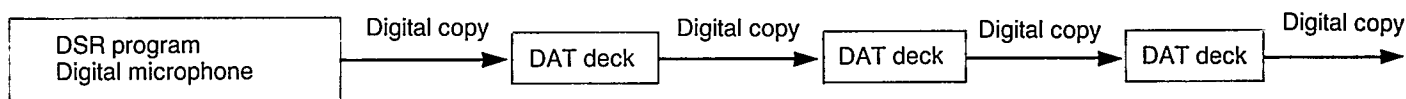

Whether there is the copy prohibit code or not

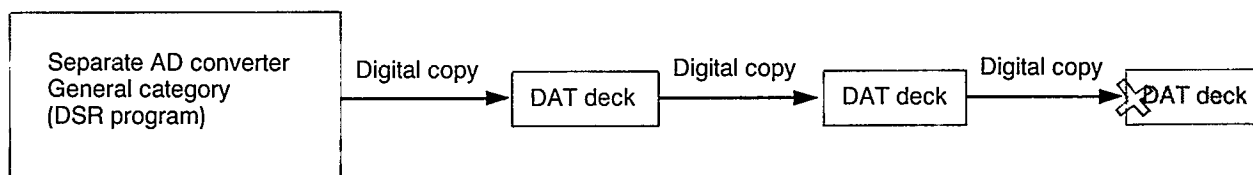

### • Copying analog sources

When an analog signal is input, this signal can be recorded by a DAT deck because this signal does not contain a copy prohibit code. However, since the signal recorded on the tape

has passed through the A/D converter (ADC), the tape is treated as a DAT prerecorded tape which contains the copy prohibit code.

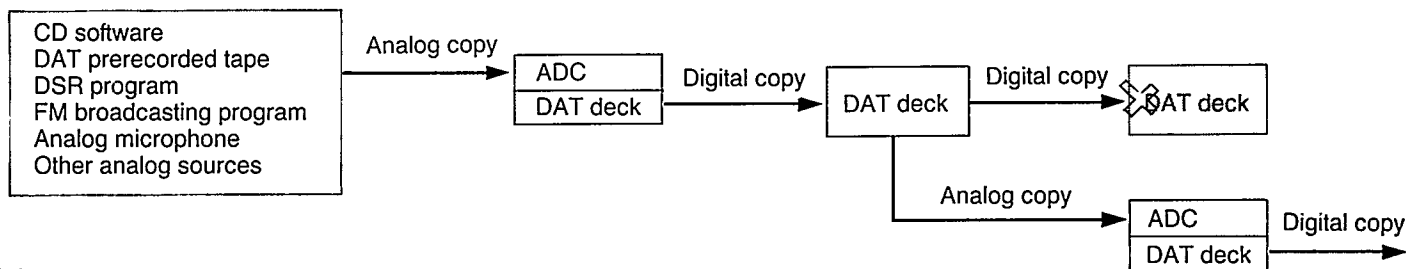

#### Note:

An A/D converter performs sampling and quantization to convert an analog signal into a digital signal. This signal processing is called "A/D conversion" and the circuit which performs it is called an A/D converter.

# RECORDING

Before performing recording:

- Make sure the safety tab of the cassette is closed.
- Set the TIMER switch to OFF before switching the POWER on.

It may be unlawful to record or playback copyrighted material without the consent of the copyright owner.

— Operate in numerical order. —

Set the ON/OFF switch to ON.

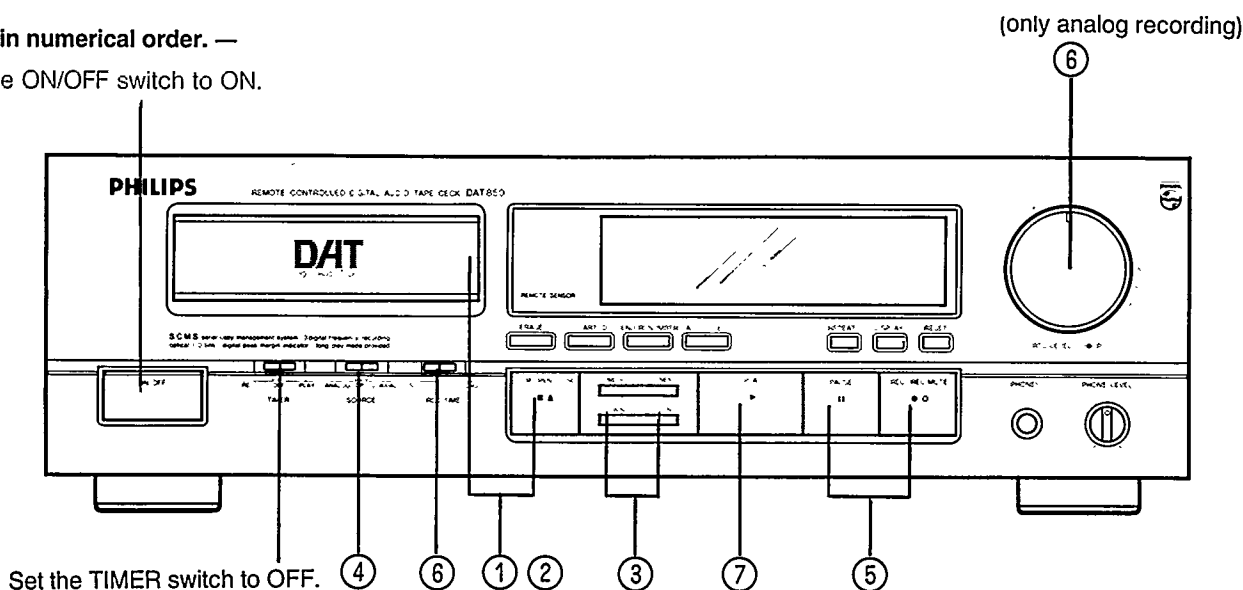

- 1 Press the ■/▲ STOP/OPEN-CLOSE button to open the cassette tray.
- 2 Insert a cassette with its window facing up.
- 3 Locate the position from which recording should start with the SEARCH buttons.  
REWIND: When recording is to start from the beginning of the tape.  
WIND : When recording is to start from the middle of the tape. (The End code is detected.)
- 4 Select the source to be recorded.  
ANALOG: When recording analog input signals  
OPTICAL or COAXIAL: When recording digital input signals
- 5 Set the deck to the rec-pause mode.  
• "SAMPLING MONITOR" lights.
- 6 Select the recording mode. When recording analog signals, adjust the recording level.

### Recording mode

REC TIME switch	Analog recording	Digital recording	
STD	48k mode	32k mode	48/44k mode
LONG	32k-LP mode	32k-LP mode	

- 7 Press the ► PLAY button to start recording.

### When recording a digital signal

The recording level, sampling frequency and emphasis status are recorded as they are. It is not necessary to adjust the recording level.

- For details about digital recording, see page 16.

### When the end of a tape is reached

With the auto rewind function, the tape is rewound to its beginning and stops automatically.

### Tape protection

When the cassette tray is closed, sometimes it will pop out again; this is to protect the tape. If this happens, adjust the position of the cassette and close the tray again.

### Notes:

1. When starting recording at the beginning of the tape, leave a no-signal recorded section of about 10 seconds.
2. "TOP" is displayed when the deck enters the rec-pause or rec mode after the tape has been rewound.

## Recording level adjustment

(only when an analog signal is to be recorded)

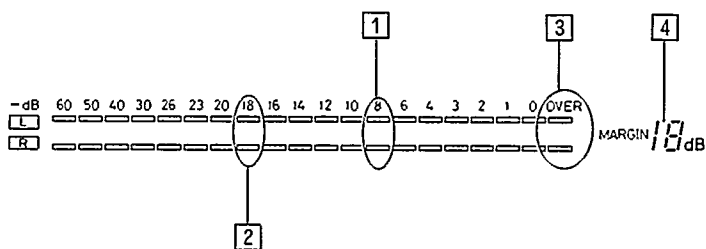

### Peak level meter and digital peak display:

- 1 **Peak level meter**  
Values higher than -40 dB will be displayed for the left and right channels independently, while peak values are held for approx. 2 seconds.
- 2 **Reference level indicator**  
Shows the reference input level of the DAT deck at a position -18 dB from the full-scale level.
- 3 **OVER level indicator**  
Lights when the recording level is too high.
- 4 **Digital peak display**  
Shows the margin between the maximum input level and the input level of the signal being recorded in 1-dB steps, within a range of -19 dB to 0 dB.

## Adjusting the recording level

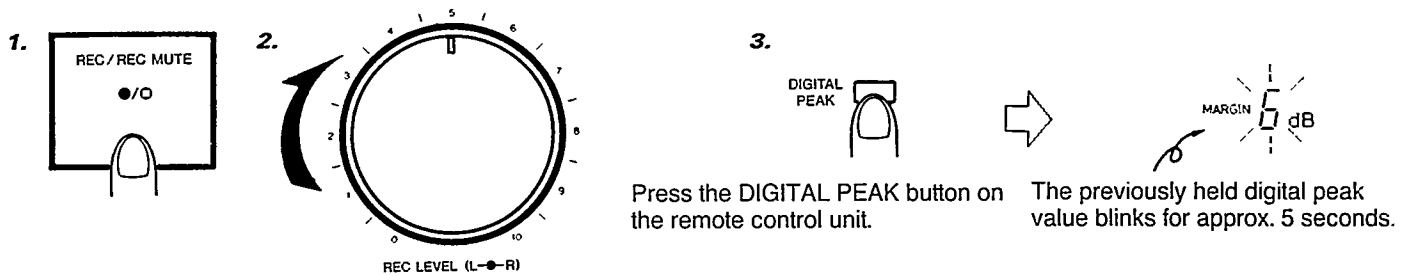

1. Press the **REC/REC MUTE** button. The deck enters the sampling monitor mode.
2. Adjust the recording level. Set the recording level by referring to the digital peak display. Adjust the maximum value of the recording level so that the OVER indicator does not light.
3. Check the digital peak level.

- While the previously held digital peak value is blinking, press the **DIGITAL PEAK** button again so that the new peak value is held in memory.

### • Sub code marking during recording

In the following case, the A TIME (absolute time), Start ID and Program No. codes will be marked automatically.

Sub code	Condition for automatic marking
A TIME	<ul style="list-style-type: none"> <li>• When recording starts from the beginning of the tape</li> <li>• When the previously marked A TIME is read and displayed</li> </ul>
Start ID	<ul style="list-style-type: none"> <li>• When the signal is input after the level of the input signal drops to a specified level (no-signal) for more than 3 seconds during recording.</li> <li>• When the first signal is input immediately after recording starts</li> </ul>
Program No. (tune No.)	<ul style="list-style-type: none"> <li>• When recording starts from the beginning of the tape</li> <li>• When the previously marked program No. is read out and displayed</li> </ul>

### • To stop recording

Press the **END** button so that the End code is marked. This makes it easy to locate the position where next recording should be started; the A TIME codes marked in the new recording are continuous from those marked in the previous recording.

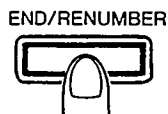

### Notes:

1. If the recording level is set to a value where the OVER level indicator lights continuously, the recording signal will saturate the tape and the sound will be distorted. Decrease the recording level to a level at which the OVER level indicator does not light.
2. Emphasis  
With emphasis, high-frequency signals are recorded after increasing their level (preemphasis); during playback this process is reversed (deemphasis). This improves the S/N ratio at higher frequencies.  
This deck incorporates only a deemphasis circuit, so it is possible to play back signals which were recorded with emphasis, however, it is impossible to record signals applying emphasis.

## Record muting

This is used to leave an appropriate no-signal recorded section between tunes.

1. When a section of the source you do not want to record is reached during recording, press the **●/○ REC/REC MUTE** button then release it. The REC indicator blinks and a no-signal recorded section is left during record muting operation.

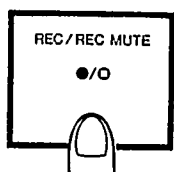

Press and release it.



No-signal recorded sections are left.

- About 4 seconds later, the REC and PAUSE indicators light and the deck enters the rec-pause mode.

2. Press the **▶ PLAY** button to start recording again.

### To leave a no-signal recorded section of more than 4 seconds

Keep the **●/○ REC/REC MUTE** button pressed continuously as long as you want to leave a no-signal recorded section. When the button is released after the above operations, the deck enters the rec-pause mode.

- A TIME codes will be written continuously even when the rec-mute mode is engaged.

### To make recordings in different recording modes on one tape

Be sure to leave a no-signal section before starting recording in the new mode.

Example: To change the recording mode from 48k to 32k-LP

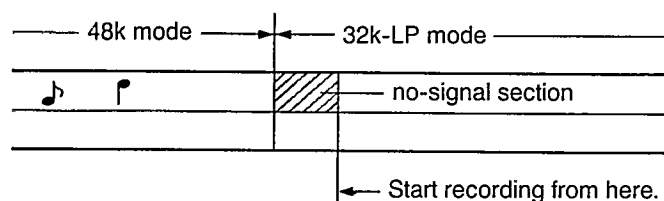

1. Set the deck to the rec-pause mode.
2. Change the recording mode.
3. Press the **●/○ REC/REC MUTE** button.
  - After 4 seconds, the deck enters the rec-pause mode. Press the **▶ PLAY** button to start recording.

### Note:

When making a recording, if you change the recording mode (48k, 44k, 32k or 32k-LP) in the middle of a tape, be sure to leave a no-signal section using the Record Mute function, etc. before starting recording in the new mode.

## Synchronized recording with the CD player

Preparation: Connect the connecting cord to the REMOTE CONT. jack on the CD player beforehand.

1. Insert the cassette tape. Set the desired starting point of the tape for recording.
2. Press the **●/○ REC/REC MUTE** and the **⏸ PAUSE** buttons simultaneously to enter "REC/PAUSE" mode.
  - The DAT deck should be operated from the stop mode.
3. Set the TIMER switch to PLAY.
4. Press the PLAY button of the CD player.
  - Recording in the programmed order is possible if the desired tracks have been programmed beforehand.

On completion of the above procedures, the recording to the DAT deck starts automatically and the recording is carried out.

The DAT deck enters stop mode automatically when the play of the CD player is over.

## Blank search

- This is used to locate the point in the middle of a tape where the previous recording ended, so a new recording can be made from that position.

1. Load a cassette and press the WIND button.

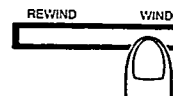

2. When the End code is detected, the deck stops automatically.

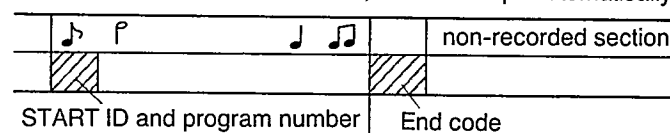

The tape is automatically rewound to the beginning of the End code and stops there.

PRGM NO  
EE

- When an End code is not marked, the deck automatically stops just before the non-recorded section of the tape.
- If new tape is loaded, the tape is first fast-forwarded and after 5 seconds, the tape is rewound.

● **Non-recorded sections (blank) and no-signal recorded sections**

In DAT decks, a non-recorded section (blank section) refers to that part of the tape which has not yet been used for recording; this distinguishes it from a no-signal recorded section, which has been used for recording but without a music signal.

In conventional compact cassette tapes, no-signal sections are left between tunes, however, in DAT cassettes, the track pattern is encoded and A TIME codes and other signals are encoded continuously in the sub code area.

**Note:**

To make a non-recorded tape, adjust the INPUT LEVEL controls to "MIN", then start recording. The previously recorded signal will be erased. New A TIME codes will be written to the tape.

**Digital recording**

- Check whether digital recording is possible or not referring to the DIGITAL INPUT indicator and the COPY PHBT indicator.

1. Set the SOURCE switch to COAXIAL or OPTICAL and check the DIGITAL INPUT indicator.

- When the source sound is input.

DIGITAL INPUT indicator	Digital signal is input or not
blinks slowly	not input
lights	input
blinks rapidly	input (recording is impossible)

- When the DIGITAL INPUT indicator blinks rapidly, digital recording cannot be performed. Set the SOURCE switch to ANALOG to perform analog recording. (The DIGITAL INPUT indicator goes off.)

2. Check the COPY PHBT indicator in the sampling monitor mode.

	DAT deck mode		Status of recorded tape
	during sampling monitoring	during recording	
COPY PHBT Condition of the indicator	not lit	not lit	Further digital copying is possible
	blinks	lights	Further digital copying is not possible
	not lit	blinks	Only one copy is possible

- If a source cannot be recorded, check the condition of the COPY PHBT indicator in the sampling monitor mode.

**Notes:**

1. When you attempt to record a source the digital recording of which is impossible, the deck enters the rec-pause mode automatically, and the DIGITAL INPUT indicator blinks rapidly.
2. When digitally recording some CDs, depending on the CD player used, sometimes the beginning of certain tunes will be cut or noise recorded. This is because the digital input signal is unstable and the DAT deck enters the rec-pause mode automatically when the mode of the CD player is changed. In this case, perform digital recording as follows:
  - ① Set the DAT deck to the rec-pause mode.
  - ② Locate the position slightly before that from which recording should start. Now start the CD player.
  - ③ Press the ► PLAY button of the DAT deck just before the required tune.



# SUB CODE MARKING

## Automatic Start ID and Program No. code marking

When recording is started from the beginning of a tape, the Start ID and Program No. codes will be marked automatically.

beginning of tape

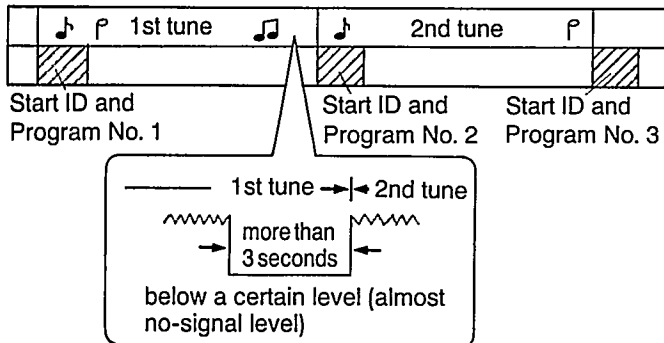

- When the signal drops below a certain level for more than 3 seconds between tunes, the next Start ID and Program No. codes are marked automatically.

### Notes:

1. When a very quiet sound (such as a pianissimo passage) continues for a relatively long time, Start ID and Program No. codes might be marked erroneously.
2. When the gap between tunes is less than 3 seconds, neither the Start ID nor Program No. codes will be marked.
3. When operating using the remote control unit, the ST-WRITE button has same function as the START ID button of the main unit.

## Manually marking Start ID and Program No. codes

The Start ID and Program No. codes are marked by pressing the START ID button during recording when the gap between tunes or no-signal portions is less than 3 seconds.

Press the START ID button at the beginning of a tune.

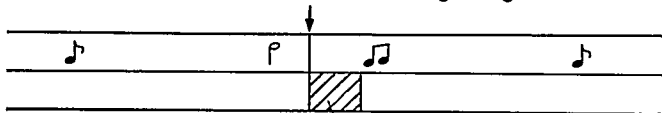

The Start ID and Program No. codes will be marked.

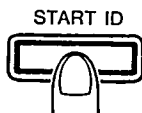

- With this operation, manual marking is possible anywhere you want Start ID and Program No. codes.
- When recording is to start from the middle of the tape, first rewind the tape to read the Program No. codes which have already been marked.

### Note:

Another Start ID code cannot be marked for 9 seconds after automatic or manual marking has been started. (When recording in the 32k-LP mode, this period becomes 18 seconds.)

## Marking the End code (Manual)

Be sure to mark the End code when you stop recording in the middle of a tape.

1. Press the END button at the end of recording.

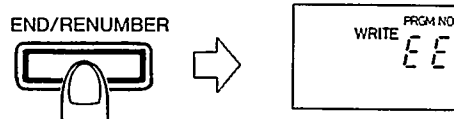

2. When the End code has been marked, the tape is rewound to the beginning of the End code and the deck stops automatically.

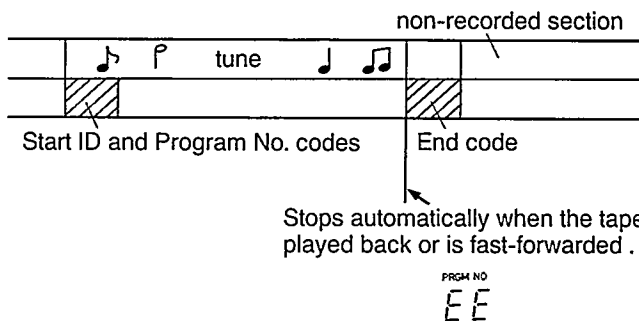

Stops automatically when the tape is played back or is fast-forwarded.

### Note:

The End code cannot be marked in the stop mode.

## Marking sub codes after recording

- **Outline of operation for marking sub codes after recording**  
We recommend that sub codes are marked after recording.

Operate as follows:

1. First play back the recorded tape and check that Start ID codes have been marked correctly at the beginning of each tune.
2. Delete unnecessary sub codes (Start ID codes).
3. Insert additional Start ID codes at the beginnings of any required tunes.
4. Mark the Start ID code using the AUTO ID EDIT function. (See page 19.)
5. Renumber the Program No. codes with the RENUMBER function. (See page 18.)

- When a Start ID is detected during playback, an indicator is displayed in the display window. Each time a Program No. or End code is detected, the PRGM NO changes.

### Note:

Marking the sub codes is impossible when the safety tab (accidental erasure prevention tab) is open. Check that the safety tab is closed if you want to mark sub codes after recording.

## Deleting sub codes

- To delete Start ID (Program No.) codes

1. Play the tape and locate unnecessary Start ID codes.

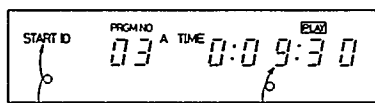

Start ID indicator When an unnecessary Start ID is marked at 9 minutes 30 seconds

2. Press the Start ID erase button while START ID is displayed.



Erase indicator

- The tape is rewound and stops at the beginning of the unnecessary Start ID code.
3. When an unnecessary Start ID code has been erased, the START ID indicator disappears and the tape stops automatically.
- The Program No. is also erased at the same time if it has been marked with the Start ID code.

### Deleting the End code

When recording starts after detecting the End code, the End code will be erased automatically.

## Marking Start ID codes

- This is used to mark Start ID codes at the required points.

1. Start playing the tape and find the point a Start ID code should be marked.

Example:

When marking a Start ID code at 28 minutes 30 seconds..

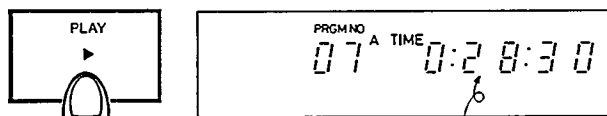

the position of 28 minutes 30 seconds

2. Press the START ID button.

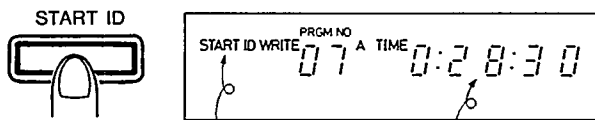

Indication while marking the Start ID code (when the Start ID code has been encoded) Recorded from an absolute time of 28 minutes 30 seconds

3. When marking is finished, the "START ID WRITE" indicator goes out.

Repeat the above procedures 1. through 3. to mark all required Start ID codes.

### Notes:

1. Be sure to mark Start ID codes leaving a gap of at least 18 seconds (36 seconds in the 32k-LP mode).
2. While a Start ID code is being marked, sound may be skipped at the beginning and the end of the Start ID code; this is not abnormal.

## Marking Program No. codes (Renumbering)

- After marking Start ID codes is completed, insert Program No. codes at the same points.

1. Press the RENUMBER button in the stop mode.

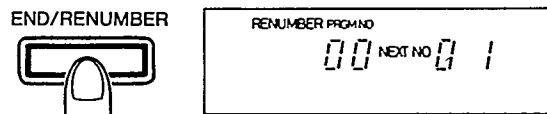

2. The tape is rewound to its beginning and then Program No. codes are marked at the points where Start ID codes are detected, in sequence starting from 1.

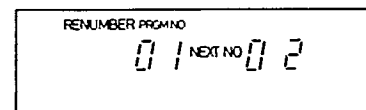

When Program No. code 1 is renumbered..

- The numbers shown by the PRGM NO and NEXT NO indicators are counted up.
3. When the tape reaches its end, this operation is completed and the tape is rewound to the start automatically.
- When the End code is detected, the deck stops at the beginning of the End code.

### Note:

Renumbering cannot be done during recording. Perform renumbering in the stop mode.

## AUTO ID EDIT operations

This function is to re-locate Start ID codes which are being marked slightly after the beginning of a tune by the Start ID marking function.

Start ID codes are re-marked from 0.5 second before the beginning of the tune.

With this function, the beginning of any tune can be located more accurately.

1. Play back the tape and press the AUTO ID EDIT button at the point from which the Start ID code is to be remarked.

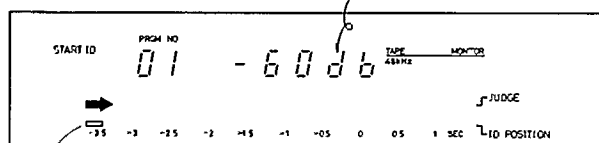
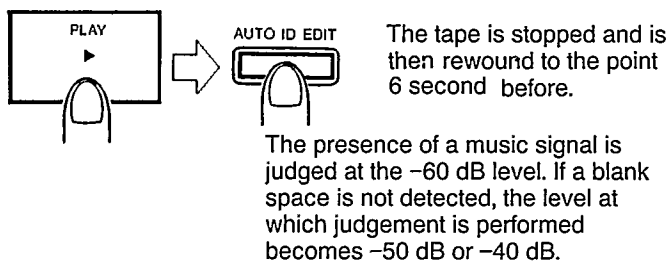

The point at which Start ID codes are marked is adjusted in steps of 0.25 seconds

2. When the appropriate point is detected, the ID POSITION indicator blinks. Example:

Indication when a signal of above -60 dB is recorded

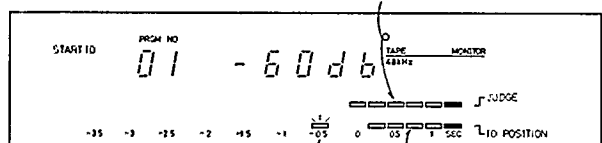

Indication of the most appropriate marking point

Indication of the recorded Start ID code

3. Press the START ID button.

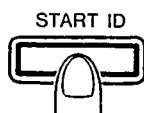

- The START ID WRITE indicator lights and the Start ID and Program No. codes are re-marked.
- When remarking is complete, the deck stops automatically.
- The appropriate marking point is also detected if the AUTO ID EDIT button is pressed in the stop mode.
- The JUDGE indicator lights when the tune is found.

- The appropriate Start ID code marking point is..

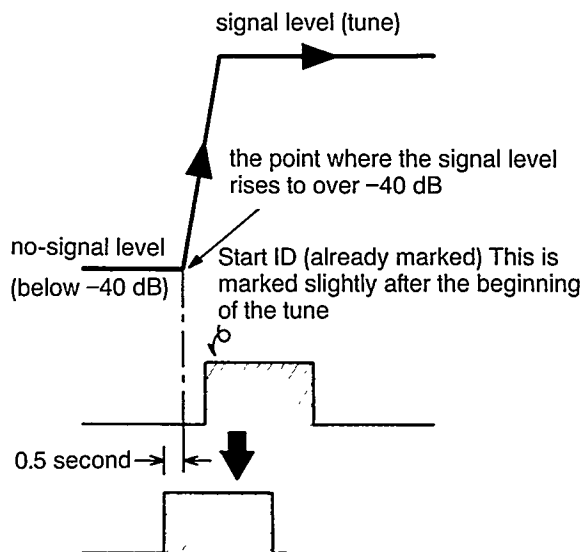

With the AUTO ID EDIT function, the Start ID code is marked 0.5 second before the beginning of the tune. This is a more appropriate point.

- To move the Start ID code marking point.. Press the PREVIOUS or NEXT button while the ID POSITION indicator is blinking.

Every time this is pressed, the Start ID code is moved backward in steps of 0.25 seconds. (up to 3.5 seconds)

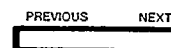

Every time this is pressed, the Start ID code is moved forward in steps of 0.25 seconds. (up to 1 second)

- When all of the JUDGE indicators light and "0" blinks in the ID POSITION indicator. This indicates that an appropriate marking point below -40 dB cannot be found. Repeat operation 1. again.

### Notes:

1. To cancel the AUTO ID EDIT function while it is operating, press the STOP or PLAY button.
2. When no tune is detected, the JUDGE indicator will not light.
3. When a tape on which A TIME codes have not been marked is loaded, this function will not work.
4. When a section with a no-signal level (below -40 dB) cannot be detected, mark the Start ID code referring to "marking Start ID codes" on page 18.
5. Start ID codes are marked and shown by the ID POSITION indicator in steps of 0.25 seconds. They could sometimes be delayed if the AUTO ID EDIT button has been pressed.

# PLAYBACK

— Operate in numerical order. —

Before starting operation, set the TIMER switch to OFF.

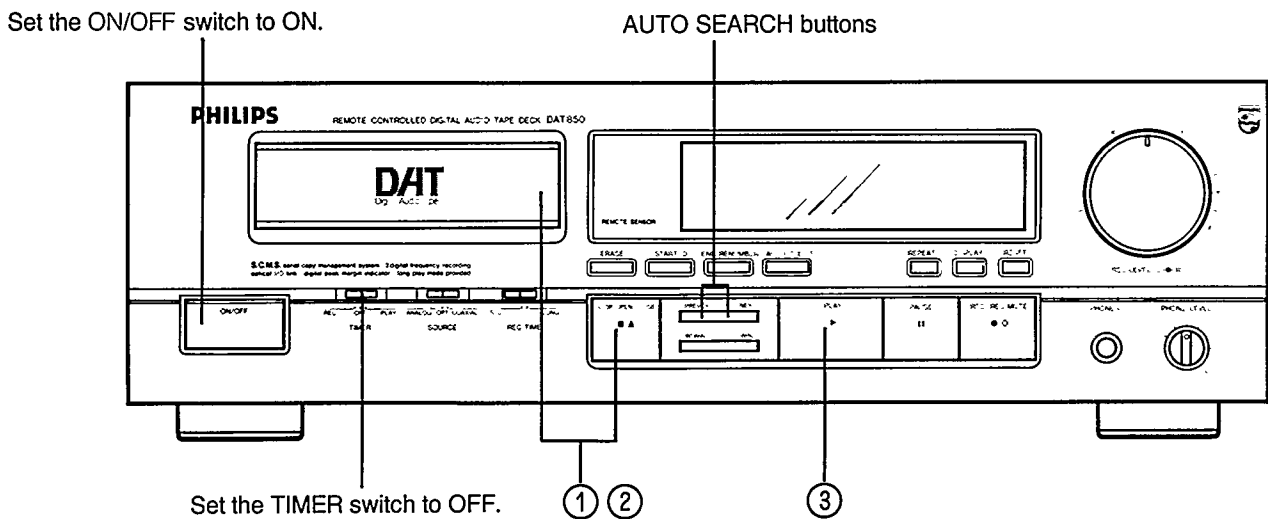

- ① Press the ■/▲STOP/OPEN-CLOSE button to open the cassette tray. (See page 9.)
- ② Load a cassette with the window of the cassette facing up and close the tray.
- ③ Press the ►PLAY button. Playback will start.
  - The sampling frequency is displayed in the display window.

- **When a tape is played back to its end...**  
The auto rewind function rewinds the tape to its start at which point it stops automatically.
- **To stop playback in the middle of a tape..**  
Press the ■ STOP button. Press it again to open the cassette tray.
- **If the EMPHASIS indicator lights..**  
When the tape is reached a position where emphasis is applied, high-frequency signals are deemphasized automatically by the deemphasis circuit.
- **If a tape recorded in 32k-LP mode is played back..**  
The 32 kHz and "LONG PLAY" indicators light in the display window.
- **To fast-forward or rewind the tape so you can hear the speeded-up sound at a lower volume..**  
Press the REWIND or WIND button during playback. The tape advances at 3 times normal speed.

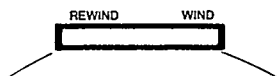

To cue to a tune in the reverse direction (review function)      To cue to a tune in the forward direction (cue function)

- When the button is released, normal playback will resume.

## Notes:

1. If the End code is detected while the tape is being played back or fast-forwarded, the tape stops automatically. Press the REWIND button and rewind the tape.
  2. If a new tape is played back, the tape is rewound to its start within 10 seconds.
  3. If the non-recorded section of a recorded tape is played back, the tape is rewound to the end of the last tune within 10 seconds and stops automatically.
  4. During high-speed playback, at the point where the mode was changed in recording, sound might not be heard. In this case, first perform normal playback and then set to the fast-forward or rewind mode.
- **When playing back a tape you have recorded yourself (recorded on blank tape)**
    - **When the cassette is loaded..**
      - If A TIME codes have been marked on the tape, they are detected and displayed in the display window.
      - When a rewind tape is loaded, first (— 00:01) is displayed and then the A TIME code is displayed.
      - Program Nos. will be displayed when they are detected.
    - **When no Program No. is displayed in the PRGM No. display:**  
Program No. codes are marked at the beginnings of tunes together with Start ID codes. If the cassette is loaded/unloaded in the middle of a tune and if a Program No. code has not been marked at that point, no Program No. will appear in the display. To display the Program No. in this case, continue playback or set the deck to the fast-forward/rewind mode so that the Program No. code is read out.

## Auto repeat

This is used to play back tunes you want to listen again.



ALL: all tunes are repeated  
1: the current tune is repeated

Every time the REPEAT button is pressed, the following indications are displayed.

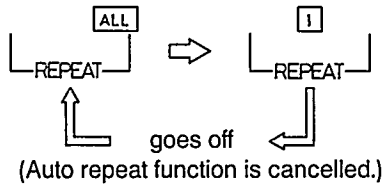

## Direct access playback

Playback with program No. codes (can only be performed using the remote control unit)

tune number buttons

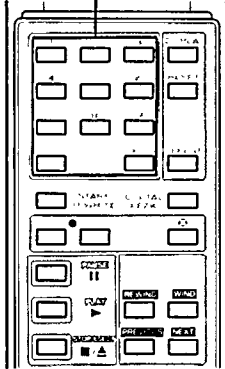

- When designating Program Nos. 1 to 10.

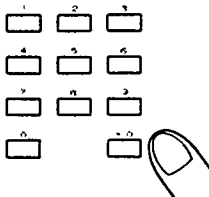

Press the Program No. button corresponding to the number of the tune.

- When designating tune No. 11 or higher..  
Designate the required tune No. by pressing the +10 button and a Program No. button. (When the +10 button is pressed once, the "NEXT NO -1" is displayed.

example: when designating 24



example: when designating 30

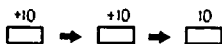

- When the program No. code of the required tune is detected, playback starts.

## Playback using Start ID codes

To find the beginning of the previous tune..

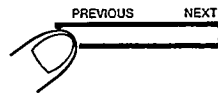

Indicator blinks

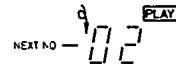

When the PREVIOUS button is pressed three times, the tape is rewound to the beginning of the tune 2 before the current tune.

- Every time this is pressed, the start of the previous tune is detected.

To find the beginning of the next tune..

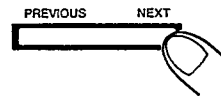

Indicator blinks

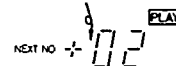

When the NEXT button is pressed twice, the tape is fast-forwarded to the beginning of tune after next.

- Every time this is pressed, the start of the next tune is detected.



- When the Start ID code of the required tune is detected, playback starts.

### Notes:

1. Tapes on which Program No. codes have not been marked cannot be used for this operation if designating is performed using the tune number buttons, Tapes on which Start ID codes are not marked cannot be used for this operation using the PREVIOUS/NEXT AUTO SEARCH button.
2. When the **||** PAUSE button is pressed while searching, the deck enters the pause mode after locating the desired tune.

# DIGITAL DUBBING

— Operate in numerical order. —

## Connection (COAXIAL connection)

When two DAT850 DAT decks are used together, digital dubbing of tapes is possible.

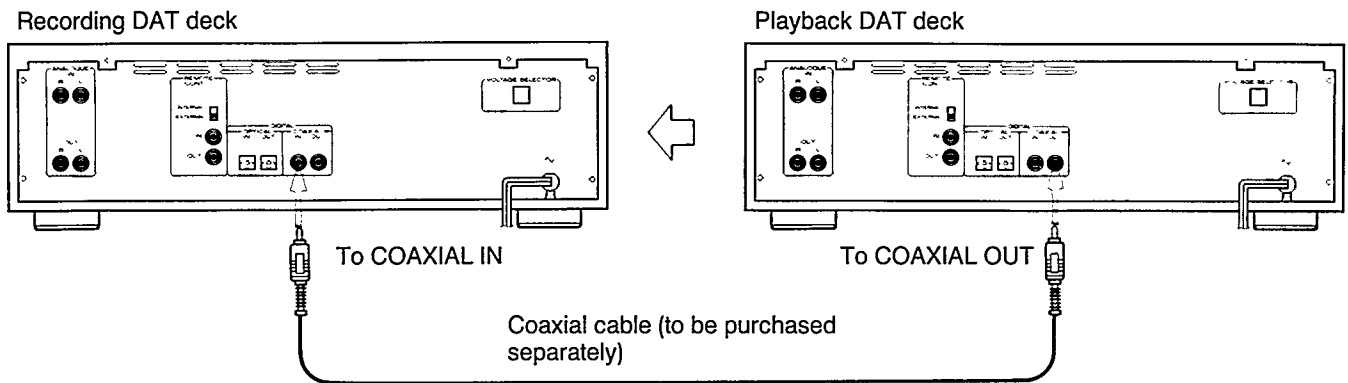

Set the SOURCE switch to the COAXIAL position.

### • Operations

	Operation of recording deck		Operation of playback deck
<b>1</b>	Load a blank DAT cassette. <ul style="list-style-type: none"> <li>• Check that the safety tab of the cassette is in place.</li> <li>• When dubbing from the middle of the tape, the deck should first read out the A TIME and the Program No. codes.</li> </ul>	<b>2</b>	Load the DAT cassette from which dubbing is to be performed. <ul style="list-style-type: none"> <li>• When dubbing the tunes in the order in which they were recorded, the program number should be displayed.</li> </ul>
<b>3</b>	Set the SOURCE switch to "COAXIAL". <ul style="list-style-type: none"> <li>• The DIGITAL INPUT indicator lights in the display window.</li> </ul>		
<b>4</b>	Set the REC TIME switch to the recording mode. <ul style="list-style-type: none"> <li>• 32k mode ... STD</li> <li>• 32k-LP mode ... LONG</li> </ul>		
<b>5</b>	Set the deck to the record mode from the rec-pause mode.		
	<ul style="list-style-type: none"> <li>• When Start ID codes have been encoded on the tape from which dubbing is to be performed, they will be copied to the new tape.</li> <li>• The signal on the new tape will be at the same level as that on the tape from which dubbing is performed.</li> </ul>	<b>6</b>	Press the ► PLAY button to start the dubbing operation.

### • When an OPTICAL cable is used for connection:

When using an optical digital cable, connect the OPTICAL IN terminal of the recording deck to the OPTICAL OUT terminal of the playback deck, and set the SOURCE switch to the OPTICAL position.

• If the tape speed (recording mode) has been changed in the middle of the tape being dubbed, dubbing is interrupted, the deck is set to the rec-pause mode and then the dubbing operation resumes.

• In digital dubbing, the copy has the same sampling frequency as the source. The recording mode cannot be changed using the recording deck's controls.

Sampling frequency of the playback tape	Sampling frequency of the recorded tape
48 kHz	48 kHz
44.1 kHz	44.1 kHz
32 kHz	32 kHz

### Notes:

1. Use either the COAXIAL connection (coaxial cable) or the OPTICAL connection (optical digital cable) for digital connection.
2. When a tape with a digital copy prohibit code is loaded, the DIGITAL INPUT indicator blinks rapidly. In this case, the deck cannot be set to the record mode.
3. If the COPY PHBT indicator blinks when a tape is being played back, digital dubbing of the tape is impossible.

## TIMER RECORDING AND PLAYBACK

- When an optional audio timer is used together with the deck, recording and playback can be started at the desired time (when you are not at home, etc.)
- When an audio timer which can perform repeated ON/OFF switching is used, repeated recording and playback can be performed.

### • Connection to audio timer

Set the POWER switches of all components to ON.

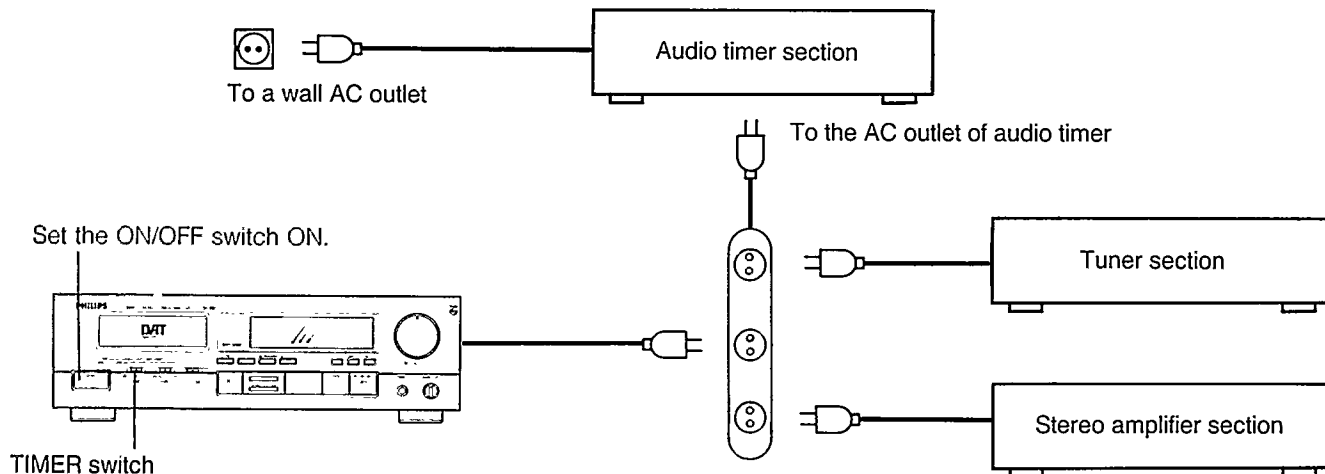

### Note:

This diagram does not represent a U.K. mains plug.

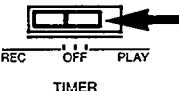
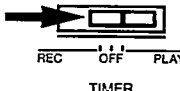
Operation procedure	Timer recording	Timer playback
<b>1. Timer operations</b>	<ul style="list-style-type: none"> <li>• Check that the POWER switches of all components connected to the timer are set to ON.</li> <li>• Operate the timer so that it turns on the power to each component.</li> </ul>	
<b>2. Amplifier/tuner operations</b>	<ul style="list-style-type: none"> <li>• Tune to the required broadcast. FM broadcast: TUNER DSR broadcast: LINE</li> </ul>	<ul style="list-style-type: none"> <li>• Set the TAPE MONITOR switch of the amplifier to ON.</li> <li>• Adjust the volume with the amplifier's volume control.</li> </ul>
<b>3. Deck operations</b>	<ul style="list-style-type: none"> <li>• Load the cassette on which the recording is to be made and operate for recording. (Refer to page 13.)</li> </ul>	<ul style="list-style-type: none"> <li>• Load a prerecorded cassette and operate for playback. (Refer to page 20.)</li> </ul>
<b>4. Timer operations</b>	<ul style="list-style-type: none"> <li>• Program the timer's ON time for when recording/playback is to start and its OFF time for when it is to stop.</li> <li>• When programming the timer's ON time and OFF time, allow a margin of 1 minute for each.</li> <li>• Check that the power supplies of all components connected to the timer are turned OFF.</li> </ul>	
<b>5. Deck operations</b>	<ul style="list-style-type: none"> <li>• Set the TIMER switch to the REC position.</li> </ul>  <p>Recording will start when the preset time is reached.</p>	<ul style="list-style-type: none"> <li>• Set the TIMER switch to the PLAY position.</li> </ul>  <p>Playback will start when the preset time is reached.</p>

### Notes:

1. After timer recording/playback has finished, be sure to set the TIMER ON/OFF switch of the DAT deck to its OFF position.
2. After recording to the end of the tape in timer recording, rewind the tape with the REWIND button.

## TROUBLESHOOTING

---

What appears to be a malfunction may not always be serious. Make sure first..

- 1. Deck does not function when any buttons are pressed.**
    - \* Is a cassette loaded?
    - \* Had 5 seconds elapsed after the power was turned ON?
  - 2. Playback (recording) starts when the power is turned ON.**
    - \* Is the TIMER switch set to PLAY(REC)?
  - 3. Recording is impossible.**
    - \* Is the safety tab of the cassette open?
  - 4. Tape does not run.**
    - \* Has the ■ PAUSE button been pressed?
  - 5. Playback sound is not output even although the tape runs.**
    - \* Is the volume control set to its minimum position?
  - 6. Direct access playback cannot be done correctly.**
    - \* Are Start ID codes marked on the tape?
    - \* Have adjacent Start ID codes been marked within 18 seconds of each other (36 seconds in the 32k-LP mode)?
  - 7. Recording of digital input signal is impossible.**
    - \* Has the SOURCE switch been set to ANALOG?
    - \* Does the COPY PHBT indicator light in the sampling monitor mode?
  - 8. Cassette cannot be loaded. (Cassette is unloaded immediately after it is loaded.)**
    - \* Is the tape damaged?
  - 9. Recording cannot be done correctly.**
    - \* Are the heads dirty?
  - 10. Program No. does not change when the tune changes.**
    - \* Did recording start from the middle of a tape which was previously used for recording?
  - 11. Tape does not run even though the ► PLAY button is pressed.**
    - \* Has a non-recorded tape been loaded?
  - 12. Deck is not operated with the remote control unit.**
    - \* Has the remote control switch on the rear panel been set the EXTERNAL?
    - \* Set the remote control switch to INTERNAL.
- If the deck or tape malfunctions, the recording may not be performed correctly.
  - We recommend that you make a test recording before making an important recording.



# SPECIFICATIONS

Basic format : Conforming to R-DAT format proposed by the DAT Conference, SCMS compatible DAT deck

Operation modes used :

	Recording/playback mode				Playback only mode
	48k	44k	32k	32k-LP	44k-WT
Tape speed (mm/sec)	8.15	8.15	8.15	4.075	12.225
Recording/playback time (R-120)*	120 min.	120 min.	120 min.	240 min.	80 min.
Sampling frequency	48 kHz	44.1 kHz	32 kHz	32 kHz	44.1 kHz
Number of bits quantization	16-bit linear	16-bit linear	16-bit linear	12-bit non-linear	16-bit linear

Number of channels : 2 Channels, stereo  
 Frequency response : 2 Hz — 22,000 Hz  $\pm 0.5$  dB (48k mode)  
 2 Hz — 20,000 Hz  $\pm 0.5$  dB (44k mode)  
 2 Hz — 14,500 Hz  $\pm 0.5$  dB (32k/32k-LP mode)  
 Signal-to-noise ratio : 92 dB (48k mode recording/playback)  
 Dynamic range : 94 dB (48k mode recording/playback)  
 Total harmonic distortion : 0.003% (1 kHz, 48k mode recording/playback)  
 0.08% (1 kHz, 32k-LP mode recording/playback)  
 Wow & flutter : Less than measurable limit ( $\pm 0.001\%$  W.PEAK)  
 Access time : 5 minutes access time ; 8.0 seconds  
 60 minutes access time ; 31.3 seconds  
 Fast forward/rewind time : Approx. 52 seconds (R-120 cassette)  
 Error correction system : Doubly-encoded Read-Solomon Code  
 Input/output terminals (Analog) : LINE IN (RCA jack) x 2  
 Min input level; 63mV (500mV at full scale)  
 Input impedance ; 47 kohms  
 LINE OUT (RCA jack) x 2  
 Output level; 0.25V (2V at full scale)  
 Output impedance; 200 ohms  
 PHONES (6.3 mm dia. standard phone jack) x 1  
 Output level; 0 — 0.1mW/8 ohms (6.3mW/8 ohms at full scale)  
 Matching impedance; 8 ohms — 1 kohms

Input/output terminals (Digital) : COAXIAL IN (RCA jack) x 1  
 0.5Vp-p Input impedance; 75 ohms  
 OPTICAL IN x 1 ; -27 dBm — -14 dBm  
 COAXIAL OUT (RCA jack) x 1  
 0.5Vp-p Output impedance; 75 ohms  
 OPTICAL OUT x 1 ; -21 dBm — -15 dBm

Other terminals : REMOTE CONTROL (Pin jack) x 2  
 Power requirements : AC 240/220/120V, 50/60Hz  
 Power consumption : 24 watts  
 Dimensions (WxHxD) : 420 x 129 x 336 mm  
 Weight : Approx. 6.6 kg  
 Accessories : RCA-plug connection cord x 2  
 Remote cable x 1  
 Remote control unit (RC850DAT) x 1  
 Battery (size "R03" for remote control operation) x 2

• Only digital recording is possible in the 44k and 32k modes.

\* R-120 is a DAT cassette with a recording time of 120 minutes in the Standard mode.

Specifications subject to change without prior notice.

This product complies with the radio interference requirements as laid down in ECC (European Economic Community) regulations.

*Important note for users in U.K.:*

The U.K. version is not fitted with a mains plug. When fitting a mains plug to the mains lead note that the wires in the mains lead are coloured with the following code:

Blue = Neutral, Brown = Live.

As these colours may not correspond with the colour markings identifying the terminals in your plug proceed as follows: the Brown wire must be connected to the terminal which is marked with the letter L or coloured Red.

The Blue wire must be connected to the terminal which is marked with the letter N or coloured Black.

Note: This apparatus must be protected by a 3 Amp Fuse if a 13 Amp plug is used or, if any other type of plug is used, by a 5 Amp Fuse either in the plug or adapter or at the distribution board. If in doubt consult a qualified electrician.

DO NOT CONNECT EITHER WIRE TO THE EARTH TERMINAL IN THE PLUG WHICH IS MARKED BY THE LETTER E OR BY THE SAFETY EARTH SYMBOL OR COLOURED GREEN OR GREEN - AND - YELLOW

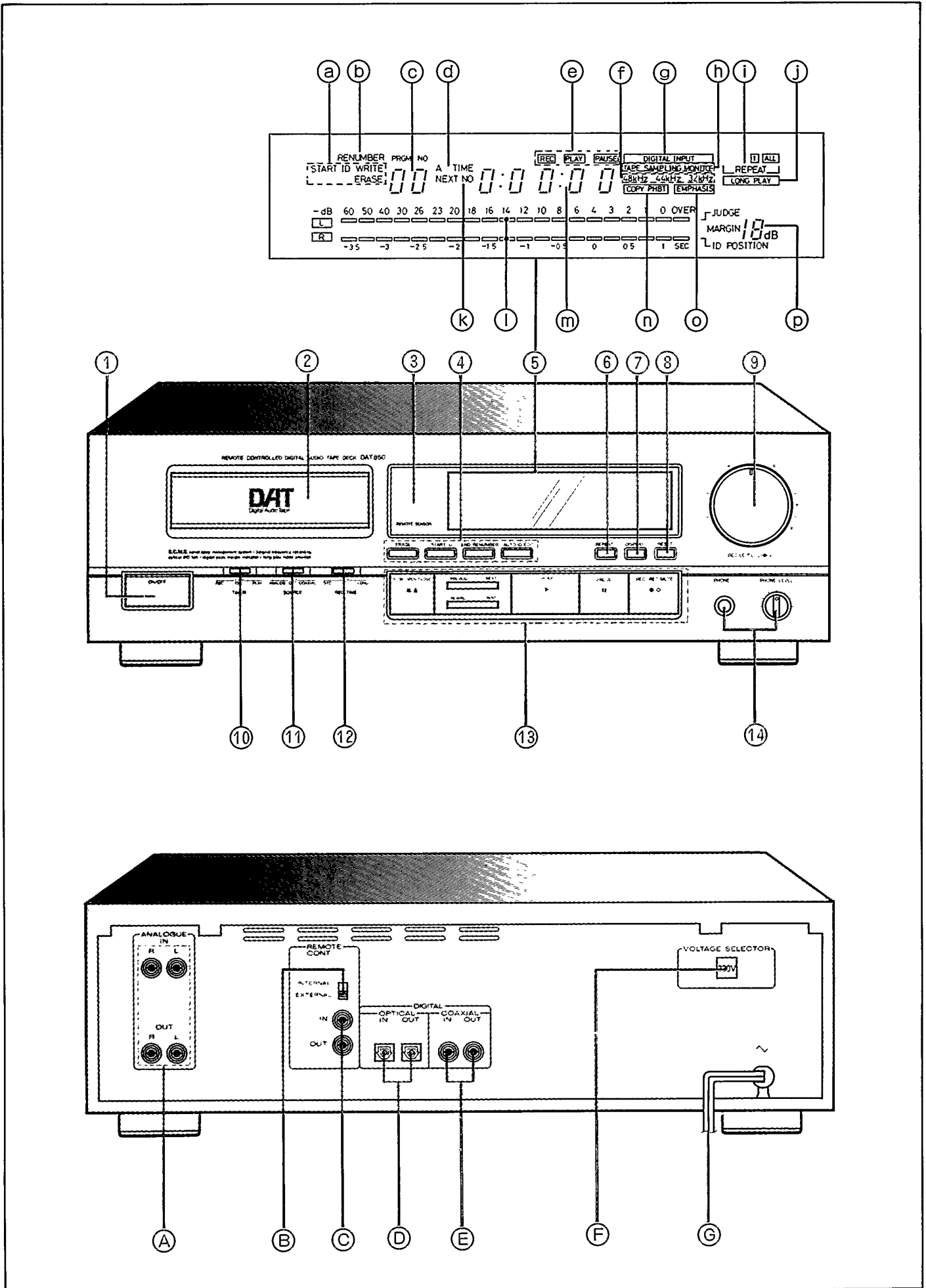





## Free Manuals Download Website

<http://myh66.com>

<http://usermanuals.us>

<http://www.somanuals.com>

<http://www.4manuals.cc>

<http://www.manual-lib.com>

<http://www.404manual.com>

<http://www.luxmanual.com>

<http://aubethermostatmanual.com>

Golf course search by state

<http://golfingnear.com>

Email search by domain

<http://emailbydomain.com>

Auto manuals search

<http://auto.somanuals.com>

TV manuals search

<http://tv.somanuals.com>