

Audio CD Recorder



Let's make things better.



PHILIPS

Caution

CAUTION: Use of controls or adjustments or performance of procedures other than herein may result in hazardous radiation exposure or other unsafe operation.

This product complies with the radio interference requirements of the European Union.

ATTENTION: L'utilisation des commandes ou réglages ou le non-respect des procédures ci-incluses peuvent se traduire par une exposition dangereuse à l'irradiation.

Ce matériel satisfait aux impératifs de brouillage radio de la Communauté Européenne.

ATENCIÓN: El uso de mandos o ajustes o la ejecución de métodos que no sean los aquí descritos puede ocasionar peligro de exposición a radiación.

Este aparato satisface las normas relativas a la interferencia radioeléctrica de la Comunidad Europea.

ACHTUNG: Der Gebrauch von Bedienelemente oder Einstellungen bzw. Verfahrensausführungen die hier nicht ausdrücklich erwähnt worden sind, kann eine gefährliche Strahlendosierung oder andere unsichere Operationen zur Folge haben.

Dieses Produkt entspricht den Funkentstörvorschriften der Europäischen Union.

LET OP: Het gebruik van de toetsen en regelingen of het toepassen van de aanwijzingen anders dan hier beschreven, kan leiden tot blootstelling aan gevaarlijke straling of tot onveilige werking. Dit apparaat voldoet aan de radio-ontstoringseisen van de Europese Unie.

ATTENZIONE: L'uso dei comandi o regolazioni o prestazioni delle procedure oltre a quelle descritte nel presente potrebbero causare esposizione a radiazioni pericolose o altre operazioni rischiose.

Questo prodotto è conforme ai requisiti delle interferenze radio della Unione Europea.

VARNING: Om du använder knapparna på annat än här angivet sätt eller utför andra justeringar eller förfaranden än de här angivna kan du utsättas för skadlig strålning eller andra risker.

Denna apparat uppfyller EU:s krav beträffande radiostörningar.

ADVARSEL: Anvendelse af andre betjeningsanordninger eller justeringer eller udførelse af andre procedurer end de heri angivne, kan medføre udsættelse for farlig stråling eller andre risici.

Dette apparat overholder EU's krav vedrørende radiostøj.

MUISTUTUS: Muiden kuin tässä kuvattujen säätimien tai säätöjen tai toimenpiteiden käyttö voi aiheuttaa vaarallisen altistuksen säteilylle tai muun turvallisuutta vaarantavan seurauksen.

Tämä tuote on Euroopan unionin radiohäiriötä koskevien vaatimusten mukainen.

AVISO: A utilização de comandos ou ajustes ou a execução de procedimentos de forma diferente daquela aqui indicada poderá resultar numa exposição perigosa a radiações ou noutra operação arriscada.

Este produto obedece aos requisitos referentes a interferência de rádio estabelecidos pela União Europeia.

ΠΡΟΣΟΧΗ: Οποιαδήποτε διαδικασία, χρήση ή ρύθμιση των ρυθμιστικών πλήκτρων και διακοπών εκτός των προβλεπόμενων στο παρόν εγχειρίδιο, μπορεί να έχει ως αποτέλεσμα την επιβλαβή έκθεση σε ακτινοβολία ή άλλη επικίνδυνη λειτουργία.

Υο προϊόν αυτό πληροί τις απαιτήσεις της Ευρωπαϊκής Ένωσης ως προς τις ραδιοπαρεμβολές.

UWAGA: Operowanie klawiszami lub pokrętłami w sposób odbiegający od zalecanego albo wykonywanie procedur innych, niż zawarte w niniejszej instrukcji, może narazić użytkownika na niebezpieczne promieniowanie lub inne zagrożenia.

Niniejszy produkt spełnia wymogi Unii Europejskiej dotyczące zakłóceń radiowych.

Index

English ————— 4

English

Français ————— 28

Français

Español ————— 52

Español

Deutsch ————— 76

Deutsch

Nederlands ————— 100

Nederlands

Italiano ————— 124

Italiano

Svenska ————— 148

Svenska

Dansk ————— 172

Dansk

Suomi ————— 196

Suomi

Português ————— 220

Português

Table of contents

English

General information

Welcome.....	5
Environmental information	5
About this manual.....	5
Technical data	5
Discs for recording.....	6
Discs for playback.....	6
Maintenance	6
Accessories	6

Operating buttons

Controls.....	7
---------------	---

Display

DISPLAY indications	8
DISPLAY messages.....	8
MENU messages.....	10

Connections

Connections at the back.....	11
Set up recommendations	11
Connections general.....	11

Installation

Analog connections.....	12
Digital connections	12
Power supply/Mains.....	13

Remote control

Inserting batteries in the remote control.....	14
Remote control commands	14

Recording

Inserting discs.....	15
Introduction	16
Adjusting the recording level	17
Recording an entire CD	17
Recording a single track.....	18
Manual recording	19
Finalizing CDR & CDRW discs.....	20
Unfinalizing CDRW discs.....	20
Erasing CDRW discs content.....	21

Playing

Playing a CD.....	21
Selecting a track	21
Search.....	22
Shuffle (random order) play	22
Repeat CD, track or program	22
Programming tracks	22

Menu mode

Remarks about Menu mode.....	23
General operation of Menu	23
A. Text input.....	24
B. Erasing text	24
C. Reviewing CD text memory.....	25
D. Auto track increment	25
E. Balance.....	26

Troubleshooting

Troubleshooting.....	27
----------------------	----

General information

Welcome!

Thank you for buying this Philips Compact Disc Recorder.

In the 1980s Philips invented a new audio system - the CD. The CD (compact disc) revealed the new dimensions of digital sound and added to the pleasure of audio.

Compact-disc technology permits a high contrast in both loud and soft passages, with perfect channel separation.

Philips has now further developed compact disc technology and the result is the CD recorder.

With your Philips CD Recordable/ReWritable Recorder, you can record, play and erase your own high-quality audio CDs, subject to legal restrictions on copying. Naturally, you will also be able to play all pre-recorded audio CDs.

Note: In certain countries, including the UK and certain Commonwealth countries, use of the product (or CD Recorder) as shown or suggested in this user manual may require the permission of copyright holders.

Environmental information

All redundant packing material has been omitted. We have done our utmost to make the packaging easily separable into three mono materials: cardboard (box), polystyrene foam (buffer) and polyethylene (bags, protective foam sheet).

Your set consists of materials which can be recycled if disassembled by a specialized company. Please observe the local regulations regarding the disposal of packing materials, exhausted batteries and old equipment.

CAUTION

INVISIBLE RADIATION WHEN OPEN.
AVOID EXPOSURE TO BEAM.

Note: This warning is located inside the enclosure.

About this manual

This manual gives instructions for operating this CD recorder.

Please note:

- the digits (1) throughout the text indicate a sequence of actions necessary to perform a certain operation;
- the arrows (→) indicate the reaction from the recorder;
- the dots (o) indicate remarks, advice or special options within a sequence of actions. The dot-marked instructions are not necessary for operation.

All instructions in this manual are based on control via the keys on the set. If there are corresponding keys available on the remote control they can be used as well.

Technical data

Subject to modification without notice.

General

Power consumption	15 W
Power consumption in Standby	6 W
Operating temperature	5-35° C
Weight	4 kg
Dimensions	435 x 310 x 88 mm

Audio

Frequency response	2Hz-22.050 Hz
Playback S/N (A-weighted)	100 dB
Playback S/N	100 dB
Playback dynamic range CDR	95 dB
Playback total harmonic distortion CDR	88 dB = 0.0039 %
Channel separation	100 dB
Recording S/N (A-weighted)	98 dB
Recording S/N digital without SRC	equal to source
Recording dynamic range	92 dB
Recording total harmonic distortion + noise	85 dB (0.0056%)

Laser

Type	Semiconductor laser GaAlAs
Wave length	775-795 nm (at 25° C)
Output power	2.5 mW (Read,) 35 mW (Write)
Beam divergence	60 degree

The type plate is located on the back of the set.

English

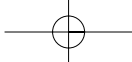

General information

English

Discs for recording

For recording, make sure to use special audio discs only. These discs are marked with "Digital Audio" and the logos shown below.

There are two different types of audio discs for the use on this CD recorder:

– CD-Audio Recordable (CDR) discs

These discs can be recorded on once and play in all standard CD players and CD recorders, when they are finalized.



– CD-Audio ReWritable (CDRW) discs

These discs can be recorded on, erased and re-recorded many times and play in CDRW compatible CD players and CD recorders, when they are finalized.



– All Philips CD players and CD recorders with the sticker shown here are CDRW compatible.



To ensure proper working of the set we recommend the use of Philips audio CDR and audio CDRW discs only.

Note: Do not use a computer CDR or CDRW as recording will not work!

Recording is permissible insofar as copyright or other rights of third parties are not infringed upon.

In certain countries including the UK and certain Commonwealth countries, use of the product as shown or suggested in this user manual may require the permission of copyright holders.

Discs for playback

Your CD recorder is able to play:

- All pre-recorded audio CDs.
- All Audio CDR and Audio CDRW.

Note: CDR(W) discs containing audio recorded with a computer can only be played when they are correctly treated according the audio standard (IEC958: Consumer part). Single session only!

Maintenance

For recording, it is very important to use discs that are free of dust and scratches.

To clean a CD, wipe it in a straight line from the center towards the edge using a soft, lint-free cloth. A cleaning agent may damage the disc! Write only on the printed side of a CDR or CDRW, and only with a soft felt-tipped pen.

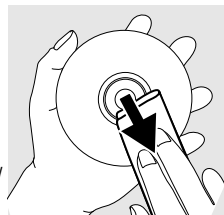

Clean the CD recorder with a soft, slightly dampened lint-free cloth. Do not use any cleaning agents as they may have a corrosive effect.



Do not expose the CD recorder batteries or CDs to humidity, rain, sand or excessive heat (caused by heating equipment or direct sunlight).

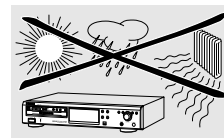

Always keep the tray closed to avoid dust on the lens.

The lens may cloud over when the CD recorder is suddenly moved from cold to warm surroundings, making it impossible to play a CD. Leave the CD recorder in the warm environment until the moisture evaporates.

Accessories

- 2 Analog audio cables (with red and white plugs)
- 1 Digital coaxial cable (with black plugs)
- Power cord
- 2 Batteries
- Remote control
- Guarantee

Operating buttons

English

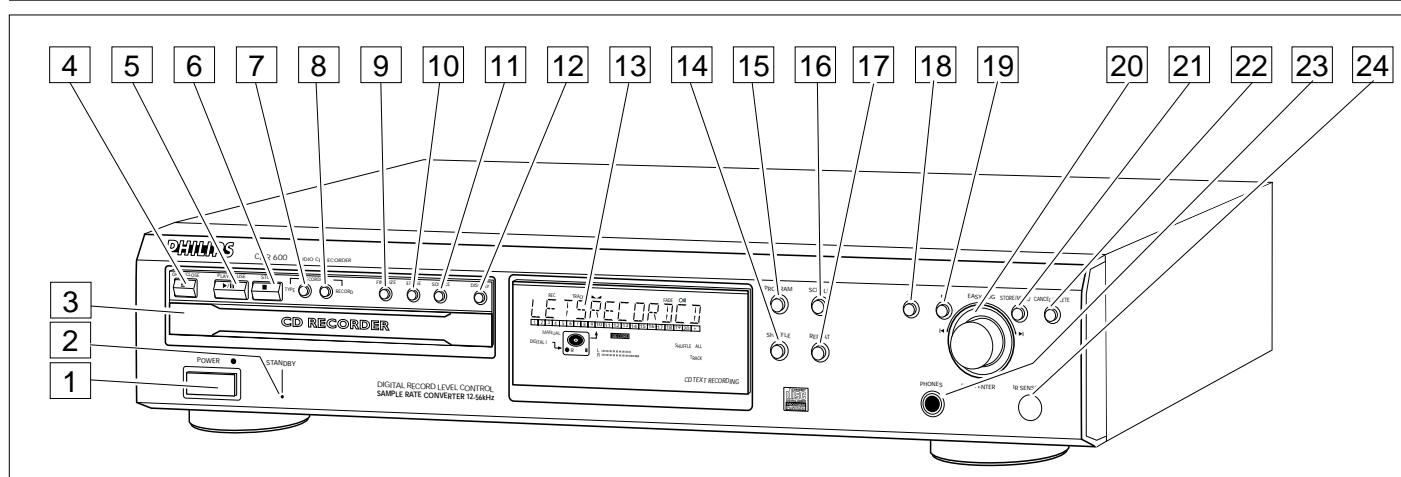

Controls



- 1 ON/OFF**
turns the CD recorder ON and OFF
- 2 Standby indicator**
- 3 Disc tray**
- 4 OPEN/CLOSE ▲**
opens/closes disc tray
- 5 PLAY/PAUSE ►►**
starts play/interrupts play or recording
- 6 STOP ■**
stops/clears a program
- 7 RECORDING TYPE**
selects recording modes
- 8 RECORD**
starts recording, finalizing, erasing
- 9 FINALIZE**
selects finalize mode
- 10 ERASE**
selects erasing mode (disc or track)
- 11 SOURCE**
selects input source
- 12 DISPLAY**
selects display information, permanent text scrolling and time
- 13 Display**
information screen
- 14 SHUFFLE**
plays CD(RW) or program in random order
- 15 PROGRAM**
opens/closes program memory
- 16 SCROLL**
activates scrolling of text over the display (once)
- 17 REPEAT**
repeats play (all, program or track)
- 18 ◀◀**
- searches backward
- cursor control in Menu/Prog. review mode
- 19 ▶▶**
- searches forward
- cursor control in Menu/Prog. review mode
- 20 ◀ EASY JOG ▶ (rotate)**
- previous/next track (Play and Program mode)
- recording level control (recording)
- selects settings (menu on)
- ENTER (push)**
- plays selected tracks
- selects settings in menu mode
- programs track numbers
- 21 STORE/MENU**
- enters Menu mode
- stores Menu settings
- 22 CANCEL/DELETE**
- deletes tracks from a program
- deletes text in Menu mode
- returns to a higher level in the menu
- 23 PHONES**
socket for headphones
- 24 IR sensor**
receives signals from the remote control

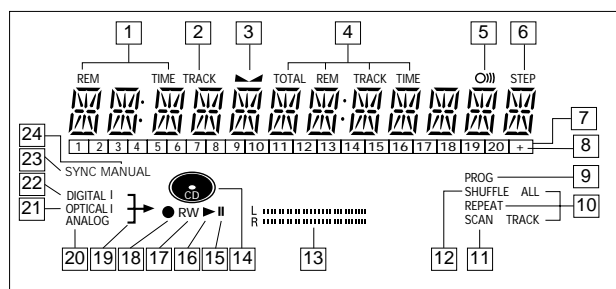

Display

English

DISPLAY indications



- 1 REM TIME**
remaining time
- 2 TRACK**
track number
- 3** 
balance (lights up during balance adjustment)
- 4 TOTAL REM TRACK TIME**
indicates total or remaining time of disc or track
- 5** 
remote control active
- 6 STEP**
indicates the number of tracks in a program
- 7 Track bar**
indicates:
- tracks on a disc or in a program
- track in play
- 8 + 20**
disc or program contains more than 20 tracks
- 9 PROG**(ram)
flashes during programming/lights in program mode
- 10 REPEAT TRACK/ALL**
lights up when a track/complete disc (or program) is repeated
- 11 SCAN**
lights up when the first 10 seconds of each track are played
- 12 SHUFFLE**
plays tracks in random order
- 13 L/R II II**
Record/play level bar, indicates the audio signal level
- 14 CD**
CD inserted (a pre-recorded CD or finalized CDR or CDR(W) disc)
- 15 II**
pause function active
- 16** 
lights during play
- 17 R(W)**
unfinalized CDR(W) disc inserted

- 18** 
lights during recording
- 19** 
lights during recording
- 20 ANALOG**
analog input selected
- 21 OPTICAL I**
optical input I selected for external recording
- 22 DIGITAL I**
digital input I selected for external recording
- 23 SYNC**
synchronized recording active
- 24 MANUAL**
manual recording active



DISPLAY messages

Messages as listed and explained here may appear on the display for your guidance.

General

- READING**
reading disc information
- OPEN**
opening tray
- CLOSE**
closing tray
- NO DISC**
no disc inserted, disc unreadable or disc inserted upside down
- PROG FULL**
program full
- INSERT DISC**
insert disc or insert disc correctly
- WRONG DISC**
inserted disc is not an audio CD
- UNFINALIZED**
unfinalized CDR(W) disc
- MEMORY $\times \times \square / \square$**
indicates the amount of memory used for unfinalized discs

Recording

- WAIT**
- when STOP  is pressed during recording
- when STOP  is pressed during recording the first 4 seconds of a track
- UPDATE**
updating disc contents

Display

English

DISC FULL
recording no longer possible

DIGITAL 1
digital coaxial input 1 selected

OPTICAL
digital optical input selected

ANALOG
analog input selected

COPY PROTECT
no digital recording can be made from the connected source

NOTFINALIZED
when opening the tray with an unfinalized disc inserted

MAKE CD
start of synchronized recording of a complete disc and Auto Finalize function selected

RECORD DISC
start synchronized recording of a complete disc

RECORD TRACK
start synchronized recording of a single track

REC MANUAL
manual start of recording selected

--XX DD
level is being adjusted

ERASE TRACK
when erasing one or more tracks

ERASE DISC
when erasing a disc

FINALIZE CD
when finalizing a disc

FINALIZED
when trying to finalize an already finalized disc

CHECK INPUT
when RECORD is pressed while no digital source is detected

XX XX ERASE
time countdown when erasing a track or a disc

XX XX FINAL
time countdown when finalizing a disc

PRESS RECORD
to start manual recording, finalizing or erasing

START SOURCE
to start synchronized recording from a source (e.g. CD player)

FINALIZED CD
when trying to record on a finalized CDR or a prerecorded CD

UNFINALIZE/PRESS ENTER
when trying to record on a finalized CDRW

PROF SOURCE
when a professional source is connected

Play

PROGRAM
program mode selected

ALBUM TITLE
will be followed by album title

TRACK TITLE
will be followed by track title

ALBUM ARTIST
will be followed by artist's name

TRACK ARTIST
will be followed by track artist's name

Others

NO AUDIO TR
when the recorder enters a data track during recording

FINALIZE CD
laser power calibration performed 96 times, finalize disc needed

INITIALIZING
during laser power calibration for unfinalized discs

DISC RECOVER
during disc recovery after power failure

OPC ERROR
OPC failure during OPC procedure
(OPC = Optimum Power Calibration)

RECORD ERROR
recording error in menu mode

DISC ERROR
when trying to record on or finalize a recovered disc

MEMORY FULL/FINALIZE CD
when no more text can be stored for a certain disc.
Another disc must be finalized to obtain memory space

NOT POSSIBLE
when trying to erase a CDR

Display

English

MENU messages - See Menu mode

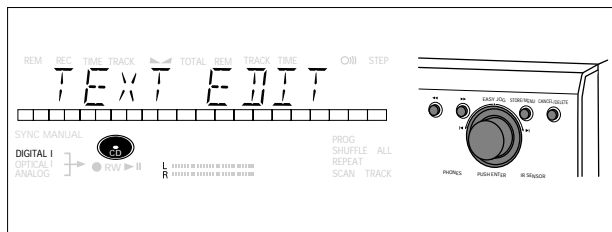

NO TRACKS

when attempting to edit text for a disc which has no tracks

TEXT EDIT

when entering Text Edit mode

ALBUM ARTIST

when editing or erasing an artist's name

ALBUM TITLE

when editing or erasing a title

ARTIST TR N

when editing or erasing an artist's name per track

TITLE TR N

when editing or erasing a title per track

TEXT ERASE

when entering Text Erase mode

ALL TEXT

when entering All Text mode

ERASE OK

when confirmation for erasing must be given with ENTER key

ERASE ALL OK

when confirmation for erasing must be given with ENTER key

ERASE MEMORY

when waiting for confirmation for erasing a disc

MEMORY VIEW

when selecting text review per unfinalized disc in memory

MEMORY EMPTY

when REVIEW is selected while no text is in memory

AUTO TRACK

when selecting auto track increment ON or OFF

ON

Auto Track increment on

OFF

Auto Track increment off

SET BALANCE

when selecting BALANCE

NO TEXT

no text stored for disc

Connections

English

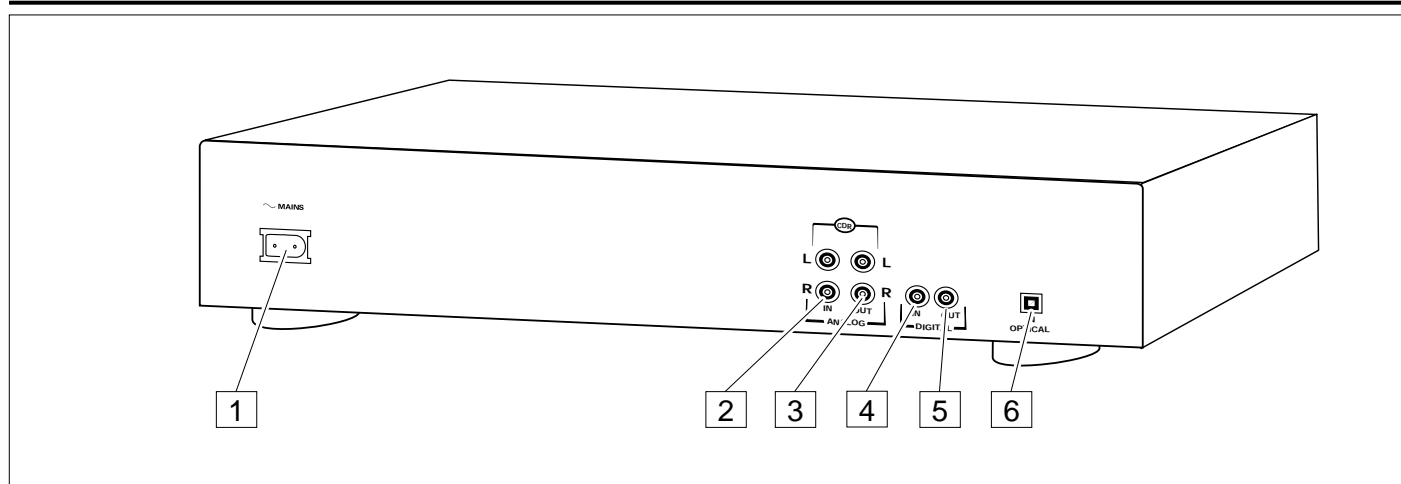

Connections at the back

- 1 Connection to mains
- 2 **ANALOG IN**
connects to the line (analog) output of an amplifier/receiver or other analog source (tape deck, tuner etc.), so you can record from this source (**ANALOG**). For recording from a record player both recorder and record player should be connected to an amplifier/receiver
- 3 **ANALOG OUT**
connects to the line (analog) input of an amplifier/receiver, so you can listen to playback of this set via the amplifier/receiver
- 4 **DIGITAL IN**
connects to the digital coaxial output of an external digital source (CD player, DVD, DAT, etc.), so you can record from this source (**DIGITAL 1**)
- 5 **DIGITAL OUT**
connects to the digital coaxial input of an amplifier/receiver, so you can listen to playback of this set via the amplifier/receiver
- 6 **OPTICAL IN**
connects to the digital optical output of an external digital source (CD player, DVD, DAT, etc.), so you can record from this source (**OPTICAL**)

Set up recommendations

- Place the CD recorder on a solid, vibration-free surface.
- Do not place the CD recorder near a source of heat or in direct sunlight.
- Do not use the CD recorder under extremely damp conditions.
- If the CD recorder is placed in a cabinet, make sure that a one-inch space remains free on all sides of the CD recorder/player for proper ventilation.

Important: Do not position the CD recorder on top of other equipment that might heat it up (e.g. receiver or amplifier).

Connections general

For recording the following inputs are present:

- Digital optical input (OPTICAL IN)
- Digital coaxial input (DIGITAL IN)
- Analog input (ANALOG IN)

For playback the following outputs are present:

- Digital coaxial output (DIGITAL OUT)
- Analog output (ANALOG OUT)

The connections you make will depend upon the possibilities your audio equipment offers. Please refer to the user manuals for your other audio equipment first.

Digital recordings (optical or coaxial) give the best performance in audio and usability (e.g. auto-track increment).

We advise you to always establish both digital and analog connections. This will mean that analog recordings can always be made when digital recording is not possible.

We have described the most common ways of connecting the CD recorder. If you still have difficulties with the connections, please contact the Philips Consumer Service desk in your area.

Installation

English

Analog connections

These connections are required for playback and recording via an amplifier/receiver, equipped with an analog in- and outputs.

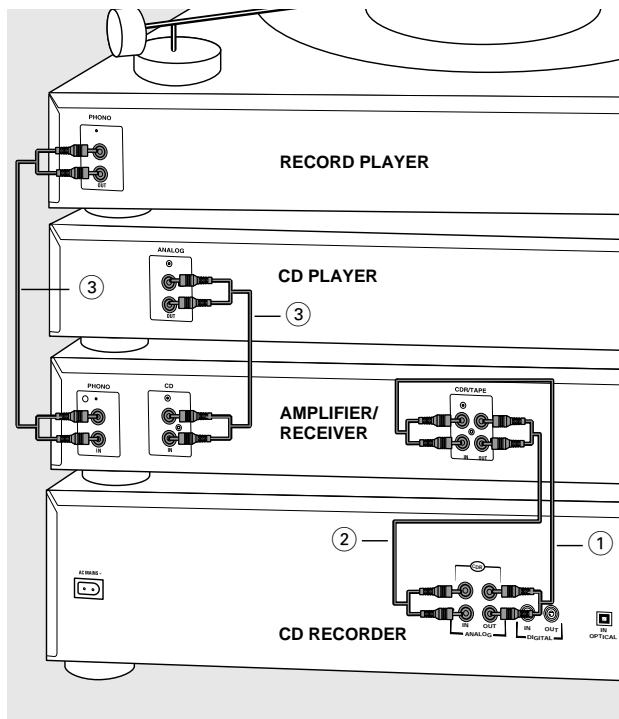

- 1 Connect supplied audio cable between the ANALOG OUT-sockets on the set and the ANALOG input sockets of the amplifier/receiver (TAPE IN, CD-R, AUX or PLAY IN). Insert the red plugs into the R sockets, and the white plugs into the L sockets.
- 2 Connect supplied audio cable between the ANALOG IN-sockets on the set and the analog outputs of the amplifier/receiver (CDR OUT, TAPE OUT, AUX OUT, REC OUT etc.). Insert the red plugs into the R sockets, and the white plugs into the L sockets.
- 3 Connect all other components of your system (tape deck, CD player, tuner, record player etc.) via their ANALOG OUT-sockets to the appropriate analog input sockets of the amplifier/receiver (CD IN, TUNER IN, AUX IN, PHONO IN etc.).
→ Any analog device, connected to the amplifier/receiver can now be used as recording source (ANALOG).

Digital connections

Direct digital coaxial connection

This connection is required for direct recording from a digital coaxial source (e.g a CD player, DVD, DAT).

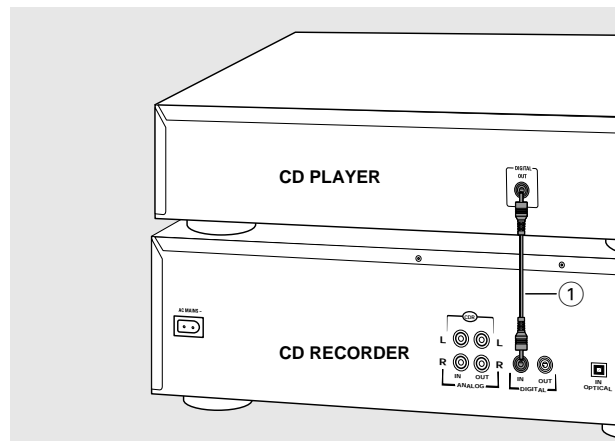

- 1 Connect a digital coaxial cable between the DIGITAL IN-socket on the set and the DIGITAL OUT socket of the digital source.
→ Recording can now be done via the digital coaxial input (DIGITAL 1).

Direct digital optical connection

This connection is required for direct recording from a digital optical source (e.g a CD player, DVD, DAT).

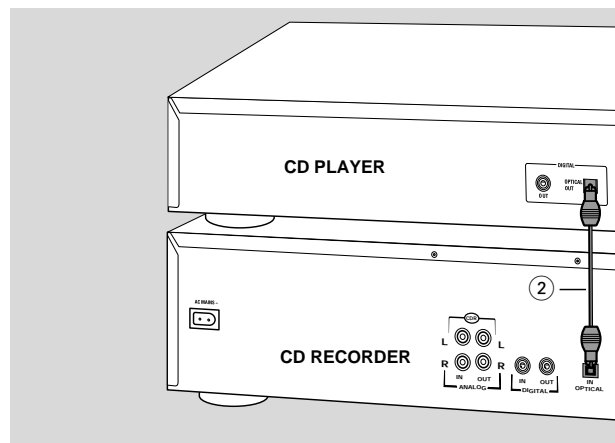

- 1 Remove the dust caps from the digital optical connections of both source and CD recorder. Keep the caps in a safe place.
- 2 Connect an optical fibre-optic cable between the OPTICAL IN socket of the set and the OPTICAL OUT socket of the source.
Make sure you insert both plugs fully, until a click is heard.
→ Recording can now be done via the digital optical input (OPTICAL).

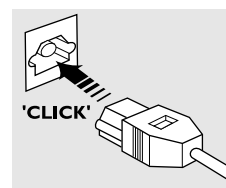

Installation

Digital coaxial connections via a digital receiver

If you have a receiver with digital coaxial in- and outputs, these connections allow you to make digital recordings from various sources, connected to the receiver.

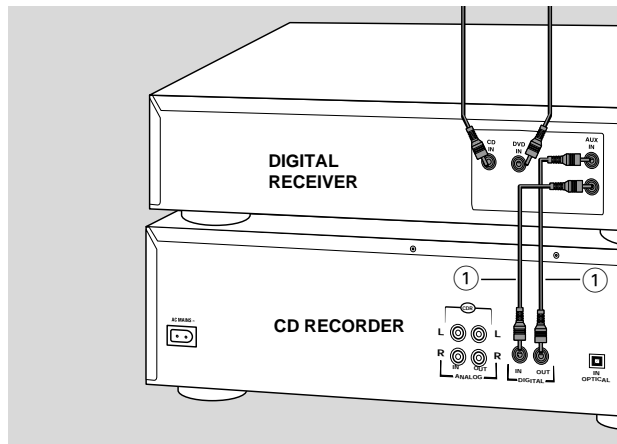

- 1 Connect a digital coaxial cable between the DIGITAL IN- and OUT sockets on the set and e.g. the (digital) AUX in- and output sockets on the digital receiver.
→ Any digital device, connected to the digital input sockets of the digital receiver (e.g. CD and DVD) can now be used as recording source.

Power supply/Mains

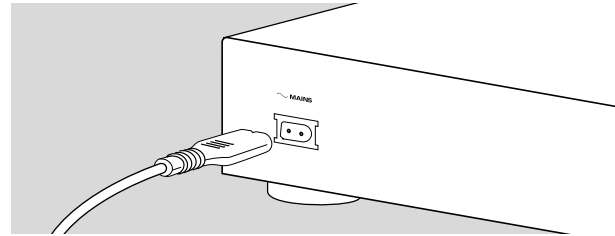

- 1 Check whether the mains voltage as shown on the type plate corresponds to your local mains voltage. If it does not, consult your dealer or service organisation.
- 2 Make sure all connections have been made before switching on the mains supply.
- 3 Plug the power cord supplied into the AC MAINS ~ connector and the CD recorder, then into the wall socket.
- 4 Press ON/OFF.
→ The CD recorder will switch on.

Notes:

If the CD recorder is in Standby mode (red LED on), press any key to activate the recorder.

When the CD recorder is in the "OFF" position, it is still consuming some power. If you wish to disconnect your CD recorder completely from the mains, withdraw the plug from the AC Outlet.

English

Remote control

English

Inserting batteries in the remote control

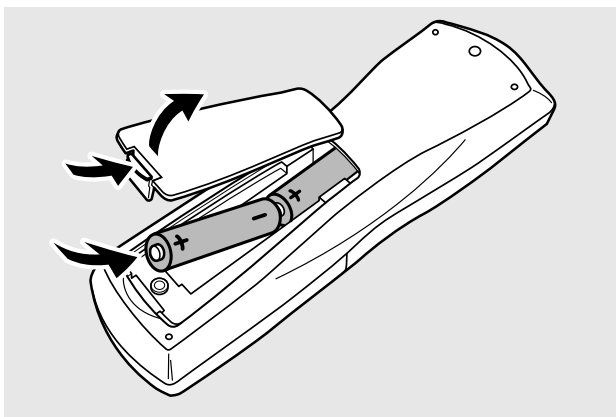

- 1 Open the battery compartment cover.
- 2 Insert 2 batteries (AA, LR6 or UM-3; as supplied) as shown.
- 3 Replace the cover.

Note: We recommend you use 2 batteries of the same type and condition.

Batteries contain chemical substances, so they should be disposed of properly.

Remote control commands

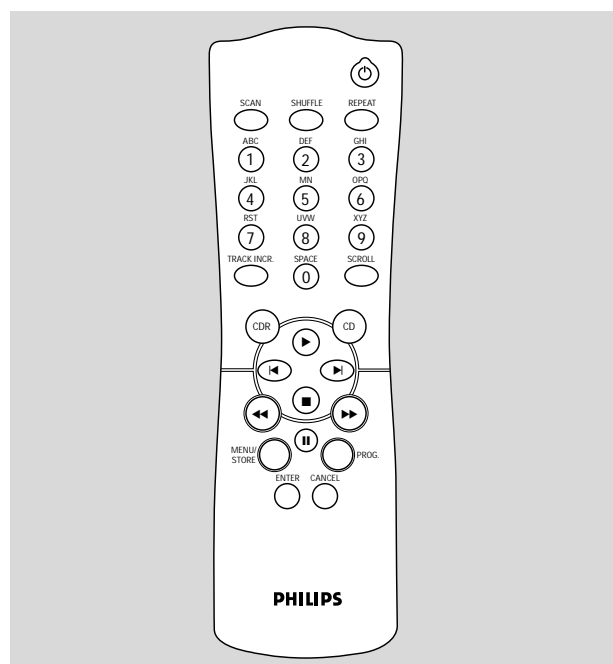

STANDBY

switches to Standby/On/Off

SCAN

plays the first 10 seconds of each track

SHUFFLE

plays CD(RW) or program in random order

REPEAT

repeat play

Number/alphabet keys 0 - 9

- selects a track by number
- selects character for text input

TRACK INCR(ement)

increases track numbers during recording

SCROLL

activates scrolling of text over the display

CDR

selects CD recorder

CD

selects CD player, can be used to control a separate Philips CD player

- ▶ starts CD(RW) play
- ◀ previous track (Play and Program mode)
- ▶ next track (Play and Program mode)
- stops CD(RW) and clears a program

Recording

English



- searches backward
- cursor control in Menu/Prog. review mode



- searches forward
- cursor control in Menu/Prog. review mode



- interrupts CD(RW) play/recording

MENU/STORE

- enters Menu mode
- stores Menu settings

PROG.(ram)

- opens/closes program memory

ENTER

- selects settings in Menu mode
- programs track numbers
- starts playback of selected track

CANCEL

- deletes tracks from a program
- deletes text in Menu mode
- returns to a higher level in the menu

Note: Always press CDR first to select the CD recorder.

Inserting discs

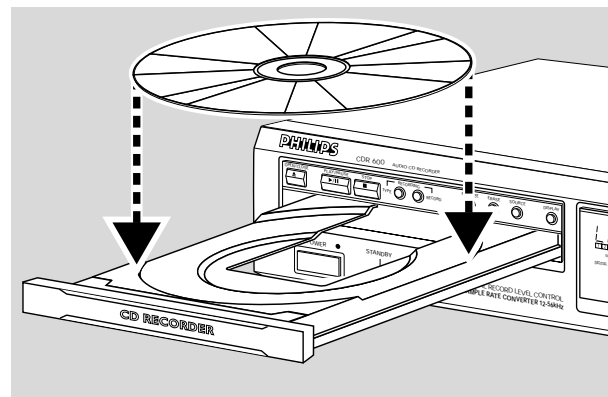

- 1 Press OPEN/CLOSE to open the disc tray.
→ **OPEN** lights up.
- 2 Insert a CD, CDR or CDRW in the appropriate recess in the tray, label side up.
- 3 Press OPEN/CLOSE to close the tray (see also Playing a CD).
→ **CLOSE** lights up, followed by **READING** the display will show the type of disc that has been inserted.
 - If a blank or partly-recorded CDR or unfinalized CDRW is inserted, the CD recorder will calibrate the disc for optimum recording. During this process the display will first show **INITIALIZING** and then the number of audio tracks. Calibration can take up to 25 seconds.
 - If a CDR(W) is finalized, **CD** will show on the display.
 - If CD-text is available the **TITLE/ARTIST** will scroll by.

Notes:

*Only Audio CDs will be accepted. If a non-audio disc is inserted, the display will show: **WRONG DISC / USE AUDIO CD.***

For recording it is important that the blank disc is completely free from dust particles or scratches (see maintenance).

Recording

English

Introduction

You will soon discover how easy it is to make your own CDs.

Your recorder offers several recording modes.

RECORD DISC

- to make a synchronized recording of the complete disc or a program simply by starting the source.

RECORD TRACK

- to make an synchronized recording of a single track simply by starting the source.

REC(ord) MANUAL

- to manually start a recording simply by pressing the RECORD key.

MAKE CD

- to make a synchronized recording of the complete disc or a program simply by starting the source. Finalizing will be done automatically (active for digital recordings).

For each recording purpose the most appropriate recording mode is explained. Basically a recording session consists of three steps:

- preparing (make all settings for your recording),
- recording (the actual recording starts) and
- finalizing your recording (making CDR(W) suitable for playback on a standard cd-player).

Some remarks on recording

It is advisable to use a CDRW disc for your first try.

- If the disc is a CDR disc and is already finalized, no recording is possible.
- If the disc is a CDRW disc and is already finalized, you must unfinalize it first.
- The recording procedure is the same for CDRs and CDRWs.
- CD text cannot be recorded from an external CD player. (Text information is not available on the output of the CD player.)

- There must be at least 7 seconds of recording time left on the disc, otherwise you will not be able to enter record standby mode. *DISC FULL* will then show on the display.
- If the display indicates *COPY PROTECT* no digital recording can be made of the source material. Recording will not start.
- The Serial Copy Management System (SCMS) only allows digital recording under specific conditions:
 - This means that it is not possible to make a digital copy from a digital copy.
 - Analog recording is always possible!
 - The number of recordings to be made from the original is unlimited.
- A maximum of 99 tracks can be recorded on a disc. Minimum allowable track length is 4 seconds.

Important: Use only discs with CDR AUDIO only or CDRW AUDIO only logo. Discs for use in a personal computer's CD-(re)writer cannot be used in an Audio CD-recorder.

If you want to play the recorded CDR disc on a regular CD player, it must be finalized.

Finalizing is a simple procedure, necessary to:

- be able to play recordings on a CD PLAYER,
- avoid further unwanted recordings on a disc,
- avoid erasure of tracks on a CDRW,
- write CD text on a CDR(W).

Finalized CDRW discs play only on CDRW compatible CD players.

Recording

Adjusting the recording level

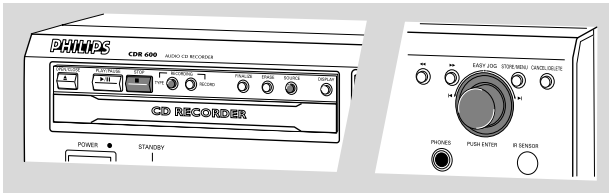

Some analog sources have such high output levels, that you may need to adjust the recording level to ensure good quality recordings without distortion.

- 1 Place an unfinalized CD(RW) disc, absolutely free of scratches and dust particles in the CD recorder tray.
- 2 Press SOURCE repeatedly to select the ANALOG input
→ **ANALOG** lights up and **ANALOG** will appear on the display.
- 3 With the CD recorder stopped, press RECORDING TYPE three times to select REC MANUAL.
→ **↔** starts to flash and the display shows **PRESS RECORD**.
- 4 Start the source by pressing PLAY/PAUSE **▶||**
DO NOT start recording!
- 5 Rotate the EASY JOG/ENTER key to decrease the record level until, on the Record/Play Level bar, all the blue segments are alight, but the red segments do not light continuously during the loudest passages.
- 6 Press STOP **■** on the CD recorder and on the source.
→ The adjusted recording level is stored in the memory of your recorder (also when powered off!).

*Note: The recording level can also be adjusted for digital or optical recordings after selecting the **DIGITAL 1** or **OPTICAL** input.*

Recording an entire CD

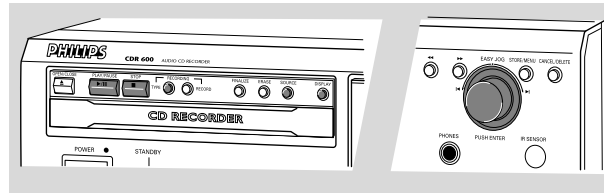

This feature enables you to make fast and easy copy of an entire CD to CD, make a compilation CD or archive an entire LP or cassette on CD.

Preparing

- 1 Place an unfinalized recordable disc, absolutely free of scratches and dust particles in the CD recorder tray.
- 2 Press SOURCE repeatedly to select the type of connection you made to your source of recording. Examples:
 - CD-player is connected with its digital out connector directly to the digital in connector of your CD-recorder: connection is **DIGITAL 1**.
 - CD-player is connected with its analog out connectors directly to analog in connectors of your CD-recorder: connection is **ANALOG**
 - Turntable is connected with its analog out connectors to amplifier/receiver which is connected to the analog in connectors of your CD-recorder: connection is **ANALOG**
- 3 With the CD recorder stopped, press RECORDING TYPE to select **REC DISC** for recording of an entire CD or a program of tracks.
→ **↔** and **sync** start to flash and the display shows the selection.
If the input label **DIGITAL 1** or **OPTICAL** also flashes, switch on the external source or check the digital connection.

Notes:

*If you are recording from a digital source (**OPTICAL** or **DIGITAL 1**) and want to finalize the CD automatically after recording, press RECORDING TYPE until the option **MAKE CD** is selected.*

If you planned to record a compilation of tracks, be sure to have programmed a selection of tracks on the CD-player or CD-changer from which you are going to record.

English

Recording

English

Recording

- 1 To start recording, press Play on the external source from which you want to record. The CD recorder automatically starts recording.
 - If, however, you start the source during a track, recording will start at the beginning of the next track or after 2.7 seconds of silence in analog recordings.
 - Track numbers are automatically incremented. During an analog recording you can insert additional track numbers during recording by simply pressing TRACK INCR. on the remote control.
 - The EASY JOG/ENTER key can be used to adjust the recording level.
 - The recorder stops automatically in case of digital recording from a CD. With AUTO TRACK ON, the recorder pauses and waits for a new track for 1 minute before going to stop. Recordings from DAT, DCC or analog sources will only stop after 20 seconds of silence.
- 2 To stop recording manually, press STOP ■ on the CD recorder.
 - **sync** goes out and the display will show *UPDATE* for several seconds.

Finalizing

If you want to play the recorded CD(RW) on a normal CD player, you must first finalize the disc. Please note that you cannot add anymore tracks on a finalized CDR. See Finalizing CDR and CDRW discs.

Recording a single track

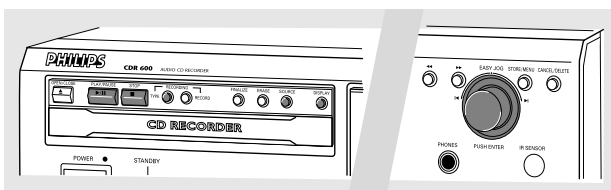

This feature enables you to record a single track from a CD, LP or cassette.

Preparing

- 1 Place an **unfinalized recordable disc**, absolutely free of scratches and dust particles in the CD recorder tray.
- 2 Press SOURCE repeatedly to select the type of connection you made to your source of recording. Examples:
 - CD-player is connected with its digital out connector directly to the digital in connector of your CD-recorder: connection is *DIGITAL I*.
 - CD-player is connected with its analog out connectors directly to analog in connectors of your CD-recorder: connection is *ANALOG*.

- Turntable is connected with its analog out connectors to amplifier/receiver which is connected to the analog in connectors of your CD-recorder: connection is *ANALOG*
 → **DIGITAL I**, **OPTICAL I** or **ANALOG** lights up and *DIGITAL 1*, *OPTICAL 1* or *ANALOG* will appear on the display.

- 3 With the recorder stopped, press RECORDING TYPE two times to select *REC TRACK* for recording of a single track.
 - **↵** and **sync** start to flash and the display shows the selection.

Recording

- 1 To start recording, press Play on the external source from which you want to record. The CD recorder automatically starts recording.
 - If, however, you start the source during a track, recording will start at the beginning of the next track or after 2.7 seconds of silence in analog recordings.
 - The EASY JOG/ENTER key can be used to adjust the recording level.
 - The recorder stops automatically in case of digital recording from a CD. Recordings from DAT, DCC or analog sources will only stop after 20 seconds of silence.
- 2 To stop recording manually, press STOP ■ on the CD recorder.
 - **sync** goes out and the display will show *UPDATE* for several seconds.

Finalizing

If you want to play the recorded CDR(W) on a normal CD player, you must first finalize the disc. Please note that you cannot add anymore tracks on a finalized CDR. See Finalizing CDR and CDRW discs.

Recording

Manual recording

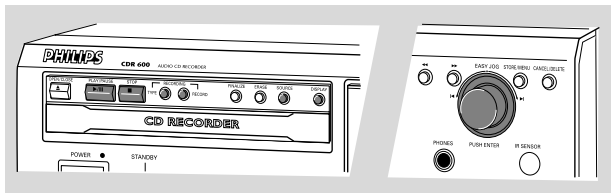

This feature enables you to manually start and stop a recording record from any source. You can use manual recording for recording live music, or for particular music like classic which cannot be recorded with synchronised recording.

Important: For recording from CD-changers, use the RECORD DISC, RECORD TRACK or MAKE CD mode. Do not use REC MANUAL.

Track increments

- During digital recordings, track numbers can be copied automatically from the original.
- For analog recordings, the set can detect silences (longer than 2.7 seconds) in the source material and start a new track. Auto Track is however dependent on the quality of the analog source material and will not always increase the track number like on the original.
- For recordings from noisy external analog sources like LP or cassette tapes we strongly recommend to switch Auto Track to OFF and insert track numbers manually.
- Auto Track is default switched on. If you wish to switch Auto Track off or on:

- 1 Press STORE/MENU.
→ `TEXT EDIT` will appear on the display.
- 2 Rotate the EASY JOG/ENTER key to select the AUTO TRACK submenu.
→ `AUTO TRACK` will appear on the display.
- 3 Press EASY JOG/ENTER to confirm.
→ `ON` or `OFF` will appear on the display.
- 4 Turn the EASY JOG/ENTER key to select Auto track `ON` or `OFF`.
- 5 Press EASY JOG/ENTER to confirm.
→ `AUTO TRACK` will appear on the display.
- 6 Press STOP ■ to exit.

During analog recording, you can always insert track numbers manually by pressing TRACK INCR. on the remote control. The minimum track length is 4 sec. Track numbers cannot be changed after recording.

Preparing

- 1 Place an unfinalized recordable disc, absolutely free of scratches and dust particles in the CD recorder tray.
 - 2 Press SOURCE repeatedly to select the type of connection you made to your source of recording. Examples:
 - CD-player is connected with its digital out connector directly to the digital in connector of your CD-recorder: connection is DIGITAL I.
 - CD-player is connected with its analog out connectors directly to analog in connectors of your CD-recorder: connection is ANALOG
 - Turntable is connected with its analog out connectors to amplifier/receiver which is connected to the analog in connectors of your CD-recorder: connection is ANALOG
- **DIGITAL I**, **OPTICAL I** or **ANALOG** lights up and `DIGITAL 1`, `OPTICAL` or `ANALOG` will appear on the display.
- 3 With the CD recorder stopped press RECORDING TYPE three times to select `REC MANUAL` for recording of a single track.
 - ↵ and **MANUAL** start to flash and the display shows the selection.
- If `CHECK INPUT` message and the input label **DIGITAL I** or **OPTICAL** also flashes, switch on the external source or check the digital connection.
 - You can record a 3-second silence at the start of a track by pressing PLAY/PAUSE ►|| on the CD recorder before starting the recording.

Recording

- 1 To start recording, press RECORD on the CD recorder and immediately start the source.
 - ↵ lights continuously. The track number and recording time will appear on the display.
- To interrupt recording, press PLAY/PAUSE ►|| on the CD recorder.
 - ↵ starts to flash. Resume at step 1.
- 2 To stop recording, press STOP ■ on the CD recorder.
 - `UPDATE` lights up and goes out.

After recording the display will show `UPDATE` for several seconds.

Note: In case of AUTO TRACK ON, the recorder will stop automatically. Recordings from DAT, DCC or analog recordings will stop after 20 seconds of silence. With AUTO TRACK OFF, the recording will not stop automatically.

Finalizing

If you want to play the recorded CD(RW) on a normal CD player, you must first finalize the disc. Please note that you cannot add anymore tracks on a finalized CDR. See Finalizing CDR and CDRW discs.

Recording

English

Finalizing CDR & CDRW discs

During finalizing, the table of contents (TOC) is written to the disc.

Finalizing is a simple procedure that is necessary in order to:

- be able to play recordings on a CD PLAYER
- avoid further unwanted recordings on a disc,
- avoid erasure of tracks on a CDRW,
- write CD text on a CDR(W).

Auto finalizing

The CDR(W) is automatically finalized when using the MAKE CD recording function.

Manual finalizing

- 1 Make sure the disc (in the CD recorder) is absolutely free of scratches and dust particles.
- 2 With the recorder stopped, press FINALIZE.
 - The display will show *FINALIZE []* and *PRESS RECORD*.
- 3 Press RECORD.
 - *xx xx FINAL* and the approximate finalization time is shown on the display. The display counts down through the finalization. Upon completion, the total number of tracks and the total time recorded will appear on the display. For CDR(W), **CDR(W)** changes to **CD** on display.

Finalizing will take at least 2- 4 minutes.

Notes:

During finalization, the CD recorder will not accept operating commands.

When a CDR has been finalized, no more recordings can be added.

Unfinalizing CDRW discs

For CDRW discs only

If you want to make more recordings (or erase tracks) on a finalized disc, you must unfinalize it first. The index of the disc content will be removed.

To unfinalize

- 1 With the CD recorder stopped, press RECORDING TYPE or ERASE.
 - *UNFINALIZE* and *PRESS ENTER* will appear on the display.
 - 2 Press JOG (ENTER).
 - The disc will now be unfinalized and can be used again to record.
- If no further recording or erasure is required, press STOP ■.

Notes:

Unfinalizing will take approximately 1,5 minutes.

*When unfinalizing a CDRW disc with text available, this text will be transferred to the CD recorder memory. However, if the text memory is full, the message *MEMORY FULL /FINALIZE []* will be displayed. Text must be erased, stored for other discs, or another disc must be finalized in order to create space in the memory.*

Recording / Playing

Erasing CDRW discs content

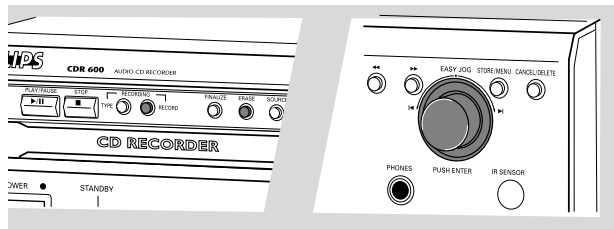

For unfinalized CDRW discs only!

You can erase:

- Tracks can only be erased from the end.
- With the EASY JOG you can select more than one track to be erased simultaneously.

Note: It is not possible to erase tracks within the sequence.

- It is also possible to erase the entire disc at once.

To erase one or more tracks from the end:

- 1 Press ERASE once.
 - The display will show the number of tracks and their total playing time. *ERASE TRACK* and *PRESS RECORD* will light up.
- If the disc is finalized, **CD** will appear on the display after inserting a CDRW in the recorder. The recorder will ask you to confirm unfinalizing first. Confirm by pressing the EASY JOG/ENTER key or ENTER on the remote control.
- 2 Select the track(s) you wish to erase by turning the EASY JOG/ENTER key to the left.
 - The selected track numbers will start blinking on the track bar.
 - The display will show the remaining time after erasing the selected track(s). The track shown will be included in the tracks erased.
- 3 Press RECORD.
 - The display will show the total countdown time and *ERASE*.
 - After the selected track(s) has/have been erased, the display will show the number of remaining tracks and their total playing time.

To erase the entire disc:

- 1 Press ERASE twice.
 - The display will show the number of tracks and their total playing time. *ERASE DISC* and *PRESS RECORD* will light up.
- If the disc is finalized, **CD** will appear on the display after inserting a CDRW in the recorder. The recorder will ask you to confirm unfinalizing first. Confirm by pressing the EASY JOG/ENTER key or ENTER on the remote control.
- 2 Press RECORD.
 - The display will show the total countdown time and *ERASE*. The entire disc will be erased.

Erasing an entire disc may take up to 15 seconds.

Playing a CD

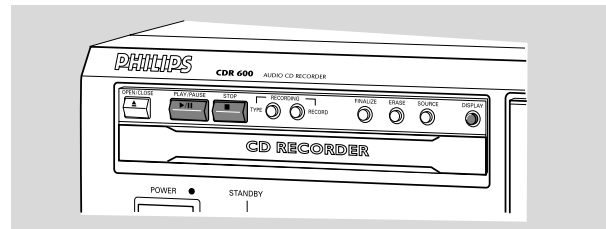

- 1 Press PLAY/PAUSE ►|| to start CD play.
 - ► will light up and the track number and track time of the track in play will appear on the display.
- 2 Press Display once, twice or three times to see:
 - Remaining track time, total remaining time, permanent text information and track time (see Menu mode).
- 3 To interrupt play temporarily, press PLAY/PAUSE ►|| again.
 - || will light on the display
- 4 To continue play, press PLAY/PAUSE ►|| again.
- 5 To stop play, press STOP ■.
 - The number of tracks and the total playing time will appear on the display.

Selecting a track

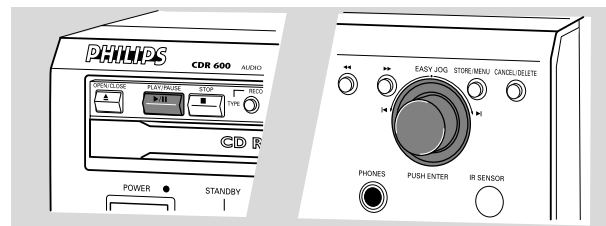

Selecting a track during play

- 1 Turn the EASY JOG/ENTER key until the required track number appears on the display.
 - Play will skip to the beginning of the selected track.

Selecting a track when CD play is stopped

- 1 Turn the EASY JOG/ENTER key until the required track number appears on the display.
- 2 Press EASY JOG/ENTER or ENTER on the remote control to confirm or press PLAY/PAUSE ►|| to start playing.

Note: You can also enter the required track number using the numerical keys on the remote control. For 2 digit numbers, press the keys in rapid succession.

English

Playing

English

Search

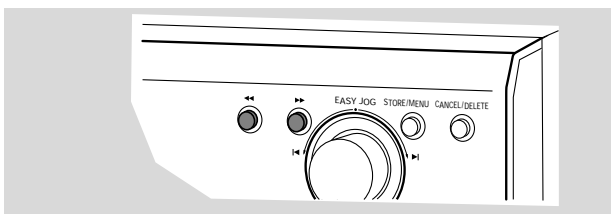

- 1 Hold down ◀◀ or ▶▶ (in Play mode).
→ The player first searches backwards or forwards at 10 times normal speed with sound at low volume, then goes to 50 times normal speed with sound muted.
- 2 Release the button at the desired passage.
→ Play will start at the desired passage.

Note: During Shuffle, Repeat Track or Programmed play, search is restricted to within the track being played at the time.

Shuffle (random order) play

- 1 Press SHUFFLE before or during CD play to start shuffle play.
→ The tracks on the CD (or program if set) will play in random order.
- 2 Press SHUFFLE again to return to normal CD play.
→ CD recorder goes to Stop mode.

Note: Shuffle is also cleared when you open the disc tray.

Repeat CD, track or program

- 1 Press repeat one or more times during CD play.
→ When **REPEAT TRACK** lights up, the current track will play repeatedly. When **REPEAT ALL** lights up, the entire disc or program plays repeatedly.
- 2 To return to normal play, press REPEAT one or more times until:
→ The **REPEAT** text disappears from the display.

Note:

*You can use shuffle in combination with **REPEAT ALL** or programmed play.*

***REPEAT** is also cleared when you open the disc tray.*

Programming tracks

- You can program up to 99 tracks to play in any desired sequence.
- Tracks can be programmed more than once, but each time counts as a track (**STEP**).

Programming

- 1 In Stop mode press PROGRAM to enter Program mode.
→ **PROG** flashes and **PROGRAM** followed by track information appears on the display.
- 2 Select the desired track numbers by turning the EASY JOG/ENTER key left or right and store by pressing ENTER.

or:

Key in a track number with the number keys and press ENTER to confirm. For 2-digit numbers, press the keys in rapid succession.

- The track will be stored in the program.
 - The track number, total program time and the number of programmed tracks (**STEPS**) are displayed.
- 3 Repeat step 2 for all tracks to be programmed.
 - 4 Press STOP ■ or PROGRAM to end programming.
→ **PROG** lights continuously.
 - 5 Press PLAY/PAUSE ▶|| to start programmed play.

Note:

To review the program, press PROGRAM, followed by ◀◀ or ▶▶ with the CD recorder in Stop mode.

To add more tracks to the program, repeat steps 1 to 5.

*If you try to store more than 99 tracks, **PROG FULL** will appear on the display.*

Clearing a program

- 1 Press STOP ■ if necessary to stop programmed play.
 - 2 Press STOP ■ again to clear the program.
→ **PROG** will disappear from the display.
- The program is also cleared when you open the disc tray.

Erasing a track from a program

- 1 In Stop mode press PROGRAM to enter Program mode.
- 2 Use ◀◀ or ▶▶ to select the track from to be deleted.
→ The track number and program step will be shown on the display.
- 3 Press CANCEL/DELETE to erase the track from the program.
→ The remaining program steps and the remaining playing time on the program will be displayed.

Menu mode

Remarks about Menu mode

- In Menu mode you will have access to a number of features which are not available via the regular keys (on the deck's front and the remote control).
- The TEXT submenus (A-B) allow you to give names to discs and tracks. The disc and track names will be displayed during playback.
- In the RECORDING submenus (D-E) you can set Auto Track and Balance.
- All settings (except Balance) made in Menu mode will be stored in the deck's memory and can be called up and changed at any time.

General operation of Menu

Menu active in Recording or Stop mode!

- 1 When using the remote control, select CDR first.
- 2 Press STORE/MENU on the deck or the remote control to enter Menu mode.
→ *TEXT EDIT* will appear on the display.
- 3 Rotate EASY JOG/ENTER to select the required submenu:
- 4 Press EASY JOG/ENTER to confirm your selection.
- 5 Rotate EASY JOG/ENTER to select options in the submenu.
- 6 Press EASY JOG/ENTER to confirm selections.
- 7 Press STORE/MENU to store settings and return to the submenu.
- 8 Press STOP ■ to store settings and exit Menu mode.

*Note: Text can only be edited for unfinalized discs.
(Finalized CDRW discs must be unfinalized first.)*

English

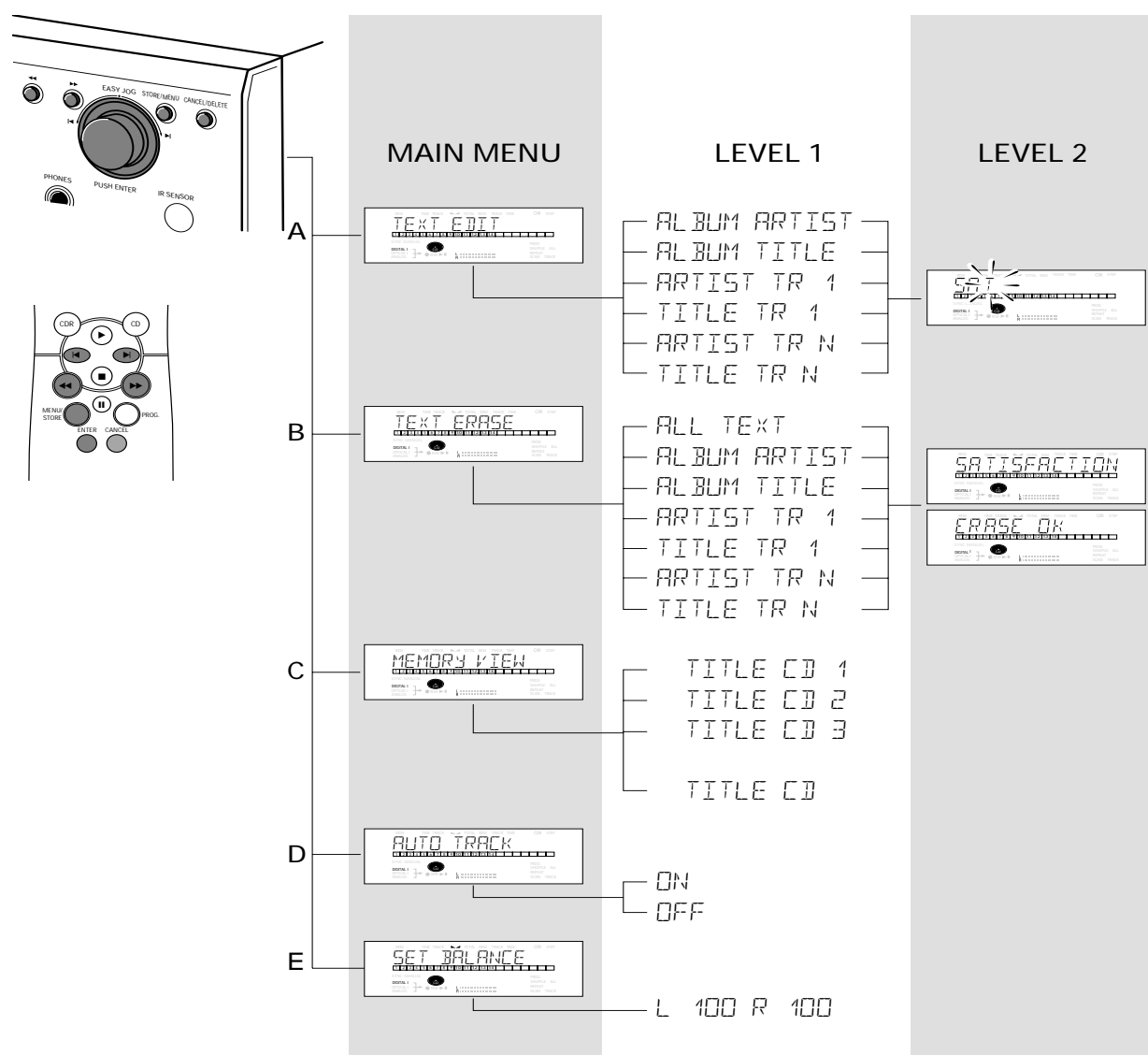

Menu mode

English

A. Text input

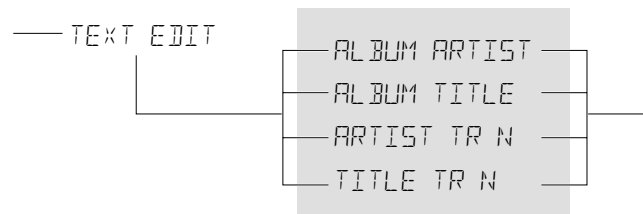

CD text can be added and/or changed to a recording. This can be done in Stop mode or during recording. With this feature you can store the name of artist and album to a CDR as well as a track title and name of artist per title.

Text will be stored in the recorder memory and can be edited until the CDR is finalized. When a CDR(W) is finalized, the CD Text will be written on the disc and removed from the recorder's memory. Text on a (finalized) CDRW can be edited at any time.

- 1 Press STORE/MENU.
→ `TEXT EDIT` will appear on the display.
- 2 Press EASY JOG/ENTER to confirm.
→ `ALBUM ARTIST` will appear on the display.
- 3 Rotate EASY JOG/ENTER to select the required option in the submenu: `ALBUM ARTIST`, `ALBUM TITLE`, `ARTIST TR 1`, `TITLE TR 1`, etc.
- 4 Press EASY JOG/ENTER to confirm.
→ The first character space appears on the display.
- 5 Select the characters by rotating the EASY JOG/ENTER key or by pressing the corresponding numeric/alphabet key on the remote control.
- 6 Press EASY JOG/ENTER to store each character and move to the next cursor position.
 - With the ◀ and ▶ keys you can move to a required cursor position.
 - With the CANCEL key you can delete a character.
- 7 Press STORE/MENU to store the name you have entered and return to the submenu, or STOP ■ to exit.

Notes:

*A maximum of 60 characters can be stored per item.
By pressing the EASY JOG/ENTER key or ENTER on the remote control without selecting a character first, you can insert a space between characters.*

When an artist's name has been stored for a certain track, the name will automatically be copied for the next track. The name can be confirmed by pressing STORE/MENU or a new name can be entered as described above.

B. Erasing text

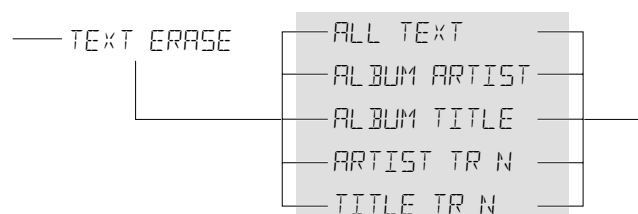

- 1 Press STORE/MENU.
→ `TEXT ERASE` will appear on the display.
- 2 Rotate the EASY JOG/ENTER key to select the TEXT ERASE submenu.
→ `TEXT ERASE` will appear on the display.
- 3 Press EASY JOG/ENTER to confirm.
→ `ALL TEXT` appear on the display.
- 4 Rotate EASY JOG/ENTER to select the required option in the submenu: `ALL TEXT`, `ALBUM ARTIST`, `ALBUM TITLE`, `ARTIST TR 1`, `TITLE TR 1`, etc.
- 5 Press EASY JOG/ENTER to confirm.
→ The display will ask you to reconfirm your selection.
`ERASE OK` will appear on the display.
- 6 Press EASY JOG/ENTER to reconfirm.
→ `UPDATE` will appear on the display.
- 7 Press STORE/MENU to return to the submenu or STOP ■ to exit.

Menu mode

C. Reviewing CD text in memory

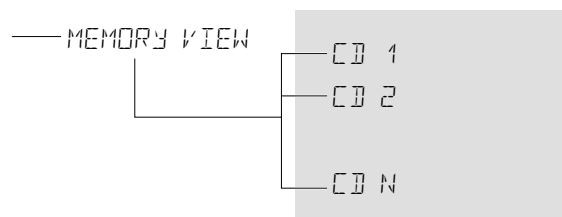

CD text is stored in the recorder's memory. When a CDR(W) is finalized, the CD Text will be written on the disc and removed from the recorder's memory. With the MEMORY VIEW function you can view/delete the CD text in the recorder's memory for each unfinalized disc. The amount of memory used is displayed each time the tray opens with an unfinalized CDR(W) inserted (e.g. MEMORY 90/10).

- 1 Press STORE/MENU.
→ `TEXT EDIT` will appear on the display.
- 2 Rotate the EASY JOG/ENTER key to select the MEMORY VIEW submenu.
→ `MEMORY VIEW` will appear on the display.
- 3 Press EASY JOG/ENTER to confirm.
→ The first album title in the recorder memory will appear on the display.
- 4 Select the album title you wish to erase.
- 5 Press EASY JOG/ENTER to confirm.
→ `ERASE MEMORY` will appear on the display.
- 6 Press the EASY JOG/ENTER key to confirm the erasure of the text for that particular disc.
→ `UPDATE` will appear on the display.
- 7 Press STORE/MENU to return to the submenu or STOP ■ to exit.

Notes:

If there are no discs in the memory, the message `MEMORY EMPTY` will appear on the display.

When the text memory of your CD recorder is full, the message `MEMORY FULL` will appear, followed by `FINALIZE CD`. If you want to add a CD to the list of discs for which text is stored, you will have to erase a disc from this list or finalize another disc for which text is stored.

`MEMORY FULL/FINALIZE CD` may also appear when unfinalizing a CDRW disc for which text was stored (see 'Unfinalizing CDRW discs'). The same action(s) should be taken in order to obtain memory space.

D. Auto track increment

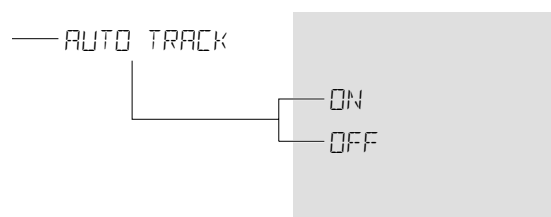

Track increments

During synchronised recordings, track numbers will be copied from the original. This will be done automatically for digital sources. For analog recordings, the set can detect silences (longer than 2.7 seconds) in the source material and start a new track (Auto track increment).

Auto Track is however dependent on the quality of the analog source material and will not always increase the track number like on the original.

Auto Track is default switched on. If you wish to switch Auto Track off or on:

- 1 Press STORE/MENU.
→ `TEXT EDIT` will appear on the display.
- 2 Rotate the EASY JOG/ENTER key to select the AUTO TRACK submenu.
→ `AUTO TRACK` will appear on the display.
- 3 Press EASY JOG/ENTER to confirm.
→ `ON` or `OFF` will appear on the display.
- 4 Turn the EASY JOG/ENTER key to select Auto track `OFF` or `ON`.
- 5 Press EASY JOG/ENTER to confirm.
→ `AUTO TRACK` will appear on the display.
- 6 Press STOP ■ to exit.

During analog recording, you can always insert track numbers manually by pressing TRACK INCR. on the remote control. It is not possible to add track numbers manually during digital recording. The minimum track length is 4 sec. Track numbers cannot be changed after recording.

Note: Auto Track is always active during synchronised recordings.

Menu mode

English

E. Balance

SET BALANCE

L 100 R 100

This feature is only active in Record/Standby mode

- 1 Press STORE/MENU.
→ `TEXT EDIT` will appear on the display.
- 2 Rotate the EASY JOG/ENTER key to select the SET BALANCE submenu.
→ `SET BALANCE` will appear on the display.
- 3 Press EASY JOG/ENTER to confirm.
→ `◀▶` and `L 100 R 100` will appear on the display.
- 4 Adjust recording balance by turning the EASY JOG/ENTER key.
 - Turn to the left: the figure on the left (`▶`) counts down, that on the right counts up.
 - Turn to the right: the figure on the right (`◀`) counts down, that on the left counts up.
- 5 Press EASY JOG/ENTER to confirm.
- 6 Press STORE/MENU to store settings.

Note: The balance setting will not be stored permanently.

Troubleshooting

English

WARNING

Under no circumstances should you try to repair the set yourself as this will invalidate the guarantee.

Do not open the set as there is a risk of electric shock.

If a fault occurs, first check the points listed, before taking the set for repair. If you are unable to solve a problem by following these hints, consult your dealer or service centre.

Laser safety

This unit employs a laser. Only a qualified service person should remove the cover or attempt to service this device, due to possible eye injury.

Problem	Solution:
No power	<ul style="list-style-type: none"> – ensure that the ON/OFF key is in the on position (red LED on): the CD recorder is in standby mode, press any key to activate it – make sure that the power cable is plugged in correctly – switch the recorder OFF and then immediately back ON
No sound	<ul style="list-style-type: none"> – check the audio connections – try using a different source on the amplifier
Amplifier sound is distorted	<ul style="list-style-type: none"> – make sure that the CD recorder analog output is not connected to the amplifier Phono input
Play will not start	<ul style="list-style-type: none"> – make sure that the label of the CD is facing up – clean the disc – make sure that the disc is not defective by trying another disc
Remote control does not work	<ul style="list-style-type: none"> – press CDR on the remote control and try again – point the remote control directly at the CD recorder – check the batteries and replace if necessary – select the right source first
Will not record	<ul style="list-style-type: none"> – clean the disc – check if CDR(W) is an unfinalized disc – check that the disc is recordable and replace if necessary – the disc is not an AUDIO disc (WRONG DISC) – wrong input source chosen. Input label flashing (CHECK INPUT) – try using a Philips Audio CDR(W)
Recording is distorted	<ul style="list-style-type: none"> – make sure the recording level is correct
20 second pause between recordings	<ul style="list-style-type: none"> – see "Autostart recording".
Recorder does not react	<ul style="list-style-type: none"> – switch the ON/OFF button on the front of the recorder off and back on
DISC RECOVER on display	<ul style="list-style-type: none"> – a power failure has occurred during recording; the CD recorder is attempting to repair the disc
DISC ERROR appears on the display	<ul style="list-style-type: none"> – the disc cannot be recorded further, and cannot be finalized. – on a CDRW disc, the track being recorded is lost, but further recording and finalization can still be done
Recorded tracks do not start or stop at the correct time or tracks have been merged together	<ul style="list-style-type: none"> – try another auto track setting – check if there are at least 2.7 seconds silence in between the tracks (analog recording only) – insert track increments manually with the remote control
START SOURCE indication	<ul style="list-style-type: none"> – start the synchronized external recording by pressing PLAY on the external source you wish to record from.

CDR 600 Audio CD Recorder

English

Français

Español

Deutsch

Nederlands

Italiano

Svenska

Dansk

Suomi

Português

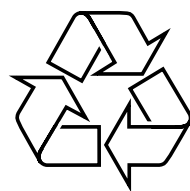

Meet Philips at the internet <http://www.philips.com>

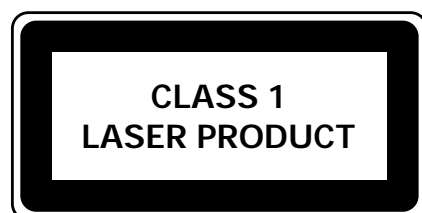

Free Manuals Download Website

<http://myh66.com>

<http://usermanuals.us>

<http://www.somanuals.com>

<http://www.4manuals.cc>

<http://www.manual-lib.com>

<http://www.404manual.com>

<http://www.luxmanual.com>

<http://aubethermostatmanual.com>

Golf course search by state

<http://golfingnear.com>

Email search by domain

<http://emailbydomain.com>

Auto manuals search

<http://auto.somanuals.com>

TV manuals search

<http://tv.somanuals.com>