

Register your product and get support at
www.philips.com/welcome

Streamium

NP3700/12



EN User manual

PHILIPS

Contents

1 Important	5	Play Internet radio stations	26
Safety	5	Tune to Internet radio stations	27
Environmental notices	6	Store preset stations	27
Recycling	6	Edit favorite stations	27
2 Your NP3700	8	Manage Internet radio online	28
Introduction	8	Manually add stations online	30
What's in the box	8	Stream from online music services	30
Overview	9	Search for music	31
Front and rear view	9	Alphanumeric search	31
Remote control	10	Quickjump	31
Touch screen	12	Superscroll	32
Home screen	12	6 Multiroom Music	33
Play screen	13	7 Play from an external audio device (AUX)	34
Text entry	13	Play from an external audio device	34
3 Prepare	15	8 Settings	35
Install batteries into the remote control	15	Play modes	35
Connect external audio devices	15	Sound settings	35
Connect an iPod / iPhone dock	15	Incredible Surround	35
Connect power supply	16	Bass and treble	35
4 First-time setup	17	Full sound	35
Connect to home Wi-Fi/wired network	18	Direct Source	35
Wireless connection: One-touch Wi-Fi Protected Setup (WPS)	19	Display settings	36
Wireless connection: Enter encryption key manually	20	Brightness	36
Wireless connection: Enter IP address manually	21	Wallpaper	36
Wired connection	22	Screensaver	36
Wired connection: Enter IP address manually	23	Slideshow settings	36
5 Play from home Wi-Fi/wired network	24	Album art	36
Stream from a UPnP server	24	Clicker sound	37
Library on a UPnP server	25	Clock settings	37
Stream from a UPnP server	25	Alarm	37
		Sleep timer	38
		Date and time	38
		Network settings	39
		Setup network	39
		Device name	39
		USB sharing	40
		Location and time zone	40
		Language	40
		Device information	40
		Check for software upgrades	40
		Demo mode	40
		Call center numbers	40
		Restore factory settings	40

9 Register NP3700 with Philips	41
Benefits	41
Register NP3700	41
Register on the web site	41
Register on the device	41
Unregister NP3700	42
Check registration information	42

10 Maintenance	43
Cleaning	43

11 Technical data	44
--------------------------	----

12 Troubleshooting	46
---------------------------	----

13 Contact information	47
-------------------------------	----

1 Important

Safety

Information for Europe:

Know these safety symbols

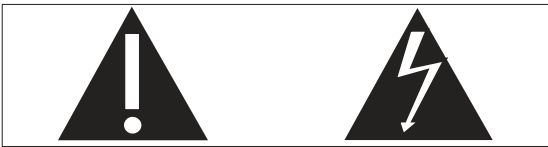
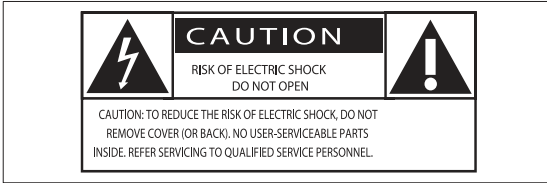

The 'exclamation mark' calls attention to features for which you should carefully read the supplied literature to prevent operating and maintenance problems.

The 'lightening bolt' symbol indicates uninsulated components within the product that can cause an electric shock.

To reduce the risk of fire or electric shock, do not expose the product to rain or moisture and do not place any objects filled with liquids, such as vases, on the product.

- ① Read these instructions.
- ② Keep these instructions.
- ③ Heed all warnings.
- ④ Follow all instructions.
- ⑤ Do not use this product near water.
- ⑥ Clean only with dry cloth.
- ⑦ Do not block any ventilation openings. Install in accordance with the manufacturer's instructions.
- ⑧ Do not remove the casing of this product.

- ⑨ Only use this product indoors. Do not expose the product to dripping / splashing water, rain or high humidity.
- ⑩ Keep this product away from direct sunlight, naked flames or heat.
- ⑪ Do not install near any heat sources such as radiators, heat registers, stoves, or other electrical equipment (including amplifiers).
- ⑫ Do not place any other electrical equipment on the product.
- ⑬ Do not place any sources of danger on the product (e.g. objects containing liquids, burning candles).
- ⑭ This product may include batteries. Please refer to safety and disposal instructions for batteries in this user manual.
- ⑮ This product may contain lead and mercury. Disposal of these materials may be regulated due to environmental considerations. Please refer to disposal instructions in this user manual.



Warning

- Never remove the casing of this apparatus.
- Never lubricate any part of this apparatus.
- Never place this apparatus on other electrical equipment.
- Keep this apparatus away from direct sunlight, naked flames or heat.
- Ensure that you always have easy access to the power cord, plug or adaptor to disconnect this apparatus from the power.
- Where the mains plug or an appliance coupler is used as the disconnect device, the disconnect device shall remain readily operable.

Risk of overheating! Never install this apparatus in a confined space. Always leave a space of at least four inches around this apparatus for ventilation. Ensure curtains or other objects never cover the ventilation slots on this apparatus.

Hearing Safety



Listen at a moderate volume:

Using headphones at a high volume can impair your hearing. This product can produce sounds in decibel ranges that may cause hearing loss for a normal person, even for exposure less than a minute. The higher decibel ranges are offered for those that may have already experienced some hearing loss.

Sound can be deceiving. Over time your hearing 'comfort level' adapts to higher volumes of sound. So after prolonged listening, what sounds 'normal' can actually be loud and harmful to your hearing. To guard against this, set your volume to a safe level before your hearing adapts and leave it there.

To establish a safe volume level:

Set your volume control at a low setting.

Slowly increase the sound until you can hear it comfortably and clearly, without distortion.

Listen for reasonable periods of time:

Prolonged exposure to sound, even at normally 'safe' levels, can also cause hearing loss.

Be sure to use your equipment reasonably and take appropriate breaks.

Be sure to observe the following guidelines when using your headphones.

Listen at reasonable volumes for reasonable periods of time.

Be careful not to adjust the volume as your hearing adapts.

Do not turn up the volume so high that you can't hear what's around you.

You should use caution or temporarily discontinue use in potentially hazardous situations.

Environmental notices



This product complies with the radio interference requirements of the European Community.

CE 0560 ! R&TTE Directive 1999/5/EC							
BG ✓	RO ✓	BE ✓	LT ✓	LI ✓	IS ✓	SE ✓	
DK ✓	ES ✓	CZ ✓	NL ✓	AT ✓	LV ✓	SK ✓	
FR ✓	UK ✓	FI ✓	PT ✓	CY ✓	MT ✓	PL ✓	
HU ✓	NO ✓	GR ✓	SI ✓	EE ✓			
IT ✓	LU ✓	IE ✓	CH ✓	DE ✓			

This product complies with the requirement of the 1999/5/EC directive.

Class II equipment symbol:



This symbol indicates that this product has a double insulation system.

Modifications

Modifications not authorized by the manufacturer may void user's authority to operate this product.

Recycling



Your product is designed and manufactured with high quality materials and components, which can be recycled and reused.

When you see the crossed-out wheel bin symbol attached to a product, it means the product is covered by the European Directive 2002/96/EC:



Never dispose of your product with other household waste. Please inform yourself about the local rules on the separate collection of electrical and electronic products. The correct disposal of your old product helps prevent potentially negative consequences on the environment and human health.

Information about the use of batteries:



Caution

- Risk of leakage: Only use the specified type of batteries. Do not mix new and used batteries. Do not mix different brands of batteries. Observe correct polarity. Remove batteries from products that are not in use for a longer period of time. Store batteries in a dry place.
- Risk of injury: Wear gloves when handling leaking batteries. Keep batteries out of reach of children and pets.
- Risk of explosion: Do not short circuit batteries. Do not expose batteries to excessive heat. Do not throw batteries into the fire. Do not damage or disassemble batteries. Do not recharge non-rechargeable batteries.

Battery disposal information:

Your product contains batteries covered by the European Directive 2006/66/EC, which cannot be disposed of with normal household waste.

Please inform yourself about the local rules on separate collection of batteries. The correct disposal of batteries helps prevent potentially negative consequences on the environment and human health.



Be responsible
Respect copyrights

The making of unauthorized copies of copy-protected material, including computer programs, files, broadcasts and sound recordings, may be an infringement of copyrights and constitute a criminal offence. This equipment should not be used for such purposes.

This item incorporates copy protection technology that is protected by U.S. patents and other intellectual property rights of Rovi Corporation. Reverse engineering and disassembly are prohibited.

2 Your NP3700

Congratulations on your purchase, and welcome to Philips! To fully benefit from the support that Philips offers, register your product at www.philips.com/welcome.

Introduction

NP3700 can

- Connect to the existing home Wi-Fi/wired network, which can consist of computers and UPnP devices;
- Connect the existing audio systems and MP3 players.
- Connect an iPod/iPhone dock.

With such connections, you can

- Play Internet radio stations and *online music services over the Internet;
- Play music stored on a computer/UPnP server;
- Play music from an audio system/portable media player through the speakers.
- Charge or play your iPod/iPhone through this unit.



Tip

- *Online services are available in some countries only.

What's in the box

Check and identify the contents of your package:

- Main unit
- Remote control with batteries
- AC power adapter
- Software suite on a CD-ROM
- Quick Start Guide

Overview

Front and rear view

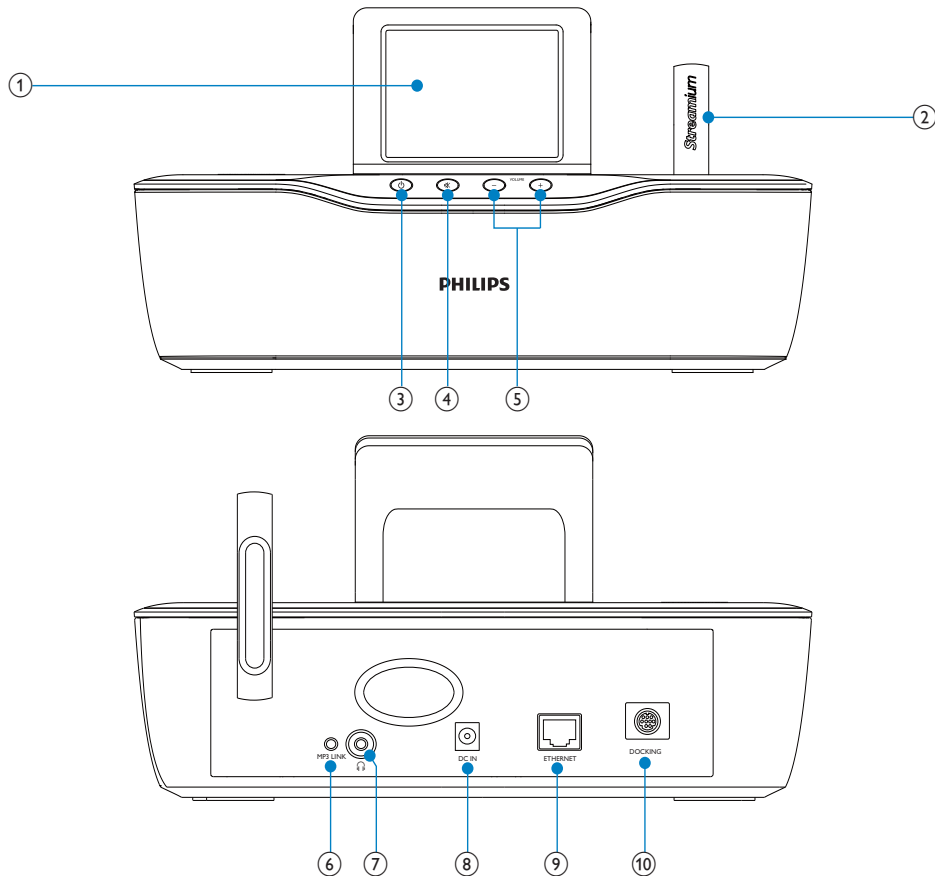

1.	LCD display
2.	Wi-Fi antenna
3.	STANDBY
	Press to turn on the set; To turn off, press to switch to active standby; or, press and hold to switch to Eco standby. Exit Demo mode.
4.	Mute/ unmute sound.
5.	- VOLUME + Increase/decrease volume.
6.	MP3 LINK Audio input socket for a portable media player to play through the speakers on this unit
7.	3.5 mm headphone jack
8.	DC IN Socket for the AC power adapter
9.	ETHERNET Socket for the Ethernet cable that connects NP3700 with the home Wi-Fi/wired network, if you want a wired connection to the home Wi-Fi/wired network
10.	DOCKING Socket for connection of an iPod/ iPhone dock (not supplied)

Remote control

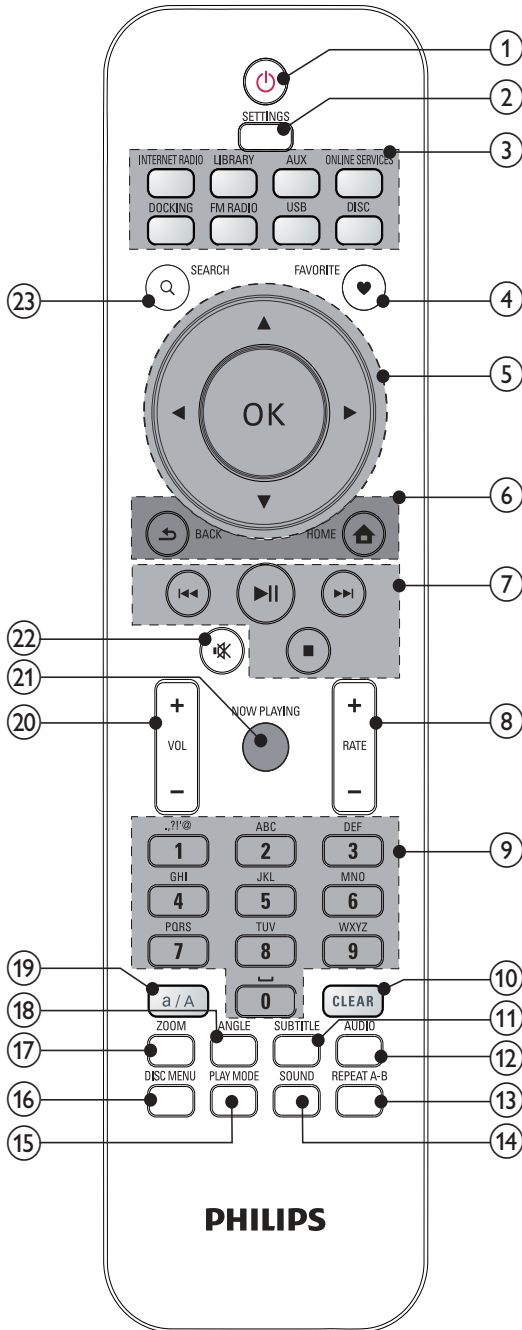

- 

Press to turn on the unit;
To turn off, press to switch to active standby; or, press and hold to switch to Eco standby.

Exit Demo mode.
- SETTINGS**

Enter the settings menus.
- Source selector**

Select a media source (**FM RADIO**, **USB**, and **DISC** are for MCI8080 only):

INTERNET RADIO: Radio services provided over the Internet;

LIBRARY: Media library on a UPnP media server;

AUX: Connected external audio device (e.g. an MP3 player or other portable music players);

ONLINE SERVICES: Supported music services provided over the Internet (available in some countries only);

DOCKING: Supported media on the connected iPod/iPhone;
- FAVORITE**

In **INTERNET RADIO** mode:
Add current station to the list of Favorite Stations.
- 









Navigation buttons
Press to navigate through menus.



In **LIBRARY/INTERNET RADIO** mode:
Superscroll: In a long list of options, press and hold to start Superscroll. Release to jump to the first item starting with current alphabet/number.

OK

Confirm selection.

6.		HOME: Return to Home screen (main menu).
		BACK: Go back to previous screen.
7.		Search buttons on the play screen
		In LIBRARY mode: Press to skip to the previous/next chapter/track;
		Start/pause/resume play; In LIBRARY mode: Start to play the entire file folder (SuperPlay™).
		Stop play; Exit Demo mode.
8.	+RATE –	In ONLINE SERVICES mode: Increase/decrease rating* of current music.
9.	Alphanumeric buttons	For text entry
		In INTERNET RADIO mode: On the radio play screen, press and hold a numeric button to store current station in the location as a preset station.
		In LIBRARY/INTERNET RADIO mode: Quickjump: In a long list of options that are sorted in an alphabetical order, press once or repeatedly to select an alphabet, and jump to the first item that starts with the selected alphabet.

10.	CLEAR	Press to delete the previous entry; Press and hold to delete all entries.
11.	SUBTITLE (for MCI8080 only)	
12.	AUDIO (for MCI8080 only)	
13.	REPEAT A-B (for MCI8080 only)	
14.	SOUND	Select sound settings.
15.	PLAY MODE	Select repeat play or random play.
16.	DISC MENU (for MCI8080 only)	
17.	ZOOM (for MCI8080 only)	
18.	ANGLE (for MCI8080 only)	
19.	a/A	Press to switch between lower and upper cases.
20.	+VOL –	Increase/decrease the volume.
21.	NOW PLAYING	Return to play screen.
22.		Mute/unmute sound.
23.	SEARCH	Press to start the search/ browsing by alphanumeric entry.

Note

- * Rating current music is available only for music services that support rating, and is available only in some countries.

Touch screen

NP3700 is equipped with a touch screen.



- If necessary, tap on the screen to show functional buttons;
- Tap on the buttons to select corresponding functions;
- Tap on an option to select.

Home screen

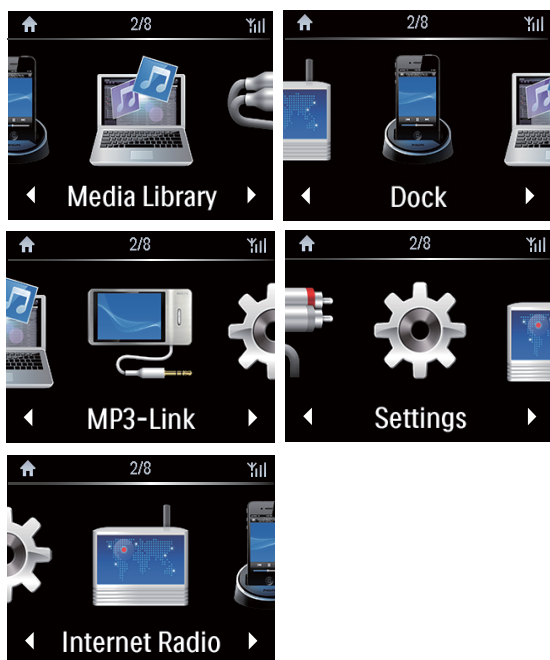

On NP3700, you enter Home screen after the first-time setup is complete.

To select a music source, or enter the [Settings] menu

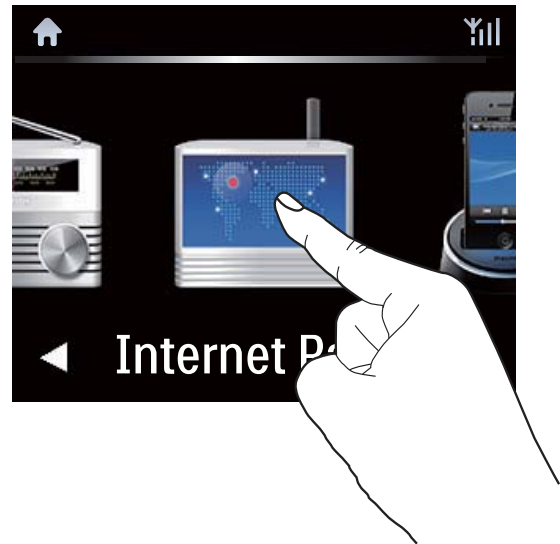

- On Home screen, tap on  to navigate through icons. Tap on the corresponding icon to select.



- Or, press /OK on the remote control to select the desired source.

To go back to previous screen

- Press .

To return to Home screen

- Press .

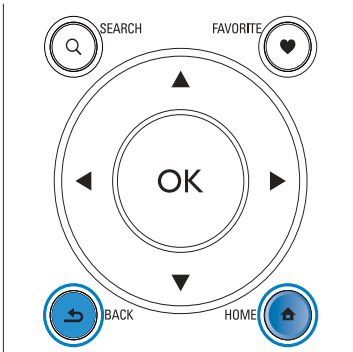

Play screen

In **LIBRARY/INTERNET RADIO/ONLINE SERVICES** mode, Play screen appears when play starts.



To navigate through menus during music play, do the following:

- 1 On the remote control, press and then, use the Navigation buttons.
- 2 To return to Play screen, press **NOW PLAYING**.

Tip

- On Play screen, you can also press and repeatedly to select songs.

Text entry

To enter text and symbols, you can:

- tap on the text box and enter text and symbols with the pop-up keypad directly
- press corresponding alphanumeric buttons on the remote control

Text entry with the remote control

- To enter letters/numbers/symbols corresponding to the same alphanumeric button, briefly and repeatedly press the button.

English		
	abc...	ABC...
1	1.,?!'@- _::/'"#S%& ()*+<=>[]^' { } ~	1.,?!'@- _::/'"#S%& ()*+<=>[]^' { } ~
2	abc2	ABC2
3	def3	DEF3
4	ghi4	GHI4
5	jkl5	JKL5
6	mno6	MNO6
7	pqrs7	PQRS7
8	tuv8	TUV8
9	wxyz9	WXYZ9
0	_0	_0

- To enter symbols, press repeatedly.
- To enter space, press .
- To switch between lower and upper cases, press .
- To delete previous character, press . To delete all entries, press and hold .

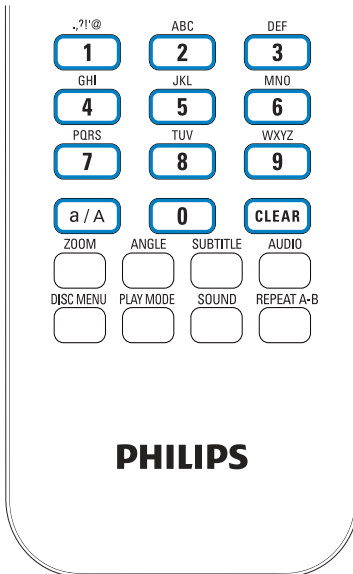

Other Languages	
abc...	ABC...
1.,?!@- :/'#\$%& ()*+<=>[N^`{ }~	1.,?!@- :/'#\$%& ()*+<=>[N^`{ }~
abc2àáâãäåæ	ABC2ÀÁÂÃÄÅÆ
def3èéêë	DEF3ÈÉÊË
ghi4íîï	GHI4ÍÎÏ
jkl5	JKL5
mno6ñòóôõöø	MNO6ÑÓÔÕÖØ
pqrs7ß	PQRS7ß
tuv8ùúûü	TUV8ÚÛÜ
wxyz9	WXYZ9
0	0



Tip

- For languages other than English, letters that an alphanumeric button corresponds to may vary.

Русский	
абв...	АБВ...
1.,?!@- :/'#\$%& ()*+<=>[N^`{ }~	1.,?!@- :/'#\$%& ()*+<=>[N^`{ }~
абвг2abc	АБВГ2ABC
дежз3def	ДЕЖЗ3DEF
ийкл4ghi	ИЙКЛ4GHI
mnop5jkl	МНОП5JKL
рсту6mno	РСТУ6MNO
фхцч7pqrs	ФХЦЧ7PQRS
шщъы8tuv	ШЩЪЫ8TUV
ьэюя9wxyz	ЬЭЮЯ9WXYZ
0	0

3 Prepare

Install batteries into the remote control

! Caution

- Risk of explosion! Keep batteries away from heat, sunshine or fire. Never discard batteries in fire.
- Risk of decreased battery life! Never mix different brands or types of batteries.
- Risk of product damage! When the remote control is not used for long periods, remove the batteries.

- 1 Open the battery compartment.
- 2 Insert two AAA R03 batteries with correct polarity (+/-) as indicated.
- 3 Close the battery compartment.

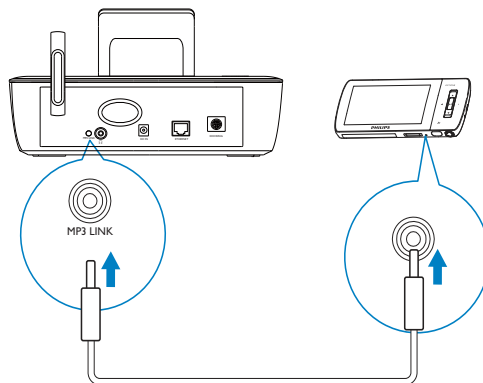
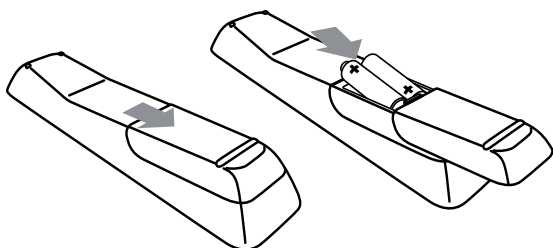

Connect an iPod / iPhone dock

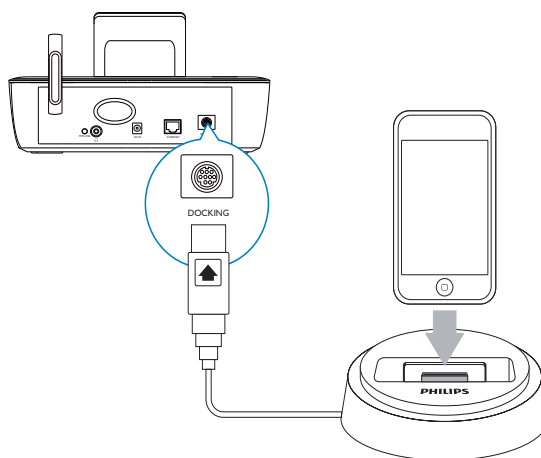

Connect external audio devices

You can listen to an external audio device through this unit. To do so, do the following connection, and then select the **AUX** mode on NP3700.

With the connected iPod / iPhone dock, you can charge or listen to music from your iPod / iPhone through this unit.

- Connect a dock (not supplied) to the **DOCKING** socket on this unit.

* Tip

- To listen to music from the docked iPod / iPhone, first press **DOCKING** to select the dock source.

Connect power supply

Warning

- Risk of product damage! Ensure that the power supply voltage corresponds to the voltage printed on the back or the underside of the product.

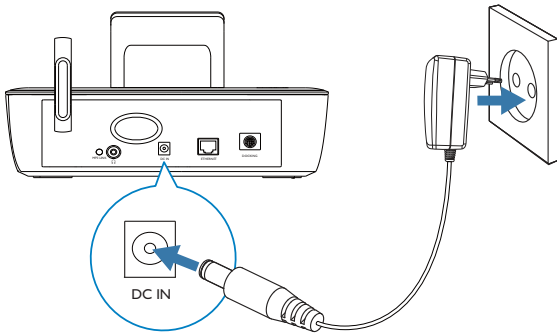



- Connect **NP3700** to the power supply.

Note

- The type plate information is located at the bottom of the product.

4 First-time setup

The first time you turn on NP3700,

- 1 Select the desired language on the screen as prompted.
- 2 **To learn major functions on NP3700,**
 - Select **[Yes, show me the demo]**, when asked whether to view demo;
 - If necessary, press **+VOL-** to adjust the volume;
 - To exit the demo play, press .
 - ↳ The unit is switched to Eco standby.
 - ↳ Press  again to turn on **NP3700**, and restart the setup.

To proceed to network setup,

 - Select **[No]**, when asked whether to view demo.
- 3 Select your location and time zone from the list as prompted.
- 4 Select **[Yes]**, when asked whether to set up network connection.

Connect to home Wi-Fi/ wired network

Connect wirelessly

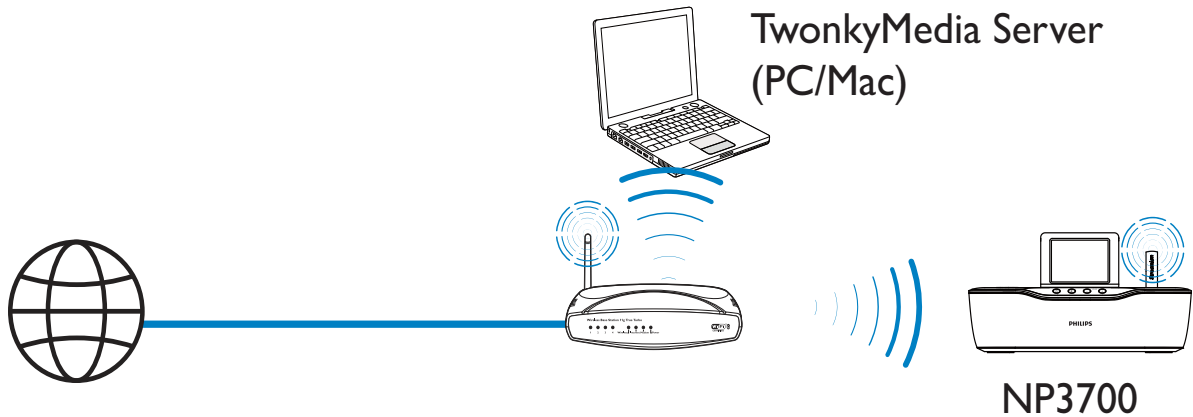

Connect through an Ethernet cable

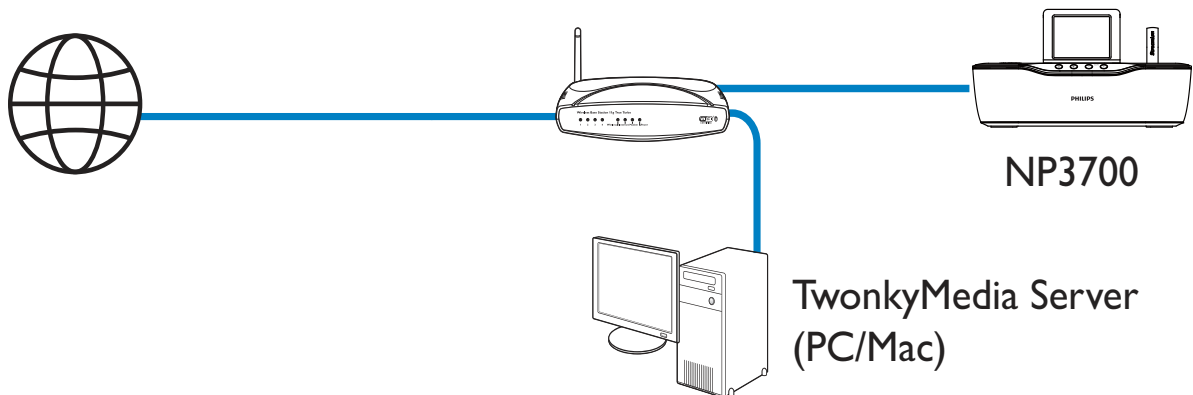

You can connect **NP3700** to home Wi-Fi/
wired network in different ways: wireless or
wired, automatic or manual.

- Use a router (or Access Point) for home Wi-Fi/wired network. That is, connect computers/devices to a router.
- Connect **NP3700** to the router wirelessly or through an Ethernet cable.
- To have the unit connected to the Internet over home Wi-Fi/wired network, ensure that the router connects to the Internet directly and no dial-up is required on the computer.
- To switch between different connection methods (wireless or wired, automatic or manual), or switch between different routers, go to **[Settings] > [Network settings] > [Setup network]**.

Wireless connection: One-touch Wi-Fi Protected Setup (WPS)

NP3700 supports Wi-Fi Protected Setup(WPS). You can quickly and securely connect **NP3700** to a wireless router that also supports the WPS.

You can select one of the two setup methods: PBC (Push Button Configuration), or PIN (Personal Identification Number).

Tip

- Wi-Fi Protected Setup(WPS) is a standard created by Wi-Fi Alliance for easy establishment of secure wireless home network.

Turn on WPS-PBC on NP3700

- 1 Select **[Yes]**, when asked whether to set up network connection (see 'First-time setup').
- 2 Select **[Wireless (WiFi)] > [Push button (WPS - PBC)]**.

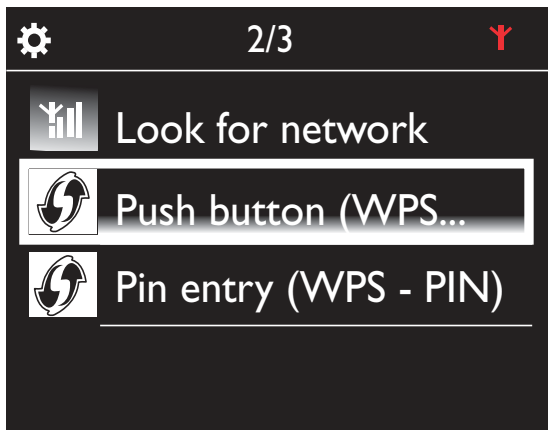

Add NP3700 on the router

- Consult the user manual of the router to learn how to add a WPS device to the router. For example: press and hold the WPS push button.
 - ↳ The router starts to search for a WPS device.

- ↳ On NP3700, a message appears when the connection is completed successfully.

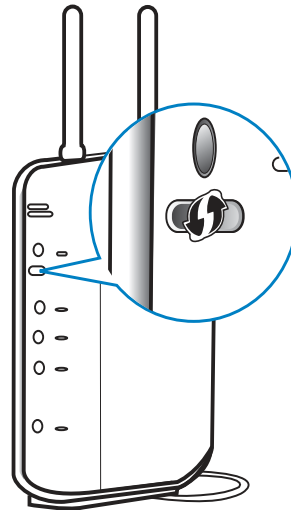

Tip

- To use PIN (Personal Identification Number) as the setup method: On **NP3700**, select **[Wireless (WiFi)] > [Pin entry (WPS - PIN)]**, and write down the PIN that is displayed on **NP3700**; On the router, enter the PIN.
- Consult the user manual of the router to learn how to enter the PIN the router.

Connect to the Internet

- Connect to the Internet as prompted.
 - ↳ You enter Home screen after the first-time setup is complete.

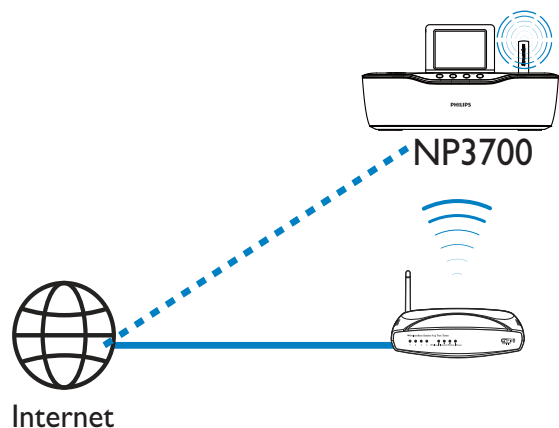

Note

- Ensure that the router connects to the Internet directly and no dial-up is required on the computer.

Wireless connection: Enter encryption key manually



Tip

- Before you start the network setup, have the encryption key to your router ready.

- 1 Select **[Yes]**, when asked whether to set up network connection (see 'First-time setup').
- 2 Select **[Wireless (WiFi)] > [Look for network]**.
 - ↳ The unit starts to search for wireless networks.
 - ↳ A list of available Wi-Fi networks appears.

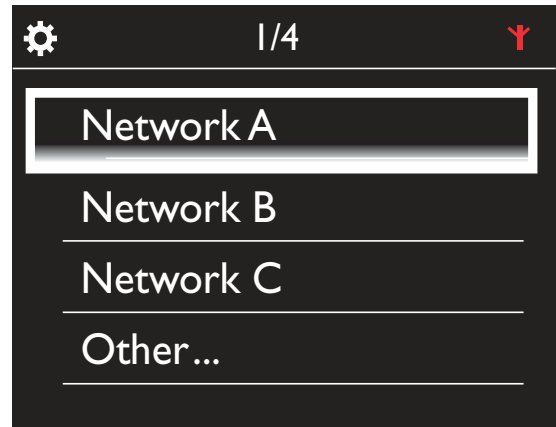
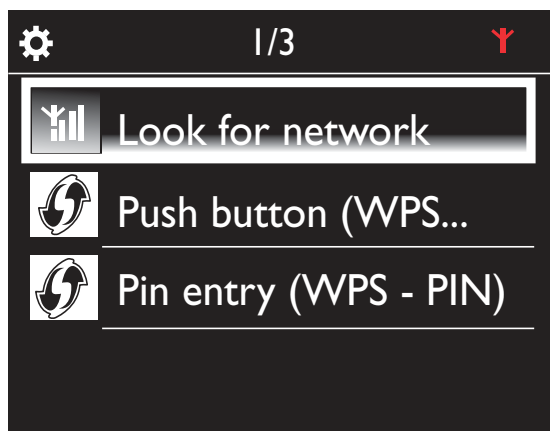

- 3 Select the desired Wi-Fi network.
- 4 As prompted, enter the encryption key to the network.
 - ↳ The unit starts to acquire an IP address assigned by the Wi-Fi network automatically.
 - ↳ A message appears when the connection is completed successfully.

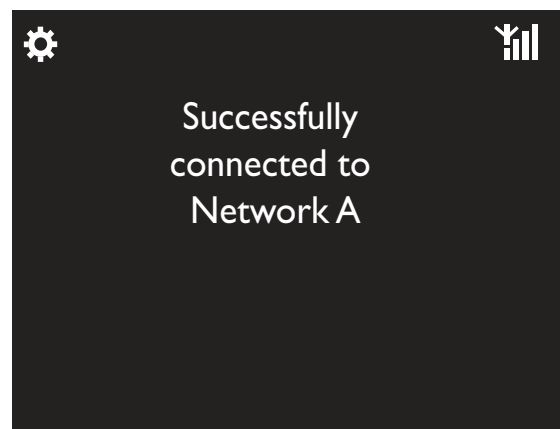
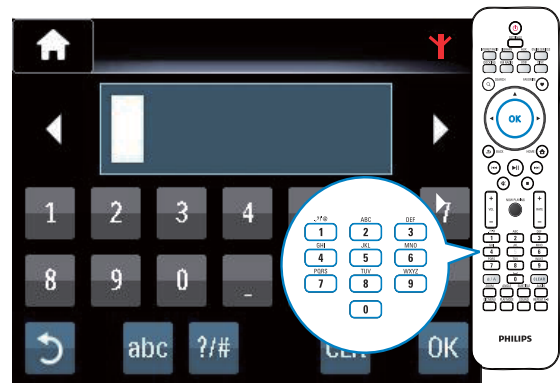

Tip

- If you have hidden the SSID of the router (e.g. disable the SSID broadcasting), go to the end of the list of Wi-Fi network. Select **[Other...]** > **[Manual SSID entry]**. In the text box, enter the name of the router.

Note

- The router may fail to assign an IP address, if the DHCP (Dynamic Host Configuration Protocol) is unavailable or disabled on the router. You may need to enter the IP address manually, or press **BACK** to start re-connecting.

Wireless connection: Enter IP address manually

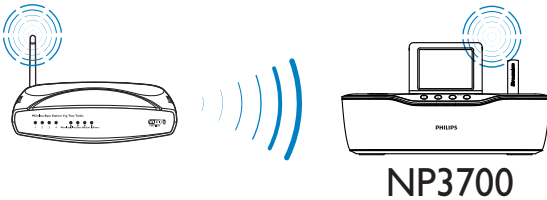

Stop getting Auto IP

- Search for the home Wi-Fi network, and then, connect to the home Wi-Fi network.
 - ↳ The unit starts to acquire an IP address assigned by the Wi-Fi network automatically.
- Press **BACK** on the remote control to stop getting auto IP.

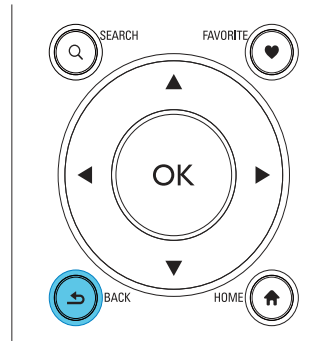

Get the IP address of the router

- Consult the user manual of the router.
- Or, to check for the settings of the router, enter the IP address (e.g. 192.168.1.1) in the web browser (e.g. Internet Explorer) of the computer, and then, get the desired information in the setup page.

Enter the IP address manually

- On the **NP3700**, enter an IP address that allows the unit to be in the same subnet as the router.
For example, if the router has IP address: 192.168.1.1, Subnet mask: 255.255.255.000;
Then, enter the following on the unit:
IP address: 192.168.1.XX (where XX denotes a number), Subnet mask: 255.255.255.000.



- Press **◀▶** repeatedly to select the entry location;

- To enter the desired digits, use the alphanumeric buttons on the remote control; or press ▲/▼ repeatedly.

Note

- Ensure that you never enter an IP address that is already assigned to a computer/device on the network.

Wired connection

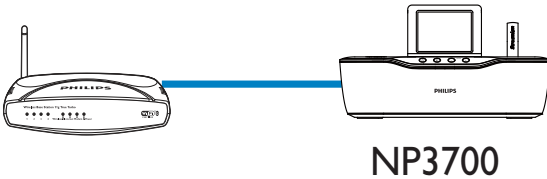

Connect to the router by using the Ethernet cable

- 1 Select **[Yes]**, when asked whether to set up network connection (see 'First-time setup').
- 2 Use an Ethernet cable to connect the unit to the router.

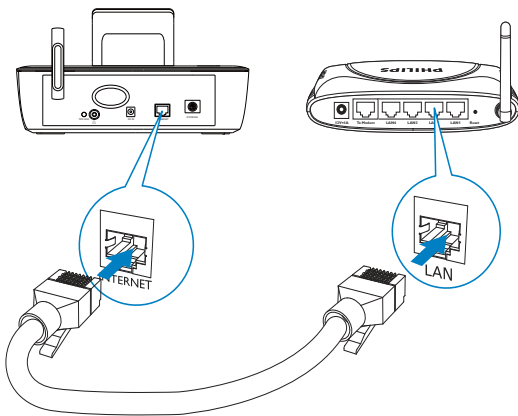

Connect to the home Wi-Fi/wired network

- On the unit, select **[Wired (Ethernet)]**.
 - ↳ The unit starts to acquire an IP address assigned by the network automatically.
 - ↳ A message appears when the connection is completed successfully.

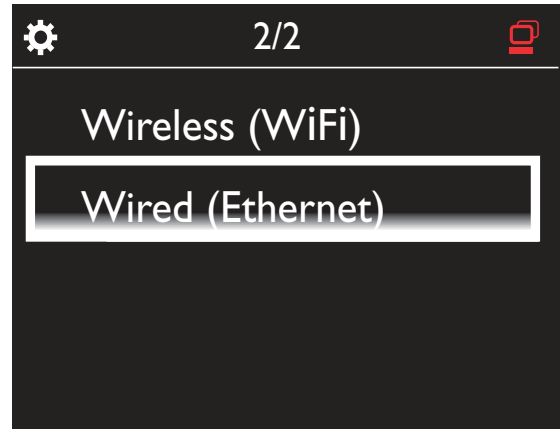

Tip

- The router may fail to assign an IP address, if the DHCP (Dynamic Host Configuration Protocol) is unavailable or disabled on the router. You may need to enter the IP address manually, or press **BACK** to start re-connecting.

Connect to the Internet

- Connect to the Internet as prompted.
 - ↳ You enter Home screen after the first-time setup is complete.

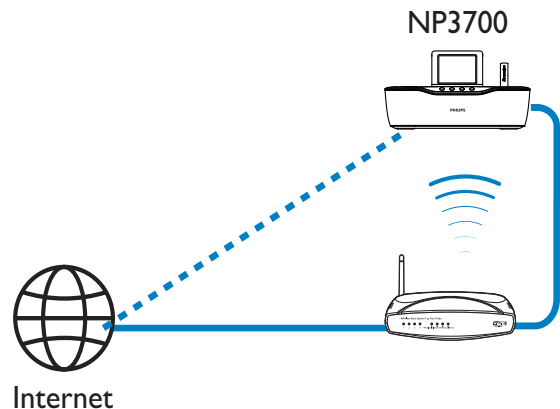

Note

- Ensure that the router connects to the Internet directly and no dial-up is required on the computer.

Wired connection: Enter IP address manually

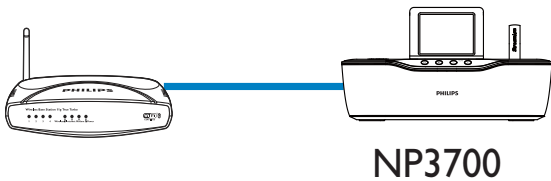

Stop getting Auto IP

- 1 Use an Ethernet cable to connect the unit to the router.
- 2 On the unit, select **[Wired (Ethernet)]**.
- 3 Press **BACK** on the remote control to stop getting auto IP.

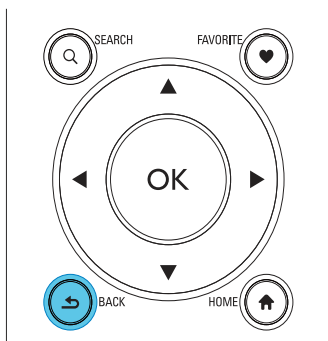
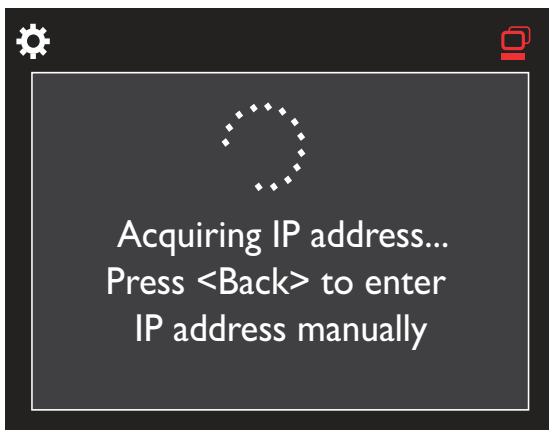

Get the IP address of the router

- Consult the user manual of the router.
- Or, to check for the settings of the router, enter the IP address (e.g. 192.168.1.1) in the web browser (e.g. Internet Explorer) of the computer, and then, get the desired information in the setup page.

Assign the IP address manually

- On the **NP3700**, enter an IP address that allows the unit to be in the same subnet as the router.
For example, if the router has IP address: 192.168.1.1, Subnet mask: 255.255.255.000;
Then, enter the following on the unit: IP address: 192.168.1.XX (where XX denotes a number), Subnet mask: 255.255.255.000.



- Press **◀▶** repeatedly to select the entry location;
- To enter the desired digits, use the alphanumeric buttons on the remote control; or press **▲▼** repeatedly.

Note

- Ensure that you never enter an IP address that is already assigned to a computer/device on the network.

5 Play from home Wi-Fi/wired network

Stream from a UPnP server

TwonkyMedia Server
(PC/Mac)

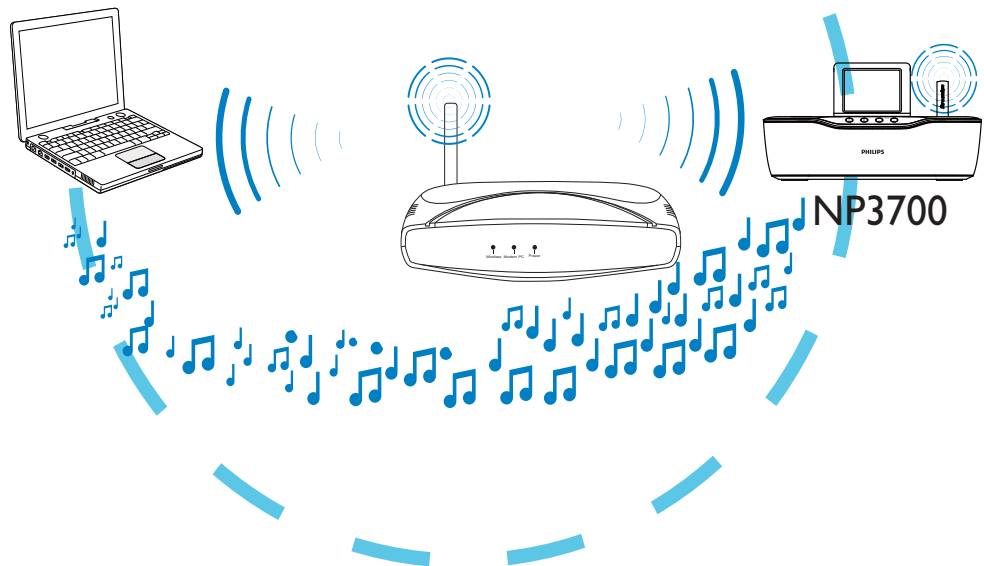

You can stream music between computers and **NP3700**, when

- **NP3700** is connected to home Wi-Fi/wired network;
- Music sharing is set up on the computers, other UPnP servers that are also connected to the home Wi-Fi/wired network.

With the music sharing software (the supplied **Media Browser** and **TwonkyMedia Server**), such computers can work as UPnP media servers (music libraries) of **NP3700**, if they are turned on.

Through the UPnP (Universal Plug and Play) protocols, a UPnP media server allows music files to be streamed from the server to a UPnP client device (e.g. **NP3700**). On the UPnP client device, you can play the music from the server.

NP3700 can also be the UPnP media server of such computers and other UPnP devices that are connected to the home Wi-Fi network, if **NP3700** is turned on or switched to active standby.

Library on a UPnP server

On the computers (UPnP servers), the supplied software **Media Browser** or **TwonkyMedia Server** can access music libraries that are organized by different media management software, including **Windows Media Player 11** and **iTunes**.

iTunes is the a trademark of Apple Inc., registered in the U.S. and other countries.

Stream from a UPnP server

On NP3700, play a music library that is streamed from a UPnP server (a computer on the home Wi-Fi/wired network).

- 1 Ensure that the UPnP server is connected to the home Wi-Fi/wired network.
- 2 On NP3700, press **LIBRARY** on the remote control.
 - Or, from Home screen, select **[Media Library]**.
- 3 Select a music library.
 - ↳ You can see the categories by which the music is sorted (e.g. Artist, Album, Genre).
- 4 Select your desired track or album.
- 5 Press **▶||** to start play.
 - Play starts from the beginning of the album, if you press **▶||** on an album.
 - Play screen appears when play starts (see 'Your NP3700'->'Overview'->'Play screen').



- 6 To stop play, press **■**.

Play favorite songs

On NP3700, you may wish to listen to certain songs from different artists, albums, and genres. Add the songs to **[Favorites]**.

- 1 Go to a list of songs.
- 2 On the remote control, press **FAVORITE** to add current song to **[Favorites]**.
 - Or, press **FAVORITE** when listening to a song.
 - A list of favorite songs is created under **[Media Library] > [Favorites]**.
- 3 To find and play the favorite songs, press **HOME** on the remote control.
 - ↳ From home screen, you can find the favorite songs under **[Media Library] > [Favorites]**.
 - To remove a favorite song from [Favorites]**
 - ↳ Select the song in **[Media Library] > [Favorites]**. Press **FAVORITE** on the remote control.

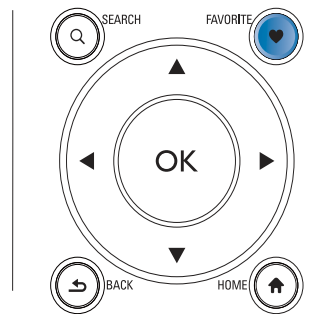

Play photos

- Press **▲/▼** to rotate the picture;
- Press **◀/▶** to move to previous/next picture;
- Press **▶||** to start playing all pictures in slideshow mode.



External control from a PC

Through the home W-Fi/wired network, the **Media Browser** on a PC (UPnP server) allows you to control NP3700.

- 1 On the PC desktop, launch **Media Browser** by double clicking the icon.
- 2 In **Media Browser**, select songs to be played on NP3700. Drag the songs to the icon of NP3700.
 - ↳ A green “+” appears if the songs are in supported formats.

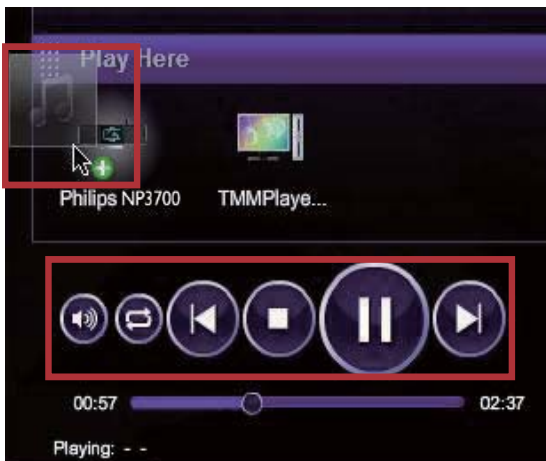

- 3 On the computer, you can click the buttons to
 - Adjust the volume;

- Select previous/next songs if you have dragged more than one songs to NP3700. See the Step 2 above.
- Fast search forward or backward;
- Play/pause and resume.

- 4 On NP3700, do the following to exit the external control.
 - Press **■** on the remote control;
 - Press a source selector on the remote control;
 - Press **⏻**;
 - Press **HOME**.

Note

- The external control is stopped if the sleeper timer is turned on after the set time duration.

Play Internet radio stations

To play Internet radio stations, ensure that

- **NP3700** is connected to the Internet over the home Wi-Fi/wired network.

Note

- Ensure that the router connects to the Internet directly and no dial-up is required on the computer.

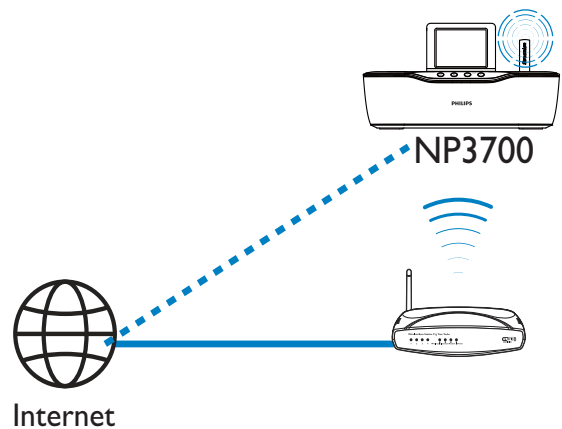

Tune to Internet radio stations

- 1 Ensure that NP3700 is connected to the Internet.
- 2 On NP3700, press **INTERNET RADIO** on the remote control.
 - Or, from Home screen, select **[Internet Radio]**.
- 3 To search for radio stations,
 - Go to [All stations] > [Locations] to locate stations by region;
 - To search for a station by name, use the remote control to start alphanumeric search or Superscroll (see 'Play from home Wi-Fi/wired network'->'Search for music').
- 4 Select the desired station to start play.

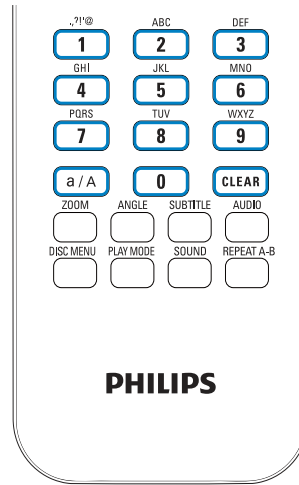

To play a preset station

- Go to **[Internet Radio] > [Presets]**.
- Or, on the radio play screen, press the corresponding numeric button (0-9).

Store preset stations

On NP3700, you can store up to 10 preset stations. Each preset station corresponds to a numeric button on the remote control. On the radio play screen, press a numeric button, you quickly switch to the corresponding preset station.

By default, preset stations are pre-loaded to NP3700 according to the location that you select during the first-time setup. To check or change the location, go to **[Settings] > [Location and time zone]**.

To store preset station

- 1 Play the desired station (see 'Play from home Wi-Fi/wired network'->'Play Internet radio stations'->'Tune to Internet radio stations').
- 2 On the play screen, press and hold the desired numeric button (0-9).
 - ↳ A message appears, indicating that the station is added to the corresponding location.
 - ↳ The new preset replaces the old one if the location has been filled.

Edit favorite stations

On NP3700, you can mark an Internet radio station as favorite. All the stations are added to **[Internet Radio] > [Favorite stations]**. In this way, you can quickly access your favorite stations.

To add a station to [Favorite stations]

- On a list of stations, select the desired station. Press **FAVORITE** on the remote control.
- Or, play the desired station. On the play screen, press **FAVORITE** on the remote control.
 - ↳ A message appears, indicating that the station is added to **[Favorite stations]**.

To remove a station from [Favorite stations]

- Select the station in the list of stations; or, go to the play screen of the station. Press **FAVORITE** again.
- Or, press **CLEAR** on the play screen of the station.

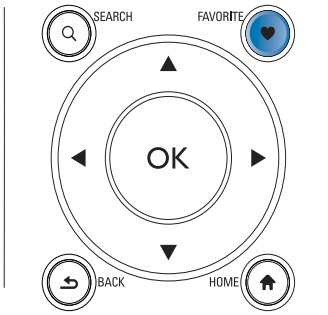

Manage Internet radio online

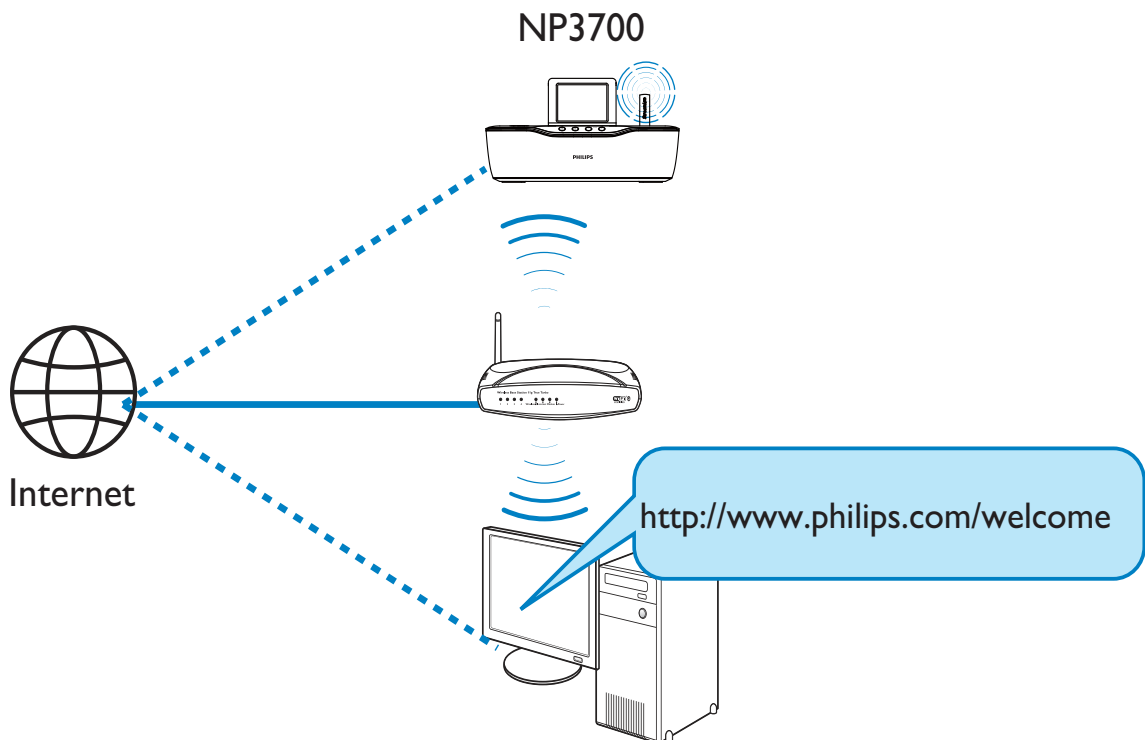

By registering NP3700 on www.philips.com/welcome (see 'Register NP3700 with Philips'), you can log in to Club Philips. On Club Philips, you can do the following to manage the Internet Radio on a computer:

- Edit favorite stations;
- Manually add stations that you are unable to find on NP3700.

Edit favorite stations online

Through Club Philips, you can manage the list of favorite stations on a computer. When connecting NP3700 to the Internet, you update the favorite stations on NP3700.

- 1 On a computer, log in to Club Philips (see 'Register NP3700 with Philips').
- 2 To mark/unmark stations as favorite:
 - Click [Streamium management] > [Favorites] > [Browse];

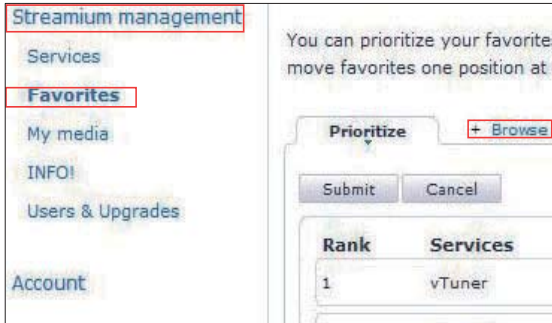

- In [Browse], find the desired stations;



- Under [Favorite], check the box corresponding to the station.
↳ The station is marked as favorite.
- To unmark, uncheck the box corresponding to a station.



3 To change the order of favorite stations in the list:

- Click [Prioritize];
- Click on the row of the station to be moved;
- Drag and drop the row upward or downward.



- ↳ On NP3700, you can find the stations in the desired order under **[Internet Radio]** > **[Favorite stations]**, if you have connected NP3700 to the Internet.

Tip

- In the list of favorite stations, to put a favorite station ahead of the first one, make the station just behind the first one; drag and drop the first station downward.
- To put a station behind the last one, make the station just ahead of the last one; drag and drop the last station upward.

Manually add stations online

Manually add stations

Through Club Philips, you can manually add Internet radio stations to NP3700 on a computer.

- 1 On a computer, log in to Club Philips (see 'Register NP3700 with Philips').
- 2 To add a station, click [Streamium management] > [My media] > [Music].



- 3 In [Music], enter station information in the text boxes:
 - In [URL], fill in the web site of the station;
 - In [Nickname], fill in a name that appears as station name in [My media];
 - In [Description], fill in one-word description about the station, e.g. music, sports, new.
The description is used as a category to sort stations under [My media].
- 4 Click [Save].
 - ↳ A station is manually added the below the edit boxes.

To edit an added station

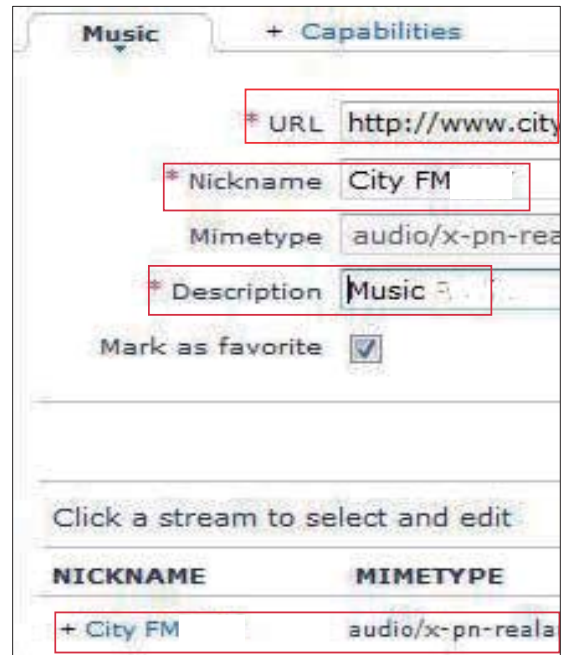

- As shown, click the station.
 - ↳ The text boxes are filled, showing the information about the station.
- Click on the text boxes to edit the information.

Stream from online music services

On NP3700, you can enjoy the online music services.

With the online music services, you can access their online music libraries.

Create a user account to use the services. To access some features, you may need to subscribe services.

Note

- Online services are available in some countries only.

- 1 On NP3700, press **ONLINE SERVICES** on the remote control.
 - Or, from Home screen, go to **[Online services]**.
- 2 On the list of online services, select the desired option. Press **OK** to confirm.
- 3 To start play, press **▶▶**.
 - To stop play, press **■**.

Search for music

In a list of options, you can do one of the following to search for what you need.



Tip

- When searching in the following ways, ensure that NP3700 is in **[Media Library]** or **[Internet Radio]** mode.

- Use the navigation keys **▲, ▼, ◀, ▶**.
- Start quick search by using the **alphanumeric search, Superscroll**, and **Quickjump**.



Note

- **Alphanumeric search, Superscroll** and **Quickjump** are available only when you enter a long sorted list of options (excluding the home screen and lists of menus).

Alphanumeric search

In a long list of options, start alphanumeric search by entering characters that an item starts with or contains.

- 1 Press **SEARCH** on the remote control, if necessary.
 - ↳ A text box appears.



- 2 Enter characters by using the remote control (see 'Your NP3700'-'>'Overview'-'>'Text entry').
- 3 Press **OK** after completing text entry.
 - ↳ Search starts.
 - ↳ You can find a list of items that contain the characters.
 - ↳ You can find a close match if there is no item that contains the character.

Quickjump

You can also use **Quickjump** for alphanumeric search.

To reach the first item that starts with a certain letter

- On the button corresponding to the letter, press once or repeatedly until the letter appears.

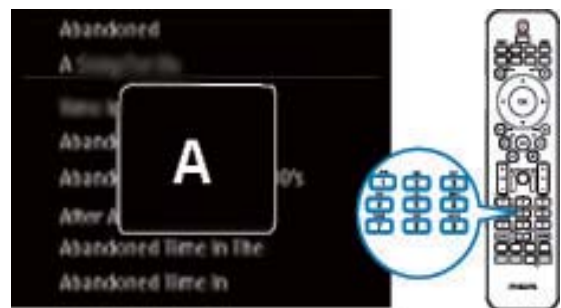

To reach the first item that starts with the next letter

- Press **▶**.

To reach the first item that starts with the previous letter

- Press **◀**.

Superscroll

In a long list of options, **Superscroll** allows you to start a search in an alphabetical order. You can quickly reach the first item that starts with the selected alphabet.

- 1 Press and hold ▲/▼ to start Superscroll.
 - ↳ A pop-up text box appears. Letters are displayed repeatedly in an alphabetical order, starting from current letter:

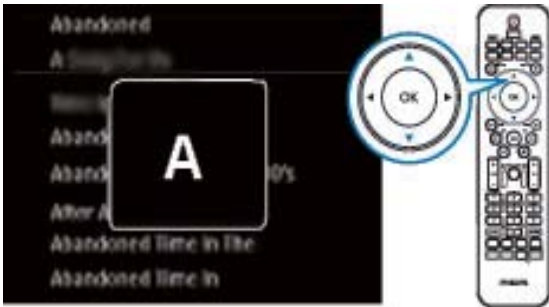

- 2 Release ▲/▼ when you reach the desired letter.
 - ↳ You reach the first item that starts with the letter:

6 Multiroom Music

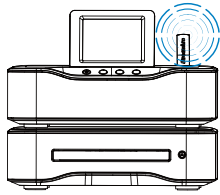

MCI8080

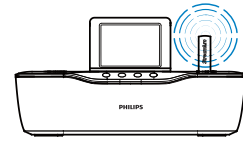

NP3700

With the Multiroom Music feature, you can play the same song on MCI8080 and NP3700 at the same time.

Before you enable this feature, make sure that:

- both MCI8080 and NP3700 are connected to the home Wi-Fi network;
- you are playing songs from the HDD connected to MCI8080.

- 1 Play a song from the HDD connected to MCI8080.
- 2 From Home screen of MCI8080, select **[Multiroom Music]** to enable the Multiroom Music feature.



- 3 Wait until the Multiroom Music feature is enabled successfully.

- To cancel simultaneous play, press **■** on MCI8080.

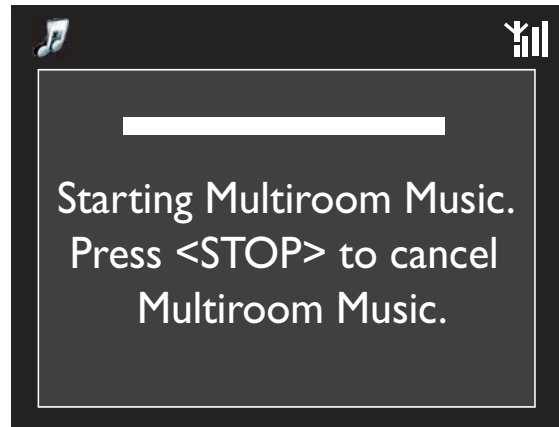

7 Play from an external audio device (AUX)

With the **MP3 LINK** socket and **AUX** mode, NP3700 allows you to play an external audio device (e.g. a portable media player) through the speakers of NP3700.

Play from an external audio device

- 1** Ensure that the external audio device is properly connected to NP3700 (see 'Connect'->'Connect external audio devices').
- 2** On NP3700, select the **AUX** mode.
 - From Home screen, select [**MP3 LINK**].
 - Or, press **AUX** on the remote control.
- 3** On the external audio device, start music play.
 - For the music play, you can use the sound settings on NP3700 (see 'Settings'->'Sound settings').



8 Settings

Play modes

When playing music, you can choose to play repeatedly, play in random order, or play one by one. Select a play mode as desired.

To select a play mode for music play

Before or during music play,

- From Home screen, go to **[Settings]** > **[Play mode]**; Or,
- Press **PLAY MODE** on the remote control.
 - ↳  - Play all songs in current folder repeatedly;
 - ↳  - Play current song repeatedly;
 - ↳  - Play all songs in current folder randomly.

Sound settings

On NP3700, you can select different sound settings in **[Settings]** > **[Sound settings]**.

- 1 From Home screen, go to **[Settings]** > **[Sound settings]**.
 - Or, press **SETTINGS** on the remote control to enter **[Settings]**.
- 2 Select the option. Press **OK** to turn it on or off.
Or,
On the remote control, press **SOUND** to enter the menu of sound settings.
 - To exit the menu of sound settings, press **BACK**.

Incredible Surround

Incredible Surround allows you to experience total surround with greater depth and width of sound, without the use of additional speakers.

- In **[Settings]** > **[Sound settings]** > **[Incredible Surround]**, turn it on or off.

Bass and treble

Use **[Bass / Treble]** to adjust the low (bass) or high (treble) range of musical notes.

- 1 From Home screen, go to **[Settings]** > **[Sound settings]** > **[Bass / Treble]**.
 - Or, press **SOUND** on the remote control to enter the menu of sound settings.
- 2 Press  repeatedly to increase/decrease the level.
 - Press **CLEAR** to select neutral level.

Full sound

[FullSound] restores the sonic details that music compression loses (e.g. MP3, WMA).

Turn on or off **[FullSound]** in **[Settings]** > **[Sound settings]**.

Direct Source

With **[Direct source]**, you can turn off the settings of sound effects on NP3700, including **[FullSound]** and **[Bass / Treble]**.

Thus, music plays in an original way, without the sound effects from NP3700.

- Turn on or off **[Direct source]** in **[Settings]** > **[Sound settings]**.



Tip

- The sound effect settings are retained and enabled when **[Direct source]** is off.

Display settings

Brightness

On NP3700, you can adjust the brightness of the display. As desired, the display lights up, dims or turns off when NP3700 is turned on or switched to active standby.

- In **[Settings]** > **[Display settings]** > **[Brightness when on]** or **[Brightness when standby]**, select an option and press **OK**.

Wallpaper

For menus on NP3700, you can set the background display (wallpaper).

To set wallpaper

- 1 On NP3700, select and play a photo.
- 2 Press **SETTINGS** on the remote control to select **[Settings]** > **[Display settings]** > **[Wallpaper]**.
- 3 In **[Wallpaper]**, select **[Current picture]**.
↳ Current picture is set as wallpaper.

Screensaver

On NP3700, the screensaver is turned on when NP3700 is switched to active standby.

When turned on, the selected screensaver appears. The clock is shown on the lower right corner of the screen.

By default, clock display appears as the screensaver.

To set screensaver

- 1 On NP3700, select and play a picture.
- 2 Press **SETTINGS** on the remote control to select **[Settings]** > **[Display settings]** > **[Screen saver]**.

- 3 In **[Screen saver]**, select **[Current picture]**.
↳ Current picture is set as screensaver.

Slideshow settings

When in the slideshow mode, you can view pictures one by one.

To select a play mode for slideshow

- 1 From the home screen, go to **[Settings]** > **[Slideshow settings]**.
Or, press **SETTINGS** on the remote control to enter **[Settings]**.
- 2 Select one of the following play modes. Press **OK** to turn it on or off.
↳ **[Repeat]**: Play all pictures repeatedly;
↳ **[Shuffle]**: Play all pictures randomly.

To set the play time of each picture

- 1 From Home screen, go to **[Settings]** > **[Slideshow settings]** > **[Time per slide]**.
 - Or, press **SETTINGS** on the remote control to enter **[Settings]**.
- 2 In **[Time per slide]**, select the desired time duration.

Album art

Album art (the picture of CD/album cover) is sometimes available for music downloads. With some media management software, album art can be inserted for the songs. By turning **[Album art]** on or off, you can choose whether to show the picture of CD/album cover for corresponding songs.

To turn on [Album art]

- 1 From the home screen, go to **[Settings]** > **[Album art]**.
Or, press **SETTINGS** on the remote control to enter **[Settings]**.

- 2 Select **[Album art]**. Press **OK** to turn it on or off.
- If **[Album art]** is on,
- ↳ In the list of songs, the album art appears as thumbnail along with the corresponding song.



- ↳ During the song play, the album art is displayed in full screen as the background.



Clicker sound

NP3700 can give you an audible feedback (clicker sound) every time you press a button on the remote control.

You can turn the clicker sound on or off in **[Settings] > [Clicker sound]**.

Clock settings

Alarm

Set the alarm

- 1 Ensure that you have set the clock (see 'Settings'-'>'Date and time').
- 2 From Home screen, go to **[Settings] > [Clock settings] > [Alarm]**.
 - Or, press **SETTINGS** on the remote control to enter **[Settings]**.
- 3 To set the source of alarm sound,
 - Select **[Music]**;
 - ↳ At the set alarm time, last played song starts/resumes, or you tune to the last played Internet radio station.
 - Select **[Buzzer]**.
 - ↳ At the set alarm time, the buzzer sounds.
- 4 To set the alarm time,
 - Press and hold **▲/▼**, or press **▲/▼** repeatedly until you reach the desired digits. Press **OK** to confirm.
 - Or, enter the desired digits by using the alphanumeric buttons on the remote control.
 - ↳ The alarm icon **🔔** appears on the screen.

To play a song or Internet radio station as the next alarm sound

- 1 Ensure that you have selected **[Music]** in the Step 3 above;
- 2 Before you turn off NP3700, or switch NP3700 to active standby,
 - Go to **[Media Library]**, and select and play the desired song;
 - Or, go to **[Internet Radio]**, and tune to the desired station.

Use the alarm

At the set alarm time, music/Internet radio plays as desired, or the buzzer sounds.

Note

- The alarm sounds even if you have switched NP3700 to active standby or Eco standby.
- The buzzer sounds instead, if NP3700 fails to connect to a music library or an Internet radio station.
- NP3700 is unmuted if it has been muted.
- The alarm sounds in a higher volume if the volume level is lower than minimum.

To snooze the alarm

- Press any button on the unit or the remote control (except for the volume buttons).
 - ↳ The alarm sounds again 15 minutes later. The alarm icon remains.

To turn off the alarm

- Go to **[Settings] > [Clock settings] > [Alarm]**. Select **[Alarm off]** and press **OK** on the remote control.

Sleep timer

With the sleep timer, you can have NP3700 turned off automatically after the set timer duration.

To set the time duration

- 1 From the home screen, go to **[Settings] > [Clock settings] > [Sleep timer]**.
 - Or, press **SETTINGS** on the remote control to enter **[Settings]**.
- 2 Select an option. Press **OK** to turn it on.

Date and time

The date and time can be set automatically or manually.

Automatic setting

For automatic clock setting, use the online service over the Internet.

Through the online service over the Internet

- 1 Turn on the unit, if necessary.
 - Ensure that the unit is connected to the home Wi-Fi/wired network and Internet.
- 2 From Home screen, select **[Settings] > [Clock settings] > [Date and time]**.
 - Or, press **SETTINGS** on the remote control to enter **[Settings]**.
- 3 In **[Date and time]**, select **[Current date and time] > [Automatic (Internet)]**.
 - ↳ The unit starts auto time setting over the Internet.
 - ↳ A message appears when the setting is done.

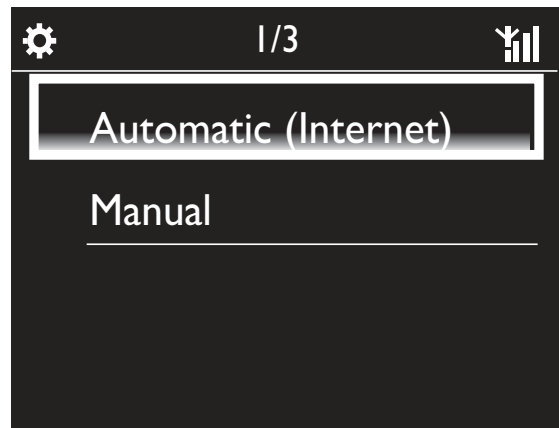

 Tip

- According to the location and time zone you select, the unit can have the clock time set and adjusted automatically through the online service over the Internet.
- To check and change current location and time zone, go to **[Settings]** > **[Location and time zone]**.

Manual setting

- 1 Turn on the unit, if necessary.
- 2 From Home screen, select **[Settings]** > **[Clock settings]** > **[Date and time]**.
 - Or, press **SETTINGS** on the remote control to enter **[Settings]**.
- 3 In **[Date and time]**, select **[Current date and time]** > **[Manual]**.
- 4 To enter date and time,
 - Press ◀ or ▶ to select the entry location;
 - Use the alphanumeric buttons to enter desired digits;
 - Press **OK** to confirm.
 - You can also press ▲ or ▼ repeatedly, or press and hold ▲ or ▼ until the desired digit appears.

Set date/time format

Select how date and time are displayed in the clock.

- 1 Follow Step 1-2 under “**Manual setting**”.
- 2 In **[Date and time]**, go to **[Time format]** or **[Date format]** to select options.

Network settings

Setup network

After the first-time setup, you can change how **NP3700** connects to home Wi-Fi/wired network:

- Switch between different connection methods (wireless or wired, automatic or manual);
- Switch between different routers. To do so, do the following:

- 1 From Home screen, go to **[Settings]** > **[Network settings]** > **[Setup network]**.
 - Or, press **SETTINGS** on the remote control to enter **[Settings]**.
- 2 Connect **NP3700** as you did in the first-time setup (see ‘First-time setup’->‘Connect to home Wi-Fi/wired network’).

Device name

In **[Device name]**, you can name/rename your NP3700. On a connected UPnP server/client, the NP3700 can be found as named.

- 1 From Home screen, go to **[Settings]** > **[Network settings]** > **[Device name]**.
- 2 In **[Device name]**, press ◀▶ to select the entry location; press ▲/▼ repeatedly to select desired letters.

Location and time zone

After the first-time setup, you can change the selected location and time zone when moving to a new location or time zone.

According to the selected location and time zone, NP3700 can

- Set clock automatically over the Internet (see 'Settings'->'Date and time');
- Pre-load preset Internet radio stations automatically.

Language

After the first-time setup, you can change the language selection in **[Settings]** > **[Language]**.

Device information

From the home screen, go to **[Settings]** > **[Device ID and information]**. You can learn about information about NP3700, including model number, name to be shown on a UPnP server/client, software version and network settings.

Check for software upgrades

On the NP3700, you can check for software upgrades. After you click to agree to the terms and conditions, the downloading and installation of new upgrades start automatically.

- 1 Ensure that NP3700 is connected to the Internet.
- 2 From Home screen, go to **[Settings]** > **[Check for software upgrades]**.

Demo mode

After the first-time setup, you can view the demo again.

- 1 From Home screen, go to **[Settings]** > **[Demo mode]**.
 - ↳ Demo play starts.
- 2 To exit the demo play, press **⏻**.
 - ↳ The unit is switched to Eco standby.

Restore factory settings

You can restore NP3700 to factory settings. All your settings are removed, including the settings of network, sound, display, clock, alarm and language.

- 1 Go to **[Settings]** > **[Restore factory settings]**.
- 2 As prompted, select **[Yes]**.
 - ↳ The unit is turned off.
 - ↳ The unit is turned on again automatically when the factory settings are restored.
 - ↳ Start the first-time setup.

9 Register NP3700 with Philips

Benefits

By registering NP3700 on www.philips.com/welcome, you can

- Get free software upgrades;
- Manage your own favorite radio stations;
- Receive Streamium newsletters.

Note

- Registration of **NP3700** requires a valid email address.

Register NP3700

Use a valid email address as the account when you register NP3700 on www.philips.com/welcome.

You can complete the registration directly on www.philips.com/welcome. Or, use an email address to register on the device, and then, complete the registration through the web site link that you received in the email.

Register on the web site

To register NP3700 directly on www.philips.com/welcome, you need to fill in the following information as prompted during registration:

- A valid email address as the registration account;
- Product model number;
- Product registration ID.

To get the product model number

- Look at the packaging box of the device or the product label. You can always find the model number on the packaging box or product label (e.g. MCI8080, NP3700).



To get the product registration ID

- On NP3700, go to **[Settings]** > **[Device ID and information]**. Press **▼** repeatedly to find **[Product Registration ID]**.

Register on the device

Use an email address to register on the device, and then, complete the registration through the web site link that you received in the email.

- 1 Ensure that NP3700 is connected to the Internet.
- 2 To register with www.philips.com/welcome,
 - On NP3700, select **[Settings]** > **[User registration]** > **[Register now]** > **[Register on the device]**;
 - As prompted, enter your valid email address (see 'Your NP3700'->'Overview'->'Text entry').
 - ↳ You receive an email message from ConsumerCare@Philips.com.
 - On a computer, use the web site link in the email to complete registration.



Tip

- To log in to Philips online services later, use the web site link in the email, and the password.

Unregister NP3700

When registering with www.philips.com/ welcome, you can only use one account for one unit (e.g. NP3700). For each account, you can maintain a set of favorite stations and manually added stations.

To use another account for registration, you need to unregister current one.

To unregister an account

- 1 On NP3700, select **[Settings]** > **[User registration]** > **[Unregister]**.
- 2 As prompted, confirm to start unregistering the account.



Tip

- When re-registering the account, you can recover the Internet radio stations that you maintained with Philips online services.

Check registration information

You can check whether you have registered the NP3700, and what account you have used for registration. To check the information, go to **[Settings]** > **[User registration]** > **[Registration status]**.

10 Maintenance

This chapter tells you how to care for NP3700.

Cleaning



Note

- Avoid moisture and abrasion.

- 1 Clean NP3700 only with a soft dry cloth.

11 Technical data

General

AC Power

The voltage information is printed on the power adaptor (backside).

DC Power

9 V / 2.1 A

Dimensions (L x W x H)

292 x 147.5 x 151.7 mm

Weight (net)

Main unit: ~ 1.47 kg

Power consumption

On

< 25 W

Standby (active)

< 4 W

ECO (passive) standby

≤ 0.7 W

Audio output

Headphones

1x 3.5 mm jack

40 - 18,000 Hz

32 Ω

Signal to noise ratio (headphones)

typically 85 dBA (IEC)

Distortion (line out / headphones)

< 1 %

Audio input

MP3 link

1 x 3.5mm jack

Input sensitivity

950 mV

Input impedance

> 10 kΩ

Audio amplifier (Digital)

Output power

2 x 5 W (RMS)

Frequency response

30Hz - 20,000Hz (3 dB points)

Signal to noise ratio

≥ 85 dBA (IEC)

Loudspeakers

Power handling

6 W

Impedance

8 Ω

Sensitivity

83 dB / 1 m / W

Dimensions

2 1/4 inches

Frequency response

40 Hz - 18 kHz

Sound features

FullSound®

Yes (on / off)

BASS / TREBLE control

Yes (on / off)

Incredible Surround

Yes (on / off)

Wireless

Wireless standard

802.11n, backwards compatible to 802.11b/g

Wireless security

WEP (64 or 128 bit),

WPA/WPA2 (8-63 characters)

Frequency range

2412 - 2462 MHz (CH1-CH11) (for /79, /37, /55, /97)

2412 - 2472 MHz (CH1-CH13) (for /12, /05)

Antenna

1 x vertical, polarized

Wireless protected setup (WPS)

Yes

Wired (LAN / Ethernet)

Wired standard

802.3 / 802.3 u

Speed

10 / 100 MBit/s

Mode

half / full duplex

Crossover detection (Auto MDIX)

Yes (Auto MDIX)

Note

- The wired and wireless network interfaces cannot be turned on at the same time.

Internet services

Internet radio

My Media

Internet services

Rhapsody Direct * (for /37, /17)

Napster Direct * (for /12, /05 only in Germany/UK)

Both services require user registration with Rhapsody and Napster respectively.

Decoding capabilities

MP3

8 - 320 kbps (CBR / VBR)

WMA

32 - 192 kbps (CBR / VBR)

AAC (M4A)

16 - 320 kbps (CBR / VBR)

PCM

1x (1.4 Mbps)

FLAC

Yes, supported

Real Audio (*.ra)

No, not supported

Playlist support

*.m3u, *.wpl

Yes

iTunes, Rhapsody

Yes (via by-packed UPnP Server)

Display / Clock

Resolution

Dotmatrix, 320 x 240 dots (QVGA), color TFT

Size

3.5 inches

Backlight

Can be turned on/off, or dimmed

Touch screen

Yes

Clock / date display

Yes

Automatic time setting via the Internet (NPT)

Yes, enabled

Sleep timer

Yes

Internal (key) clicker

Yes

Docking

9 pole MiniDIN socket

Compatible with Philips DCK3060 (external dock; not included)

5V / 500mA

Others

UPnP

DMP (Local renderer, Local control point)

ECP (Controllable via an external control point)

DLNA

Yes, Version 1.5 (DMP, DMR)

NP3700 can connect to

- Windows Media Player 11, Winamp, TwonkyMedia;
- Philips Music Center WAC3500 / WAC7500 / MCI500H;
- Philips NAS SPD8020CC;
- Mobile phone Nokia N80, N93, N95.

Note

- Specifications and external appearance are subject to changes without notice.

12 Troubleshooting

I cannot hear any sound or the sound is poor, what do I do?

- Press **+ VOL -** to increase the volume.
- Press the **MUTE** button again to reactivate the sound output.

Is there a maximum distance of transmission between a wireless router and NP3700 for effective streaming?

Yes. The maximum distance of Wi-Fi transmission is 250m measured in open spaces. However, in a home environment, where solid obstacles such as walls and doors are present, the effective transmission distance is reduced to 50-100m. Reposition the devices if you experience transmission problems.

I have not received any registration email from ConsumerCare@Philips.com.

- Check that the email address that is entered in the user registration section is valid and spelled correctly.
- Check that the PC has an active Internet connection.
- The Internet server may be busy, try again later.
- Check if the email was redirected to the spam folder.

How do I avoid Wi-Fi interferences from other devices that operate in the same (2.4GHz) frequency spectrum, such as Dect phones or bluetooth devices?

- Move NP3700 at least 3m away from such devices.
- Use a WEP/WPA encryption key when you create the wireless connection your PC / home network.
- Change the operating channel on the interfering devices.
- Turn the devices in different directions to minimize interference.

13 Contact information

Argentina	(54-11) 4544-2047
Australia	1300 363 391
Austria	0810 000 205
Belgium	78250145
Belarus	882000110068
Brazil	0800 701 02 03 (all except Sao Paulo)(11) 2121-0203 (Sao Paulo only)
Bulgaria	8001154424
Canada	1-888-744-5477
Chile	600 744 5477 (600-PHILIPS)
China	4008 800 008
Colombia	01 800 700 7445
Croatia	800222778
Czech Republic	800142840
Denmark	35258759
Estonia	8000100288
Finland	923113415
France	805025510
Germany	8000007520
Greece	80031221280
Hong Kong	852-2619 9663
Hungary	680018189
India	1860-180-1111
Ireland	16011777
Israel	9600900-09
Italy	800088774
Japan	0570-07-6666
Korea	080-600-6600
Latvia	80002794
Luxembourg	4066615644
Malaysia	1800 880 180
Mexico	01 800 504 6200
Netherlands	8000230076
New Zealand	0800 658 224
Norway	22708111

Pakistan	051 580 902-3
Peru	0800 00100
Philippines	(63 2) 667 9000
Poland	8003111318
Portugal	800780903
Romania	800894910
Russia Federation	(495)961-1111 (local rate)8-800-200-0880 (mobile phone - free)
Singapore	65 6882 3999
Slovakia	800004537
South Africa	(011) 471-5194
Spain	900800655
Sweden	857929100
Switzerland	844800544
Taiwan	0800 231 099
Thailand	66 2 652 8652
Turkey	0800 261 3302
Ukraine	8-800-500-69-70
United Kingdom	8003316015
United States	1-888-744-5477
Uruguay	(598-2) 619 6666
Venezuela	0800 100 4888

Streamium terms and conditions

Terms and Conditions of Use of your Philips Streamium-enabled Device

Congratulations on your purchase of a Philips Streamium-enabled Device ("Device"). These Terms and Conditions of Use give you the rights to use certain features on your Device relating to the streaming of content. You must agree to these Terms and Conditions of Use before using the Device. Your use of the Device constitutes your agreement to be bound by these Terms and Conditions of Use and will give you the right to access these features. If you do not agree to these Terms and Conditions of Use, you may return your Device to the point of purchase. These Terms and Conditions of Use supplement, and do not replace, any terms, conditions or disclaimers which were provided with your purchase of the Device. All such terms, conditions and disclaimers remain in full force and effect.

Eligibility for Registration.

You must be at least 14 years of age to assume the responsibilities of these Terms and Conditions of Use. If you are under 14 years of age, you may not use the Device unless one of your parents or legal guardians assumes the responsibilities of these Terms and Conditions of Use. Your use of the Device constitutes your representation that you are either 14 years of age or, if you are under 14 years of age, that your parent or legal guardian has assumed the responsibilities of these Terms and Conditions of Use.

Restrictions on Modification of your Device

Your Device provides access to certain streams of content. As a condition of obtaining access to those streams through the Device, you agree not to tamper with or otherwise modify or attempt to modify the Device in any way (including through the use of software or by making physical alterations to the Device). You agree that you will not circumvent or attempt to circumvent technological measures employed to control access to, or the rights in, any content. You agree that you will not circumvent or attempt to circumvent any copy management system by any means. You agree that you will not decipher or attempt to decipher cryptographic keys or otherwise defeat or attempt to defeat any security features implemented in the Device or in the content streams. You agree that you will not use the Device for any unauthorized purpose or in contravention of any law or regulation.

Disclaimers Regarding Content

The streams of content which are accessible through your Device are not controlled or programmed by Philips. Rather, they are provided by third parties. Think of your Device (in addition to its other features) as a form of "tuner" which allows you to receive the content broadcast by many others outside of your local area. Since the content is provided by others, PHILIPS HAS NO EDITORIAL CONTROL OVER ANY OF THAT CONTENT RECEIVED THROUGH YOUR DEVICE AND, THEREFORE IS NOT LIABLE FOR CONTENT OR ITS NATURE OR DELIVERY. PHILIPS DOES NOT ENDORSE ANY OPINIONS EXPRESSED IN ANY CONTENT RECEIVED THROUGH YOUR DEVICE. PHILIPS DOES NOT GUARANTEE THE TRUTHFULNESS, ACCURACY, RELIABILITY, COMPLETENESS OR TIMELINESS OF CONTENT. YOU AGREE THAT ANY RELIANCE ON CONTENT IS AT YOUR OWN RISK.

Limitations on Access to Streams.

Philips does not guarantee access to any particular stream or to the content contained in any stream. Philips may, in its discretion, add or remove access to any specific stream or content at any time. Some streams are accessible through arrangements with online service providers which determine which streams are listed on their directories. Although Philips will strive to provide a good selection of online service providers, Philips does not guarantee continued access to any specific online service provider. Philips may, in its discretion, add or remove access to any specific online service provider.

Rights in Content

Content may be protected by copyright laws or other intellectual property or proprietary laws. In some situations, such as use of the Device in a commercial environment, it may be necessary for you to obtain, at your own risk, a license or other authorization to use such content. You agree that, in the event such a license or

authorization is necessary, it is your responsibility to obtain any such license or authorization. You agree that you are solely liable for any damages you may incur resulting from your failure to obtain the proper license or authorization for use of the content accessible through the Device. You agree that Philips will have no liability to you with regard to your use of the content.

Changes in Features

Philips may, in its discretion, change the features of the Device, including adding features to, or removing features from, the Device. Some new features may require changes to these Terms and Conditions of Use. Your use of those new features will constitute your agreement to the revised Terms and Conditions of Use.

Software and Intellectual Property Rights

You may need to use certain software programs to use or have full access to certain features of the Device. You received certain software with the purchase of the Device and may receive other software from time to time in the future. Most of that software is contained in the Device and is not accessible to you. Some of that software is owned by Philips and some is owned by others. Your use of software owned by Philips is subject to these Terms and Conditions of Use and any applicable license agreement. Your use of software owned by others is governed by their applicable license agreements. Your use of software does not transfer any title or ownership rights in the software to you. Philips retains all its rights in software and other intellectual property, including copyrights, patent rights, and rights in its trademarks and trade names. You agree that you will not disassemble, decompile, create derivative works of, reverse engineer, modify, sublicense, distribute the software or use the software for any unauthorized purpose or in contravention of any law or regulation.

Warranty Disclaimer

PHILIPS MAKES NO REPRESENTATION OR WARRANTY, EXPRESS OR IMPLIED, THAT THE DEVICE WILL MEET YOUR REQUIREMENTS OR THAT THE USE OF THE DEVICE WILL BE UNINTERRUPTED, TIMELY, SECURE OR FREE FROM ERRORS. PHILIPS MAKES NO WARRANTY AS TO THE CONTENT CARRIED IN ANY STREAM. PHILIPS MAKES NO REPRESENTATION OR WARRANTY, EXPRESS OR IMPLIED, AS TO THE INFORMATION OR CONTENT ACCESSED THROUGH YOUR DEVICE OR TO YOUR RELIANCE ON, OR USE OF, ANY INFORMATION OR CONTENT ACCESSED THROUGH YOUR DEVICE. SPECIFIC WARRANTIES WERE PROVIDED WITH YOUR PURCHASE OF YOUR DEVICE AND THOSE WARRANTIES, INCLUDING ANY DISCLAIMERS TO THOSE WARRANTIES, CONTINUE TO APPLY. Because some jurisdictions do not permit the disclaimer of implied warranties, such disclaimers may not apply to you.

Limitation of Liability

PHILIPS WILL NOT BE LIABLE TO YOU OR TO ANY OTHER PARTY FOR ANY INDIRECT, INCIDENTAL, PUNITIVE, SPECIAL OR CONSEQUENTIAL DAMAGES (INCLUDING LOST PROFITS OR LOST SAVINGS) OR FOR LOSS OF DATA OR BUSINESS INTERRUPTION ARISING OUT OF OR RELATING TO YOUR USE OF THE DEVICE WHETHER OR NOT SUCH DAMAGES ARE BASED ON TORT, WARRANTY, CONTRACT OR ANY OTHER LEGAL THEORY - EVEN IF PHILIPS HAS BEEN ADVISED, OR IS AWARE, OF THE POSSIBILITY OF SUCH DAMAGES. IN NO EVENT WILL PHILIPS CUMULATIVE LIABILITY FOR DAMAGE (FROM ANY CAUSE WHATSOEVER) EXCEED THE AMOUNT YOU PAID FOR YOUR DEVICE.

Miscellaneous

“This agreement will be governed by the laws of the jurisdiction in which the Device was sold and you hereby consent to the non-exclusive jurisdiction of courts in the relevant country. If any provision of this agreement is invalid or unenforceable under applicable law, such provision will be deemed modified to the extent necessary to render such provision valid and enforceable and the other provisions of this agreement will remain in full force and effect. These Terms and Conditions of Use will not be governed by the United Nations Convention of Contracts for the International Sale of Goods, the application of which is hereby expressly waived.”

BY USING YOUR DEVICE, YOU REPRESENT THAT YOU HAVE READ AND UNDERSTOOD THESE TERMS AND CONDITIONS OF USE AND THAT YOU ACCEPT THEM.

NOTICE

SOFTWARE END USER LICENSE AGREEMENT

THIS SOFTWARE END USER LICENSE AGREEMENT (“THIS AGREEMENT”) IS A LEGAL AND BINDING AGREEMENT BETWEEN YOU (EITHER AN INDIVIDUAL OR ENTITY) AND PHILIPS CONSUMER ELECTRONICS B.V.A DUTCH LIMITED LIABILITY COMPANY, WITH ITS PRINCIPAL OFFICE AT GLASLAAN 2, 5616 LW EINDHOVEN, THE NETHERLANDS AND ITS SUBSIDIARY COMPANIES (INDIVIDUALLY AND COLLECTIVELY “PHILIPS”). THIS AGREEMENT GIVES YOU THE RIGHT TO USE CERTAIN SOFTWARE (THE “SOFTWARE”) INCLUDING USER DOCUMENTATION IN ELECTRONIC FORM WHICH MAY HAVE BEEN PROVIDED SEPARATELY OR TOGETHER WITH A PHILIPS PRODUCT (THE “DEVICE”) OR A PC. BY DOWNLOADING, INSTALLING OR OTHERWISE USING THE SOFTWARE, YOU ACCEPT AND AGREE TO BE BOUND BY ALL OF THE TERMS AND CONDITIONS OF THIS AGREEMENT. IF YOU DO NOT AGREE TO THESE TERMS AND CONDITIONS, DO NOT DOWNLOAD, INSTALL OR OTHERWISE USE THE SOFTWARE. IF YOU ACQUIRED THE SOFTWARE IN TANGIBLE MEDIA E.G. CD WITHOUT THE OPPORTUNITY TO REVIEW THIS LICENSE AND DO NOT ACCEPT THESE TERMS, YOU MAY RECEIVE A FULL REFUND OF THE AMOUNT, IF ANY, THAT YOU PAID FOR THE SOFTWARE IF YOU RETURN THE SOFTWARE UNUSED WITH PROOF OF PAYMENT WITHIN 30 DAYS FROM THE DATE OF PURCHASE.

1. Grant of License. This Agreement grants you a non-exclusive, nontransferable, non-sub licensable license to install and use, on the Device or a PC, as applicable, one (1) copy of the specified version of the Software in object code format as set out in the user documentation solely for your personal use. The Software is “in use” when it is loaded into the temporary or permanent memory (i.e. RAM, hard disk, etc.) of the PC or the Device.

2. Ownership. The Software is licensed and not sold to you. This Agreement grants you only the right to use the Software, but you do not acquire any rights, express or implied, in the Software other than those specified in this Agreement. Philips and its licensors retain all right, title, and interest in and to the Software, including all patents, copyrights, trade secrets, and other intellectual property rights incorporated therein. The Software is protected by copyright laws, international treaty provisions, and other intellectual property laws. Therefore, other than as expressly set forth herein, you may not copy the Software without prior written authorization of Philips, except that you may make one (1) copy of the Software for your back-up purposes only. You may not copy any printed materials accompanying the Software, nor print more than one (1) copy of any user documentation provided in electronic form, except that you may make one (1) copy of such printed materials for your back-up purposes only.

3. License Restrictions. Except as provided otherwise herein, you shall not rent, lease, sublicense, sell, assign, loan, or otherwise transfer the Software. You shall not, and you shall not permit any third party, to reverse engineer, decompile, or disassemble the Software, except to the extent that applicable law expressly prohibits the foregoing restriction. You may not remove or destroy any product identification, copyright notices, or other proprietary markings or restrictions from the Software. All titles, trademarks, and copyright and restricted rights notices shall be reproduced on your back up copy of the Software. You may not modify or adapt the Software, merge the Software into another program or create derivative works based upon the Software.

4. Termination of certain functionality. The Software may contain components of certain licensed software including software licensed from Microsoft Corporation (“Microsoft”) which implements Microsoft’s digital rights management technology for Windows Media. Content providers are using the digital rights management technology for Windows Media (“WM-DRM”) to protect the integrity of their content (“Secure Content”) so that their intellectual property, including copyright, in such content is not misappropriated. Your Device may also use WM-DRM software to transfer or play Secure Content (“WM-DRM Software”). If the security of such WM-DRM Software is compromised, Microsoft may revoke (either on its own or upon the request of the owners of Secure Content (“Secure Content Owners”)) the WM-DRM Software’s right to acquire new licenses to copy, store, transfer, display and/or play Secure Content. Revocation does not alter the WM-DRM Software’s

ability to play unprotected content. A list of revoked WM-DRM Software is sent to your PC and/or your Device whenever you download a license for Secure Content. Microsoft may, in conjunction with such license, also download revocation lists onto your Device on behalf of Secure Content Owners, which may disable your Device's ability to copy, store, display, transfer, and/or play Secure Content. Secure Content Owners may also require you to upgrade some of the WM-DRM components distributed with this Software ("WM-DRM Upgrades") before accessing their content. When you attempt to play Secure Content, WM-DRM Software built by Microsoft will notify you that a WM-DRM Upgrade is required and then ask for your consent before the WM-DRM Upgrade is downloaded. WM-DRM Software built by Philips may do the same. If you decline the upgrade, you will not be able to access Secure Content that requires the WM-DRM Upgrade; however, you will still be able to access unprotected content and Secure Content that does not require the upgrade. WM-DRM features that access the Internet, such as acquiring new licenses and/or performing a required WM-DRM Upgrade, can be switched off. When these features are switched off, you will still be able to play Secure Content if you have a valid license for such content already stored on your Device. However, you will not be able to use certain of the WM-DRM Software features that require Internet access such as the ability to download content that requires the WM-DRM Upgrade. All title and intellectual property rights in and to the Secure Content is the property of the respective Secure Content owners and may be protected by applicable copyright or other intellectual property laws and treaties. This Agreement grants you no rights to use such Secure Content. **To summarize, if the Software contains Microsoft WM-DRM components – Secure Content you desire to download, copy, store, display, transfer, and/or play is protected by the Microsoft WM-DRM components of the Software. Microsoft, Secure Content Owners, or Secure Content distributors may deny you access, or restrict your access, to Secure Content even after you have paid for, and/or obtained, it. Neither your consent nor the consent or approval of Philips is necessary for any of them to deny, withhold or otherwise restrict your access to Secure Content. Philips does not guaranty that you will be able to download, copy, store, display, transfer, and/or play Secure Content.**

5. Open Source Software. (a) This software may contain components that are subject to open-source terms, as stated in the documentation accompanying the Device. This Agreement does not apply to this software as such. (b) Your license rights under this Agreement do not include any right or license to use, distribute or create derivative works of the Software in any manner that would subject the Software to Open Source Terms. "Open Source Terms" means the terms of any license that directly or indirectly (1) create, or purport to create, obligations for Philips with respect to the Software and/or derivative works thereof; or (2) grant, or purport to grant, to any third party any rights or immunities under intellectual property or proprietary rights in the Software or derivative works thereof.

6. Termination. This Agreement shall be effective upon installation or first use of the Software and shall terminate (i) at the discretion of Philips, due to your failure to comply with any term of this Agreement; or (ii) upon destruction of all copies of the Software and related materials provided to you by Philips hereunder. Philips's rights and your obligations shall survive the termination of this Agreement.

7. Upgrades. Philips may, at its sole option, make upgrades to the Software available by general posting on a website or by any other means or methods. Such upgrades may be made available pursuant to the terms of this Agreement or the release of such upgrades to you may be subject to your acceptance of another agreement.

8. Support Services. Philips is not obligated to provide technical or other support ("Support Services") for the Software. If Philips does provide you with Support Services, these will be governed by separate terms to be agreed between you and Philips.

9. Limited Software Warranty. Philips provides the Software 'as is' and without any warranty except that the Software will perform substantially in accordance with the documentation accompanying the Software for a period of one year after your first download, installation or use of the Software, whichever occurs first. Philips' entire liability and your exclusive remedy for breach of this warranty shall be, at Philips' option, either (i) return of the price paid by you for the Software (if any); or (b) repair or replacement of the Software that does not

meet the warranty set forth herein and that is returned to Philips with a copy of your receipt. This limited warranty shall be void if failure of the Software has resulted from any accident, abuse, misuse or wrongful application. Any replacement Software will be warranted for the remainder of the original warranty period or thirty (30) days, whichever is longer. This limited warranty shall not apply to you if the Software was provided to you free of charge on an evaluation only basis.

10. NO OTHER WARRANTIES. EXCEPT AS SET FORTH ABOVE, PHILIPS AND ITS LICENSORS DO NOT WARRANT THAT THE SOFTWARE WILL OPERATE ERROR FREE OR UNINTERRUPTED, OR WILL MEET YOUR REQUIREMENTS. YOU ASSUME ALL RESPONSIBILITIES FOR SELECTION OF THE SOFTWARE TO ACHIEVE YOUR INTENDED RESULTS, AND FOR THE INSTALLATION OF, USE OF, AND RESULTS OBTAINED FROM THE SOFTWARE. TO THE MAXIMUM EXTENT PERMITTED BY APPLICABLE LAW, PHILIPS AND ITS LICENSORS DISCLAIM ALL WARRANTIES AND CONDITIONS, WHETHER EXPRESS OR IMPLIED, INCLUDING BUT NOT LIMITED TO THE IMPLIED WARRANTIES OF MERCHANTABILITY, FITNESS FOR A PARTICULAR PURPOSE, AND ACCURACY OR COMPLETENESS OF RESULTS WITH RESPECT TO THE SOFTWARE AND THE ACCOMPANYING MATERIALS. THERE IS NO WARRANTY AGAINST INFRINGEMENT. PHILIPS DOES NOT WARRANT THAT YOU WILL BE ABLE TO DOWNLOAD, COPY, STORE, DISPLAY, TRANSFER, AND/OR PLAY SECURE CONTENT.

11. LIMITATION OF LIABILITY. UNDER NO CIRCUMSTANCES WILL PHILIPS OR ITS LICENSORS BE LIABLE FOR ANY CONSEQUENTIAL, SPECIAL, INDIRECT, INCIDENTAL OR PUNITIVE DAMAGES WHATSOEVER, INCLUDING, WITHOUT LIMITATION, DAMAGES FOR LOSS OF PROFITS OR REVENUES, BUSINESS INTERRUPTION, LOSS OF BUSINESS INFORMATION, LOSS OF DATA, LOSS OF USE OR OTHER PECUNIARY LOSS, EVEN IF PHILIPS OR ITS LICENSORS HAVE BEEN ADVISED OF THE POSSIBILITY OF SUCH DAMAGES. IN NO EVENT SHALL PHILIPS' OR ITS LICENSORS' AGGREGATE LIABILITY FOR DAMAGES ARISING OUT OF THIS AGREEMENT EXCEED THE GREATER OF THE PRICE ACTUALLY PAID BY YOU FOR THE SOFTWARE OR FIVE TEN POUNDS STERLING US DOLLARS (510.00).

12. Trademarks. Certain of the product and Philips names used in this Agreement, the Software, and the printed user documentation may constitute trademarks of the Philips, its licensors or other third parties. You are not authorized to use any such trademarks.

13. Export Administration. You agree that you will not directly or indirectly, export or re-export the Software to any country for which the United States Export Administration Act, or any similar United States law or regulation requires an export license or other U.S. Government approval, unless the appropriate export license or approval has first been obtained. By downloading or installing the Software you agree to abide by this Export provision.

14. Governing law. This Agreement is governed by the laws of your country of residence, without reference to its conflict of laws principles. Any dispute between you and Philips regarding this Agreement shall be subject to the non-exclusive jurisdiction of the courts of your country of residence.

15. General. This Agreement contains the entire agreement between you and Philips and supersedes any prior representation, undertaking or other communication or advertising with respect to the Software and user documentation. If any part of this Agreement is held invalid, the remainder of this Agreement will continue in full force and effect. This Agreement shall not prejudice the statutory rights of any party dealing as a consumer.



Free Manuals Download Website

<http://myh66.com>

<http://usermanuals.us>

<http://www.somanuals.com>

<http://www.4manuals.cc>

<http://www.manual-lib.com>

<http://www.404manual.com>

<http://www.luxmanual.com>

<http://aubethermostatmanual.com>

Golf course search by state

<http://golfingnear.com>

Email search by domain

<http://emailbydomain.com>

Auto manuals search

<http://auto.somanuals.com>

TV manuals search

<http://tv.somanuals.com>