

Color TV

Directions for Use



Important!
Return your
Warranty
Registration Card
within 10 days.
See why inside.

Congratulations on purchasing this Philips product.
We've included everything you need to get started.
If you have any problems, Philips Representatives can
help you get the most from your new product by explaining:

- Hookups,
- First Time Setup, and
- Feature Operation.

For fast help, call us first!
1-800-531-0039

Thank you for making Philips a part of your home!

Model No.: _____

Serial No.: _____

Let's make things better.



PHILIPS

Return your Warranty Registration card today to ensure you receive all the benefits you're entitled to.

Once your PHILIPS purchase is registered, you're eligible to receive all the privileges of owning a PHILIPS product. So complete and return the Warranty Registration Card enclosed with your purchase at once. And take advantage of these important benefits.

Warranty Verification

Registering your product within 10 days confirms your right to maximum protection under the terms and conditions of your PHILIPS warranty.

Owner Confirmation

Your completed Warranty Registration Card serves as verification of ownership in the event of product theft or loss.

Model Registration

Returning your Warranty Registration Card right away guarantees you'll receive all the information and special offers which you qualify for as the owner of your model.

Congratulations on your purchase, and welcome to the "family!"

PHILIPS



Dear PHILIPS product owner:

Thank you for your confidence in PHILIPS. You've selected one of the best-built, best-backed products available today. And we'll do everything in our power to keep you happy with your purchase for many years to come. As a member of the PHILIPS "family," you're entitled to protection by one of the most comprehensive warranties and outstanding service networks in the industry.

What's more, your purchase guarantees you'll receive all the information and special offers for which you qualify, plus easy access to accessories from our convenient home shopping network.

And most importantly you can count on our uncompromising commitment to your total satisfaction.

All of this is our way of saying welcome—and thanks for investing in a PHILIPS product.

Sincerely,

Lawrence J. Blanford
President and Chief Executive Officer

P.S. Remember, to get the most from your PHILIPS product, you must return your Warranty Registration Card within 10 days. So please mail it to us right now!

Know these safety symbols



This "bolt of lightning" indicates uninsulated material within your unit may cause an electrical shock. For the safety of everyone in your household, please do not remove product covering.

The "exclamation point" calls attention to features for which you should read the enclosed literature closely to prevent operating and maintenance problems.

WARNING: TO PREVENT FIRE OR SHOCK HAZARD, DO NOT EXPOSE THIS EQUIPMENT TO RAIN OR MOISTURE.

CAUTION: To prevent electric shock, match wide blade of plug to wide slot, and fully insert.

ATTENTION: Pour éviter les chocs électriques, introduire la lame la plus large de la fiche dans la borne correspondante de la prise et pousser jusqu'au fond.

PHILIPS Visit our World Wide Web Site at <http://www.philips.com>

IMPORTANT SAFETY INSTRUCTIONS

Read before operating equipment

1. Read these instructions.
2. Keep these instructions.
3. Heed all warnings.
4. Follow all instructions.
5. Do not use this apparatus near water.
6. Clean only with a dry cloth.
7. Do not block any of the ventilation openings. Install in accordance with the manufacturers instructions.
8. Do not install near any heat sources such as radiators, heat registers, stoves, or other apparatus (including amplifiers) that produce heat.
9. Do not defeat the safety purpose of the polarized or grounding-type plug. A polarized plug has two blades with one wider than the other. A grounding type plug has two blades and third grounding prong. The wide blade or third prong are provided for your safety. When the provided plug does not fit into your outlet, consult an electrician for replacement of the obsolete outlet.
10. Protect the power cord from being walked on or pinched particularly at plugs, convenience receptacles, and the point where they exit from the apparatus.
11. Only use attachments/accessories specified by the manufacturer.
12.  Use only with a cart, stand, tripod, bracket, or table specified by the manufacturer, or sold with the apparatus. When a cart is used, use caution when moving the cart/apparatus combination to avoid injury from tip-over.
13. Unplug this apparatus during lightning storms or when unused for long periods of time.
14. Refer all servicing to qualified service personnel. Servicing is required when the apparatus has been damaged in any way, such as power-supply cord or plug is damaged, liquid has been spilled or objects have fallen into apparatus, the apparatus has been exposed to rain or moisture, does not operate normally, or has been dropped.
15. This product may contain lead and mercury. Disposal of these materials may be regulated due to environmental considerations. For disposal or recycling information, please contact your local authorities or the Electronic Industries Alliance: www.eiae.org
16. **Damage Requiring Service** - The appliance should be serviced by qualified service personnel when:
 - A. The power supply cord or the plug has been damaged; or
 - B. Objects have fallen, or liquid has been spilled into the appliance; or
 - C. The appliance has been exposed to rain; or
 - D. The appliance does not appear to operate normally or exhibits a marked change in performance; or
 - E. The appliance has been dropped, or the enclosure damaged.
17. **Tilt/Stability** - All televisions must comply with recommended international global safety standards for tilt and stability properties of its cabinet design.
 - Do not compromise these design standards by applying excessive pull force to the front, or top, of the cabinet which could ultimately overturn the product.
 - Also, do not endanger yourself, or children, by placing electronic equipment/toys on the top of the cabinet. Such items could unsuspectingly fall from the top of the set and cause product damage and/or personal injury.
18. **Wall or Ceiling Mounting** - The appliance should be mounted to a wall or ceiling only as recommended by the manufacturer.
19. **Power Lines** - An outdoor antenna should be located away from power lines.
20. **Outdoor Antenna Grounding** - If an outside antenna is connected to the receiver, be sure the antenna system is grounded so as to provide some protection against voltage surges and built up static charges.

Section 810 of the National Electric Code, ANSI/NFPA No. 70-1984, provides information with respect to proper grounding of the mast and supporting structure, grounding of the lead-in wire to an antenna discharge unit, size of grounding connectors, location of antenna-discharge unit, connection to grounding electrodes, and requirements for the grounding electrode. See Figure below.
21. **Object and Liquid Entry** - Care should be taken so that objects do not fall and liquids are not spilled into the enclosure through openings.

Note to the CATV system installer: This reminder is provided to call the CATV system installer's attention to Article 820-40 of the NEC that provides guidelines for proper grounding and, in particular, specifies that the cable ground shall be connected to the grounding system of the building, as close to the point of cable entry as practical.

Example of Antenna Grounding as per NEC - National Electric Code

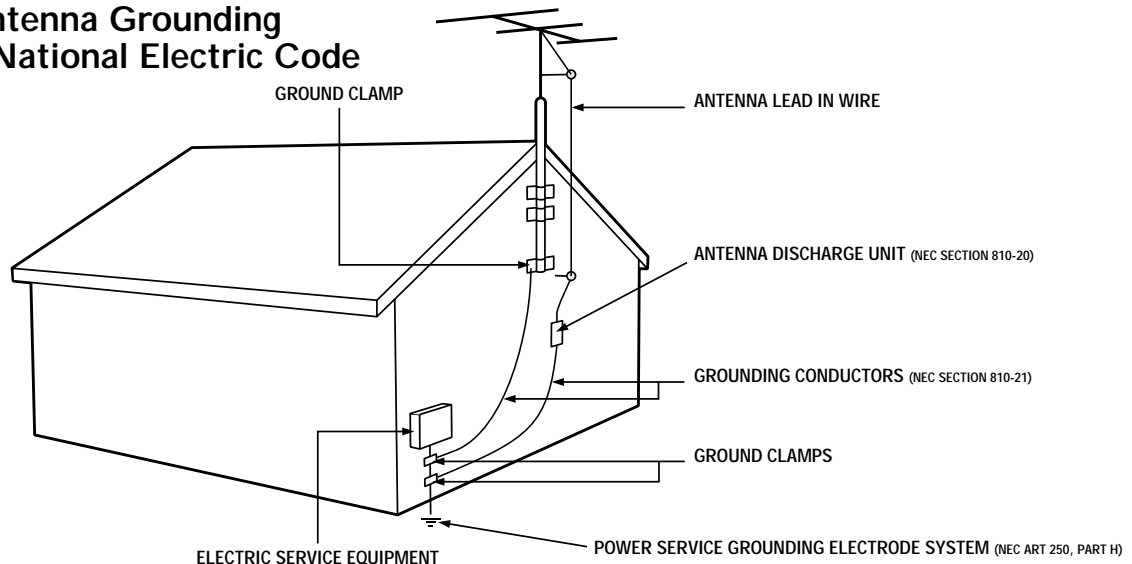

CONTENTS

INTRODUCTION

Welcome/Registration of Your TV	2
Safety/Precautions	2-3
Features	5



AUDIO/VIDEO INPUT JACKS

Jack Panel descriptions and required cables	6
Using the AV 1 Input Jacks	7
Using the AV 2 Input Jacks	8
Using the Side Input Jacks	9
Using the AV 3 Input Jacks	10
Using the AV 4 Input Jacks	11
Using the Component Video Input Jacks (CVI)	12
Using the S-Video Input Jack	13
Using the Monitor Output Jacks	14
Using the Audio Output Jacks	15



PICTURE MENU CONTROLS

Adjusting the Contrast Control	16
Adjusting the Brightness Control	16
Adjusting the Color Control	16
Adjusting the Sharpness Control	16
Adjusting the Tint Control	16
How to set the Color Temp Control	16
How to use the Pixel Plus (Digital Processing) Control	17
How to set the Dynamic Contrast Control	18
How to use the DNR Control	19
How to use the Color Enhancement Control	20
How to use the Auto Picture Control	21
How to set the Picture Format Control	22



SOUND MENU CONTROLS

Adjusting the TV Volume (and Headphone Volume)	23
Adjusting the TV Equalizer Control	24
How to use the Sound Mode Control	25
How to use the Alternate Audio Control	26
How to set the TV for Stereo programming	27
How to use the 3D Surround Effect Control	28
How to use the AVL (Automatic Volume Leveler) Control	29
How to use the Delta Volume Control	30
How to use the Auto Sound Control	31



FEATURE MENU CONTROLS

How to use the Closed Captions Controls	32
How to use the Sleptimer Control	33
How to use the On-Timer Control	34
Using the Channel List Control	35
How to use the Channel Lock Control	36

Using the Lock After Control	37
How to block programming using the TV Ratings Lock Controls	38
How to block programming using the Movie Ratings Controls	39
Editing channels with the Channel Remove Control	40
Using the Antenna Attenuator Control	41



SPEAKER MENU CONTROLS

Using the Test Tone and Speaker Trim Controls	42
How to turn the Center Mode and Surround Speakers Controls on	43



GENERAL MENU CONTROLS

How to use the Menu Background Control	44
Using the Surf Control (Channel Surf)	45
How to use the Dual Screen Format Control	46
How to use the Multipip Control	47
How to use the Freeze Control	48
How to Reset the AV Setting	49
Using the Tilt Adjust Control	49
How to Minimize or Maximize the Onscreen Display	50
How to set up the Timer Zone and Daylight Savings Controls	50
How to change your PIN (Personal Identification Number) for AutoLock features	51
How to Label the AV Sources	52



REMOTE CONTROL RELATED FEATURES

Using the Active Control	53
How to use the Zoom Control	53
Using the Remote Control with accessory devices	
Code-Entry Method	54
Search Method	55
Direct-Entry Code list for accessory devices	56-57
Remote Control VCR Specific Button	58



IMPORTANT INFORMATION

Care and Cleaning	59
Troubleshooting	59
Glossary of terms	60
Index	61
Factory Service Locations	62-63
Limited Warranty	64

QUICK USE AND SETUP GUIDE

Refer to the simple *Quick Use and Setup Guide* (supplied with your TV) for details on Basic Connections, Remote Control Operation, Language and Auto Program.



FEATURES

Active Control™ continuously measures and corrects all incoming signals to help provide the best picture quality. This feature monitors and corrects both the sharpness control and noise reduction control.

Audio/Video Jack Panel allows direct connections with VCRs, DVDs, High Definition Receivers or other devices, providing quality TV picture and sound playback.

Audio Volume Leveler (AVL) Control keeps the TV sound at an even level. Peaks and valleys that occur during program changes or commercial breaks are reduced, making for a more consistent, comfortable sound.

Channel Lock allows you to block the viewing of certain channels or programs with certain ratings if you do not want your children to view inappropriate materials.

Auto Programming scans (when activated) for all available channels from regular antenna or cable signals and stores only active broadcast stations in the TV's memory.

AutoPicture™ allows you to change the picture settings (color, tint, contrast, etc.) for various types of programming, such as sports, movies, multimedia (games), or weak signals with the push of one button. Selections include, Personal, Rich, Natural, Soft, Multimedia, or Eco.

AutoSound™ allows you to change to different factory pre-defined audio settings and a personal control that you set according to your own preferences through the onscreen Sound menu. The five factory-set controls (Personal, Speech, Music, Movie, and Multimedia) enable you to tailor the TV sound so as to enhance the particular programming you are watching.

Channel Remove allows you to delete channels from the list stored in the TV's memory. Channel Remove makes it easy to limit the number of channels that are available to you when you press the Channel (+) or (-) buttons on your remote control.

Closed Captioning allows the viewer to read TV program dialogue or voice conversations as onscreen text.

Dynamic Contrast helps to sharpen the picture quality by improving the contrast between the darkest and brightest parts of the picture.

Pixel Plus™ (or Digital Processing) gives a choice of two different scanning techniques – Progressive Scan or Pixel Plus.

Progressive Scan doubles the number of picture lines, eliminating line flicker and providing a jitter-free picture.

Pixel Plus™ improves the appearance of onscreen motion. The number of picture lines are increased along with the number of pixels per line, giving normal broadcast signals, DVD reproduction or Digital TV signals, unparalleled sharpness and depth. Gives the viewer near High Definition and natural looking detail without the High Definition signal.

Infrared Remote Control works your TV and other remote-controlled devices, such as VCRs, DVD players, cable converters, satellite receivers, etc.

Onscreen Menu shows helpful messages and instructions for setting TV feature controls (can be viewed in English, French, or Spanish).

Sleep Timer automatically turns the TV OFF after a set amount of time that you choose.

Standard Broadcast (VHF/UHF) or Cable TV (CATV) channel capability allows for viewing by antenna or cable.

Stereo capability, including a built-in audio amplifier and twin-speaker system, allows for the reception of TV programs broadcast in stereo sound.

Surf Button allows you to easily switch among only the channels that are of interest to you (the ones that you have programmed into the TV's Surf control through the onscreen menu). Surf allows 2 channel surfing or 9 channel surfing.

Timer allows you to set your TV to turn itself ON and OFF once or daily like an alarm clock.

Items Included with This TV

As you unpack your TV, please note the included items:

- **Directions for Use manual (contains safety-tip, cleaning and Factory Service Center location information)**
- **Warranty Registration Card**
- **Remote Control (with supplied batteries for use)**
- **Quick Use Guide to help you set up your new TV.**

Please take a few minutes to complete your registration card. The serial number for the TV is on the rear of the set. For your future reference, please write down the serial and model number of this television in the space provided on the cover of this manual. (In the unlikely event you should need to place a service call, these numbers will be needed.)

END-OF-LIFE DISPOSAL

Your new television and its packing contain materials that can be recycled and reused. Specialized companies can recycle your product to increase the amount of reusable materials and minimize the amounts that need to be properly disposed.

Your product also uses batteries that should not be thrown away when depleted, but should be handed in and disposed of as small chemical waste.

When you replace your existing equipment, please find out about the local regulations regarding disposal of your old television, batteries, and packing materials.



As an Energy Star® Partner, Philips Consumer Electronics has determined this product meets the Energy Star® guidelines for energy efficiency. Energy Star® is a U.S. registered mark. Using products with the Energy Star® label can save energy. Saving energy reduces air pollution and lowers utility bills.

Active Control, AutoPicture, AutoSound, Pixel Plus are trademarks of Philips Consumer Electronics Company. Copyright 2002 Philips Consumer Electronics.



JACK PANEL DESCRIPTIONS AND REQUIRED CABLES

The television is equipped with external input and output jacks for use with optional accessory devices such as Home entertainment Receivers, VCRs, DVD Player, Gaming Units, Video Cameras, etc. The following gives a brief explanation of the different types of jacks available and the type of cables needed to make connections.

- 1** **75Ω RF** - Cable/Antenna Input connection jack.
- 2** **AV 1 IN** - Audio/Video connection jacks including Component Video Inputs.
- 3** **AV 2 IN** - Audio/Video Input connection jacks including S-Video connections.
- 4** **AV 3 IN** - Component Video, VGA (RGB), and Audio Input connection jacks.
- 5** **AV 4 IN** - High Definition Component Video and Audio Input connection jacks.
- 6** **Monitor Out** - Audio/Video Output connection jacks (TV tuner signal only).
- 7** **Audio Out** - Audio connections for home entertainment receivers and external speakers.
- 8** **SIDE** - Audio/Video Input jacks include a S-Video jack, plus a Headphone jack located on the side of the cabinet.

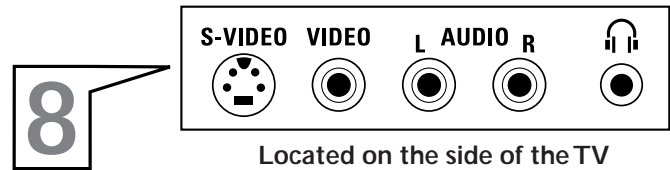
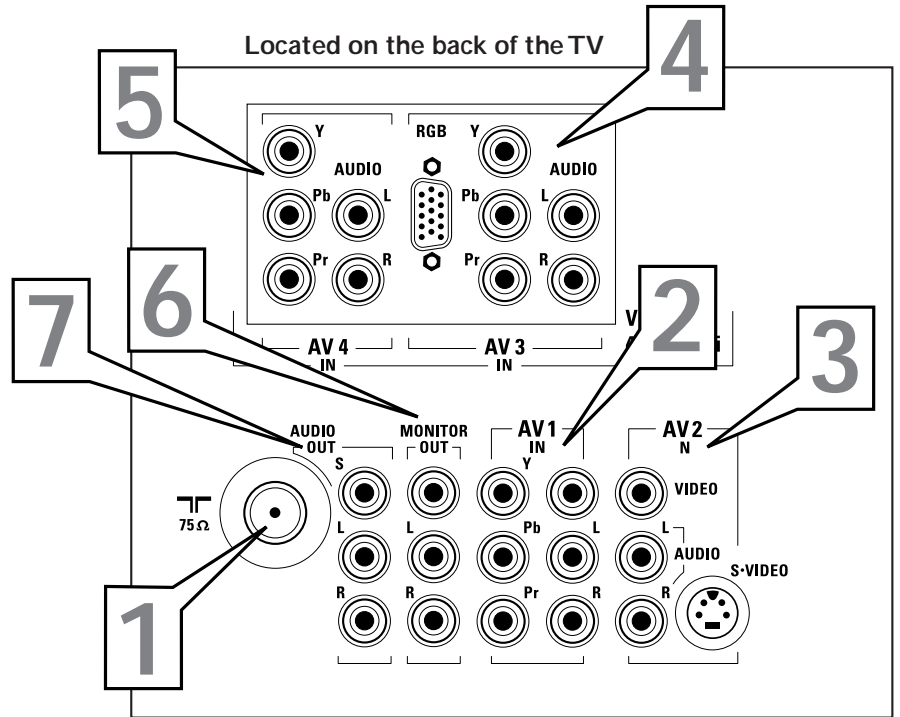

Cable Descriptions:



A 75-ohm **coaxial cable** connects signals from an antenna or a cable TV company to the antenna jack on the back of the TV. Coaxial cables use "F" connectors.

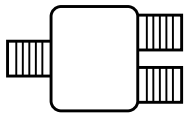

A **two-way signal splitter** enables you to take a single antenna or cable TV signal and supply it to two different inputs.

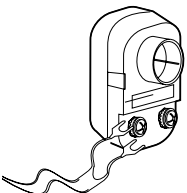

A **300- to 75-ohm twin-lead adapter** accepts the antenna cables (called twin-lead wires) from an antenna, allowing you to connect the antenna signal to the TV.

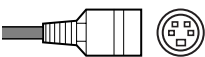

An **S-Video cable** provides better picture performance than regular (composite) video connections. S-Video cables can be used only with S-Video-compatible accessory devices. You must also connect the left and right audio cables to the AV 2 Audio in jacks because the S-Video jack carries only the picture signal, not the sound.

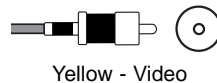

Yellow - Video



White - Audio Left



Red - Audio Right

Video and audio cables with standard RCA (phono) connectors connect the video and audio jacks of accessory devices such as VCRs and DVD players to the jacks on the TV.

These connectors are usually color coded. The jacks on your TV are also color coded to match the colors of the connectors. Yellow for video (composite) and Red and White for the right and left audio channels. The video cables used to connect component video or RGB (high-resolution) jacks are color coded red, green, and blue.

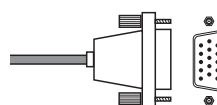

A **VGA (HD15) cable** makes a VGA (RGB) connection to the HD INPUT-AV 4 jack on the rear of the TV.

USING THE AV 1 INPUT JACKS

The TV's audio/video input jacks are for direct picture and sound connections between the TV and a VCR (or similar device) that has audio/video output jacks. Follow the easy steps below to connect your accessory device to the AV 1 Input Jacks located on the back of the TV.

- 1 **Connect the VIDEO (yellow) cable** to the VIDEO AV1 IN jack on the back of the TV.
- 2 **Connect the AUDIO (red and white) cables** to the AUDIO (left and right) AV1 IN jacks on the rear of the TV.
- 3 **Connect the VIDEO (yellow) cable** to the VIDEO OUT jack on the back of the VCR.
- 4 **Connect the AUDIO (red and white) cables** to the AUDIO (left and right) OUT jacks on the rear of the VCR.
- 5 **Turn the VCR (accessory device) and the TV ON.**
- 6 **Press the SOURCE SELECT button** on the remote control to display the SOURCE menu.
- 7 **Press the CURSOR UP or DOWN button** to select the AV1 option.
- 8 **Press the OK button** to confirm your selection. The TV will change to the AV1 channel.

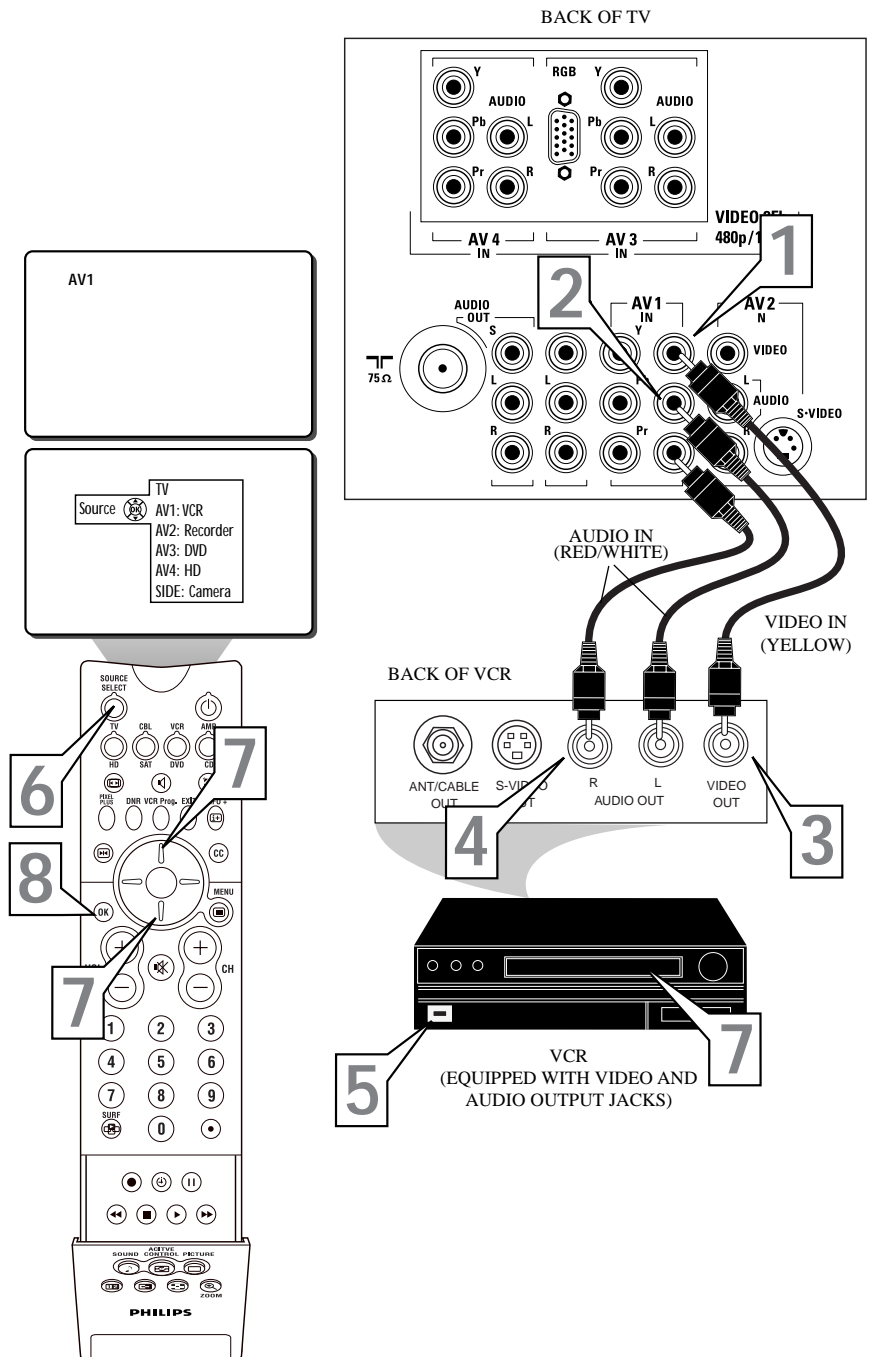



USING THE AV 2 INPUT JACKS

The TV's audio/video input jacks allow you to connect multiple accessory devices at one time to different sets of input jacks. Follow the easy steps below to connect an additional accessory device to the AV 2 Input Jacks located on the back of the TV.

- 1 **Connect the VIDEO (yellow) cable** to the VIDEO AV2 IN jack on the back of the TV.
- 2 **Connect the AUDIO (red and white) cables** to the AUDIO (left and right) AV2 IN jacks on the rear of the TV.
- 3 **Connect the VIDEO (yellow) cable** to the VIDEO OUT jack on the back of the VCR.
- 4 **Connect the AUDIO (red and white) cables** to the AUDIO (left and right) OUT jacks on the rear of the VCR.
- 5 **Turn the VCR (accessory device) and the TV ON.**
- 6 **Press the SOURCE SELECT button** on the remote control to display the SOURCE menu.
- 7 **Press the CURSOR UP or DOWN button** to select the AV2 option.
- 8 **Press the OK button** to confirm your selection. The TV will change to the AV2 channel.
- 9 **With the VCR (or accessory device) ON and a prerecorded tape (or other media depending on type of accessory device being used) inserted, press the PLAY button** to view the tape on the television.

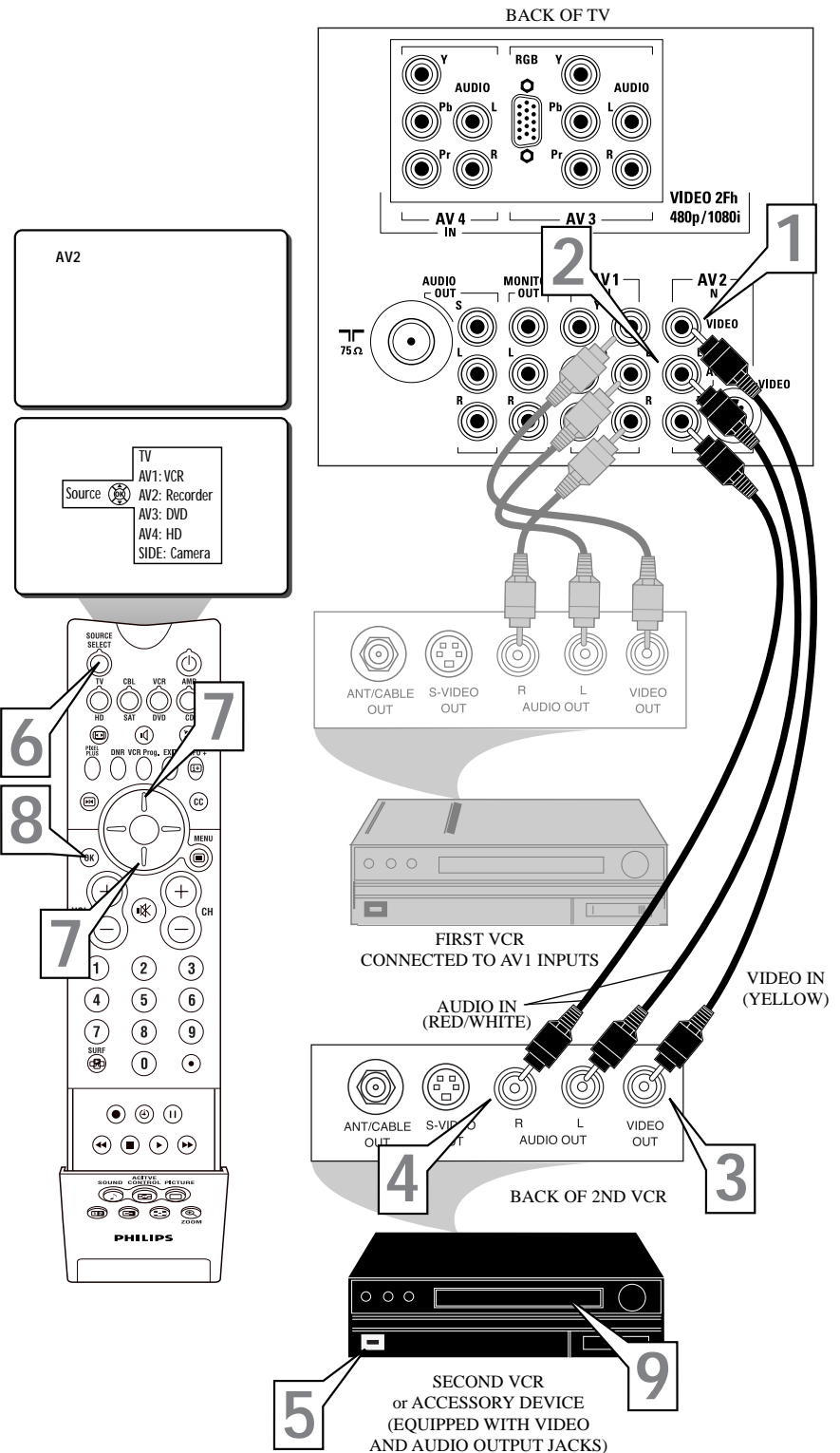

USING THE SIDE INPUT JACKS



This television has input jacks conveniently located on the side of the cabinet. These jack are for easy hook-ups (without having to move around to the back of the TV) for cameras, gaming units, and other accessory devices that wouldn't be connected permanently. Follow the easy steps below to connect your accessory device to the SIDE Input Jacks located on the right side of the TV.

- 1** Connect the VIDEO (yellow) cable to the VIDEO IN jack on the side of the TV.
- 2** Connect the AUDIO (red and white) cables to the AUDIO (left and right) IN jacks on the side of the TV.
- 3** Connect the VIDEO (yellow) cable to the VIDEO OUT jack on the back of the camera (or accessory device).
- 4** Connect the AUDIO (red and white) cables to the AUDIO (left and right) OUT jacks on the rear of the camera (or accessory device).
- 5** Turn the camera (or accessory device) and the TV ON.
- 6** Press the SOURCE SELECT button on the remote control to display the SOURCE menu.
- 7** Press the CURSOR UP or DOWN button to select the SIDE option.
- 8** Press the OK button to confirm your selection. The TV will change to the SIDE channel.
- 9** With the camera (or accessory device) ON and a prerecorded tape (or other media depending on type of accessory device being used) inserted, press the PLAY button to view the tape on the television.

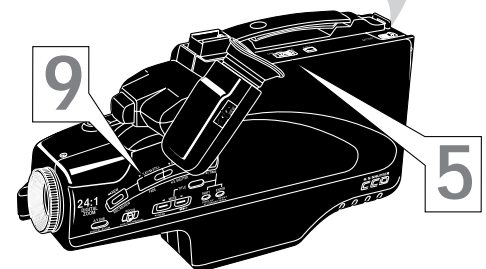
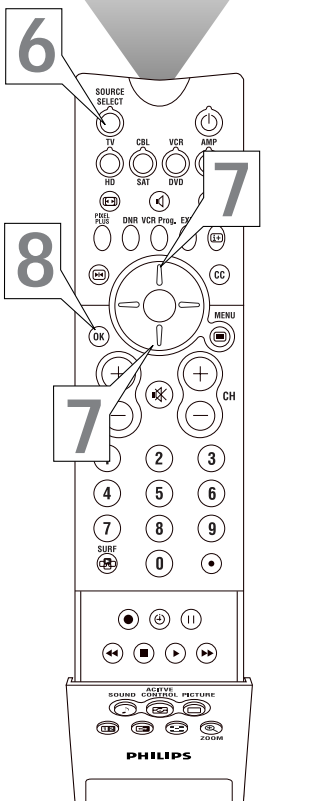
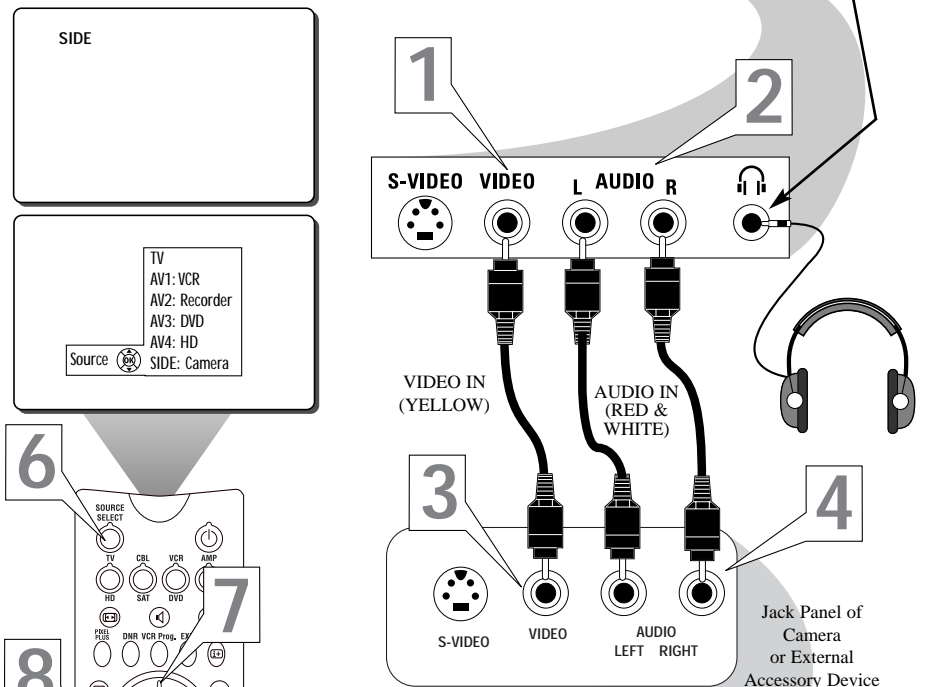
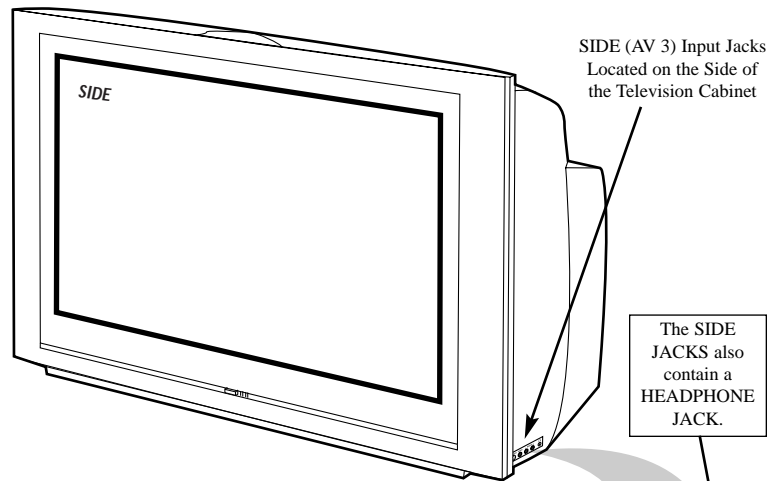

NOTE: The S-Video Cable can be used in place of the Yellow Video cable shown in this diagram. If your camera or accessory device has a S-Video output jack, connecting the video signal through the S-Video jack will reproduce the video signal with greater quality.



USING THE AV 3 INPUT JACKS

The AV3 Input Jacks provide Both Component and RGB Video Inputs at 1080i, for accessories like a HD Receiver and Digital DVD Players. Using the color difference signals (Pb, Pr) and the luminance (Y) signal will improve color bandwidth information. The TV can also become a monitor for projectors, computers or HD Receivers using the RGB Input.

Note: If the AV3 channel is tuned and no signal connection present, the screen could jump or flash.

- 1** Connect the Component (Y, Pb, Pr) Video OUT jacks from the DVD player (or similar device) to the (Y, Pb, Pr) AV3 IN(put) jacks on the TV.
- 2** Connect the red and white AUDIO CABLES to the Audio (left and right) output jacks on the rear of the accessory device to the Audio (L and R) AV3 IN(put) jacks on the TV.
- 3** Connect a RGB cable from the VGA OUT on the HD Receiver to the AV3 RGB Input jack on the back of the TV.
- 4** Connect a 75Ω round cable from the OUT TO TV jack on the HD Receiver to the 75Ω IN on the back of the TV.
- 5** If using a Satellite Dish, Cable signal or Antenna signal, connect the 75Ω round cable from a Satellite Dish to the SATELLITE IN and/or the Cable and Antenna signals to the ANTENNA "A" or "B" IN on the back of the HD Receiver.
- 6** Press the SOURCE SELECT button on the remote control to display the SOURCE menu.
- 7** Press the CURSOR UP or DOWN button to select the AV3 option.
- 8** Press the OK button to confirm your selection. The TV will change to the AV3 channel.

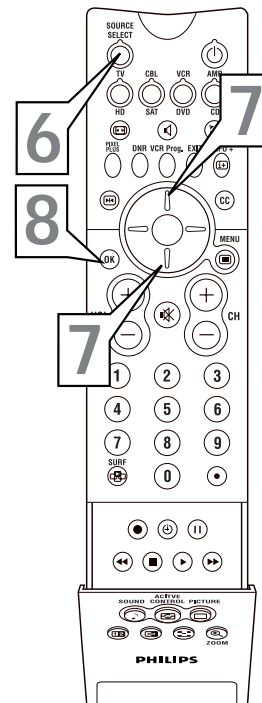
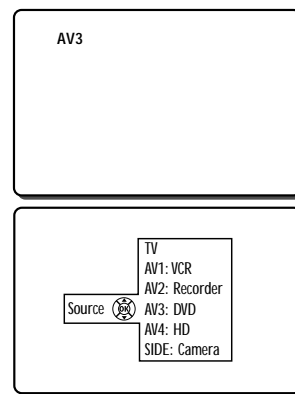
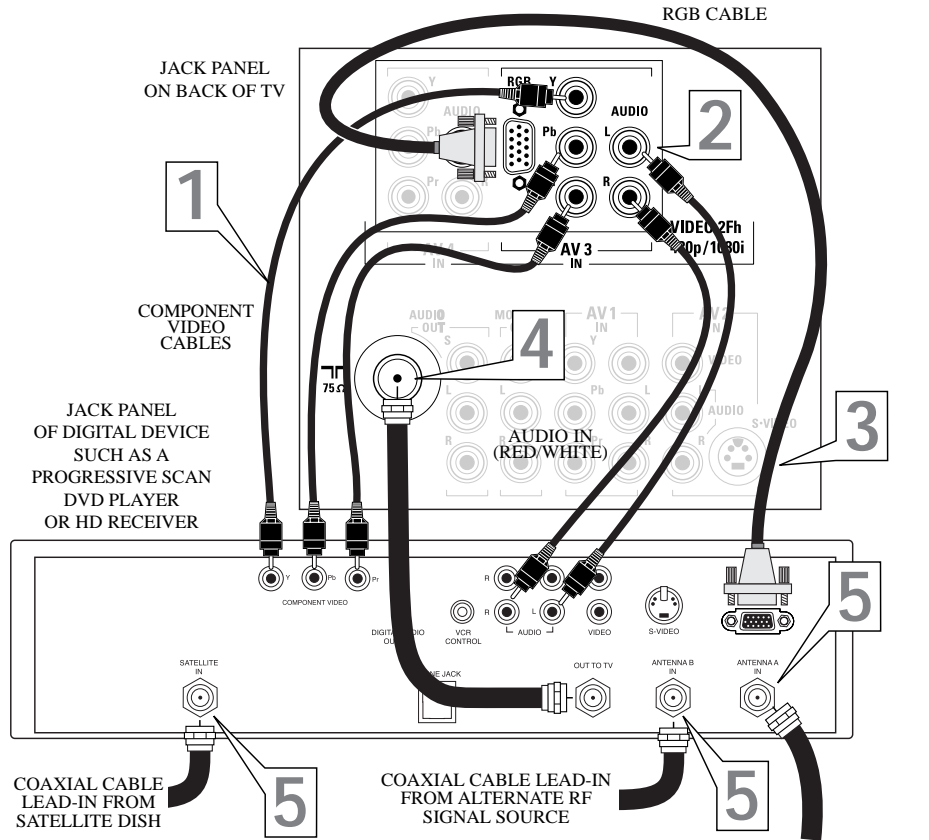



USING THE AV 4 INPUT JACKS

The AV4 Input Jacks provide Component Video Inputs at 1080i, for accessories like a HD Receiver and Digital DVD Players. Using the color difference signals (Pb, Pr) and the luminance (Y) signal will improve color bandwidth information.

Note: If the AV4 channel is tuned and no signal connection present, the screen could jump or flash.

- 1** Connect the Component (Y, Pb, Pr) Video OUT jacks from the DVD player (or similar device) to the (Y, Pb, Pr) AV4 IN(put) jacks on the TV.
- 2** Connect the red and white AUDIO CABLES to the AUDIO (left and right) OUT(put) jacks on the rear of the accessory device to the Audio (L and R) AV4 IN(put) jacks on the TV.
- 3** Press the SOURCE SELECT button on the remote control to display the SOURCE menu.
- 4** Press the CURSOR UP or DOWN button to select the AV3 option.
- 5** Press the OK button to confirm your selection. The TV will change to the AV3 channel.
- 6** Turn the TV and the DVD (or digital accessory device) ON.
- 7** Press the PLAY button on the DVD (or digital accessory device) to view the program on the television.

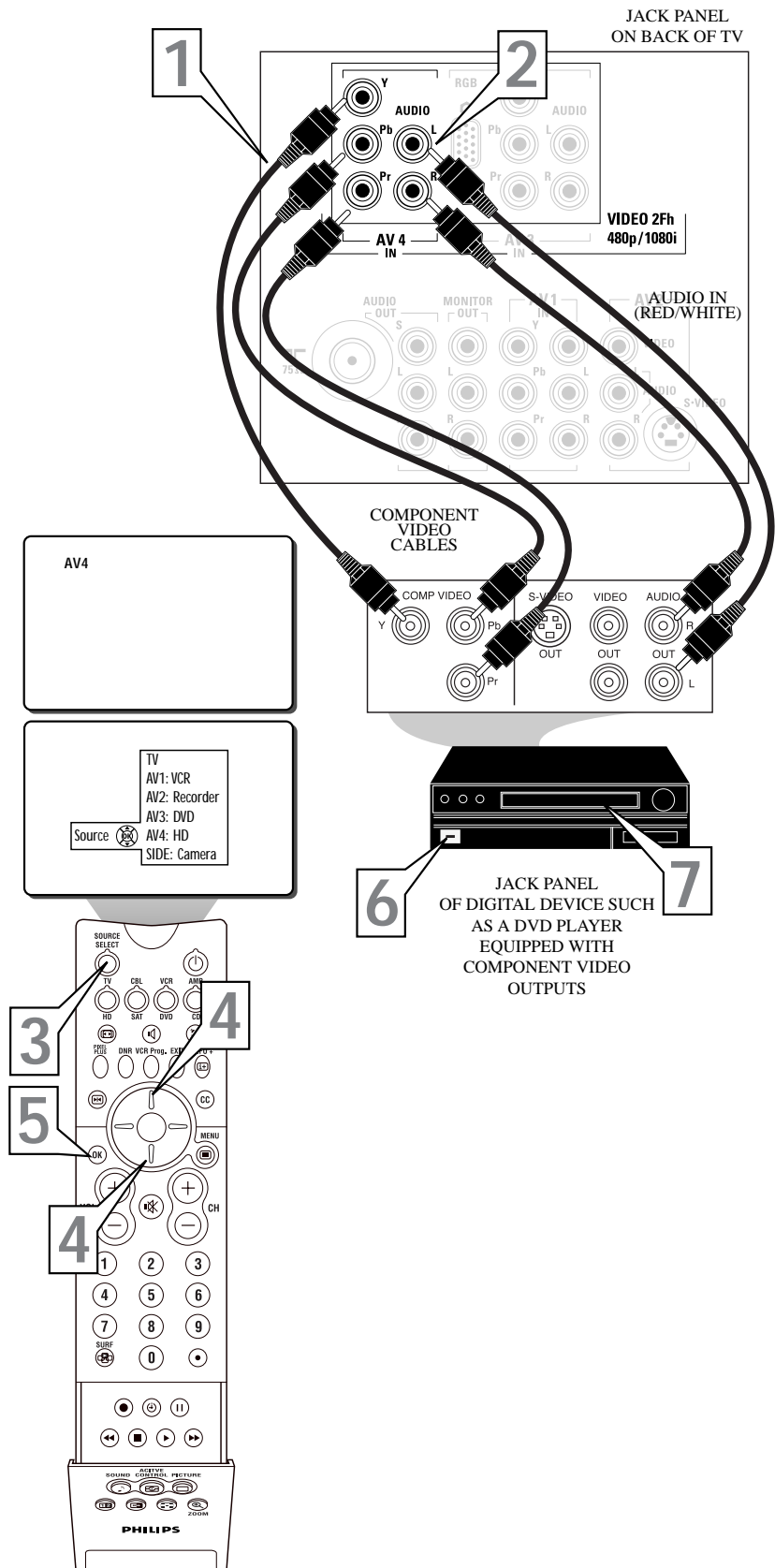



USING THE COMPONENT VIDEO INPUT (AV1) JACKS

If using an accessory device that is not high definition but uses Component Video jacks. The AV1 jacks on the TV offer the user the possibility of better video reproduction using the Component Video Inputs. The color difference signals (Pb, Pr) and the luminance (Y) signal are connected and received separately, which allows for improved color bandwidth information (not possible when using composite video or S-Video connections).

- 1** Connect the Component (Y, Pb, Pr) Video OUT jacks from the DVD player (or similar device) to the (Y, Pb, Pr) IN(put) jacks on the TV. When using the Component Video Inputs, it is best not to connect a signal to the AV1 Video Input.
- 2** Connect the yellow VIDEO CABLE along with the red and white AUDIO CABLES to the AUDIO (left and right) OUT(put) jacks on the rear of the accessory device to the AV1 VIDEO and AUDIO IN(put) jacks on the TV.
- 3** Press the SOURCE SELECT button on the remote control to display the SOURCE menu.
- 4** Press the CURSOR UP or DOWN button to select the AV1 option. CVI will show onscreen rather than AV1.
- 5** Press the OK button to confirm your selection. The TV will change to the AV1 channel.
- 6** Turn the TV and the DVD (or digital accessory device) ON.
- 7** Insert a DVD disc into the DVD player and press the PLAY button on the DVD Player (or digital accessory device).

The CVI connection will dominate over the AV1 Video Input. When a Component Video Device is connected as described, it is best not to have a video signal connected to the AV1 Video Input jack.

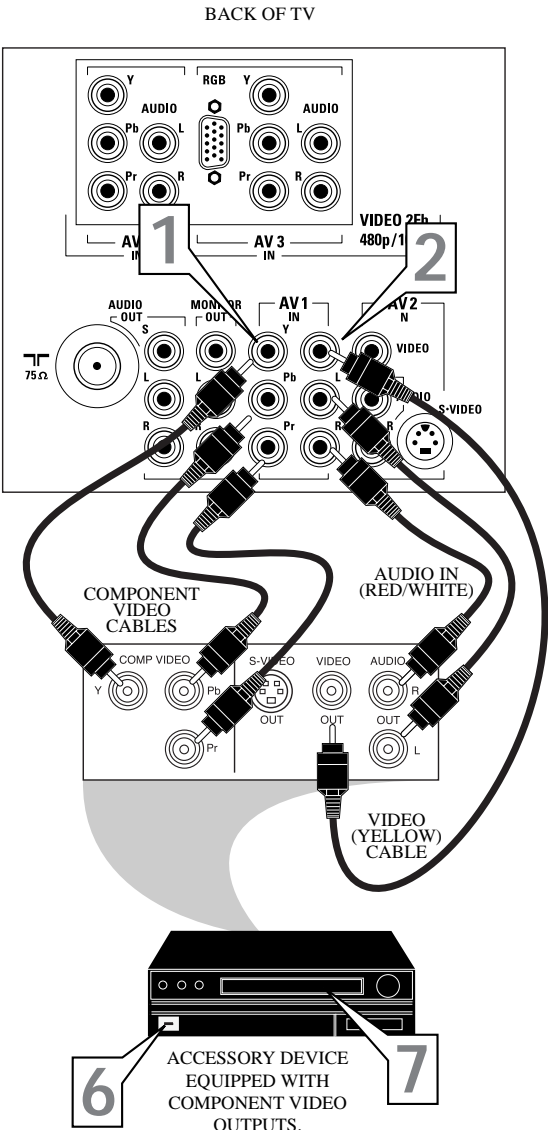
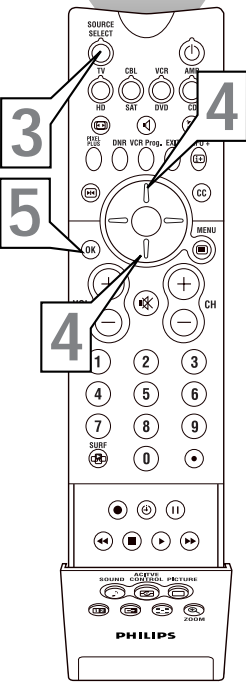
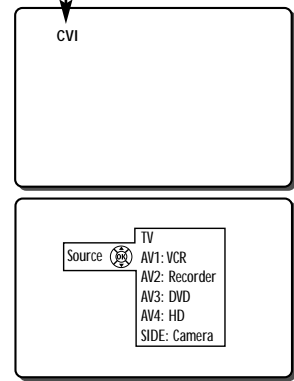

HELPFUL HINT

The description for the component video connectors may differ depending on the DVD player or accessory digital source equipment used (for example, Y, Pb, Pr; Y, B-Y, R-Y; Y, Cr, Cb). Although abbreviations and terms may vary, the letters *b* and *r* stand for the blue and red color component signal connectors, and *Y* indicates the luminance signal. Refer to your DVD or digital accessory owner's manual for definitions and connection details.

USING THE S-VIDEO INPUT JACKS



The S(uper)-Video connection on the rear of the TV can provide you with better picture detail and clarity for the playback of accessory sources such as DBS (digital broadcast satellite), DVD (digital video discs), video games, and S-VHS VCR (video cassette recorder) tapes than the normal antenna picture connections.

NOTE: The accessory device must have an S-VIDEO OUT(put) jack in order for you to complete the connection on this page.

- 1 **Connect the S-VIDEO CABLE** to the S-VIDEO input jack on the rear of the television.
- 2 **Connect the AUDIO (red and white) cables** to the AUDIO AV2 IN jacks on the rear of the TV.
- 3 **Connect the S-VIDEO CABLE** to the S-VIDEO OUT(put) jack on the accessory device.
- 4 **Connect the red and white AUDIO cables** to the AUDIO (left and right) OUT(put) jacks on the rear of the accessory device.
- 5 **Press the SOURCE SELECT button** on the remote control to display the SOURCE menu.
- 6 **Press the CURSOR UP or DOWN button** to select the AV2 option.
- 7 **Press the OK button** to confirm your selection. The TV will change to the AV2 channel.
- 8 **Turn the VCR, DVD or other accessory device ON.**
- 9 **With the VCR (or accessory device) ON and a prerecorded tape inserted, press the PLAY button** to view the tape on the television.

When using the S-Video Input, do not connect a video signal to the AV 2 IN Video Jack. This could cause a ghost image to appear over the S-Video signal.

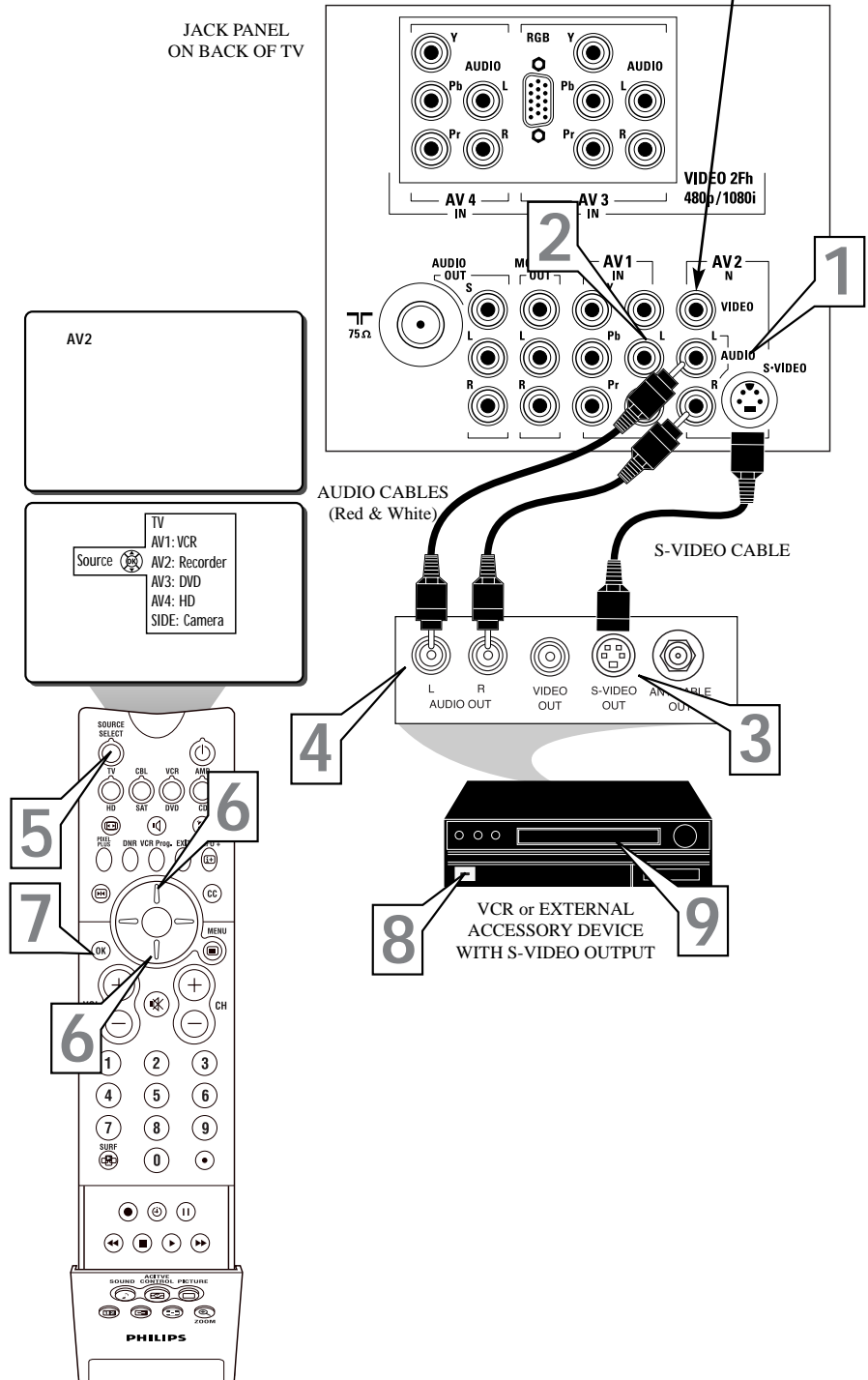

✓ CHECK IT OUT

The S-Video jack and the AV 2 jacks work together. When a device is connected to the S-Video jack, do not connect a signal to the AV 2 IN Video jack. This could cause an over-lapping of two video images on the TV screen.



USING THE MONITOR OUTPUT JACKS

The Audio/Video (Monitor) Output jacks can be used for recording a selected TV (Antenna Input/tuner signal source) Channel. This recording can even be completed while viewing another external Audio/Video Source Select option. (For example: DVD program playback shown through the AV 1 or 2 Input source connection.)

NOTE: Refer to page 7 for the proper hookup of an accessory device to the AV 1 IN(put) jacks. Follow the instructions on how to tune to the AV 1 channel to view a DVD program playback or pre-recorded VCR tape.

The following steps allow you to connect a VCR to record a selected TV channel program through the Monitor Outputs.

- 1** Connect one end of the yellow Video Cable to the Monitor Out VIDEO plug. Connect the other end to the VIDEO IN plug on the VCR.
- 2** Connect one end of the red and white Audio cable from the Monitor Out AUDIO L and R plugs on the TV to the AUDIO IN plugs on the VCR.
- 3** Tune the TV to the program channel you wish to record.
Note: Once selected be sure to leave the TV channel tuned to the desired program until the complete recording is finished.
- 4** Press the SOURCE SELECT button on the remote control to display the SOURCE menu.
- 5** Press the CURSOR UP or DOWN button to select the AV1 option (or any of the other AV connection options from which you wish to watch an accessory device playback. Example: DVD playback on AV 1).
- 6** Press the OK button to confirm your selection. The TV will change to the AV1 channel input (or any other source option you wish to select).
- 7** Turn the VCR ON, insert a blank VHS tape and it's ready to record the channel program you selected previously in step #3.

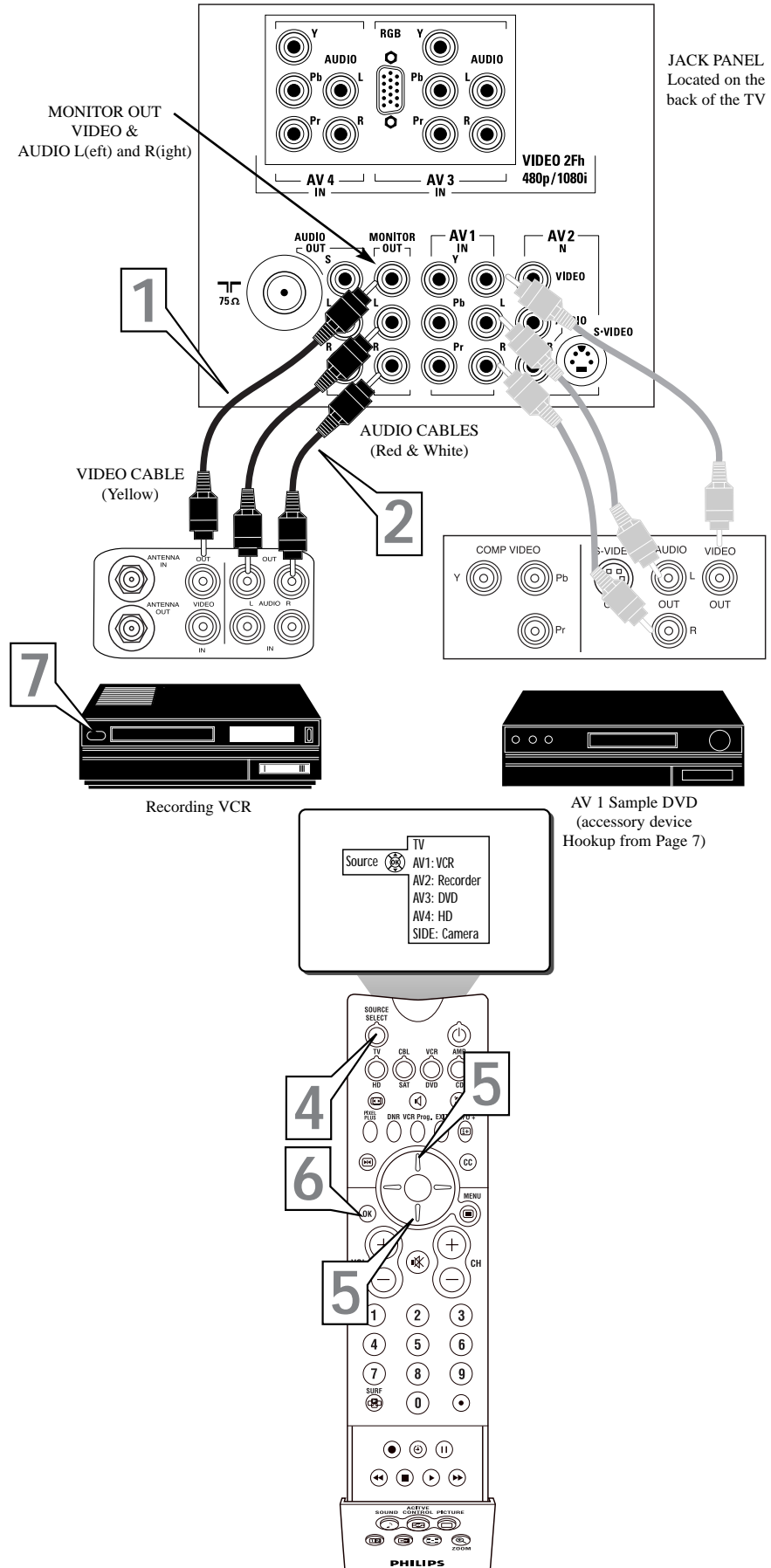

USING THE AUDIO OUTPUT JACKS

The Audio Output jacks are great for connecting to an external audio system or a set of external speakers. This will enhance the sound coming from the television to improve your viewing and listening experience.

For Audio System Connection:

- 1 Connect one end of the R(ight) and L(ef) Audio Cables (red and white) to the AUDIO OUT (Left and Right) jacks on the television.
- 2 Connect the other ends of the R(ight) and L(ef) Audio Cables (red and white) to the Audio Left and Right Input jacks on the external Audio System.
- 3 Turn the Audio System and the TV on. Adjust the volume coming from the Audio System to a pleasant listening level.
- 4 You can now adjust the sound level coming from the audio system by pressing the VOLUME (+) or (-) button on the TV or remote control.

For External Speaker Connection:

- 1 Connect one end of the R(ight) and L(ef) Audio Cables (red and white) to each of the external speakers.
- 2 Using a Stereo to Mono adapter (not supplied) connect the other ends of the Audio Cables to the Stereo end of the adapter.
- 3 Connect the mono end of the Stereo to Mono Adapter to the AUDIO OUT S jack.

These speakers can now be adjusted using the Speaker controls within the Setting section of the onscreen menu. Please see page 42 for more details.

External Audio System:

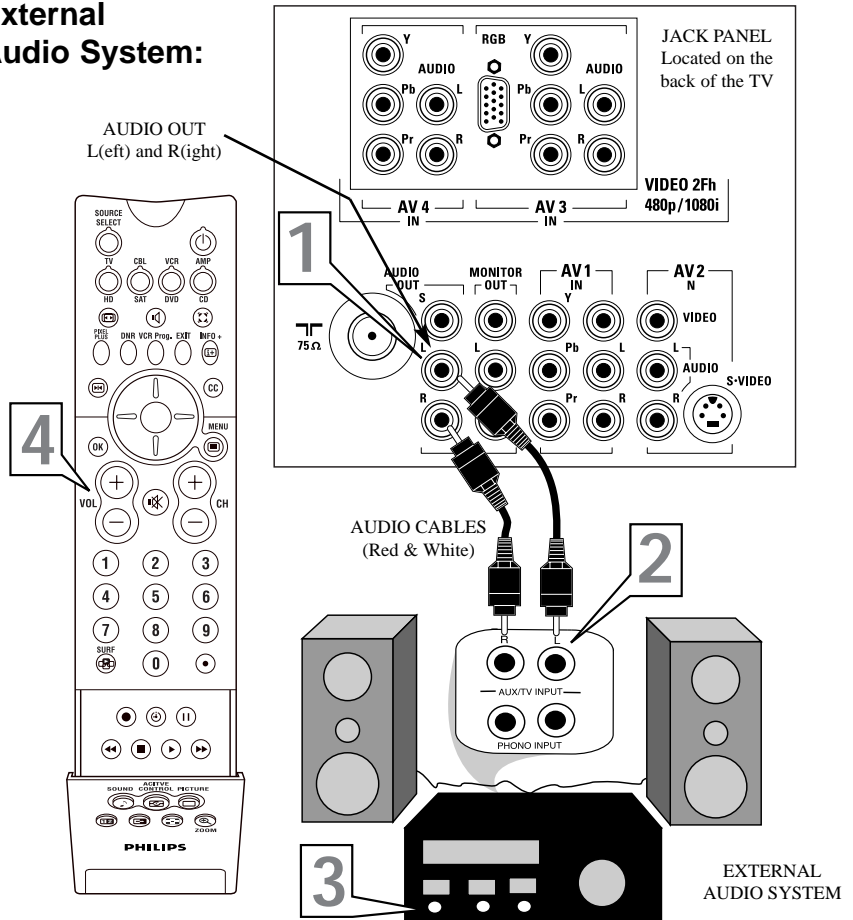

External Speakers:

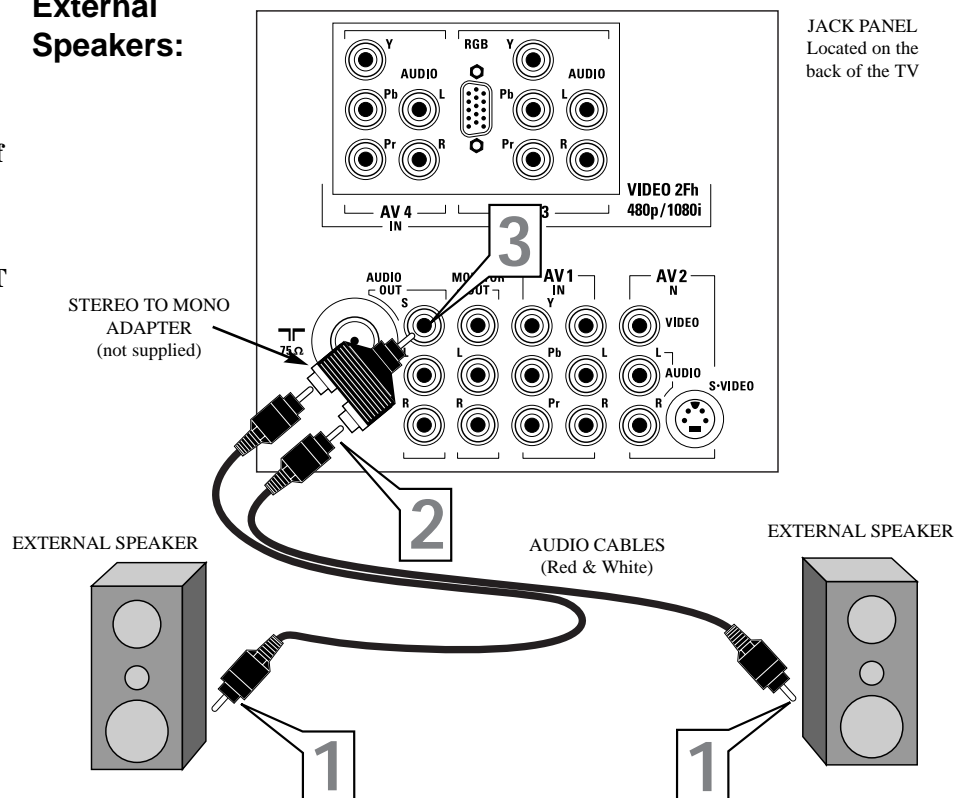



ADJUSTING THE PICTURE CONTROLS

To adjust your TV picture controls, select a channel and follow these steps.

- 1 Press the **MENU** button on the remote control to show the onscreen menu.
- 2 Press the **CURSOR RIGHT** button to highlight **PICTURE**.
- 3 Press the **CURSOR DOWN** button to select one of the picture adjustment: **CONTRAST**, **BRIGHTNESS**, **COLOR**, **SHARPNESS**, **TINT**, OR **COLOR TEMPERATURE**.

NOTE: The menu will show only four items at a time, so you will need to continue scrolling with the **CURSOR DOWN** button to adjust the **TINT** and **COLOR TEMPERATURE**.

- 4 Press the **CURSOR LEFT** or **CURSOR RIGHT** button to adjust the selected control. OR, if **COLOR TEMPERATURE** is chosen, press the **CURSOR RIGHT** to choose from a submenu of options; **NORMAL**, **COOL**, or **WARM**.

- 5 Press the **MENU** button when finished to remove the onscreen menu from the TV screen.

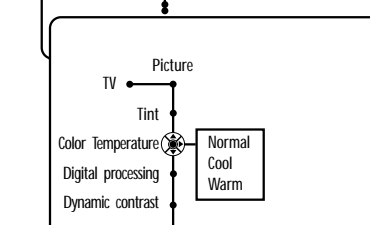
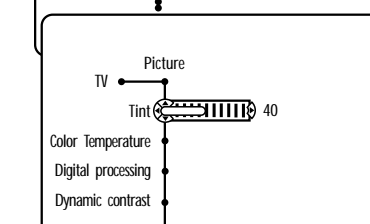
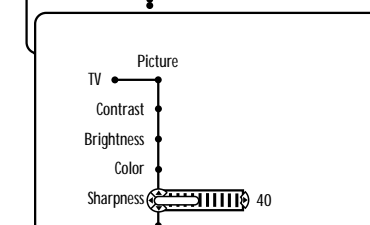
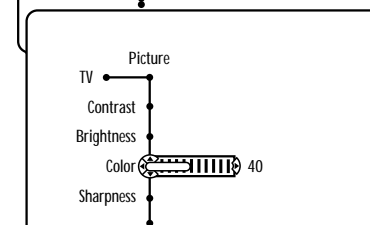
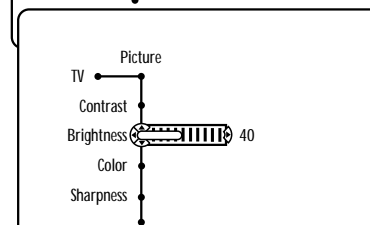
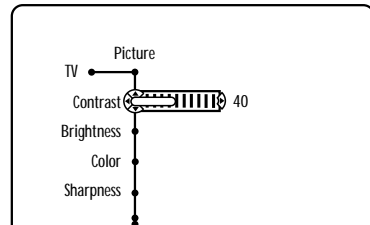
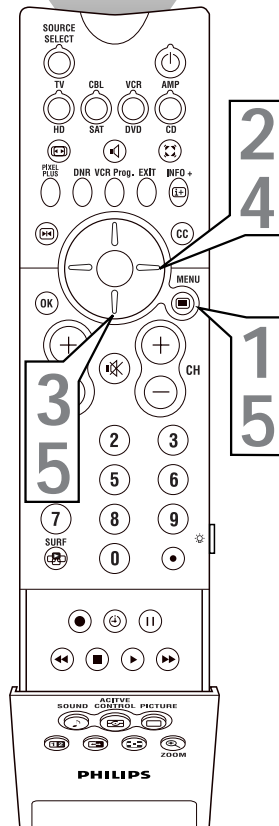
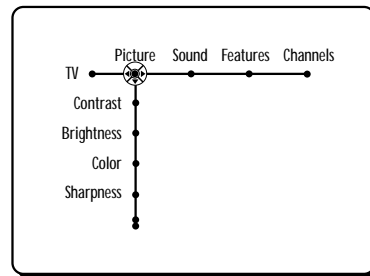
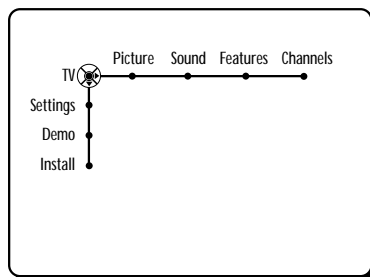

HELPFUL HINT

Remember, when the bar scale is centered , the control settings are at normal, mid-range levels.

NOTE: The **SHARPNESS** and **TINT** Controls will not be available for adjustments when tuned to the **AV3/AV4/CVI** Inputs.

BRIGHTNESS – adds or subtracts light from the darkest part of the picture.

COLOR – adds or eliminates color.

PICTURE – improves the detail of the lightest parts of the picture.

SHARPNESS – improves the detail in the picture.

TINT – adjusts the picture to obtain natural skin tones.

COLOR TEMP offers **NORMAL**, **COOL**, or **WARM** picture preferences.

NORMAL – keeps whites, white.

COOL – makes whites, bluish.

WARM – makes whites, reddish.

HOW TO USE THE DIGITAL PROCESSING CONTROL



The Digital Processing control gives you a choice between two different picture scanning modes: Progressive Scan or Pixel Plus.

Progressive Scan doubles the number of picture lines, eliminating line flicker and providing a jitter-free picture.

Pixel Plus improves the picture quality and appearance of onscreen images. The number of picture lines are increased along with the number of pixels per line, giving normal broadcast signals, DVD reproduction or Digital TV signals, unparalleled sharpness and depth. This gives the viewer near High Definition and natural looking detail without the High Definition signal.

- 1 Press the **MENU** button on the remote to display the onscreen menu.
- 2 Press the **CURSOR RIGHT** button to highlight PICTURE.
- 3 Press the **CURSOR DOWN** button repeatedly until the DIGITAL PROCESSING control is highlighted.
- 4 Press the **CURSOR RIGHT** button to enter the Digital Processing sub-menu.
- 5 Press the **CURSOR UP** or **DOWN** button to select PROGRESSIVE SCAN or PIXEL PLUS.
- 6 Press the **MENU** button to remove the onscreen menu from the TV screen.

HELPFUL HINT

With the use of Pixel Plus some DVD players may display certain screen elements or artifacts while in playback. The Auto Picture-SOFT control (see page 21) can also be used to help reduce the appearance and level of such a screen playback condition.

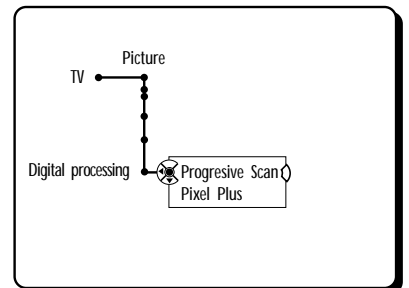
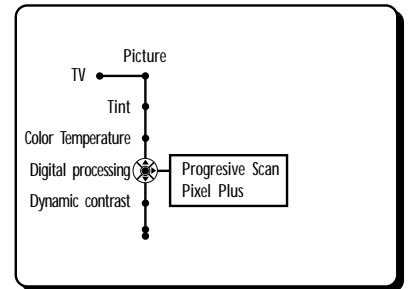
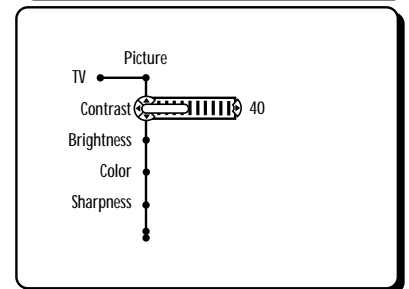
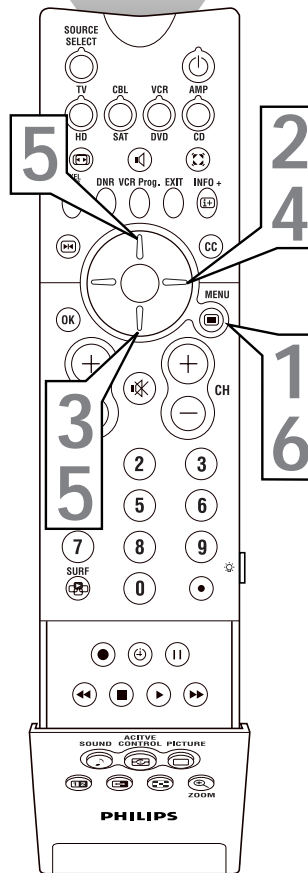
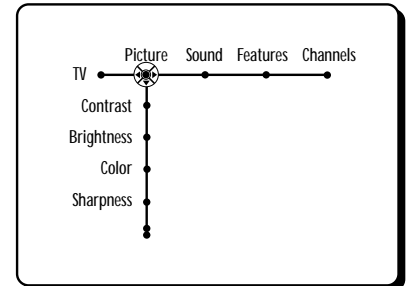
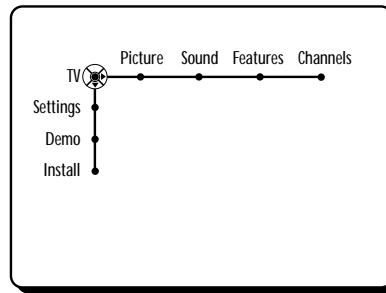

OR

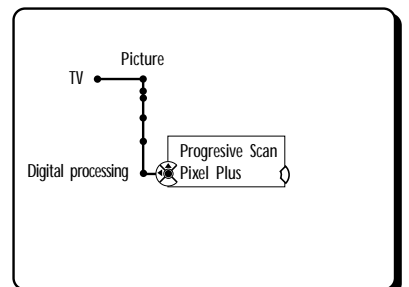

Note: The Digital Processing Control is not available for use with the AV 3 or AV 4 input jacks.

Pixel Plus Demo

With Pixel Plus ON, there is a sharper image with more natural motion. The picture will appear flicker free.

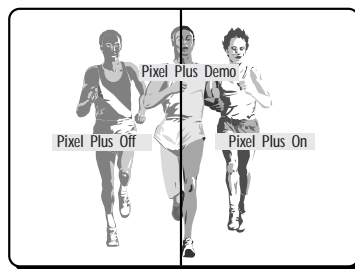
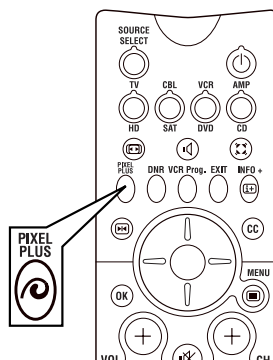



HOW TO SET THE DYNAMIC CONTRAST CONTROL

The Dynamic Contrast control allows you to sharpen the picture quality by making dark portions of the picture darker and light portions of the picture more noticeable. Normally, you will probably want to select **MEDIUM**. In certain circumstances, however, you may prefer **MINIMUM** or **MAXIMUM**.

- 1** Press the **MENU** button on the remote to display the onscreen menu.
- 2** Press the **CURSOR RIGHT** button to highlight PICTURE.
- 3** Press the **CURSOR DOWN** button repeatedly until the **DYNAMIC CONTRAST** control is highlighted.
- 4** Press the **CURSOR RIGHT** button to enter the Dynamic Contrast sub-menu.
- 5** Press the **CURSOR UP** or **DOWN** button to select one of the Dynamic Contrast options; **OFF**, **MINIMUM**, **MEDIUM**, or **MAXIMUM**.
- 6** Press the **MENU** button to remove the onscreen menu from the TV screen.

HELPFUL HINT

The Dynamic Contrast control is not available for use with the AV 3 or AV 4 Inputs.

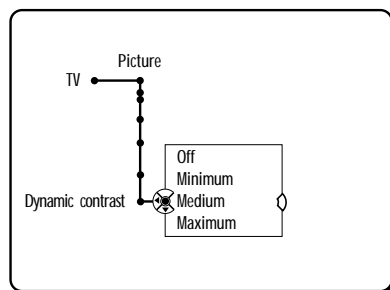
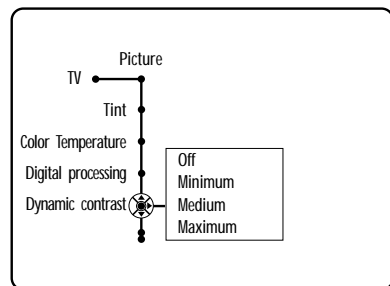
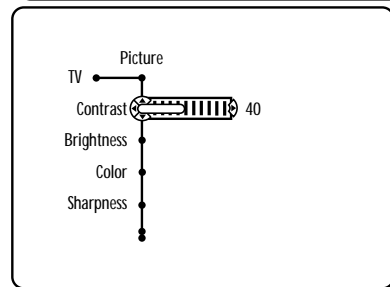
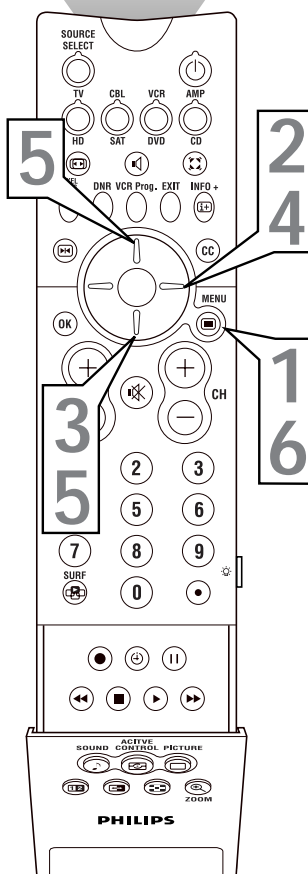
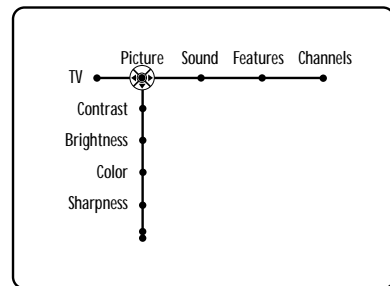
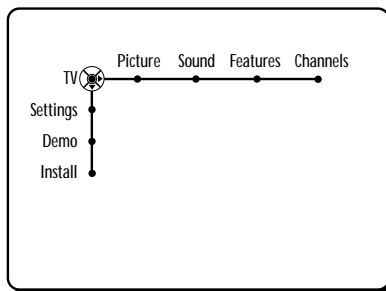

HOW TO USE THE DNR (DYNAMIC NOISE REDUCTION) CONTROL



Due to many reasons, such as poor cable reception, the picture can sometimes appear slightly "speckled" (an indication of signal noise in the picture). The DNR (Dynamic Noise Reduction) control can help eliminate this type of interference and improve the quality of the picture.

- 1** Press the **MENU** button on the remote to display the onscreen menu.
- 2** Press the **CURSOR RIGHT** button to highlight PICTURE.
- 3** Press the **CURSOR DOWN** button repeatedly until the DNR control is highlighted.
- 4** Press the **CURSOR RIGHT** button to enter the DNR sub-menu.
- 5** Press the **CURSOR UP** or **DOWN** button to select one of the DNR options; OFF, MINIMUM, MEDIUM, or MAXIMUM.
- 6** Press the **MENU** button to remove the onscreen menu from the TV screen.
- 7** The DNR Control can also be accessed by simply **pressing the DNR button** on the remote control.

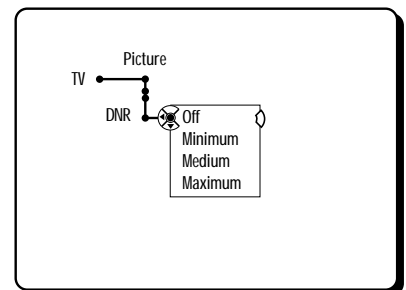
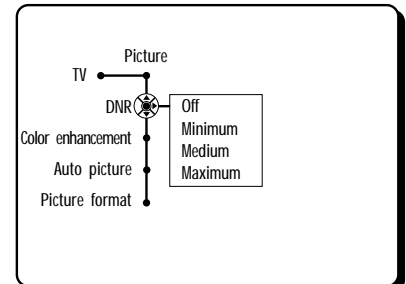
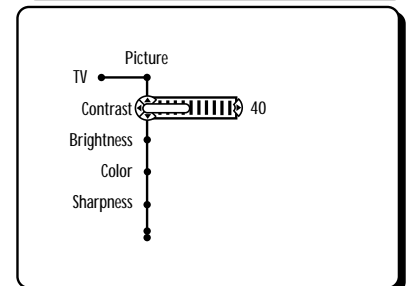
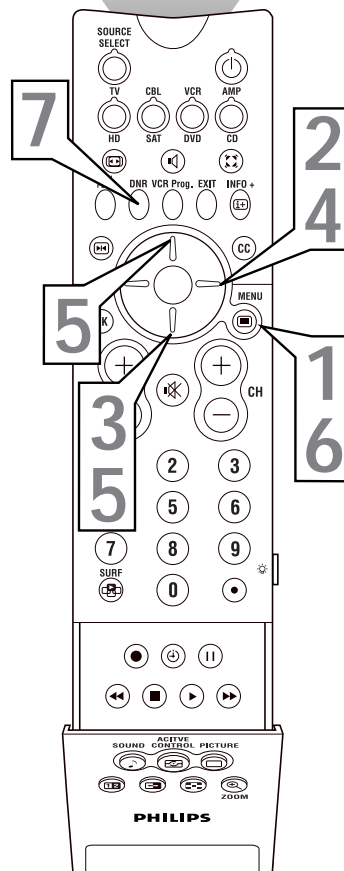
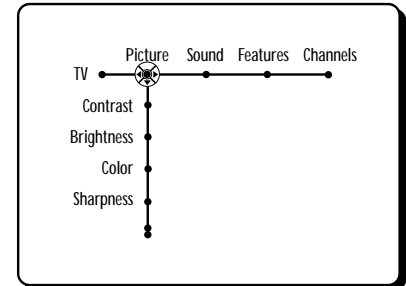
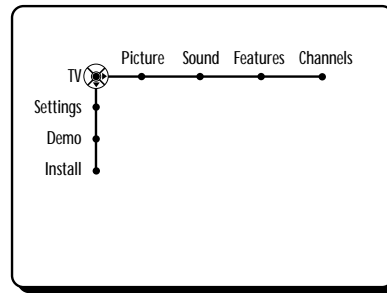



HOW TO USE THE COLOR ENHANCEMENT CONTROL

The Color Enhancement control can dramatically improve the picture quality of pictures with a high saturation of color. This control works in four ways;

Dynamic Blue Stretch corrects the white colors toward a more bluish colored white without changing the other colors. Improves the sharpness of the picture.

Green Enhancement offers a more saturated green color in case of low green broadcasts giving landscapes a fresher and brighter look.

Color Dependent Sharpness improves the sharpness of the picture through the color information. Gives the picture more details especially in red colors.

Skin-tone Correction adjusts for over saturation of red that often appears in skin-tones.

- 1 Press the **MENU** button on the remote to display the onscreen menu.
- 2 Press the **CURSOR RIGHT** button to highlight PICTURE.
- 3 Press the **CURSOR DOWN** button repeatedly until the **COLOR ENHANCEMENT** control is highlighted.
- 4 Press the **CURSOR RIGHT** button to turn the Color Enhancement control ON or OFF.
- 5 Press the **MENU** button to remove the onscreen menu from the TV screen.

HELPFUL HINT

The Color Enhancement control is not available for use with the AV 3 or AV 4 Inputs.

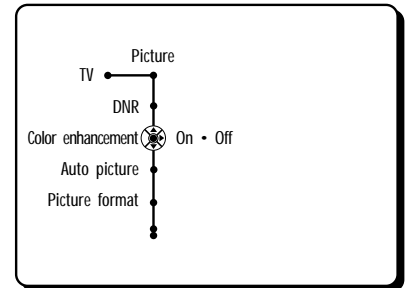
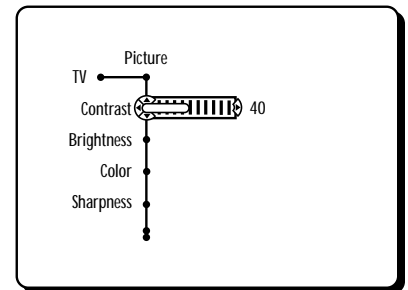
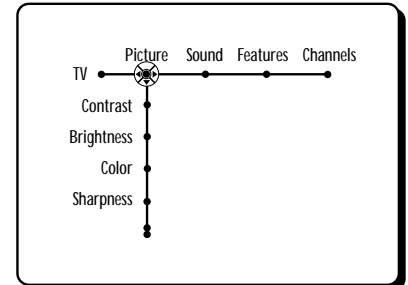
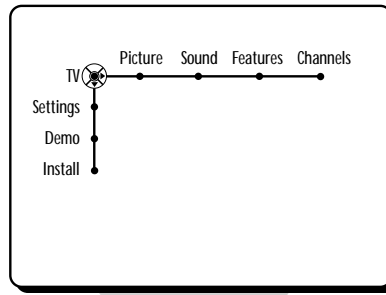

OR

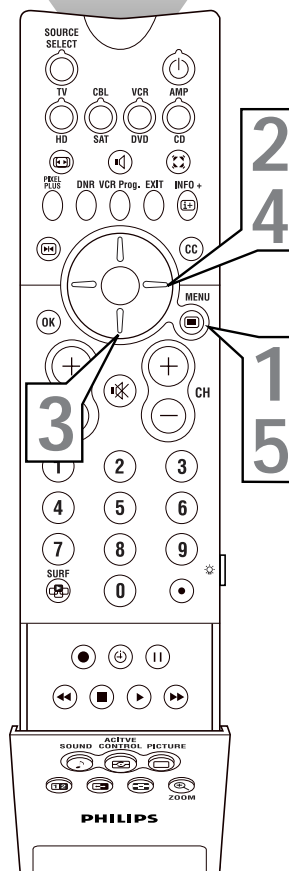
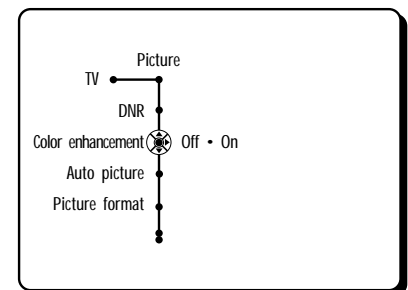

HOW TO USE THE AUTO PICTURE CONTROL



Whether you're watching a movie or a video game, your TV has automatic video control settings that will match with your current program source or content. AutoPicture™ quickly resets your TV's video controls for a number of different types of programs and viewing conditions that you may have in your home. The Personal AutoPicture™ settings are the same as the PICTURE control adjustments made within the onscreen menu.

1 Press the **PICTURE** button on the remote control. The Auto Picture menu will appear on the TV screen.

2 Press the **CURSOR DOWN** button repeatedly to select either PERSONAL, RICH, NATURAL, SOFT, MULTIMEDIA or ECO picture settings.

After your selection is made the onscreen menu will disappear from the TV screen within a couple of seconds.

NOTE: The PERSONAL setting and the PICTURE options within the onscreen menu are the same. This is the only option in AutoPicture™ that can be changed. To adjust these settings, use the PICTURE options within the onscreen menu. All other settings are set up at the factory during production and cannot be adjusted.

HELPFUL HINT

PERSONAL – picture settings are based on your personal choice or viewer control preferences.

RICH – emphasizes very vibrant colors. (Good choice for AV mode used in a brightly lit room.)

NATURAL – sets picture controls at mid-level settings for consistent viewing conditions.

SOFT – emphasizes warm colors. (Good choice for dimly lit room. Gives a cinematic effect when the light is switched off.)

Note: Can also be used with Pixel Plus control (see page 17) to soften the appearance of harsh video replay screen elements that can show with certain types of DVD playback conditions.

MULTIMEDIA – emphasizes soft colors. (Good choice for playing computer games, etc.)

ECO – reduces Brightness and Contrast settings to low levels as a power consumption saving measure.

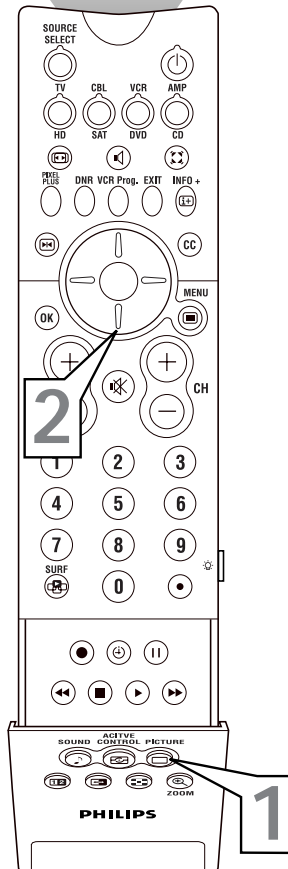
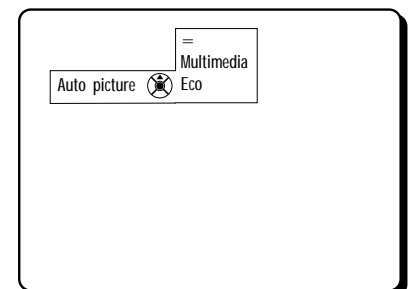
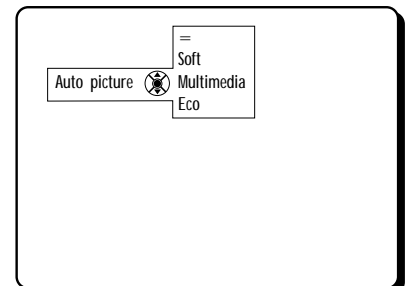
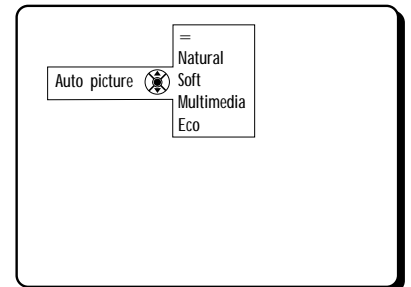
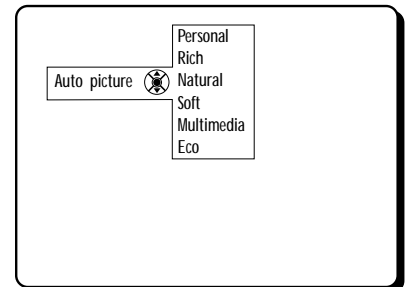
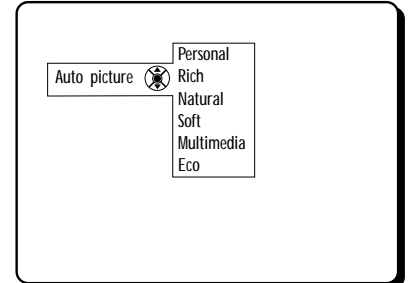
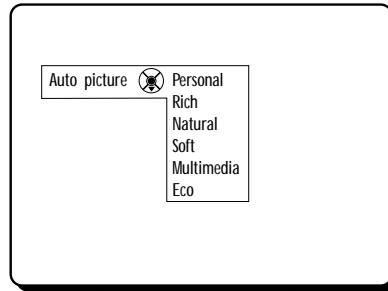



HOW TO USE THE PICTURE FORMAT CONTROL

You can change the screen format size to match the type of program you're watching. Select the normal 4:3 aspect ratio or a variety for wide screen formats.

- 1** Press the **MENU** button on the remote to display the onscreen menu.
- 2** Press the **CURSOR RIGHT** button to highlight PICTURE.
- 3** Press the **CURSOR DOWN** button repeatedly until the Picture Format control is highlighted.
- 4** Press the **CURSOR RIGHT** button to enter the Picture Format sub-menu options.
- 5** Press the **CURSOR DOWN** button to select one of the seven screen formats. Choose from Automatic, Super Zoom, 4:3, Movie Expand 4:3, Movie Expand 16:9, 16:9 Subtitle, or Wide Screen.
- 6** Press the **MENU** button to remove the onscreen menu from the TV screen.
- 7** Note: The Picture format onscreen menu can also be entered by pressing the Picture Format button on the remote control.

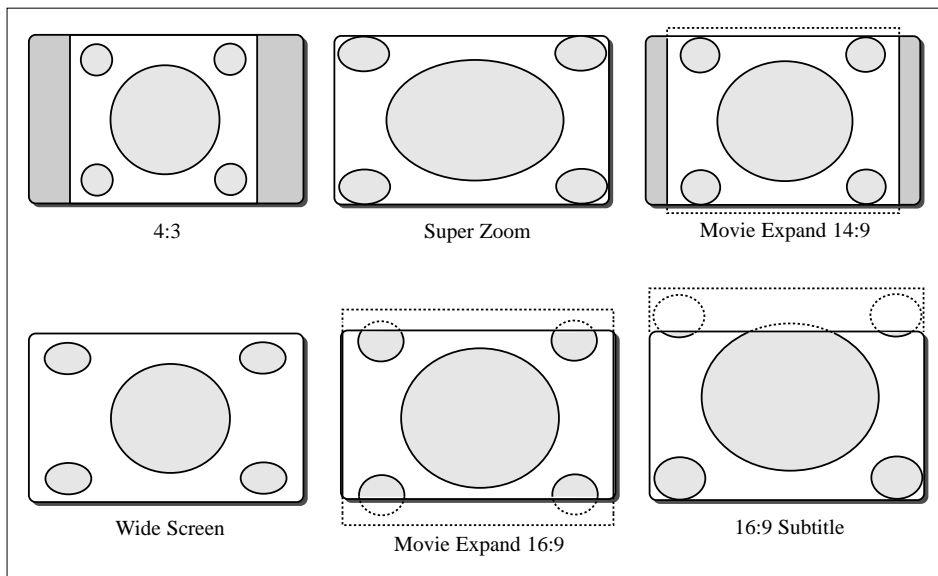
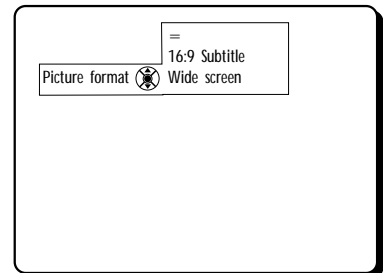
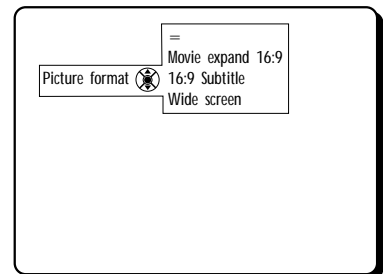
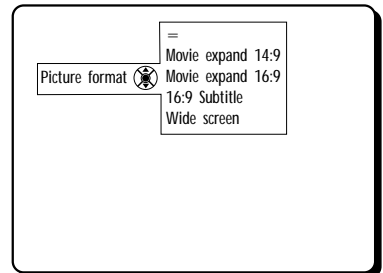
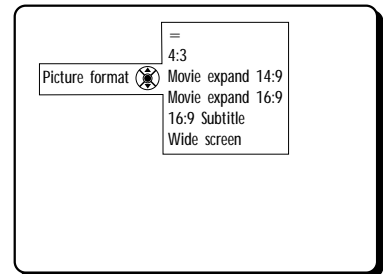
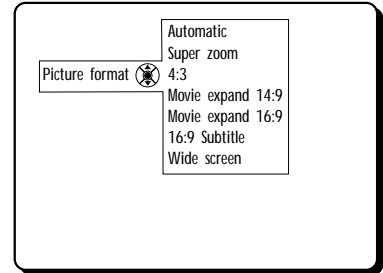
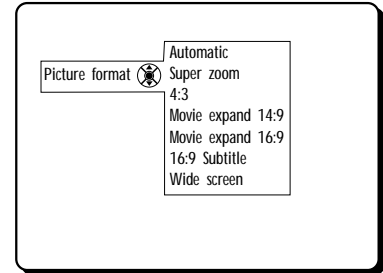
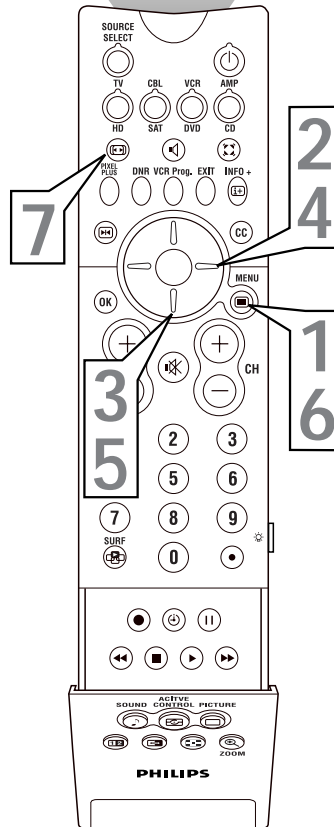
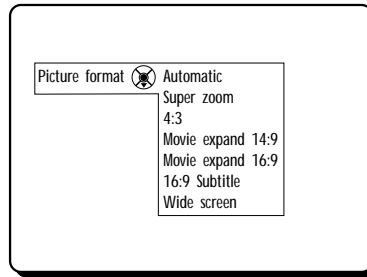

ADJUSTING THE TV VOLUME AND THE HEADPHONE VOLUME



Besides the normal volume level control, your TV also has a headphone volume control. This control can be adjusted when using headphones without having to adjust the main volume control for the TV cabinet speakers.

To control the television volume:

- 1 Press the **VOL +** button on the remote control to increase the television volume level.
- 2 Press the **VOL -** button on the remote control to decrease the television volume level.

Note: The Volume level can also be adjusted within the onscreen menu. Select the Sound menu and cursor down to the Volume control. Use the Cursor Left and Right to adjust.

To control the Headphone volume:

- 3 Press the **MENU** button on the remote control to display the onscreen menu.
- 4 Press the **CURSOR RIGHT** button to highlight **SOUND**.
- 5 Press the **CURSOR DOWN** button repeatedly until the Headphone Volume control is highlighted.
- 6 Press the **CURSOR RIGHT** button to increase the volume level being heard through the headphones.
- 7 Press the **CURSOR LEFT** button to decrease the volume level being heard through the headphones.
- 8 Press the **MENU** button on the remote control to remove the onscreen menu from the TV screen.

TELEVISION VOLUME

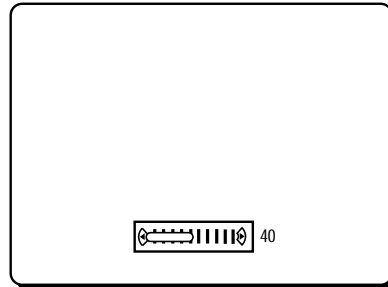

HEADPHONE VOLUME

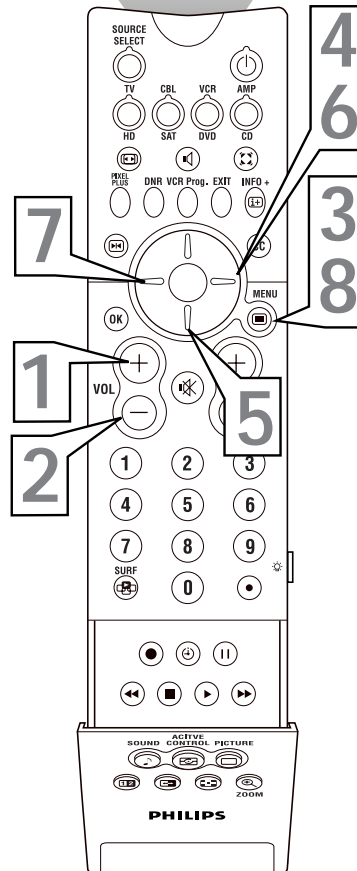
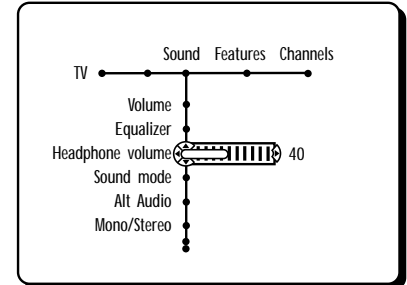
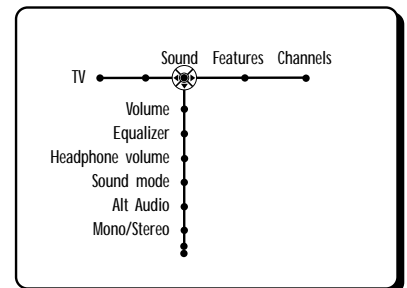
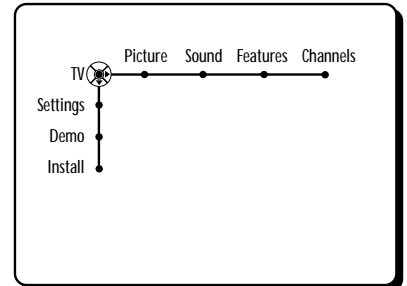



USING THE TV EQUALIZER CONTROL

You can change the dynamics of the sound being heard through the TV by using the Equalizer control. The Equalizer control contains slider controls to adjust or change only the Personal settings. If any of the other factory pre-defined settings are changed, they will become the new Personal settings.

- 1** Press the **MENU** button on the remote to display the onscreen menu.
- 2** Press the **CURSOR RIGHT** button repeatedly to highlight **SOUND**.
- 3** Press the **CURSOR DOWN** button repeatedly until the Equalizer control is highlighted.
- 4** Press the **CURSOR RIGHT** button to enter the Equalizer sub-menu options. Continue to press the **CURSOR RIGHT** to select one of the options; Personal, Speech, Music, Movie, or Multimedia.
- 5** The Personal setting can be changed. Once an option has been chosen, **press the CURSOR DOWN button** to highlight one of the settings.
- 6** Press the **CURSOR LEFT** or **RIGHT** button to adjust the slider control to the desired position.

Note: Even if an option other than Personal has been chosen, changing any of the values will default it to the new Personal setting.

- 7** Press the **MENU** button when finished to remove the onscreen menu from the TV screen.

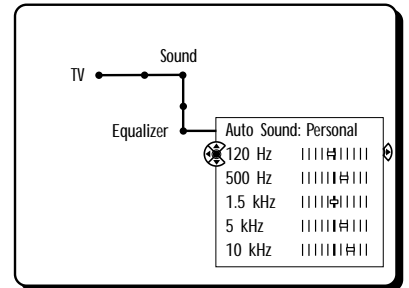
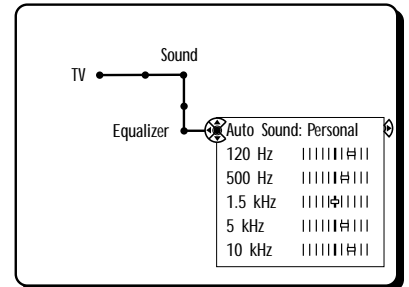
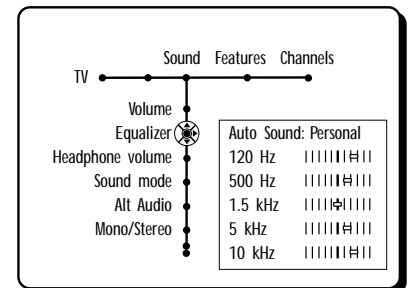
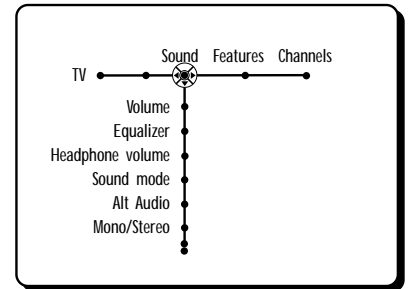
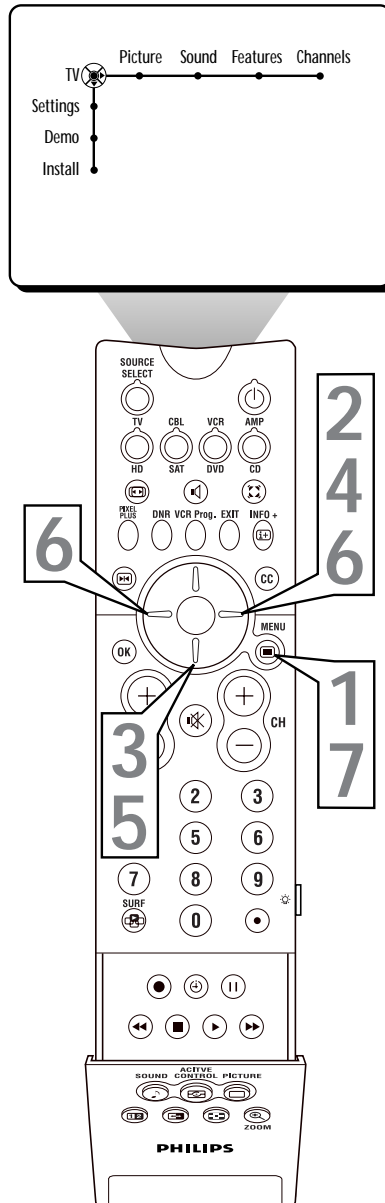

HOW TO USE THE SOUND MODE CONTROL



The Sound Mode control allows you to place the TV sound into one of five modes; Stereo, 3 Stereo, 3D Surround, Hall, or Pro Logic.

The following instructions show how to place the TV into one of these sound modes.

- 1** Press the **MENU** button on the remote to display the onscreen menu.
- 2** Press the **CURSOR RIGHT** button repeatedly to highlight **SOUND**.
- 3** Press the **CURSOR DOWN** button repeatedly until the Sound Mode control is highlighted.
- 4** Press the **CURSOR RIGHT** button to enter the Sound Mode sub-menu options.
- 5** Press the **CURSOR DOWN** button to select one of the five options; Stereo, 3 Stereo, 3D Surround, Hall, or Pro Logic.

Stereo - Reproduces only left and right front speaker sound. If you are receiving a stereo broadcast, you will hear left and right channel stereo sound.

3 Stereo - Gives stereo sound through the left, right, and center front speakers.

3D Surround - Gives the experience of Dolby Surround Pro Logic without having rear speakers connected or activated.

Hall - Creates a "Hall" effect through the TV left, right, and rear speakers. Will add simulated surround sound to any broadcast which is not encoded with Dolby Surround, or to a mono signal broadcast.

Pro Logic - For broadcasts encoded with Dolby Surround, the left, right center and rear speakers will reproduce the Dolby Surround Pro Logic audio.

- 6** Press the **MENU** button when finished to remove the onscreen menu from the TV screen.

- 7** Pressing the **SOUND MODE** button on the remote control will display a simplified menu for selecting the proper sound mode.

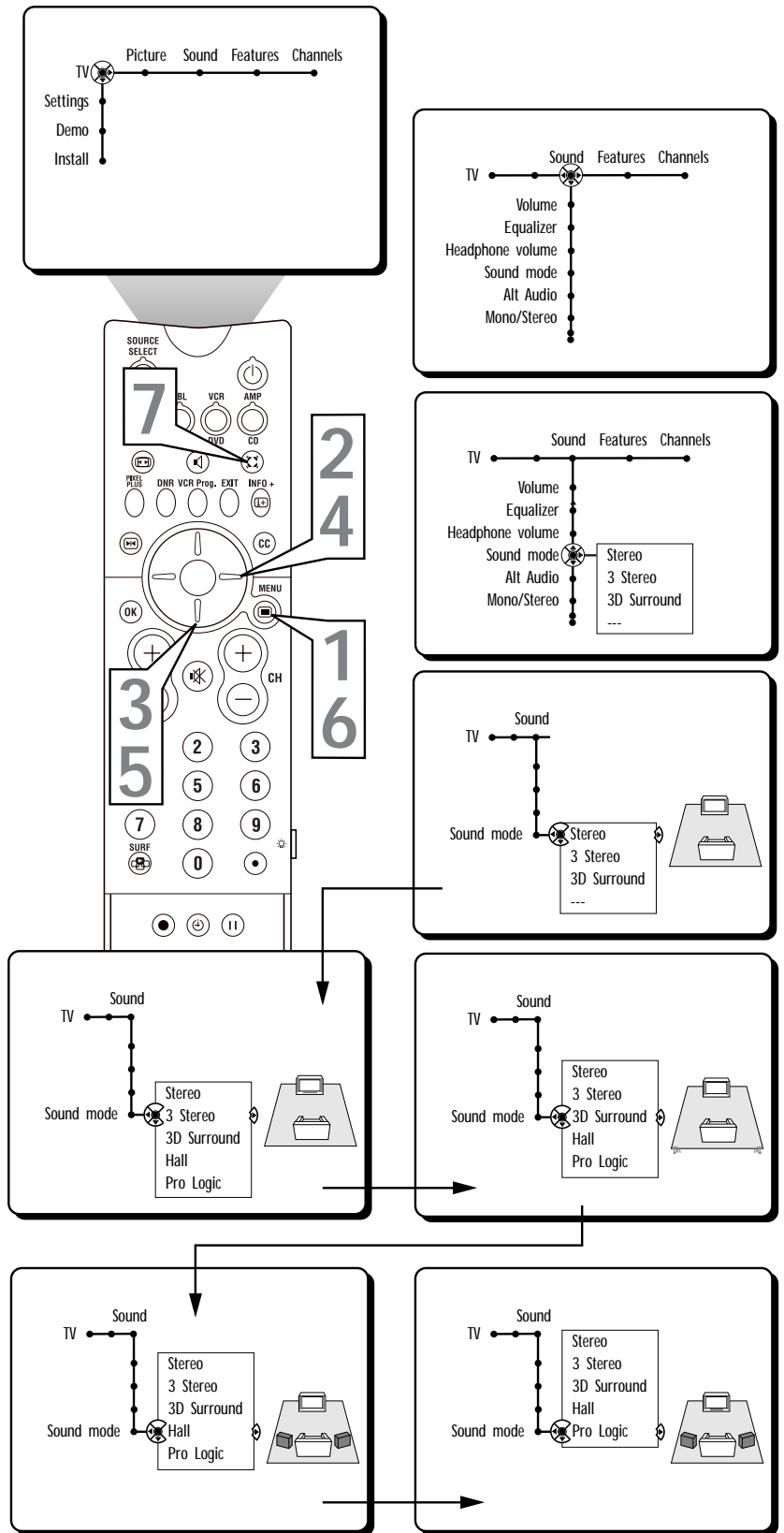

*Manufactured under license from Dolby Laboratories. "Dolby", "Pro Logic", and the double-D symbol are trademarks of Dolby Laboratories.



HOW TO USE THE ALTERNATE AUDIO CONTROL (SAP)

For broadcasts that contain SAP (Secondary Audio Program) information the Alt Audio Control can be set to ON. SAP is an additional part of the stereo broadcast system. Sent as a third audio channel, SAP can be heard apart from the current TV program sound. TV stations are free to use SAP for any number of purposes.

If a SAP signal is not present with a selected program, the Alt Audio option cannot be selected and will appear grayed out in the onscreen menu.

If SAP is available on the tuned channel:

- 1 Press the **MENU** button on the remote to display the onscreen menu.
- 2 Press the **CURSOR RIGHT** button repeatedly to highlight **SOUND**.
- 3 Press the **CURSOR DOWN** button repeatedly until the Alt Audio control is highlighted.
- 4 Press the **CURSOR RIGHT** button to toggle and select either Main or SAP.
- 5 Press the **MENU** button when finished to remove the onscreen menu from the TV screen.

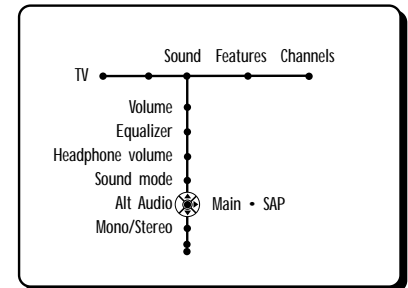
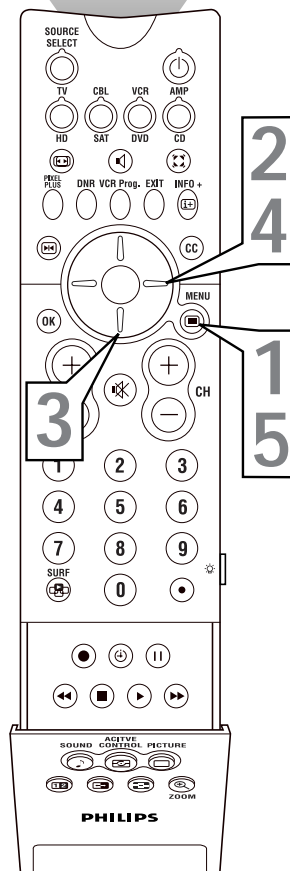
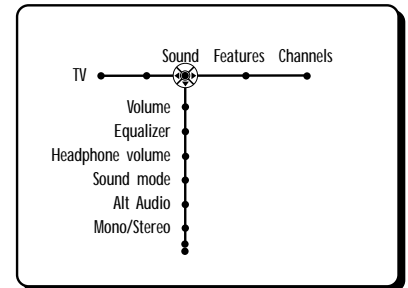
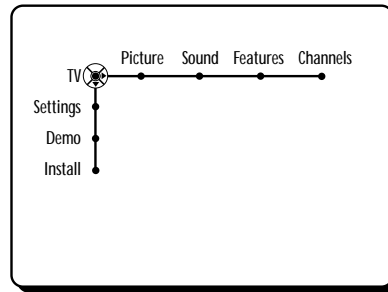

OR

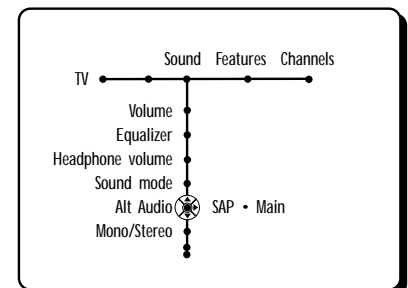

HOW TO SET THE TV FOR STEREO PROGRAMMING



You can receive broadcast stereo TV programs. The TV has both an amplifier and twin speakers through which the stereo sound can be heard.

- 1 Press the MENU button** on the remote to display the onscreen menu.
- 2 Press the CURSOR RIGHT button** repeatedly to highlight SOUND.
- 3 Press the CURSOR DOWN button** repeatedly until the Mono/Stereo control is highlighted.
- 4 Press the CURSOR RIGHT button** to toggle and select either Mono or Stereo.

Note: If the signal being received is in mono, it can not be set to Stereo. However, if the signal being received is in Stereo, the TV can be placed in the Mono mode. (If set to the Mono control position, remember to return the Mono/Stereo Control back to Stereo when using the TV with stereo programming.)

- 5 Press the MENU button** when finished to remove the onscreen menu from the TV screen.

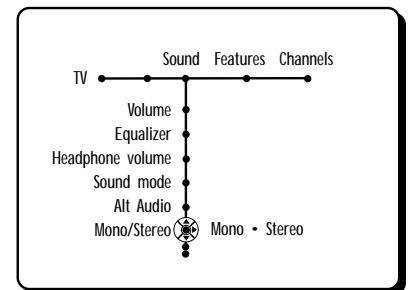
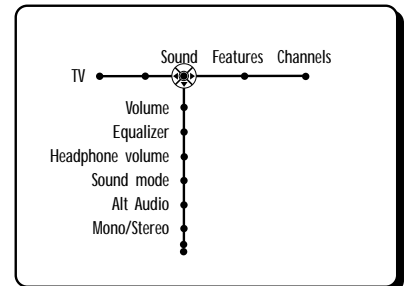
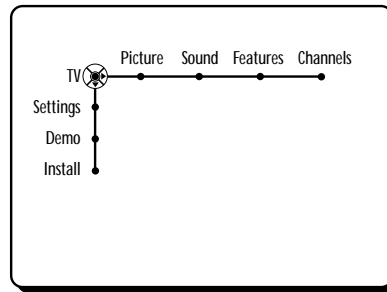
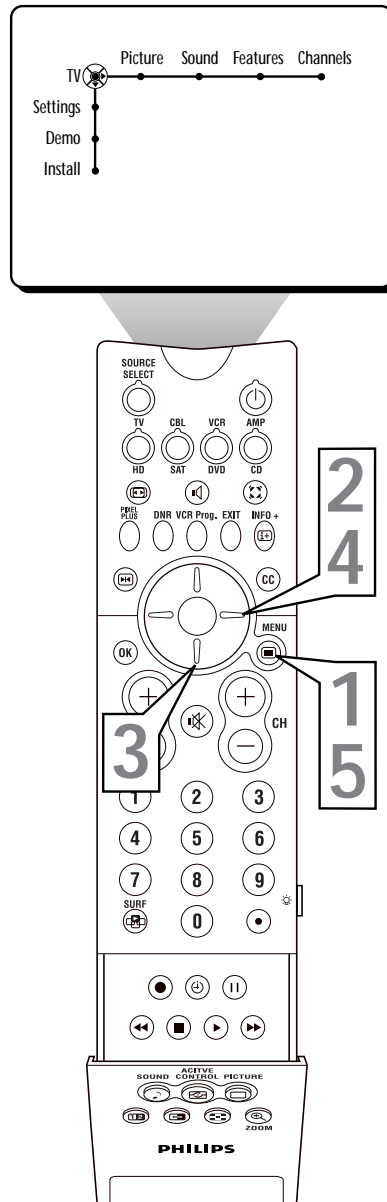

OR

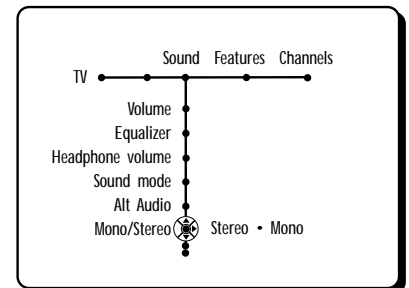



HOW TO USE THE 3D SURROUND EFFECT CONTROL

The 3D Surround Effect Control helps to widen the effect being heard through the television speakers. This control is only available if the television has been placed in the 3D Surround mode.

- 1** Press the **MENU** button on the remote to display the onscreen menu.
- 2** Press the **CURSOR RIGHT** button repeatedly to highlight **SOUND**.
- 3** Press the **CURSOR DOWN** button repeatedly until the 3D Surround Effect control is highlighted.
- 4** Press the **CURSOR RIGHT** button to increase the surround effect. Choose a value of 0, 33, 66, or 100.
- 5** Press the **MENU** button when finished to remove the onscreen menu from the TV screen.

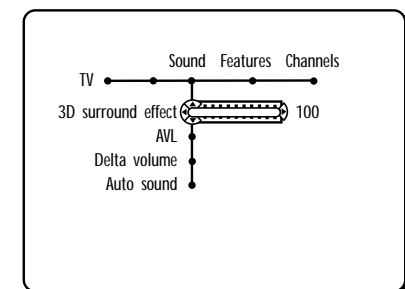
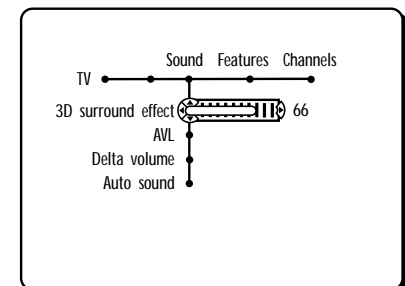
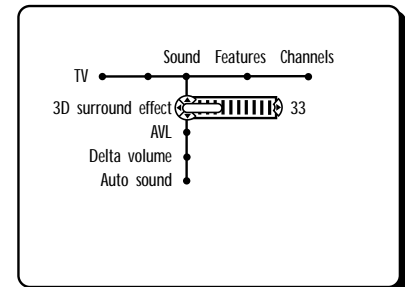
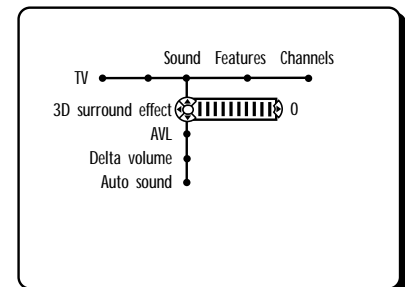
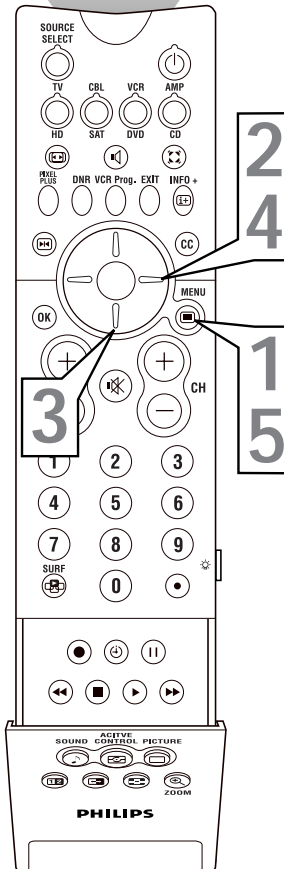
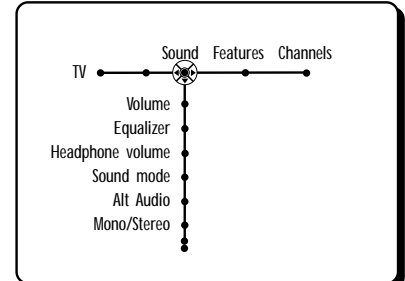
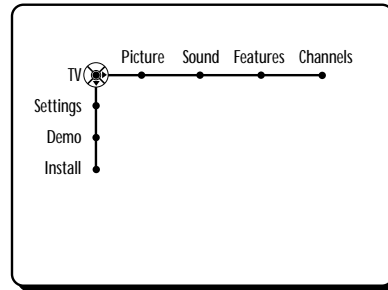

HOW TO USE THE AVL CONTROL



In most cases, the volume levels coming from broadcast programming or commercials are never the same. With the AVL (Audio Volume Leveler) control turned ON, you can have the TV level out sound that is being heard. This makes for a more consistent sound by reducing the peaks and valleys that occur during program changes or commercial breaks. To turn the AVL ON, follow these steps.

- 1** Press the **MENU** button on the remote control to display the onscreen menu.
- 2** Press the **CURSOR RIGHT** button repeatedly to highlight **SOUND**.
- 3** Press the **CURSOR DOWN** button repeatedly until **AVL** is highlighted.
- 4** Press the **CURSOR RIGHT** button to toggle the control ON or OFF.
- 5** Press the **MENU** button to remove the menu from the screen.

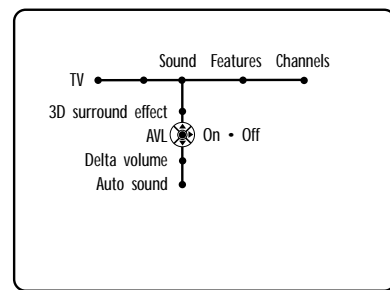
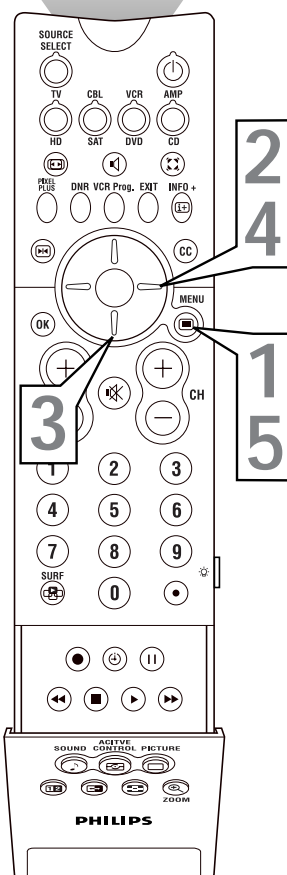
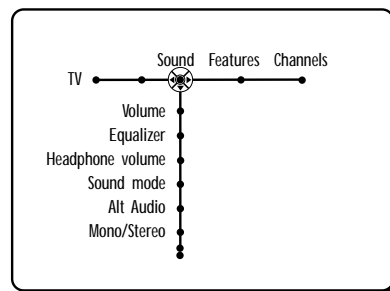
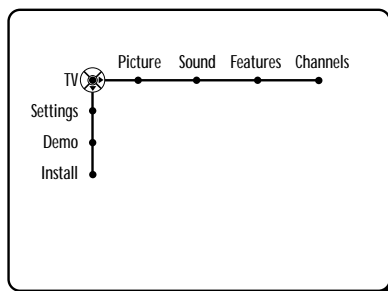

OR

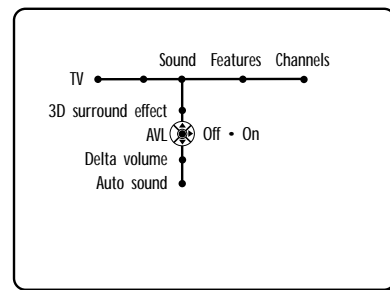



HOW TO USE THE DELTA VOLUME CONTROL

The volume level coming from channel to channel and broadcast to broadcast can vary widely. The Delta Volume Control will allow the volume to be increased for channels with weaker audio signals while allowing other channels with stronger signals to be reduced some. When the Delta Volume Control is adjusted or changed, it will only effect the currently tuned channel. The TV will store the setting for that channel within its memory and remember it when the channel is tuned again.

- 1** Press the **CH + or -** button on the remote control to tune a specific channel.
- 2** Press the **MENU** button on the remote control to show the onscreen menu.
- 3** Press the **CURSOR RIGHT** button once to highlight **SOUND**.
- 4** Press the **CURSOR DOWN** button repeatedly until Delta Volume is highlighted.
- 5** Press the **CURSOR LEFT** button to decrease the overall volume, or **press CURSOR RIGHT** button to increase the overall volume for the tuned channel.

Repeat steps for other channels you wish to adjust the Delta Volume.

- 6** Press the **MENU** button to remove the onscreen menu from the TV screen.

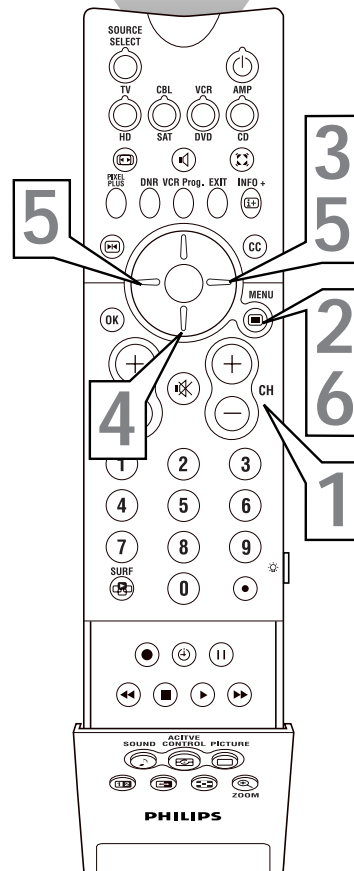
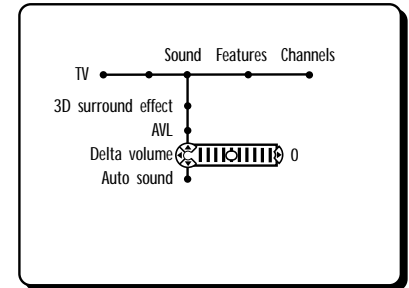
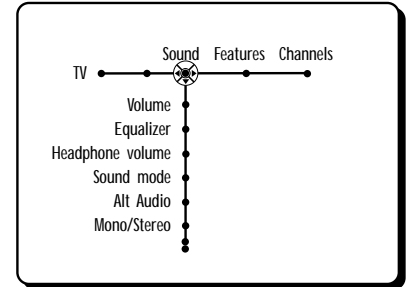
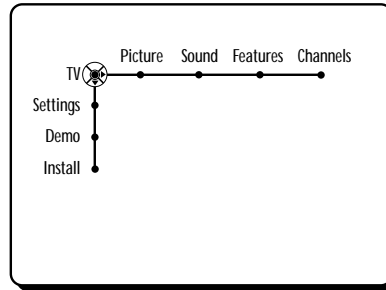

HOW TO USE THE AUTO SOUND CONTROL



AutoSound™ allows you to select from four factory-set controls and a personal control that you set according to your own preferences through the onscreen Sound menu. The four factory-set controls (Speech, Music, Movie, or Multimedia) enable you to tailor the TV sound so as to enhance the particular program you are watching. Follow these steps to select any of the options.

- 1 Press the SOUND button** on the remote control.
- 2 Press the CURSOR DOWN button repeatedly** to toggle down the options: Personal, Speech, Music, Movie, or Multimedia.

Once your selection has been made, the onscreen menu will disappear from the TV screen within few seconds.

The Auto Sound options can also be selected through the SOUND menu options within the onscreen menu.

CHECK IT OUT

PERSONAL – presents the TV's sound according to the settings you make within the sound menu.

SPEECH – brings voices to the forefront and emphasizes them. Moves music to the background.

MUSIC – emphasizes music over voices.

MOVIE – provides a balance between voices and music.

MULTIMEDIA – provides sound balance best suited for gaming consoles, or interactive media.

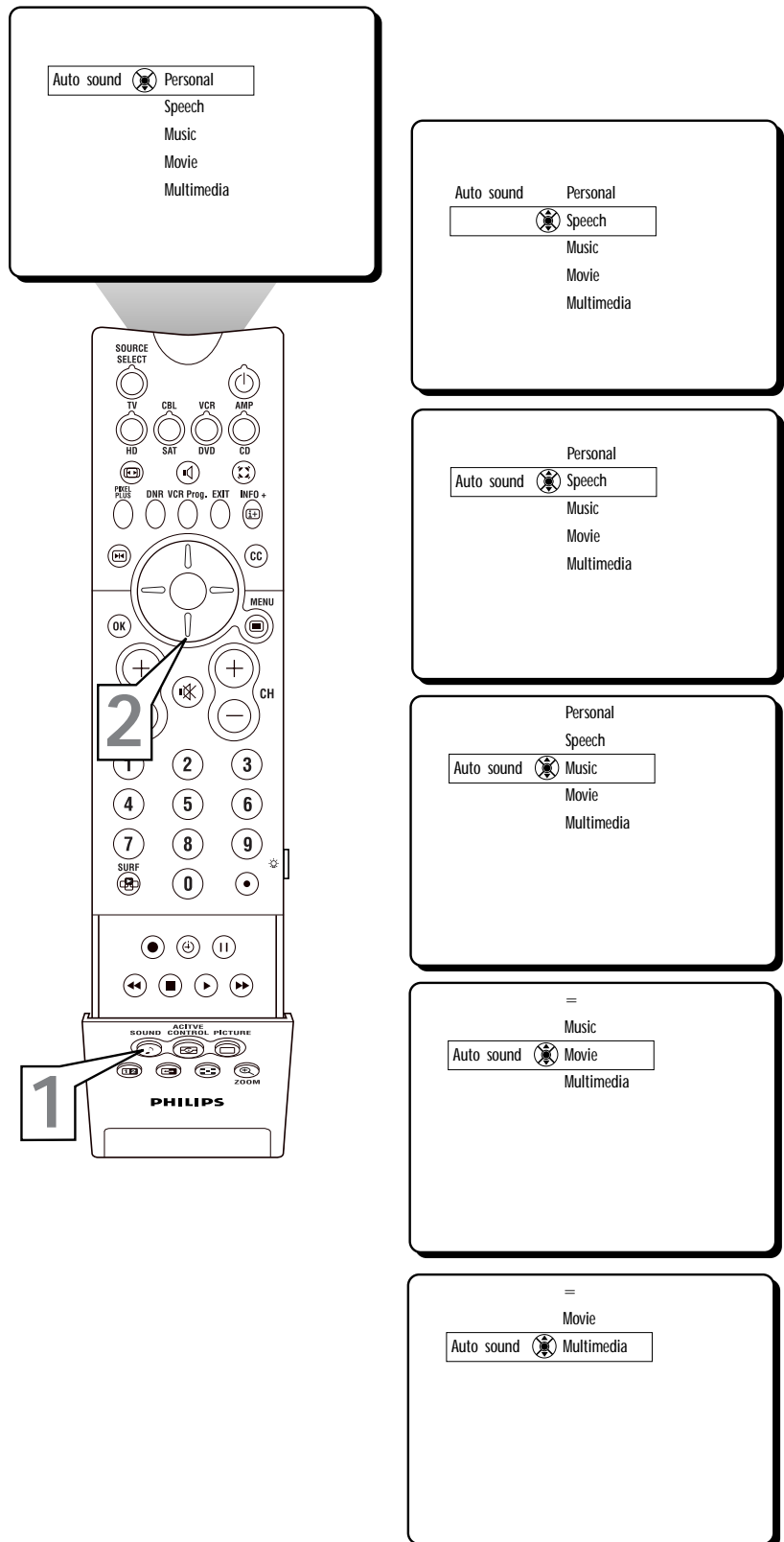



HOW TO USE THE CLOSED CAPTIONING CONTROL

Closed Captioning (CC) allows you to read the voice content of television programs on the TV screen. Designed to help the hearing impaired, this feature uses onscreen "text boxes" to show dialogue and conversations while the TV program is in progress.

Follow steps 1 through 7 to select a Closed Caption option:

- 1** Press the **MENU** button on the remote control to display the onscreen menu.
- 2** Press the **CURSOR DOWN** button repeatedly to highlight **SETTINGS**.
- 3** Press the **CURSOR RIGHT** button repeatedly to highlight **General**.
- 4** Press the **CURSOR DOWN** button repeatedly to highlight **Caption Service**.
- 5** Press the **CURSOR RIGHT** button to enter the Closed Captions sub-menu.
- 6** Press the **CURSOR UP** or **DOWN** button to highlight one of the caption modes: CC-1, CC-2, CC-3, CC-4, T-1, T-2, T-3, or T-4.

Note: Text Modes (T1-T4) appear onscreen as boxes and may block portions of the TV screen.

- 7** Press the **MENU** button to remove the onscreen menu from the TV screen.

Follow steps 8 through 13 to turn the Closed Captions Control ON or OFF.

- 8** Press the **CC** button on the remote control.
- 9** Press the **CURSOR UP** or **DOWN** button repeatedly to select **OFF**, **ON**, or **ON with Mute**.
OFF - Closed Captioning service will not be displayed on the TV screen.
ON - Closed Captioning information (if available) will display on the TV screen.
ON with Mute - Closed Captioning information will turn On only when the MUTE button is pressed. Turns the closed captioning information OFF when the TV volume is restored.

- 10** Press the **MENU** button on the remote to remove the onscreen display from the TV screen.

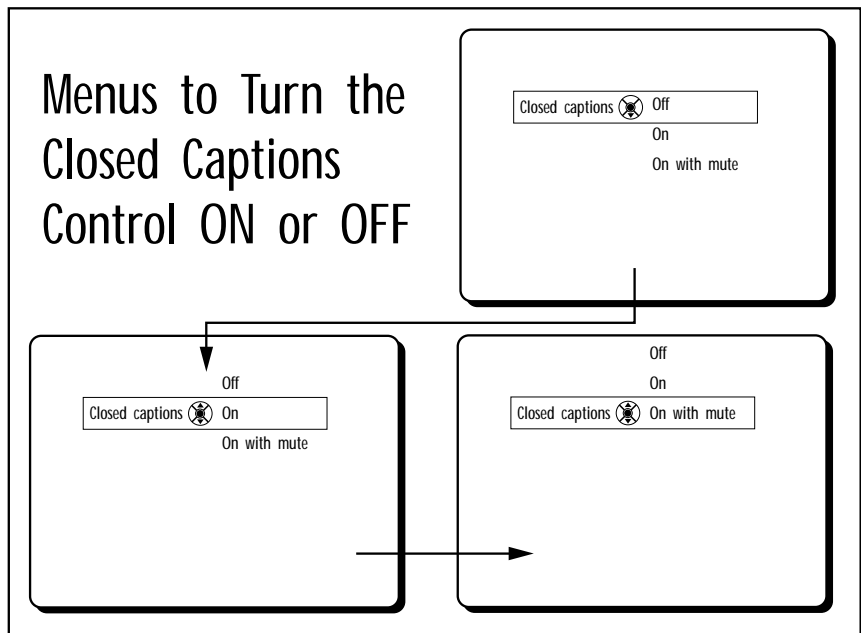
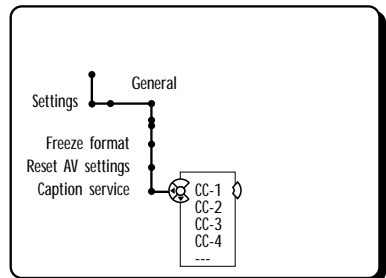
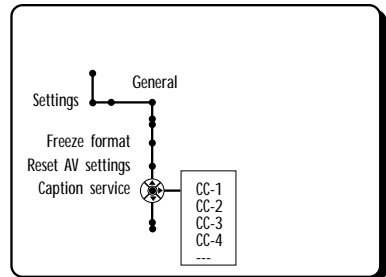
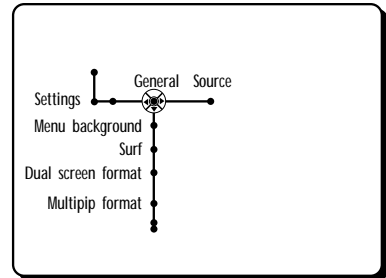
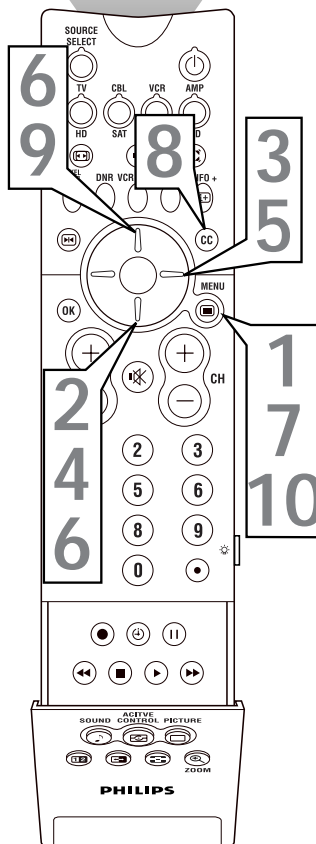
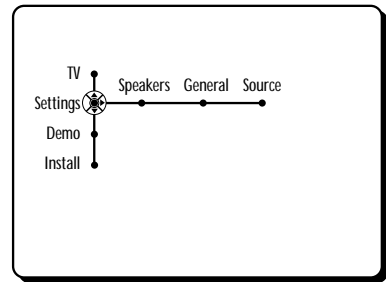
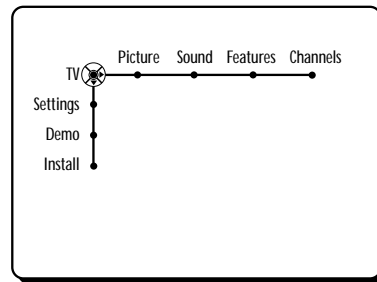

HOW TO SET THE SLEEP TIMER CONTROL



Have you ever fallen asleep in front of the TV, only to have it wake you up at two in the morning with a test pattern sound screeching in your ears? Well, your TV can enable you to avoid that discomfort by automatically turning itself off. With the Sleptimer control, you can set a timer to automatically switch the TV OFF after a period of time you choose (5-minutes up to 180 minutes in 5-minute increments).

- 1** Press the **MENU** button on the remote control to display the onscreen menu.
- 2** Press the **CURSOR RIGHT** button repeatedly until **FEATURES** is highlighted.
- 3** Press the **CURSOR DOWN** button repeatedly to highlight **Sleptimer**.
- 4** Press the **CURSOR RIGHT** button to set the Sleptimer in 5-minute increments starting at 5-minutes up to 180-minutes.
- 5** Press the **MENU** button to remove the onscreen menu from the TV screen.

An onscreen countdown will appear during the last minute before the TV shuts itself off. At this time you may cancel the sleptimer setting by pressing the **OK** button on the remote control.

HELPFUL HINT

To see how many minutes remain before the TV shuts itself off, press the **INFO+** button. A Sleep Timer setting can be cancelled by pressing the **OK** button during the last minute of the operation.

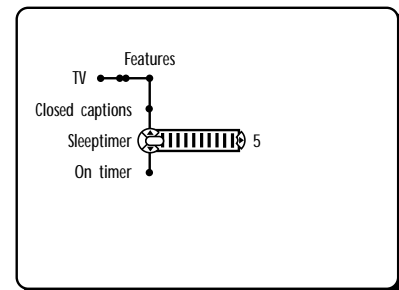
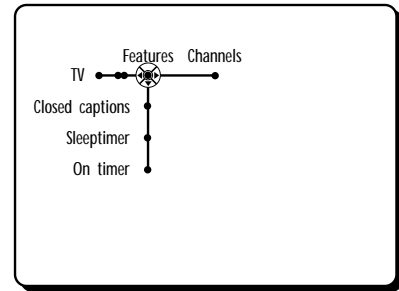
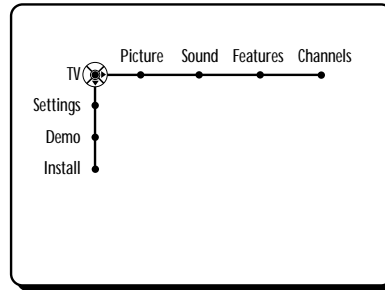
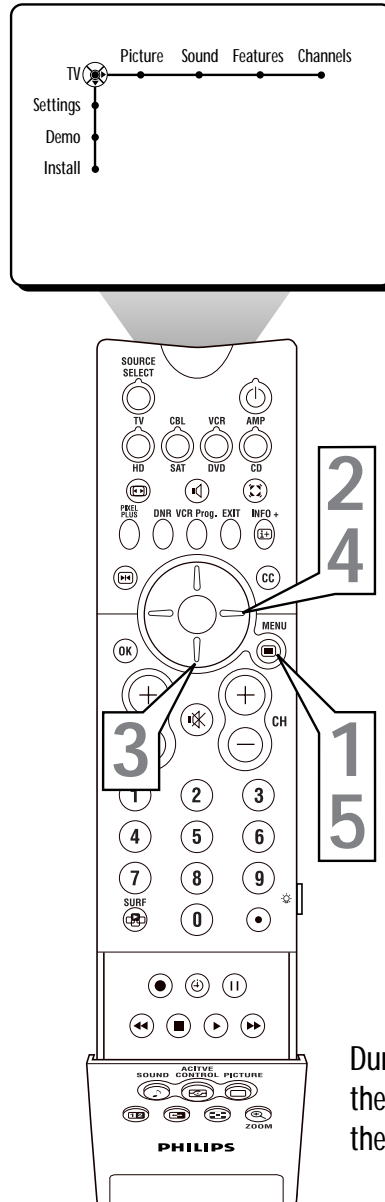

Up To

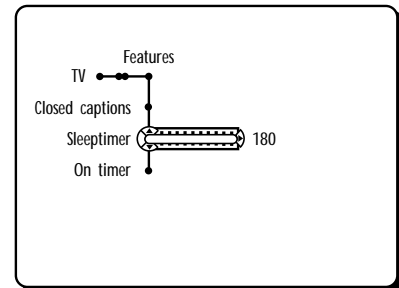

During the last minute of a Sleptimer setting the TV will display a countdown screen where the setting can be cancelled

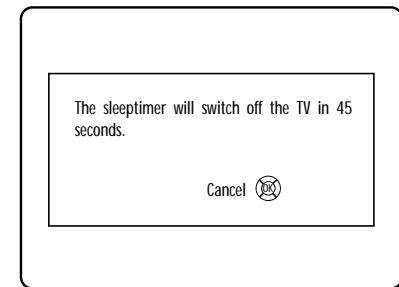



HOW TO USE THE ON-TIMER CONTROL

The On-Timer Control allows you to set a time to power the TV on automatically at a certain time of day. The On-Timer can be set to work once, or daily at the same time.

- 1 Press the **MENU** button on the remote control to display the onscreen menu.
- 2 Press the **CURSOR RIGHT** button repeatedly to highlight FEATURES.
- 3 Press the **CURSOR DOWN** button repeatedly to highlight the On Timer control.
- 4 Press the **CURSOR RIGHT** button to enter the sub-menu.
- 5 Press the **CURSOR UP** or **DOWN** button to select ON.
- 6 Press the **CURSOR RIGHT** button to shift the menu to the start channel sub-menu.
- 7 Press the **CURSOR UP** or **CURSOR DOWN** button to select the channel you would like the TV to tune to when it turns on.
- 8 Press the **CURSOR RIGHT** button to shift the menu to the Day/Daily sub-menu.
- 9 Press the **CURSOR UP** or **DOWN** button to select the day to turn on or select Daily.
- 10 Press the **CURSOR RIGHT** button to enter the AM/PM sub-menu.
- 11 Press the **CURSOR UP** or **DOWN** button to select AM or PM.
- 12 Press the **CURSOR RIGHT** button to enter the start time.
- 13 Press the **NUMBERED** buttons to enter the time. Use 0 first if entering a signal digit. (i.e.; 0, 1, 3, 0 for 1:30)
- 14 Press the **OK** button to confirm.
- 15 Press the **MENU** button to remove the onscreen menu from the TV screen.

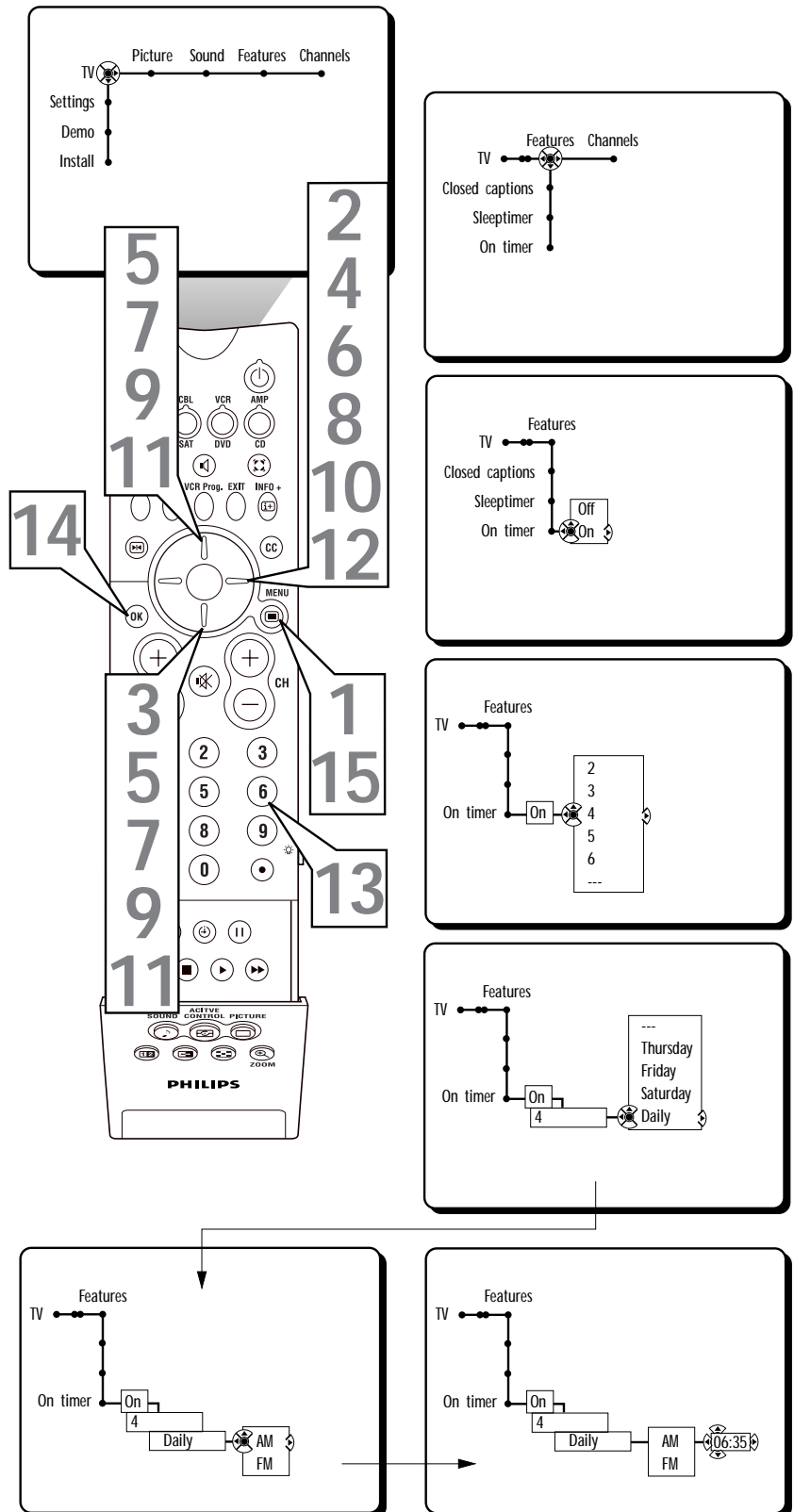

HELPFUL HINT

Remember, be sure to press 0 first and then the hour number for single-digit entries.

HOW TO USE THE CHANNEL LIST CONTROL



The Channel List Control shows all the available channels that the Auto Programming placed in the TV memory. The channels can be selected from this list.

- 1 Press the MENU button** on the remote control to display the onscreen menu.
- 2 Press the CURSOR RIGHT button** repeatedly to highlight CHANNELS.
- 3 Press the CURSOR DOWN button** to highlight the Channel List control.
- 4 Press the CURSOR RIGHT button** to enter the Channel List sub-menu.
- 5 Press the CURSOR UP or DOWN button** to highlight a specific channel from the list.
- 6 Press the OK button.** The television will tune to the highlighted channel.
- 7 Press the MENU button** to remove the onscreen menu from the TV screen.

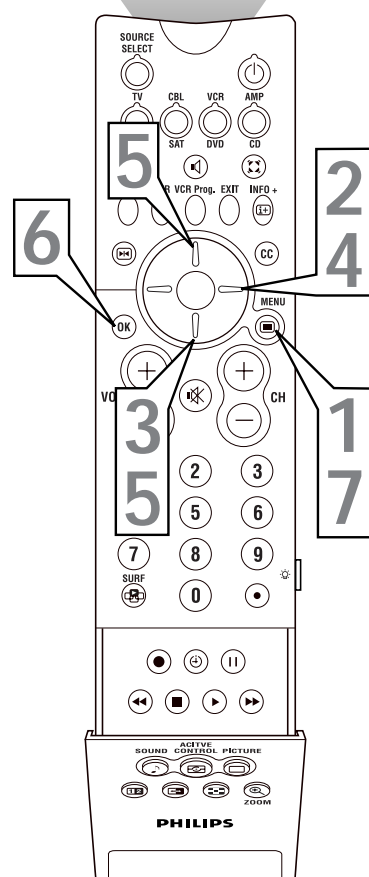
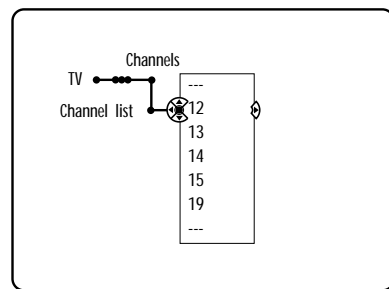
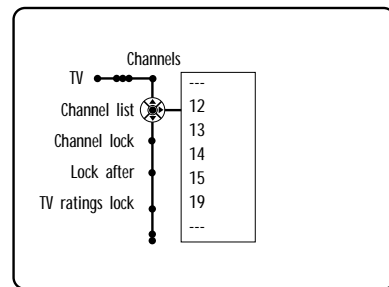
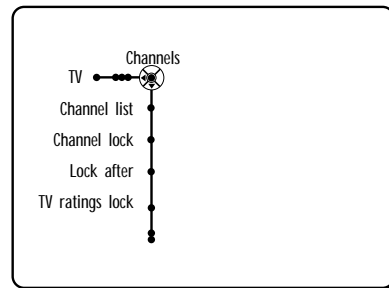
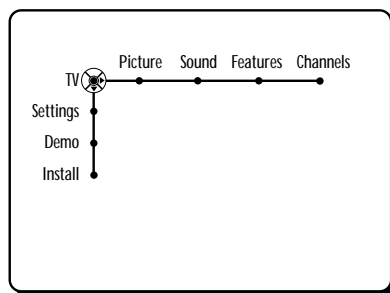



HOW TO USE THE CHANNEL LOCK CONTROL

For various reasons you might want to block the programming on a specific channel or series of channels. The Channel Lock Control will allow individual channels to be "locked", blocking the programming on that channel.

- 1** Press the **MENU** button on the remote control to display the onscreen menu.
- 2** Press the **CURSOR RIGHT** button repeatedly to highlight CHANNELS.
- 3** Press the **CURSOR DOWN** button repeatedly to highlight the Channel Lock Control.
- 4** Press the **CURSOR RIGHT** button to enter the Channel Lock sub-menu.
- 5** Press the **CURSOR UP** or **DOWN** button to highlight a specific channel from the list.
- 6** Press the **OK** button. The "dot" in front of the channel number will change to yellow showing that the channel is locked.

Repeat steps 5 and 6 for other channels you wish to lock.

- 7** Press the **MENU** button to remove the onscreen menu from the TV screen.

Note: To unlock a locked channel, enter your personal PIN number to clear the channel from being blocked. Please refer to page 51 for instructions on setting up a PIN (Personal Identification Number).

HELPFUL HINT

If you tune to a channel that is locked and you enter your PIN to unlock the channel, ALL locked channels will be unlocked until the television is shut off. When the television is turned back on again, previously locked channels will be locked again.

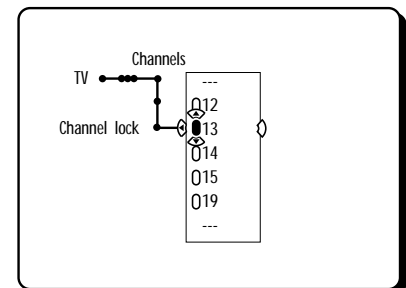
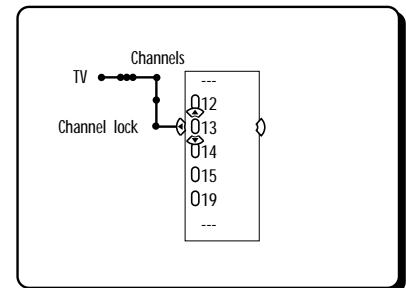
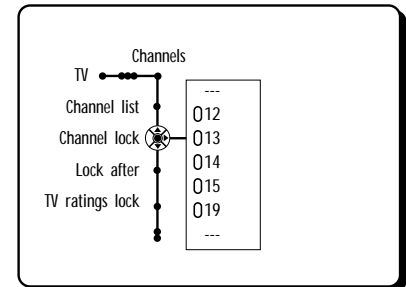
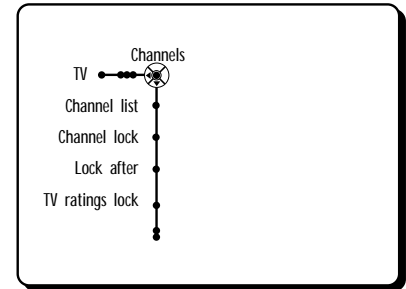
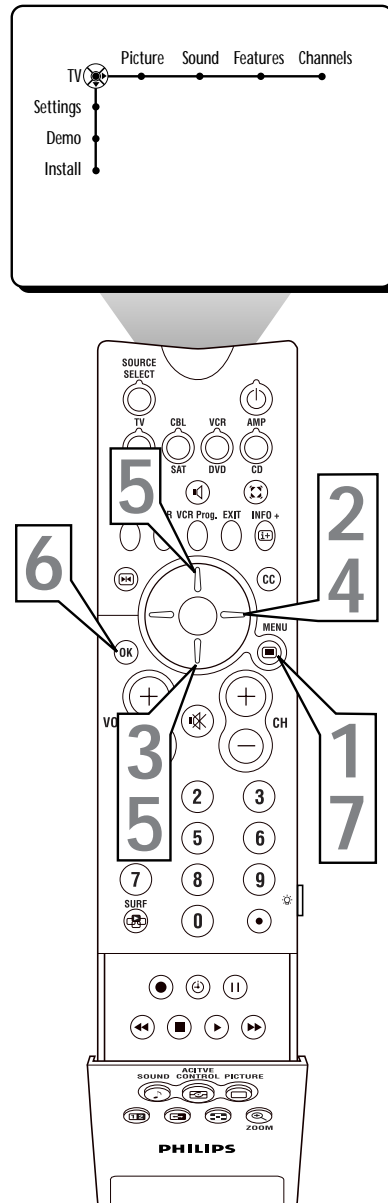

This screen will appear when tuned to a locked channel. To view the channel, enter your PIN.

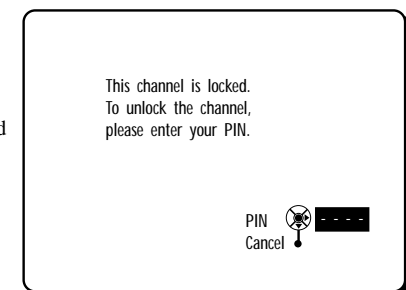

HOW TO USE THE LOCK AFTER CONTROL



There may come a time when you will need to block programming after a certain time of day. This is a great feature to limit the time your children watch TV or to lock all channels at night when material not suited for children might be broadcast.

- 1 Press the **MENU** button on the remote control to display the onscreen menu.
- 2 Press the **CURSOR RIGHT** button repeatedly to highlight CHANNELS.
- 3 Press the **CURSOR DOWN** button repeatedly to highlight the Lock After Control.
- 4 Press the **CURSOR RIGHT** button to enter the Lock After sub-menu (ON or OFF).
- 5 Press the **CURSOR UP** or **DOWN** button to highlight On from the list. A sub-menu with AM or PM will appear.
- 6 Press the **CURSOR RIGHT** button to enter the AM, PM sub-menu. A box with the time (or area when the time can be entered) will appear.
- 7 Press the **CURSOR UP** or **DOWN** button to highlight AM or PM.
- 8 Press the **CURSOR RIGHT** button to enter the lock after time.
- 9 Press the **NUMBERED** button to enter the time you want the television to lock all channels.
- 10 Press the **MENU** button to remove the onscreen menu from the TV screen.

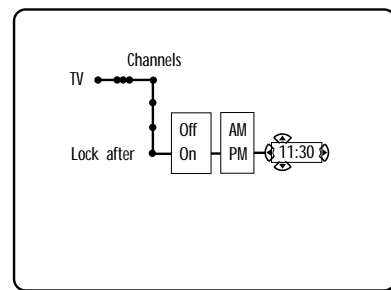
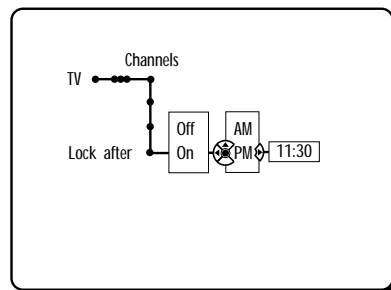
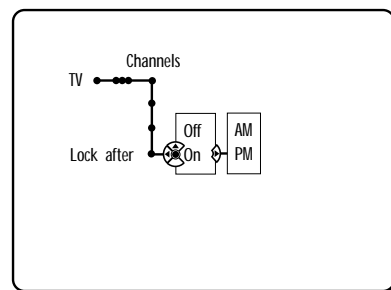
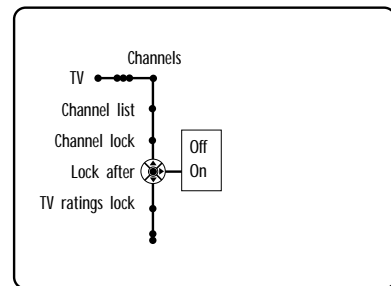
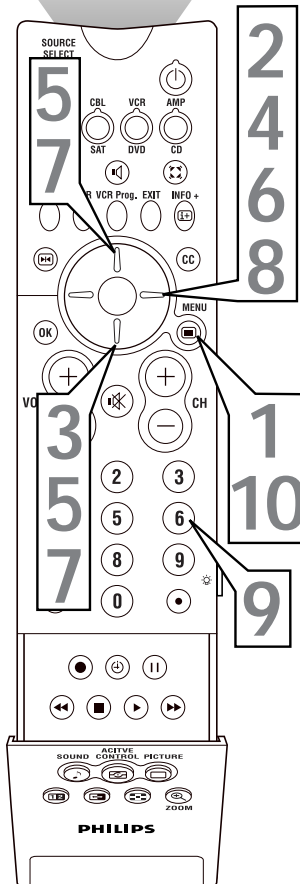
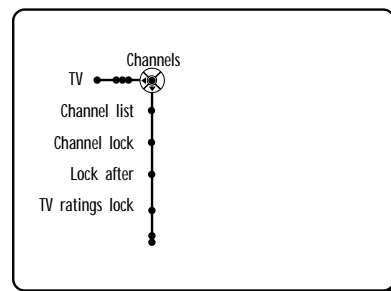
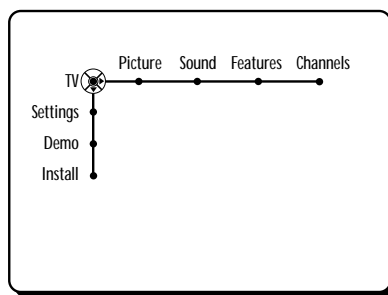

Note: To unlock a locked channel, enter your personal PIN number to clear the channel from being blocked. Please refer to page 51 for instructions on setting up a PIN (Personal Identification Number).

HELPFUL HINT

If you tune to a channel that is locked and you enter your PIN to unlock the channel, ALL locked channels will be unlocked until the television is shut off. When the television is turned back on again, previously locked channels will be locked again.

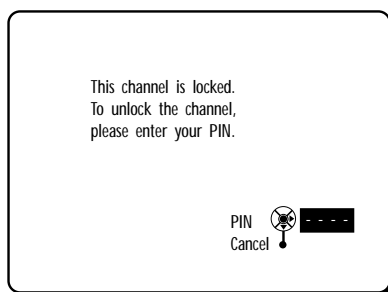

Once the Lock After setting takes place, all channels will display this screen. To view the channels, enter your PIN.



HOW TO BLOCK PROGRAMMING BASED ON TV RATINGS

You can select specific TV Ratings to block broadcast signal with unsuitable information.

- 1 Press the **MENU** button on the remote control to display the onscreen menu.
- 2 Press the **CURSOR RIGHT** button repeatedly to highlight CHANNELS.
- 3 Press the **CURSOR DOWN** button repeatedly to highlight the TV Ratings Lock Control.
- 4 Press the **CURSOR RIGHT** button to enter the TV Ratings Lock list of options.
- 5 Press the **CURSOR UP** or **DOWN** button to highlight one of the ratings.
- 6 Press the **OK** button to activate your choice. Note: Whenever a rating is turned On, all higher ratings (with their sub-ratings) will also be turned On or blocked.
- 7 Press the **MENU** button to remove the onscreen menu from the TV screen.

Note: Some of the TV Rating options contain specific sub-ratings. TV-Y7 contains sub-rating of (FV) Fantasy Violence; TV-PG and TV-14 contains sub-ratings of (D) Dialogue, (L) Language, (S) Sex, and (V) Violence; TV-MA contains sub-ratings of (L) Language, (S) Sex, and (V) Violence.

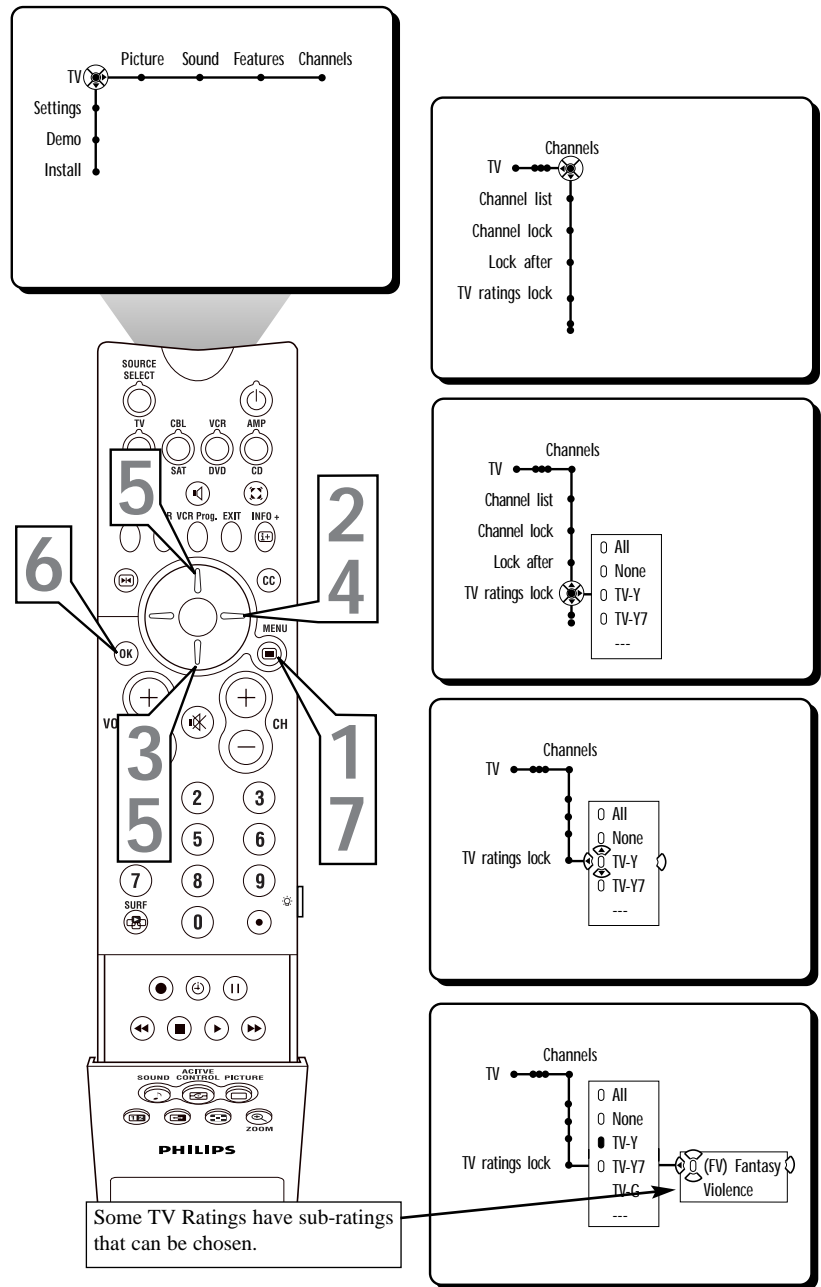

TV RATINGS (TV BROADCASTERS)



TV-Y: (All children -- appropriate for all children.) Designed for a very young audience, including children ages 2-6.



TV-Y7: (Directed to Older Children -- designed for children ages 7 and above.) For children who have acquired the development skills needed to distinguish make-believe from reality. This programming may include mild fantasy and comic violence (FV).



TV-G: (General Audience -- suitable for all ages.) Contains little or no violence, no strong language, and little or no sexual dialogue or sexual situations.



TV-PG: (Parental Guidance Suggested -- Contains material unsuitable for younger children.) Contains one or more of the following: Moderate violence (V), some sexual situations (S), infrequent coarse language (L), or some suggestive dialogue (D).



TV-14: (Parents Strongly Cautioned -- Contains some material unsuitable for children under 14 years of age.) Contains one or more of the following: intense violence (V); intense sexual situations (S); strong, coarse language (L); or intensely suggestive dialogue (D).



TV-MA: (Mature Audience Only -- Designed to be viewed by adults and unsuitable for children under 17.) Contains one or more of the following: graphic violence (V); explicit sexual situations (S); or crude, indecent language (L).

HOW TO BLOCK PROGRAMMING BASED ON MOVIE RATINGS



You can select specific Movie Ratings to block programming signals with unsuitable information.

- 1 Press the **MENU** button on the remote control to display the onscreen menu.
- 2 Press the **CURSOR RIGHT** button repeatedly to highlight CHANNELS.
- 3 Press the **CURSOR DOWN** button repeatedly to highlight the Movie Ratings Lock Control.
- 4 Press the **CURSOR RIGHT** button to enter the Movie Ratings Lock list of options.
- 5 Press the **CURSOR UP** or **DOWN** button to highlight the rating you wish to lock.
- 6 Press the **OK** button to activate your choice. Note: Whenever a rating is turned on, all higher ratings (and sub-ratings) will be turned on. (i.e., If R is selected, NC-17 and X will automatically turn on also.)
- 7 Press the **MENU** button to remove the onscreen menu from the TV screen.

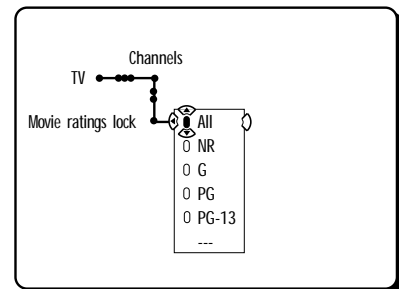
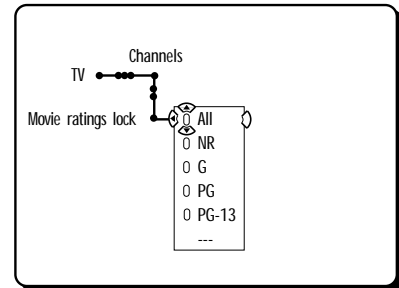
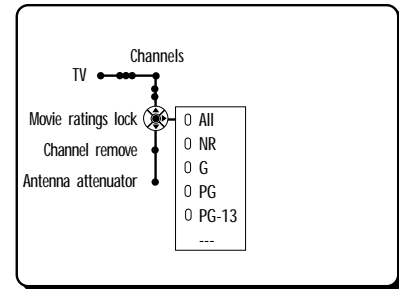
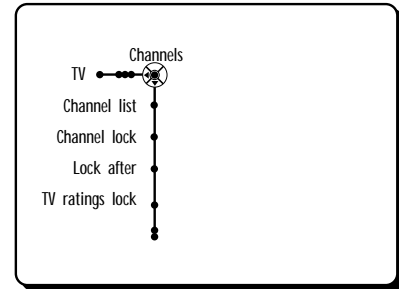
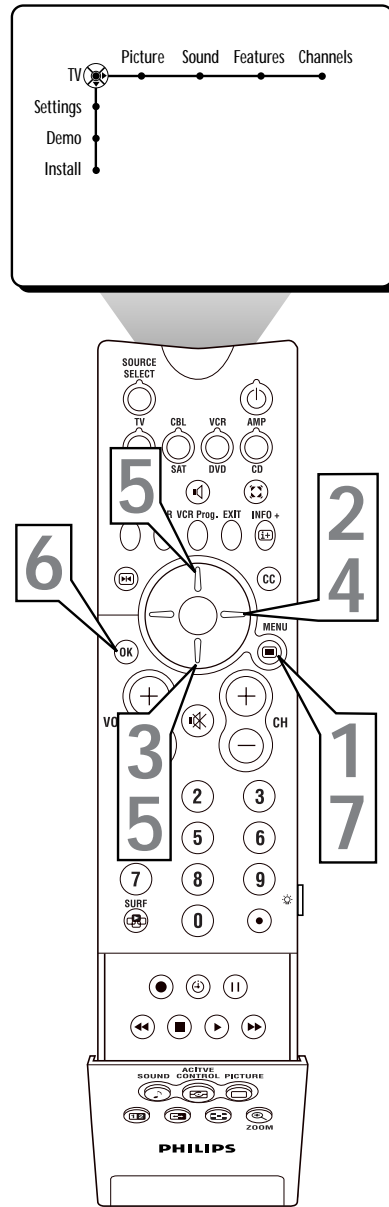

MOVIE RATINGS

(MOTION PICTURE ASSOCIATION OF AMERICA)

G: General Audience - All ages admitted. Most parents would find this programming suitable for all ages. This type of programming contains little or no violence, no strong language, and little or no sexual dialogue or sexual situations.

PG: Parental Guidance Suggested - This programming contains material that parents may find unsuitable for younger children. It may contain one or more of the following: Moderate violence, some sexual situations, infrequent coarse language, or some suggestive dialogue.

PG-13: Parents Strongly Cautioned - This programming contains material that parents may find unsuitable for children under the age of 13. It contains one or more of the following: violence, sexual situations, coarse language, or suggestive dialogue.

R: Restricted - This programming is specifically designed for adults. Anyone under the age of 17 should view this programming only with an accompanying parent or adult guardian. It contains one or more of the following: intense violence; intense sexual situations; strong coarse language; or intensely suggestive dialogue.

NC-17: No one under the age of 17 will be admitted. - This type of programming should be viewed by adults only. It contains graphic violence; explicit sex; or crude, indecent language.

X: Adults Only - This type of programming contains one or more of the following: very graphic violence, very graphic and explicit or indecent sexual acts, very coarse and intensely suggestive language.



HOW TO REMOVE CHANNELS FROM THE CHANNEL LIST

You can remove specific channels from the television's memory by using the Channel Remove Control.

- 1** Press the **MENU** button on the remote control to display the onscreen menu.
- 2** Press the **CURSOR RIGHT** button repeatedly to highlight CHANNELS.
- 3** Press the **CURSOR DOWN** button repeatedly to highlight the Channel Remove Control.
- 4** Press the **CURSOR RIGHT** button to enter the list of channels within the television's memory.
- 5** Press the **CURSOR UP** or **DOWN** button to highlight a channel you wish to remove.
- 6** Press the **OK** button to activate your choice. After you activate the Channel Remove Control, the channel(s) highlighted will no longer be tuned when using the Channel + or - buttons.
- 7** Press the **MENU** button to remove the onscreen menu from the TV screen.

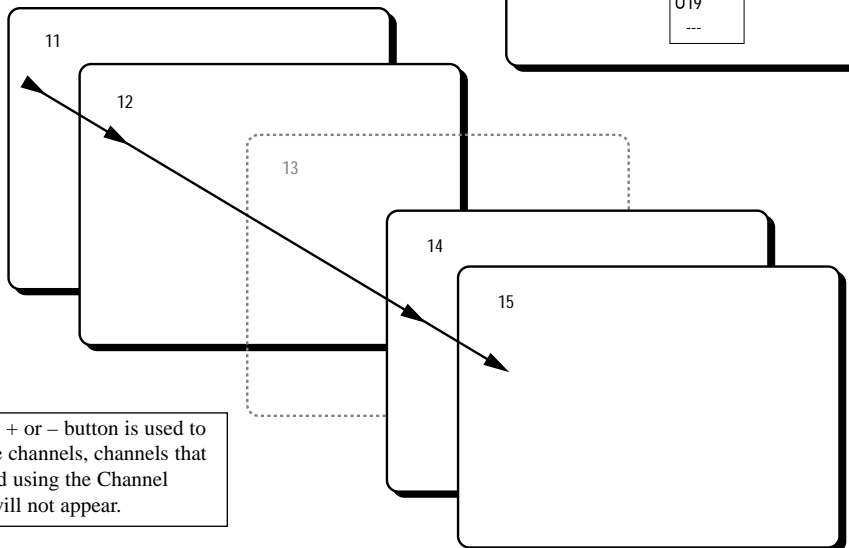
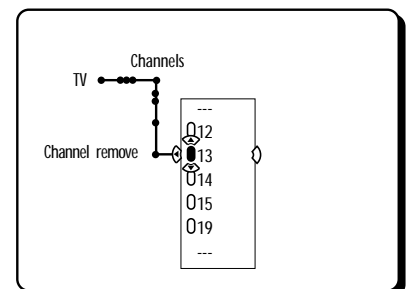
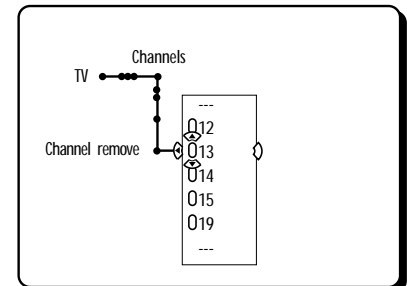
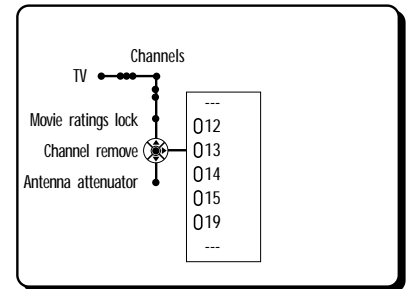
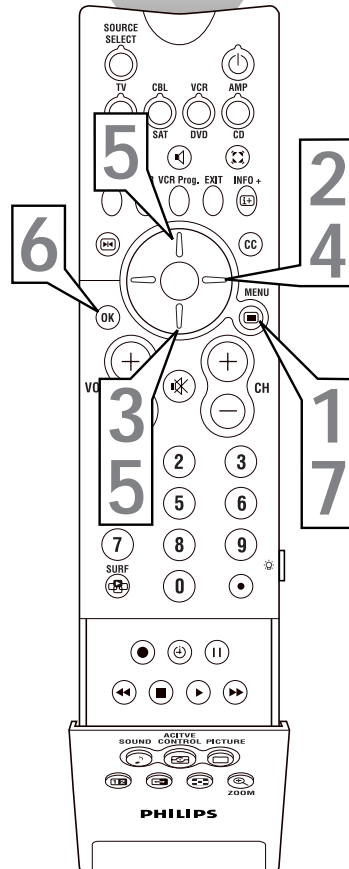
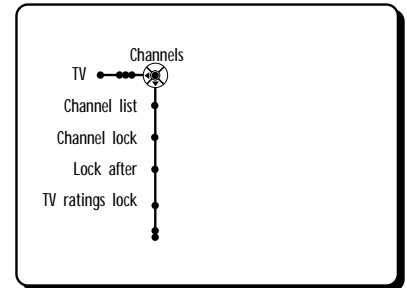
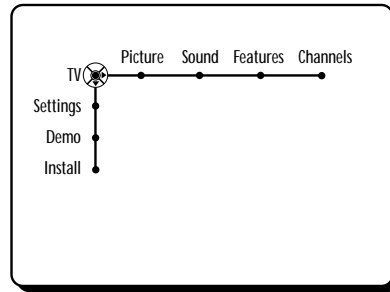

When the Channel + or - button is used to scroll the available channels, channels that have been removed using the Channel Remove Control will not appear.

HOW TO USE THE ANTENNA ATTENUATOR CONTROL



At times the signal being received may be weak due to various reasons. This television is equipped with a control (Antenna Attenuator) that will help to improve or strengthen the signal being received.

- 1 Press the MENU button** on the remote control to display the onscreen menu.
- 2 Press the CURSOR RIGHT button** repeatedly to highlight CHANNELS.
- 3 Press the CURSOR DOWN button** repeatedly to highlight the Antenna Attenuator Control.
- 4 Press the CURSOR RIGHT button** to toggle the control ON or OFF.
- 5 Press the MENU button** to remove the onscreen menu from the TV screen.

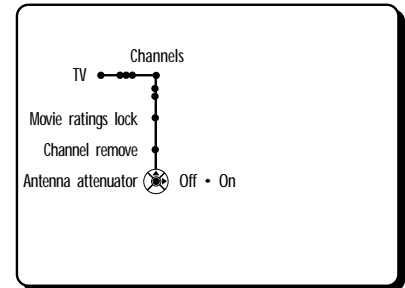
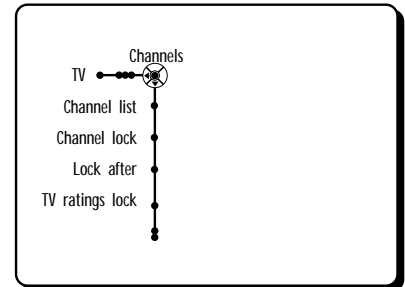
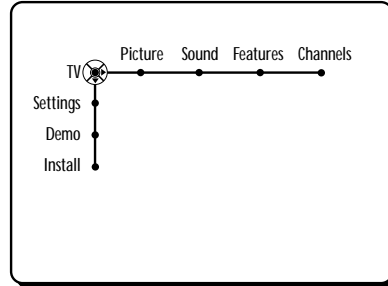

OR

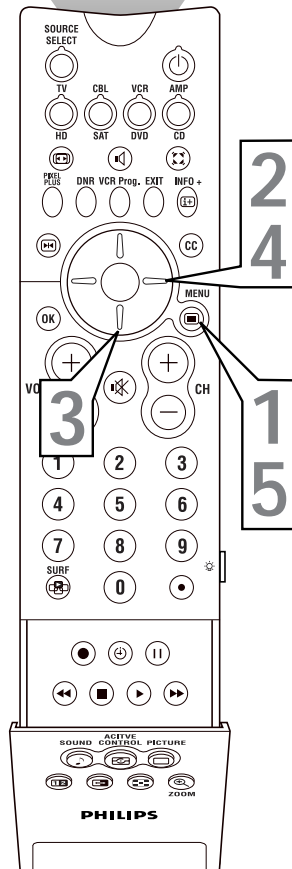
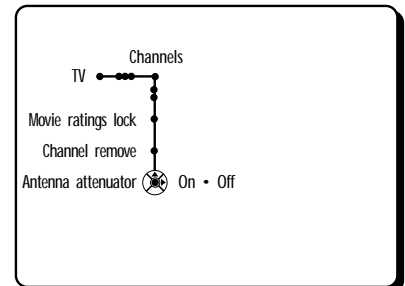



HOW TO USE THE TEST TONE AND SPEAKER TRIM CONTROLS

The Test Tone and Speaker Trim Controls will allow you to adjust and balance the sound coming from all available speakers.

- 1** Press the **MENU** button on the remote control to display the onscreen menu.
- 2** Press the **CURSOR DOWN** button to highlight **SETTINGS**.
- 3** Press the **CURSOR RIGHT** button to highlight the **Speakers** menu.
- 4** Press the **CURSOR DOWN** button to highlight the **Test Tone Control**.
- 5** Press the **CURSOR RIGHT** button to toggle the **Test Tone Control ON or OFF**. When **ON** is selected, the Test Tone control generated a sound test signal that circulates through all active speakers one at a time in a clockwise direction. With the Test Tone Control **ON**, you can now use the individual **Speaker Trim Controls** to adjust each speaker's volume.
- 6** Press the **CURSOR DOWN** button to select one of the **Speaker Trim Controls** (**Front L Trim**, **Front R Trim**, **Center Trim**, or **Surround Trim**).
- 7** Press the **CURSOR LEFT or RIGHT** button to adjust the volume for each control. Once all trim controls have been set, return to the **Test Tone Control** and turn it **OFF**.
- 8** Press the **MENU** button to remove the onscreen menu from the TV screen.

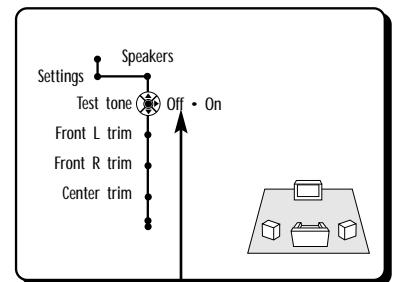
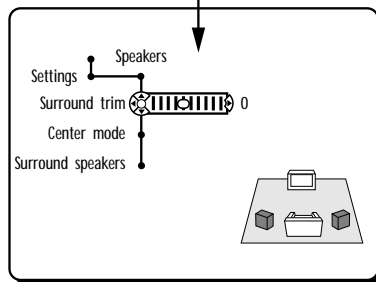
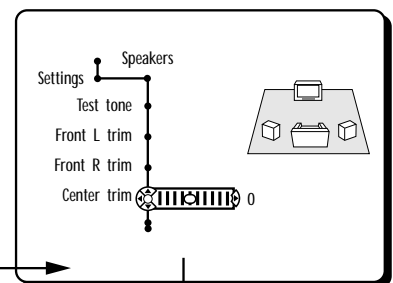
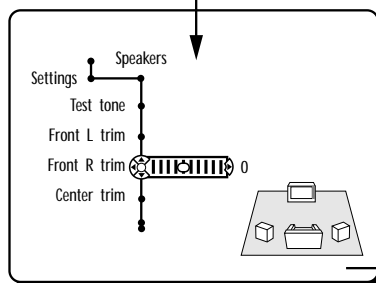
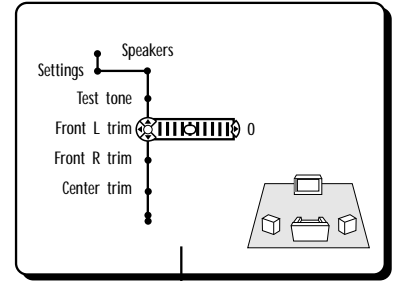
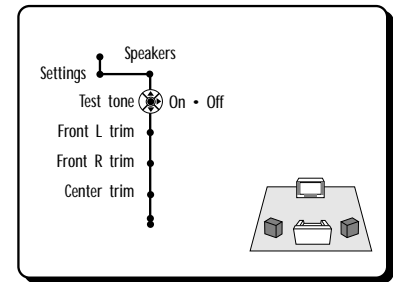
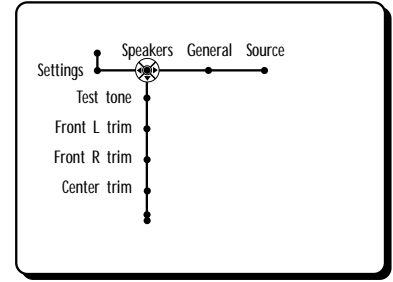
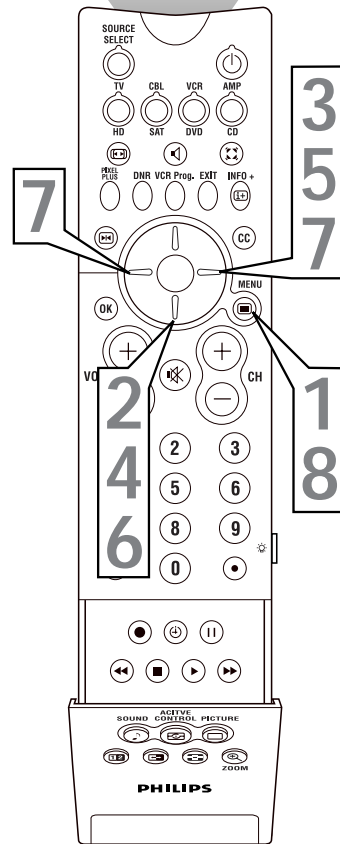
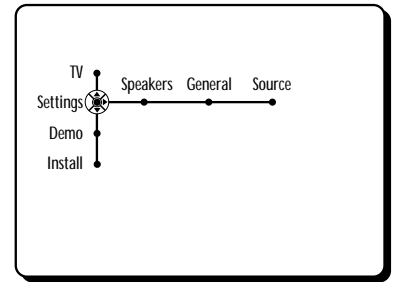
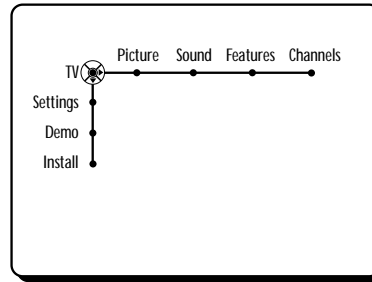

Be sure to go back to the Test Tone Control and turn it OFF when finished with the Speaker Trim Controls.

HOW TO TURN THE CENTER MODE AND SURROUND SPEAKERS CONTROLS ON



There are simple controls to set the television in Center Mode (center speaker mode) or to turn the Surround Speakers ON.

To turn the Center Mode Control ON:

- 1 Press the **MENU** button on the remote control to display the onscreen menu.
- 2 Press the **CURSOR DOWN** button to highlight **SETTINGS**.
- 3 Press the **CURSOR RIGHT** button to highlight the **Speakers** menu.
- 4 Press the **CURSOR DOWN** button repeatedly to highlight the **Center Mode Control**.
- 5 Press the **CURSOR RIGHT** button to toggle the Center Mode Control ON or OFF.

To turn the Surround Speakers Control ON:

- 6 Within the **Speakers** menu, press the **CURSOR DOWN** button repeatedly to select the **Surround Speakers Control**.
- 7 Press the **CURSOR RIGHT** button to toggle the Surround Speakers Control ON or OFF.
- 8 Press the **MENU** button to remove the onscreen menu from the TV screen.

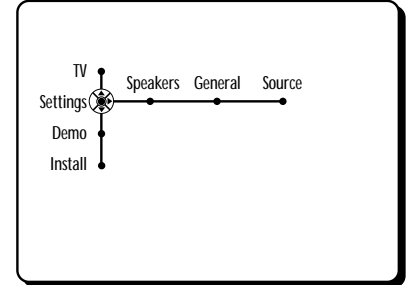
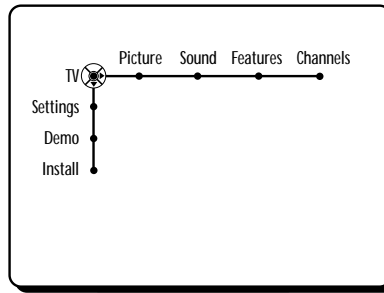

Center Mode Control

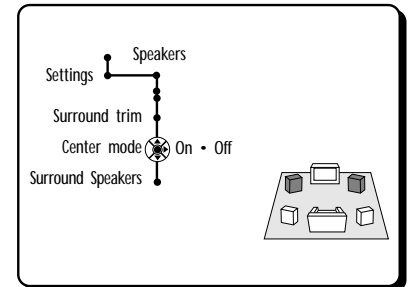
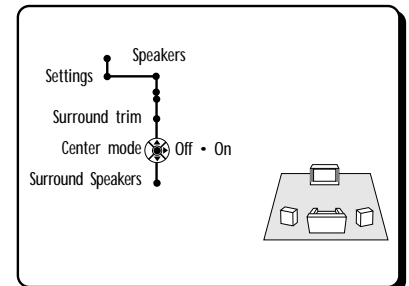
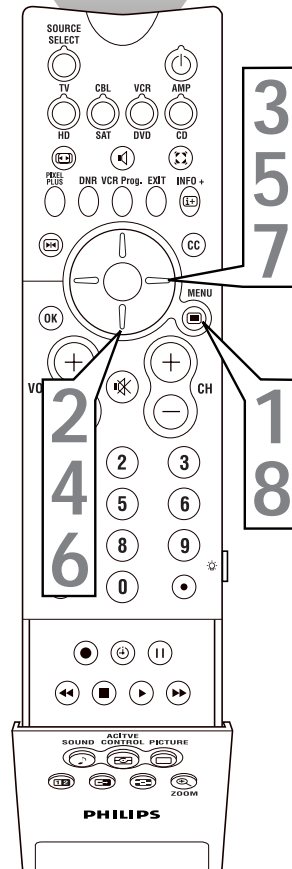

Surround Speakers Control

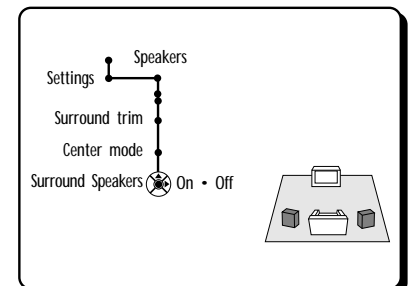
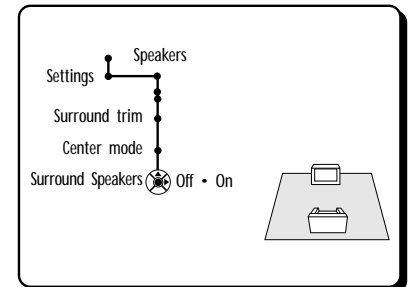

HOW TO USE THE MENU BACKGROUND CONTROL

To help view the onscreen menu better when it is activated, the Menu Background Control will place a light transparent green field behind the onscreen menu. This field reduces the contrast in the TV picture allowing the text of the onscreen menu to be more highly visible.

- 1** Press the **MENU** button on the remote control to display the onscreen menu.
- 2** Press the **CURSOR DOWN** button to highlight SETTINGS.
- 3** Press the **CURSOR RIGHT** button repeatedly to highlight the General menu.
- 4** Press the **CURSOR DOWN** button to highlight the Menu Background Control.
- 5** Press the **CURSOR RIGHT** button to toggle the Menu Background Control ON or OFF.
- 6** Press the **MENU** button to remove the onscreen menu from the TV screen.

Note: The Menu Background, when ON, will only appear while the onscreen menu is displayed on the television screen.

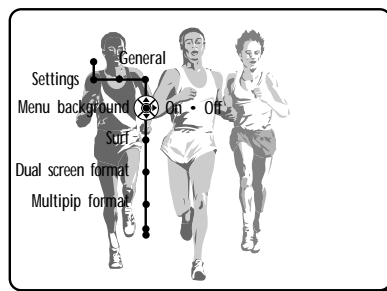
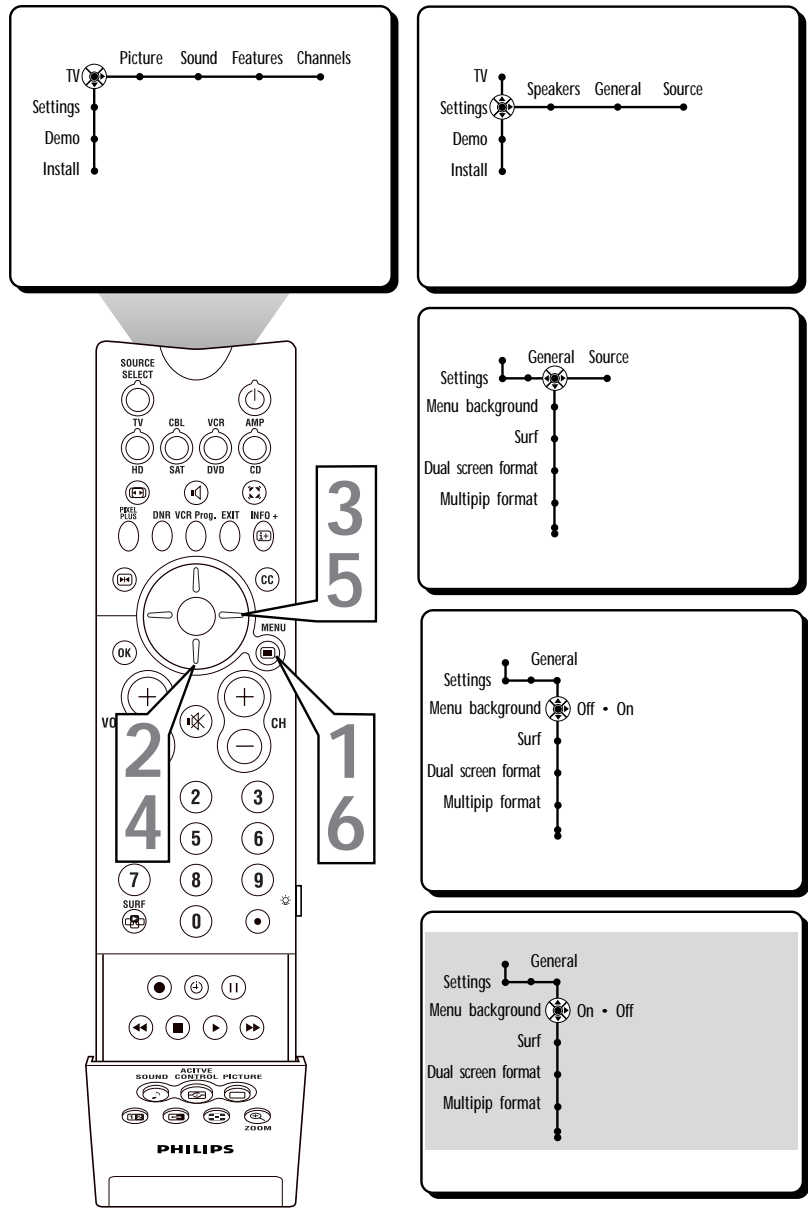

With Menu Background OFF

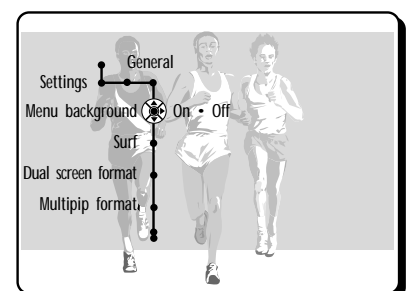

With Menu Background ON

HOW TO USE THE SURF CONTROL



A list or series of previously viewed channels can be selected with the SURF button on your remote control. With this feature, you can easily switch between different TV channels that currently interest you. The SURF Control allows you to set up the television to toggle 2 channels or 9 channels when pressing the Surf button on the remote.

- 1** Press the **MENU** button on the remote control to display the onscreen menu.
- 2** Press the **CURSOR DOWN** button to highlight SETTINGS.
- 3** Press the **CURSOR RIGHT** button repeatedly to highlight the General menu.
- 4** Press the **CURSOR DOWN** button repeatedly to highlight the Surf Control.
- 5** Press the **CURSOR RIGHT** button to toggle the Surf Control between 2 channels or 9 channels.
- 6** Press the **MENU** button to remove the onscreen menu from the TV screen.
- 7** Press the **SURF** button on the remote control repeatedly to toggle through the last series of viewed channels (2 or 9 depending on what is selected in the Surf control).

Note: 2 Channel Surf works like an Alternate Channel control. Pressing the SURF button will toggle the current channel and previously last viewed channel. 9 Channel Surf allows toggling of the present channel and the last previously viewed 8 channels when pressing the SURF button.

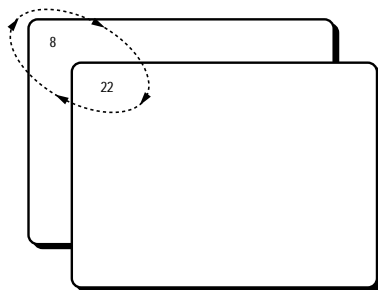
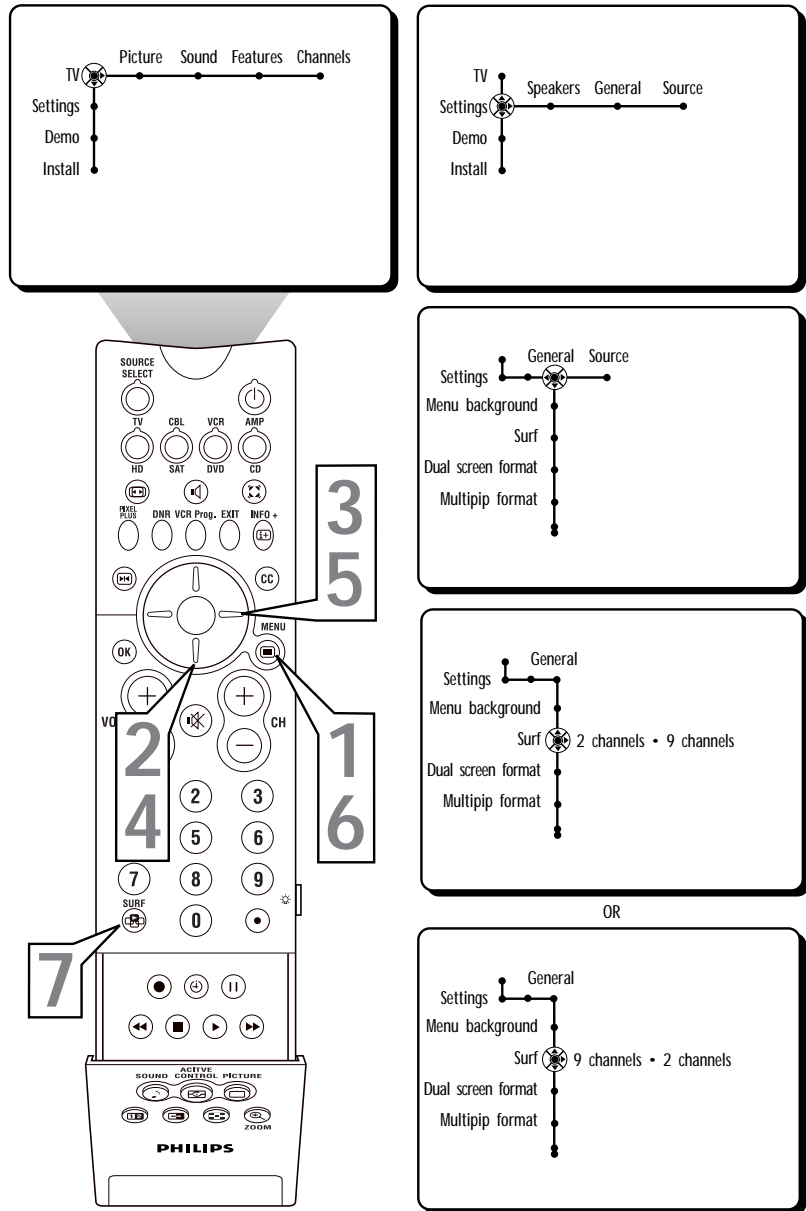

2 Channel Surf

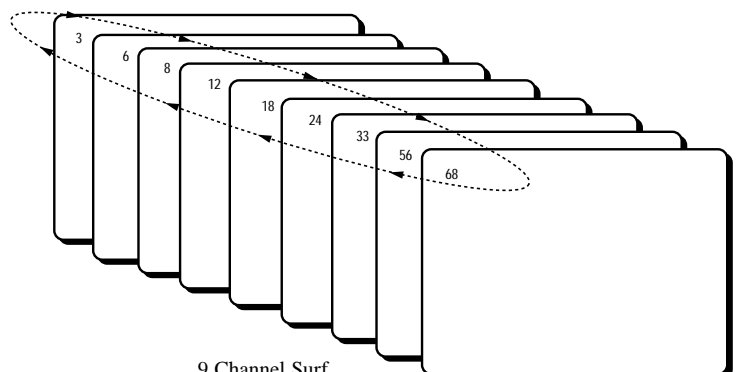

9 Channel Surf

HOW TO USE THE DUAL SCREEN FORMAT CONTROL

The Dual Screen, or sometimes called Picture In Picture (PIP), feature will allow you to choose the size of Dual Screen window to be displayed when the Dual Screen (or PIP) button is pressed on the remote control. The window can be set to Dual Screen, Large PIP, Medium PIP, or Small PIP.

- 1 Press the **MENU** button on the remote control to display the onscreen menu.
- 2 Press the **CURSOR DOWN** button to highlight SETTINGS.
- 3 Press the **CURSOR RIGHT** button repeatedly to highlight the General menu.
- 4 Press the **CURSOR DOWN** button repeatedly to highlight the Dual Screen Format Control. A sub-menu or list of options will appear.
- 5 Press the **CURSOR RIGHT** button to enter the list of options.
- 6 Press the **CURSOR UP** or **DOWN** button to select the desired Dual Screen Format. Choose from Dual Screen, Large PIP, Medium PIP, or Small PIP.
- 7 Press the **MENU** button to remove the onscreen menu from the TV screen.
- 8 Press the **Dual Screen** button on the remote control to display the second video window in the format you have chosen. Press the **Dual Screen** button again to return the television to the main

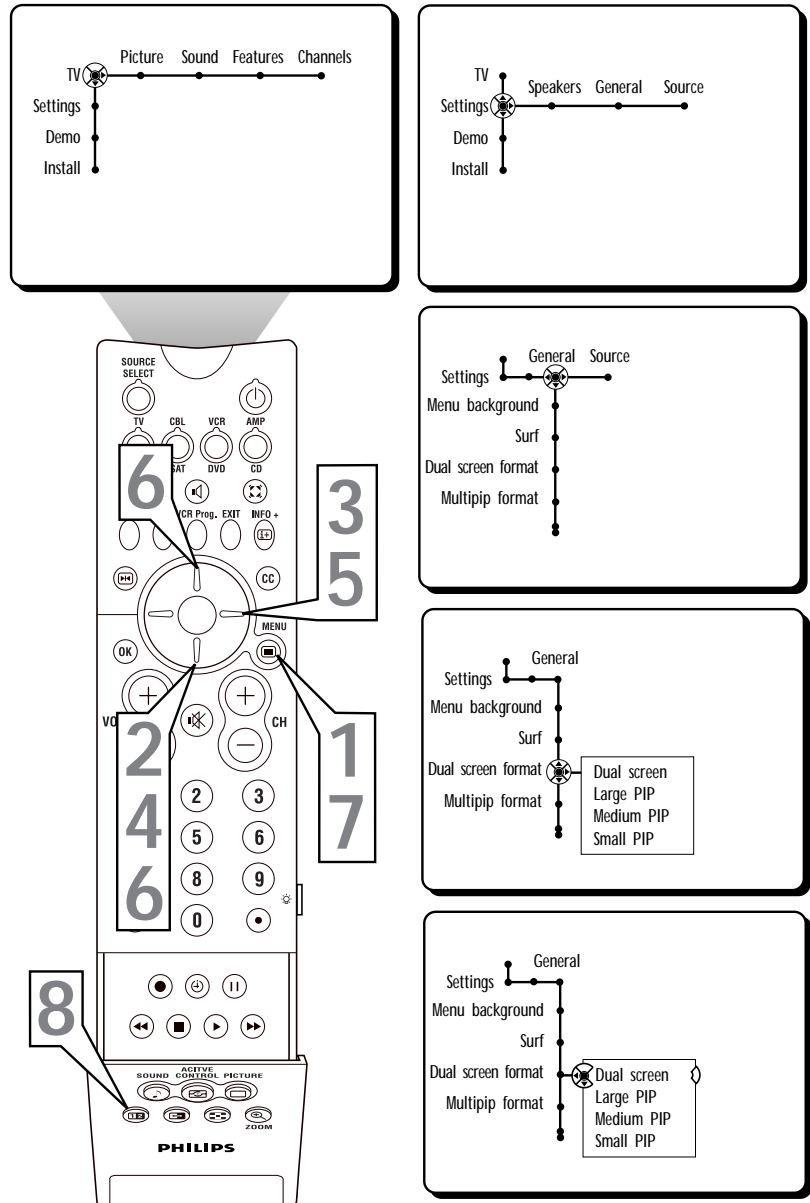

Dual Screen

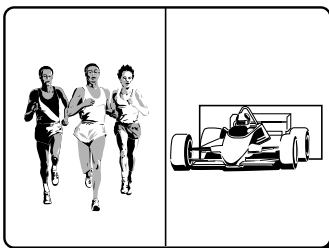

Large PIP



Medium PIP

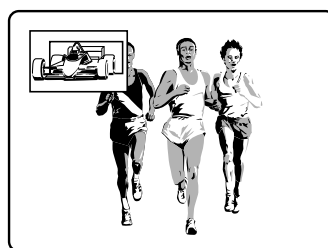

Small PIP

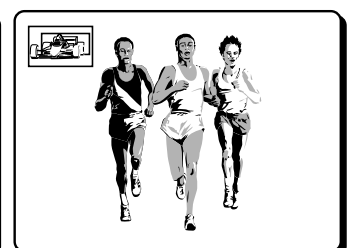

HOW TO USE THE MULTIPIP CONTROL



The MultiPIP Control will allow you to choose between showing 3 or 6 PIP windows while still displaying the main video picture onscreen.

- 1 Press the **MENU** button on the remote control to display the onscreen menu.
- 2 Press the **CURSOR DOWN** button to highlight SETTINGS.
- 3 Press the **CURSOR RIGHT** button repeatedly to highlight the General menu.
- 4 Press the **CURSOR DOWN** button repeatedly to highlight the Multipip Control.
- 5 Press the **CURSOR RIGHT** button to toggle between PIP 3 (3 PIP windows) or PIP 6 (6 PIP windows).
- 6 Press the **MENU** button to remove the onscreen menu from the TV screen.
- 7 Press the **MultiPIP** button on the remote control to display the multiple video windows in the format you have chosen. Press the **MultiPIP** button again to return the television to the main video screen.

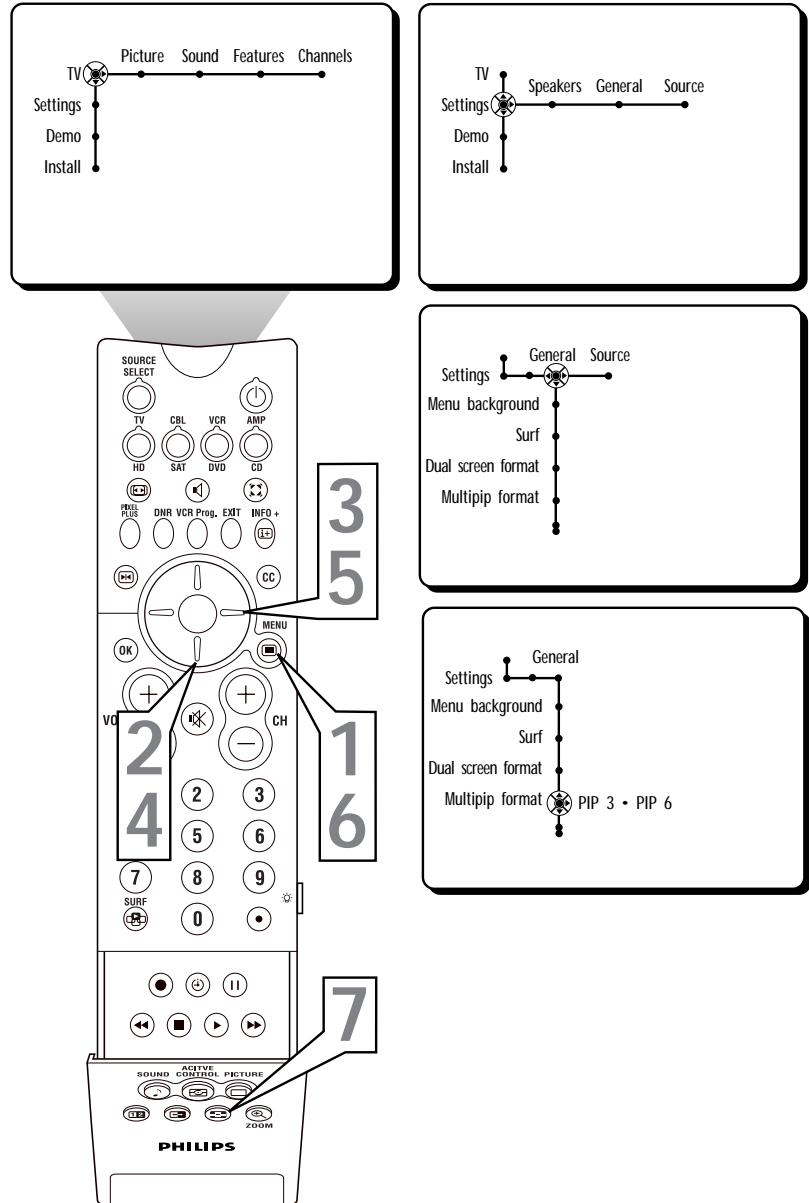

PIP 3

PIP 6

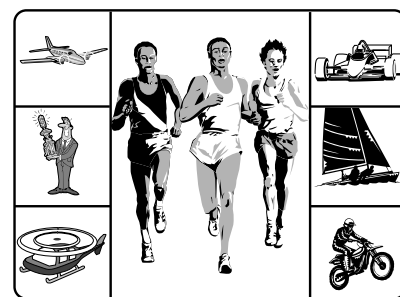
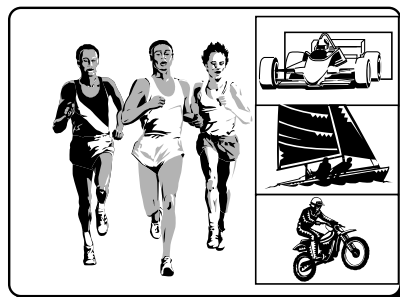

HOW TO USE THE FREEZE CONTROL

The Freeze Control will allow you to set the freeze option to one of three different choices. Choose from the Freeze, Replay, or Photo Finish options. Below are the steps describing the process to set the Freeze Format Control.

- 1** Press the **MENU** button on the remote control to display the onscreen menu.
- 2** Press the **CURSOR DOWN** button to highlight SETTINGS.
- 3** Press the **CURSOR RIGHT** button repeatedly to highlight the General menu.
- 4** Press the **CURSOR DOWN** button repeatedly to highlight the Freeze Format Control. A sub-menu with a list of options will appear.
- 5** Press the **CURSOR RIGHT** button to enter the list of options.
- 6** Press the **CURSOR UP** or **DOWN** button to select the desired Freeze Format. Choose from Freeze, Replay, or Photo finish.
- Freeze** - Will freeze the main screen image while the audio continues to play.
- Replay** - Will display and replay a few seconds of store video information within single PIP window.
- Photo Finish** - Will display a series of frozen images within 6 PIP windows.
- 7** Press the **MENU** button to remove the onscreen menu from the TV screen.
- 8** Press the **FREEZE** button on the remote control to display the format you have chosen. Press the **FREEZE** button again to return the television to the main video screen.

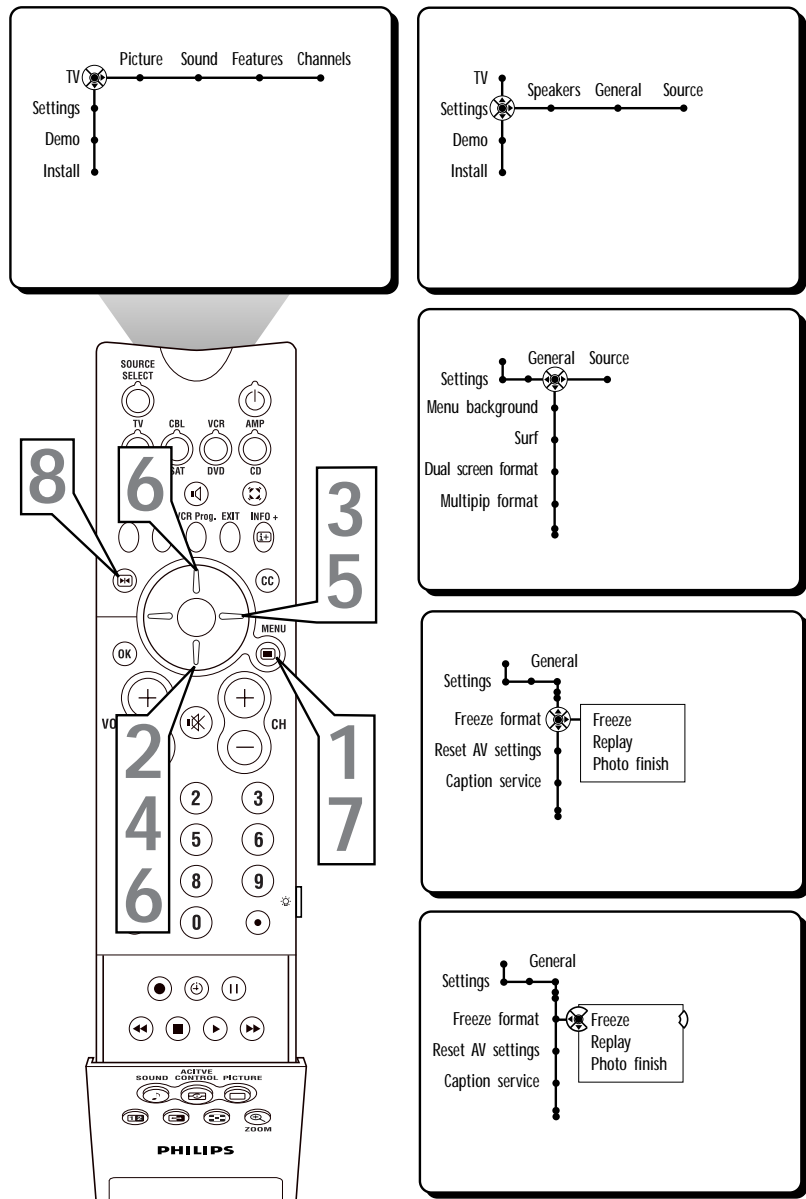

FREEZE
Single frozen image



REPLAY
Replays a few seconds of stored video



PHOTO FINISH
Displays a series of 6 frozen images within 6 PIP windows



HOW TO RESET THE AUDIO VIDEO SETTING TO THE FACTORY PRESETS

The Audio/Video control can be reset to the Factory set modes using the Reset AV Setting Control.

- 1 Press the **MENU** button on the remote control to display the onscreen menu.
- 2 Press the **CURSOR DOWN** button to highlight SETTINGS.
- 3 Press the **CURSOR RIGHT** button repeatedly to highlight the General menu.
- 4 Press the **CURSOR DOWN** button repeatedly to highlight the Reset AV Setting Control.
- 5 Press the **OK** button to activate the control.
- 6 Press the **MENU** button to remove the onscreen menu from the TV screen.

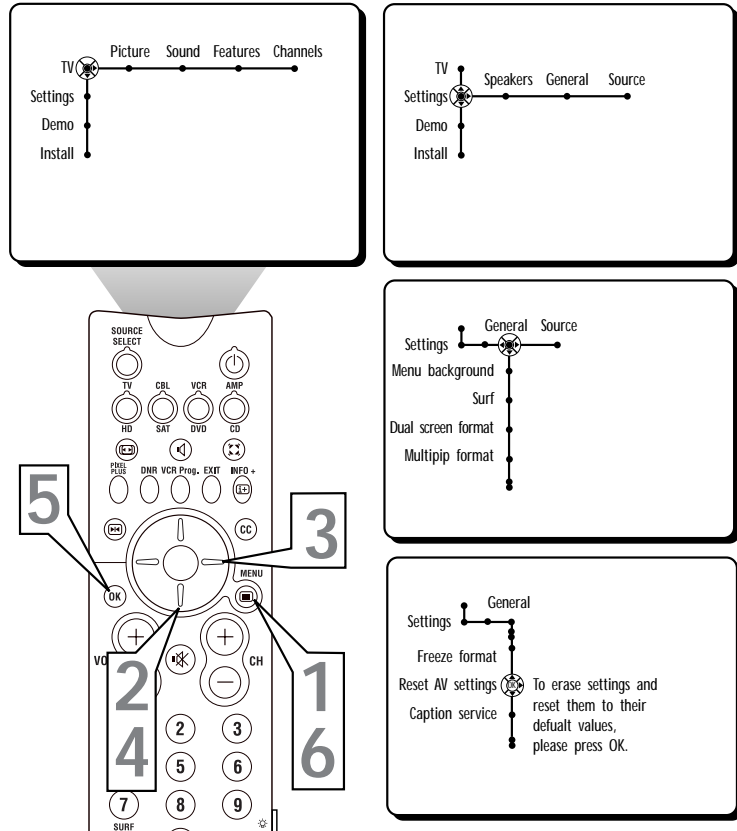

HOW TO USE THE TILT ADJUST CONTROL

There may be times when the video reproduction from some signals may appear to be slightly tilted from normal. The Tilt Adjust Control can help to correct this problem.

- 1 Press the **MENU** button on the remote control to display the onscreen menu.
- 2 Press the **CURSOR DOWN** button to highlight SETTINGS.
- 3 Press the **CURSOR RIGHT** button repeatedly to highlight the General menu.
- 4 Press the **CURSOR DOWN** button repeatedly to highlight the Tilt Adjust Control.
- 5 Press the **CURSOR RIGHT** button to tilt the image clockwise, or press the **CURSOR LEFT** button to tilt the image counter clockwise.
- 6 Press the **MENU** button to remove the onscreen menu from the TV screen.

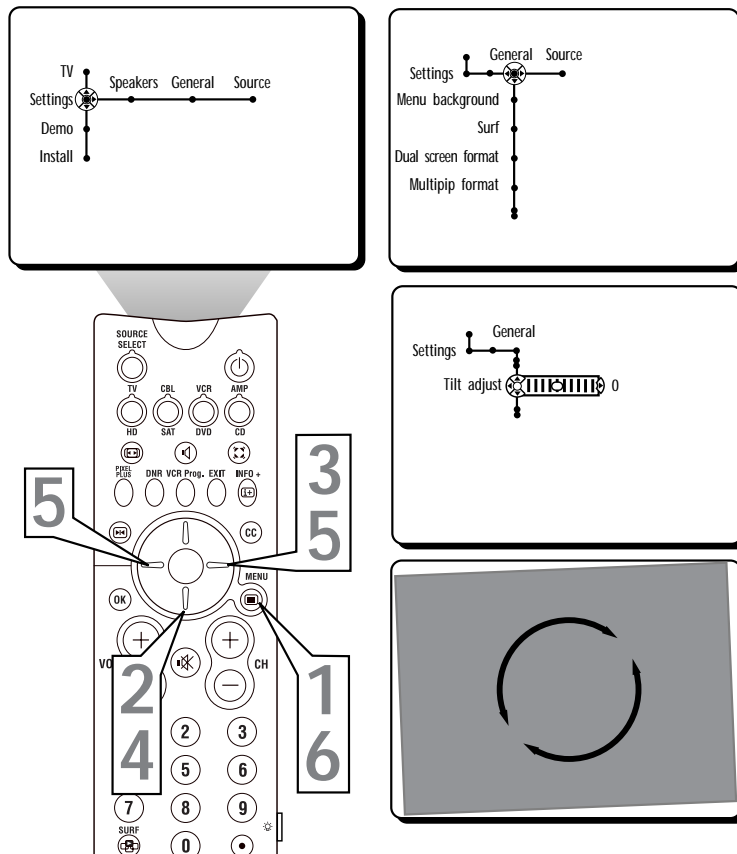

HOW TO MAXIMIZE OR MINIMIZE THE ONSCREEN DISPLAY

The television Onscreen Display (OSD) Control can be set two ways. OSD Minimize limits the TV display to current channel number status. Normal shows additional TV operating modes and other status screen information.

- 1 Press the **MENU** button on the remote control to display the onscreen menu.
- 2 Press the **CURSOR DOWN** button to highlight SETTINGS.
- 3 Press the **CURSOR RIGHT** button repeatedly to highlight the General menu.
- 4 Press the **CURSOR DOWN** button repeatedly to highlight the OSD Control.
- 5 Press the **CURSOR RIGHT** button to toggle between Minimize or Maximize.
- 6 Press the **MENU** button to remove the onscreen menu from the TV screen.

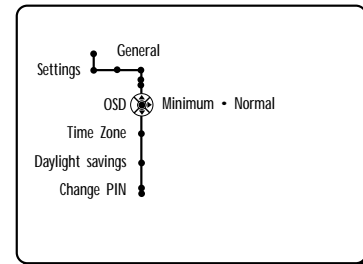
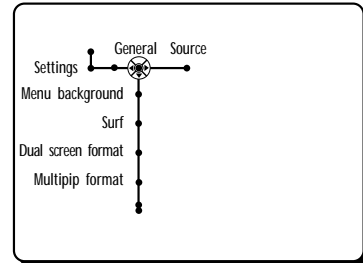
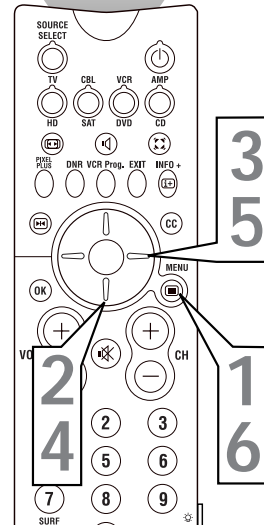
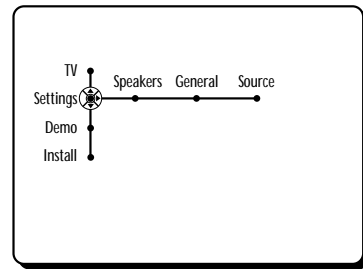
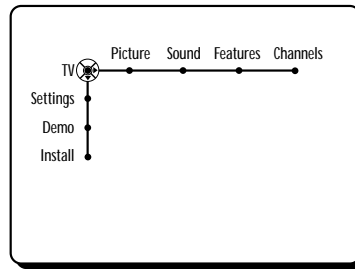
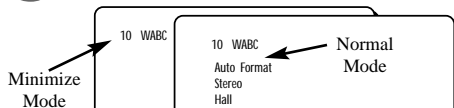

HOW TO SELECT A TIME ZONE AND SET THE DAYLIGHT SAVINGS CONTROL

Your television can pick the current time from the signal being received. It needs to know your Time Zone and if you use Daylight Savings.

- 1 Press the **MENU** button on the remote control to display the onscreen menu.
- 2 Press the **CURSOR DOWN** button to highlight SETTINGS.
- 3 Press the **CURSOR RIGHT** button repeatedly to highlight the General menu.
- 4 Press the **CURSOR DOWN** button repeatedly to highlight the Timer Zone Control.
- 5 Press the **CURSOR RIGHT** button to enter the list of available zones.
- 6 Press the **CURSOR UP** or **DOWN** button to select your Time Zone.
- 7 Press the **CURSOR LEFT** button, then press the **CURSOR DOWN** button to highlight the Daylight Savings Control.
- 8 Press the **CURSOR RIGHT** button to toggle Daylight Savings to Automatically change or to Off.
- 9 Press the **MENU** button to remove the onscreen menu from the TV screen.

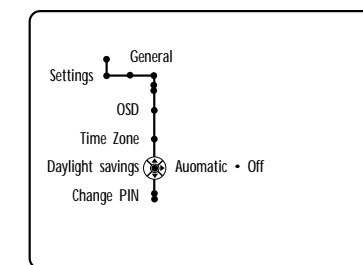
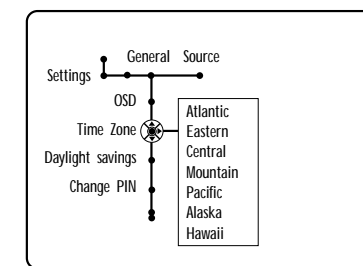
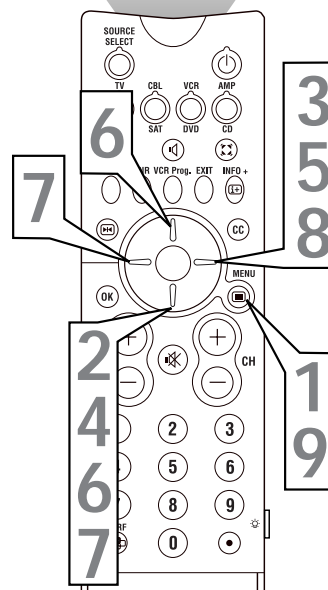
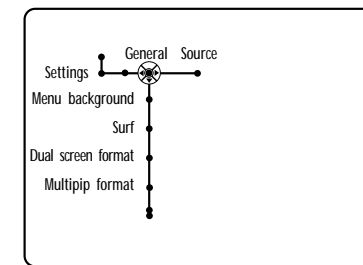
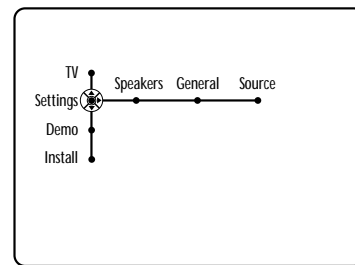

HOW TO SETUP OR CHANGE A PIN (PERSONAL IDENTIFICATION NUMBER)

Setting up a PIN or changing your existing PIN is easy. Follow the steps below to learn how.

- 1 Press the **MENU** button on the remote control to display the onscreen menu.
- 2 Press the **CURSOR DOWN** button to highlight **SETTINGS**.
- 3 Press the **CURSOR RIGHT** button repeatedly to highlight the **General** menu.
- 4 Press the **CURSOR DOWN** button repeatedly to highlight the **Change PIN** Control.
- 5 Press the **OK** button to begin the process.
- 6 Enter the default four digit PIN number (**0, 7, 1, 1**) using the **NUMBERED** buttons on the remote control.
- 7 Using the **NUMBERED** buttons on the remote control, enter a new four digit PIN.
- 8 Re-enter your new PIN using the **NUMBERED** buttons to confirm the code. Your PIN is now changed.
- 9 Press the **MENU** button on the remote control to remove the onscreen menu from the TV screen.

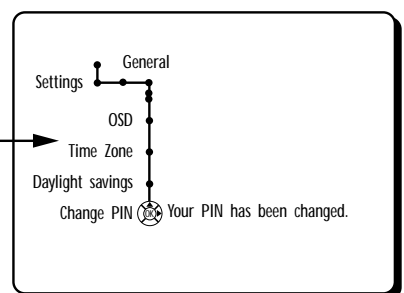
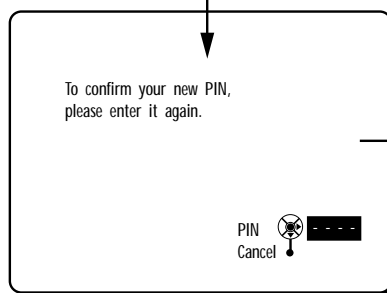
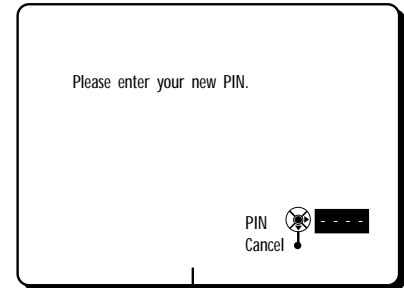
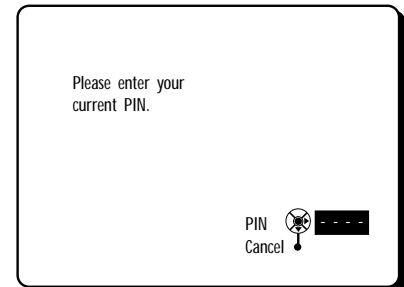
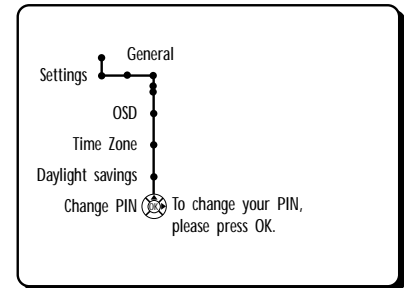
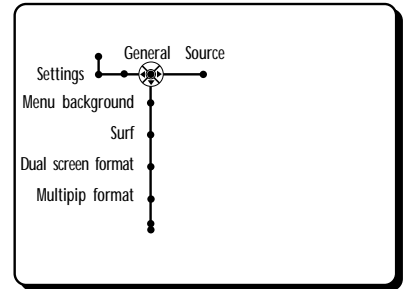
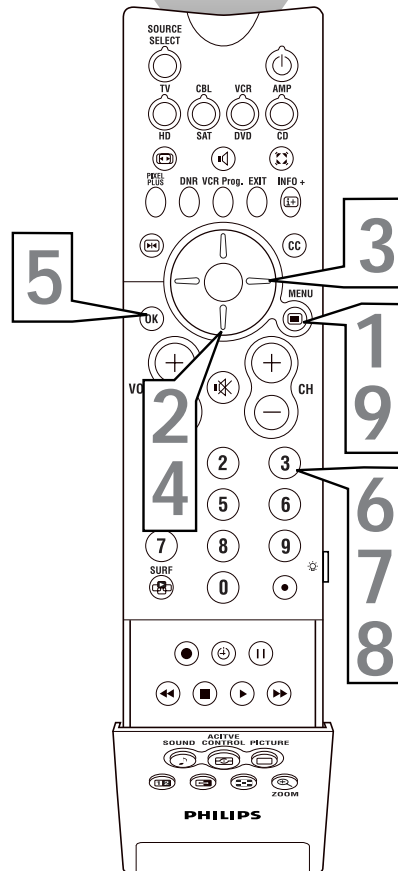
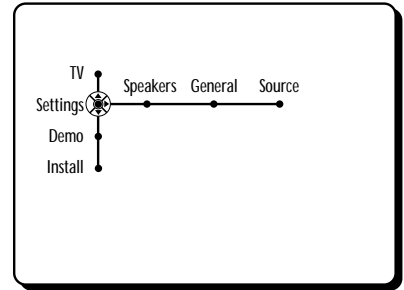
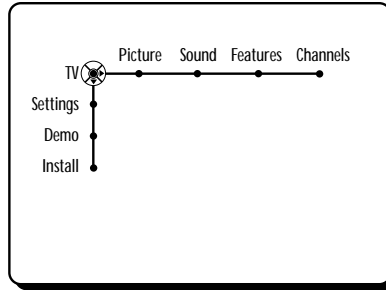

HELPFUL HINT

Remember, if you ever forget you current four digit PIN, the default four digit PIN is:

0, 7, 1, 1

This default PIN will still work as a backup number even if you create a new PIN.

HOW TO LABEL THE AUDIO/VIDEO INPUT JACKS

Within the Source Control, all the external Audio/Video Input Jacks can be given a channel label that will appear along side the channel indicator when the AV Input channels are tuned.

- 1 Press the **MENU** button on the remote control to display the onscreen menu.
- 2 Press the **CURSOR DOWN** button to highlight SETTINGS.
- 3 Press the **CURSOR RIGHT** button repeatedly to highlight the Source menu.
- 4 Press the **CURSOR DOWN** button repeatedly to highlight any of the AV Inputs. (AV1, AV2, AV3, AV4, or SIDE) A sub-menu or list of names will appear next to the selected AV Input.
- 5 Press the **CURSOR RIGHT** button to enter the sub-menu list.
- 6 Press the **CURSOR UP** or **DOWN** button to scroll and highlight one of the labels on the list.
- 7 Press the **MENU** button on the remote control to remove the onscreen menu from the TV screen.
- 8 Press the **SOURCE SELECT** button on the remote control to display the list of AV Inputs and their labels.

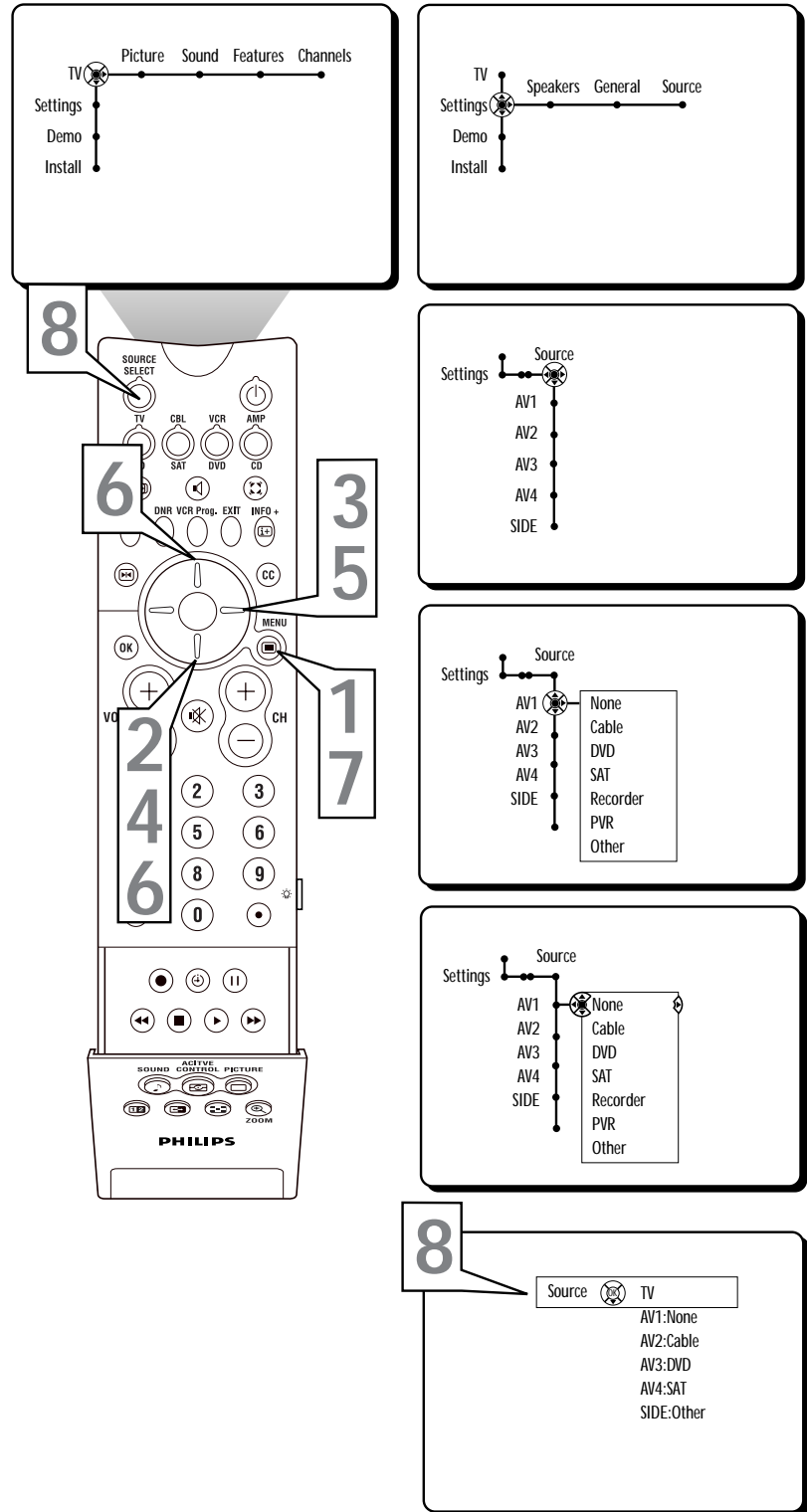

This is just a sample of what the labeling might look like. Your Source Labels will depend on how you choose to label the AV Inputs.

USING THE ACTIVE CONTROL



The Active Control monitors and adjusts incoming video signals to help provide the best picture quality. When you choose to turn the Active Control ON, the control can be set to Minimum, Medium, or Maximum effect.

- 1 Press the **ACTIVE CONTROL** button on the remote control to display the Active Control menu.
- 2 Press the **CURSOR UP** or **DOWN** button to highlight one of the options (Minimum, Medium, Maximum or Off).
- 3 Press the **CURSOR RIGHT** button to display the Active Control information window. You will notice how the values constantly change while Active Control is working.
- 4 Press the **MENU** button to remove the onscreen menu from the TV screen.

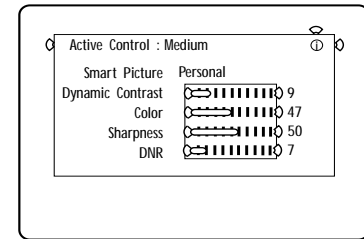
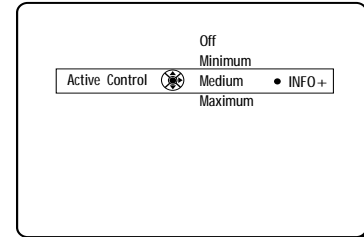
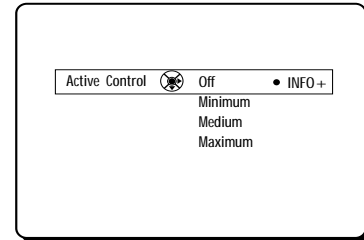
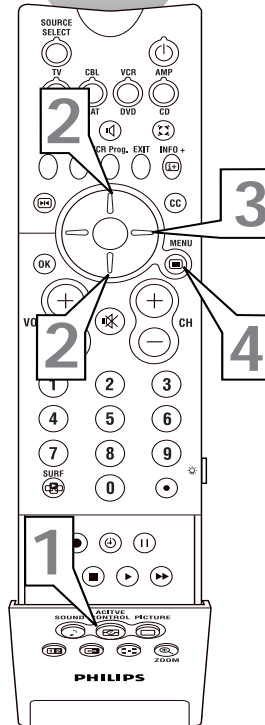

HOW TO USE THE ZOOM CONTROL



This television offers an unique feature called Zoom. The Zoom Controls allows you to magnify the onscreen picture by 4, 9, or 16 times. The magnified picture can also be panned with the cursor buttons.

- 1 Press the **ZOOM** button on the remote control to display the Zoom menu.
- 2 Press the **OK** button repeatedly to select and highlight one of the zoom options (4x, 9x, or 16x).
- 3 Press and hold any of the **CURSOR** buttons to pan the picture up, down, left or right.
- 4 Press the **MENU** button to remove the Zoom menu from the TV screen and return the picture to its normal size.

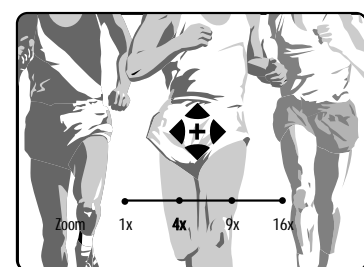
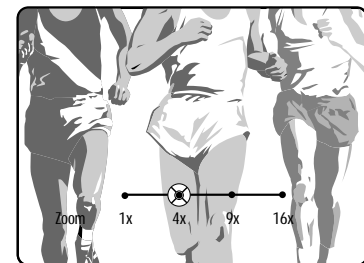
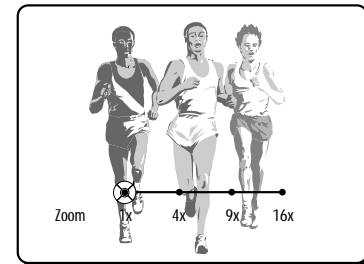
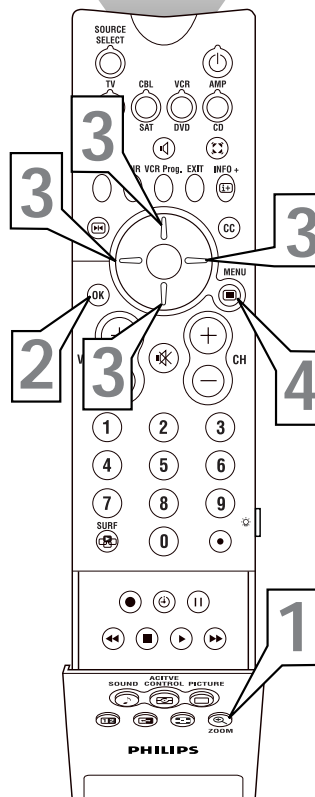



SETTING THE REMOTE CONTROL TO OPERATE ACCESSORY DEVICES

The remote control that is supplied with your television may also work with a variety of infrared controlled accessory devices such as VCRs, Cable Boxes, DVD Players, Satellite Receivers, etc.

- 1 Press the CBL, VCR, AMP, HD, SAT, DVD, or CD button** depending on the type of accessory device you want to operate. If the function buttons (i.e.; Play, CH + or -, Stop, etc.) on the remote control work the device, the remote is ready to use and no further steps are required. If the remote does not work with the accessory device proceed to step 2.

Using the Code Entry Method:

(Please look up the code(s) for your brand of accessory device (listed on pages 56-57) before you begin the next few steps.)

- 2 Press the desired MODE button** that corresponds to the type of device you wish to operate. (CBL, VCR, AMP, HD, SAT, DVD, or CD) A green light will indicate the mode labeled on the top of the button, while a red light will indicate the mode labeled on the bottom of the button. If needed, hold the button down and the light will toggle between the green and red settings.

- 3 Press and hold the NUMBER 1 and 3 buttons** at the same time until the backlight and selected mode buttons light up. Then, release both buttons.

- 4 Within 30 seconds of completing step 3 and using the NUMBERED buttons,** enter the 4 digit code listed on pages 56-57 for you brand of device. There may be several codes for your brand and all may have to be tried.

If a valid code number has been entered, the backlight and select mode buttons will turn off and then blink twice.

Try the function buttons to see if the remote will operate your accessory device.

IF YES - No other steps are required.

IF NO - Try the procedure again with another code number listed by your brand. Several attempts may be needed to complete all code numbers.

IF NO - After several attempts fail, please refer to the next page to try the Auto Search Method.

1 Codes from page 56-57

0054

0056

0057

0891

0944



VCR



Satellite Receiver



Cable Converter

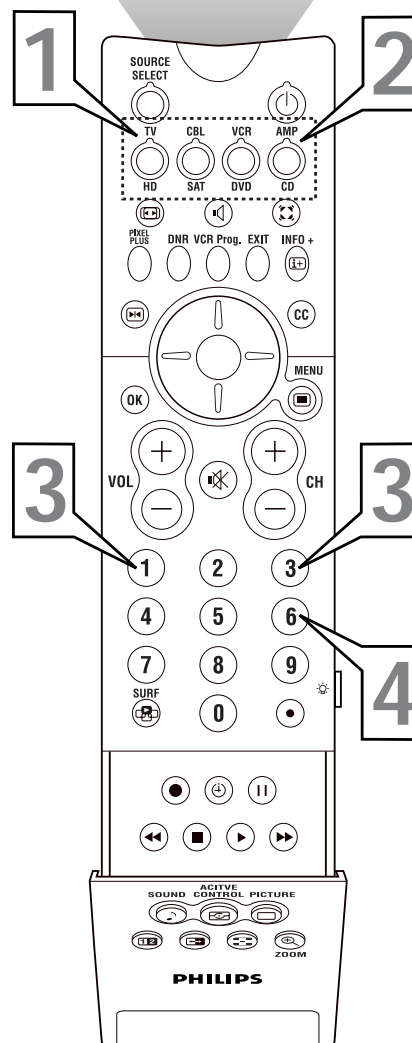



The Auto Search Method of programming the remote control can take several minutes to complete. So before starting, it is recommended that you seat yourself in a comfortable position at least six feet from the accessory device. You will have to hold the remote so that it is pointed at the front of the device for the entire time the search is taking place.

- 1** Turn the accessory device ON using the devices power button.
- 2** Press the desired **MODE** button that corresponds to the type of device you wish to operate. (CBL, VCR, AMP, HD, SAT, DVD, or CD) A green light will indicate the mode labeled on the top of the button, while a red light will indicate the mode labeled on the bottom of the button. If needed, hold the button down and the light will toggle between the green and red settings.
- 3** Press and hold the **NUMBER 1 and 3** buttons at the same time until the backlight and selected mode buttons light up. Then, release both buttons.
- 4** Press and release the red **POWER** button on the remote control. The backlight buttons will turn off.

The remote will start the Auto Search of all available codes, sending a command to channel up. The backlight will blink after each code is tried. (For devices such as DVD or CD players, insert a disc and press PLAY on the device. The remote control will send a command to switch to the next track. Switch AV receivers to the tuner function.)

IMPORTANT: Watch the channel indicator of your accessory device closely. Once the right code is found the channels on your device will start to scan up.

- 5** Press and release the red **POWER** button on the remote control as soon as the channels start to change. The backlight buttons and selected mode button will blink twice to indicate the Auto Search code setup is complete.

Note: if any other buttons are pressed during the procedure, the Auto Search will end.

Remember, Auto Search can take several minutes to complete. Please be patient.

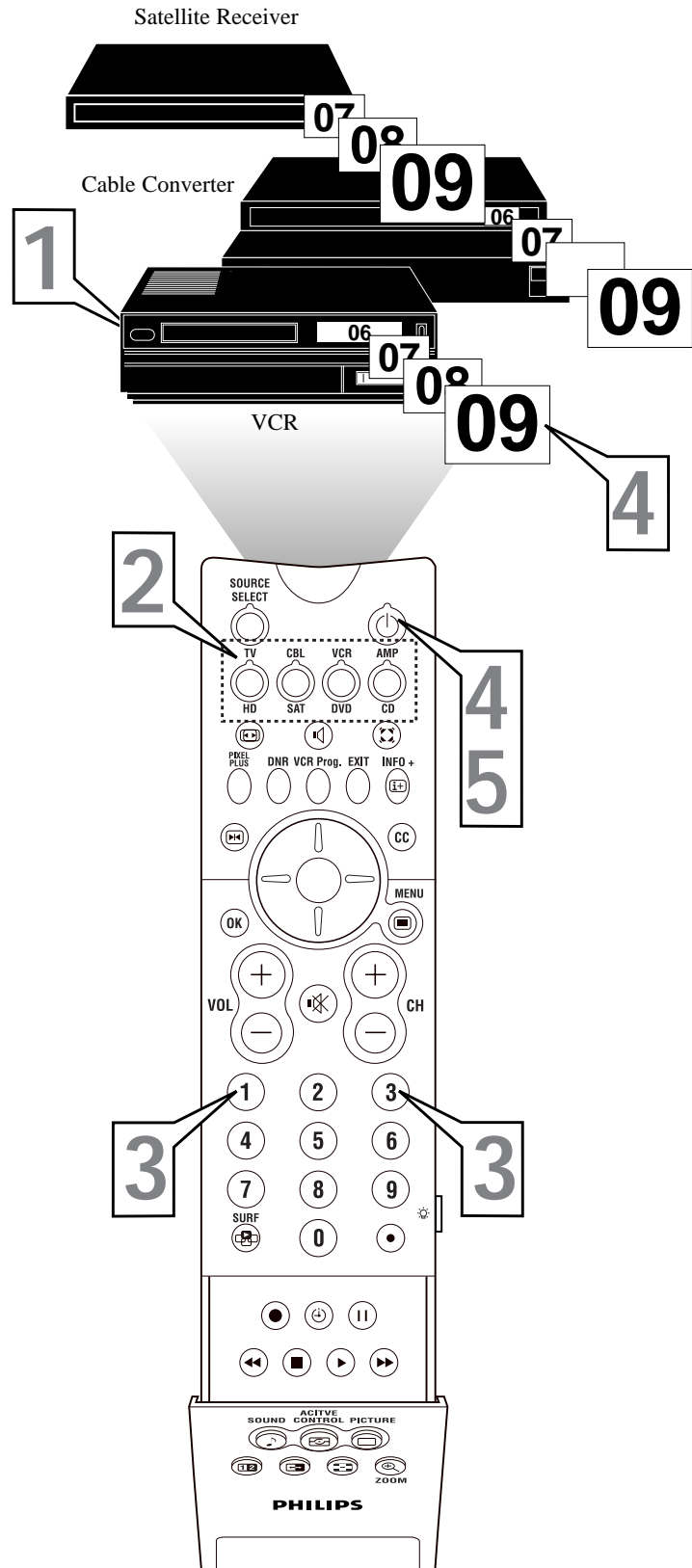



REMOTE CONTROL DIRECT ENTRY CODES FOR ACCESSORY DEVICES

Amplifiers Remote Code No.

Aiwa0433
 Carver0296
 Curtis Mathes0327
 Denon0187
 GE0105
 Harman/Kardon0919
 JVC0358
 Linn0296
 Magnavox0296
 Marantz0296, 0348
 Nakamichi0348
 Optimus0422
 Panasonic0335
 Philips0296, 0919
 Pioneer0040, 0327
 Realistic0422
 Sansui0348
 Sony0716, 0247
 Soundesign0105
 Technics0335
 Victor0358
 Wards0040, 0105
 Yamaha0381

Cable Remote Code No.

ABC0030, 0028, 0034, 0035, 0038,
0040, 0041, 0044
 Allegro0180, 0342
 Americast0926
 Antronix0049
 Archer0049, 0180, 0824
 Belcor0083
 Bell & Howell0041
 Cable Star0083
 Cabletenna0049
 Cableview0049
 Century0180
 Citizen0180, 0342
 Colour Voice0052
 Comtronics0067
 Contec0046
 Eastern0029
 Emerson0824
 Everquest0042, 0067
 Focus0427
 GC Electronics0083
 Garrard0180
 Gemini0042
 General Instrument0303, 0503, 0038, 0837
 GoldStar0067, 0171
 Goodmind0824
 Hamlin0047, 0036, 0286, 0061
 Hitachi0038
 Hytex0034
 Jasco0042, 0180, 0342
 Jerrold0030, 0039, 0303, 0041,
0038, 0503, 0042, 0837
 Memorex0027
 Movie Time0090
 NSC0090
 Oak0046, 0034
 Optimus0048
 Panasonic0048, 0134, 0027
 Paragon0027
 Philips0052, 0180
 Pioneer0171, 0560, 0904
 Popular Mechanics0427
 Pulsar0027
 Quasar0027

RCA0048
 Radio Shack0042, 0342, 0910, 0824
 Recoton0427
 Regal0047, 0286
 Regency0029
 Rembrandt0038
 Runco0027
 SL Marx0067
 Samsung0067, 0171
 Scientific Atlanta0035, 0044, 0504, 0904
 Signal0042, 0067
 Signature0038
 Sprucer0048
 Starcom0030, 0042
 Stargate0067, 0042, 0824
 Starquest0042
 Sylvania0028
 TV860090
 Tandy0285
 Teleview0067
 Texscan0028
 Tocom0039, 0040
 Toshiba0027
 Tusa0042
 Unika0180, 0049
 United Artists0034
 Universal0049, 0083, 0180, 0218
 Viewstar0285, 0090
 Zenith0027, 0552, 0926
 Zentek0427

CD Players Remote Code No.

Aiwa0184
 Burmester0447
 California Audio Labs0056
 Carver0184, 0206, 0464
 DKK0027
 Denon0030, 0900
 Emerson0332
 Fisher0201, 0206
 Garrard0420, 0447
 Genexxa0059, 0332
 Harman/Kardon0200, 0184
 Hitachi0059
 JVC0099
 Kenwood0055, 0217, 0853, 0064,
0653, 0708
 Krell0184
 LXI0332
 Linn0184
 MCS0056
 MTC0447
 Magnavox0184, 0332
 Marantz0184, 0056, 0207
 Mission0184
 NSM0184
 Nikko0201
 Onkyo0128, 0895
 Optimus0447, 0059, 0206, 0495,
0464, 0332, 0027, 0064, 0172
 Panasonic0056, 0330
 Parasound0447
 Philips0184, 0653
 Pioneer0059, 0495, 0271, 0332
 Proton0184
 QED0184
 Quasar0056
 RCA0080, 0332, 0206, 0791
 Realistic0206, 0207, 0447
 Rotel0184, 0447
 SAE0184

Sansui0184, 0332
 Sanyo0206
 Scott0332
 Sears0332
 Sharp0064, 0207, 0888
 Sherwood0207
 Sony0027, 0212, 0517
 Soundesign0172
 Tascam0447
 Teac0420, 0447, 0201, 0207
 Technics0330, 0056
 Victor0099
 Wards0080, 0184
 Yamaha0214, 0063
 Yorx0488

Receivers Remote Code No.

ADC0558
 Adcom0643
 Aiwa0148, 0432, 0185, 0216
 Akai0251, 0103
 Capetronic0558
 Carver0035, 0216, 0387, 0069
 Casio0222
 Clarinette0222
 Curtis Mathes0107
 Denon0031, 0798, 0300
 Emerson0451
 Fisher0069, 0246, 0387
 Garrard0451, 0490
 Harman/Kardon0137, 0216, 0918
 Inkel0089
 JBL0137
 JVC0101
 Kenwood0054, 0341, 0104, 0069,
0213, 0340
 Koss0451
 LXI0208
 Linn0216
 Lloyd's0222
 MCS0066, 0373
 Magnavox0216, 0418, 0558, 0155, 0222
 Marantz0216, 0155, 0066
 Modulaire0222
 NAD0347
 NEC0262
 Nakamichi0374, 0124
 Onkyo0162, 0407, 0127
 Optimus0208, 0204, 0213, 0246,
0558, 0765, 0828, 0069, 0697
 Panasonic0066, 0336, 0545
 Penney0222
 Philips0216, 0418
 Pioneer0107, 0041, 0177, 0558, 0657
 Quasar0066
 RCA0081, 0373, 0558, 0387, 0557
 Realistic0208, 0222, 0190
 Sansui0216, 0220, 0373
 Sanyo0246, 0828
 Scott0190, 0349
 Sharp0213
 Sherwood0529, 0518, 0089
 Sony0185, 0195, 0501
 Soundesign0697
 Teac0490, 0190
 Technics0336, 0066, 0235, 0545
 Victor0101
 Wards0081, 0041, 0107, 0185, 0216
 Yamaha0203, 0213
 Yorx0222
 Zenith0884



Satellite Remote Code No.

AlphaStar0799
 Amplica0099
 Amway0102
 Astro Industries0122
 BSR0122
 Capetronic0122
 Channel Master0045, 0239
 Chaparral0080, 0236, 0243
 Curtis Mathes0088, 0099
 DX Antenna0068
 Drake0091, 0272, 0045, 0176
 Echostar0307, 0802, 0175, 0186, 0296
 Expressvu0802
 General Instrument0388, 0896, 0654
 HTS0802
 Hitachi0846
 Homecable0265
 Hughes Network Systems0776
 Hytek0122
 IQ0237
 IQ Prism0237
 JVC0802
 Janeil0179
 Jerrold0388, 0654
 Legend0296
 Macom0088, 0045
 Magnavox0749, 0751
 Memorex0296, 0751
 Next Level0896
 Panasonic0179, 0728
 Philips0227, 0749, 0751
 Pico0102
 Primestar0654, 0388
 RCA0593, 0170, 0882
 Radio Shack0896
 Ramsey0102
 Realistic0079
 STS0237, 0068
 Sony0666
 Star Choice0896
 Star Trak0207
 Toshiba0109, 0817, 0088
 Uniden0265, 0079, 0101, 0397, 0751,
0103, 0749
 Zenith0091, 0883, 0088

VCR Remote Code No.

Admiral0075, 0236
 Adventura0027
 Aiko0305
 Aiwa0334, 0027, 0064
 Akai0133, 0068, 0088
 America Action0305
 American High0062
 Asha0267
 Audiovox0064
 Beaumark0267
 Bell & Howell0131
 Brocksonic0236
 Broksonic0148, 0211, 0029, 0236, 0506
 CCE0099, 0305
 Calix0064
 Canon0062
 Capehart0047
 Carver0108
 Cinerall0305
 Citizen0305, 0064
 Colt0099
 Craig0064, 0099, 0074, 0267, 0298
 Curtis Mathes0062, 0068, 0087, 0189
 Cybernex0267

Daewoo0305, 0588, 0047, 0072
 Dayton0047
 Denon0069
 Dynatech0027
 Electrohome0064
 Electrophonic0064
 Emerex0059
 Emerson0211, 0029, 0236, 0305,
0148, 0235, 0506, 0588,
0088, 0239, 0027, 0064, 0070
 Fisher0074, 0131, 0081
 Fuji0060, 0062
 Funai0027
 GE0062, 0087, 0075, 0229, 0267
 Garrard0027
 Go Video0459, 0553
 GoldStar0064, 0065
 Gradiente0035, 0027
 HI-Q0074
 Harley Davidson0027
 Harman/Kardon0065, 0108
 Harwood0099
 Headquarter0073
 Hitachi0069, 0132, 0027, 0068
 Hughes Network Systems0069
 JVC0094, 0035, 0068
 Jensen0068
 KEC0064, 0305
 KLH0099
 Kenwood0068, 0094, 0065
 Kodak0062, 0064
 LXI0064
 Lloyd's0027, 0235
 Logik0099
 MEI0062
 MGA0070, 0088, 0267
 MGN Technology0267
 MTC0027, 0267
 Magnasonic0305
 Magnavox0062, 0108, 0027, 0066, 0176
 Magnin0267
 Marantz0108, 0062
 Marta0064
 Matsushita0062, 0189, 0481
 Memorex0131, 0074, 0027, 0064, 0075,
0062, 0073, 0267, 1064, 0334,
0066, 0236, 1189, 1289
 Minolta0132, 0069
 Mitsubishi0070, 0088, 0075, 0094
 Motorola0062, 0075
 Multitech0027, 0099
 NEC0065, 0068, 0094, 0131
 Nikko0064
 Nikon0061
 Noblex0267
 Olympus0062
 Optimus1089, 1189, 0075, 1289, 0064,
1075, 0131, 0189, 0459, 0481
 Optonica0089
 Orion0506, 0029, 0211, 0236
 Panasonic0062, 1189, 0189, 0252,
0481, 0643
 Penney0062, 0267, 0064, 0069, 0065, 0081
 Pentax0069, 0132
 Philco0062, 0236, 0506
 Philips0108, 0062, 0089, 0645, 1108, 1208
 Pilot0064
 Pioneer0094
 Portland0047
 Profitronic0267
 Proscan0087, 0229
 Protec0099

Pulsar0066
 Quarter0073
 Quartz0073
 Quasar0062, 0189, 0481, 1189
 RCA0087, 0176, 0229, 0069, 0132,
0062, 0075, 0133, 0267
 Radio Shack0027, 1064
 Radix0064
 Randex0064
 Realistic0027, 0131, 0074, 0075, 0064,
0062, 0089, 0073
 ReplayTV0641, 0643
 Ricoh0061
 Runco0066
 STS0069
 Samsung0072, 0267
 Sanky0066, 0075
 Sansui0068, 0506, 0027, 0094, 0236, 0298
 Sanyo0074, 0073, 0131, 0267
 Scott0211, 0148, 0070, 0072, 0239
 Sears0081, 0132, 0064, 0069, 0027,
0062, 0073, 0074, 0131
 Semp0072
 Sharp0075, 0089
 Shintom0099
 Shogun0267
 Singer0099
 Sony0060, 0061, 0059, 0027, 0062
 Sylvania0062, 0108, 0027, 0070
 Symphonic0027
 TMK0235, 0267
 Tatum0068
 Teac0027, 0068
 Technics0062, 0189
 Teknika0027, 0062, 0064
 Thomas0027
 Tivo0645
 Toshiba0072, 0239, 0070
 Totevision0064, 0267
 Unitech0267
 Vector0072
 Vector Research0065
 Video Concepts0072, 0088
 Videosonic0267
 Wards0062, 0087, 0089, 0027, 0074, 0239,
0267, 0069, 0075, 0099, 0108, 0176
 White Westinghouse0305, 0236
 XR-10000099, 0027, 0062
 Yamaha0065
 Zenith0066, 0027, 0060, 0061, 0236, 0506

Digital Video Disc Remote Code No.

Harman/Kardon0609
 JVC0650, 0585
 Kenwood0561
 Magnavox0530
 Mitsubishi0548
 Onkyo0654, 0530
 Panasonic0517, 0659
 Philips0530, 0566
 Pioneer0598, 0552, 0659
 Proscan0549
 RCA0549
 Samsung0600
 Sharp0657
 Sony0560
 Technics0517
 Theta Digita0598
 Toshiba0530
 Yamaha0517, 0572
 Zenith0618, 0530



SPECIFIC REMOTE CONTROL VCR BUTTONS

When using the TV remote control with a VCR, first make certain it is set to control your VCR (by the CODE ENTRY or SEARCH method).

- 1 Press the VCR mode button.** Be sure the button lights green.
- 2 Point the top of the remote** toward the front of the VCR (remote sensor window) when pressing the buttons.

VCR Mode Button

Press button to place the remote in a mode to control a VCR.

VCR Prog. Button

Many VCRs have an automatic programming function. If your VCR has this feature, when the remote is programmed, the code for this function will be assigned to this button.

Play Button ▶

Press to begin playback of a videotape.

• (Record) Button

Hold the • (Record) and PLAY ▶ buttons down to begin a VCR recording.

Stop Button ■

Press to stop the motion of a tape in playback, rewind, fast forward, and so on.

Rewind Button ◀◀

Press to rewind tapes. For some VCR's, the STOP button may have to be pressed first, then REWIND. In playback mode, hold down the button to view the picture moving rapidly in reverse.

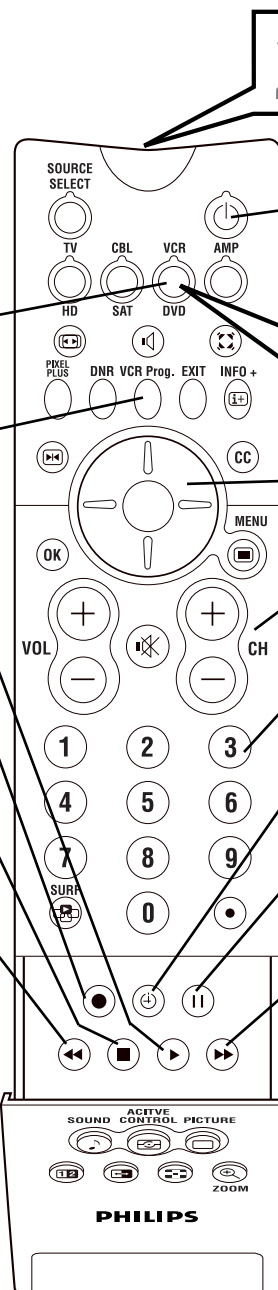

Power Button

Press to turn the VCR ON and OFF.

Cursor Up/Down/Left/Right

Press to navigate the VCR onscreen customer controls.

Channel + and - Buttons

Press to scan up or down through the VCR channel numbers.

Number Buttons

Press buttons for the direct selection of VCR channels.

VCR Timer Button

Press button to set up a timer recording within the VCR onscreen menu.

Pause Button ||

Press to temporarily stop the tape during a playback or recording. Press again to release Pause.

Fast Forward Button ▶▶

Press to rapidly advance the tape. For some VCRs, you may need to press the STOP button first, then the FAST FORWARD button. In playback mode, hold the button down to view the picture moving rapidly in the forward direction.

HELPFUL HINT

Remember, the VCR buttons on the remote will not operate your VCR if those features are not found on your VCR remote control.

NOTE: All VCR functions (particularly Search, Rewind, Fast Forward, etc.) will operate the same as with the original VCR remote control provided with the VCR.



No Power

- Check the TV power cord. Unplug the TV, wait 10 seconds, then reinsert the plug into the outlet and push the POWER button again.
- Check that the outlet is not on a wall switch.
- Be sure the fuse is not blown on the AC power strip, if one is being used.

No Picture

- Check antenna connections. Are they properly secured to the TV's ANT 75Ω plug?
- Check the TUNER MODE control for the correct tuner setting.
- Try running the Auto Program feature to find all available channels.
- Press the Source Select button on the remote to make sure the correct signal source is selected (FRONT or Current Channel).

No Sound

- Check the VOLUME buttons.
- Check the MUTE button on the remote control.
- If you're attempting to hook up auxiliary equipment, check the audio jack connections located on the front of the TV.

Remote Does Not Work

- Make sure the correct Mode button is being used.
- Check the batteries. If necessary, replace them with AA Heavy Duty (Zinc Chloride) or Alkaline batteries.

Remote Does Not Work (Continued)

- Clean the remote control and the remote control sensor window on the TV.
- Check the TV power cord. Unplug the TV, wait 10 seconds, then reinsert the plug into the outlet and push the POWER button again.
- Be sure the fuse is not blown on the AC power strip, if one is being used.
- Check to be sure the TV outlet is not on a wall switch.

TV Displays Wrong Channel or No Channels Above 13

- Repeat channel selection.
- Add the desired channel numbers (using the CHANNEL EDIT control) into the TV's memory.
- Check to be sure the TUNER MODES are set to the CABLE option and run the Auto Program feature to find all available channels.

TV Displays white lines in letterbox when viewing a DVD disc

- Some DVD Discs are encoded with as much as 30% more video information to give the best possible picture quality. With the DVD Player in the 16:9 picture format, the playback of this type of disc with extra video information, can produce a number of small white lines in the upper portion of the black letterbox area. With some of these discs, this situation is unavoidable and it does not require a service call.

CARE AND CLEANING

WARNING Concerning Stationary Images on the TV Screen:

Do not leave stationary or letterbox images on screen for extended periods of time. This can cause uneven picture-tube aging.

Normal use of the TV should involve the showing of pictures that contain constantly moving and changing images that fill the screen. Be careful not to leave nonmoving images on screen for extended periods of time, or to display the same images on screen too frequently, because subtle ghost images can be left on the picture tubes. Sources of stationary images may be DVD disks, laser disks, video games, CD-i disks, videotapes, digital television boxes, broadcast channels, cable channels, satellite channels, and others. **Here are some examples of stationary images (this is not an all-inclusive list; you may encounter others in your viewing):**

- **DVD menus**—listings of DVD disk content
- **Letterbox black bars**—shown at the top and bottom of the TV screen when a wide screen (16:9) movie is viewed on a TV with standard (4:3) aspect ratio.
- **Video-game images and scoreboards**
- **Television station logos**—present a problem if they are bright and stationary; moving or low-contrast graphics are less likely to cause uneven aging of the picture tube
- **Stock-market tickers**—presented at the bottom of the TV screen
- **Shopping channel logos and pricing displays**—bright and shown constantly or repeatedly in the same location on the TV screen.

PLACEMENT OF THE TV

- To avoid cabinet warping, cabinet color changes, and increased chance of set failure, do not place the TV where temperatures can become excessively hot; for example, in direct sunlight or near a heating appliance.
- Be sure to allow a free flow of air to and from the perforated back cover of the set.

CLEANING

- To avoid possible shock hazard, be sure the TV is unplugged from the electrical outlet before cleaning.
- Regularly dust the TV with a dry, nonscratching duster to keep the TV clean.
- When cleaning the TV, take care not to scratch or damage the screen surface. Avoid wearing jewelry or using anything abrasive. Do not use household cleaners. Wipe the front screen with a clean cloth dampened with water. Use even, easy, vertical strokes when cleaning.
- Gently wipe the cabinet surfaces with a clean cloth or sponge dampened in a solution of cool, clear water and a mild soap or detergent. Use a clean, dry cloth to dry the wiped surfaces.
- Occasionally vacuum the ventilation holes or slots in the back cover of the set.
- Never use thinners, insecticide sprays, or other chemicals on or near the cabinet, as they might cause permanent marring of the cabinet finish.



Active Control • Active Control continuously measures and corrects the incoming signals to provide the best picture possible.

Alternate Channel • Allows you to toggle between the last two channels viewed by pressing the A/CH button on the remote control.

Aspect Ratio • The proportions of a rectangular display screen. NTSC television has a 4:3 ratio; HDTV has a 16:9 ratio.

Audio/Video Inputs • Jacks (standard RCA), located on the back of the TV, used for external accessory devices. These jacks are designed to receive higher picture resolution and offer sound-connection options.

Auto Picture and Auto Sound • Buttons on the remote control (Sound and Picture) to select predefined picture and sound settings.

Auto Programming • When activated, this feature scans for all available channels from regular antenna or cable signals and stores only active broadcast stations in the TV's memory.

Channel Edit • The feature that allows you to add or delete channels from the list of channels stored in the TV's memory.

Closed Captioning • The broadcast standard feature that allows you to read the voice content of television programs on the TV screen. Designed to help the hearing impaired, Closed Captioning shows dialogue and conversations while a TV program is in progress.

Coaxial Cable • A single solid wire normally matched with a metal plug (F-type) end connector that screws (or pushes) directly onto a 75-ohm input found on the television or VCR.

Component Video Inputs • Inputs that allow the separate reception of blue, red, and luminance signals. These inputs provide the highest possible color and picture resolution in the playback of digital signal-source material, such as the kind available from DVD players.

Composite Video Input • An input in which all the components required for displaying the onscreen image are combined in one signal.

High-definition Television (HDTV) • High-resolution digital television.

Incredible Stereo (or Surround) • False acoustic management of the audio signal that produces a dramatic expansion of the wall of sound that surrounds the listener and heightens overall viewing pleasure.

Menu • An onscreen list of feature controls available for you to adjust or set.

NTSC (analog video signals) • National Television Standards Committee format devised to TV broadcasting signals in the 1940s (525 lines: 60Hz).

Onscreen Displays (OSD) • The wording or messages generated by the television (or VCR) to help you with specific feature controls (color adjustment or programming, for example).

Pixel Plus improves picture quality and definition by increasing the number of picture lines and the number of pixels per line to give normal broadcast signals, DVD reproduction or Digital TV signals, unparalleled sharpness and depth. Gives near High Definition and natural looking detail without the High Definition signal.

Picture Freeze • TV mode which allows you to freeze a certain image in order to study a specific detail at ease, e.g. to make notes of certain program information like phone numbers.

Progressive Scan • Double the number of visible picture lines per field. A jitter-free and quiet picture with astonishing sharpness.

Remote Control Sensor Window • The window or opening found on the television control panel through which infrared remote control command signals are received.

Second Audio Program (SAP) • An additional audio channel provided for in the Multichannel Television Sound (MTS) broadcast standard. A monaural soundtrack included within the recorded or video signal (usually containing a second language translation for the displayed programming).

Status/Exit Button • The remote control function that allows you to quickly confirm what channel number you are watching. Status/Exit can also be used to clear the television of onscreen displays or information. You can use Status/Exit rather than having to wait for the displays to "time out," or automatically disappear from the screen.

Surround Pro Logic • Literally wraps you in 4-channel sound. It brings your favorite movies to life with all the realism and impact of cinema sound as though you are part of the action or viewing your programming from the theatre.

S-Video Input • Signal input that allows direct connection of high-resolution video sources, such as a satellite receiver, DVD player, S (Super)-VHS videocassette recorder, or video games. Provides improved picture resolution, sharpness, and clarity.

Tint • TV function that allows you to change the general color balance between cool and warm. Adjust tint according to your personal preference.



3D Surround Effect Control28	Freeze Control48
Active Control53	Glossary of Terms60
Alternate Audio Control26	Headphone Volume Control24
Antenna Attenuator Control41	Index61
Audio/Video Input/Output Jacks		Lock After Control37
Audio Outputs15	Menu Background Control44
AV1 Inputs7	Minimize/Maximize OSD Control50
AV2 Inputs8	Movie Ratings Lock Control39
AV3 Inputs10	MultiPIP Control47
AV4 Inputs11	On-Timer Control34
Component Video Inputs (CVI)12	Picture Format Control22
Monitor Outputs14	PIN (Personal Identification Number)51
S-Video Inputs13	Pixel Plus Control17
Side A/V Inputs9	Progressive Scan Control17
Auto Picture Control21	Registration Information2-3
Auto Sound Control31	Remote Control Programming for Accessory Devices	
AV Source Labels52	Auto Search Method55
AVL (Automatic Volume Leveler)29	Code-Entry Method54
Brightness Control16	Direct-Entry Code List56-57
Cable and Input Jack Descriptions6	Remote Control VCR Button Descriptions58
Care and Cleaning59	Resetting the AV Settings Control49
Center (Speaker) Mode Control43	Safety/Precautions2-3
Channel List Control35	Sharpness Control16
Channel Lock Control36	Sleeptimer Control33
Channel Remove Control40	Sound Mode Control25
Closed Captions Control32	Speaker Trim Controls42
Contrast Control16	Stereo/Mono Sound Control27
Color Control16	Surf (2 channel and 9 channel) Control45
Color Enhancement Control20	Surround Speakers Control43
Color Temperature Control16	Test Tone Control42
Daylight Savings Control50	Tilt Adjust Control49
Delta Volume Control30	Time Zone Control50
Digital Processing Control17	Tint Control16
DNR (Dynamic Noise Reduction)19	Troubleshooting Tips59
Dual Screen Format Control46	TV Ratings Lock Control38
Dynamic Contrast Control18	Volume Control23
Equalizer Control24	Warranty (Limited)62
Feature Highlights5	Zoom Control53

**RENEWED
90 DAY
LIMITED WARRANTY**

Free Manuals Download Website

<http://myh66.com>

<http://usermanuals.us>

<http://www.somanuals.com>

<http://www.4manuals.cc>

<http://www.manual-lib.com>

<http://www.404manual.com>

<http://www.luxmanual.com>

<http://aubethermostatmanual.com>

Golf course search by state

<http://golfingnear.com>

Email search by domain

<http://emailbydomain.com>

Auto manuals search

<http://auto.somanuals.com>

TV manuals search

<http://tv.somanuals.com>