

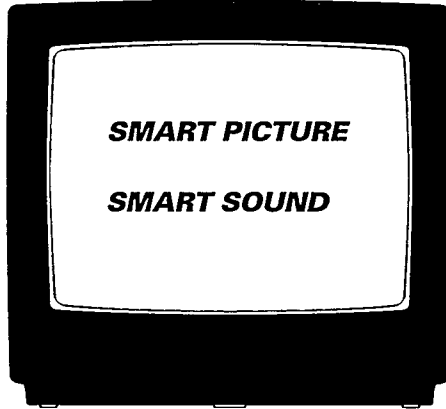

# PHILIPS



**PAL/SECAM**

<b>14GX8310</b>	<b>14GX8510</b>	<b>14GX8512</b>
<b>20GX8350</b>	<b>20GX8550</b>	<b>20GX8552</b>

## OPERATING INSTRUCTIONS

English

Español

Русский  
Бразильский

## Safety Information

Disconnect mains plug when :

- the RED light below the screen is flashing continuously.
- a bright white line is displayed across the screen.
- cleaning the TV screen. Never use aggressive cleaning agents. Use a slight damp chamois leather.
- there is a lightning storm.
- the set is left unattended for an extended period of time.

**CAUTION:** Never attempt to repair a defective TV yourself. Always consult a skilled service personnel.

Switch off your TV overnight via the POWER ON/OFF button instead of leaving it on stand-by. You save energy and at the same time demagnetise the picture tube. A demagnetised picture tube supports good picture quality. When the set is switched on, do not shift, move or turn (e.g. on a swivel base) the set around because an unevenness in colour in some parts of the screen may occur. This can be eliminated by switching off the set by the mains power button . Wait for 20 minutes before switching on again. If symptom still exists, call for service.

## Before Calling For Service

Please make these simple checks before calling for service.

SYMPTOM	CHECK/ACTION
Colour patch (unevenness)	• Switch off TV by the mains power button. Wait for 20 minutes before switching on again.
No power	• Check TV's AC power cord is plugged into mains socket. If there is still no power, disconnect plug. Wait for 60 seconds and re-insert plug. Switch on TV again.
No picture	• Check antenna connection at rear of the TV. • Possible faulty TV station. Try another channel. • Increase the contrast setting first and then the brightness setting.
Good picture but no sound	• Try increasing the volume. • Check sound is switched on.
Good sound but poor or abnormal colour or no picture	• Increase the contrast setting first and then the brightness setting.
Snowish picture and noise	• Check antenna connection at rear of the TV.
Horizontal dotted lines	• Possible electrical interference( e.g. hairdryer, nearby neon lights, etc). Switch off equipment.
'Ghosts' or double image	• Possible poor positioning of antenna. Using a highly directional antenna may improve reception.
One white line across the screen	• Switch off set immediately and consult service personnel.
TV not responding to remote control handset	• Check life span of batteries. • Aim remote control handset directly at remote control sensor lens on the TV set.

## Safety Information

### Positioning of the TV

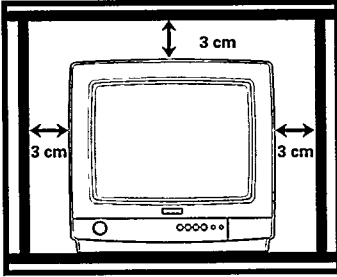

- Place TV set on a solid base (e.g. a TV/video cabinet)
- Leave at least 3 cm around each side of TV set for ventilation to avoid over-heating.
- Do not place TV set near a radiator or other sources of heat.
- Do not place TV set where it can be exposed to rain or excessive moisture.

English

### Power Connection

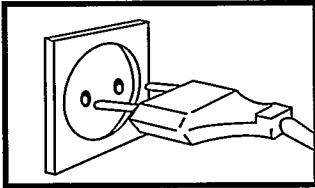

- For correct mains voltage, refer to Specification page.
- Consult your dealer if mains supply is different.

**NOTE :**

This plug is not representative of the actual plug and socket.

### Care of Remote Control handset

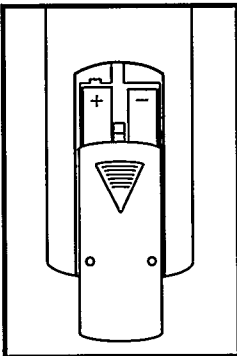

- Always remove the batteries from the remote control handset if handset is not used for a long period. This can help prevent damage to handset from possible battery leakage.

# PRE-INSTALLATION

English

## ANTENNA CONNECTION

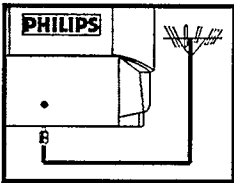
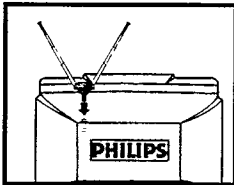

- For indoor antenna, attach it to the mounting socket of the backcover.
- Connect aerial plug to the antenna socket **T** on the backcover.
  
- For external antenna, connect the aerial plug to the antenna socket **T** on the backcover.

## PERIPHERAL EQUIPMENT CONNECTION

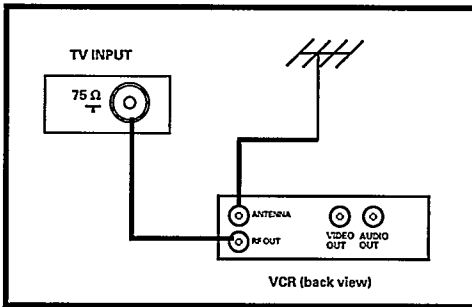

- Connect antenna to Antenna RF Input of VCR.
  
- Connect RF cable from RF Output of VCR to the Antenna Input **T** of the TV.

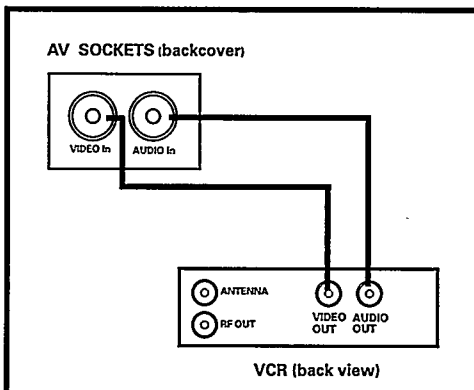

- Connect the VIDEO in and AUDIO in sockets of the TV to the VIDEO out and AUDIO out sockets of the VCR for playback programmes. (Applicable to sets with AV mode only)

# NAME AND FUNCTION OF CONTROLS

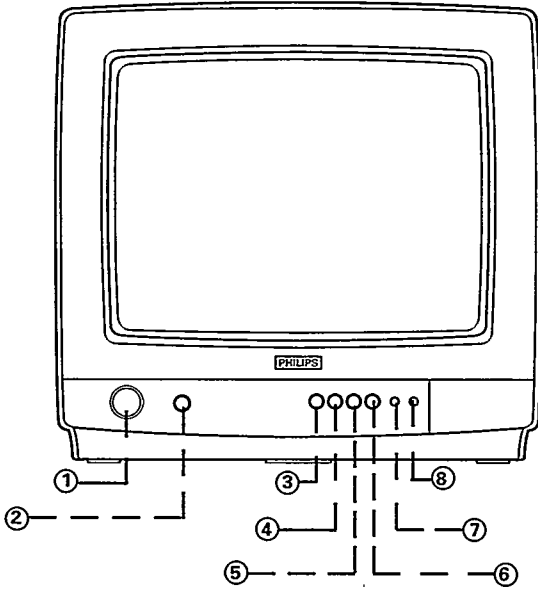

## FUNCTIONS OF TV

①	Main Power button	Turns main power on and off.
②	Headphone socket	Connects headphone jack to socket for personal listening. (Applicable for certain models/versions only)
③	Volume Down button	Adjusts sound volume softer.
④	Volume Up button	Adjusts sound volume louder.
⑤	Channel Down button	Selects channel backward.
⑥	Channel Up button	Selects channel forward.
⑦	Stand-by light indicator	Indicates red light when stand-by is on.
⑧	Remote Sensor	Aim remote control here.

# NAME AND FUNCTION OF CONTROLS

## FUNCTIONS OF REMOTE CONTROL

English

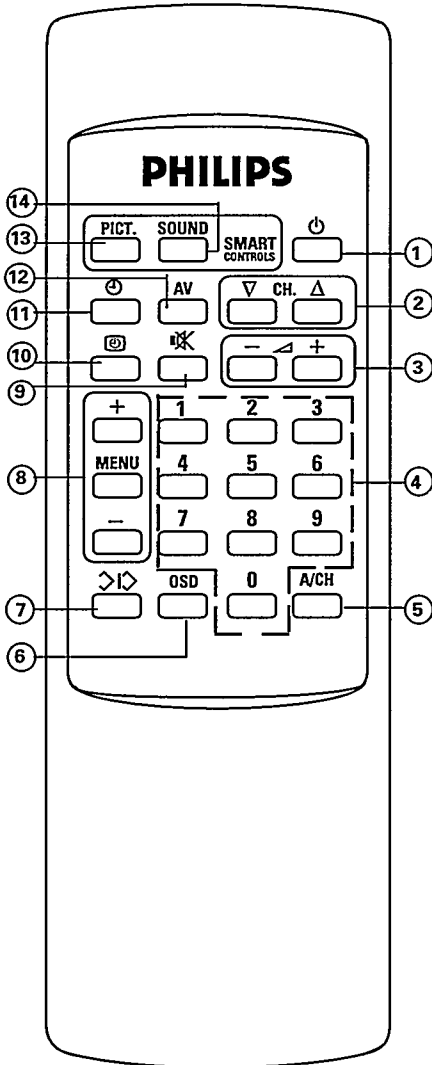





①	Stand-by button	Turns TV on and off when main power is on.
②	Channel Up/Down button	Selects channels preset on programme number.
③	Volume Up/Down button	Adjusts sound volume louder or softer.
④	Digit (0 - 9) button	Selects channel directly. Press desired number to select(one digit). For two-digit channel number, press the first digit followed by the second digit.
⑤	Alternate channel button	Alternates last viewed channel and present channel.
⑥	On Screen Display button	Displays channel number and sleep-timer.
⑦	Install button	Starts installation menu and store new settings.
⑧	Menu and Menu Up/Down button	Selects and start the various menu.
⑨	Mute button	Mutes sound temporarily.
⑩	On-Timer button	Not applicable.
⑪	Clock button	Not applicable .
⑫	AV button	For AV playback programmes. (For sets with AV mode).
⑬	Smart Picture button	Allows you a choice of 4 picture settings.
⑭	Smart Sound button	Allows you a choice of 4 sound settings.



# INSTALLATION

## HOW TO START MANUAL INSTALLATION



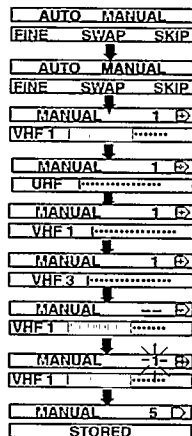

- Step 1 • Press  button to start installation menu and press  button again to highlight MANUAL menu.
- Step 2 • Press MENU button to start MANUAL mode.
- Step 3 • Press MENU — button to select either UHF 1, VHF 1 or VHF 3 band.
- Step 4 • Press MENU + button to start MANUAL installation.
- Step 5 • Enter your preference number for that available channel once a blinking channel number appears.
- Step 6 • Press  button to store channel number.
- Step 7 • Repeat Step 3 to Step 5 to install other channels.
- Step 8 • Press  button to exit from menu.



English

## HOW TO DO FINE TUNING

To achieve optimum picture and sound quality, you can use the FINE TUNING feature to adjust the picture and sound quality.

- Step 1 • Select the channel which you want to fine tune.
- Step 2 • Press  button to start installation menu. and press  button until FINE is highlighted.
- Step 3 • Press MENU button to start FINE mode.
- Step 4 • Press and hold MENU + or — button until the desired picture and sound is obtained. A blinking channel number will then appear on the screen.
- Step 5 • Press  button to store new setting. Repeat all the above steps if you wish to do a fine tuning for other channels.
- Step 6 • Press  button to exit from menu.

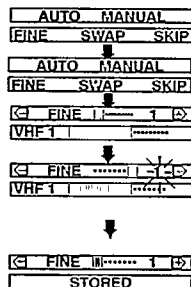







# INSTALLATION

## HOW TO SWAP CHANNEL NUMBERS



You can change the channel number to your choice for a particular TV station. Select the **SWAP** feature in the installation menu to re-arrange the TV stations according to the channel numbers of your choice.

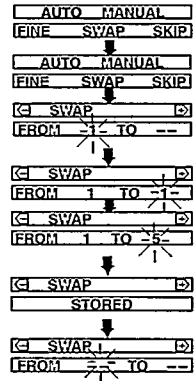

- Step 1** • Select the channel which you want to swap.
- Step 2** • Press  button to start installation menu. Press  button until **SWAP** is highlighted.
- Step 3** • Press **MENU** button to start **SWAP** mode. The current channel is flashing and is indicated in the **FROM** column.
- Step 4** • Press **MENU +** button to select the **TO** column. Enter the channel number you want to swap here.
- Step 5** • Press  button to start **SWAP** function to store the swapped channels. After the swapped channel is stored, the **FROM** " -- " and **TO** " -- " symbol will appear immediately. If you want to continue swapping other channel, enter the channel number in the **FROM** " -- " column and the other channel that you want to swap to in the **TO** " -- " column.
- Step 6** • Press  button again to exit from menu.



English

## HOW TO SKIP CHANNEL NUMBERS

This feature allows you to skip those channels which have bad or weak TV station signal by the **CHANNEL**  or  button on the remote control.

- Step 1** • Press  button to start installation menu. Press  button until **SKIP** is highlighted.
- Step 2** • Press **Menu** button to start **SKIP** mode.
- Step 3** • Press **Digit** button to select the channel you want to skip.
- Step 4** • Press **Menu +** button to select **YES**. The skipped channel will display a "x" on the top left hand of the channel number, e.g. \*10.
- Step 5** • Repeat **Step 3** and **4** to skip other selected channels.
- Step 6** • Press  button to exit from menu.

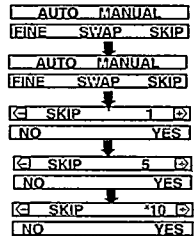

**NOTE :** Skipped channels can still be selected by pressing the digit button.

## HOW TO ADD BACK THE SKIPPED CHANNEL NUMBERS

- Step 1** • Repeat **Step 1** to **Step 4** .(As in "How To Skip Channel Numbers")
- Step 2** • Press **MENU -** button to select **NO** and the channel will be added to the memory. The "x" on the top left hand of the channel number will disappear. Press  button to exit from menu.

## MENU OPERATION

The Picture and sound settings are pre-set for ideal viewing.

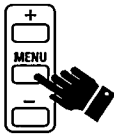

- Step 1 • Press **MENU** button to start menu.
- Step 2 • Press **MENU** button repeatedly to cycle through menu.
- Step 3 • Press **MENU** **+** or **-** to increase or decrease setting.

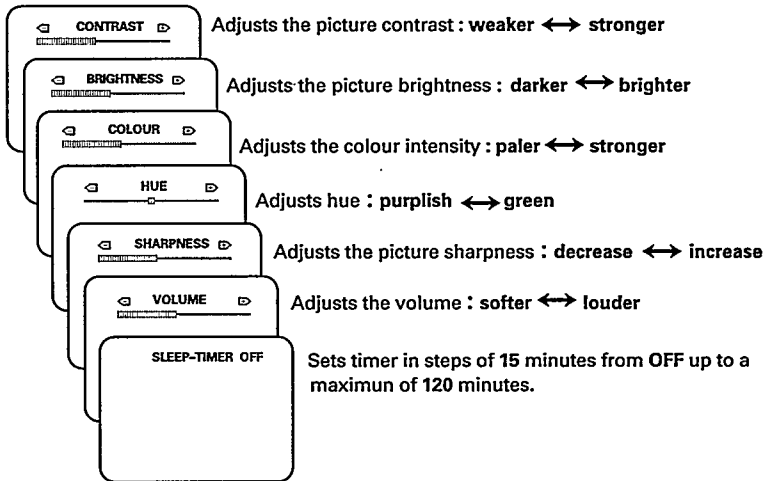

- NOTE**
- Hue adjustment is applicable to NTSC playback programmes only.
  - Last viewed/selected function will appear if menu operation is activated again.

### SLEEP-TIMER

This feature allows you to select a time period after which the set will switch to stand-by automatically. You can set the timer in steps of 15 minutes from OFF mode up to a maximum of 120 minutes.

- Step 1 • Press **MENU** button to start menu.
- Step 2 • Press **MENU** button again until **SLEEP-TIMER** function is selected.
- Step 3 • Press **MENU** **+** or **-** to select a time period.

### 12 PERSONAL PREFERENCE SETTINGS

- For programme number 0 to 10, you can make adjustment to picture settings to suit your preference. Adjusted picture settings for each programme number will be stored automatically under **PERSONAL** mode. (Refer to the next page on how to made adjustment to your preferred setting).
- Adjusted volume level setting for programme 0 to 10 is also stored automatically.
- Each programme number (0 to 10) will therefore has its Personal Preference Setting for picture and volume level.
- For AV mode (if any), you can also store your personal preference setting for picture and volume level.
- For programme number 11 to 69, personal preference setting for picture and volume level will be common. If any adjustment is made to the picture and volume setting, (for example, programme number 18), all the programme numbers from 11 to 69 will follow the picture and volume level setting of channel number 18.

## SMART CONTROLS

### SMART PICTURE CONTROLS

Smart Picture offers you a choice of 4 picture settings – PERSONAL, RICH, NATURAL and SOFT

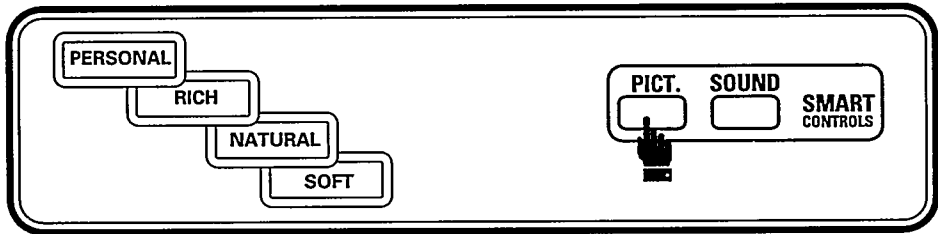

#### Definition of Picture Settings

- PERSONAL** : Picture Settings are set to your preference.
- RICH** : Emphasize very vibrant colours. (Suitable for AV mode in brightly-lit room condition)
- NATURAL** : Emphasize original colours.
- SOFT** : Emphasize "warm" colours. (Suitable for dimly-lit room condition and gives cinema-like effect when light is switched off)

Adjustment can be made to the picture settings to suit your preference and stored under PERSONAL mode through the menu operation.

- Step 1 • Select channel you want for picture and sound adjustment.
- Step 2 • Press **MENU** button to start menu.
- Step 3 • Press **MENU** button repeatedly to cycle through menu and select menu items.
- Step 4 • Press **MENU** + or – to increase or decrease setting.
- Step 5 • Press  button to exit.

**NOTE** : The new settings will be stored in the PERSONAL mode in the SMART CONTROLS menu.

### SMART SOUND CONTROLS

Smart Sound offers you a choice of 4 settings – THEATRE, MUSIC, VOICE and NORMAL.

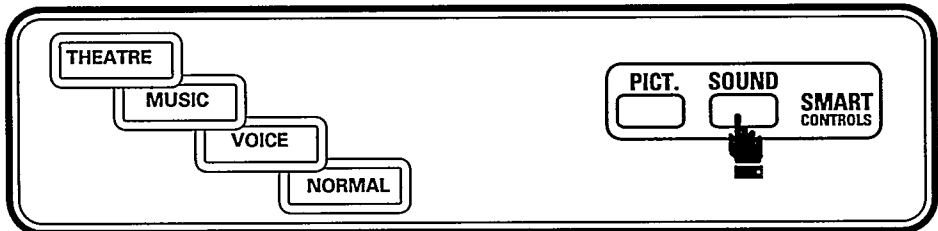

#### Definition of Sound Settings

- THEATRE** : Emphasize sensation to action. (Bass and Treble Boosted)
- MUSIC** : Emphasize low tone (Bass boosted)
- VOICE** : Emphasize high tone. (Treble boosted)
- NORMAL** : Emphasize normal tone. (No boosting)

# SPECIFICATION

English

	14GX8310	14GX8510	14GX8512	20GX8350	20GX8550	20GX8552
<b>Pix Tube Size</b>	14" (34 cm)			20" ( 48 cm)		
<b>Audio Output</b>	3 W Front Firing Speaker					
<b>Tuning System</b>	VST					
<b>Headphone Connection</b>	Ø 3.5 mm (Applicable to certain models/versions)					
<b>Rear Cconnection</b>	Nil	AV In	AV In	Nil	AV In	AV In
<b>Packed Set Dimensions :</b> Width Height Depth	44.5 cm 41 cm 45 cm			58.5 cm 55.5 cm 57 cm		
<b>Antenna Assembly</b>	Rod Aerial	300/75 ohm adaptor		Nil		
<b>Power Consumption</b>	38W			52W		
<b>Weight (without packaging)</b>	8.6 kg			18.4 kg		

		VERSIONS					
		50	52	57	58	59	75
<b>TV System</b>	<b>PAL B/G/H</b>	x	x				x
	<b>PAL I</b>			x			
	<b>PAL/SECAM B/G/D/K</b>				x	x	
	<b>PAL 60 Playback</b>	x	x	x	x	x	x
<b>Operating Voltage</b>	<b>100 – 250 V ~, 50/60 Hz</b>					x	
	<b>170 – 250 V ~, 50/60 Hz</b>	x	x	x	x		
	<b>230 – 240 V ~, 50/60 Hz</b>						x

## Free Manuals Download Website

<http://myh66.com>

<http://usermanuals.us>

<http://www.somanuals.com>

<http://www.4manuals.cc>

<http://www.manual-lib.com>

<http://www.404manual.com>

<http://www.luxmanual.com>

<http://aubethermostatmanual.com>

Golf course search by state

<http://golfingnear.com>

Email search by domain

<http://emailbydomain.com>

Auto manuals search

<http://auto.somanuals.com>

TV manuals search

<http://tv.somanuals.com>