



14PT2001

## Operating Instructions



*Let's make things better.*



**PHILIPS**



## TABLE OF CONTENTS

### Introduction

Safety Information/Useful Tips .....	3
Before Calling Service .....	4

### Basic Installation/Functions

Hooking Up Your TV (Basic Connection) .....	5
Use/Care of remote Control .....	5
Connecting the Audio/Video Sockets (Playback) .....	6
Functions of Remote Control .....	7
Functions of TV Controls .....	9

### TV Installation

Selecting the Menu Language.....	10
Automatic Tuning of Channels .....	11
Manual Tuning of Channels .....	12
Selecting the Colour/Sound System .....	14
Fine Tuning Of Channels .....	15
Sorting of Channels.....	16
Editing of Channels.....	17
Naming of Channels.....	18

### Features

Adjusting the TV Picture .....	19
Adjusting the TV Sound .....	20
Using the Timer.....	21
Activating the Child Lock.....	23
Using the Screen Format .....	27
Smart Picture Control .....	28
Smart Sound Control.....	29
Personal Zapping .....	30

### General

Specifications.....	31
---------------------	----



Recycling Directive – To minimise harm to the environment, the batteries supplied with the TV set do not contain mercury or nickel cadmium. If possible, when disposing of batteries, use recycling means available to you. Your TV set uses materials which are reusable or which can be recycled. To minimise the amount of waste in the environment, specialist companies recover used sets for dismantling and collection of reusable materials (contact your dealer).



## SAFETY INFORMATION AND USEFUL TIPS

### Safety Information

- Disconnect mains plug when :
  - the red light below the TV screen is flashing continuously.
  - a bright white line is displayed across the screen.
  - cleaning the TV screen. Never use abrasive cleaning agents. Use a slight damp chamois leather or soft cloth.
  - there is a lightning storm.
  - the set is left unattended for a prolonged period of time.
- No naked flame sources, such as lighted candles, should be placed on top of the TV or in the vicinity.
- Do not place your TV set under direct sunlight or heat.
- Leave at least 5 cm around each side of TV set to allow for proper ventilation.
- Avoid placing your set (e.g. near the window) where it is likely to be exposed to rain or water.
- No objects filled with liquids should be placed on top the TV so as to avoid dripping or splashing of liquids on the set.

### Useful Tips

- Do not leave your set on standby mode for a prolonged period of time. Switch off set to allow it to be demagnetised. A demagnetised set supports good picture quality.
- Do not shift or move the set around when it is switched on. Unevenness in colour in some parts of the screen may occur.
- Never attempt to repair a defective TV yourself. Always consult a skilled service personnel.



## BEFORE CALLING SERVICE

Below is a list of frequently occurred symptoms. Before you call for service, make these simple checks. Some of these symptoms can easily be rectified if you know what to do.

### Symptom

### What you should do

Colour patch  
(unevenness)

- Switch off the TV by the mains power button. Wait for 20 minutes before switching on again.
- Check the TV is not placed too near speakers or magnetic objects.

No power

- Check the TV's AC power cord is plugged into the mains socket. If there is still no power, disconnect plug. Wait for 60 seconds and re-insert plug. Switch on the TV again.

No picture

- Check the antenna connection at the rear of the TV.
- Possible TV station problem. Try another channel.

Good picture  
but no sound

- Try increasing the volume.
- Check that the sound is not muted. If it is muted, press the **Mute** button on the remote control to restore sound.

Good sound but poor  
colour or no picture

- Try increasing the contrast and brightness setting.

Snowish picture and  
noise

- Check antenna connection at the rear of the TV.

Horizontal dotted lines

- Possible electrical interference e.g. hairdryer, vacuum cleaner, etc. Switch off appliances.

Double images or  
"Ghost" images

- Possible poor positioning of antenna. Using a highly directional antenna may improve reception.

TV not responding to  
remote control handset

- Check life span of batteries of remote control handset.
- Aim remote control handset directly at remote control sensor lens on the TV.



## HOOKING UP YOUR TV (BASIC CONNECTION)

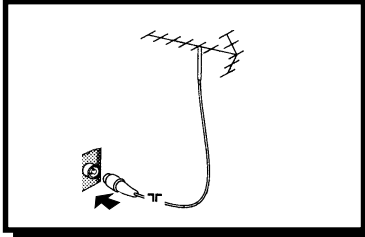

### Antenna Connection

- Connect the aerial plug to the antenna socket **T** on the backcover.
- Insert the mains plug into the wall socket.

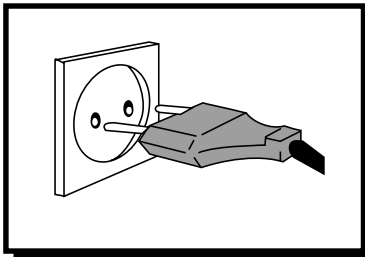

### Mains Connection

- For correct mains voltage, refer to type sticker at the rear of the TV set
- Consult your dealer if mains supply is different.  
**Note** : This diagram is not representative of the actual plug and socket.

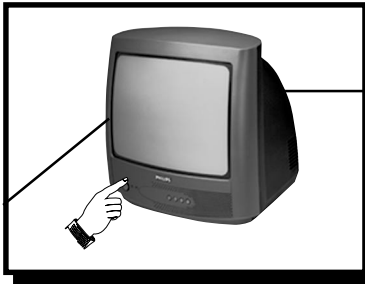

### Switching on the Set

- Press the main power button to switch on/off the TV.
- If the set is on standby (indicator is red), press the **Power** button on the remote control to switch on set.

## USE/CARE OF REMOTE CONTROL

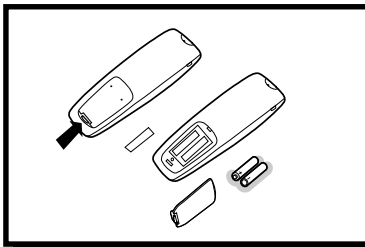

- Insert the correct type of batteries into the compartment.
- Ensure the batteries are placed in the right direction.



## CONNECTING THE AUDIO/VIDEO SOCKETS (PLAYBACK)

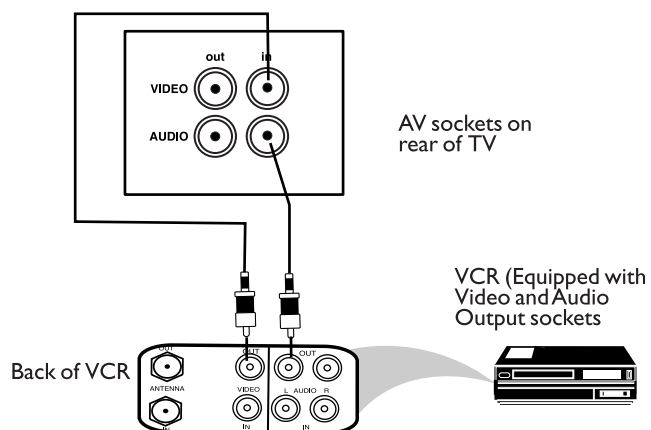

You can view the playback of VCR tapes (Video Disc players, camcorders, etc.) by using the **AUDIO** and **VIDEO INPUT** sockets on the rear of the TV.

- Connect the **VIDEO** and **AUDIO IN** sockets on the rear of the TV to the **AUDIO** and **VIDEO OUT** sockets on the VCR.

## CONNECTING THE AUDIO/VIDEO SOCKETS (RECORDING)

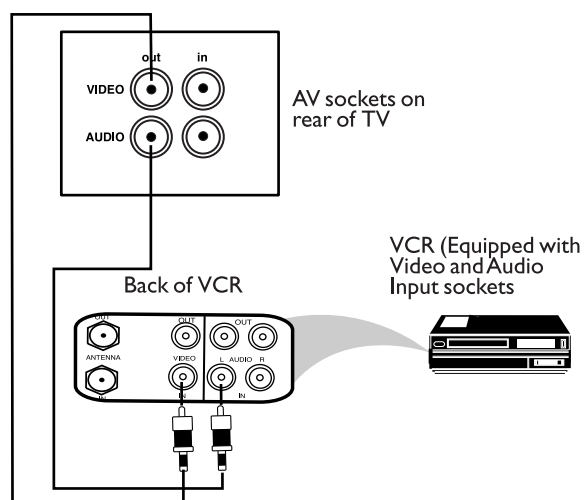

- Connect the sockets of the VCR which you wish to record from, to the corresponding **AV** sockets.

## FUNCTIONS OF REMOTE CONTROL

- 1 Power button**
  - Switch set off temporarily to standby mode. (The red light indicator lights up when the set is on standby mode).
  - To switch on set from standby mode, press Channel +/- , Digit (0 -9) or Power button.
- 2 Personal Zapping buttons**

As Personal Zapping buttons, you can surf up to 10 personal channels for each button. For detailed description of functions, refer to section on "Personal Zapping".
- 3 Smiley button**

Allows to add and store your personal preference channels in your Personal Preference list. For detailed description of functions, refer to section on "Using your Personal Zapping feature".
- 4 Sleptimer Button**

Allows you to select a time period after which the set will switch to standby mode automatically.
- 5 Smart Sound Button**

Press the Smart Sound button repeatedly to access 4 different types of sound settings and choose your desired setting.
- 6 Incredible Surround Button**

Not applicable.
- 7 Menu Button**

Displays the main menu. Also exits menu from screen.
- 8 Cursor Up Button**

Allows you to select the next item on the menu.
- 9 Cursor Left Button**

Allows you to select the sub-menus and adjust the settings.
- 10 Volume + / - Button**

Increases or decreases volume.
- 11 A/CH (Alternate channel) Button**

Allows you to change between the current channel and the previous channel.

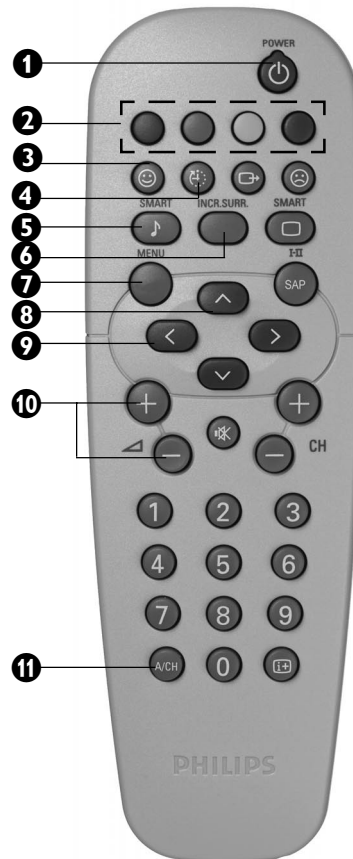



## FUNCTIONS OF REMOTE CONTROL

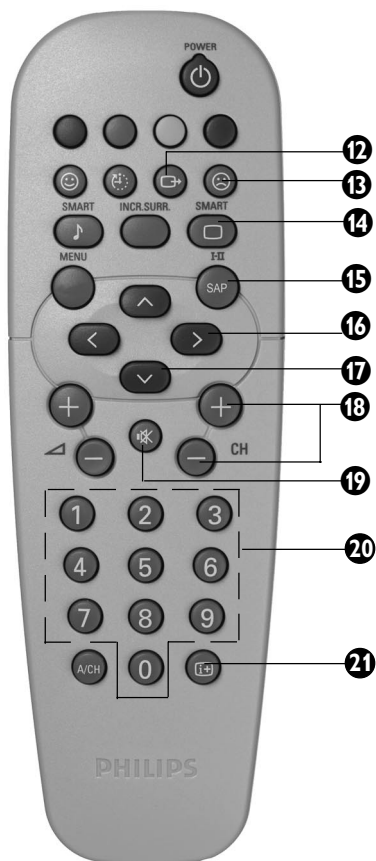

- 12 A/V Button**  
Allows you to select the AV channel.
- 13 Frownie button**  
Allows to delete stored personal preference channels in your Personal Preference list. For detailed description of functions, refer to section on "Personal Zapping".
- 14 Smart Picture Button**  
Press the Smart Picture button repeatedly to access 5 different types of picture settings and choose your desired setting.
- 15 HI**  
Not applicable.
- 16 Cursor Right Button**  
Allows you to access the sub-menus and adjust the settings.
- 17 Cursor Down Button**  
Allows you to select the next item on the menu.
- 18 Channel + / - Buttons**  
Allows you to select channels in ascending or descending order.
- 19 Mute Button**  
Mutes sound. To restore sound, press button again.
- 20 Digit (0 -9) Buttons**  
Press to select a channel. For a 2-digit channel number, press the first digit and followed immediately by the second digit.
- 21 OSD button**  
Allows you to display the current channel number. It also allows to exit menu from the screen after control adjustments.





## FUNCTIONS OF TV CONTROLS

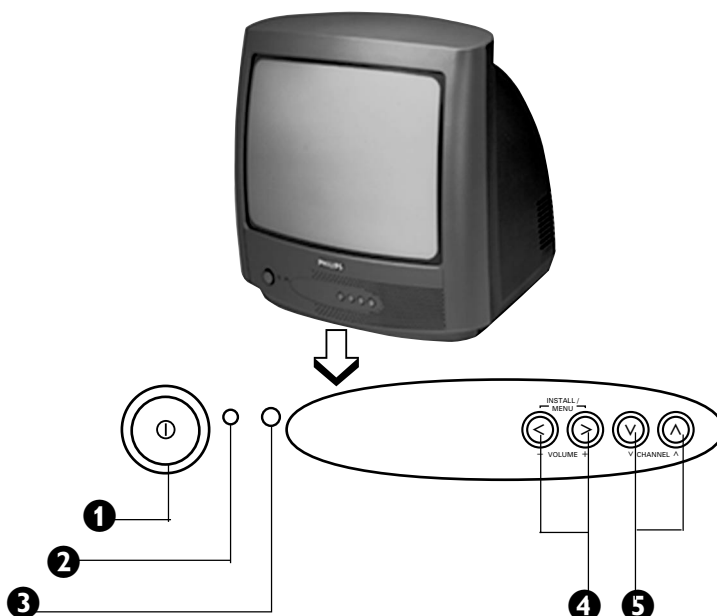

❶	Mains Power button	Switch mains power on or off.
❷	Standby light indicator	Indicate red light when standby mode is activated.
❸	Remote Sensor	Acts as a sensor for activating the controls of the TV when remote control handset is aimed at it.
❹	Volume + / - buttons	Adjust sound volume softer/louder.
❺	Channel ∨ / ∧ buttons	Select channel in descending/ascending order.

### **Note**

- You can enter the main menu by pressing both the Volume - and + buttons at the same time.
- Press the Channel ∨ or ∧ button to select the next item on the menu.
- Press Volume - or + button to access sub-menu and adjust the settings.













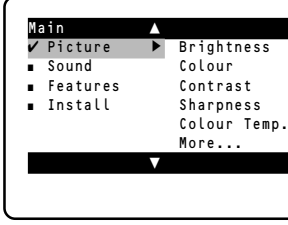

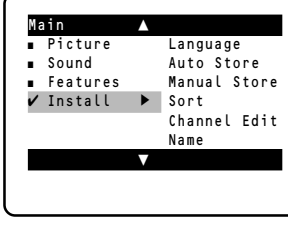
## SELECTING THE MENU LANGUAGE

Operating instructions generally explains the operation of the TV set using the buttons on the remote control unless otherwise stated. Please read the following instructions carefully and follow the steps as shown to familiarise yourself with the installations and all features available in your set.

**Note:** When there is no signal input to the TV, you may encounter instability of the on screen display. In this instance, please use the  button on your remote control to select an AV channel.









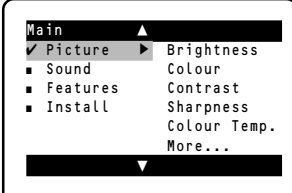

The **Language** feature allows you to set the TV's on-screen menu to be shown in your desired language.

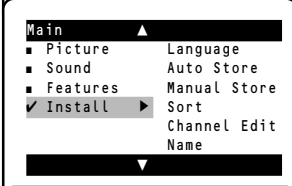
Step	Press button		Result on screen
	 MENU	Enter main menu.	
		Select <b>Install</b> .	
		Enter the Install menu.	
		Press button repeatedly to cycle through the language list and select the language of your choice.	
		Exit menu from screen.	

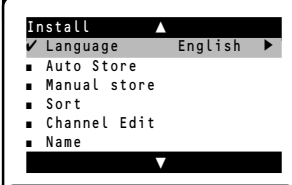

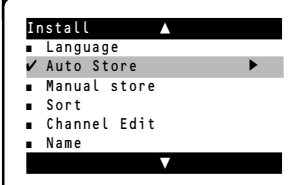
## AUTOMATIC TUNING OF CHANNELS

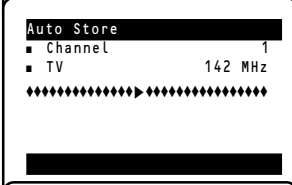
Automatic tuning of channels allows you to store each programme automatically.

Step	Press button	Result on screen
1	 Enter main menu.	
2	 Press button repeatedly until <b>Install</b> is selected.	
3	 Enter install menu.	
4	 Select <b>Auto Store</b> .	
5	 Start automatic tuning of channels.	
6	 When tuning is completed, exit menu from screen.	



## MANUAL TUNING OF CHANNELS

Manual tuning of channels allows you to select your preferred channel number for every available programme.

Step	Press button	Result on screen
1	MENU 	
2		
3		
4		
5		
6		

## MANUAL TUNING OF CHANNELS

Step	Press button		Result on screen
7		Start manual searching. Searching stops once a transmitting signal is found.	
8		Select <b>Channel</b> .	
9		Key in the channel number.	
10		Press button repeatedly until <b>Store</b> is selected.	
11		Store tuned channel. <b>Note</b> : If you want to continue searching for another transmitting channel, repeat steps 7 to 11.	
12		Exit menu from screen.	



## SELECTING THE COLOUR/SOUND SYSTEM

This feature allows you to select your desired **Colour** and **Sound** system. If **Auto** is selected, the respective colour and sound system will be automatically selected according to the transmission system. **Note** : Select your desired colour and sound system manually if reception is poor at **Auto** mode.

**Step**      **Press button**

**Result on screen**

Repeat step 1 to step 5 as in "Manual Tuning of TV Channels"

**Colour System** is selected.

6



Select the desired colour system (**Auto**, **PAL**, **NTSC 3.58**, **NTSC 4.43** or **SECAM**).

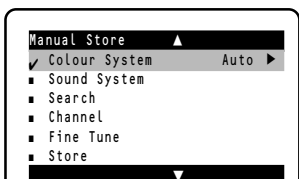

7



Press button repeatedly until **STORE** is selected.

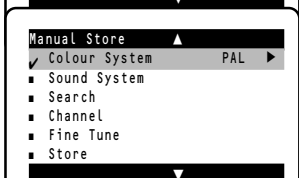

8



Store selected system.

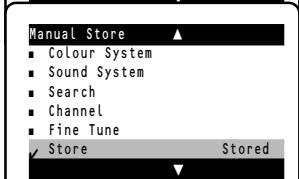

9



Proceed to select **Sound System**.

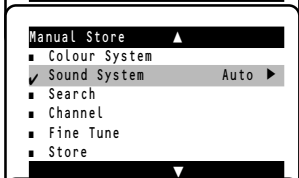

10

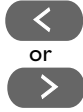

Select the desired sound system (**Auto**, **BG** or **DK**).

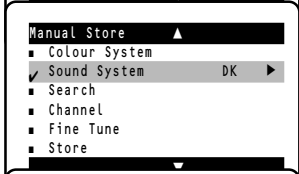

11



Press button repeatedly until **STORE** is selected.

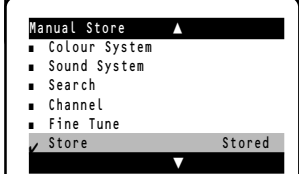

12



Store selected system.

13



Exit menu from screen.



## FINE TUNING OF CHANNELS

This feature allows you to adjust picture reception in areas of weak reception.

Step	Press button	Result on screen
1	MENU 	
2		
3		
4		
5		
6		
7	 or 	
8		
9		
10		





## SORTING OF CHANNELS

This feature rearranges channel numbers.

Step	Press button	Result on screen
<b>1</b>	MENU 	
<b>2</b>	Press button repeatedly until <b>Install</b> is selected.	
<b>3</b>	Enter install menu.	
<b>4</b>	Press button repeatedly until <b>Sort</b> is selected.	
<b>5</b>	Enter sort mode.	
<b>6</b>	or  Select the channel number you want to change from (e.g. 002).	
<b>7</b>	Confirm selection.	
<b>8</b>	Select the channel number you want to change to (e.g. 005).	
<b>9</b>	Confirm selection. The change is done. <b>Note</b> : Channel numbers 5, 4 and 3 will move upwards accordingly. that is, Channel 5 will move up to Channel 4, Channel 4 to 3 and Channel 3 to 2.	
<b>10</b>	Exit menu from screen.	





## EDITING OF CHANNELS

This feature allows you to skip or edit channels which have bad or weak TV signal or channels that you do not watch often. **Note** : Once a channel is skipped, you cannot have access to it by the CH (Channel) + or – button. You can only have access to the channel by the Digit (0 -9) buttons.

Step	Press button	Result on screen
1	MENU 	
2		
3		
4		
5		
6		
7		
8		
9		

### HOW TO RESTORE SKIPPED CHANNELS

- Repeat **Steps 1 to 5** as in "Editing of Channels".
- Key in the channel number to be restored by the **Digit (0 - 9)** button.
- Select **Skipped** by the button.
- Select **Off** to restore channel by the button.
- Exit menu from screen by the button.

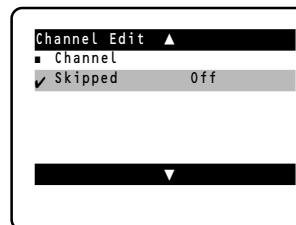



## NAMING OF CHANNELS (APPLICABLE TO CERTAIN VERSIONS ONLY)

This feature enables you to name or rename channels.

Step	Press button	Result on screen
1	MENU 	
2		
3		
4		
5		
6	 or 	
7		
8	 or 	
9		





## ADJUSTING THE TV PICTURE

The picture menu allows you to make adjustments to the picture.

Step	Press button	Result on screen
1	MENU 	
2		
3	 or 	
4	 or 	
5		

Picture menu items	Activities
Brightness	Increase or decrease brightness level.
Colour	Increase or decrease color level.
Contrast	Increase or decrease contrast level.
Sharpness	Increase or decrease sharpness level to improve detail in picture.
Colour temperature	Choose from 3 settings (Normal, Warm or Cool).
NR (Noise Reduction)	Select "On" to reduce "noisy" picture (little dots on picture) due to weak signal.
Contrast +	Select "On" to allow you to optimise the total contrast for improved picture quality.



## ADJUSTING THE TV SOUND

The sound menu allows you to make adjustments to the sound.







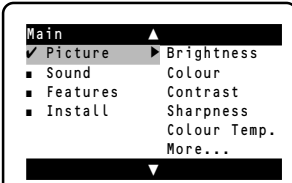

Step	Press button	Result on screen
1	MENU 	
2		
3		
4	 or 	
5	 or 	
6		

Sound menu items	Activities
Treble Boost	Select "On" to enjoy enhanced treble output.
Bass Boost	Select "On" to enjoy enhanced bass output.
AVL (Auto Volume Leveller)	Select "On" to enable volume to remain at a pre-determined level should there be a sudden change in volume during commercial breaks or channel switching.

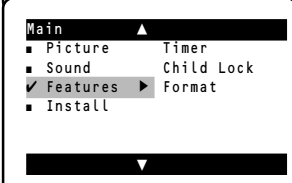
## USING THE TIMER

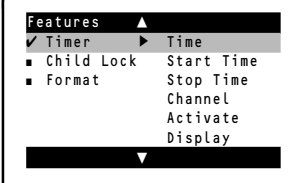
The Timer feature allows you to set the timer to switch to another channel at a specified time while you are watching another channel or when the TV is on standby mode.

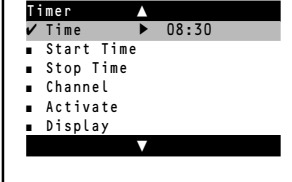
**Note :** For the timer to function, the set must not be switched off. Once the set is switched off, the timer is disabled.

Step	Press button	Result on screen
1	MENU 	
2		
3		
4		
5	1 2 3 4 5 6 7 8 9 0	Key in the current time starting from the hour follow by minute. This is the time where the "start time" and "stop time" will take reference from.
6		
7	1 2 3 4 5 6 7 8 9 0	Key in the time you want the programme to be switched on.



## USING THE TIMER

Step	Press button		Result on screen
8		Select <b>Stop Time</b> .	
9		Key in the time you want the programme to be switched off.	
10		Select <b>Channel</b> .	
11		Key in the channel you want to switch to.	
12		Select <b>Activate</b> .	
13		Activate timer. You can select <b>Once, Daily</b> or <b>Off</b> .	
14		Select <b>Display</b> .	
15		Select <b>On</b> mode if you want to display the time on the TV screen.	
16		Exit menu from screen.	

### Note :

- After the Stop Time is activated, the TV will go to standby mode immediately.
- If Stop Time is not keyed in, the set will go to standby mode after 2 hours.
- To switch on set from standby mode, press **Channel +/-**, **Digit (0 -9)** or **Power** button.

## ACTIVATING THE CHILD LOCK (ACCESS CODE)

The Child Lock feature allows you to lock channels to prevent your children from watching programmes you deem undesirable.









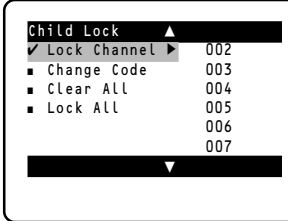

**Note :** You can only have access to the locked channels via the remote control. Keep the remote control out of reach so as to prevent your children from having access to it.

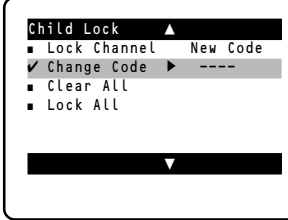
Step	Press button	Result on screen
1	MENU	
2	Down Arrow	
3	Right Arrow	
4	Down Arrow	
5	Right Arrow	
6	0 7 8 9	
7	0 1 2 3 4 5 6 7 8 9	
8	0 1 2 3 4 5 6 7 8 9	
9	Exit	

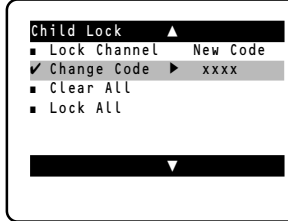
**Note :** After you have exit menu from screen and you want to enter the child lock menu again, you need to key the new access code only once.

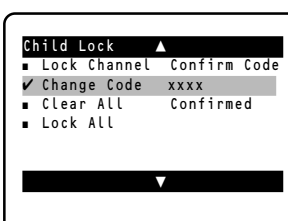
## ACTIVATING THE CHILD LOCK (CHANGE CODE)

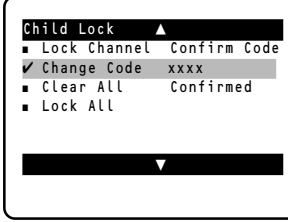
**Note :** You need to key the access code only once.

Step	Press button		Result on screen
Repeat <b>Steps 1 to 8</b> as in " <b>ACTIVATING THE CHILD LOCK (ACCESS CODE)</b> "		The Child Lock menu will now appear. You can proceed to change code.	
<b>9</b>		Select <b>Change Code</b> .	
<b>10</b>		Enter change code mode.	
<b>11</b>		Key in your preferred code (4-digit).	
<b>12</b>		Key in the new code the second time to confirm code.	
<b>13</b>		Exit menu from screen.	

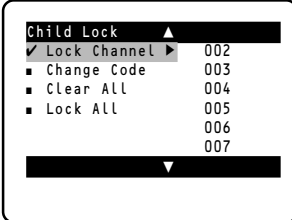
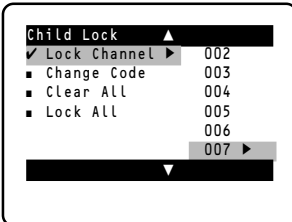
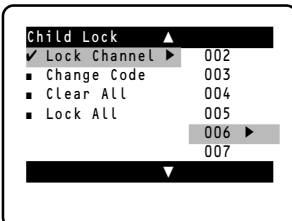
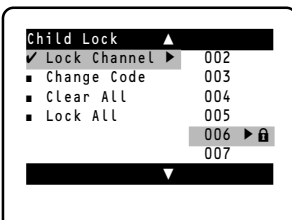

## ACTIVATING THE CHILD LOCK (LOCK CHANNEL)

Step	Press button	Result on screen		
Repeat <b>Steps 1 to 8</b> as in " <b>CHILD Lock (ACCESS CODE)</b> "	The Child Lock menu will now appear. You can proceed to lock channel.			
9	➤	Enter lock channel mode.		
	10	▲ or ▼	Select the channel you want to lock.	
11	➤	Activate blocking of channel. A keylock symbol will appear beside the channel number indicating that it is locked. <b>Note :</b> To lock more than one channel, repeat Steps 10 to 11 before exiting menu from screen.		
12	⏏	Exit menu from screen.		



## ACTIVATING THE CHILD LOCK (LOCK ALL)

You can choose to lock all channels in the **Lock All** mode in the Child Lock menu.

**Step**      **Press button**

Repeat **Steps 1 to 8** as in "**CHILD Lock (ACCESS CODE)**"

The Child Lock menu will now appear. You can proceed to lock all channels.

**Result on screen**

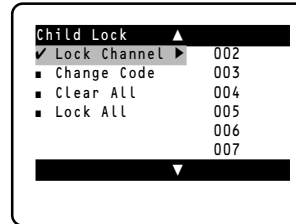

9



Select **Lock All**.

10



Select the **On** option to lock all channels.

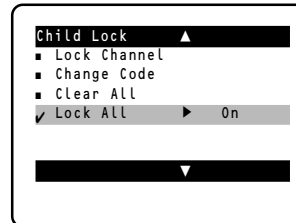

11



Exit menu from screen.

## ACTIVATING THE CHILD LOCK (CLEAR ALL)

To unlock channels that you have locked, enter the Child Lock menu and select the **Off** option **Clear All** mode.

**Step**      **Press button**

Repeat **Steps 1 to 8** as in "**CHILD Lock (ACCESS CODE)**"

The Child Lock menu will now appear. You can proceed to clear all channels.

**Result on screen**

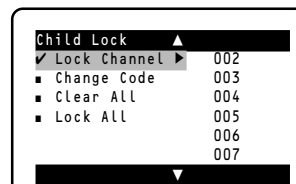

9



Select **Clear All**.

10



Select the **Off** option to unlock all channels.

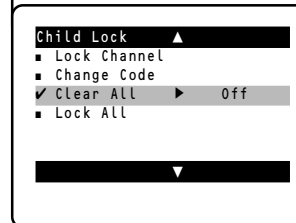

11



Exit menu from screen.



## USING THE SCREEN FORMAT

You can have a choice of two formats for your viewing pleasure, namely :- **4:3** mode and the **EXPAND 4:3** mode through the **FORMAT** menu.

Step	Press button	Result on screen
1	MENU	
2		
3		
4		
5		
6		

### When to use the Screen Formats

#### 4:3 format

Select the 4:3 format if you want to display the 4:3 picture using the full surface of the screen.

#### Expand 4:3 format

Select the Expand 4:3 format if you want to expand movie images recorded in the letterbox format. When this format is selected, the black horizontal bars at the top and bottom are expanded thus filling up the entire TV screen.

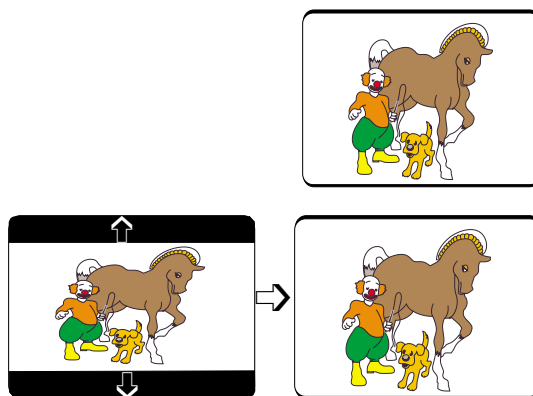



## SMART PICTURE CONTROL

Whether you are watching a movie or video game, your TV has automatic video control settings matched to your current program source or content. The Smart Picture feature quickly resets your TV's video controls of program for a number of different types of programs and viewing conditions you may have in your home. Each Smart Picture setting is preset at the factory to automatically adjust the TV's Brightness, Colour, Picture and Sharpness levels.

### Step

### Press button

1



Press button repeatedly to cycle through the 5 settings namely, **Personal**, **DVD/VCD**, **Rich**, **Natural** and **Soft** and select your desired picture setting.

2



Exit menu from screen.

### Defintion of Picture Settings

**Personal** : Picture settings are set to your preference.

**DVD/VCD** : For optimal picture setting, whenever the source is connected to DVD/VCD player, select DVD/VCD setting for AV mode.

**Rich** : Emphasize very vibrant colours. This setting is the optimal setting when you are viewing TV programmes in a brightly-lit room.

**Natural** : Emphasize original colours.

**Soft** : Emphasize "warm" colours. (Suitable for dimly-lit room condition and gives cinema-like effect when light is switched off).

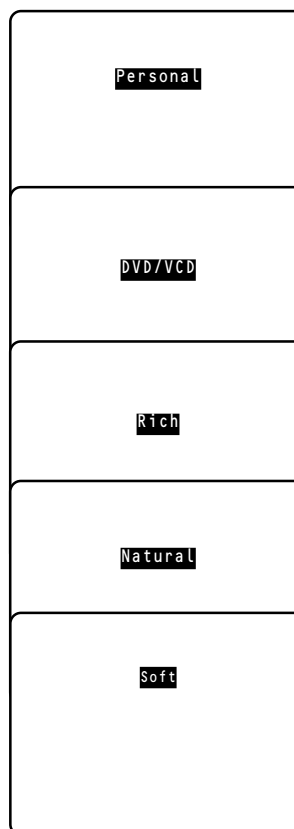



## SMART SOUND CONTROL

Whether you are watching a movie or video game, your TV has automatic sound control settings matched to your current program source or content. The Smart Sound feature quickly resets your TV's sound controls of program for a number of different types of programs and viewing conditions you may have in your home. Each Smart Sound setting is preset at the factory to automatically adjust the TV's Treble and Bass levels.

Step

Press button

1



Press button repeatedly to cycle through the 4 settings namely, **Personal**, **Theatre**, **Music** and **Voice** and select your desired sound setting.

2



Exit menu from screen.

### Definition of Sound Settings

**Personal** : Sound settings are set to your preference.

**Theatre** : Emphasize sensation to action.  
(Bass and Treble boosted)

**Music** : Emphasize low tone (Bass boosted).

**Voice** : Emphasize high tone (treble boosted).

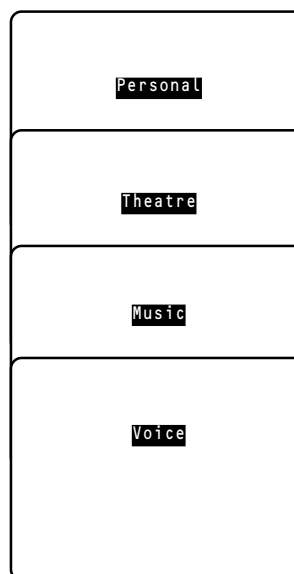



## PERSONAL ZAPPING

A list or series of favourite TV programs can be selected and stored in the 4 coloured buttons with the Personal Zapping feature. With this feature you can easily view up to a total of 10 preferred channels for each coloured button.

### Adding Channels to the Favourite list

Step	Press button		Result on screen
1		Select a channel by the Digit buttons	  
2		Press button to display list.	
3		Choose your favourite colour button to store selected channel.  Repeat steps 1 to 3 to add and store your favourite channels to the list.	
4		Exit menu from screen.	

### To view through the favourite list

1		Press the colour button that you have selected.
2		Press button repeatedly to cycle through your favourite list and view your favourite channel.

### Deleting Channels from the Favourite list

1		Select a colour button and press button repeatedly to select the channel you want to delete.	 
2		Press button to display list.	
3		Press button to remove item.  Repeat steps 1 to 3 to delete more channels from list.	
4		Exit menu from screen.	



## SPECIFICATIONS

	<b>14PT2001</b>
Picture tube screen size	370 mm
Picture tube visible area	340 mm
Audio Output : Speaker	1 x 4 W
TV System	PAL B/G PAL D/K PAL I (only for certain versions) SECAM B/G SECAM D/K SECAM K1
Playback System	NTSC 3.58, NTSC 4.43, PAL 60
Set Dimensions : Width Depth Height	360 mm 370 mm 357 mm
Net Weight of Set (approximate )	9 kg

### Note

For Operating Voltage, Frequency, Power Consumption and Version Number, refer to the type number at the rear of the set.



**3139 125 29252**



31-32/E/29251

32



06/24/02, 11:54 AM





## Free Manuals Download Website

<http://myh66.com>

<http://usermanuals.us>

<http://www.somanuals.com>

<http://www.4manuals.cc>

<http://www.manual-lib.com>

<http://www.404manual.com>

<http://www.luxmanual.com>

<http://aubethermostatmanual.com>

Golf course search by state

<http://golfingnear.com>

Email search by domain

<http://emailbydomain.com>

Auto manuals search

<http://auto.somanuals.com>

TV manuals search

<http://tv.somanuals.com>