

I4PT2219/94

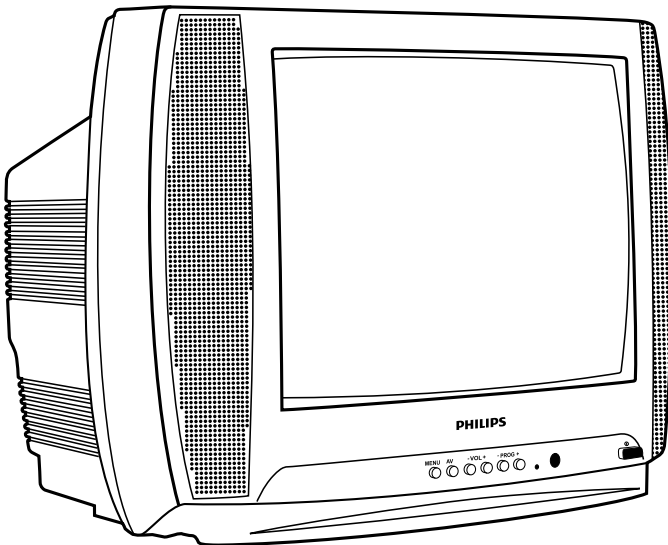

www.philips.com

I4" CRT TV user manual

PHILIPS

Table of contents

Safety	4
General	
Caring and cleaning of the TV	
<hr/>	
Before calling service	5
Symptoms	
<hr/>	
TV hookup (Basic connection)	6
Antenna connection	
Mains connection	
Switching on the set	
<hr/>	
Remote control care and use	6
<hr/>	
Features	7
<hr/>	
Front and back terminals	8
<hr/>	
Control and connection panel	9
<hr/>	
Power in your hand – Remote control	10
<hr/>	
Viewing the menus	12
Picture	12
Sound	12
Timer	12
Features	13
Install	14
<hr/>	
Specifications	16

Safety

1. General

- 1 Two people are required to lift and carry a TV that weights more than 25kg. Improper handling of the TV can cause serious injury.
- 2 The surface on which the TV is placed has to be leveled and able to withstand its weight.
- 3 Do not place the TV in a confined place. Air must be able to circulate freely through the ventilation slots.
- 4 Do not place naked flame sources such as lighted candles close to the TV.
- 5 Do not place a vase filled with water near the TV. Spills can results in electric shock. If water gets into the TV, disconnect the TV from the mains and have it checked by a qualified technician.
- 6 Do not expose the TV or the batteries of the remote control to heat, direct sunlight, rain or water.
- 7 During a thunder storm, do not touch any part of the TV, power cord or antenna cable.
- 8 Do not leave the TV in standby mode for an extended period of time. Instead disconnect it from the mains.
- 9 Do not connect too many equipment to the same mains socket because it can result in fire or electric shock.

2. Caring and cleaning of the TV

- 1 Disconnect the TV from the mains before you clean the TV. Use only a dry cloth.
- 2 Do not touch, push, rub or strike the screen with anything hard as this may scratch or damage the screen permanently.

Before calling service

Below is a list of frequently occurred symptoms. Before you call for service, make these simple checks. Some of these symptoms can easily be rectified if you know what to do.

Symptoms	What you should do
Colour patch	– Switch off the TV by the mains power button. – Wait for 20 minutes before switching on again. – Check the TV is not placed too near the speakers or magnetic objects.
No power	– Check the TV's AC power cord is plugged into the mains socket. If there is still no power, disconnect plug. Wait for 60 seconds and re-insert plug. Switch on the TV again.
No picture	– Check the antenna connection at the rear of the TV. – Possible TV station problem
Good picture but no sound	– Try increasing the volume. – Check that the sound is not muted. If it is muted, press the MUTE button on the remote control to restore sound.
Good sound but poor colour or no picture	– Try increasing the contrast and brightness setting.
Snowy picture and noise	– Check antenna connection at the rear of the TV.
Horizontal dotted lines	– Possible electrical interference e.g. hairdryer, vacuum cleaner, etc. – Switch off other appliances.
Double images or "Ghost" images	– Possible poor positioning of antenna. Using a highly directional antenna may improve reception.
TV not responding to remote control	– Aim remote control directly at remote sensor lens on the front panel of the TV. – Check life span of batteries of the remote control.

TV hookup (Basic connection)

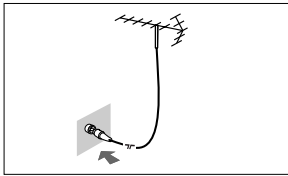

Antenna connection

- Connect the aerial plug to the antenna socket on the backcover.
- Insert the mains plug into the wall socket.

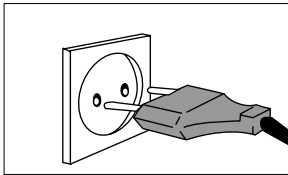

Mains connection

- For correct mains voltage, refer to type sticker at the rear of the TV set.
- Consult your dealer if mains supply is different.

Note: This diagram is not representative of the actual plug and socket.

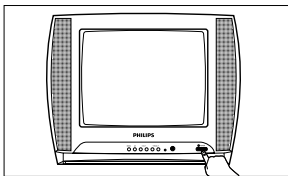

Switching on the set

- Press the main power button to switch ON/OFF the TV.
- If the set is on standby (indicator is lit), press the power button on the remote control to switch on set.

Remote control care and use

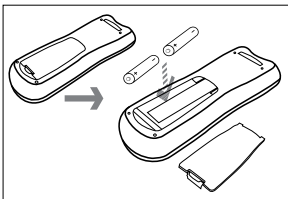

- Insert the correct type of batteries into the compartment.
- Ensure the batteries are placed in the right direction.

Features

- 250 Program memory
- Frequency synthesized tuning
- Auto search
- Menu driven
- AV in1 / AV in2 / AV-out
- Timer display
- Sleep
- On/Off timer
- Last viewed channel (recall)
- Display
- Child lock (panel lock)
- 5 Picture modes (smart)
- Auto shut off after 15 minutes
- Blue back at no signal
- Zoom mode (normal, zoom, wide)
- White tone (normal, warm, cold)
- Game (box man)
- Calendar
- Video off
- Phone book
- Message
- Favourite channel
- Channel swap
- Noise reduction
- Auto volume leveler (AVL)
- Plug and play
- Black stretch

Operating instructions generally explain the operation of the TV set using the buttons on the remote control unless otherwise stated. Please read the following instructions carefully and follow the steps as shown to familiarize yourself with the installations and all features available in your set.

Front and back terminals

Front view

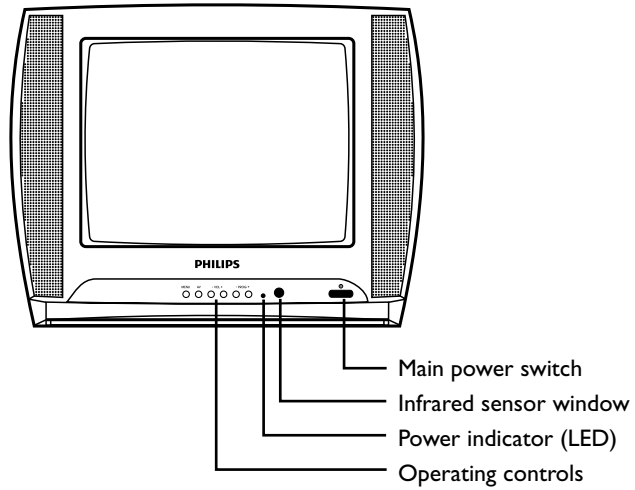

Back view

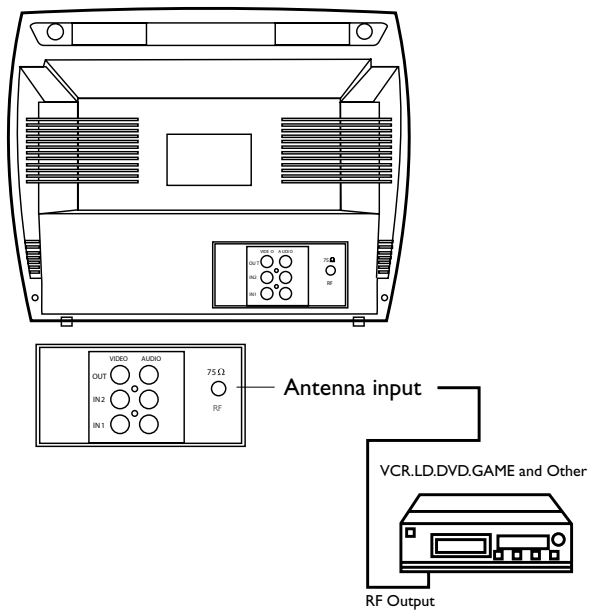

Control and connection panel

Front control

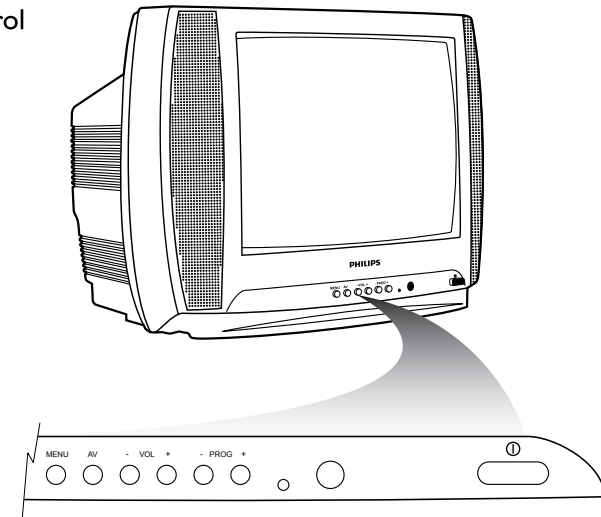

Back control

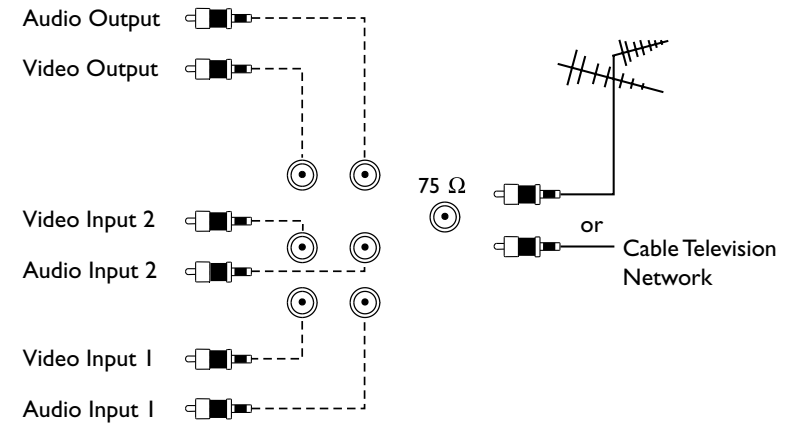

Power in your hand – Remote control

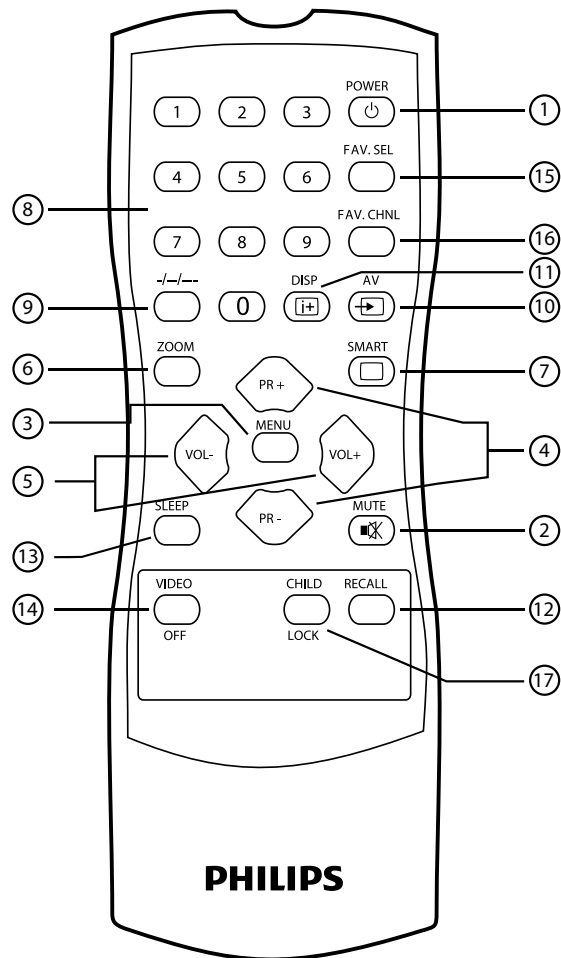

- ❶ **POWER:** Switches the set **ON** from **Standby** or **OFF** to **Standby**.
- ❷ **MUTE:** By pressing the **MUTE** key, the volume of the set can be switched off completely. The volume can be returned to the original if the key is pressed again or **VOL +** button is pressed.
- ❸ **MENU:** Press the key to display the on-screen menu. Each press will take to another set of menu.
- ❹ **PR +/-:** Selects to display the next or previous stored channel.
- ❺ **VOL +/-:** Used to increase or decrease the volume.
- ❻ **ZOOM:** Use this key to change the viewing mode of the set, which can be selected from zoom, normal or wide.
- ❼ **SMART :** Smart or personal preference is the key which can be used to view the prefixed setting of Brightness/Contrast/Sharpness named as Personal/Standard/Sport/Soft/Vivid.
- ❽ **NUMERIC BUTTONS (0-9):** Press any number key to select the respective channel number.
- ❾ **- /- /---**: Press this key followed by numeric keys to select the multi digit program number.
- ❿ **AV:** Press this key to select TV from AV mode or vice versa as per your preference.
- ⓫ **DISP:** Press this key to display current modes i.e. **Program No., Clock** (if clock is on). Press it again to return to normal TV viewing.
- ⓬ **RECALL:** Use this to toggle between currently viewed and last viewed channel.
- ⓭ **SLEEP:** This can be used to select a time period between 5 to 120 minutes after which the set will automatically switch off to **Standby** mode. If the **Sleep Timer** is not selected, **OFF** will be displayed. If it is already set the remaining time for **Sleep Timer** will be displayed.
- ⓮ **VIDEO OFF:** Press this key to select TV to mute the video of the set. When pressed a **MUSIC** mark will come onto the screen as a screen saver and no other video will be seen. The audio can only be heard in this mode.
- ⓯ **FAV. SEL:** Press this key to save a particular channel in your **Favorite Channel** list. The sequence of the favorite channel will depend upon the sequence of saving a particular channel and not on its program number. A maximum of 8 channels can be saved in favorite memory.
- ⓰ **FAV. CHNL:** Press this key to select any channel saved into your **Favorite Channel** list. Each press will take to your next saved favorite channel.
- ⓱ **CHILD LOCK:** Press **CHILD LOCK** key on remote. You will get a lock symbol displayed on screen. In this mode the control panel on front of TV will stop working.

Viewing the menus

Press the menu key. Each press of menu key will take to another submenu. To come to the previous main menu from any submenu, press menu key again.

1 Picture

Press the menu key to display the picture menu on the screen as shown. Press **PR+/-** to select the parameter which needs to be adjusted. Press **VOL+/-** to make appropriate adjustments of the selected parameter. Select White Tone by using **PR+/-** then by **VOL+/-**, you can select the desired tone i.e. Normal, Warm and Cold.

The display will disappear after 15 sec.

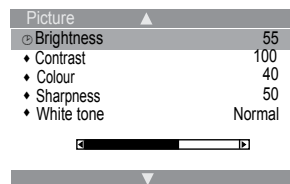

2 Sound

Press the menu key twice to call the **Sound** menu. Press **PR+/-** to select channels, if you intend to change it. Press **VOL+/-** to decrease or increase the volume.

Auto Volume Leveler (AVL): The **Auto Volume Leveler** moderates sudden volume increases when switching broadcast channels or when commercials come on. It suppresses the volume increases in the sound modulation. This is great new feature!

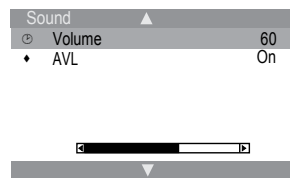

3 Timer

Press the menu key three times to call the **Timer** menu. Press **PR+/-** to select Time. Adjust hours and minutes using numeric keys.

OffTime: Select **OffTime** to schedule the time at which you would like to switch the set to standby mode automatically.

Switch Time: Select **Switch Time** to schedule the

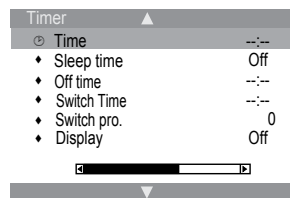

Viewing the menus

time at which you want to switch on the set from **Standby** mode automatically.

Switch pro.: At **Switch pro.** enter the program number at which you would like to switch on the set from **Standby** mode.

Display: When kept to ON position, will display the **Time** on the TV screen.

Note: Time should be set prior to setting the **OffTime** and **Switch Time**

The **Time** remains in the memory of the set till it is not switched off from the mains.

Reset the time again when it is switched on from mains.

4 Features

Press the menu key four times. This will show the Feature menu.

Game: Select **Game** using **PR+/-** and press **VOL+/-** to go to **Game** menu. The screen will appear as shown. You can enjoy video game either in RF mode or in AV mode. This is a 10 level game. You can change the level by using **PR+/-**. Select any one level as per your choice to play. Press **VOL+/-** key to start the game. If you wish to restart the game on the same level, during play press **DISP** key. You can exit from the menu by pressing menu key.

Calendar: Select **Calendar** using **PR+/-** and press **VOL+/-** to display the calendar on screen, as shown. You may select the desired year, month and date by pressing **VOL+/-** and change the selected value by pressing **PR+/-**. You can use this feature to view 199 years from 1901 to 2099.

Phone Book: Select **Phone Book** using **PR+/-** and press **VOL+/-** to display the phone book on screen, as shown. This feature is used to memorize the name along with the telephone number of any desired person. You

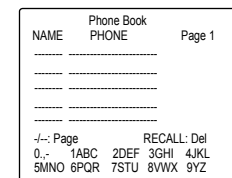
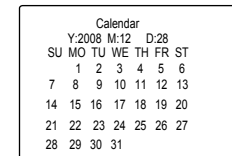
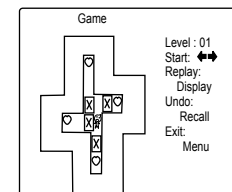
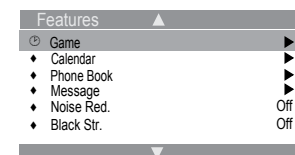

can feed 8 character name & max 15 digit phone nos. Use number keys as per the alphabets written above to enter the name of the person you want to enter. To change the page in ascending order you can use **-/--/---** key. You can select any line of particular page by **PR+/-** key and move cursor by **VOL+/-** key. Enter the telephone number using numeric keys only. A maximum of 20 number can be stored on four pages.

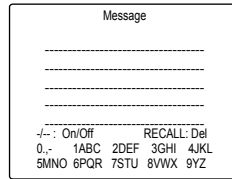

Message: Using the feature of **Message** you can display a message of 115 characters, whenever the set is switched on either from standby mode or from mains.

The message can be entered in five line using numeric keys on remote. You can change the setting of the message from **ON** to **OFF** and vice versa using **-/--/---** key. To delete any character while entering the message, use **Recall** key of remote.

Noise Red: The **Noise Red** function reduces the noise (snow) on the picture. Press **VOL+/-** after selection to toggle between **ON** and **OFF**.

Black STR.: The **Black STR.** Function is used to enhance the black colour of the picture.

5 Install

Press the Menu key five times. This will show the Install Menu.

Program: Select **Program** no. and enter the desired number by using **VOL+/-**, numeric key and **-/--/---** keys.

Colour Sys: You can change the **Colour System** of any particular channel by selecting the same using **PR+/-**. Press **VOL+/-** to select from **AUTO/PAL/N3.58/N4.43**.

N3.58/N4.43 (NTSC) can be selected in **AV** mode only.

Skip: If you do not want a channel to be viewed using **PR+/-**, you can block the same with the use of **Skip** function. The blocked channel can be viewed by the

numeric keys.

Fine tune: Select **Fine tune** at a particular program number by pressing **PR+/-**. This can be used to improve both picture and sound quality of the particular program number. Using **VOL+/-**, the fine tuning can be done in both forward and backward direction.

Auto Search: Select **Auto Search** by using **PR+/-**. Then Press the **VOL+/-** key. This will display menu as shown. All the available channels are searched and each time the channel is found, it is stored on the **Program**.

Nos., starting from program number 0. The TV returns to the initial starting number after completion of auto search. Press the menu key to stop the auto search in between the searching.

Search: Select **Search** by using **PR+/-**. This can be used to manually store the program at a particular Program Nos. Press **VOL+/-** key to search the program in either forward or backward direction.

Once a signal is received, the unit will stop searching. Continue searching the desired program using **VOL+/-** until you receive the channel of your interest.

Sort to: Use **Sort to** function of your set, for interchanging the programs memorized on two different program numbers. Enter the two program numbers at **Program Nos.** and **Sort to**. Select **Confirm** and press **VOL+/-**.

Plug & Play: When kept to **ON** position, it will automatically start the auto tuning when the set will be switched on for the very first time.

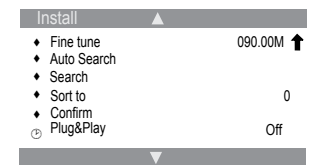
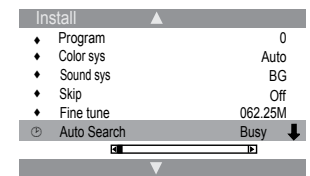
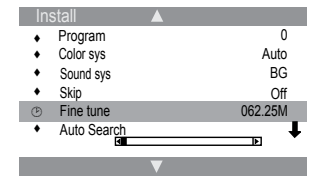
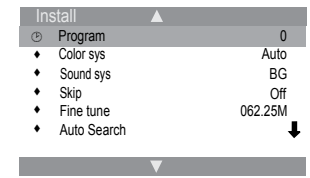

Specifications

Product type : 14PT2219/94

Picture

Display screen type : Black HiBri tube

Visible diagonal screen size : 36cms

Aspect ratio : 4:3

Picture enhancement : Black stretch

Picture noise reduction : Noise reduction

Sound

Sound output : 200W PMPO

Sound systems : Mono

Sound features : Mute, AVL

Convenience : Sleep timer, Auto store, Smart picture

Reception

Colour system : Auto, PAL, NTSC 3.58, NTSC 4.43

Sound system : BG (5.5M)

Connectivity

Rear : Input-AV IN 1, AV IN 2, Antenna 75Ω

: Output-AV OUT

General

Mains voltage : 110-240V~, 50-60Hz

Power consumption : 55W

Net weight (approx.) : 8.5kg

Gross weight (approx) : 10.3kg

Set dimension (W x D x H) : 443 x 382 x 340mm



www.philips.com

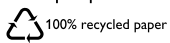

100% recycled paper

Document order number: 0000 000 00000

Free Manuals Download Website

<http://myh66.com>

<http://usermanuals.us>

<http://www.somanuals.com>

<http://www.4manuals.cc>

<http://www.manual-lib.com>

<http://www.404manual.com>

<http://www.luxmanual.com>

<http://aubethermostatmanual.com>

Golf course search by state

<http://golfingnear.com>

Email search by domain

<http://emailbydomain.com>

Auto manuals search

<http://auto.somanuals.com>

TV manuals search

<http://tv.somanuals.com>