

DFU
TS3258
TS3658

Return your Warranty Registration card today to ensure you receive all the benefits you're entitled to.

Once your PHILIPS MAGNAVOX purchase is registered, you're eligible to receive all the privileges of owning a PHILIPS MAGNAVOX product. So complete and return the Warranty Registration Card enclosed with your purchase at once. And take advantage of these important benefits.

Warranty Verification

Registering your product within 10 days confirms your right to maximum protection under the terms and conditions of your PHILIPS MAGNAVOX warranty.

Owner Confirmation

Your completed Warranty Registration Card serves as verification of ownership in the event of product theft or loss.

Model Registration

Returning your Warranty Registration Card right away guarantees you'll receive all the information and special offers which you qualify for as the owner of your model.

Congratulations on your purchase, and welcome to the "family!"

PHILIPS MAGNAVOX



Dear PHILIPS MAGNAVOX product owner:

Thank you for your confidence in PHILIPS MAGNAVOX. You've selected one of the best-built, best-backed products available today. And we'll do everything in our power to keep you happy with your purchase for many years to come.

As a member of the PHILIPS MAGNAVOX "family," you're entitled to protection by one of the most comprehensive warranties and outstanding service networks in the industry.

What's more, your purchase guarantees you'll receive all the information and special offers for which you qualify, plus easy access to accessories from our convenient home shopping network.

And most importantly you can count on our uncompromising commitment to your total satisfaction.

All of this is our way of saying welcome—and thanks for investing in a PHILIPS MAGNAVOX product.

Sincerely,

Robert Minkhorst
President and Chief Executive Officer

P.S. Remember, to get the most from your PHILIPS MAGNAVOX product, you must return your Warranty Registration Card within 10 days. So please mail it to us right now!

Know these safety symbols



This "bolt of lightning" indicates uninsulated material within your unit may cause an electrical shock. For the safety of everyone in your household, please do not remove product covering.

The "exclamation point" calls attention to features for which you should read the enclosed literature closely to prevent operating and maintenance problems.

WARNING: TO PREVENT FIRE OR SHOCK HAZARD, DO NOT EXPOSE THIS EQUIPMENT TO RAIN OR MOISTURE.

CAUTION: To prevent electric shock, match wide blade of plug to wide slot, and fully insert.

ATTENTION: Pour éviter les chocs électriques, introduire la lame la plus large de la fiche dans la borne correspondante de la prise et pousser jusqu'au fond.

PHILIPS MAGNAVOX Visit our World Wide Web Site at <http://www.philipsmagnavox.com>

SAFETY INSTRUCTIONS - Read before operating equipment

This product was designed and manufactured to meet strict quality and safety standards. There are, however, some installation and operation precautions which you should be particularly aware of.

1. **Read Instructions** - All the safety and operating instructions should be read before the appliance is operated.
2. **Retain Instructions** - The safety and operating instructions should be retained for future reference.
3. **Heed Warnings** - All warnings on the appliance and in the operating instructions should be adhered to.
4. **Follow Instructions** - All operating and use instructions should be followed.
5. **Water and Moisture** - The appliance should not be used near water - for example, near a bathtub, washbowl, kitchen sink, laundry tub, in a wet basement or near a swimming pool, etc.
6. **Carts and Stands** - The appliance should be used only with a cart or stand that is recommended by the manufacturer.
- 6A.  An appliance and cart combination should be moved with care. Quick stops, excessive force, and uneven surfaces may cause the appliance and cart combination to overturn.
7. **Wall or Ceiling Mounting** - The appliance should be mounted to a wall or ceiling only as recommended by the manufacturer.
8. **Ventilation** - The appliance should be situated so that its location or position does not interfere with its proper ventilation. For example, the appliance should not be situated on a bed, sofa, rug, or similar surface that may block the ventilation openings; or, placed in a built-in installation, such as a bookcase or cabinet that may impede the flow of air through the ventilation openings.
9. **Heat** - The appliance should be situated away from heat sources such as radiators, heat registers, stoves, or other appliances (including amplifiers) that produce heat.
10. **Power Sources** - The appliance should be connected to a power supply only of the type described in the operating instructions or as marked on the appliance.
11. **Power-Cord Protection** - Power supply cords should be routed so that they are not likely to be walked on or pinched by items placed upon or against them, paying particular attention to cords and plugs, convenience receptacles, and the point where they exit from the appliance.

12. **Cleaning** - The appliance should be cleaned only as recommended by the manufacturer.
13. **Power Lines** - An outdoor antenna should be located away from power lines.
14. **Outdoor Antenna Grounding** - If an outside antenna is connected to the receiver, be sure the antenna system is grounded so as to provide some protection against voltage surges and built up static charges.
Section 810 of the National Electric Code, ANSI/NFPA No. 70-1984, provides information with respect to proper grounding of the mast and supporting structure grounding of the lead-in wire to an antenna discharge unit, size of grounding connectors, location of antenna-discharge unit, connection to grounding electrodes and requirements for the grounding electrode. See Fig. below.
15. **Non-use Periods** - The power cord of the appliance should be unplugged from the outlet when left unused for a long period of time.
16. **Object and Liquid Entry** - Care should be taken so that objects do not fall and liquids are not spilled into the enclosure through openings.
17. **Damage Requiring Service** - The appliance should be serviced by qualified service personnel when:
 - A. The power supply cord or the plug has been damaged; or
 - B. Objects have fallen, or liquid has been spilled into the appliance; or
 - C. The appliance has been exposed to rain; or
 - D. The appliance does not appear to operate normally or exhibits a marked change in performance; or
 - E. The appliance has been dropped, or the enclosure damaged.
18. **Servicing** - The user should not attempt to service the appliance beyond that described in the operating instructions. All other servicing should be referred to qualified service personnel.

Note to the CATV system installer: This reminder is provided to call the CATV system installer's attention to Article 820-40 of the NEC that provides guidelines for proper grounding and, in particular, specifies that the cable ground shall be connected to the grounding system of the building, as close to the point of cable entry as practical.

EXAMPLE OF ANTENNA GROUNDING AS PER NATIONAL ELECTRICAL CODE (NEC)

Example of Antenna Grounding as per NEC - National Electric Code

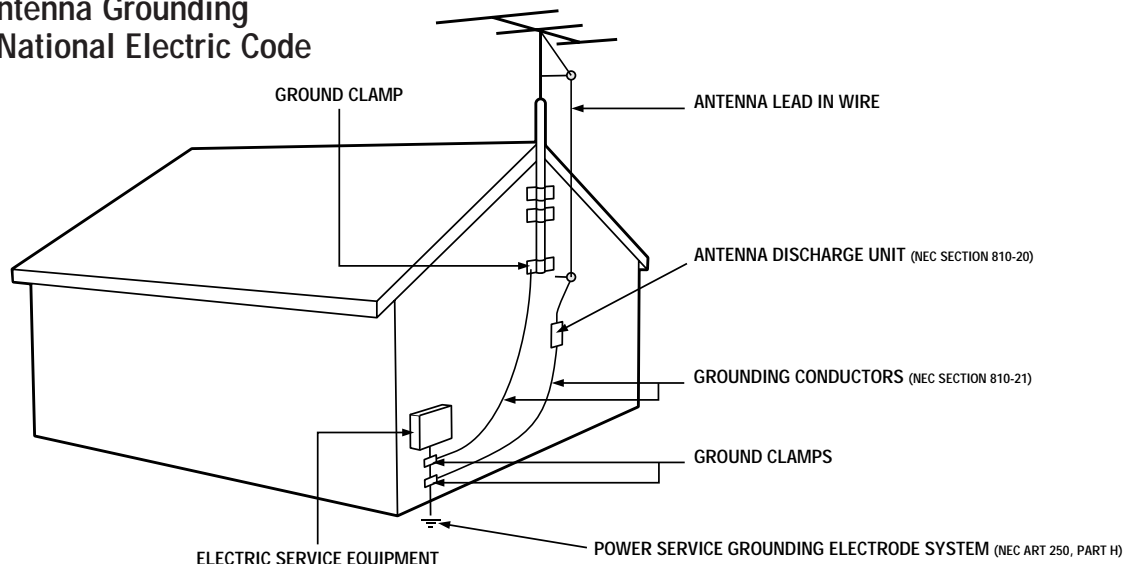

TABLE OF CONTENTS

Introduction

Welcome/Registration of Your TV	2
Safety/Precautions	3
Table of Contents	4
Features	5



On-Screen MENU

Picture

◇ Adjusting the TV Picture	6
----------------------------------	---

Features

◇ Setting the TV's On-screen Clock	7
◇ Activating the TV's On Timer Control.....	8
◇ Selecting the TV's On Timer Channel	9
◇ Setting the TV's On Timer Startup Time.....	10
◇ Turning on the On Timer Display.....	11
◇ Setting the Access Code within SmartLock	12
◇ Using SmartLock to Block Channels	13
◇ Using the Noise Reduction (NR) Control	14
◇ Using the Contrast + Control.....	14
◇ Setting the TV for Closed Caption	15
◇ Using the Sleep Timer Control.....	16

Sound

◇ Adjusting the Treble, Bass, and Balance Sound Controls.....	17
◇ Setting the TV for Stereo and SAP Programs ..	18
◇ Using the Incredible Stereo Control	19
◇ Using the Volume Bar Control	19
◇ Using the Audio Out Jacks (with TV Speaker On/Off Control)	20
◇ Using the TV's Audio/Video Input Jacks	21-22



Remote Control Operation

Using the Smart Picture Control	23
Using the Smart Sound Control (AVL).....	24
Using the Surf and Alternate Channel Buttons	25
Setting the Remote to Operate Accessory Devices	26-27
Setting the TV Remote to Operate Accessory Devices (Search Method)	28
Remote Control Direct Entry Code List	29-30
Using the Remote's VCR Buttons	31



General Information

Tips if Something Isn't Working	32
Glossary of TV Terms.....	33
Index	33
Factory Service Locations	34-35
Warranty.....	36

QUICK USE/INSTALLATION GUIDE



Getting Started

Warning/Precautions.....	1
Hooking Up Your TV	1
How to Use the "INSTALL" Controls	2-3
Using the Language Control.....	2
Setting the TV to Auto Program Channels.....	2
Setting the TV for a Cable or Antenna Signal.....	2
Using the Adding and Deleting Channels	3
Setting the Channel Name Control.....	3
How to use the Smart Clock control	3
Basic TV and Remote Control Operation	4

FEATURES

Infrared Remote Control works your TV set, VCR, and a variety of wireless remote control Cable Converters (Satellite Receivers, DVD, etc.).

Standard broadcast (VHF/UHF) or Cable TV (CATV) channel capability.

Stereo Ready TV with built-in audio amplifier and twin speaker system for receiving TV programs broadcast in stereo sound.

Closed Captioning allows the viewer to read TV program dialogue or voice conversations as on-screen text.

Automatic Programming of Channels for quick and easy selection of favorite stations available in your area.

On-Screen Features (in either English, French, or Spanish) show helpful messages for setting of TV controls.

Audio/Video Jackpanel for direct connections with VCRs (or other video accessories) providing quality TV picture and sound playback.

On Timer automatically turns the TV ON at a preset time, and channel.

Sleep-Timer automatically turns the TV OFF at pre-set times.

SmartLock feature allows you to block the viewing of certain channel or external audio/video connections were you might not want your children viewing inappropriate material.

Smart Picture allows you to set the picture color, tint, contrast, etc. for various types of programming such as Sports, Movies, Multi Media (Gaming), or Weak Signals with the push of one button.

Smart Sound controls the sudden volume changes that occur when changing programs or when a commercial break comes on. It eliminates the peaks and valleys in the TV's sound with one pleasant listening level.

SET-UP AND QUICK USE GUIDE

Use the simple Set-Up Guide (supplied with your TV information packet) for details on:

- Cable/Antenna Hook-ups
- Auto-Programming of Channels
- Channel Editing
- Automatic Clock Setting (Smart Clock)
- Basic TV and Remote Control Operation
- On-Screen Menu Use

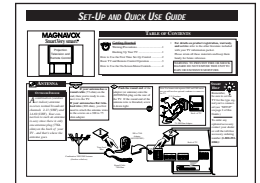

NOTE: This owner's manual is used with several different television models. Not all features (and drawings) discussed in this manual will necessarily match those found with your television system. This is normal and does not require you contacting your dealer or requesting service.

END-OF-LIFE DISPOSAL

Your new television and its packing contain materials that can be recycled and reused. Specialized companies can recycle your product to increase the amount of reusable materials and minimize the amounts which need to be properly disposed.

Your product also uses batteries which should not be thrown away when depleted, but should be handed in and disposed of as small chemical waste.

Please find out about the local regulations on how to dispose of your old television, batteries, and packing materials whenever you replace existing equipment.

HOW TO ADJUST THE TV PICTURE

To adjust your TV picture controls, select a channel and follow the steps shown below:

BEGIN

- 1 Press the **MENU** button on the remote to show the on-screen menu. **PICTURE** will be highlighted.
- 2 Press the **CURSOR RIGHT** button and the menu will shift to the right to display an adjustment bar in front of the **BRIGHTNESS** control.
- 3 Use the **CURSOR LEFT** or **RIGHT** buttons to adjust the **BRIGHTNESS** level of the picture.
- 4 After adjusting the **BRIGHTNESS** control, press the **CURSOR DOWN** button to select another Picture adjustment; **COLOR**, **PICTURE**, **SHARPNESS**, **TINT**, or **COLOR TEMP**. Use the **CURSOR LEFT** or **CURSOR RIGHT** buttons to adjust the selected control.



SMART HELP



Remember, when the bar scale is centered, the control settings are at normal mid-range levels.

BRIGHTNESS Press the **▶▶** or **◀◀** buttons until darkest parts of the picture are as bright as you prefer.

COLOR Press the **▶▶** or **◀◀** buttons to add or eliminate color.

PICTURE Press the **▶▶** or **◀◀** buttons until lightest parts of the picture show good detail.

SHARPNESS Press the **▶▶** or **◀◀** buttons to improve detail in the picture.

TINT Press the **▶▶** or **◀◀** buttons to obtain natural skin tones.

COLOR TEMP Press the **▶▶** or **◀◀** buttons to select **NORMAL**, **COOL**, or **WARM** picture preferences. (**NORMAL** will keep the whites, white; **COOL** will make the whites, bluish; and **WARM** will make the whites, reddish.)

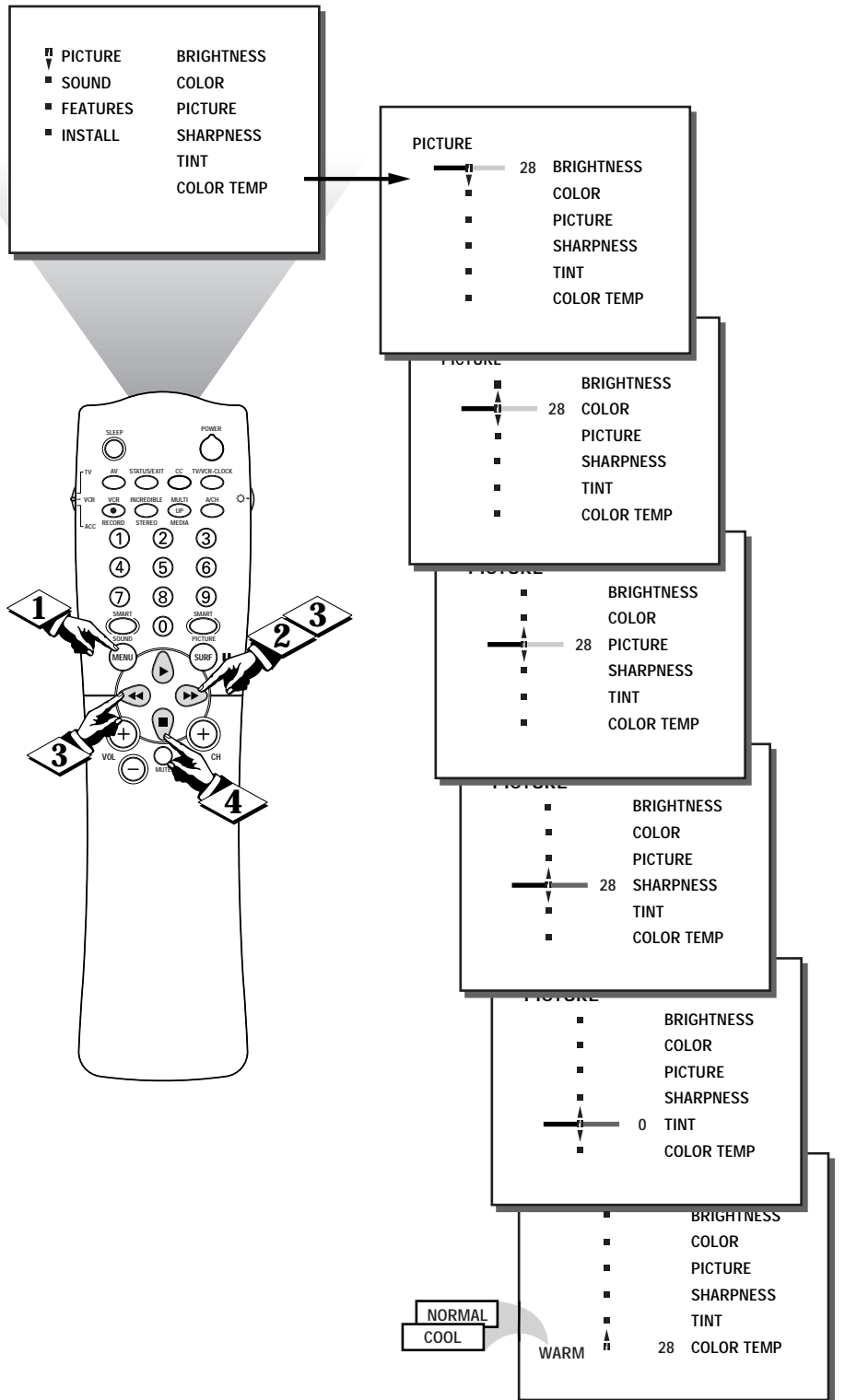

ACTIVATING THE TV'S ON TIMER CONTROL

Just like an alarm clock you can set the TV to turn itself on at the same time everyday.

BEGIN

1 Press the **MENU** button on the remote to show the on-screen menu. **PICTURE** will be highlighted.

2 Press the **CURSOR DOWN** button twice to select the **FEATURES** menu.

3 Press the **CURSOR RIGHT** button and the menu will shift to the left to display the **TIMER** controls.

4 Press the **CURSOR RIGHT** button again to shift the display left, then **CURSOR DOWN** to highlight the **ACTIVATE** timer control.

5 Press the **CURSOR RIGHT** button again to highlight the **ACTIVATE** timer option. Then, press the **CURSOR UP** or **CURSOR DOWN** buttons to turn the timer ON or OFF.



SMART HELP

Remember, be sure to set the time you want the television to turn on using the **START TIME** control as described on page 10.

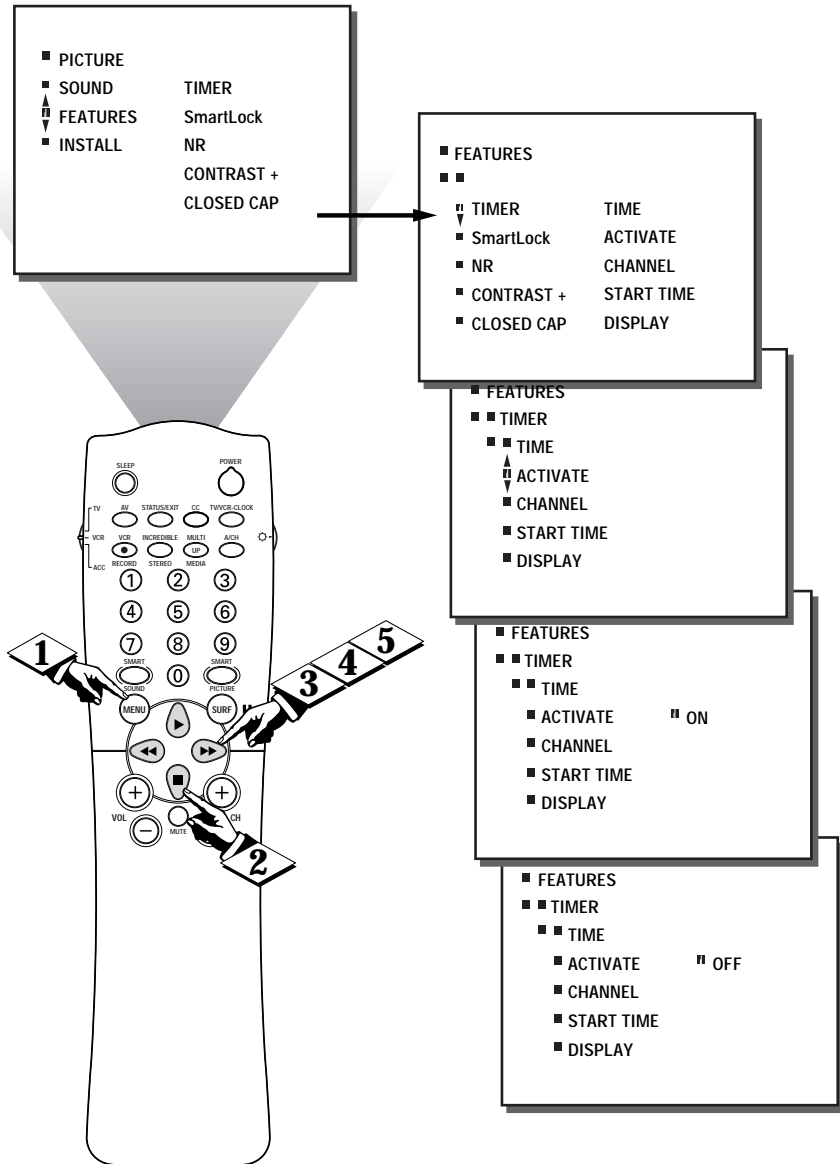

SELECTING THE TV'S ON TIMER CHANNEL

Used along with the on timer feature, you can select a specific channel that the television will tune to when the Timer **ACTIVATE** control is turned **ON**.

BEGIN

- 1 Press the **MENU** button on the remote to show the on-screen menu. **PICTURE** will be highlighted.
- 2 Press the **CURSOR DOWN** button twice to select the **FEATURES** menu.
- 3 Press the **CURSOR RIGHT** button and the menu will shift to the left to display the **TIMER** controls.
- 4 Press the **CURSOR RIGHT** button again to shift the display left, then **CURSOR DOWN** button to highlight the **CHANNEL** control.
- 5 Press the **CURSOR RIGHT** button again to highlight the channel indicator area.
- 6 Press the **NUMBERED** buttons to enter the desired start up channel. (Or, use the **CHANNEL (+)** or **(-)** buttons to select the desired channel.)

STOP

SMART HELP

Remember, be sure to turn the **Timer ACTIVATE** control **ON** after selecting the desired start up channel. (Refer to page 8 for further details.)

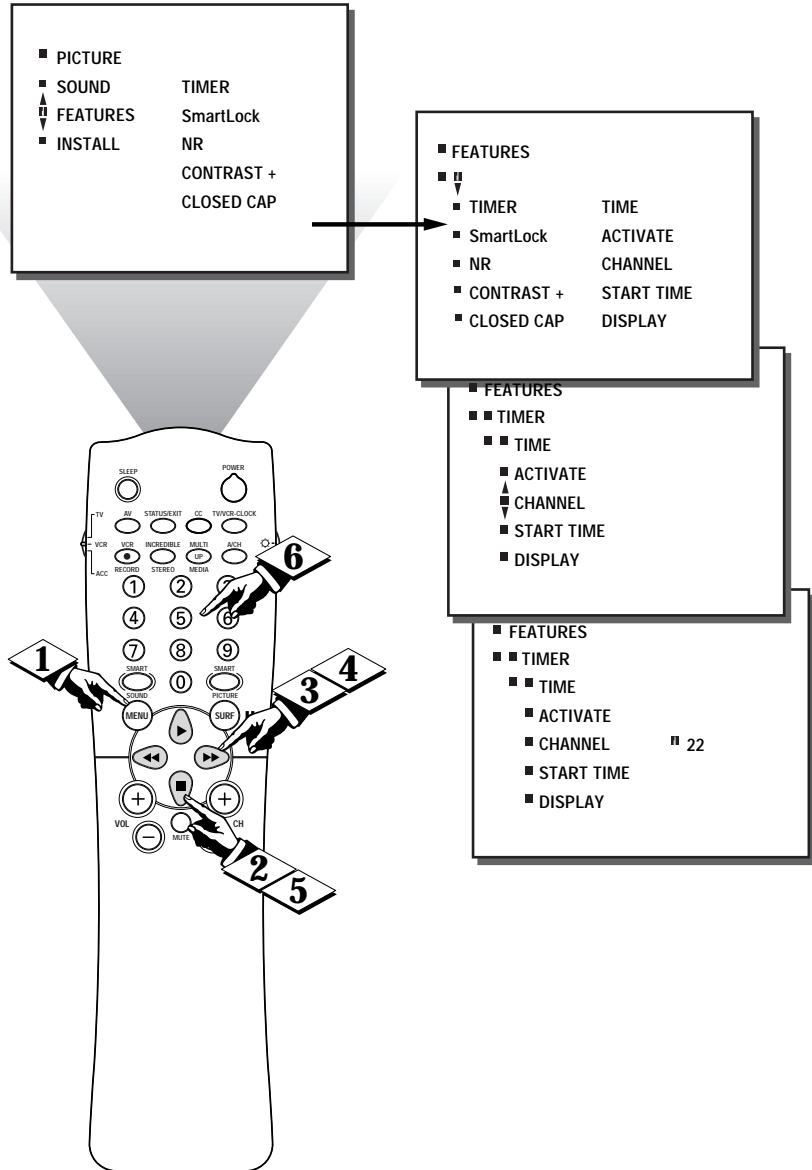

SETTING THE TV'S ON TIMER START TIME

Used along with the on timer feature, you can select a specific time the television will turn on when the Timer **ACTIVATE** control is turned **ON**.

BEGIN

- 1 Press the **MENU** button on the remote to show the on-screen menu. **PICTURE** will be highlighted.
- 2 Press the **CURSOR DOWN** button twice to select the **FEATURES** menu.
- 3 Press the **CURSOR RIGHT** button and the menu will shift to the left to display the **TIMER** controls.
- 4 Press the **CURSOR RIGHT** button again to shift the display left, then **CURSOR DOWN** to highlight the **START TIME** control.
- 5 Press the **CURSOR RIGHT** button again to highlight the time indicator area.
- 6 Press the **NUMBERED** buttons to enter the desired start up time. (Use the **CURSOR UP** or **CURSOR DOWN** buttons to set **AM** or **PM**.)



SMART HELP



Remember, be sure to turn the **Timer ACTIVATE** control **ON** after setting the desired start up time. (Refer to page 8 for further details.)

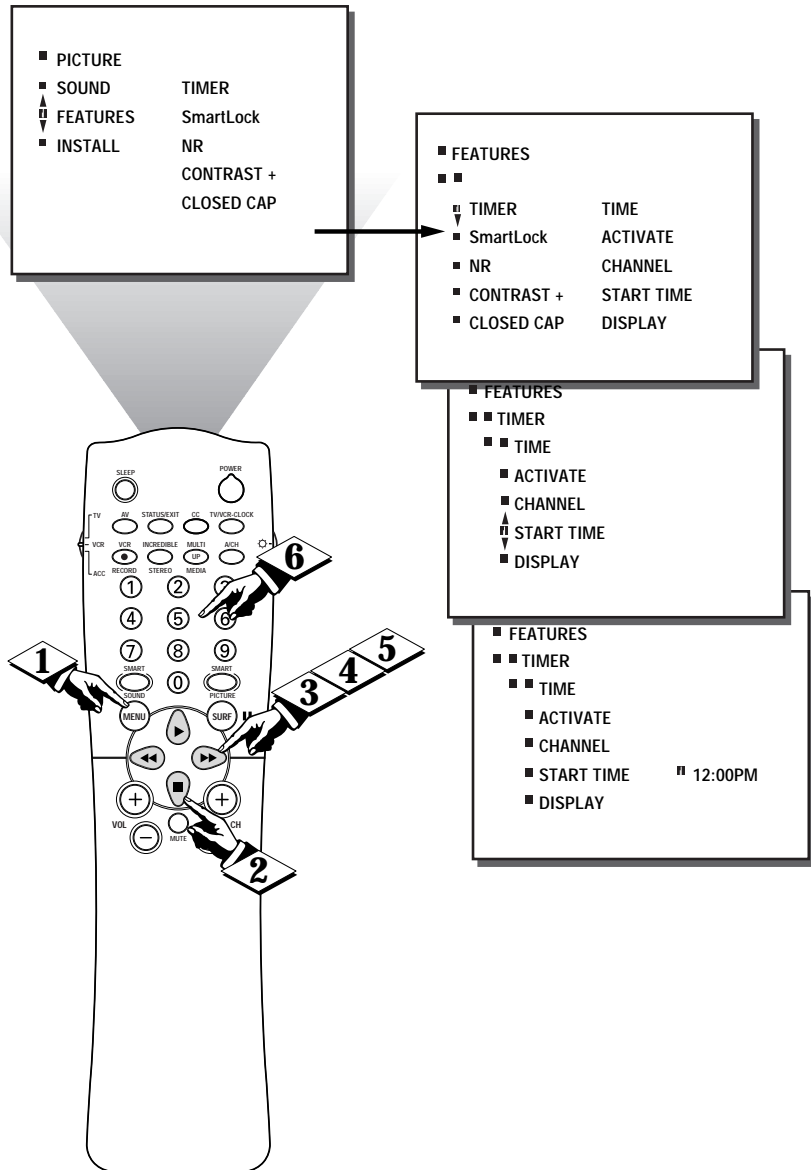

SETTING THE TV'S ON TIMER DISPLAY



Once the television clock has been set, you can use your television as a clock. The **Timer DISPLAY** control allows you to permanently display the time in the upper right corner of the screen.

BEGIN

- 1 Press the **MENU** button on the remote to show the on-screen menu. **PICTURE** will be highlighted.
- 2 Press the **CURSOR DOWN** button twice to select the **FEATURES** menu.
- 3 Press the **CURSOR RIGHT** button and the menu will shift to the left to display the **TIMER** controls.
- 4 Press the **CURSOR RIGHT** button again to shift the display left, then **CURSOR DOWN** to highlight the **DISPLAY** control.
- 5 Press the **CURSOR RIGHT** button again to highlight the **DISPLAY** control options. Then, press the **CURSOR UP** or **CURSOR DOWN** buttons to turn the timer ON or OFF.



SMART HELP



Remember, be sure you have set the television's clock with the correct current time. (Refer to page 7 to set the Clock Manually or page 2 of the Quick Use Guide to set the Clock Automatically using the Smart Clock feature.)

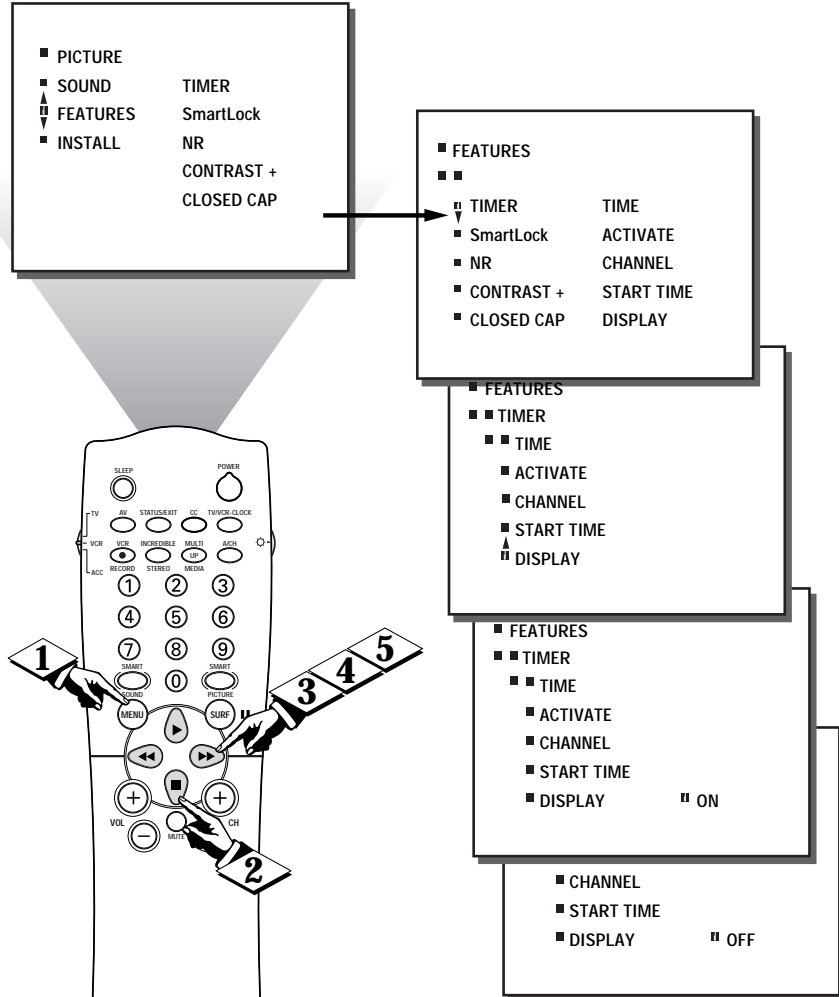

USING THE SMART LOCK (SETUP CODE) CONTROL

Smart Lock allows parents to block out, or "censor" any channels they think children should not watch. A channel blocked by the Smart Lock control cannot be viewed until a correct access code is used to unlock the channel for viewing. First let's set your Smart Lock access code:

BEGIN

1 Press the **MENU** button on the remote to show the on-screen menu. **PICTURE** will be highlighted.

2 Press the **CURSOR DOWN** button twice to select the **FEATURES** menu.

3 Press the **CURSOR RIGHT** button and the menu will shift to the left, then **CURSOR DOWN** to highlight the **SMART LOCK** control.

4 Press the **CURSOR RIGHT** button again to shift the display left, then **CURSOR DOWN** to highlight **SETUP CODE**.

5 Press the **CURSOR RIGHT** button. "---- Enter current access code" will appear within the menu.

6 Press **0, 7, 1, 1** on the remote. "XXXX" shows on the **SETUP CODE** display as you press the **NUMBER** buttons. "XXXX Incorrect - Please re-enter your access code" will appear. Re-enter the **0, 7, 1, 1** code on the remote. "XXXX Code Correct" will appear.

7 "Next enter your new access code" shows on the screen. Press the **NUMBER** buttons on the remote to enter a **NEW** four digit code. Confirm your new code by re-entering it again. "XXXX Code changed" shows on the screen to let you know the new code has been set.

Continue to the next page to learn how to block channels from viewing.

NOTE: The 0,7,1,1 access code shown on this page is the default code or way to reset the code when the current access code is not known.

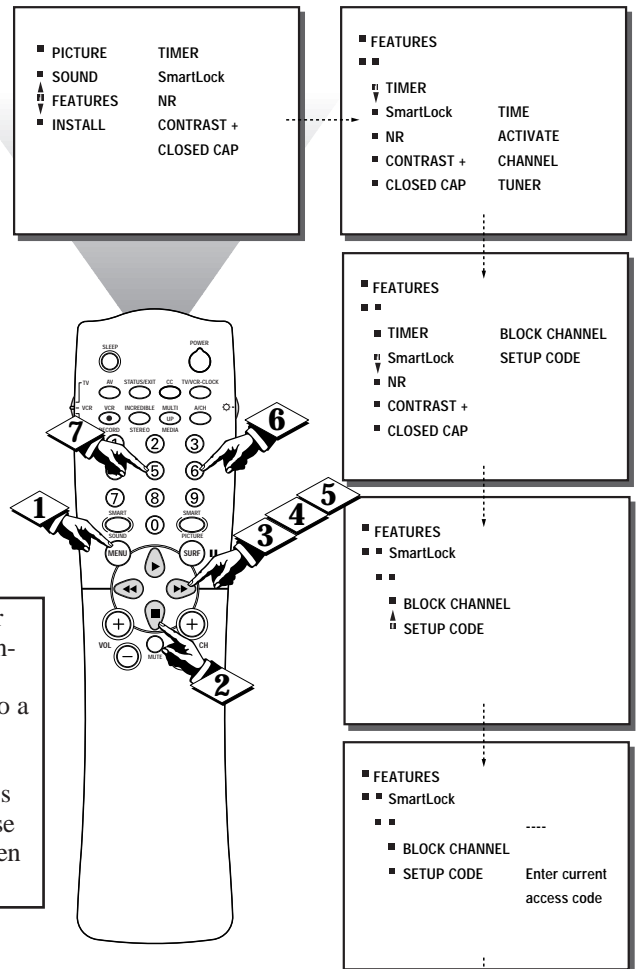

Parents - it isn't possible for your child to unblock a channel without knowing your access code or changing it to a new one. If your code changes, and you didn't change it, then you know it's been altered by someone else and block channels have been viewed.

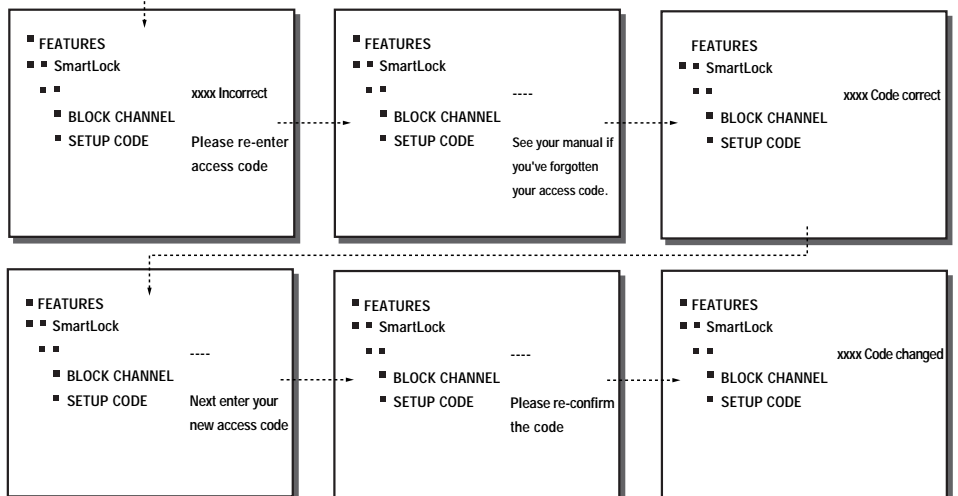

USING THE SMART LOCK (BLOCK CHANNEL) CONTROL



After your personal access code has been set (see previous page), you are now ready to select up to 5 channels or inputs to block out or censor.

BEGIN

- 1 Press the **MENU** button on the remote to show the on-screen menu. **PICTURE** will be highlighted.
 - 2 Press the **CURSOR DOWN** button twice to select the **FEATURES** menu.
 - 3 Press the **CURSOR RIGHT** button and the menu will shift to the left, then **CURSOR DOWN** to highlight the **SMART LOCK** control.
 - 4 Press the **CURSOR RIGHT** button again to shift the display left, the **BLOCK CHANNEL** control will be highlighted.
 - 5 Press the **CURSOR RIGHT** button. "---- Enter current access code" will appear within the menu.
 - 6 Enter the correct access code number. "XXXX" shows on the SETUP CODE display as you press the **NUMBER** buttons. "XXXX Code correct" will appear.
 - 7 Press the **CHANNEL (+)** or **(-) buttons** (or **NUMBER** buttons) to select the channel you want to block.
 - 8 Press the **CURSOR RIGHT** button to block viewing of the channel, or the **CURSOR LEFT** button to allow viewing of the channel.
- Repeat steps 5 through 7 for any other channels you wish to block from viewing.

Note: You can also block out the use of the A/V external inputs on the rear of the TV. This stops the viewing of VCR, DVD, etc., programs which can be shown through the A/V Input jacks. Select AV 1, AV 2, or SVID-R, MM1, MM2, MM3, and select block.

Any channel that has been blocked will be skipped when the Channel (+) and (-) buttons are used to scan all available channels. To view a blocked channel, press the number buttons on the remote to directly access the channel and refer to the Unblocking Channels section below.

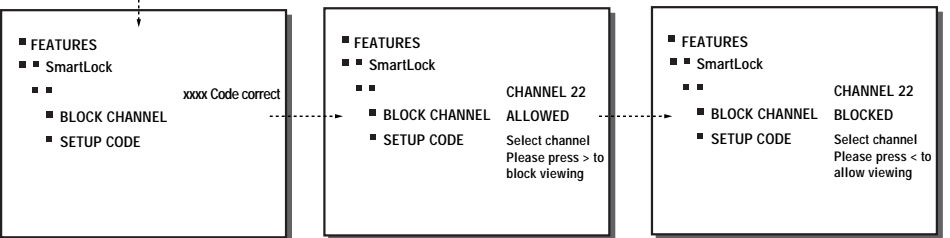
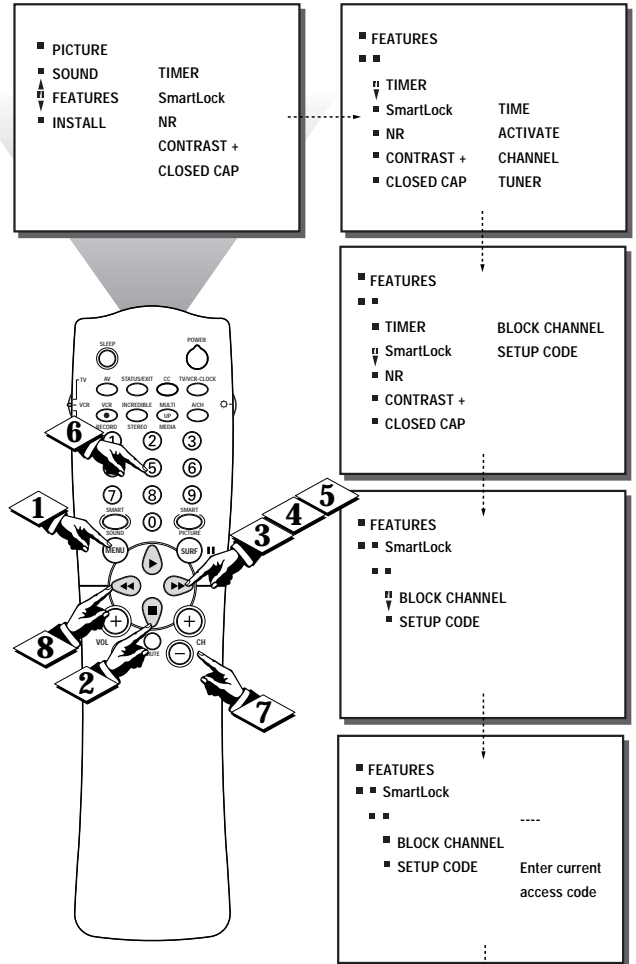

UNBLOCKING CHANNELS

- 1 Access the blocked channel directly by using the number buttons on the remote control.
- 2 Enter your four digit access code.
- 3 All blocked channels will be viewable until the TV is turned off. When the TV is turned back on, the blocked channels will not be viewable.

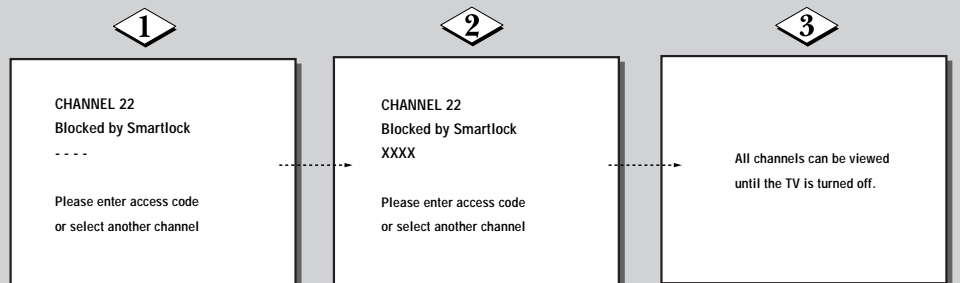

TURNING ON THE NOISE REDUCTION (PICTURE) CONTROL

Due many reason such as poor cable reception, the picture can sometime appear slightly "speckled" (noise in the picture). The NR (Noise Reduction) control can help eliminate this type of interference and improve the quality of the picture.

(BEGIN)

- 1 Press the **MENU** button on the remote to show the on-screen menu. **PICTURE** will be highlighted.
- 2 Press the **CURSOR DOWN** button twice to select the **FEATURES** menu.
- 3 Press the **CURSOR RIGHT** button and the menu will shift to the left, **TIMER** will be highlighted.
- 4 Press the **CURSOR DOWN** button to highlight the **NR** control.
- 5 Press the **CURSOR RIGHT** button again to highlight the **NR** option area.
- 6 Press the **CURSOR UP** or **CURSOR DOWN** buttons to turn the **NR** feature **ON** or **OFF**.

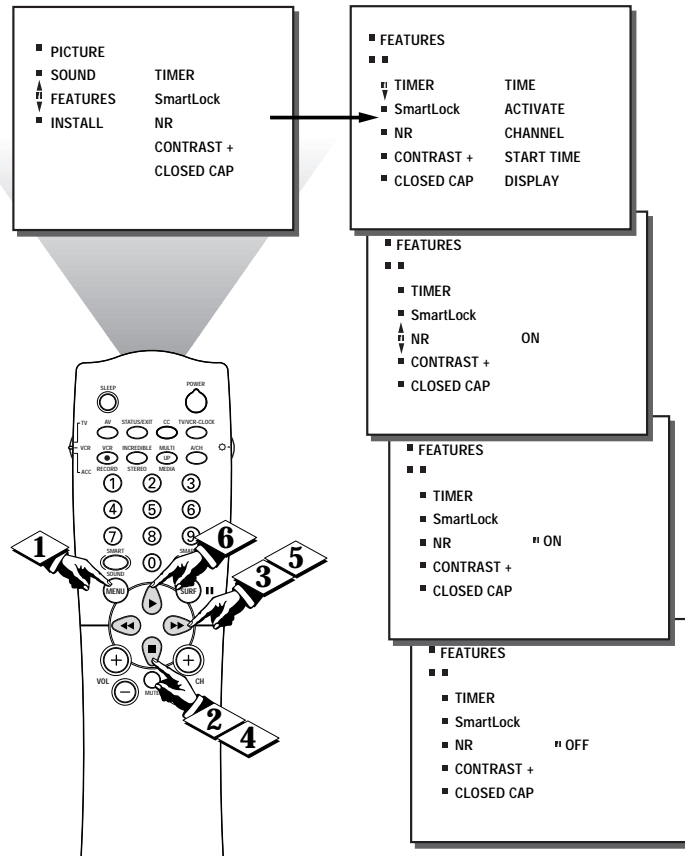

TURNING ON THE CONTRAST + CONTROL

The Contrast + feature helps to "sharpen" the picture quality. The black portions of the picture become richer in darkness and the whites become brighter.

(BEGIN)

- 1 Press the **MENU** button on the remote to show the on-screen menu. **PICTURE** will be highlighted.
- 2 Press the **CURSOR DOWN** button twice to select the **FEATURES** menu.
- 3 Press the **CURSOR RIGHT** button and the menu will shift to the left, **TIMER** will be highlighted.
- 4 Press the **CURSOR DOWN** button to highlight the **CONTRAST +** control.
- 5 Press the **CURSOR RIGHT** button again to highlight the **CONTRAST +** option area.
- 6 Press the **CURSOR UP** or **CURSOR DOWN** buttons to turn the **CONTRAST +** feature **ON** or **OFF**.

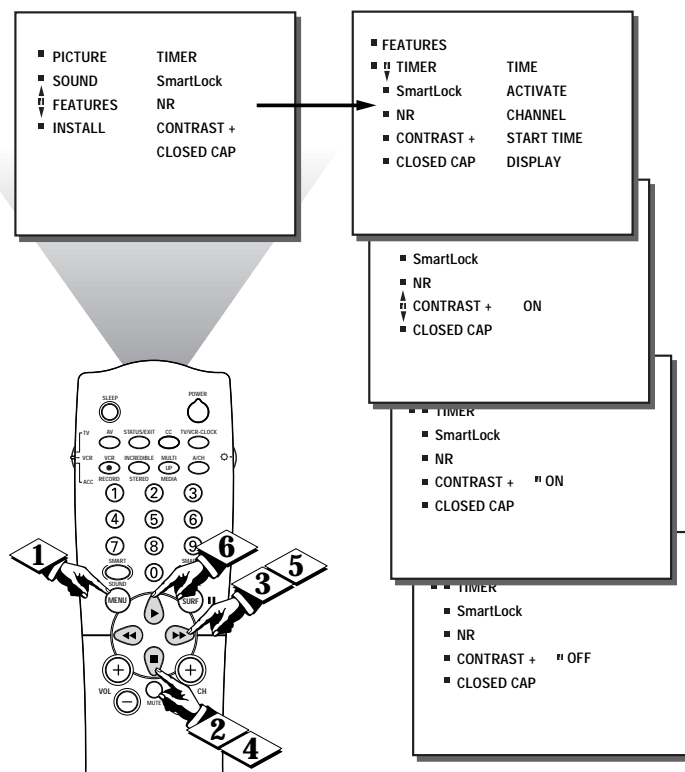

USING THE CLOSED CAPTION CONTROL

Closed Captioning (CC) allows you to read the voice content of television programs on the TV screen. Designed to help the hearing impaired, this feature uses on-screen "text boxes" to show dialogue and conversations while the TV program is in progress.

(BEGIN)

- 1 Press the **MENU** button on the remote to show the on-screen menu. **PICTURE** will be highlighted.
- 2 Press the **CURSOR DOWN** button twice to select the **FEATURES** menu.
- 3 Press the **CURSOR RIGHT** button and the menu will shift to the left, **TIMER** will be highlighted.
- 4 Press the **CURSOR DOWN** button to highlight the **CLOSED CAP** control.
- 5 Press the **CURSOR RIGHT** button again to highlight and choose either **CAPTION MODE** or **TEXT MODE**.
- 6 Press the **CURSOR RIGHT** button again to highlight the **CAPTION MODE** or **TEXT MODE** options area.
- 7 Press the **CURSOR UP** or **CURSOR DOWN** buttons to select the **CLOSED CAPTION** option you want.

CAPTION MODE: CC1, CC2, CC3, CC4, CC MUTE, or OFF -dialogue (and descriptions) for the action on the captioned TV program shows on-screen.

TEXT MODE: TXT1, TXT2, TXT3, TXT4, or OFF -often used for channel guide, schedules, or bulletin board information for CC programs.



NOTE: Not all TV programs and product commercials are made for broadcast with Closed Caption (CC) information included. Neither are all Closed Caption modes (CAPTION 1-4, or TEXT 1-4) necessarily being used by a broadcast station during the transmission of a closed caption program. Refer to your area's TV program listings for the stations and times of Closed Caption shows.

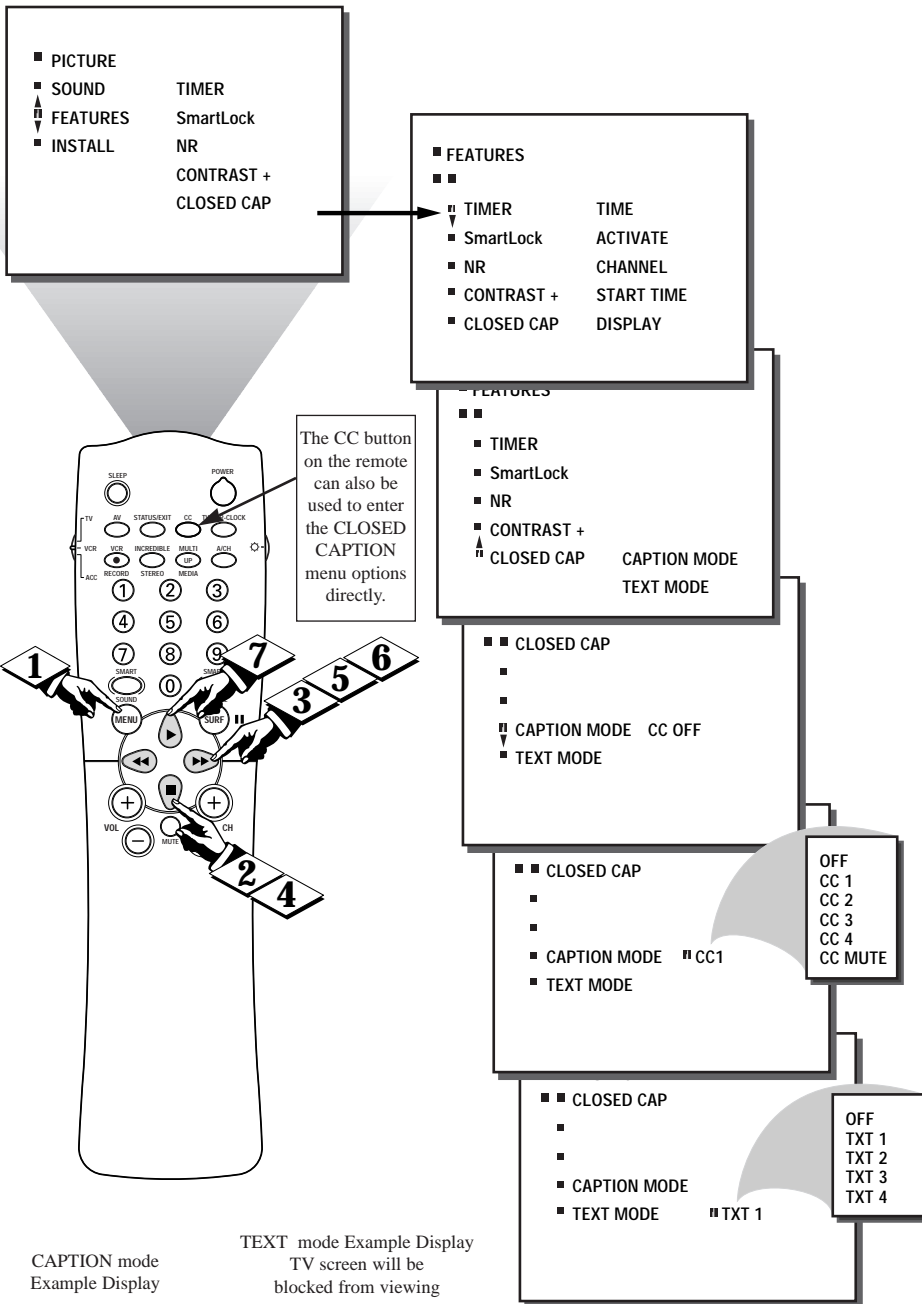

NOTE: The CC MUTE option can be used to set the TV to turn the Closed Caption mode "ON" whenever the MUTE button on the remote is pressed.

USING THE SLEEP TIMER CONTROL

Have you ever fallen asleep in front of the TV only to have in wake you up at two in the morning with a test pattern screeching in your ears? Well, your TV can save you all that trouble by automatically turning itself off.

BEGIN

1 Press the **SLEEP** button on the remote control and the **SLEEP** timer on-screen display will appear in the lower center of the display.

2 Press the **SLEEP** button repeatedly to pick the amount of time (15 minutes to 2 hours ahead) before the TV will turn itself off.

An on-screen count down will appear during the last minute before the TV shuts itself off.

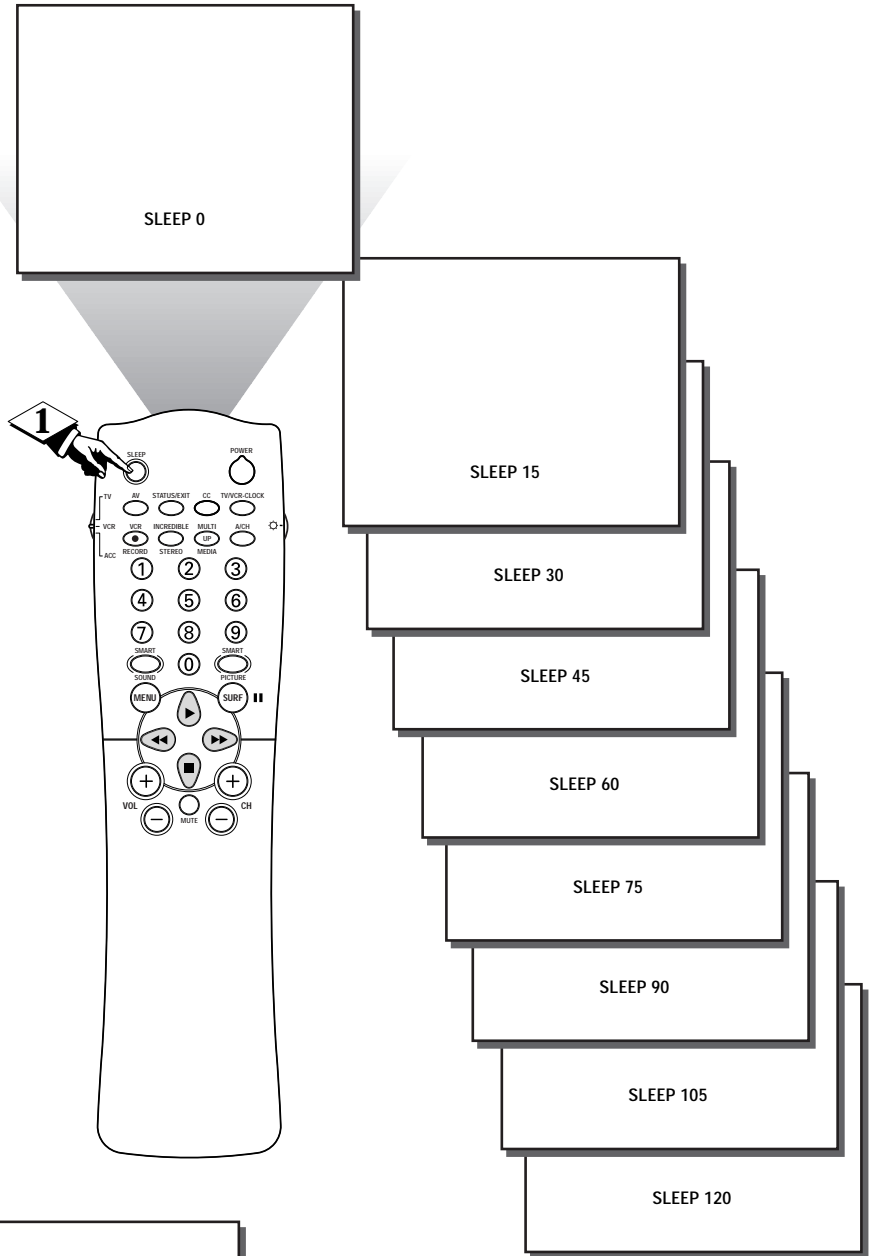

During the last minute of a SLEEP timer setting, an on-screen count down will be displayed.

SLEEP 58

GOOD BYE

During the last 10 seconds of a SLEEP timer setting, an on-screen display will read GOOD BYE.

SLEEP 8

USING TREBLE, BASS, AND BALANCE SOUND CONTROLS

Besides the normal volume level control, your TV also has individual sound adjustment controls. The **TREBLE** (high frequency), **BASS** (low frequency), and **Speaker BALANCE** may all be used to adjust the sound playback of TV programs.

BEGIN

1 Press the **MENU** button on the remote to show the on-screen menu. **PICTURE** will be highlighted.

2 Press the **CURSOR DOWN** button to select the **SOUND** menu.

3 Press the **CURSOR RIGHT** button and the menu will shift to the right to display an adjustment bar in front of the **TREBLE** control.

4 Use the **CURSOR LEFT** or **RIGHT** buttons to adjust the **TREBLE** (high frequency) level of the television's sound.

5 After adjusting the **TREBLE** control, press the **CURSOR DOWN** button to select another Sound adjustment; **BASS** or **BALANCE**. Use the **CURSOR LEFT** or **RIGHT** buttons to adjust the selected control.



SMART HELP



Remember, when the bar scale is centered, **Speaker BALANCE** is centered between the TV's Left and Right side speakers.

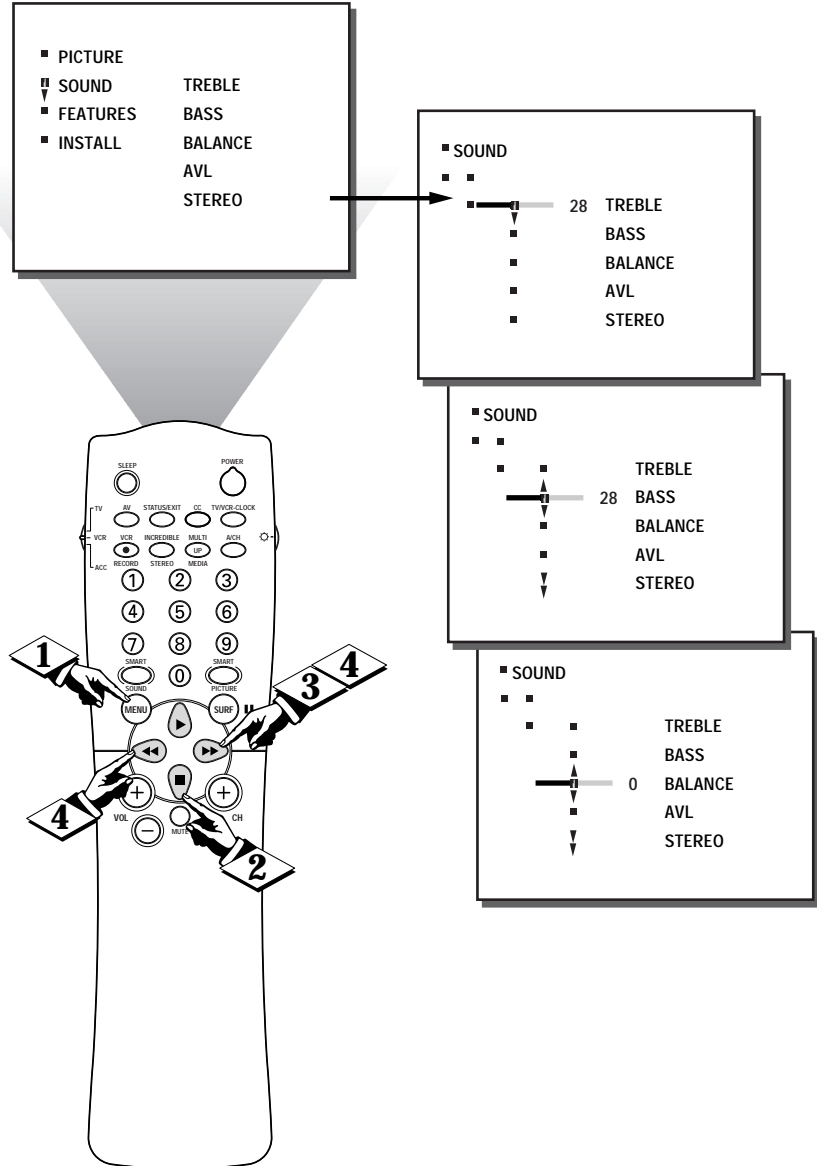

HOW TO SET THE TV FOR STEREO PROGRAMS

Your TV can receive broadcast stereo TV programs. The TV has both an amplifier and twin speakers through which the stereo sound can be heard.

BEGIN

- 1 Press the **MENU** button on the remote to show the on-screen menu. **PICTURE** will be highlighted.
- 2 Press the **CURSOR DOWN** button to select the **SOUND** menu.
- 3 Press the **CURSOR RIGHT** button and the menu will shift to the right to display an adjustment bar in front of the **TREBLE** control.
- 4 Press the **CURSOR DOWN** button to select the **STEREO** control.
- 5 Use the **CURSOR LEFT** or **RIGHT** buttons to select **STEREO** or **MONO**. With **STEREO** selected the television will reproduce any stereo broadcast signal it receives.

STOP

SECOND AUDIO PROGRAM (SAP)

SAP is an additional part of the stereo broadcast system. Sent as a third audio channel SAP can be heard apart from the current TV program sound. TV stations are free to use SAP for any number of purposes, but many experts believe it will be used for foreign language translations of TV shows (or for weather and news bulletins.)

If a SAP signal is not present with a selected program, the SAP option cannot be selected. Also, if SAP is selected on a channel (with SAP) and you select another channel, when you return to the original channel SAP will be OFF (and you will have to reselect the SAP feature.)

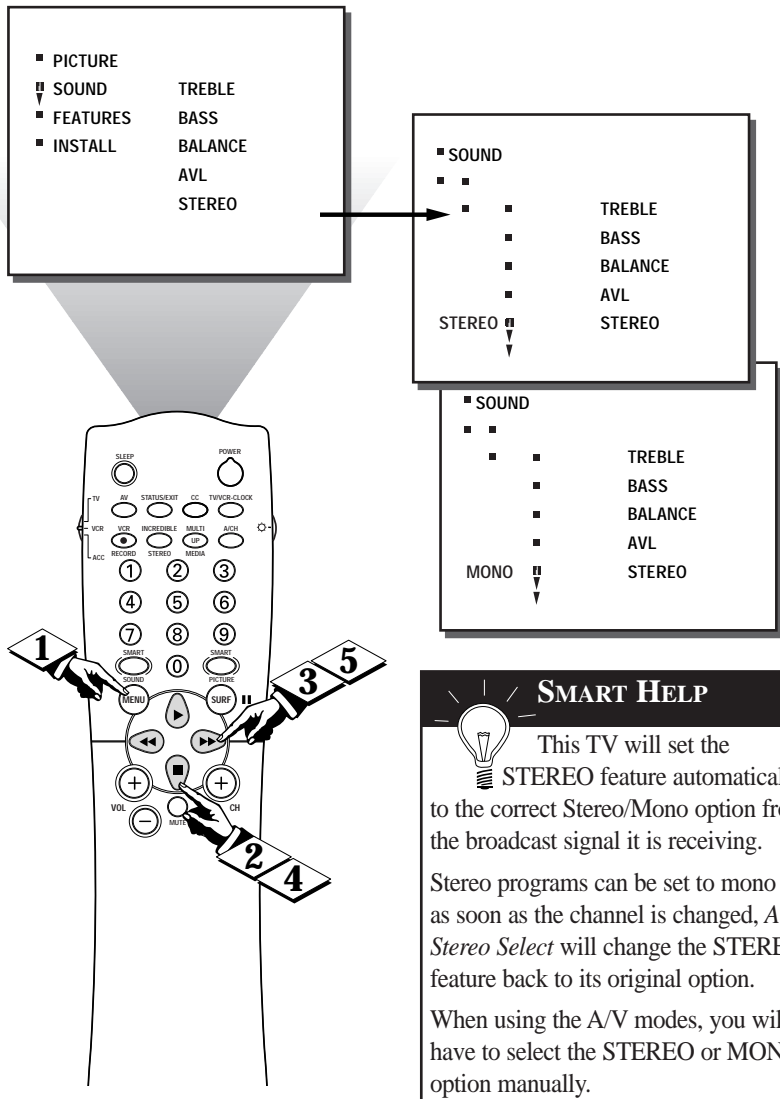

SMART HELP

This TV will set the STEREO feature automatically to the correct Stereo/Mono option from the broadcast signal it is receiving.

Stereo programs can be set to mono but as soon as the channel is changed, *Auto Stereo Select* will change the STEREO feature back to its original option.

When using the A/V modes, you will have to select the STEREO or MONO option manually.

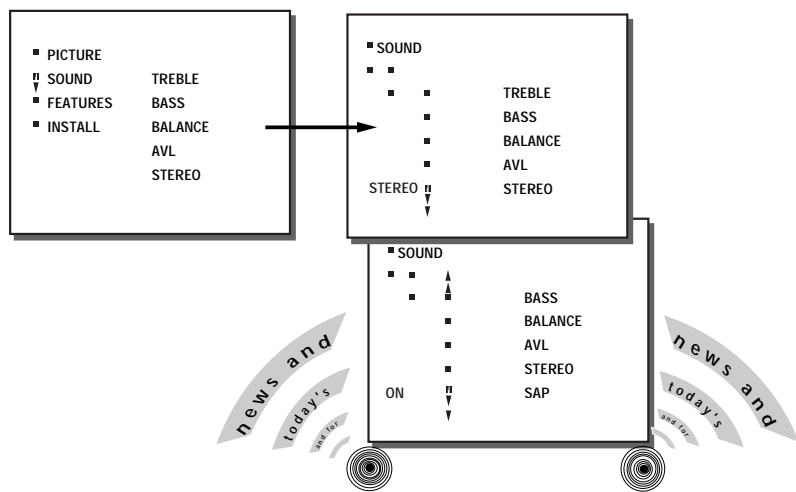

USING THE INCREDIBLE STEREO FEATURE



The Incredible Stereo feature adds greater depth and dimension to both monaural (MONO) and stereo TV sound. With the control turned ON the TV's speakers can add even wider sound separation to normal broadcasts.

BEGIN

- 1 Press the **INCREDIBLE STEREO** button on the remote to turn the Incredible Stereo feature ON.

When the TV signal is being received in STEREO, the on-screen display will read **INCR. STEREO**.

When the TV signal is being received in MONO, the on-screen display will read **SPATIAL**.

Both will give increased TV sound performance when watching movies or musical programs.

STOP

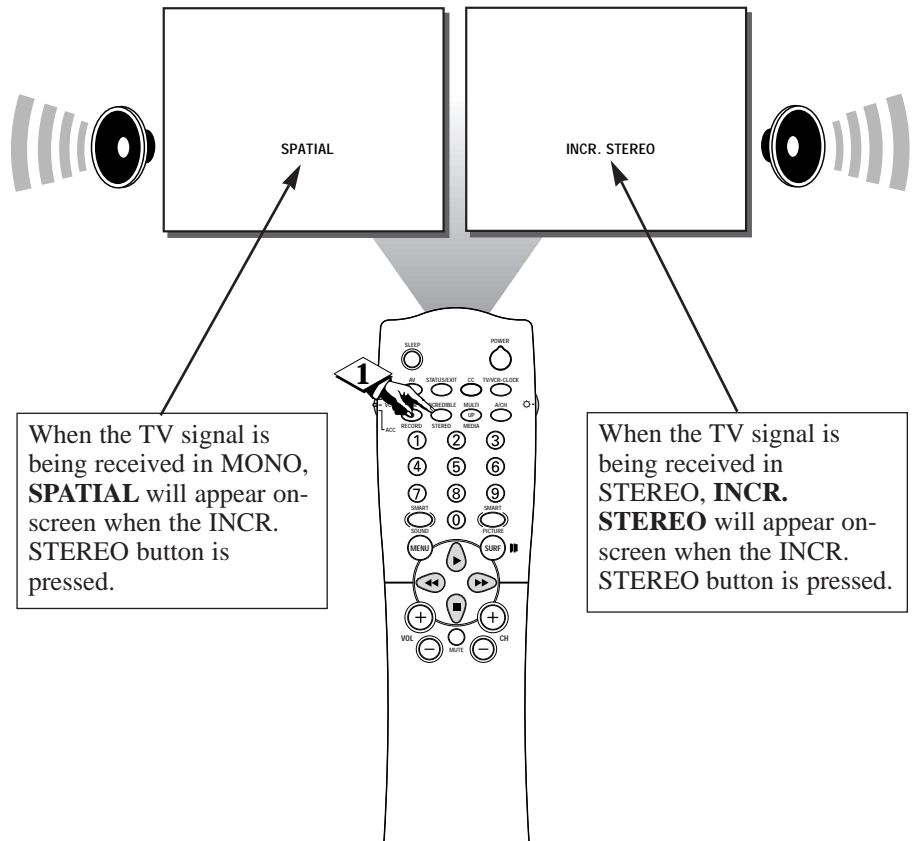

USING THE TV VOLUME BAR CONTROL

Use the Volume Bar control to see the TV's volume level settings on the TV screen. The Volume Bar will be seen each time the VOLUME buttons (on the TV or remote) are pressed.

BEGIN

- 1 Press the **VOLUME (+) or (-) buttons** on the remote to show the VOLUME bar display on-screen.

Press the **VOLUME (+) or (-) buttons** again to adjust the television's sound level.

STOP

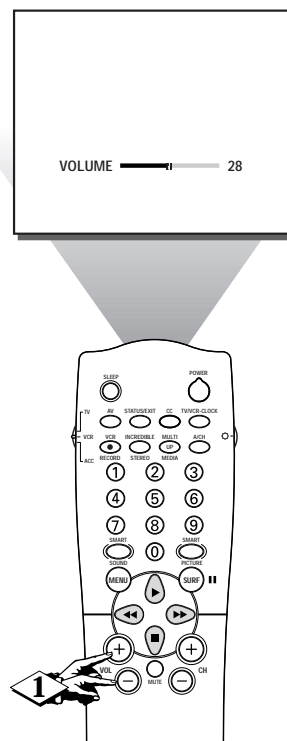

SMART HELP



Try it out. Press the VOL (+) and (-) buttons. The VOLUME BAR should appear near the bottom center of the screen.

USING THE TV SPEAKER CONTROL AND AUDIO OUTPUT JACKS

Would you like to hear TV programs through your audio hi-fi system? The TV's Audio Output jacks and TV Speaker On/Off control work together to offer you this TV sound option.

BEGIN

1 Connect the **R(ight) and L(left) AUDIO OUT** jacks on the TV to the R and L Audio Input jacks on your amplifier or sound system. Set the audio system's volume to normal listening level.

2 Turn the TV and audio system ON. You can now adjust the sound level coming from the audio system with the **VOLUME (+) or (-)** buttons on the TV or remote.

3 To hear the TV sound from only the audio system speakers. Press the **MENU** button on the remote to show the on-screen menu. **PICTURE** will be highlighted.

4 Press the **CURSOR DOWN** button to select the **SOUND** menu.

5 Press the **CURSOR RIGHT** button and the menu will shift to the right to display an adjustment bar in front of the **TREBLE** control.

5 Press the **CURSOR DOWN** button to select the **SPEAKER** control.

5 Use the **CURSOR UP** or **DOWN** buttons to select turn the television's speakers **OFF**. You should now only hear TV sound coming from the audio system speakers.



SMART HELP

Remember, the audio system may have to be in **AUX(iliary)** mode to play sound from the TV.

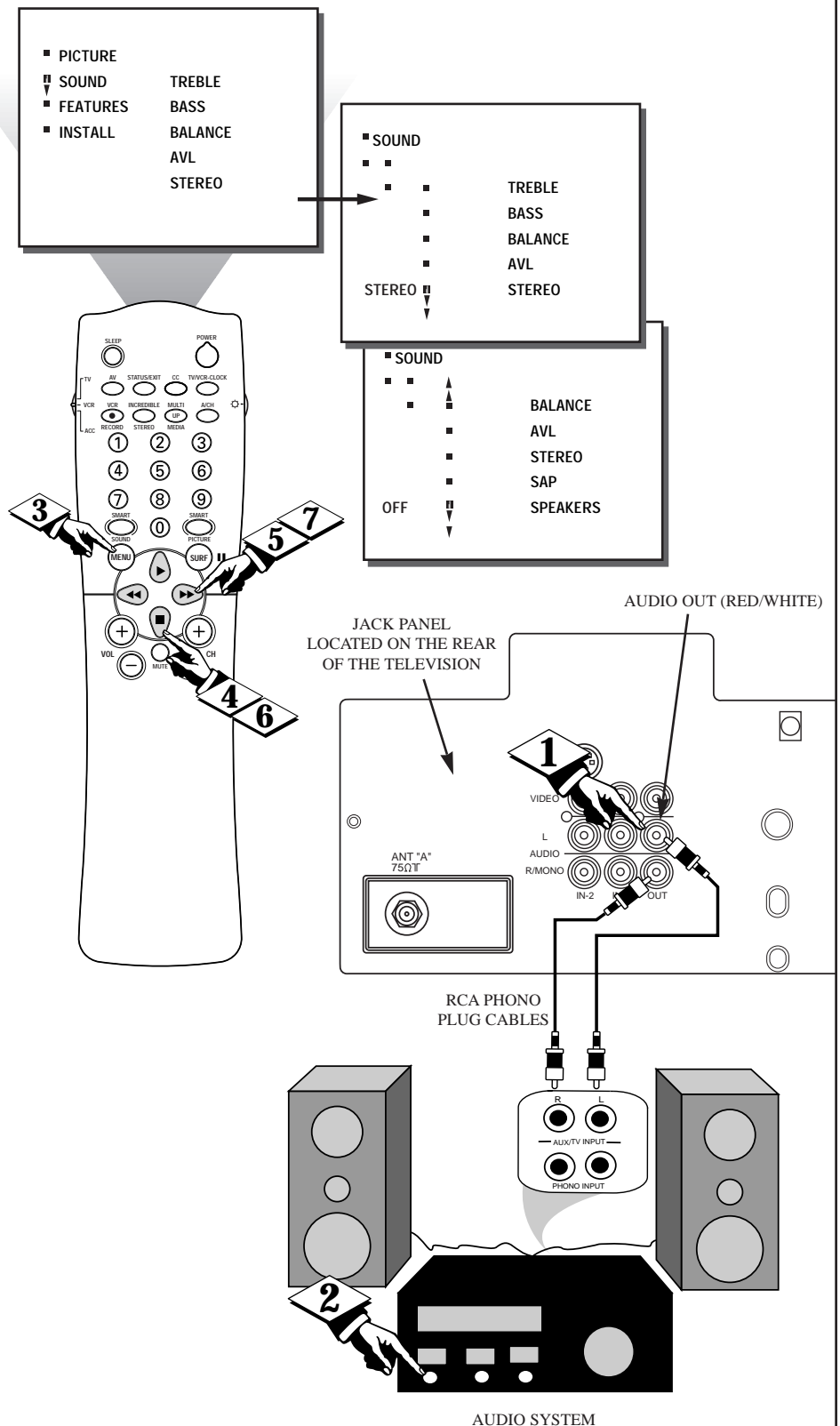

HOW TO USE THE AUDIO/VIDEO INPUT JACKS

AUDIO/VIDEO INPUTS

The TV's Audio/Video Input jacks are for direct picture and sound connections between the TV and a VCR (or similar device) that has Audio/Video Output jacks.

BEGIN

1 Connect the **VIDEO (yellow) CABLE** to the VIDEO IN jack on the back of the TV. Then connect the **AUDIO (red and white) CABLES** to the AUDIO (left and right) IN jacks on the rear of the TV.

2 Connect the **VIDEO (yellow) CABLE** to the VIDEO OUT jack on the back of the VCR. Then connect the **AUDIO (red and white) CABLES** to the AUDIO (left and right) OUT jacks on the rear of the VCR.

3 Turn the VCR and the TV ON.

4 Use the **A/V button** on the remote to select the AV 1 channel.

With the VCR ON and a pre-recorded tape inserted, **press the PLAY button** to view the tape on the television.



NOTE: Repeatedly pressing the AV button on the remote will toggle the picture source from the current channel (Tuner A or B), to the SVID-R connection, to the AV 1 connection, to the AV 2 connection. This also applies to the Multi Media button on the remote. Repeatedly pressing the Multi Media button will toggle the picture source from the current channel (Tuner A or B), to the MM 1 (SVID-R) connection, to the MM 2 (AV 1) connection, to the MM 3 (AV 2) connection.

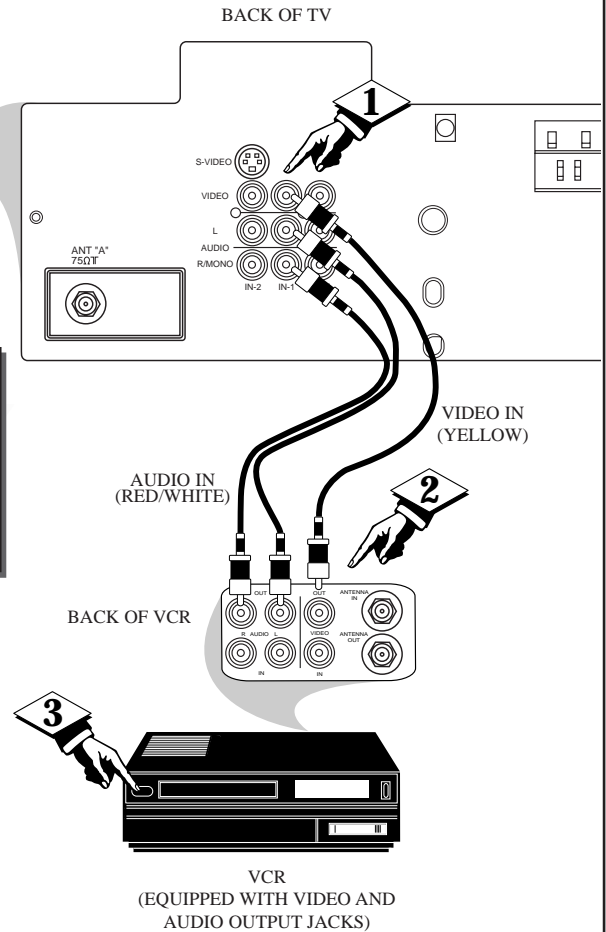
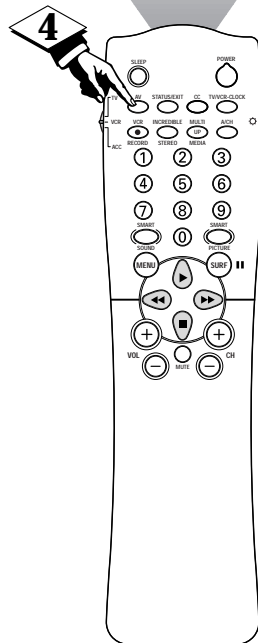
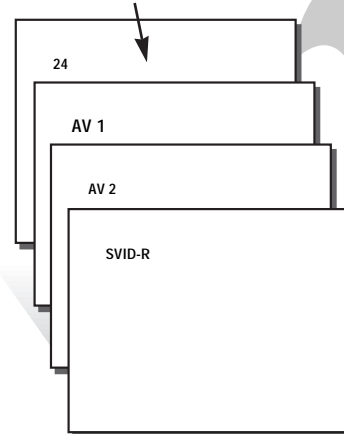

IF YOU ARE USING A MONO DEVICE, USE ONLY THE AUDIO R/MONO JACK.

SMART HELP

Remember, after it is connected an easy way to select the VCR mode is to press the TV/VCR button on the remote. Channel 3 and 4 can also be selected this way.

HOW TO USE THE AUDIO/VIDEO INPUT JACKS

S-VIDEO INPUT

The *S(uper)-Video* connection on the rear of the television can give you better picture detail and clarity, for the playback of S-VHS VCR tapes, or Digital Video Discs than the normal antenna picture connections.

Note: The VCR (or Digital Video Disc player) must have a S-VIDEO OUT(put) jack in order for you to complete the connections shown on this page.

BEGIN

- 1 Connect the S-VIDEO CABLE** to the S-VIDEO input jack on the rear of the television, then the AUDIO (red and white) to the AUDIO IN (IN 2) jacks on the rear of the TV.
- 2 Connect the S-VIDEO CABLE** to the S-VIDEO output jack on the accessory device. Then connect the red and white AUDIO CABLES to the AUDIO (left and right) output jacks on the rear of the accessory device.
- 3 Turn the VCR (or Digital Video Disc Player) ON.**
- 4 Press the AV button** on the remote to tune to the SVID-R channel. You are now ready to view the tape or disc on the TV.



SMART HELP

The S-VIDEO and VIDEO IN-2 Inputs are in parallel. The S-VIDEO input is dominate when in use. If separate video signals are connected to the S-Video and the VIDEO IN-2 Inputs, the signal from the VIDEO IN-2 input will be unuseable.

If you have added SVID-R to the TV's channels memory, just press the CHANNEL + or - buttons to select the S-VIDEO mode.

NOTE: Repeatedly pressing the AV button on the remote will toggle the picture source from the current channel (Tuner A or B), to the SVID-R connection, to the AV 1 connection, to the AV 2 connection.

This also applies to the Multi Media button on the remote. Repeatedly pressing the Multi Media button will toggle the picture source from the current channel (Tuner A or B), to the MM 1 (SVID-R) connection, to the MM 2 (AV 1) connection, to the MM 3 (AV 2) connection.

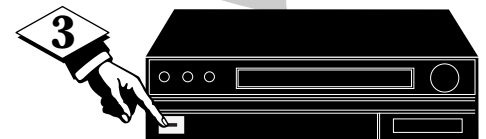
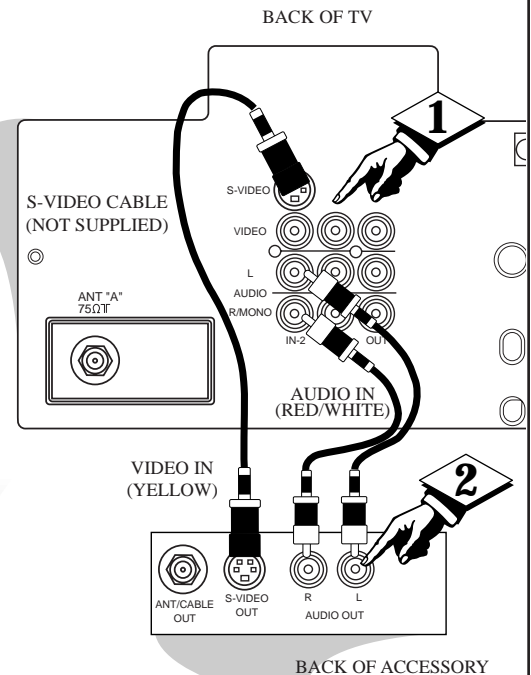
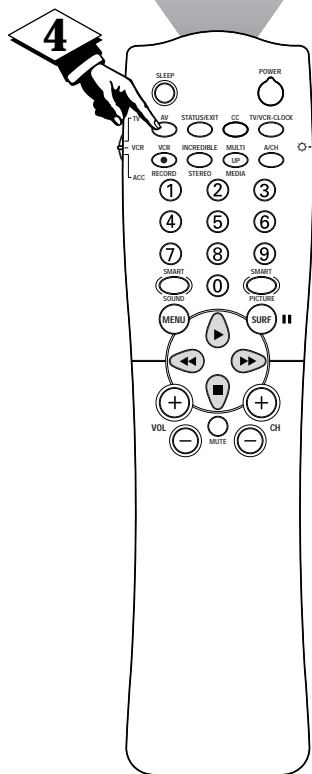
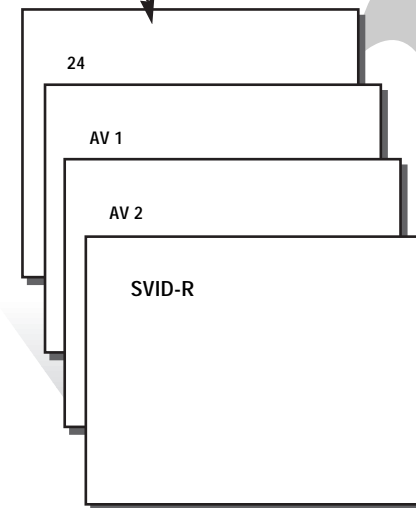

DSS, DVD, Video Game, etc.
(EQUIPPED WITH S-VIDEO AND AUDIO OUTPUT JACKS)

IF YOU ARE USING A MONO DEVICE, USE ONLY THE AUDIO R/MONO JACK.

USING THE SMART PICTURE CONTROL



Whether you're watching a movie or a video game, your TV has automatic video control settings matched for your current program source or content. The Smart Picture feature quickly resets your TV's video controls for a number of different types of programs and viewing conditions you may have in your home. Each Smart Picture setting is preset at the factory to automatically adjust the TV's Brightness, Color, Picture, Sharpness, Tint, and Color Temperature levels.

BEGIN

1 Press the **SMART PICTURE** button on the remote control. The current Smart Picture setting will appear in the middle of the screen.

2 Press the **SMART PICTURE** button repeatedly to select either **PERSONAL**, **MOVIES**, **SPORTS**, **WEAK SIGNAL**, or **MULTI MEDIA** picture settings.

Note: The **PERSONAL** settings and the **PICTURE** options within the on-screen menu are one in the same. This is the only option in Smart Picture that can be changed. To adjust these settings, use the options within the on-screen menu. All other settings are setup at the factory during the time of production and cannot be adjusted.

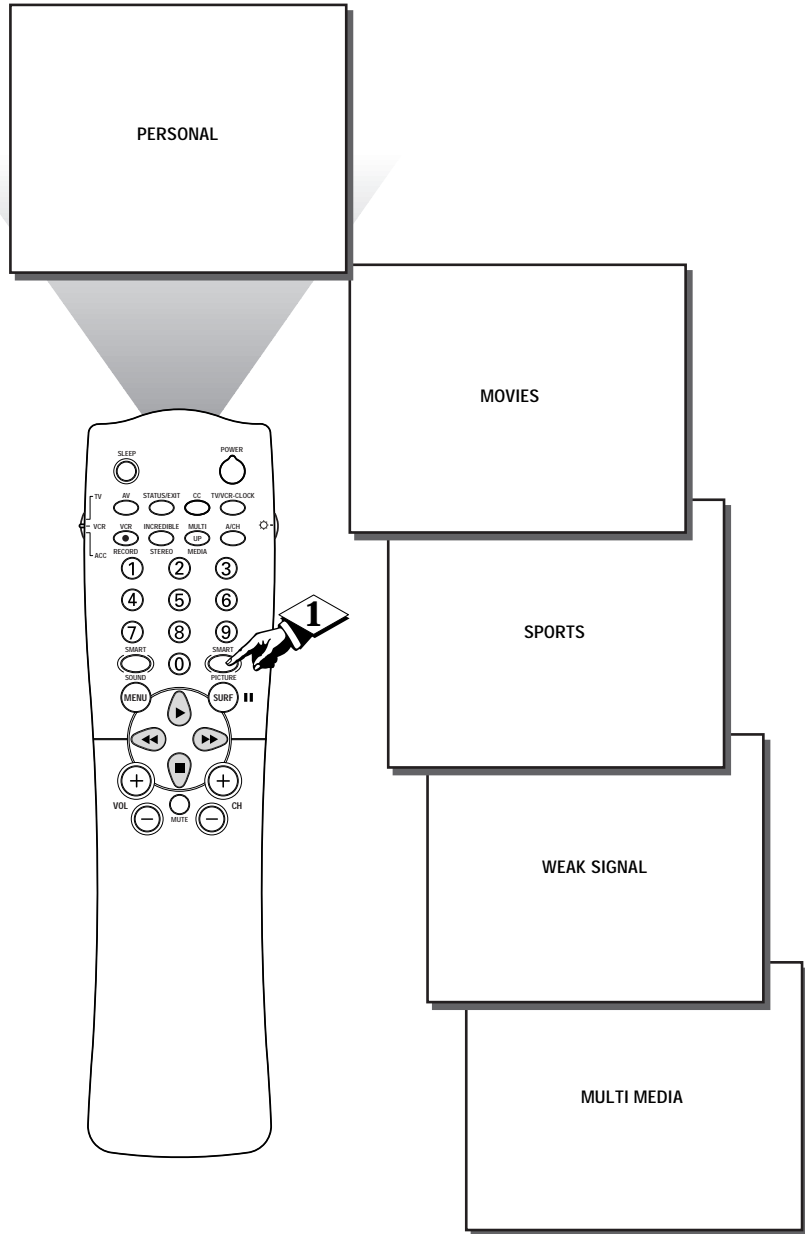

USING THE TV'S CHANNEL SURF CONTROL



A "list" or series of previously viewed channels can be selected with the SURF button on your remote control. With this feature you can easily switch between different TV programs that currently interest you. The SURF control allows you set up to ten channels in its quick viewing "list".

BEGIN

- 1 Press the CHANNEL (+) or (-) buttons (or the NUMBER buttons) to select a channel to add to the SURF list.
- 2 Press the SURF button on the remote. The on-screen display will read, "THE SURF LIST IS EMPTY, Press > to add".
- 3 Press the CURSOR RIGHT button to add the present channel to the SURF list.
- 4 Press the CURSOR LEFT button to delete the present channel from the SURF list.

Repeat steps 1 through 3 to add additional channels (up to 10) to the SURF list.



A/CH BUTTON

Your remote also has an A/CH (Alternate Channel) button. Pressing this button will toggle between the Current and one previous channel.

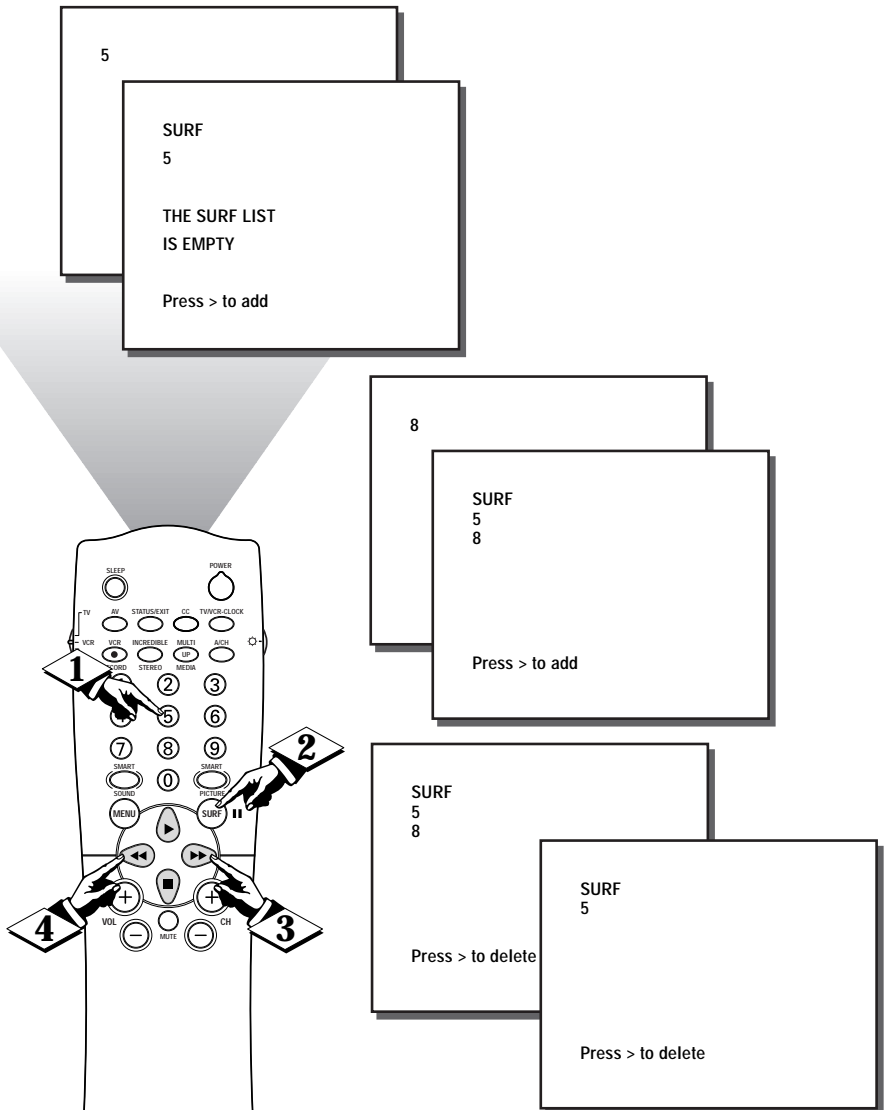
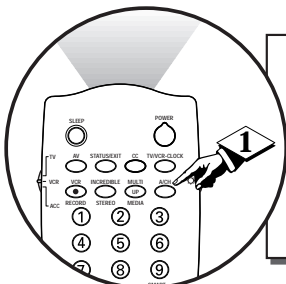

Along with regular programmed channels, the External Video Source connections can be added to the SURF list. This means the AV 1, AV 2, SVID-R, MM 1, MM 2, and MM 3 channels can be added to your SURF list. Just tune to their channel and use the same procedure described on this page.

SETTING THE REMOTE CONTROL TO WORK WITH OTHER DEVICES

Your remote control is set to work your TV and many infrared remote (IR) control VCRs, Cable Boxes, Satellite Systems, DSS, DVD, etc. However, an easy onetime step may be necessary before the remote will work your VCR.

Try this initial check to see if going on to the following section is necessary.

BEGIN

1 Place the TV/VCR/ACC Mode Switch in the proper position.

2 Point the remote control at the device and press the POWER button.

3 Does the remote turn the device ON?

If **YES**, stop and try other function buttons on the remote. If they also work the device, then the remote is ready and no further steps are needed.

If **NO**, continue...

1 First look up a **THREE-DIGIT remote control number** for your brand of Device before going through the simple "1, 2, 3" steps (on the following page).

Find your Three-Digit Code on pages 30-31.

SMART HELP



Remember, if more than one number is listed, you may have to try more than the first Three-Digit code given in order to locate your Device's remote code.

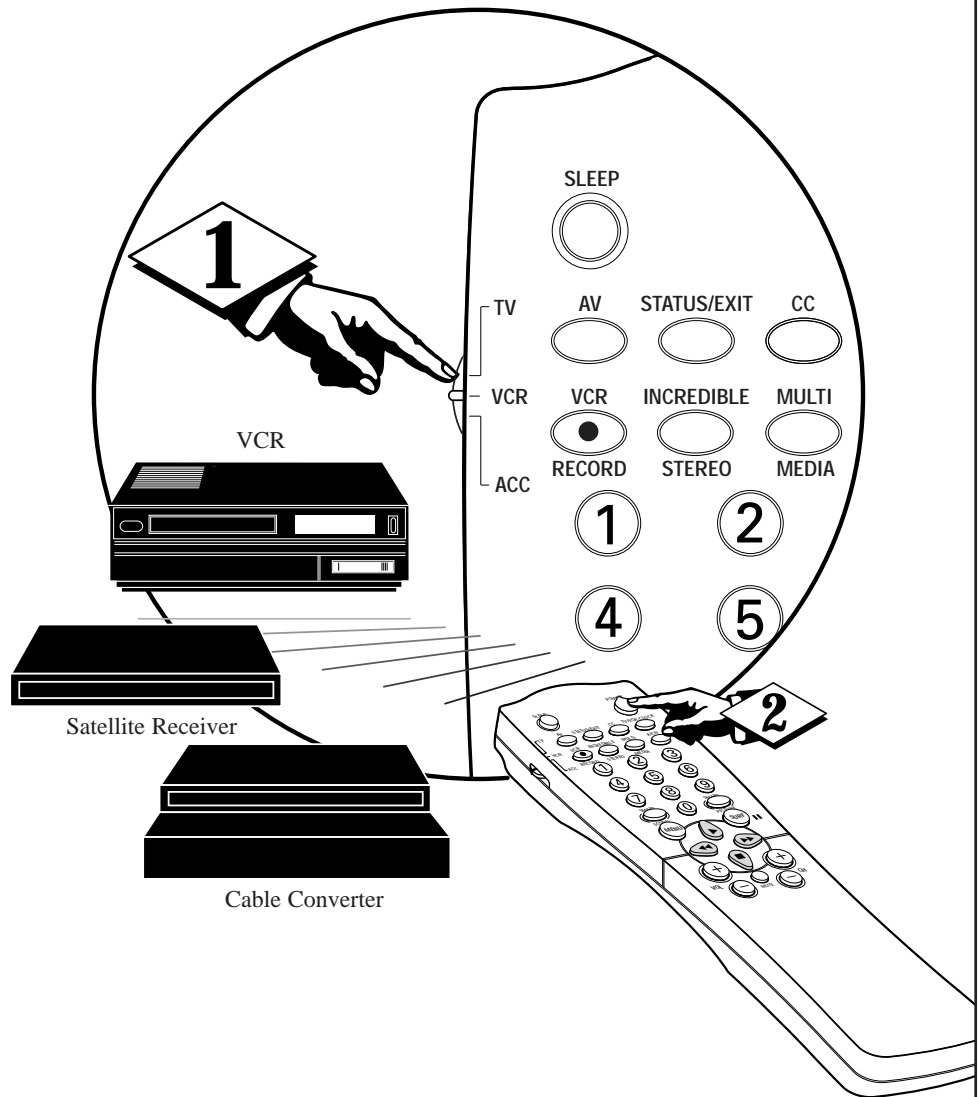

SETTING THE REMOTE CONTROL TO WORK WITH OTHER DEVICES



Direct Access Method

Now that you have looked up the three-digit Remote Code Number for your brand of device, you are ready to follow the four simple steps below.

Please read through steps 1-4 before beginning.

BEGIN

- 1 Place the TV/VCR/ACC Mode Switch** in the proper position.
- 2 Press the VCR RECORD button** on the remote control and release.
- 3 Press the SMART SOUND button** on the remote within 30 seconds, then release.
- 4 Enter the THREE-DIGIT REMOTE CODE NUMBER** for your desired device. The remote is now ready to send commands to the unit.
- 5 Point the remote at the Device.** Press the **POWER** button on the remote to turn the unit ON.



SMART HELP



Remember, if this doesn't work the first time, repeat steps using the same remote code number.

After a second try and the remote does not operate your device, see if there is another three-digit code number (pages 30-31) listed for your device and repeat the steps above using the new number.

If after repeated attempts the code number method does not work your device, try the **SEARCH METHOD** on page 29.

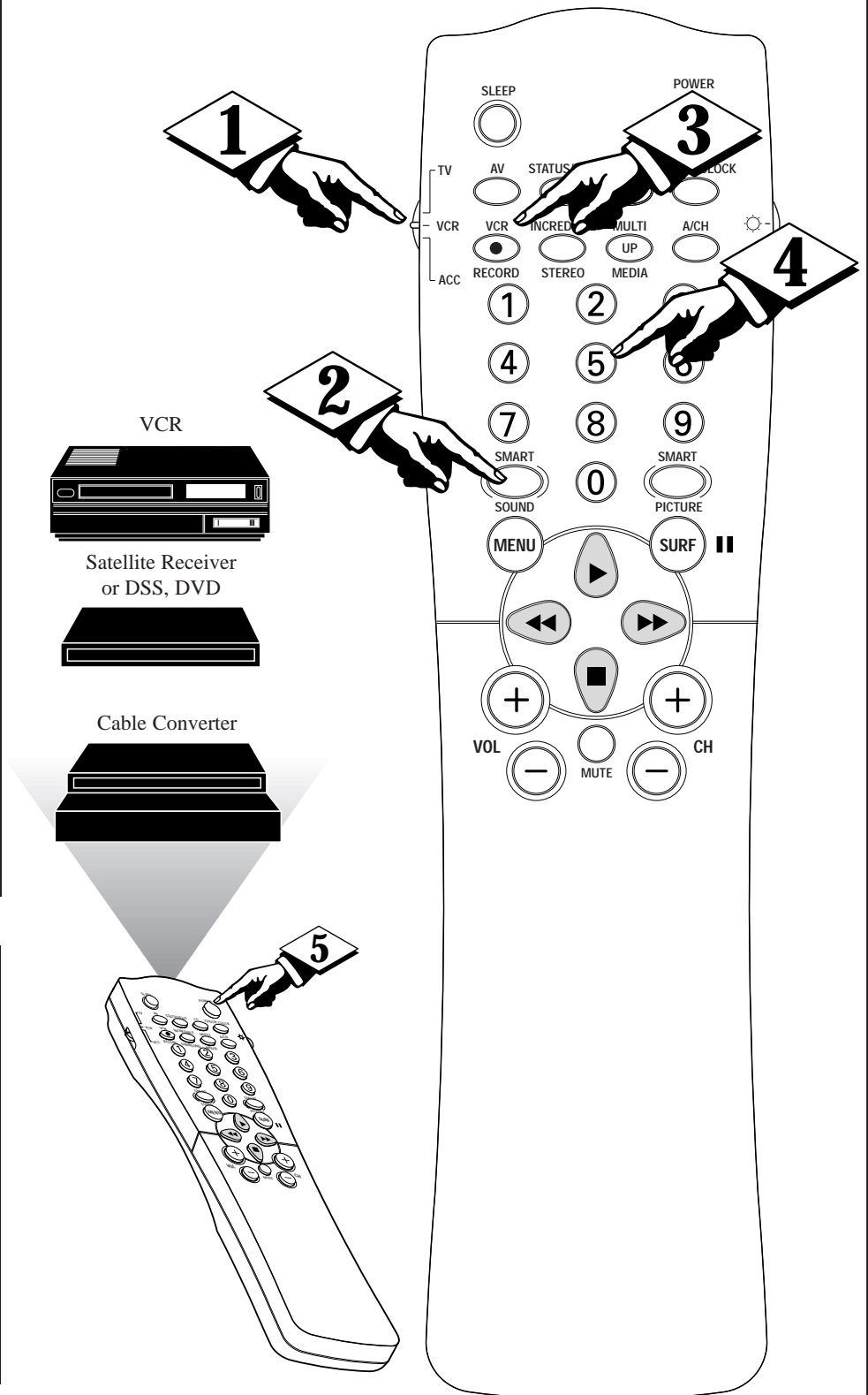

SETTING THE REMOTE CONTROL TO WORK WITH OTHER DEVICES

Search Method

Your TV remote can be set to work various external devices such as VCRs, Cable Boxes, Satellite Receivers, DSS, DVD, etc. by what is called the search method of remote control programming.

If the "Remote Code" number method shown on page did not set your remote to work your external device, then follow the easy steps listed below.

Please read steps 1-4 before beginning.

(BEGIN)

- 1 Press the **POWER** button on the device you are attempting to program to turn it ON.
- 2 Place the **TV/VCR/ACC Mode Switch** in the proper position.
- 3 Press the **VCR RECORD** and the **SMART SOUND** buttons **simultaneously** and hold them down.
- 4 The device will begin to change channels after the remote identifies the correct code. When the channels start to change release the **VCR RECORD** and **SMART SOUND** buttons. The remote should be ready to operate the device.

STOP

SMART HELP



This method can take up to two minutes to perform.

Don't let the device scan up more than five channels. If you do the remote may pass up the right code and another two minute search cycle will have to be repeated.

If no channel change happens within two minutes, repeat steps 1-4. Should a channel change still not occur, the remote will not work the desired device.

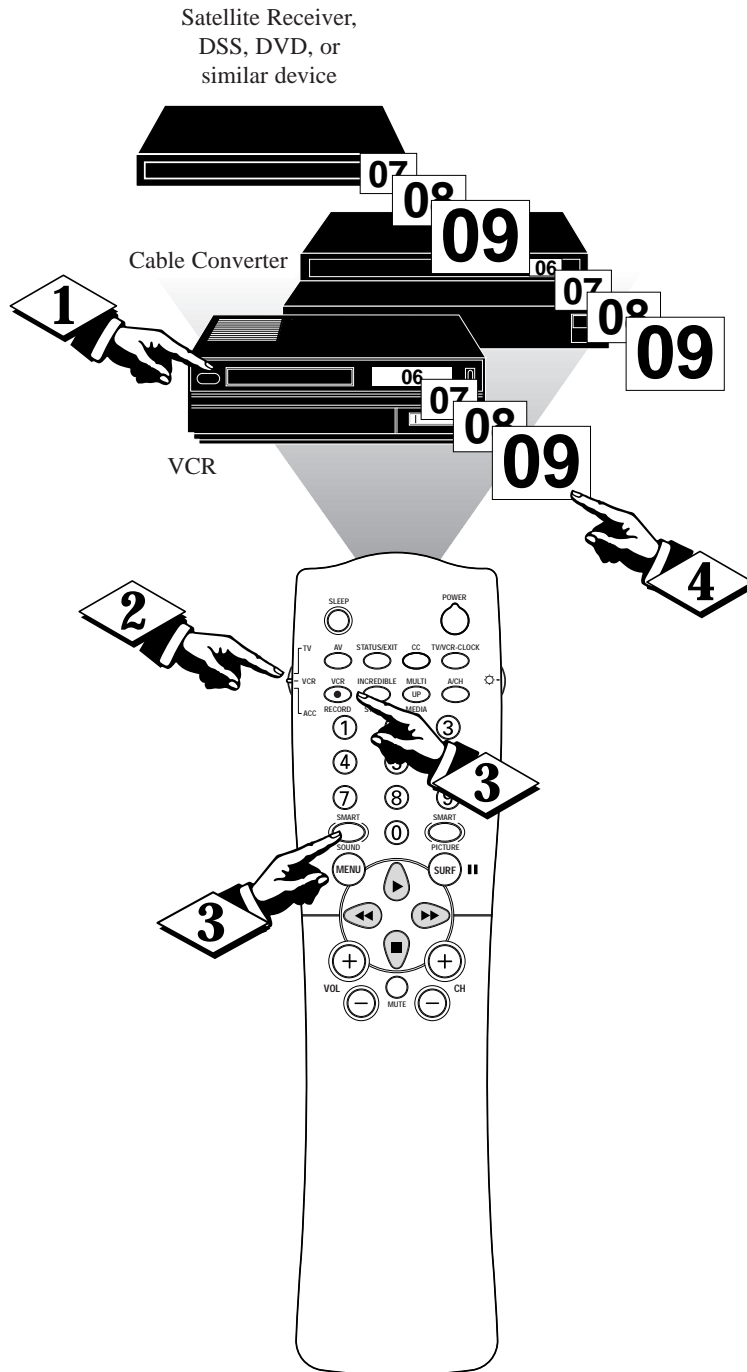

REMOTE CONTROL DIRECT ENTRY CODES



VCR	REMOTE CODE NO.	VCR	REMOTE CODE NO.	VCR	REMOTE CODE NO.
Admiral	.048	Loewe	.004	Sanyo	.046, 047, 104, 240, 268
Advantz	.358	Logik	.004, 072	Saville	.352
Adventure	.000	MEI	.035	Scott	.043, 045, 121, 164, 211, 212
Aiko	.278	MGA	.043, 061	Sears	.000, 035, 037, 042, 046, .047, 054, 066, 104, 105
Aiwa	.000, 037, 307, 348, 352	MGN Technology	.240	Sharp	.046, 062
Akai	.041, 049, 053, 061, 106, 315	MTC	.000, 240	Shintom	.072
Alba	.352	Magnavox	.000, 035, 081, 146, 181	Shogun	.051, 240
Amercian High	.035	Marta	.037	Shoral	.004
Amstrad	.325, 332	Matsui	.004, 348, 352	Siemens	.003
Asha	.240	Matsushita	.035, 162, 454	Singer	.072
Audiovox	.037	Memmorex	.307	Sinudyne	.004
Baird	.107	Memorex	.000, 035, 037, 039, 046, .047, 048, 104, 240, 266, 307	Sony	.000, 011, 022, 032, 033, .034, 035, 253, 275
Beaumarck	.240	Metz	.003, 347	Sunkel	.348
Bell & Howell	.104	Minolta	.042, 105	Sunpak	.253
Blaupunkt	.003, 006, 154	Mitsubishi	.043, 061, 067, 075, 173, 443	Sylvania	.000, 035, 043, 081, 103, 110
Brandt	.187, 320, 321	Motorola	.035, 048	Symphonic	.000
Broksonic	.121, 184, 211, 295, 361	MultiTech	.000, 072	TMK	.036, 208, 240
Bush	.352	NAD	.058	Tatung	.041
CCE	.072, 278	NEC	.036, 040, 041, 067, 104	Teac	.000, 041
Calix	.037	Nikko	.037	Technics	.035, 162
Canon	.035	Nikon	.034, 253	Teknika	.000, 035, 037
Caphart	.020	Noblex	.240	Telefunken	.187, 320, 321
Carver	.081, 146	Nordmende	.297, 320, 321	Tansal	.322
Citizen	.037, 278	Okano	.346	Thomas	.000
Colt	.072	Olympus	.035, 226	Thomson	.320
Combitach	.352	Optimus	.037, 048, 058, 104, .162, 432, 454	Toshiba	.043, 045, 066, 212, 366
Craig	.037, 047, 072, 240, 271	Optonica	.062	Totavision	.037, 240
Curtis Mathes	.035, 041, 060	Orion	.004, 295, 348, 352, 479	Towada	.322
Cybermax	.051, 240	Panasonic	.035, 077, 162, 225, .226, 378, 454	Unitech	.240
Daewoo	.020, 045, 276	Penney	.035, 037, 038, 040, .042, 065, 105	Universum	.325
Daytron	.020	Pentax	.042, 065, 105	Vactor	.045
Denon	.042	Philco	.035	Vactor Research	.038, 040
Dynatech	.000	Philips	.035, 062, 081, 110, 403	Video Concepts	.040, 045, 061
ElectroPhonic	.037	Pilot	.037	Videosonic	.240
Emerex	.032	Pioneer	.058, 067	Wards	.000, 035, 042, 047, 048, 060, 062, .072, 081, 149, 161, 212, 240
Emerson	.000, 002, 036, 037, 043, 061, .068, 088, 121, 164, 208, 209, .211, 212, 278, 295, 361, 479	Portland	.020	XR-1000	.000, 035, 072
Ferguson	.107, 320, 321	Profax	.322	Yamaha	.038
Fisher	.047, 054, 066, 104	Profitronic	.240	Zenith	.000, 033, 034, 039
Fuji	.033, 035	Protec	.072		
Funai	.000	Pulsar	.039, 051	CABLE	REMOTE
GE	.035, 060, 065, 202	Quarter	.046	CONVERTOR	CODE NO.
Garrard	.000	Quartz	.046	ABC	.001, 003, 007, 008, .011, 013, 014, 017
Go Video	.232, 279, 432	Quasar	.035, 077, 162, 454	Aliegio	.153
Gold Star	.037, 038	RCA	.042, 060, 065, 077, .105, 106, 149, 202	Andover	.544
Gradiente	.000, 406	Radio Shack	.000, 037	Antronix	.022
Grundig	.003, 007, 195, 347	Radix	.037	Archer	.022, 153
HI-Q	.047	Randex	.037	Balcor	.056
Harly Davidson	.000	Realistic	.000, 035, 037, 045, 047, .048, 062, 066, 104	British Telecom	.105
Harman/Kardon	.038, 075	Ricoh	.034, 253	Cable Star	.056
Harwood	.068, 072	Runco	.039	Cablatenna	.022
Headquarter	.046	SEG	.322	Cabletime	.161, 271, 377, 448
Hinari	.004, 352	SEI	.004	Cableview	.022
Hitachi	.000, 004, 041, 042, .065, 105, 168, 235	STS	.042	Century	.153
Ingersol	.004	Saba	.297, 320, 321	Citizen	.153
JVC	.008, 041, 067, 208, 384, 486	Saisho	.004	Clyde	.086
Jensen	.041	Salora	.075	Colour Voice	.025, 031
KEC	.037, 278	Samsung	.045, 051, 053, 240	Comtec	.274
KLH	.072	Sanky	.039, 048	Comtronics	.040
Kenwood	.038, 041, 067, 384	Sansui	.000, 041, 067, 271	Contec	.019
Kodak	.035, 037			Cryptovision	.600
LXI	.037			Deceat	.423
Lloyd's	.000, 206				

USING THE REMOTE'S VCR BUTTONS



When using the TV remote with a VCR, first make certain it is set to control your VCR (by the REMOTE CODE or SEARCH method).

BEGIN

- 1 Set the TV/VCR/ACC mode switch to VCR on the remote.
- 2 Point the top of the remote toward the front of the VCR (remote sensor window) when pressing the buttons.



NOTE: The functions of the buttons described on this page are for VCR use only. (Please make sure the TV/VCR/ACC switch is in the VCR position.)

VCR SYSTEM SWITCH

Set in the VCR position to send remote commands to the VCR.

VCR RECORD BUTTON

Hold the VCR/RECORD button down to begin a VCR recording.

PLAY BUTTON

Press to begin playback of a video tape.

REWIND BUTTON

Press to rewind tapes. For some VCR's the STOP button may have to be pressed first, then REWIND. In playback mode hold down the button to view picture moving rapidly in reverse.

STOP BUTTON

Press to stop the motion of a tape in playback, rewind, fast forward, etc.

SMART HELP



Remember, the VCR buttons on the remote will not operate your VCR if those features are not found on your VCR remote control.

Note: All VCR functions (particularly Search, Rewind, Fast Forward, etc.) will operate the same as with the original VCR remote control provided with the VCR.

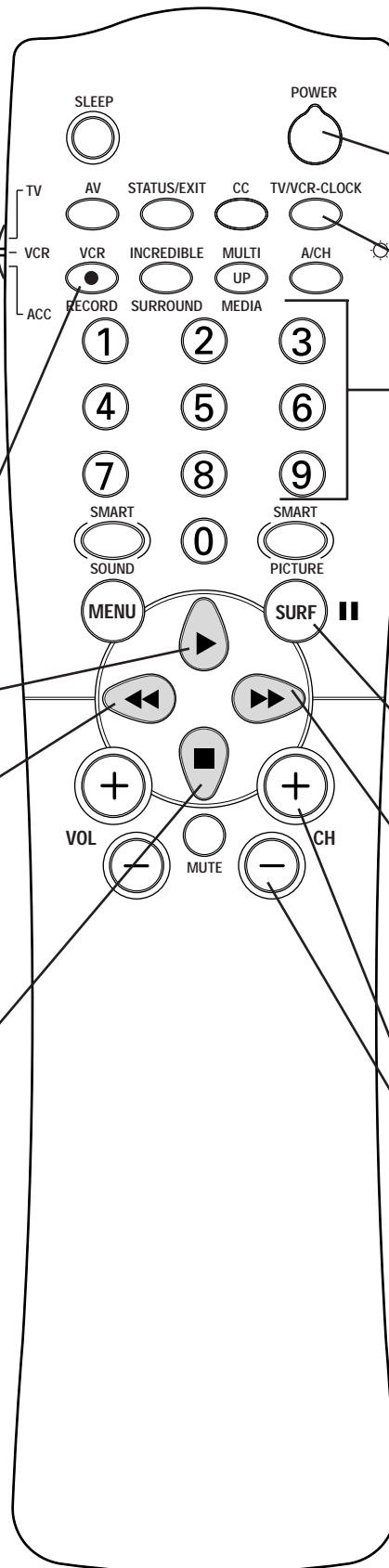

POWER BUTTON

Press to turn the VCR ON and OFF.

TV/VCR-CLOCK BUTTON

Press to the VCR position (VCR indicator on the front of the unit will light) to view the playback of a tape, watch a program while recording it, or to watch a TV broadcast using the VCR CH (+) (-) or Number buttons. Press again to place in the TV position (VCR indicator light will go off) to view one program while recording another program.

NUMBER BUTTON

Press buttons for direct VCR channel selections.

PAUSE BUTTON

Press to temporarily stop the tape during a playback or recording. Press again to release Pause.

FAST FORWARD BUTTON

Press to rapidly advance the tape. For some VCR's you may need to press the STOP button first, then the FAST FORWARD button. In playback mode hold the button down to view the picture moving rapidly in the forward direction.

CHANNEL + & - BUTTONS

Press to scan up or down through the VCR channel numbers.



TIPS IF SOMETHING ISN'T WORKING

Please make these simple checks before calling for service. These tips can save you time and money since charges for TV installation and adjustment of customer controls are not covered under your warranty.

No Power

No Picture

No Sound

Remote Does Not Work

TV Displays Wrong Channel or No Channels Above 13

TV Displays Black Box

CAUTION: A video source (such as a video game, Compact Disc Interactive - CDI, or TV information channel) which shows a constant non-moving pattern on the TV screen, can cause picture tube damage. When your TV is continuously used with such a source the pattern of the non-moving portion of the game (CDI, etc.) could leave an image permanently on the picture tube. When not in use, turn the video source OFF. Regularly alternate the use of such video sources with normal TV viewing.

- Check the TV power cord. Unplug the TV, wait 10 seconds, then reinsert plug into outlet and push POWER button again.
- Check that outlet is not on a wall switch. Be sure fuse is not blown on AC Power strip.
- Check to be sure the system mode switch (TV/VCR/ACC) is in the correct position when using the remote control to power the set ON.

- Check antenna connections. Are they properly secured to the TV's ANT/CABLE plug ?
- Check the TUNER control for CABLE or ANTENNA setting.
- Press the AV button on the remote to make sure the correct signal source is selected. (AV 1, AV 2, SVID-R or MM 1, MM 2, MM 3)

- Check the VOLUME buttons.
- Check the MUTE button on the remote control.
- Check the SPEAKER on-screen control. OFF position will eliminate sound at the set.
- If attempting auxiliary equipment hook-ups, check audio jack connections.
- (If Applicable) Check Audio Receiver for correct operating mode.

- Check TV/VCR/ACC "System" switch on the remote. Move the switch to the TV position to operate the television.
- Check batteries. Replace with AA Heavy Duty (Zinc Chloride) or Alkaline batteries if necessary.
- Clean the remote and the remote sensor window on the TV.
- Check the TV power cord. Unplug the TV, wait 10 seconds, then reinsert plug into outlet and push POWER button again.
- Check to be sure TV outlet is not on a wall switch.

- Repeat channel selection.
- Add desired channel numbers (CHANNEL control) into TV memory.
- Check to be sure the TUNER control is set to the CABLE option.

- Check CLOSED CAPTION in menu and turn TEXT Mode OFF.

Cleaning and Care

- To avoid possible shock hazard be sure the TV is unplugged from the electrical outlet before cleaning.
- When cleaning the TV screen take care not to scratch or damage the screen surface (avoid wearing jewelry or using anything abrasive). Wipe the front screen with a clean cloth dampened with water. Use even, easy, vertical strokes when cleaning.
- Gently wipe the cabinet surfaces with a clean cloth or sponge dampened in a solution of cool clear water. Use a clean dry cloth to dry the wiped surfaces.
- Never use thinners, insecticide sprays, or other chemicals on or near the cabinet, as they might cause permanent marring of the cabinet finish.

GLOSSARY TO TELEVISION TERMS



Coaxial Cable * A single solid antenna wire normally matched with a metal plug (F-type) end connector that screws (or pushes) directly onto a 75 Ohm input found on the Television or VCR.

Closed Caption * Broadcast standard which allows you to read the voice content of television programs on the TV screen. Designed to help the hearing impaired this feature uses on-screen "text boxes" to show dialogue and conversations while the TV program is in progress.

Direct Audio/Video Inputs * Located on the rear of the TV these connectors (RCA phono type plug) are used for the input of audio and video signals. Designed for use with VCRs (or other accessories) in order to receive higher picture resolution and offer sound connection options.

Identify* Method by which a remote control searches and finds an operating code for another product (such as a VCR or Cable Converter). Once the code has been "identified" then the TV remote can operate and send commands to the other product.

On Screen Displays (OSD) * Refers to the wording or messages generated by the television (or VCR) to help the user with specific feature controls (color adjustment, programming, etc.).

Menu * An on-screen listing of feature controls shown on the Television screen that are made available for user adjustments.

Multichannel Television Sound (MTS) * The broadcast standard that allows for stereo sound to be transmitted with the TV picture.

Programming * The procedure of adding or deleting channel numbers into the Television's memory circuits. In this way the Television "remembers" only the locally available or desired channel numbers and skips over any unwanted channel numbers.

Remote Sensor Window * A window or opening found on the Television control panel through which infrared remote control command signals are received.

Setup Mode * Automatic feature control settings made by the TV. Designed for first time set-up and use. Settings for signal connections (antenna or cable TV), plus channel program memory are held in the TV's memory (even if the set is unplugged and moved to a new location.)

Second Audio Program (SAP) * Another or additional audio channel provided for in the Multichannel Television Sound (MTS) broadcast standard. The most frequently proposed use for SAP is the simultaneous bilingual broadcast of TV program material.

Status * Allows the user to quickly confirm what channel number is currently being viewed. Status can also be used to clear the Television of on screen displays or information (rather than waiting for the displays to "time out" or automatically disappear from the screen).

Twin Lead Wire * The more commonly used name for the two strand 300 Ohm antenna wire used with many indoor and outdoor antenna systems. In many cases this type of antenna wire requires an additional adapter (or balun) in order to connect to the 75 Ohm Input terminals designed into the more recent Televisions and VCRs.

INDEX

Accessories/Optional	.20-22, *Q/U-1	Picture Noise Reduction	.14
Adapter Connector	*Q/U-1	Precautions/Safety	.3, 36, *Q/U-1
Add/Delete Channels	*Q/U-2	Programming Channels	*Q/U-2
Audio/Video Jackpanel	.20-22	Remote Control	.23-31, *Q/U-4
AVL (Automatic Volume Leveler)	.24	Remote Control Direct Entry Code List	.29-30
Balance Control	.17	Remote Control with Accessory Equipment	.26-31
Bass Control	.17	Requesting Service	.32, 34-36
Battery Installation	*Q/U-4	RF Coaxial Cable	.21-22, *Q/U-1
Cable Converter Direct Entry Code List	.29-30	Satellite Receiver Direct Entry Code List	.29-30
Cable TV Connections/Settings	.21-22, *Q/U-2	Safety/Precautions	.3, 36, *Q/U-1
Channel (Name) Display	*Q/U-3	Second Audio Program	.18
Channel Memory	*Q/U-2	Sensor Remote	*Q/U-4
Closed Captioning	.15	Set Up/First Time Use	*Q/U-1, 2, 3, 4
Contrast + Control	.14	Sleep Timer	.16
Controls/TV	*Q/U-4	Smart Lock Access Code Feature	.12
Controls/Remote	.23-31, *Q/U-4	Smart Lock Block Channel Feature	.13
Features	.5	Smart Picture Control	.23
Glossary TV Terms	.33	Smart Sound Control	.24
Tuner Control	*Q/U-2	Status Button	*Q/U-4
Inputs/Audio and Video	.21-22	Stereo	.18
Language Option	*Q/U-2	Incredible Stereo Control	.19
Memory/Program Channels	*Q/U-2	Surf	.25
Menu Button	*Q/U-4	Tips for Service	.32, 34-36
Minus(-)/Plus (+) Buttons	*Q/U-4	Treble Control	.17
On Timer Channel Control	.9	TV Speaker Control	.20
On Timer Control	.8	VCR Buttons	.31, Q/U-4
On Timer Display	.11	VCR/TV Connections	.20-22, *Q/U-1
On Timer Start Up Control	.10	Volume Bar Control	.19
Picture Controls	.6	Warranty	.36

* Information contained in Quick-Use (Q/U) Guide-page listed.

Philips Consumer Electronics Company Factory Service Center Locations

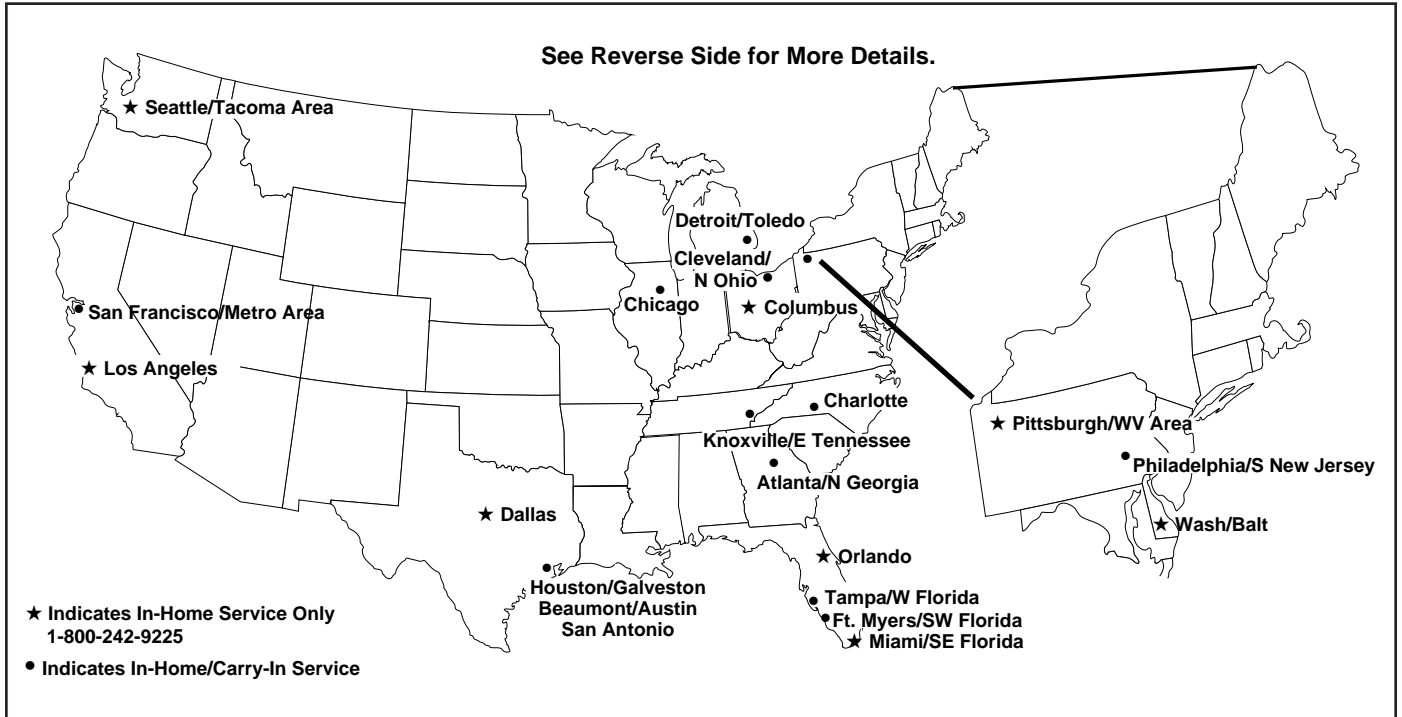

NOTE: If you reside in one of our Philips Factory Service Branch areas (see directory on back), you can contact the nearest Service Branch to obtain efficient and expedient repair for your product. If your product is In-Warranty, you should have proof-of-purchase to ensure No Charge Service. For Out-of-Warranty service, call the location nearest you.

NOTA: Si vous résidez dans une des régions desservies par une succursale de service après vente du fabricant Philips (voir liste ci-dessous), vous pourrez contacter la branche de service après vente la plus près de chez vous pour obtenir un service après vente rapide et efficace. Si le produit est sous garantie, il suffira de présenter une preuve d'achat pour bénéficier d'un service sans frais. Pour les produits non couverts par la garantie, contactez le centre le plus près de chez vous.

NOTA: Si Ud. reside en una de nuestras zonas para sucursales Philips de servicio al de fábrica (ver directorio más abajo), Ud. puede comunicarse con la sucursal de servicio más cercana para obtener una reparación oportuna y eficaz de su producto. Si su producto está todavía bajo garantía, Ud. debe presentar comprobante de compra para no ocasionar ningunos cargos por servicio. Para servicio después del vencimiento de la garantía, llame al lugar más cercano de los abajo indicados.

In Canada

How you can obtain efficient and expedient carry-in, mail-in, or in-home service for your product
Please contact Philips at
1-800-661-6162 (French speaking)
1-800-363-7278 (English speaking)

Au Canada

Comment obtenir le service après-vente pour les produits apportés ou envoyés par la poste à notre centre de service ou le service à domicile
Veuillez contacter philips à:
1-800-661-6162 (Francophone)
1-800-363-7278

En el Canadá

Cómo recibir servicio eficiente para su producto, en persona, por correo o a domicilio
Favor de comunicarse con Philips al:
1-800-661-6162 (francófono)
1-800-363-7278 (anglófono)

QUALITY SERVICE IS AS CLOSE AS YOUR TELEPHONE! SIMPLY LOOK OVER THE LIST BELOW FOR THE NUMBER OF A FACTORY SERVICE CENTER NEAR YOU. YOUR PRODUCT WILL RECEIVE EFFICIENT AND EXPEDIENT CARRY-IN, MAIL-IN, OR IN-HOME SERVICE, AND YOU WILL RECEIVE PEACE OF MIND, KNOWING YOUR PRODUCT IS BEING GIVEN THE EXPERT ATTENTION OF PHILIPS' FACTORY SERVICE. AND, IF THE PHONE NUMBER LISTED FOR YOUR AREA IS LONG DISTANCE, CALL 1-800-242-9225 FOR FACTORY SERVICE.

COMMENT OBTENIR NOTRE SERVICE APRES VENTE RAPIDE ET EFFICACE SOIT PAR COURRIER, A DOMICILE, OU EN SE PRESENTANT A UN CENTRE DE SERVICE PHILIPS. PLUS DE 600 CENTRES DE RECEPTION DE PRODUITS A REPARER A TRAVERS LE PAYS: CONTACTER LE CENTRE DE SERVICE AUX CONSOMMATEURS LE PLUS PROCHE POUR SAVOIR L'EMPLACEMENT DE CES DEPOTS DANS UN RAYON DE 50 A 75 MILES (80 KM A 120 KM) DU CENTRE DE SERVICE LOCAL.

CÓMO OBTENER UN SERVICIO OPORTUNO Y EFICIENTE POR CORREO, EN CASA O EN PERSONA PARA SU PRODUCTO A TRAVÉS DE UN CENTRO PHILIPS DE SERVICIO. MAS DE 600 SITIOS POR TODO EL PAIS PARA LA RECEPCION DE PRODUCTOS NECESITADOS DE REPARACIONES: COMUNICARSE CON EL CENTRO DE SERVICIO DE FABRICA MAS CERCANO PARA ESTOS LUGARES DENTRO DE UN RADIO DE 80 A 120 KM (50 A 75 MILLAS) DEL CENTRO DE SERVICIO LOCAL.

GEORGIA

Philips Factory Service of Georgia
200 N. Cobb Pkwy., Suite 120
Marietta, GA 30062
(770) 795-0085

FT. MYERS, FLORIDA

Philips Factory Service Satellite - Ft. Myers
11601 Cleveland Ave., Suite 15
Ft. Myers, FL 33907
(941) 278-4242

FLORIDA

Philips Factory Service of Florida
1911 US Highway 301 North
Tampa, FL 33619
(813) 621-8181

WESTERN U.S.A.

Philips Factory Service Western Region
681 East Brokaw Rd.
San Jose, CA 95112
(408) 436-8566

NORTH CAROLINA

Philips Factory Service of N. Carolina
520 G Clanton Rd.
Charlotte, NC 28217
(704) 529-6330

TEXAS

Philips Factory Service of Texas
1110 N. Post Oak Rd., Suite 100
Houston, TX 77055
(713) 682-3990

CENTRAL U.S.A.

Philips Factory Service Central US
950 Keynote Circle
Brooklyn Heights, OH 44131
(216) 741-3334

MICHIGAN

Philips Factory Service of Michigan
25173 Dequindre
Madison Heights, MI 48071
(248) 544-2110

ILLINOIS

Philips Factory Service of Illinois
1360 W. Hamilton Pkwy.
Itasca, IL 60143
(630) 775-0990

TENNESSEE

Philips Factory Service of East Tennessee
6700 D Papermill Rd.
Knoxville, TN 37919
(423) 584-6614

MID-ATLANTIC

Philips Factory Service Mid-Atlantic
352 Dunks Ferry Rd.
Bensalem, PA 19020
(215) 638-7500

LIMITED WARRANTY

COLOR TELEVISION

90 Days Free Labor

One Year Free Replacement of Parts (Two Years Free Replacement on Color Picture Tube)

This product can be repaired in-home.

WHO IS COVERED?

You must have proof of purchase to receive warranty service. A sales receipt or other document showing that you purchased the product is considered proof of purchase.

WHAT IS COVERED?

Warranty coverage begins the day you buy your product. For 90 days thereafter, all parts will be repaired or replaced free, and labor is free. From 90 days to one year from the day of purchase, all parts will be repaired or replaced free, but you pay for all labor charges. From one to two years from the day of purchase, you pay for the replacement or repair of all parts except the picture tube, and for all labor charges. After two years from the day of purchase, you pay for the replacement or repair of all parts, and for all labor charges.

All parts, including repaired and replaced parts, are covered only for the original warranty period. When the warranty on the product expires, the warranty on all replaced and repaired parts also expires.

WHAT IS EXCLUDED?

Your warranty does not cover:

- labor charges for installation or setup of the product, adjustment of customer controls on the product, and installation or repair of antenna systems outside of the product.
- product repair and/or part replacement because of misuse, accident, unauthorized repair or other cause not within the control of Philips Consumer Electronics Company.
- reception problems caused by signal conditions or cable or antenna systems outside the unit.
- a product that requires modification or adaptation to enable it to operate in any country other than the country for which it was designed, manufactured, approved and/or authorized, or repair of products damaged by these modifications.
- incidental or consequential damages resulting from the product. (Some states do not allow the exclusion of incidental or consequential damages, so the above exclusion may not apply to you. This includes, but is not limited to, prerecorded material, whether copyrighted or not copyrighted.)
- a product used for commercial or institutional purposes.

WHERE IS SERVICE AVAILABLE?

Warranty service is available in all countries where the product is officially distributed by Philips Consumer Electronics Company. In countries where Philips Consumer Electronics Company does not distribute the product, the local Philips service organization will attempt to provide service (although there may be a delay if the appropriate spare parts and technical manual(s) are not readily available).

MAKE SURE YOU KEEP...

Please keep your sales receipt or other document showing proof of purchase. Attach it to this owner's manual and keep both nearby. Also keep the original box and packing material in case you need to return your product.

BEFORE REQUESTING SERVICE...

Please check your owner's manual before requesting service. Adjustments of the controls discussed there may save you a service call.

TO GET WARRANTY SERVICE IN U.S.A., PUERTO RICO OR U.S. VIRGIN ISLANDS...

Contact a Philips factory service center (see enclosed list) or authorized service center to arrange repair.

(In U.S.A., Puerto Rico and U.S. Virgin Islands, all implied warranties, including implied warranties of merchantability and fitness for a particular purpose, are limited in duration to the duration of this express warranty. But, because some states do not allow limitations on how long an implied warranty may last, this limitation may not apply to you.)

TO GET WARRANTY SERVICE IN CANADA...

Please contact Philips at:

1-800-661-6162 (French Speaking)

1-800-363-7278 (English Speaking)

(In Canada, this warranty is given in lieu of all other warranties. No other warranties are expressed or implied, including any implied warranties of merchantability or fitness for a particular purpose. Philips is not liable under any circumstances for any direct, indirect, special, incidental or consequential damages, howsoever incurred, even if notified of the possibility of such damages.)

REMEMBER...

Please record the model and serial numbers found on the product below. Also, please fill out and mail your warranty registration card promptly. It will be easier for us to notify you if necessary.

MODEL # _____

SERIAL # _____

This warranty gives you specific legal rights. You may have other rights which vary from state/province to state/province.

Philips Service Company, P.O. Box 555, Jefferson City, Tennessee 37760, (423) 475-8869

Free Manuals Download Website

<http://myh66.com>

<http://usermanuals.us>

<http://www.somanuals.com>

<http://www.4manuals.cc>

<http://www.manual-lib.com>

<http://www.404manual.com>

<http://www.luxmanual.com>

<http://aubethermostatmanual.com>

Golf course search by state

<http://golfingnear.com>

Email search by domain

<http://emailbydomain.com>

Auto manuals search

<http://auto.somanuals.com>

TV manuals search

<http://tv.somanuals.com>