

PHILIPS



Ⓜ Stereo Radio Cassette Recorder

Ⓜ Stereo Radio-Cassette Recorder

Ⓜ Radiocasete Estéreo

Ⓜ Radioregistratore Stereo

Ⓜ Stereo Radio Kasette Båndoptager

Ⓜ Stereo Radio Kasette Spiller



PHILIPS

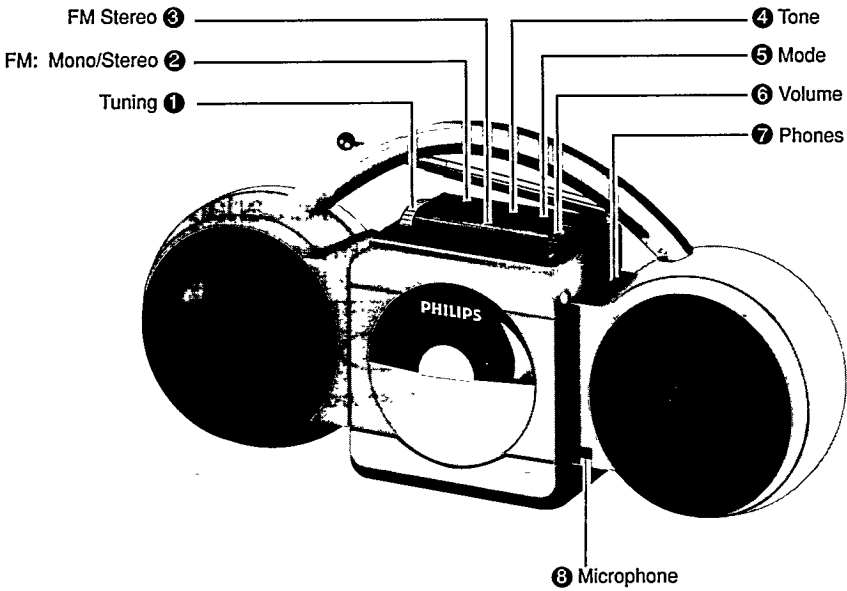

S Svenska

Typskilten sitter på apparatens undersida.

Observera: Strömbrytaren är sekundärt inkopplad och bryter ej strömmen från nätet. Den inbyggda nåtdelen är därför ansluten till nätet så länge stickproppen sitter i vägguttaget.

SF Suomi

Arvolkipi sijaitsee laitteen pohjassa.

Huom: Virrankytin on kytketty toisiopuolelle eikä se kytke laitetta irti sähköverkosta. Sisäänrakennettu verkko-osa on kytkettynä sähköverkkoon aina silloin, kun pistoke on pistorasiassa.

MEX México

NOM

Es necesario que lea cuidadosamente su instructivo de manejo.



NOM

GB English

Illustrations

Page 5
Page 3

English

F Français

Illustrations

Page 12
Page 3

Français

D Deutsch

Zeichnungen

Seite 18
Seite 3

Deutsch

NL Nederlands

Afbeeldingen

Pagina 24
Pagina 3

Nederlands

E Español

Ilustraciones

Página 30
Página 3

Español

I Italiano

Illustrazioni

Pagina 36
Pagina 3

Italiano

N Norsk

Illustrasjon

Sida 42
Sida 3

Norsk

DK Dansk

Illustration

Sivu 48
Sivu 3

Dansk

W elcome to the worldwide family of Philips product owners!

Let us show you how to enjoy this wonderful product you have bought.

To begin, you can use 220V, 50Hz power supply (240V, 50Hz for UK) or six R14, UM2 or C-cells batteries to run your set.

If your set comes with a 'Voltage' selector, set this selector to the local mains voltage.

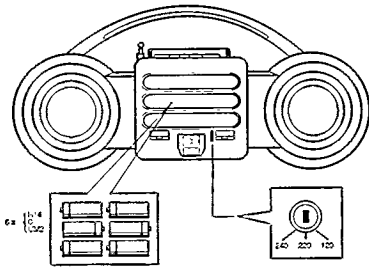

For UK users

(Ask your parents or an elder person to help you)

When fixing a mains plug, please note that Blue is Neutral and Brown is Live.

Connect the Brown wire to the terminal marked 'L' or coloured Red.
Connect the Blue wire to the terminal marked 'N' or coloured Black.
There is no need to connect to the earth terminal.

Do **not** connect either wire to the earth terminal in the plug, marked E or \perp or coloured green or green and yellow.

RADIO

For models with 2 wavebands, set modeswitch ⑤ to FM/AM.

For models with 3 wavebands, set modeswitch FM/AM.

In case of AM, use ② to select MW/LW.

a) Use modeswitch ⑤ to select a waveband.

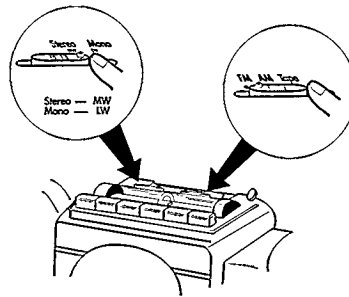

b) Use TUNING ① to tune to your favourite station.

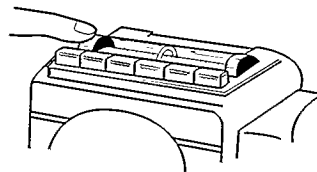

English

Français

Deutsch

Nederlands

Español

Italiano

Norsk

Dansk

c) For better reception, adjust your set as follows:

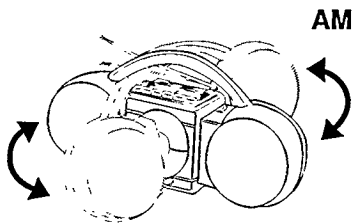
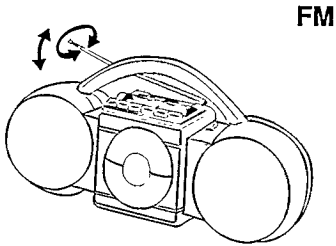

d) Adjust your volume with ⑥ and tone with ④.

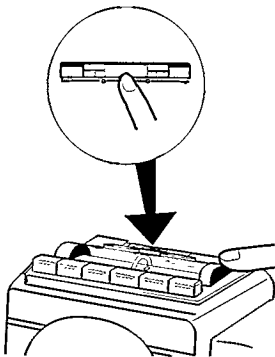

e) To listen with headphones, plug your headphones into ⑦. The loudspeakers will be muted.

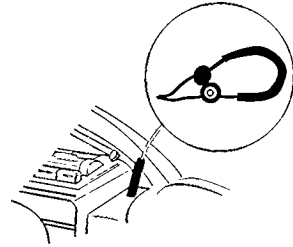

f) When the FM Stereo ③ indicator lights up, you are receiving transmissions in stereo. A disturbing noise, due to a weak FM-stereo signal, can be suppressed by setting the Mono/Stereo switch ② to Mono and you are listening to the programme in Mono.

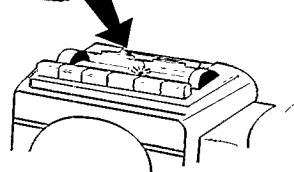
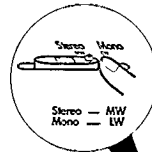

g) To switch the radio off, set ⑤ to TAPE and make sure no recording button is pressed.

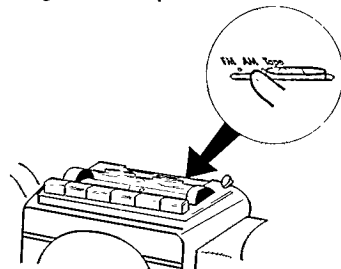

CASSETTE RECORDER

For recording, use NORMAL or FERRO cassettes.

For playback, any type of cassette can be used.

To protect a recording e.g. on side 1 of the cassette, break out the tab opposite the arrow. Now, recording on side 1 is no longer possible.

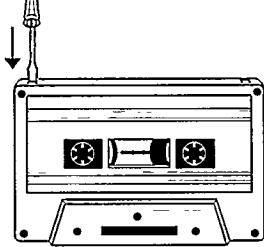

To rewind, press REWIND ►►.
To fast wind, press F.FWD◄◄.

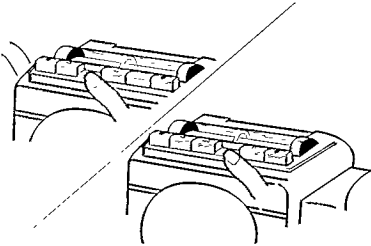

To stop, press STOP/EJECT ■.

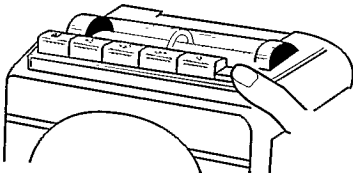

RECORDING

Radio Recording

- a) Use modeswitch ⑤ to select a waveband.
If you select AM, use ② to select MW or LW.

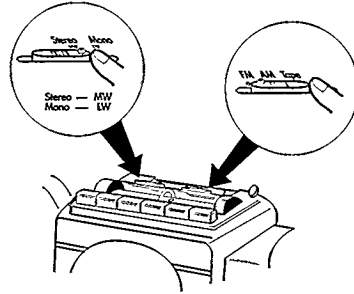

- b) Use TUNING switch ① to tune to your favourite station.

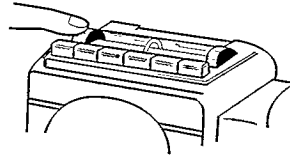

- c) To record in FM Stereo, set Mono/Stereo switch ② to Stereo.

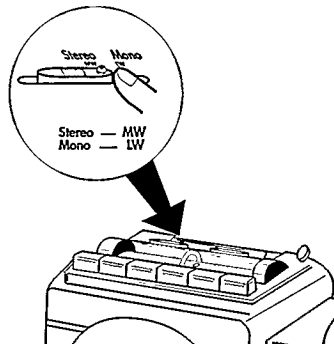

- d) Press STOP/EJECT  to open the cassette door.

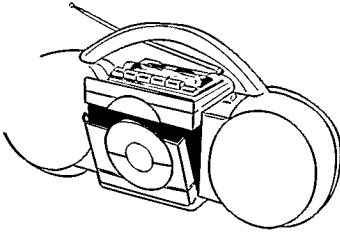

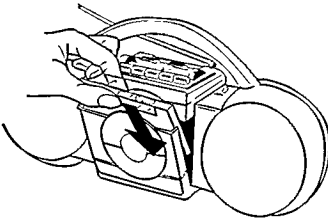

- e) Put in the cassette.
Use a cassette with the tab not broken out!

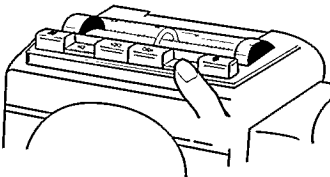

- f) Press RECORD .



- g) To monitor your recording, use TONE  and VOLUME  to adjust your sound.

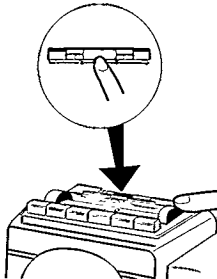

Note:

Recording is permissible insofar as copyright or other rights of third parties are not infringed.

- h) For brief interruptions, press pause  to restart recording press again.

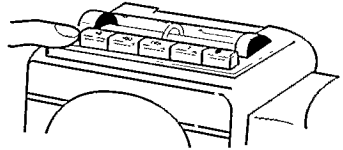

- i) Press STOP/EJECT  to stop recording.

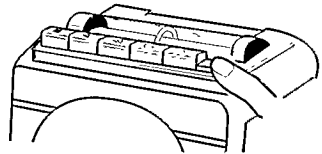

- j) To switch off the set, set mode-switch  to TAPE, and make sure no recording button is pressed.

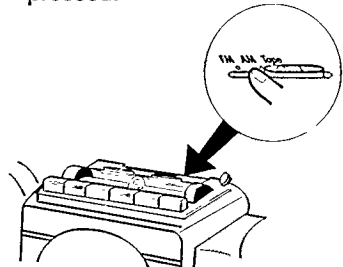

Tape Recording from MICROPHONE ⑧

- a) Tune volume ⑥ to zero.

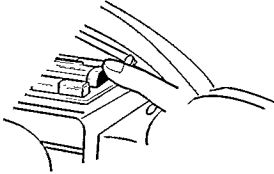

- b) Make sure that you speak in front of the internal microphone.

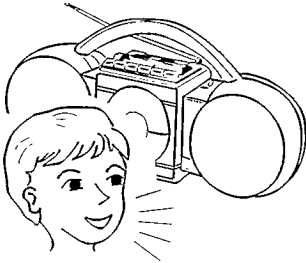

PLAYBACK

- a) Set modeswitch ⑤ to TAPE.

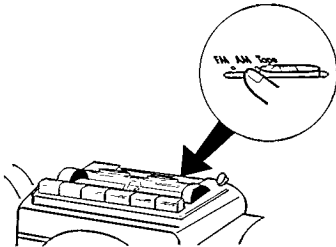

- b) Press STOP/EJECT ■ to open the cassette door.

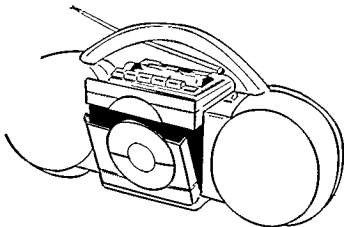

- c) Put in the cassette.

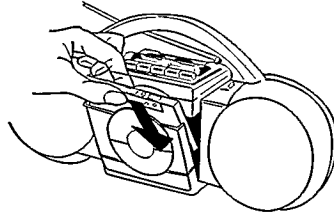

- d) Press PLAY ◀.

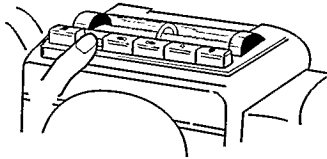

- e) Use TONE ④ and VOLUME ⑥ to adjust the sound.

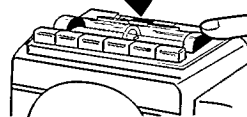
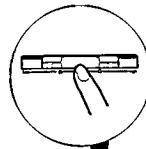

- f) To listen with a headphones, plug your headphone into ⑦.

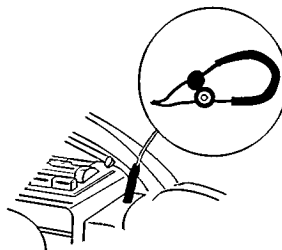

- g) To stop playing, press STOP/EJECT ■.

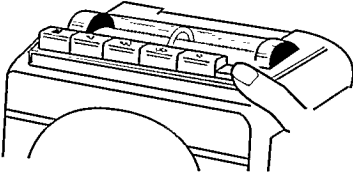

- h) To switch off, set mode-switch ⑤ to TAPE and make sure no recording button is pressed.

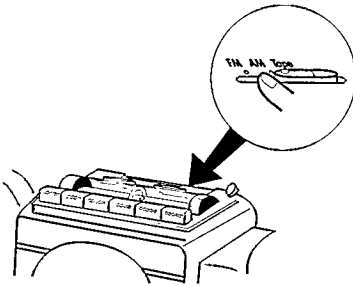

MAINTENANCE

To keep your set in tip top condition;

- a) Unplug the mains and remove batteries when not using the unit for long periods. This prevents damage from battery leakage and corrosion.

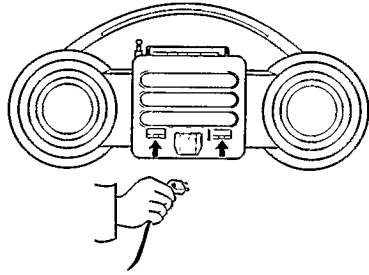

Keep unit away from direct sun or rain.

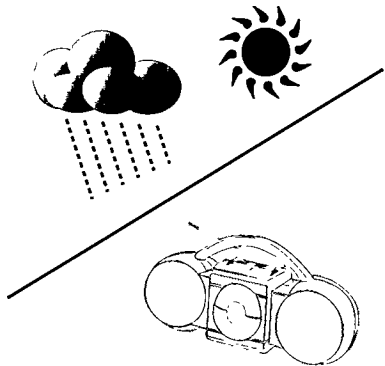

Do not expose the set, batteries or cassettes to rain, moisture, or for any great length of time, to excessive heat from heating equipment or direct sunshine, e.g. in motor cars parked in the sun.

b) Clean the parts after playing for a long time or once a month (on average)

–Press STOP/EJECT ■ to open cassette holder.

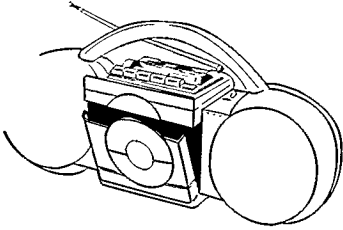

–Use a cotton bud slightly moistened with a head cleaning fluid.



–Press PLAY ◀ and clean ④.

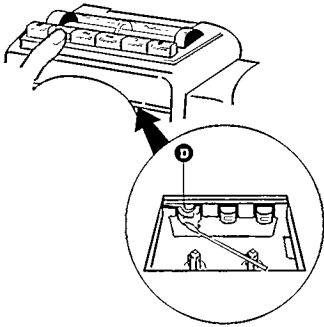

–Press PAUSE || and clean ③, ②, and ①.

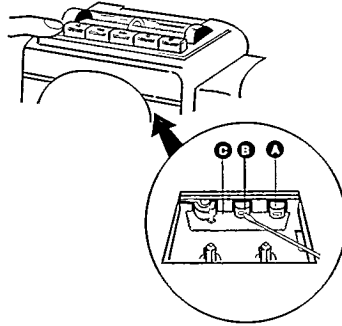

–After cleaning, press STOP/EJECT ■.

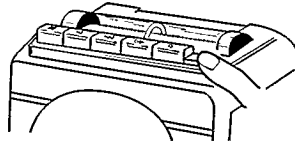

The type plate is on the base of the set.

- If in doubt, call an electrician.
- The unit complies with the radio interference requirements as laid down in E.C. (European Community) regulations.
- Copyright
Recording & Playback of material may require consent.

GUARANTEE AND SERVICE FOR UNITED KINGDOM

Philips sell this product subject to the understanding that if any defect in manufacture or material shall appear in it within 12 months from the date of consumer sale, the dealer from whom the product was purchased will arrange for such defect to be rectified without charge, provided:

1. Reasonable evidence is supplied that the product was purchased within 12 months prior to the date of claim
2. The defect is not due to use of the product for other than domestic purposes, or on an incorrect voltage, or contrary to the Company's operating instructions, or to accidental damage (whether in transit or otherwise), misuse, neglect or inoperative repair.

Products sent for service should be adequately packed so no liability can be accepted for damage or loss in transit, and name and address must be enclosed.

Facts about free service

When service is required, apply to the dealer from whom the product was purchased. Should any difficulty be experienced in obtaining Service, e.g. in the event of the dealer having ceased to trade, you are advised to contact Philips Service.

These statements do not affect the statutory rights of a consumer.

If you have any questions which your dealer cannot answer, please write to

Philips Consumer Relations, P.O. Box 298, 420 London Road,

CROYDON CR9 3QR, or ☎ (01) 689-2166 Consumer Advice.

Please retain this card. Produce if service is required.

GUARANTEE AND SERVICE VALID FOR IRELAND

This apparatus is made of high quality material and great care has been taken in its manufacture

Philips, therefore, give you a guarantee on parts against failures arising from faulty workmanship or material for 12 months after date of purchase. This guarantee is valid on the condition that this certificate is completed and signed immediately on delivery of the apparatus. In case of failure ask your dealer for further information

If you have any questions which your dealer cannot answer, you may apply to **Philips Electrical (Ireland) Ltd., Service Department, Newstead, Clonskeagh, DUBLIN 14, ☎ 69 33 55.**

GUARANTEE AND SERVICE VALID FOR AUSTRALIA

The benefits given to the purchaser by this warranty are in addition to all other rights and remedies, which, under the Trade Practices Act or other Commonwealth or State law, the purchaser or owner has in respect of the product.

The Philips product carries the following warranties:

C-Series HiFi-systems. 12 months Compact Disc Players: 12 months. Home Audio Systems: 6 months. Clock radios, portable radios, cassette recorders, cassette players and radio recorders: 90 days.

Any defect in materials or workmanship occurring within the specified period from the date of delivery, will be rectified free of charge by the retailer from whom this product was purchased

Note: Please retain your purchase docket to assist prompt service

Conditions of this warranty

1. All claims for warranty service must be made to the retailer from whom this product was purchased. All transport charges incurred in connection with warranty service or replacement will be paid by the purchaser.
2. These warranties do not cover batteries and extend only to defects in materials or workmanship occurring under normal use of the product where operated in accordance with our instructions.

Philips Consumer Products Division, Technology Park, Figtree Drive, Australia Centre, HOME BUSH 2140, New South Wales

GUARANTEE AND SERVICE FOR NEW ZEALAND

Thank you for purchasing this quality Philips product. The document you are now reading is your guarantee card

Guarantee

Philips New Zealand Ltd guarantees this product against defective components and faulty workmanship for a period of 12 months. Any defect in materials or workmanship occurring within 12 months from the date of purchase subject to the following conditions will be rectified free of charge by the retailer from whom this product was purchased

Conditions.

1. The product must have been purchased in New Zealand, and this guarantee card completed at time of purchase (this is your proof of the date of purchase).
2. The guarantee applies only to faults caused by defective components, or faulty workmanship on the part of the manufacturer.
3. The guarantee does not cover failures caused by misuse, neglect, normal wear and tear, accidental breakage, use on the incorrect voltage, use contrary to operating instructions, or unauthorised modification to the product or repair by an unauthorised technician
4. Reasonable evidence (in the form of a sales docket or completed guarantee card) must be supplied to indicate that the product was purchased no more than 12 months prior to the date of your claim
5. In the event of a failure, Philips shall be under no liability for any injury, or any loss or damage caused to property or products other than the product under guarantee. This guarantee does not prejudice your rights under common law and statute, and is in addition to the normal responsibilities of the retailer and Philips

How to claim.

Should your Philips product fail within the guarantee period, please return it to the retailer from whom it was purchased. In most cases the retailer will be able to satisfactorily repair or replace the product.

However, should the retailer not be able to conclude the matter satisfactorily, or if you have other difficulties claiming under this guarantee, please contact

the Guarantee Controller, Philips New Zealand Ltd,

P.O. Box 1041, AUCKLAND - ☎ (09) 605-914

GARANTIE EN SERVICE IN NEDERLAND

• Wat wordt gegarandeerd?

Philips Nederland B.V. garandeert dat dit apparaat kosteloos wordt hersteld indien - bij normaal particulier gebruik volgens de gebruiksaanwijzing - binnen 12 maanden na aankoopdatum fabricage- en/of materiaalfouten optreden

• Wie voert de garantie uit?

De zorg voor de uitvoering van de garantie berust bij de handelaar die u het apparaat verkocht heeft. De handelaar kan daarbij eventueel een beroep doen op een der Philips Service vestigingen

• Uw aankoopbon + de identificatiekaart

De identificatiekaart is uw garantiebewijs. U kunt alleen een beroep doen op de bovenschreven garantie tegen overlegging van de aankoopbon (factuur, kassabon of kvitantje), in combinatie met de identificatiekaart, waarop typenummer en serienummer zijn vermeld. Uit de aankoopbon dienen duidelijk de aankoopdatum en de naam van de handelaar te blijken. Mocht het noodzakelijk zijn deze documenten aan uw handelaar af te geven, dan kunt u hem daarvoor een ontvangstbewijs vragen

De garantie vervalt indien op de genoemde documenten iets is veranderd, doorgehaald, verwijderd of onleesbaar gemaakt. De garantie vervalt eveneens indien het typenummer en/of serienummer op het apparaat is veranderd, doorgehaald, verwijderd of onleesbaar gemaakt

• Hoe te handelen bij een storing?

Om onnodige kosten te voorkomen, raden wij u aan bij storingen eerst nauwkeurig de gebruiksaanwijzing te lezen. Indien de gebruiksaanwijzing daarin uitkomst biedt, kunt u uw handelaar raadplegen en/of hem het apparaat ter reparatie aanbieden

• ...en bij problemen?

Bij problemen omtrent de garantie-uitvoering kunt u zich in verbinding stellen met **Philips Nederland B.V. Afdeling Consumentenbelangen, Antwoordnummer 500, 5600 VB EINDHOVEN** (postzegel niet nodig), of ☎ **040-78 11 78.**

GARANTIE FÜR DIE SCHWEIZ

Philips-Geräte sind aus erstklassigem Material und mit größter Sorgfalt hergestellt worden. Dieses Gerät wird Ihnen gute Dienste leisten, sofern es sachgemäß bedient und unterhalten wird. Trotz aller Sorgfalt ist das Auftreten von Fehlern in oft ganz auszuscheiden. Im Falle eines Defektes wenden Sie sich bitte unter Vorlage des Einkaufsbeleges und des Gerätepasses an das Fachgeschäft, in welchem Sie das Gerät erworben haben

GARANTIE POUR LA SUISSE

Les appareils Philips ont été fabriqués au moyen de matériaux de toute première qualité et avec beaucoup de soins. Cet appareil vous donnera encore plus de satisfaction si l'utilisation et l'entretien sont suivis selon le mode d'emploi. Malgré tous les soins apportés, l'apparition de défauts n'est pas exclue. Dans ce cas, nous vous serons reconnaissants de bien vouloir vous adresser directement chez votre vendeur muni du passeport de l'appareil ainsi que de la facture s'y reportant.

GARANZIA PER LA SVIZZERA

Gli apparecchi Philips sono prodotti con materiali di prima qualità e assemblati con la massima cura. Essi Vi offriranno un ottimo servizio, in cambio di un accurato uso e manutenzione. Malgrado tutto i nostri sforzi, non è escluso che possano verificarsi dei guasti. In caso di difetto Vi preghiamo di rivolgerVi al Vostro fornitore specializzato, portando con Voi il passaporto assieme al documento d'acquisto

GARANTIE EN SERVICE IN BELGIË EN LUXEMBOURG

In België en Luxemburg gelden uitsluitend de garantie-epalingen die in het door uw handelaar verstrekte garantiebewijs staan aangegeven

• **Voor België:** Indien u na de aankoop van een of ander Philips apparaat problemen heeft met bijv. de werking, de werkg. of het gebruik ervan, en indien de verdere die u deze apparaten verkocht heeft moeilijkheden ondervindt om deze problemen op te lossen, stelt u zich dan telefonisch of schriftelijk in verbinding met onze dienst **'Klanten Contact', de Broeckereplein 2, 1000 BRUSSEL - ☎ 02211 91 11**

GARANTIE EN BELGIEUE ET LUXEMBOURG

Pour les conditions de garantie en Belgique et Luxembourg veuillez vous référer à la carte de garantie que le revendeur doit vous remettre

• **Pour la Belgique:** Si après l'achat de l'un ou l'autre appareil Philips vous avez des problèmes concernant par exemple la garantie, le fonctionnement ou l'utilisation de l'appareil et que le distributeur qui vous a vendu ces appareils éprouve des difficultés pour les résoudre, contactez soit par téléphone, soit par écrit avec notre service **'Contact Clientèle', Place de Broeckère 2, 1000 BRUXELLES - ☎ 02211 91 11**

GARANTIE IN ÖSTERREICH

In Österreich ist die Gewährleistung für Verträge zwischen Händler und Käufer gesetzlich geregelt. Zur Geltendmachung des Gewährleistungsanspruches dient der Kaufbeleg.

Die Österreichische Philips Industrie GmbH unterstützt die Gewährleistungspflicht ihres Händlers für Heugeräte, die der Handel über die Österreichische Philips Industrie GmbH bzw. Homy VertriebsgmbH bezogen hat, dadurch, daß für den Käufer innerhalb von 6 Monaten ab Verkaufsdatum Funktionsmängel (Fabrikations- oder Materialfehler) in einer unserer Service-Filialen kostenlos, d.h. ohne Verrechnung von Arbeitszeit und Material, behoben werden. Schäden, die durch äußere Einflüsse, unsachgemäße Behandlung oder unsachgemäßen Fremdeingriff entstanden sind, sowie Gehäusefehler oder Glasbruch, sind von dieser Zusage ausgeschlossen.

Philips Zentrale Kundeninformation:

— 1101 WIEN, Triesterstraße 64, ☎ 0222-60101-DW 1620 oder 1563

— 6020 INNSBRUCK, Klostergasse 4, ☎ 0522-74634

— 9020 KLAGENFURT, Villacher Straße 161, ☎ 0463-22397-DW 94

Philips Service-Organisation: 1232 WIEN, Ketzergasse 120, ☎ 0222-8662-0

INFORMATION SUR LA GARANTIE ET LE SERVICE APRÈS-VENTE EN FRANCE

Cet appareil PHILIPS a été fabriqué avec le souci de vous donner entière satisfaction. Sa garantie contractuelle est de la responsabilité du point de vente.

Cette garantie qui peut varier tant en durée qu'en contenu, ainsi que les modalités de service après-vente, doivent vous être précisées lors de l'achat par le vendeur qui, de plus, vous conseillera en cas de panne ou de défaillance.

A cet effet, il vous est demandé de conserver soigneusement votre facture et/ou le présent document dûment rempli et signé et/ou le contrat de garantie qui vous aura été remis conformément au décret N° 87-1045 du 22 décembre 1987.

Pour sa part, PHILIPS, soucieux de l'intérêt des consommateurs, apporte sa contribution aux efforts de points de vente, que ce soit en matière de garantie ou de service après-vente.

- matériellement, par la formation, l'assistance technique, la fourniture de pièces détachées,
- financièrement, selon des modalités précises définies entre PHILIPS et les points de vente.

Rappel: Vous bénéficiez en tout état de cause de dispositions des articles 1641 et suivants du code civil relatifs à la garantie légale.

Aucune garantie ne peut être mise en œuvre si la détérioration résulte d'une cause étrangère à l'appareil ou du non respect des prescriptions d'utilisation.

Service consommateurs PHILIPS:

☎ B.P. 49 - 77423 MARNE LA VALLÉE CÉDEX 2

☎ (16-1) 64 80 54 54 - Minitel 36 15 code: PHILIPS

SNC PHILIPS ELECTRONIQUE DOMESTIQUE - RCS NANTERRE B 333 6760 833

GARANTIE FÜR DIE BUNDESREPUBLIK DEUTSCHLAND

Philips-Geräte sind Markenartikel, die mit größter Präzision nach modernsten Fertigungsmethoden und mit einem Höchstmaß an Sorgfalt hergestellt werden. Das Gerät wird Ihnen gute Dienste leisten, vorausgesetzt daß Sie es sachgemäß bedienen und unterhalten. Trotz aller Sorgfalt ist das Auftreten von Fehlern nicht auszuschließen. Ihr Partner für die Behebung derartiger Fehler ist Ihr Fachhändler, bei dem das Gerät erworben wurde. Falls ein Reklamationsfall eintritt, wenden Sie sich bitte unter Vorlage des Einkaufsbeleges und des Gerätepasses an Ihren Fachhändler.

GARANZIA E ASSISTENZA VALIDI PER L'ITALIA

Questo apparecchio è stato realizzato con materiali di prima qualità e costruito con la massima cura. La Philips comunque fornisce all'acquirente una Garanzia di buon funzionamento secondo le condizioni stabilite dall'ANIE. Tale Garanzia decorre dalla data di acquisto ed ha la durata di **6 mesi**. Per aver diritto alla Garanzia è necessario che questo certificato porti i dati di Modello e Matricola dell'apparecchio, la data di acquisto ed il numero del rivenditore, inoltre per tutti gli apparecchi per i quali è prevista la "ricevuta fiscale" (o altro documento di consegna) il documento stesso dovrà essere conservato con questo certificato a certificazione della data d'acquisto.

In caso di necessità il prodotto dovrà essere fatto pervenire al Centro di Assistenza più vicino al suo recapito e pubblicato sugli elenchi telefonici della zona di residenza alla voce Philips.

Per questo apparecchio Philips offre un Abbonamento all'Assistenza Tecnica. Per informazioni rivolgersi ai Centri di Assistenza o al servizio Consumatori Philips. **Philips S.p.A., Viale del Fulvio Testi 327, 20162 MILANO, ☎ 1678-20026**

CONDIÇÕES VÁLIDAS PARA PORTUGAL

A Philips Portuguesa, SA, assegura ao comprador deste aparelho garantia contra qualquer defeito do material ou fabrico, pelo prazo de 6 meses, contado a partir da data de aquisição. As agulhas de fonocaptores não têm qualquer garantia.

A Philips Portuguesa, SA, anula a garantia ao aparelho desde que se verifique ser a deficiência motivada por acidente, utilização incorrecta, causas externas, ou nos casos em que apresente vestígios de ter sido violado, ajustado ou reparado por entidade não autorizada. Também será considerada nula a garantia se este certificado apresentar rasuras ou alterações.

A Philips Portuguesa, SA, obriga-se a prestar a garantia referida somente nos seus Serviços Técnicos ou nos Concessionários de Serviço autorizados. As despesas e custos de transporte de e para as oficinas serão sempre da responsabilidade do comprador.

Nota: Para que o aparelho seja assistido ao abrigo da garantia, é indispensável que seja apresentado este certificado, devidamente preenchido e autenticado, por vendedor autorizado, aquando da sua aquisição.

Se sobre esta garantia necessitar algum esclarecimento que o vendedor não lhe possa dar, deve dirigir-se a **Philips Portuguesa, SA,**

— **Outeira - Camaxide - 2795 LINDA A VELHA - ☎ 418 00 71/9**

— **R. Eng. Ezequiel de Campos, 182 - 4100 PORTO - ☎ 67 25 13**

GARANTI OG SERVICE FOR DANMARK

De er nu ejer af et apparat, hvis konstruktion er baseret på erfaring og lang tids forskning. Philips garanterer for kvaliteten, og hvert led i fabrikationen er underkastet stadig kontrol. Alle henvendelser om fejl under garantien skal rettes til den forhandler, der har udlæst og underkædet garanteret, hvorpå de gældende garantibestemmelser tillige er anført. Garantien er kun gældende i købslandet.

GARANTI I NORGE

De er nå ejer av et apparat som er basert på lang tids forskning og erfaring. Philips garanterer for kvaliteten, men hvis en feil skulle oppstå bes De ta kontakt med den forhandler som har utlevert og underkrevet garantert. Garantien gjelder kun i kjøpslandet hvor de gjeldende garantibestemmelser må følges.

Hvis De trenger ytterligere opplysninger utover de forhandleren kan gi Dem, kan De henvende Dem til **Norsk A/S Philips, Avd. Audio/Video, Sandstuveien 70, OSLO 6 - ☎ 02 - 68 02 00**

TAKUU JA HUOLTO

Tämän tuotteen rakenne on pitkäaikaisen, kokemuksella tehdyn tutkimustyön tulos. Jatkuvan en tuotantovaiheissa tehtävän laaturatkailun vuoksi Philips takaa tuotteen- sa laadun.

Tarkemmat tiedot takuuehdoista saat Philips-myyjältä tai alla olevasta osoitteesta.

Oy Philips AB, Sinihallintie 3, 02630 ESPOO - ☎ (358-0)-50261

☎ Oy Philips AB, P.O. Box 75, 02631 ESPOO

GARANTÍA PARA MÉXICO

Este aparato está fabricado con materiales de alta calidad y ha sido cuidadosamente verificado. Philips, por lo tanto, da a usted una garantía de 12 meses a partir de su fecha de compra.

La garantía ampara la reposición de las piezas defectuosas debidas a fallas en su montaje o en los materiales, incluyendo la mano de obra necesaria para su reemplazo en nuestras Sucursales o talleres autorizados.

En caso de fallas en su aparato le rogamos se sirva poner en contacto con su distribuidor.

Esta garantía no cubrirá las averías que resulten como consecuencia de una instalación incorrecta del aparato, manifiesto maltrato o uso inadecuado del mismo. Philips se obliga a reparar y devolver a usted su aparato en un plazo no mayor de 30 días hábiles contados a partir de la fecha de haber ingresado su aparato a uno de nuestros talleres.

Para que esta garantía sea válida, es necesario que el certificado que figura en la parte posterior de este instructivo haya sido debidamente llenado en el momento de la compra del aparato.

En caso de extravío del certificado con la presentación de la factura o remisión de su aparato podrá hacer efectiva la garantía correspondiente.

Si usted tiene alguna duda o pregunta que no le pueda solucionar su distribuidor, por favor ponerse en contacto con **Oficinas Centrales de Servicio,**

Av. Coyoacán No. 1051, Col. del Valle, 03100 MÉXICO, D.F.

☎ 5-75-20-22 o 5-75-01-00

PHILIPS IBÉRICA, S.A.E.

Garantiza este aparato durante 6 meses, a partir de la fecha de adquisición, de la forma siguiente:

1. Cubriendo cualquier defecto de fabricación o vicio de origen, así como la totalidad de sus componentes, incluyendo la mano de obra necesaria para el reemplazo de las piezas defectuosas, por nuestros talleres autorizados.
2. Esta garantía no cubrirá la avería, si es consecuencia de incorrecta instalación del aparato, manifiesto mal trato o uso inadecuado del mismo. La calificación de las averías corresponderá únicamente a los servicios técnicos de los talleres autorizados Philips.
3. Las reparaciones que pudieran producirse durante el período de vigencia de la presente garantía se efectuarán, bien en el domicilio del usuario, bien en los talleres autorizados Philips, a libre elección y criterio de esta última.
4. Transcurrido un mes desde la fecha de adquisición del aparato, todos los gastos de desplazamiento del personal técnico para proceder al examen y/o reparación del aparato correrán por cuenta del usuario de acuerdo con las tarifas establecidas para este concepto.
5. En todas las reparaciones se deberá acompañar al aparato factura de compra y la presente garantía debidamente cumplimentada, con la indicación exacta de la fecha de venta del aparato.
6. En todo caso, el titular de la garantía tiene los derechos mínimos reconocidos por la Ley.

Titular (Comprador)

Domicilio

ΠΛΗΡΟΦΟΡΙΕΣ ΓΙΑ SERVICE ΚΑΙ ΕΓΓΥΗΣΗ ΣΤΗΝ ΕΛΛΑΔΑ

Η συσκευή έχει ελεγχθεί σχολαστικά, η λειτουργία της είναι οριστική και λόγω αντικαταστάσεώς της δεν προκειται σε κομμία περίπτωση να προκύβει. Αν όμως, παρ' όλα αυτά, κάποιο εξάρτημα δεν λειτουργήσει, το εξάρτημα αυτό και η εργασία επισκευής παρεχόνται από την εταιρία δωρεάν. Η προσκομιζόμενη για επισκευή συσκευή πρέπει να συνοδεύεται απαραίτητα από το ΔΕΛΤΙΟ ΔΙΑΝΚΙΗΣ ΠΩΛΗΣΕΩΣ, η φωτοτυπία του, και το παρον εντυπο συμπληρωμένο και στρατηγμένο από το καταστήμα αγοράς.

Η εργασία ισχύει για ΕΝΑ ετος, από την ημερομηνία αγοράς. Η εργασία δεν ισχύει στην παρακάτω περιπτώσεις:
α. Για ανωμαλία οχι από βλαβή της συσκευής, αλλά από φθορά η βλαβή, που προκλήθηκε από τρίτους ή από μεταβολή της τάσεώς του ηλεκτρικού ρευστού.

β. Για ανωμαλία λόγω ελαττωματικής εγκαταστάσεώς της συσκευής γ. Όταν ο αριθμός κατασκευής της συσκευής έχει αλλοιωθεί.

δ. Για κεφάλες πικ-απ και μικροφώνω.

Η εργασία επισκευής γίνεται στα Εργαστήρια της Εταιρίας, όπου ο πελάτης πρέπει να μεταφέρει τη συσκευή με δική του δαπάνη. Κονενός αντιπροσώπωσ δεν έχει το δικαίωμα αλλαγής των ορων εργασεώς. Μετα τη λήξη του χρόνου εργασεώς, για κάθε πρόβλημα συντηρησεώς, επισκευής ή συμβουλήσ, σας συνιστούμε να απευθυνεσθε στα κατά τοπους Service της Εταιρίας.

Διεύθυνση Κεντρικών SERVICE PHILIPS:

25ης Μαρτίου 15, 177 78 Ταυρος - ☎ 4894.911

Τηλεμνηστική 62, 546 93 Θεσσαλονίκη - ☎ 260.621

**Guarantee certificate
Identificatiekaart
Garantibeviset**

**Certificat de garantie
Certificado de garantia
Takuutodistus**

**Garantieschein
Certificato di garanzia
Εγγύηση**

Type no. of product:
No. de type du produit:
Typennummer des Gerätes:
Typenr. van het apparaat:
Tipo no. del producto:

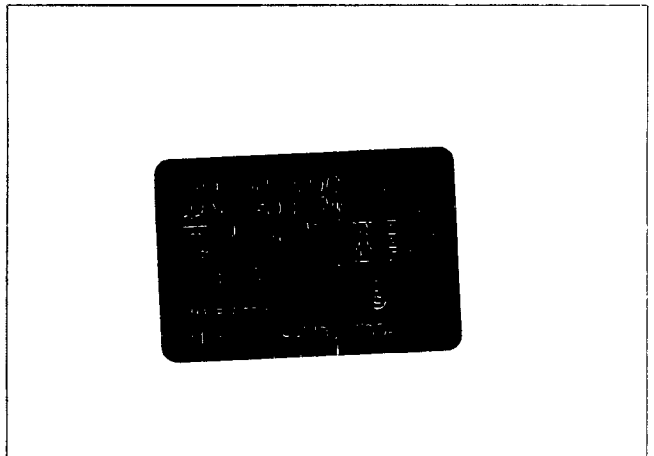

Date of purchase – Date d'achat – Kaufdatum – Koopdatum - Fecha de compra – Data da compra – Data di acquisto - Købsdato - Kjøpedato
Inköpsdato – Ostopäivä – Ημερομηνία αγοράς

19

Dealer's name, address and signature
Nom, adresse et signature du revendeur
Name, Anschrift und Unterschrift des Händlers
Naam, adres en handtekening van de handelaar
Nombre, dirección y firma del distribuidor
Nome, indirizzo e firma del fornitore
Nome, morada e assinatura da loja
Forhandlerens navn, adresse og underskrift
Återförsäljarens namn, adress och namnteckning
Myyjän nimi, osoite ja allekirjoitus
Όνομα/Επωνύμο Αντιπροσώπου

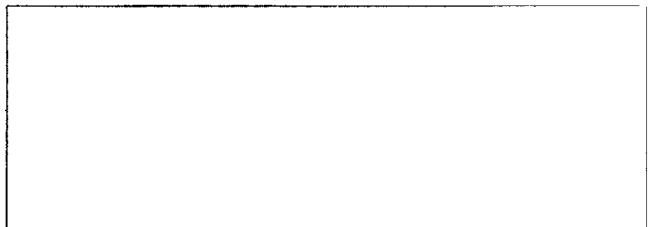

Free Manuals Download Website

<http://myh66.com>

<http://usermanuals.us>

<http://www.somanuals.com>

<http://www.4manuals.cc>

<http://www.manual-lib.com>

<http://www.404manual.com>

<http://www.luxmanual.com>

<http://aubethermostatmanual.com>

Golf course search by state

<http://golfingnear.com>

Email search by domain

<http://emailbydomain.com>

Auto manuals search

<http://auto.somanuals.com>

TV manuals search

<http://tv.somanuals.com>