

Register your product and get support at
www.philips.com/welcome

AJ3500



EN User manual

PHILIPS

1

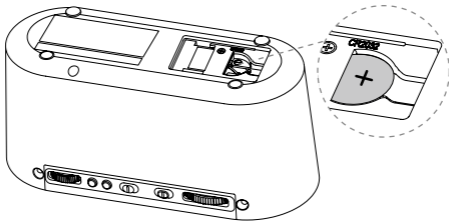
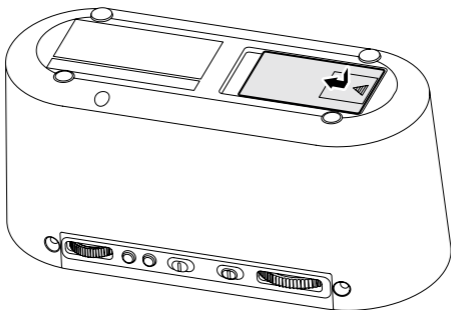

2

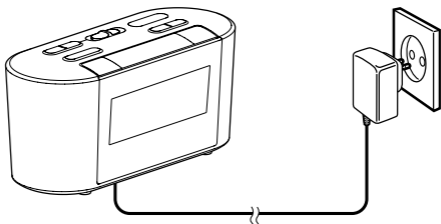

3

1

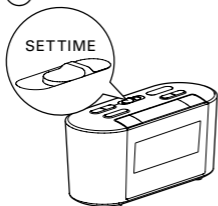

2



3

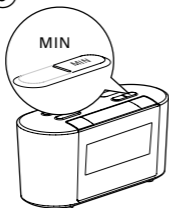

4

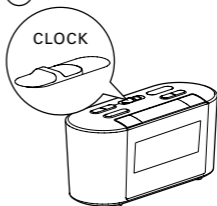

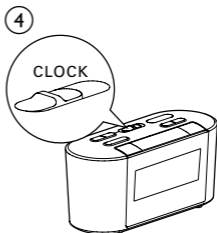
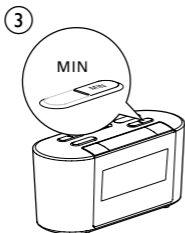
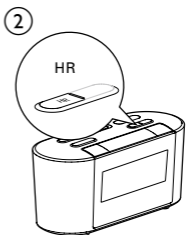
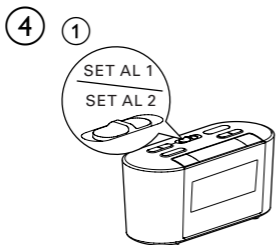

5

1



2



3

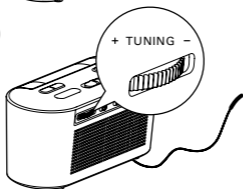

6

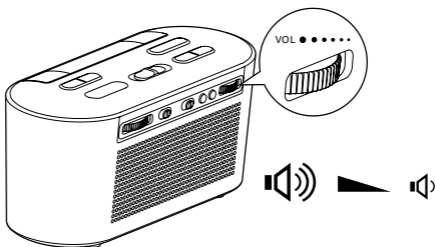

1 Important

Safety

- Read these instructions.
- Heed all warnings.
- Follow all instructions.
- Do not use this clock radio near water.
- Clean only with dry cloth.
- Do not block any ventilation openings. Install in accordance with the manufacturer's instructions.
- Do not install near any heat sources such as radiators, heat registers, stoves, or other apparatus (including amplifiers) that produce heat.
- Protect the power cord from being walked on or pinched, particularly at plugs, convenience receptacles, and the point where they exit from the clock radio.
- Only use attachments/accessories specified by the manufacturer.
- Unplug this clock radio during lightning storms or when unused for long periods of time.
- Refer all servicing to qualified service personnel. Servicing is required when the clock radio has been damaged in any way, such as power-supply cord or plug is damaged, liquid has been spilled or objects have fallen into the clock radio, the clock radio has been exposed to rain or moisture, does not operate normally, or has been dropped.
- This clock radio shall not be exposed to dripping or splashing.

- Do not place any sources of danger on the clock radio (e.g. liquid filled objects, lighted candles).
- Where the MAINS plug or an appliance coupler is used as the disconnect device, the disconnect device shall remain readily operable.

2 Your clock radio

Congratulations on your purchase, and welcome to Philips! To fully benefit from the support that Philips offers, register your product at www.philips.com/welcome.

Introduction

With this unit, you can:

- listen to FM/MW radio;
- know the time;
- set two alarms; and
- wake up by buzzer alarm or FM/MW radio.

What's in the box

Check and identify the contents of your package:

- Main unit (with a battery)
- User manual

If you contact Philips, you will be asked for the model and serial number of this apparatus. The model number and serial number are on the bottom of the clock radio. Write the numbers here:

Model No. _____

Serial No. _____

Overview of the main unit

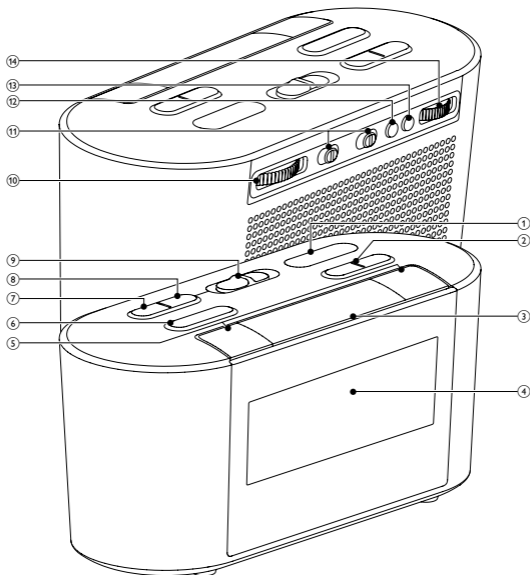

- ① **FM/MW frequency indicator**
 - Show FM/MW frequency.
- ② **HR/MIN**
 - Adjust hour/minute.

③ REPEAT ALARM/BRIGHTNESS CONTROL

- Snooze alarm.
- Adjust display brightness.

④ Display panel

- Show current status.

⑤ AL1/AL2

- Turn on/off alarm.
- View alarm settings.

⑥ RADIO

- Turn on/off radio.

⑦ FM/MW

- Select FM/MW tuner.

⑧ SLEEP

- Set sleep timer.

⑨ CLOCK/SET AL1/SET AL2/SET TIME

- Set time/alarm.
- View time.

⑩ + TUNING -

- Tune to radio stations.

⑪ AL1/AL2 RADIO BUZZ

- Select alarm source for Alarm 1/Alarm 2.

⑫ TIME ZONE

- Select time zone.

⑬ 12/24H·DST

- Select 12/24 hour format.
- Select daylight saving time (DST) option.

⑭ VOL

- Adjust volume.

3 Get started



Caution

- Use of controls or adjustments or performance of procedures other than herein may result in hazardous radiation exposure or other unsafe operation.

Always follow the instructions in this chapter in sequence.

Install battery ①



Warning

- Risk of explosion! Keep batteries away from heat, sunshine, or fire. Never discard batteries in fire.
- The battery contains chemical substances, so it should be disposed of properly.
- Danger of explosion if battery is incorrectly replaced. Replace only with the same or equivalent type.
- Keep children away from the battery.



Note

- You can only use AC power as power supply.
- When power is disconnected, the display backlight is off.
- The pre-installed lithium CR2032 battery can back up clock settings.

When  is displayed, replace the battery as indicated.

Connect power ②



Caution

- Risk of product damage! Ensure that the power voltage corresponds to the voltage printed on the back or underside of the clock radio.
- Risk of electric shock! When you unplug the AC adapter, always pull the plug from the socket. Never pull the cord.

Plug and set

The clock radio has “plug and set” feature. When power is connected, the clock is set automatically.

Select time zone

Check if the time of the clock radio is consistent with the local time. If not, adjust the time zone settings according to your location.

- 1 In standby mode, press **TIME ZONE**.
↳ The current time zone number blinks on the display panel.
- 2 Press **TIME ZONE** repeatedly to select time zone (-1 to +12 adjustable).

For Europe:

Western European Time (WET)	+0
Central European Time (CET)	+1 (Default)
Eastern European Time (EET)	+2
Moscow Standard Time (MST)	+3

Set clock ③

In standby mode, you can set clock manually.



Tip

- In clock setting mode, press and hold **HR/MIN** for one second, and the hour/minute digits increase or decrease continuously.

Select DST (daylight saving time) mode

For countries with daylight saving time (DST), the clock radio offers you DST option to adjust summer time.

In standby mode, press and hold **12/24H ·DST** for two seconds.

↳ The clock advances by one hour and **[DST]** is displayed.



Tip

- To exit DST mode, repeat the above operation.
- To select 12/24 hour format, press **12/24H ·DST** repeatedly.

4 Set alarm timer

Set alarm time ④

In standby mode, you can set two alarms to ring at different time.



Note

- In alarm setting mode, press and hold **HR/MIN** for one second, and the hour/minute digits increase or decrease continuously.

Select alarm sound



To select the last heard channel or buzzer as alarm sound, switch **AL1/AL2 RADIO BUZZ** to left or right.



Tip

- The gentle wake-up function is designed for all alarm sources.

Activate/deactivate alarm timer

- 1 Press **AL1/AL2** to view alarm settings.
- 2 Press **AL1/AL2** again to activate or deactivate the alarm timer.
↳  or  appears if alarm timer is on and disappears if it is off.
 - To stop alarm, press the corresponding **AL1/AL2**.
 - The alarm repeats ringing for the next day except in hotel mode.



Note

- When alarm sounds, you cannot adjust volume by rotating **VOL**.

Snooze alarm

When alarm sounds, press **REPEAT ALARM/BRIGHTNESS CONTROL**.

↳ The alarm snoozes and repeats ringing five minutes later.

To adjust alarm interval (in minutes), press **REPEAT ALARM/BRIGHTNESS CONTROL** repeatedly.

5 → 10 → 15 → 20 → 25 → 30



5 Listen to radio

Tune to radio stations (5)



Tip

- Position the antenna as far as possible from TV, VCR, or other radiation source.
- For better reception, fully extend and adjust the position of the antenna.

Adjust volume ⑥

6 Other features

Set sleep timer

This clock radio can switch to standby mode automatically after a preset period.

- 1 Press **SLEEP** repeatedly to select sleep timer period (in minutes).
↳ When the sleep timer is activated, **zZ** is displayed.

To deactivate the sleep timer:

- 1 Press **SLEEP** repeatedly until **[OFF]** (off) appears.

15 → 30 → 60 → 90 → 120

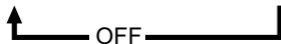

Select hotel mode

In hotel mode, the alarm can only be activated once at the preset time and will not repeat ringing on the next day.

Hold down **SLEEP**, then press and hold **AL2** simultaneously for five seconds.

- ↳ **[ON]** is displayed.



Note

- To return to normal mode, repeat the above operation. **[OFF]** is displayed.

Adjust display brightness

Press **REPEAT ALARM/BRIGHTNESS CONTROL** repeatedly to select different brightness level: high, mid, and low.

7 Product information



Note

- Product information is subject to change without prior notice.

Specifications

Amplifier

Rated Output Power

0.6W RMS

Tuner

Tuning Range	FM: 87.5 - 108 MHz MW: 520-1620 KHz
Sensitivity - Mono, 26dB S/N Ratio	FM: <22 dBu MW: <92 dBuV/M
Search Selectivity	FM: <28 dBu MW:<98 dBuV/M
Total Harmonic Distortion	FM: <3% MW:<5%
Signal to Noise Ratio	FM: >45 dB MW:>40 dB

General information

AC power	220-240 V ~, 50/60Hz
Operation Power Consumption	< 3W
Standby Power Consumption	< 2W
Dimensions - Main Unit (W x H x D)	179.5 x 87 x 76 mm
Weight - With Packing - Main Unit	0.7 kg 0.5 kg

8 Troubleshooting



Warning

- Never remove the casing of this apparatus.

To keep the warranty valid, never try to repair the system yourself. If you encounter problems when using this apparatus, check the following points before requesting service. If the problem remains unsolved, go to the Philips web site (www.philips.com/welcome). When you contact Philips, ensure that the apparatus is nearby and the model number and serial number are available.

No power

- Ensure that the AC power plug of the unit is connected properly.
- Ensure that there is power at the AC outlet.

No sound

- Adjust the volume.

No response from the unit

- Disconnect and reconnect the AC power plug, then turn on the unit again.

Poor radio reception

- Increase the distance between the unit and your TV or VCR.
- Fully extend the FM antenna.

Alarm does not work

- Set the clock/alarm correctly.

Clock/alarm setting erased

- Power has been interrupted or the power plug has been disconnected.
- Reset the clock/alarm.

9 Notice



This product complies with the radio interference requirements of the European Community.

Any changes or modifications made to this device that are not expressly approved by Philips Consumer Lifestyle may void the user's authority to operate the equipment.



Note

- The type plate is located on the bottom of the apparatus.



Your product is designed and manufactured with high quality materials and components, which can be recycled and reused.



When this crossed-out wheeled bin symbol is attached to a product it means that the product is covered by the European Directive 2002/96/EC.

Please inform yourself about the local separate collection system for electrical and electronic products.

Please act according to your local rules and do not dispose of your old products with your normal household waste. Correct disposal of your old product helps to prevent potential negative consequences for the environment and human health.



Your product contains batteries covered by the European Directive 2006/66/EC, which cannot be disposed with normal household waste. Please inform yourself about the local rules on separate collection of batteries because correct disposal helps to prevent negative consequences for the environmental and human health.

Environmental information

All unnecessary packaging has been omitted. We have tried to make the packaging easy to separate into three materials: cardboard (box), polystyrene foam (buffer) and polyethylene (bags, protective foam sheet.)

Your system consists of materials which can be recycled and reused if disassembled by a specialized company. Please observe the local regulations regarding the disposal of packaging materials, exhausted batteries and old equipment.

2010 © Koninklijke Philips Electronics N.V. All rights reserved.

Specifications are subject to change without notice. Trademarks are the property of Koninklijke Philips Electronics N.V. or their respective owners. Philips reserves the right to change products at any time without being obliged to adjust earlier supplies accordingly.

Norge

Typeskilt finnes på apparatens underside.

Observer: Nettbryteren er sekundert innkoplet. Den innebygde nettdelen er derfor ikke frakoplet nettet så lenge apparatet er tilsluttet nettkontakten.

For å redusere faren for brann eller elektrisk støt, skal apparatet ikke utsettes for regn eller fuktighet.



© 2010 Koninklijke Philips Electronics N.V.

All rights reserved.

AJ3500_12_UM_V1.0



Free Manuals Download Website

<http://myh66.com>

<http://usermanuals.us>

<http://www.somanuals.com>

<http://www.4manuals.cc>

<http://www.manual-lib.com>

<http://www.404manual.com>

<http://www.luxmanual.com>

<http://aubethermostatmanual.com>

Golf course search by state

<http://golfingnear.com>

Email search by domain

<http://emailbydomain.com>

Auto manuals search

<http://auto.somanuals.com>

TV manuals search

<http://tv.somanuals.com>