

Register your product and get support at

AJ7010

www.philips.com/welcome



EN User manual

(A)

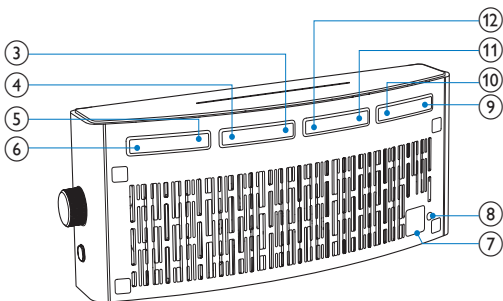
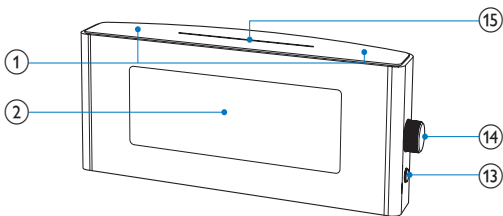

(B)

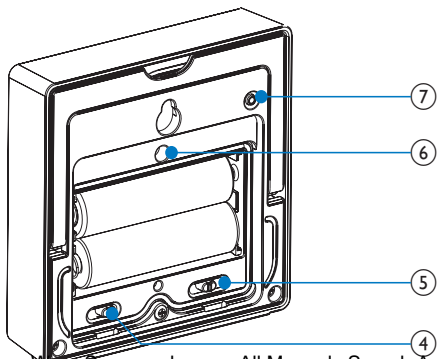
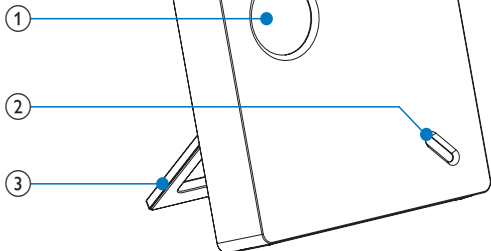

(C)

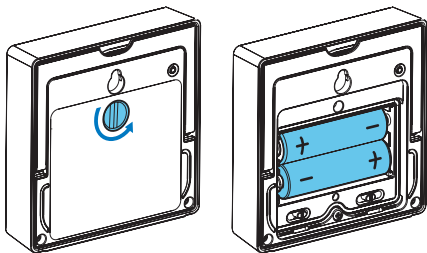

(D)

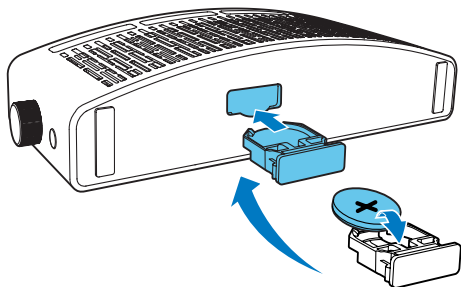

E

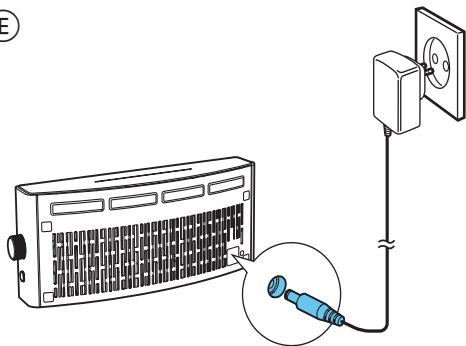

F

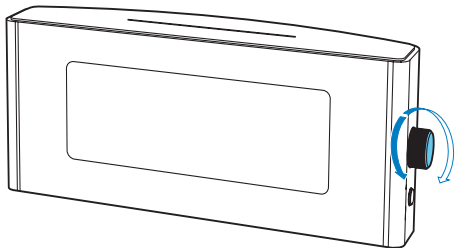

1 Important

- Read these instructions.
- Heed all warnings.
- Follow all instructions.
- Do not block any ventilation openings. Install in accordance with the manufacturer's instructions.
- Do not install near any heat sources such as radiators, heat registers, stoves, or other apparatus (including amplifiers) that produce heat.
- Protect the power cord from being walked on or pinched, particularly at plugs, convenience receptacles, and the point where they exit from the clock radio.
- Only use attachments/accessories specified by the manufacturer.
- Unplug this clock radio during lightning storms or when unused for long periods of time.
- Refer all servicing to qualified service personnel. Servicing is required when the clock radio has been damaged in any way, such as power-supply cord or plug is damaged, liquid has been spilled or objects have fallen into the clock radio, the clock radio has been exposed to rain or moisture, does not operate normally, or has been dropped.
- The main unit of the clock radio shall not be exposed to dripping or splashing.
- Do not place any sources of danger on the main unit of the clock radio (e.g. liquid filled objects, lighted candles).
- Where the plug of the Direct Plug-in Adapter is used as the disconnect device, the disconnect device shall remain readily operable.

2 Your clock radio

Congratulations on your purchase, and welcome to Philips! To fully benefit from the support that Philips offers, register your product at www.philips.com/welcome.

Introduction

With this clock radio, you can:

- listen to FM/MW radio;
 - set two alarms;
 - view time, date, and indoor/outdoor temperature;
 - adjust time zone and daylight saving time; and
 - be waken up by buzzer, radio, or stored nature sounds.
-

What's in the box

Check and identify the contents of your package:

- Main unit (with button cell battery)
 - Outdoor temperature sensor
 - Power adapter
 - User manual
 - Quick start guide
-

Overview of the main unit (A)

① AL1/AL2

- Set alarm.
- View alarm settings.
- Activate/deactivate alarm timer.

- ② **Display panel**
 - Show current information.
- ③ **DST**
 - Select daylight saving time (DST) mode.
- ④ **TIME ZONE**
 - Set time zone.
- ⑤ **DISPLAY**
 - Activate temperature display setting mode.
- ⑥ **NATURE SOUND**
 - Activate nature sound setting mode.
- ⑦ **AC 6V ~ 450mA**
 - Connect power.
- ⑧ **FM ANT**
 - Improve FM reception.
- ⑨ **TUNING MODE**
 - Select tuning mode.
- ⑩ **PRESET**
 - Select a preset radio station.
- ⑪ **FM/MW**
 - Select tuner source.
- ⑫ **SET TIME/PROG**
 - Set time.
 - Program radio stations.
- ⑬ **SLEEP**
 - Set sleep timer.

- ⑭ **Main knob**
- Adjust volume.
 - Confirm selection.
 - Adjust settings.
 - Deactivate nature sound.

- ⑮ **SNOOZE/BRIGHTNESS**
- Snooze alarm.
 - Adjust display brightness.

Overview of the outdoor sensor ②

- ① **Display panel**
- Show outdoor temperature and RF channel.
- ② **LED light**
- Blink when transmitting data to the main unit.
- ③ **Sensor support**
- ④ **°C/°F slide**
- Switch between Centigrade (°C) or Fahrenheit (°F) temperature display.
- ⑤ **CHANNEL1/2/3**
- Select RF channel to transmit signals.
- ⑥ **Lock for battery compartment (with screw)**
- ⑦ **RESET**
- Reset to restart transmission.

3 Get started

Always follow the instructions in this chapter in sequence.

Install battery



Caution

- Risk of explosion! Keep batteries away from heat, sunshine or fire. Never discard batteries in fire.
- Danger of explosion if battery is incorrectly replaced. Replace only with the same or equivalent type.
- The battery contains chemical substances, so it should be disposed of properly.
- Keep children away from the battery.

Insert batteries into the sensor ©



Note

- Do not mix batteries (old and new or carbon and alkaline, etc.).

Before using the sensor,

- 1 turn the screw anticlockwise to unlock the battery compartment.
- 2 insert 2 AA batteries (not supplied) with correct polarity (+/-) as indicated.
- 3 turn the screw clockwise to lock the battery compartment.

Replace battery of the main unit (D)



Note

- You can only use AC power as power supply. The pre-installed CR2032 battery can only back up clock and alarm settings.

When the low battery icon is displayed, replace the battery as indicated.

Connect power (E)



Caution

- Risk of product damage! Ensure that the power voltage corresponds to the voltage printed on the back or underside of the clock radio.
- Risk of electric shock! When you unplug the AC adapter, always pull the plug from the socket. Never pull the cord.



Warning

- To reduce the risk of fire or electric shock, do not expose this clock radio to rain or moisture.

Plug and set

Time has been preset at the factory. When power is connected, the set time is displayed automatically.

The built-in lithium battery can maintain clock setting despite power interruption.

Select time zone

You can adjust time zone setting according to your location.

- 1** In standby mode, press **TIME ZONE**.
↳ The current time zone number blinks on the display.
- 2** Rotate the main knob to set time zone (-1 to +12 adjustable).
- 3** Press the knob to confirm.

For Europe:

Western European Time (WET)	+0
Central European Time (CET)	+1 (Default)
Eastern European Time (EET)	+2
Moscow Standard Time (MST)	+3

Set clock

If the preset time is inaccurate, you can set time and date manually.

- 1** In standby mode, press **SET TIME** to activate clock setting mode.
↳ The hour digits begin to blink.
- 2** Rotate the main knob to adjust hour.
- 3** Press the knob to confirm.
↳ The minute digits begin to blink.
- 4** Repeat steps 2-3 to set the minute, 12/24 hour format, year, month, day, and month-day display mode in sequence.



Tip

- In time and date setting mode, if you press and hold the knob for 3 seconds, the clock radio will save the change and quit the setting mode.

4 Listen to FM/MW radio

Tune to radio stations



Tip

- Position the antenna as far as possible from TV, VCR, or other radiation source.
- For better reception, fully extend and adjust the position of the antenna.

- 1 Press **FM/MW** to select FM or MW tuner source.
- 2 Press **TUNING MODE** repeatedly until **[FIND]** (find) blinks.
- 3 Rotate the main knob slowly.
↳ The clock radio tunes to a station with strong reception automatically.
- 4 Press the knob to confirm.
- 5 Repeat steps 2-4 to tune to more radio stations.

To tune to a station manually:

- 1 In tuner mode, press **TUNING MODE** repeatedly until **[STEP]**

- 2 Rotate the knob slowly to select a frequency.

Store radio stations automatically

You can store a maximum of 20 FM radio stations and 10 MW radio stations.

- 1 In tuner mode, press **TUNING MODE** repeatedly until **[AUTO]** (auto) blinks.
- 2 Rotate the main knob slowly.
 - ↳ The clock radio stores all the available FM/MW radio stations and broadcasts the first available station automatically.

Store radio stations manually

- 1 Tune to a radio station.
- 2 Press **PROG**.
 - ↳ The preset number begins to blink.
- 3 Rotate the main knob to select a number.
- 4 Press the knob to confirm.
 - ↳ **[DONE]** (done) is displayed.
- 5 Repeat steps 1 to 4 to store other stations.



Note

- To remove a pre-stored station, store another station in its place.

Select a preset radio station

In tuner mode, press **PRESET**, then rotate the main knob to select a preset number.

Adjust volume (F)

5 Other features

Display indoor/outdoor temperature

Adjust temperature display

- 1 Press **DISPLAY**.
- 2 Rotate the knob to select a temperature display mode for the main unit:
 - Display indoor temperature;
 - Display outdoor temperature detected from channel 1/2/3; or
 - Display indoor and outdoor temperature alternatively.
- 3 Press the knob to confirm.



Tip

- To convert between Centigrade (°C) and Fahrenheit (°F) temperature display, adjust °C/°F slide inside the battery compartment of the sensor.
- If the main unit fails to receive signal from the sensor, only indoor temperature can be displayed.

Improve sensor reception

When battery is correctly installed in the sensor; the sensor starts to transmit RF signal to the main unit through Channel 1/2/3.

To improve the sensor reception,

- adjust the **CHANNEL** control inside the battery compartment of the sensor.
- reduce the distance between the main unit and the sensor.
- press **RESET** on the sensor to restart transmission, in case of sudden error or abnormal state.

To change to Channel **2** or **3** to transmit RF signal,

- 1** Press **DISPLAY**.
- 2** Rotate the knob until the corresponding icon appears.
- 3** Press the knob to confirm.
- 4** Switch the **CHANNEL** control to **2** or **3**.
 - ↳ The main unit and sensor begin to detect signal from Channel **2** or **3** and then display the outdoor temperature.

Enjoy nature sound

This clock radio provides realistic nature sounds of rooster, forest, sea,

- 1 Press **NATURE SOUND**.
- 2 Rotate the knob to select a nature sound.
- 3 Press the knob to confirm.
- 4 Rotate the knob to adjust the volume level of the nature sound (0-8).



Tip

- To deactivate the nature sound, press the knob again.

Set alarm timer

Set alarm

You can set two alarms to ring at different time.



Note

- Make sure that the clock is set correctly.

- 1 In standby mode, press and hold **AL1/AL2** for two seconds to activate alarm setting mode.
 - ↳ The hour digits and **[AL1]/[AL2]** begin to blink.
- 2 Rotate the main knob to adjust hour.
- 3 Press the main knob to confirm.
 - ↳ The minute digits and **[AL1]/[AL2]** begin to blink.

4 Repeat Step 2, 3 to set minute.

- 5 Repeat Step 2-3 to select whether to ring alarm for the whole week, on weekdays (Monday to Friday), or on the weekend (Saturday and Sunday).
 - 6 Repeat steps 2-3 to select an alarm source: radio, buzzer, or a nature sound.
 - 7 Repeat steps 2-3 to set the alarm volume.
-

Activate/deactivate alarm timer

- 1 Press **AL1/AL2** to view alarm settings.
 - 2 Press **AL1/AL2** again to activate or deactivate the alarm timer.
 - ↳ **[AL1]/[AL2]** appears if alarm timer is on and disappears if it is off.
 - To stop the ringing alarm, press the corresponding **AL1/AL2**.
 - The alarm repeats ringing for the next day.
-

Snooze alarm

When alarm sounds, press **SNOOZE**.

- ↳ The alarm snoozes and repeats ringing nine minutes later.
-

Set sleep timer

This clock radio can switch to standby mode automatically after a preset period.

- 1 Press **SLEEP**.
- 2 Rotate the main knob to select the sleep timer period (in minutes).
- 3 Press the knob to confirm.
 - ↳ When the sleep timer is activated, **2** appears.

To deactivate the sleep timer:

In sleep timer setting mode, rotate the knob until **[OFF]** (off) appears, then press the knob.

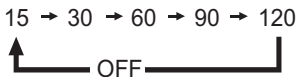

Select DST (daylight saving time) mode

For countries with daylight saving time (DST), the clock radio offers you DST option to adjust summer time.

In standby mode, press and hold **DST** for 3 seconds.

↳ The clock advances by one hour and **[DST]** is displayed.

Adjust display brightness

Press **BRIGHTNESS** repeatedly to select different brightness levels: **[HI]** (high), **[MID]** (mid), and **[LOW]** (low).

6 Product information



Note

- Product information is subject to change without prior notice.

Specifications

Amplifier

Rated Output Power	0.6 W RMS
--------------------	-----------

Tuner

Tuning Range	FM: 87.5 - 108 MHz MW: 531-1602 KHz
--------------	--

Sensitivity - Mono, 26dB S/N Ratio	FM: <22 dBu MW: <92 dBuV/M
---------------------------------------	-------------------------------

Search Selectivity	FM: <28 dBf MW:<98 dBuV/M
--------------------	------------------------------

Total Harmonic Distortion	FM: <3% MW:<5%
---------------------------	-------------------

Signal to Noise Ratio	FM: >45 dB MW:>40 dB
-----------------------	-------------------------

General information

AC Power	Model : AGC060V0450T; Input : 220-240V ~, 50/60Hz; Output : AC6V 450MA
----------	--

Operation Power Consumption	<5 W
--------------------------------	------

Standby Power Consumption	<2 W
---------------------------	------

Dimensions

- Main Unit (W x H x D)	197 x 80 x 45 mm
-------------------------	------------------

Weight

- With Packing	0.9 kg
- Main Unit	0.5 kg

7 Troubleshooting



Warning

- Never remove the casing of this apparatus.

To keep the warranty valid, never try to repair the system yourself. If you encounter problems when using this apparatus, check the following points before requesting service. If the problem remains unsolved, go to the Philips web site (www.philips.com/support). When you contact Philips, ensure that the apparatus is nearby and the model number and serial number are available.

No power

- Ensure that the AC power plug of the clock radio is connected properly.
- Ensure that there is power at the AC outlet.

No response from the clock radio

- Disconnect and reconnect the AC power plug, then turn on the clock radio again.

Poor radio reception

- Keep the clock radio away from other electronic devices to avoid radio interference.

No signal detected from the sensor

- Check if the battery is correctly installed in the sensor.
- Reduce the distance between the main unit and the sensor.
- Press **RESET** on the sensor to restart transmission.
- Change to another channel to transmit signal.

8 Notice



This product complies with the radio interference requirements of the European Community.

Any changes or modifications made to this device that are not expressly approved by Philips Consumer Lifestyle may void the user's authority to operate the equipment.



Your product is designed and manufactured with high quality materials and components, which can be recycled and reused.



When this crossed-out wheeled bin symbol is attached to a product it means that the product is covered by the European Directive 2002/96/EC.

Please inform yourself about the local separate collection system for electrical and electronic products.

Download from www.Somanuals.com. All Manuals Search And Download

Please act according to your local rules and do not dispose of your old products with your normal household waste. Correct disposal of your old product helps to prevent potential negative consequences for the environment and human health.



Your product contains batteries covered by the European Directive 2006/66/EC, which cannot be disposed with normal household waste. Please inform yourself about the local rules on separate collection of batteries because correct disposal helps to prevent negative consequences for the environmental and human health.

Environmental information

All unnecessary packaging has been omitted. We have tried to make the packaging easy to separate into three materials: cardboard (box), polystyrene foam (buffer) and polyethylene (bags, protective foam sheet.)

Your system consists of materials which can be recycled and reused if disassembled by a specialized company. Please observe the local regulations regarding the disposal of packaging materials, exhausted batteries and old equipment.



Note

- The type plate is located on the bottom of the apparatus.

2012 © Koninklijke Philips Electronics N.V. All rights reserved.

Specifications are subject to change without notice. Trademarks are the property of Koninklijke Philips Electronics N.V. or their respective owners. Philips reserves the right to change products at any time

Norge

Typeskilt finnes på apparatens underside.

Observer: Nettbryteren er sekundert innkoplet. Den innebygde nettdelen er derfor ikke frakoplet nettet så lenge apparatet er tilsluttet nettkontakten.

For å redusere faren for brann eller elektrisk støt, skal apparatet ikke utsettes for regn eller fuktighet.



© 2012 Koninklijke Philips Electronics N.V.

All rights reserved.



Free Manuals Download Website

<http://myh66.com>

<http://usermanuals.us>

<http://www.somanuals.com>

<http://www.4manuals.cc>

<http://www.manual-lib.com>

<http://www.404manual.com>

<http://www.luxmanual.com>

<http://aubethermostatmanual.com>

Golf course search by state

<http://golfingnear.com>

Email search by domain

<http://emailbydomain.com>

Auto manuals search

<http://auto.somanuals.com>

TV manuals search

<http://tv.somanuals.com>