

MCL1801 FAMILY

LCD 18" COLOR MONITOR

User's Manual

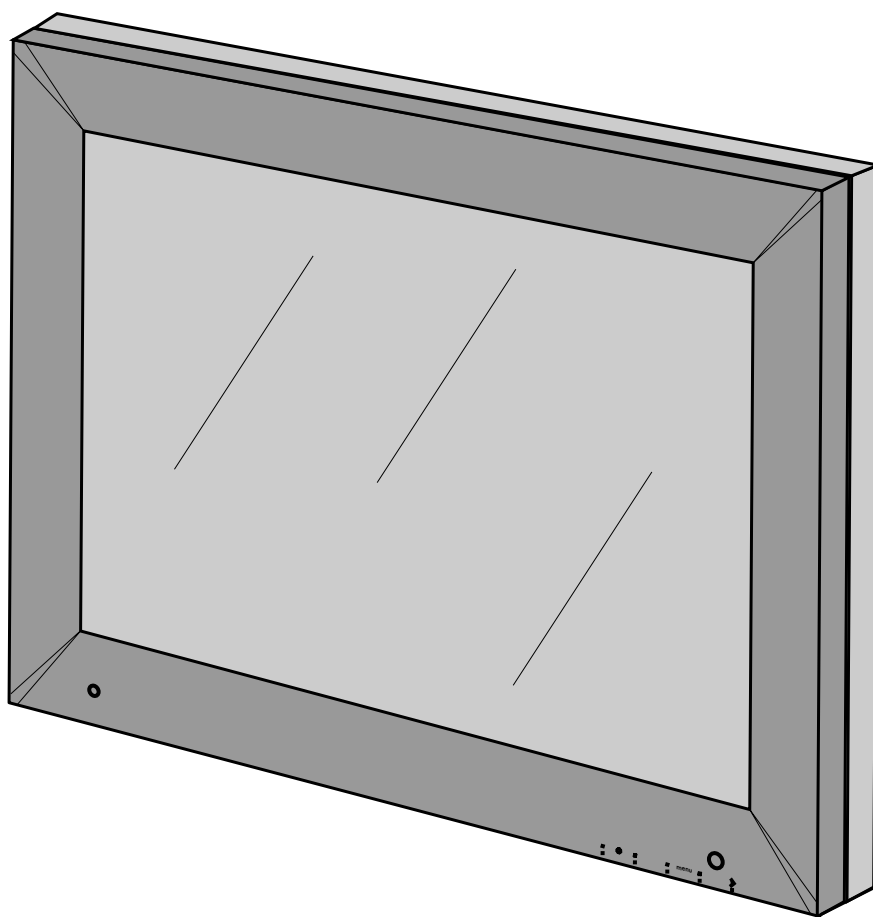

Copyright © 2002 FIMI S.r.l. Saronno - Italy

All rights are reserved. Reproduction in whole or in part is prohibited without the written consent of the copyright owner

Printed in Italy

(Rev. 1.1)

Copyright ©

This manual is copyrighted with all rights reserved. Under the copy rights law, this manual may not be copied, in whole or part, without written consent of Philips. Under the law, copying includes translating into another language or format.

The monitor described in this manual, has been certified/registered by the safety agencies/regulatory authorities as model n° :

FCC Notice

This equipment has been tested and found to comply with the limits for a class A digital device, pursuant to Part 15 of FCC Rules. These limits are designed to provide reasonable protection against harmful interference when the equipment is operated in a commercial environment.

This equipment generates, uses and can radiate radio frequency energy and , if not installed and used in accordance to radio communications.

Operation of this equipment in a residential area is likely to cause harmful interference in which case the user will be required to correct the interference at his own expense.

This monitor complies with the European community radio interference standard EN 55011 Class B.

Modification

The FCC requires the user to be notified that any changes or modifications made to this device that are not expressly approved by the manufacturer may void the user's authority to operate the equipment.

Cables

Connections to this device must be made with shielded signals cables with metallic RFI/EMI connector hoods to maintain compliance with FCC Rules and Regulations.

 The lightning flash with arrowhead symbol is intended to alert the user of the presence of uninsulated "dangerous voltage" within the product's enclosure that may be sufficient magnitude to constitute a risk of electrical shock to people.

 The exclamation mark is intended to alert the user of the presence of important operating and maintenance (servicing) instructions in literature accompanying the appliance.

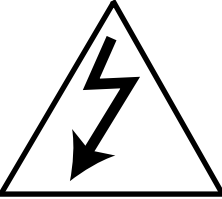
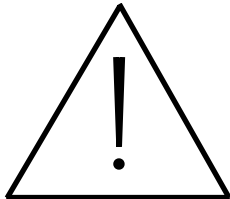
	<p>CAUTION RISK OF ELECTRICAL SHOCK DO NOT OPEN ATTENTION RISQUE DE CHOC ELECTRIQUE NE PAS OUVRIR</p>	
<p>CAUTION: TO REDUCE THE RISK OF ELECTRICAL SHOCK. DO NOT REMOVE COVER (OR BACK) NO USER SERVICEABLE PARTS INSIDE REFER SERVICING TO QUALIFIED SERVICE PERSONNEL</p>		

WARNING:

TO PREVENT DAMAGE WHICH MAY RESULT IN FIRE OR SHOCK HAZARD, DO NOT EXPOSE THIS APPLIANCE TO RAIN OR EXCESSIVE MOISTURE.

THE ENCLOSURE HAS TO BE CHECKED UPON COLLISION DAMAGE; REFER TO QUALIFIED SERVICE PERSONNEL

INTRODUCTION

The FIMI Medical Grade MCL1801 Medical is a color active matrix, liquid crystal display exclusively designed for medical applications.

The monitor can be used for general medical viewing requiring high level color image quality, as well as in the Control Stations of Patient Monitoring, with a resolution of 1280 x 1024, and can accept an analogue signal input as well as a digital input.

The product is engineered to meet all stringent medical safety requirements, including UL2601.1, CAN/CSA C22.2 No.601.1, EN-60601.1 and the product can be safely placed next to other sensitive equipment with no risk of harmful interference.

Certifications of monitor also cover requirements for liquid ingress and current-leakage from power supply.

The other key features of the MCL1801 are:

- long term luminance stability through an optional backlight stabilization circuit
- luminance stability vs the viewing angle
- contrast stability vs the viewing angle
- brightness uniformity
- automatic brightness control with backlight sensor and ambient light sensor
- internal automatic greyscale calibration (10 bit L.U.T.)

The tilt swivel base can be removed and the monitor uses a mounting plate that conforms to the VESA mounting standard, that allows flexible mounting options, including wall mounting and rolling stands.

User controls are available through On-Screen Display.

CONTENTS

TECHNICAL INFORMATION.....	5
DIMENSIONS.....	6
INSTALLATION.....	8
MOUNTING INSTRUCTION.....	8
CONNECTING INSTRUCTION.....	9
connecting AC power.....	10
connecting analog video.....	11
connecting digital video.....	11
connecting the optional touchscreen.....	12
INPUT INSTRUCTION.....	13
CONTROL PANEL DESCRIPTION.....	14
(OSD) ON SCREEN DISPLAY.....	15
menu structure.....	15
OSD key functions.....	16
OSD controls.....	16
main menu.....	16
information.....	17
image adjust.....	17
horizontal position.....	18
vertical position.....	18
scale / center.....	18
image Enhancement.....	18
ABC selection.....	18
transfer function.....	19
advanced.....	19
phase adjust.....	20
clock adjust.....	20
service.....	21
auto-setup options.....	21
auto-setup on modest.....	21
auto-clock feature.....	22
auto-(Phase/Position).....	22
auto-(Clock/Position).....	22
auto-level	22
restore factory preset.....	23
language.....	23
OSD setting.....	23
OSD position.....	24
(OSD) vertical position.....	24
OSD size.....	25
OSD transparency.....	25
OSD timeout.....	25
video source.....	25
keyboard option.....	26

TECHNICAL INFORMATION

Display Panel	18.1" (460mm) SXGA active matrix monochrome TFT/LCD
Supported Grayscale	8-bit
Dimensions	Panel 410 x 362 x 105 mm. (width x height x depth.)
Weight	7,7 Kg (panel), 3,7 Kg (pedestal)
Active display area	359,0 x 287,2 mm (width x height)
Response Time	40 mS (10% to 90% rising + 90% to 10% falling)
Viewing Angle	± 85° typ. horizontal or vertical (contrast ratio ≥ 15)
Contrast Ratio	400 : 1 typ.
White luminance	200 cd/m ²
Pixel Pitch	0,2805 (one triad) x 0,2805 mm (width x height)
Video interface	Analog Input: DSUB-15 connection for Separate Sync Video Signal or SOG Video Signal. Digital Input: DVI-D connection for TMDS signal link standard version.
Scanning Frequency	Max pixel clock 135MHz
Power Consumption	≤ 70 W
Power Supply	From 90 to 264 Vac , 50 -60 Hz
Operation Temperature	+10 to +45 °C
Storage Temperature	-20 to +60 °C
Humidity	80% (Maximum Wet-Bulb should be 39 °C and No condensation)
Shock	Half sine wave: 50G 11msec. ;X+/-, Y+/-, Z+/- (total 6 Directions), Each two time shock.

DIMENSIONS

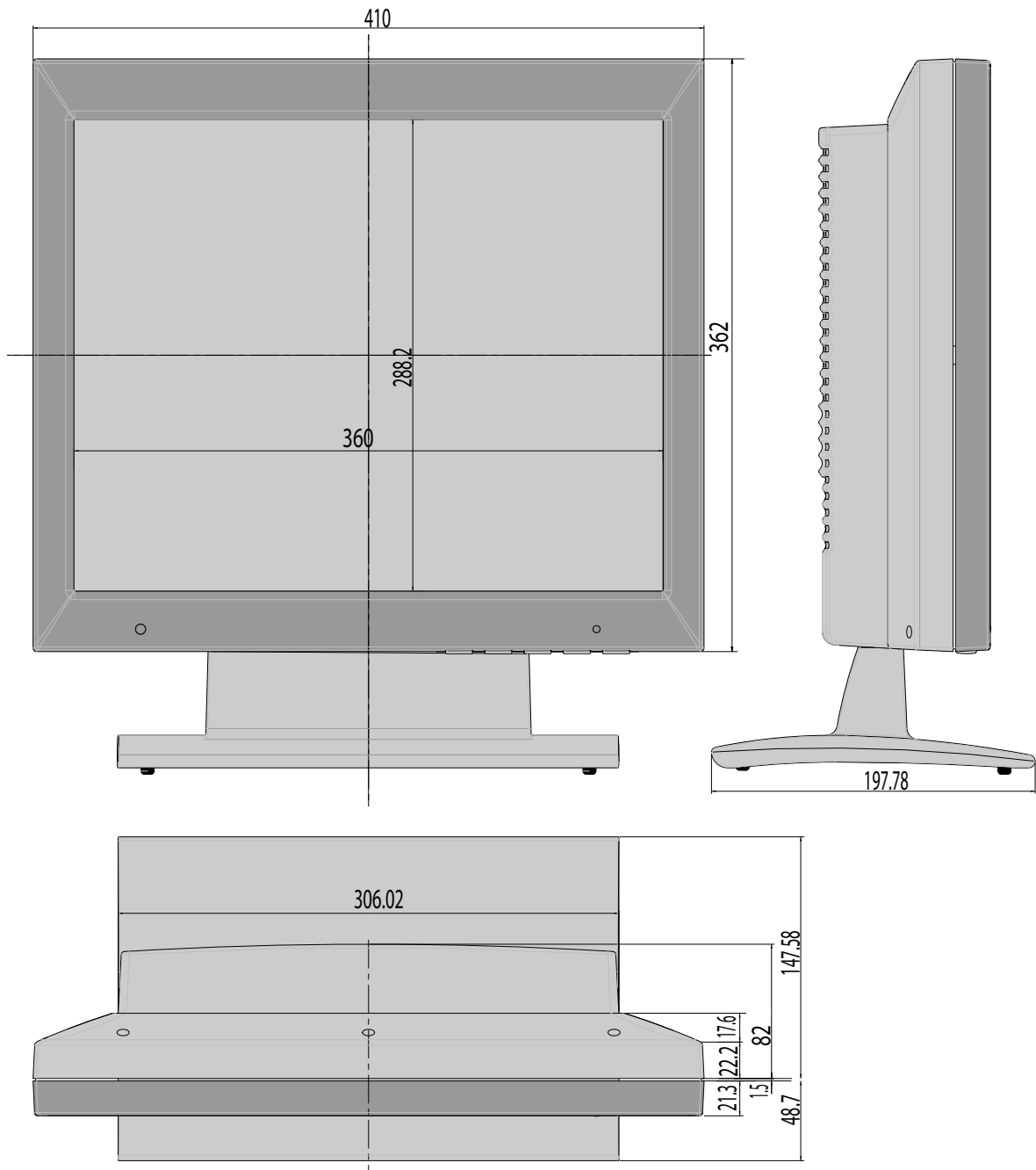

DIMENSIONS

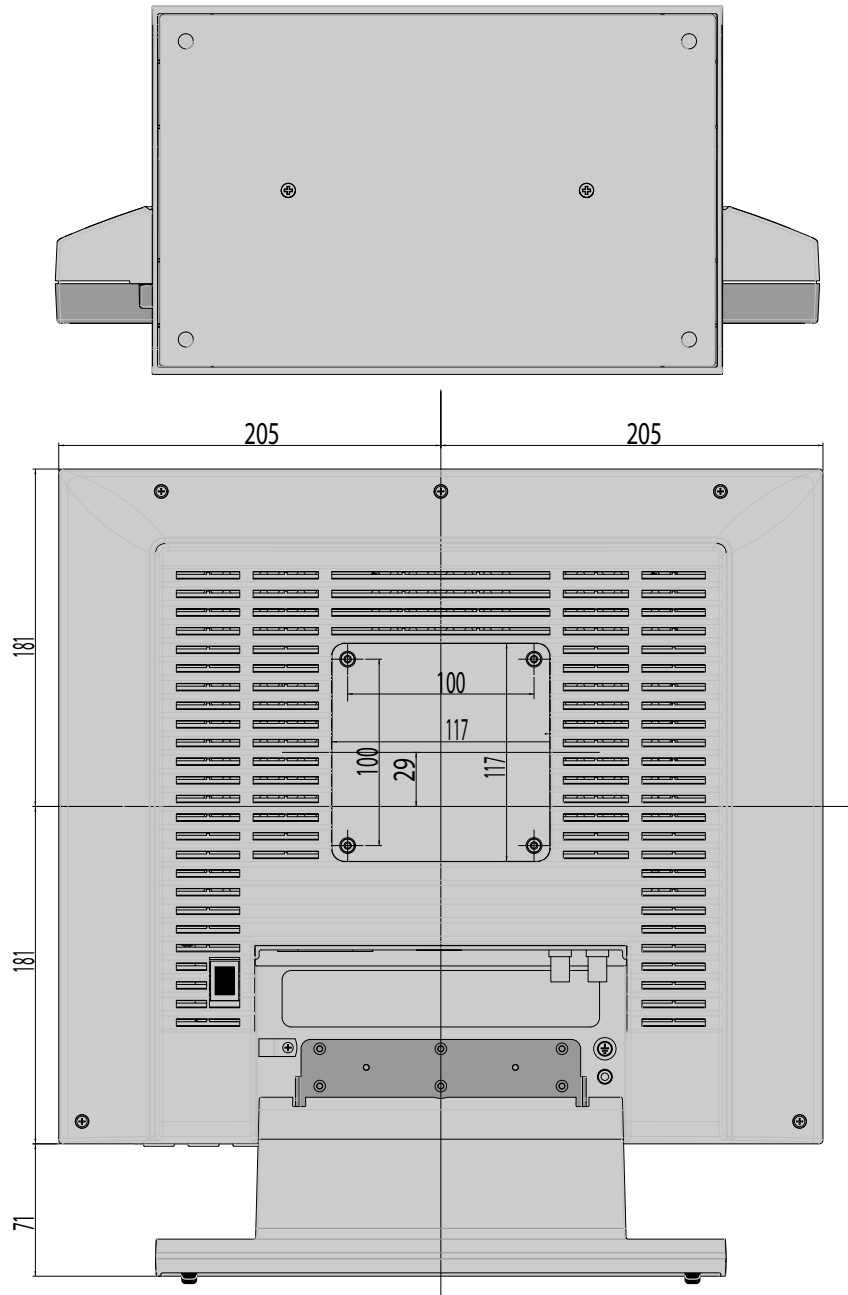

INSTALLATION

Before unpacking the monitor, prepare a suitable workspace. You need a stable and level surface near a grounded wall outlet in an area that is relatively free of glare from sunlight or other sources of bright light. The monitor is cooled by two internal fans. For best performance, do not block the cooling vents.

NOTE: before installing this monitor, please refer to the user's guides of your computer and video adapter to make sure if these equipments require any change of setting.

Positioning

WARNING:

WHEN POSITIONING THIS EQUIPMENT, ENSURE THAT THE MAINS PLUG AND SOCKET ARE EASILY ACCESSIBLE

While unpacking the monitor, inspect it and other package contents for shipping damage that could cause a fire or shock hazard. immediately report any shipping damage to the carrier or transportation company, and contact customer service for assistance. keep all packing material in case you need to ship, store or return the monitor.

After unpacking the monitor, make sure the following items are included:

- Monitor
- Mains cord set 1,8-meter (USA version)
- Mains cord set 1,8-meter (EU version)
- Signal cable 1,8-meter (DB15 / DB15)
- This user's manual

If you ordered the monitor with the resistive touchscreen option, the following items should also be included:

- User's manual of touchscreen
- Touchscreen cable

PEDESTAL (standard)

With the built-in pedestal you can tilt the monitor for a most comfortable viewing angle as shown in figure 8a.

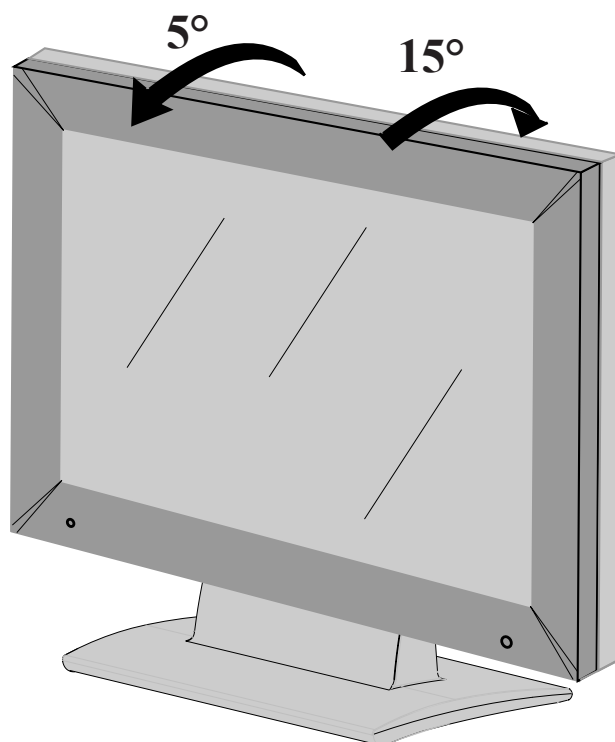

fig. 8a

MOUNTING INSTRUCTION

PEDESTAL STANDARD (OPTIONAL)

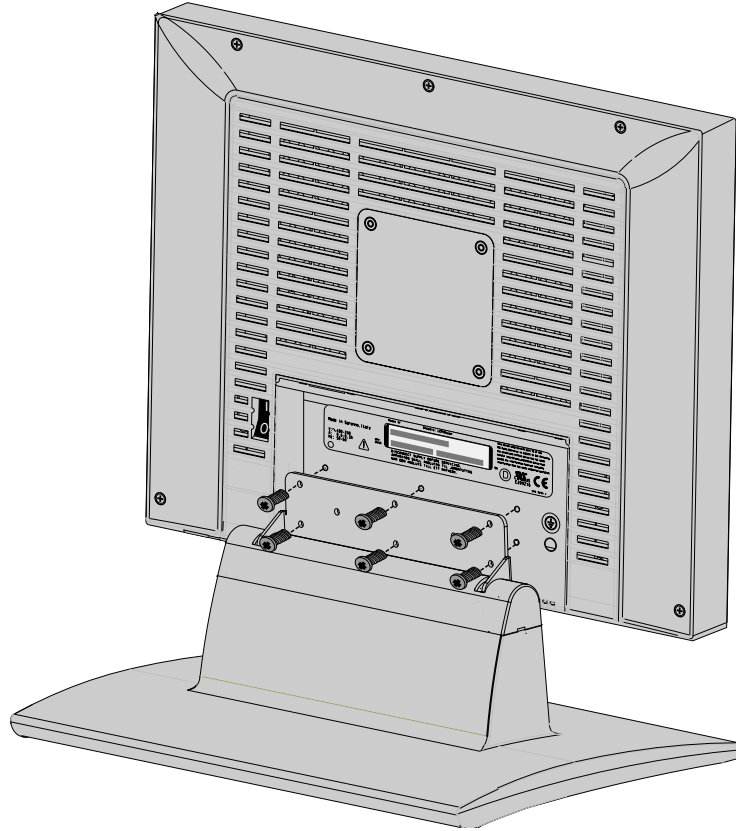

fig. 9a

The pedestal must be fixed at monitor with N° 6 screws M3x10 (included into the BOX) as shown in figure 9a.

ARM VESA PLATE

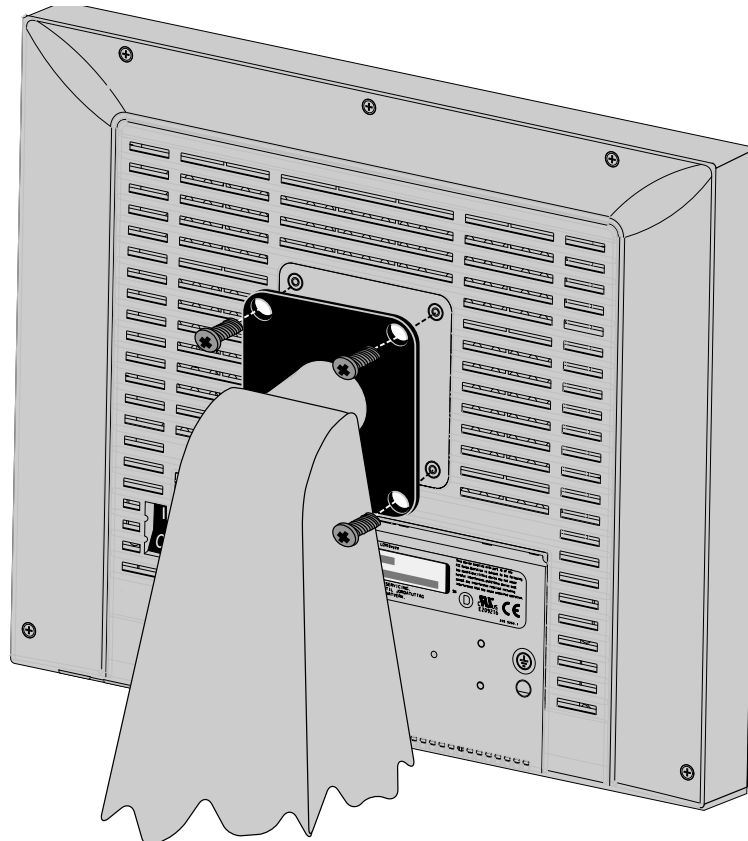

fig. 9b

An arm with VESA (100x100) interface must be fixed at monitor with N° 4 screws M4x10 as shown in figure 9b.

CONNECTING INSTRUCTION

CONNECTING AC POWER

Plug the receptacle end of the cord set into the AC power adapter, then plug the power connector of the adapter into the power port on the monitor.

This power port is located on the back of the monitor (see fig. 10a).

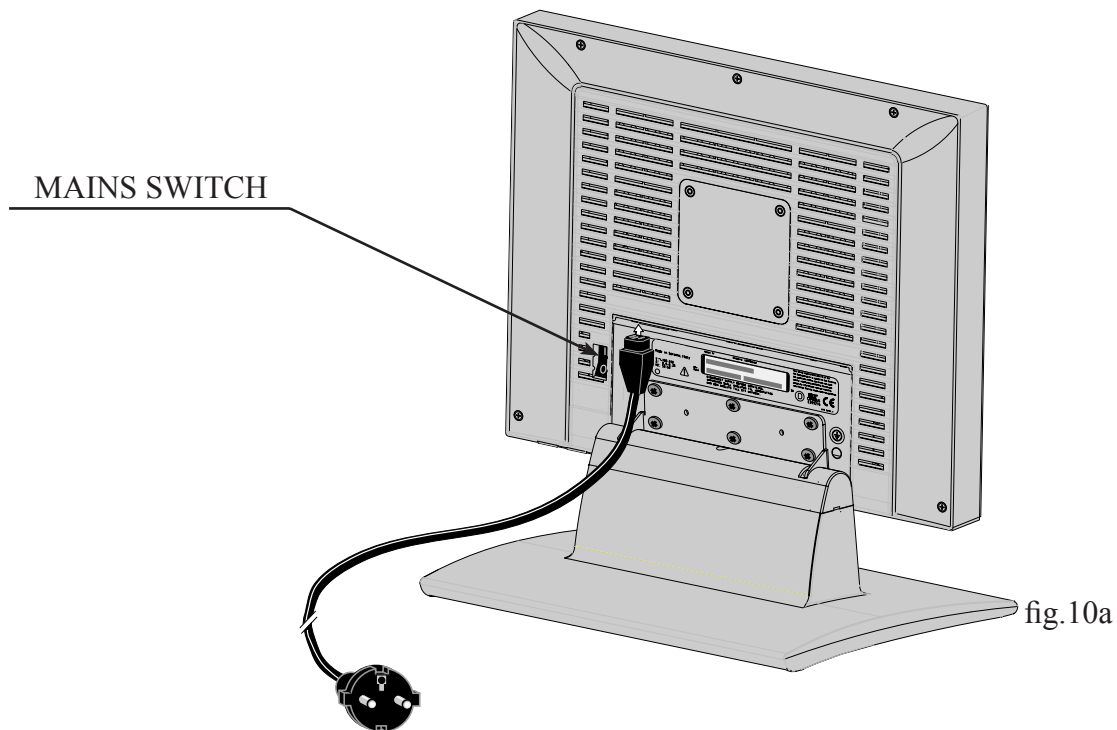

The power cord set can be fixed to cabinet with proper cable clamp and screw (see fig. 10b)

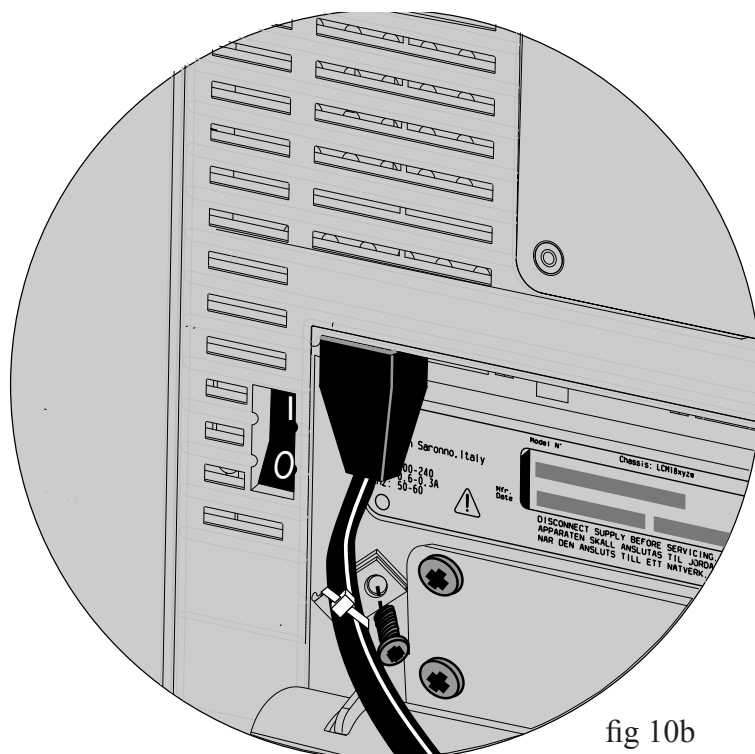

Insert the plug end of the power cord into a grounded wall outlet. For added protection, use a surge protector between the AC adapter and the electrical wall outlet to prevent sudden current variations from reaching the monitor

CONNECTING ANALOG VIDEO (SXGA)

With the power the computer and the monitor turned off, connect the supplied video cable from the monitor to the computer's video port (see fig. 11a)

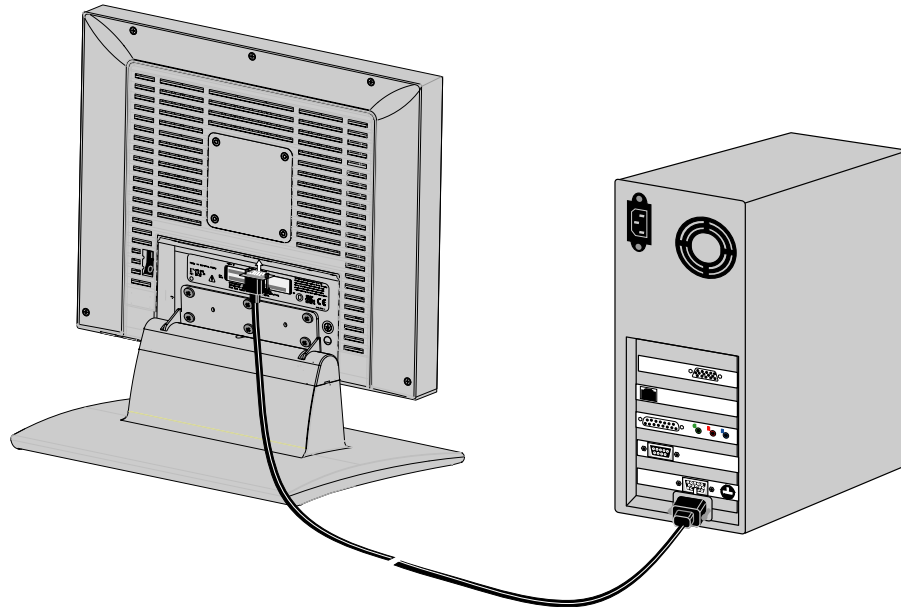

fig. 11a

Make sure the video cable connector is securely connected to the video port on your computer. Turn the monitor on first, and then turn on the computer.

CONNECTING DIGITAL VIDEO (DVI)

With the power the computer and the monitor turned off, connect the supplied video cable from the monitor to the computer's video port (see fig. 11b)

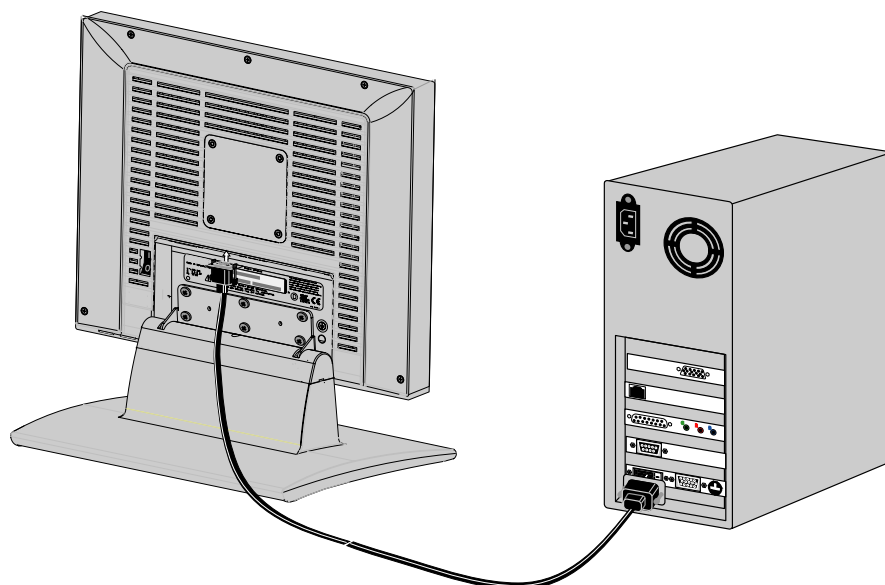

fig. 11b

CONNECTING TOUCHSCREEN (OPTIONAL)

If your monitor has this optional feature, connect the monitor's RJ11-4 serial port to the computer's 9-pin RS-232 serial port using the proper cable (see fig. 12a)

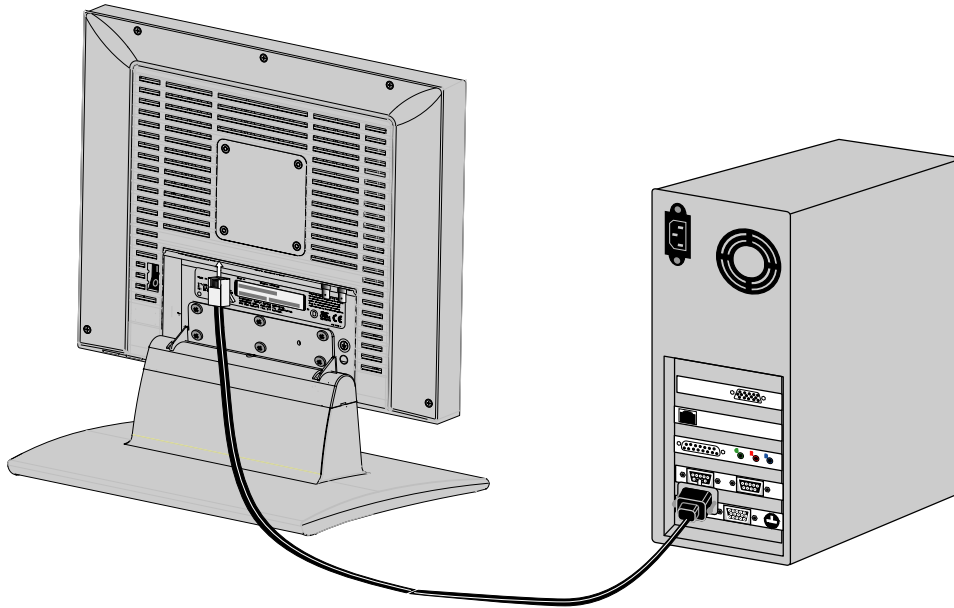

fig. 12a

NOTE: *Follow the instructions included on the enclosed CD for installing the Touchscreen drivers on your system. Following driver software installation, calibrate your Touchscreen to the system following the procedure described on the enclosed CD.*

INPUT INSTRUCTION

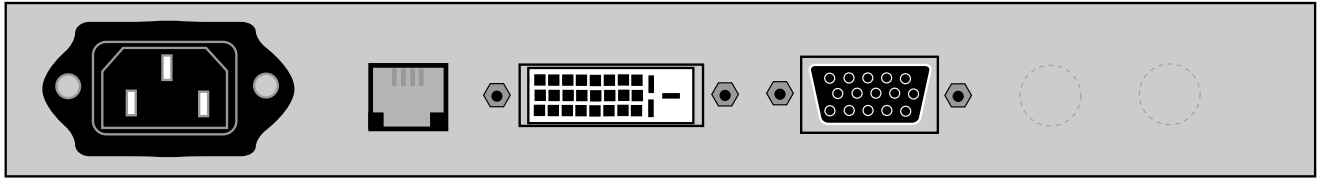

fig.13a

↑
 AC INLET
 MAINS SOCKET

↑
 RS232
 or
 TOUCHSCREEN

↑
 DVI-INPUT

↑
 VIDEO-INPUT
 XVGA

AC INLET (Meet IEC 320/CEE 22 STANDARD)
110/220Vdc

RS232 / TOUCHSCREEN Connector (RJ11-4)

- Pin 1 : RS232 Rx
- Pin 2 : RS232 Tx
- Pin 3 : ENABLE (Only with touch screen)
- Pin 4 : GND

Note: When the option touchscreen is used, the RS232 monitor control is not available.

DVI INPUT Connector (Microcross™ DVI-D female connector)

- | | |
|------------------------------|------------------------------|
| Pin 1 : D2_RX - (T.M.D.S.) | Pin 13 : N.C. |
| Pin 2 : D2_RX + (T.M.D.S.) | Pin 14 : +5V Power |
| Pin 3 : GND (Data 2 shield) | Pin 15 : GND |
| Pin 4 : N.C. | Pin 16 : Hot Plug Detect |
| Pin 5 : N.C. | Pin 17 : D0_RX - (T.M.D.S.) |
| Pin 6 : SCL (For DDC) | Pin 18 : D0_RX + (T.M.D.S.) |
| Pin 7 : SDA (For DDC) | Pin 19 : GND (Data 0 shield) |
| Pin 8 : N.C. | Pin 20 : N.C. |
| Pin 9 : D1_RX - (T.M.D.S.) | Pin 21 : N.C. |
| Pin 10 : D1_RX + (T.M.D.S.) | Pin 22 : GND (Clock shield) |
| Pin 11 : GND (Data 1 shield) | Pin 23 : CK_RX + (T.M.D.S.) |
| Pin 12 : N.C. | Pin 24 : CK_RX - (T.M.D.S.) |

VIDEO INPUT XVGA Connection (DSUB15 female connector)

- | | |
|--------------|-------------------------------|
| Pin 1 : R-in | Pin 9 : N.C. |
| Pin 2 : G-in | Pin 10 : GND |
| Pin 3 : B-in | Pin 11 : N.C. |
| Pin 4 : N.C. | Pin 12 : SDA (For DDC option) |
| Pin 5 : N.C. | Pin 13 : H.S.-in |
| Pin 6 : GND | Pin 14 : V.S.-in |
| Pin 7 : GND | Pin 15 : SCL (For DDC option) |
| Pin 8 : GND | |

CONTROL PANEL DESCRIPTION

On the front **bottom side** part of the unit the following controls are placed:

- BRIGHTNESS ADJ-
- BRIGHTNESS ADJ+
- MENU SELECT - / BRIGHTNESS Recall to 200 Cd/m²
- MENU SELECT +
- ENTER (Store/Source-Select)

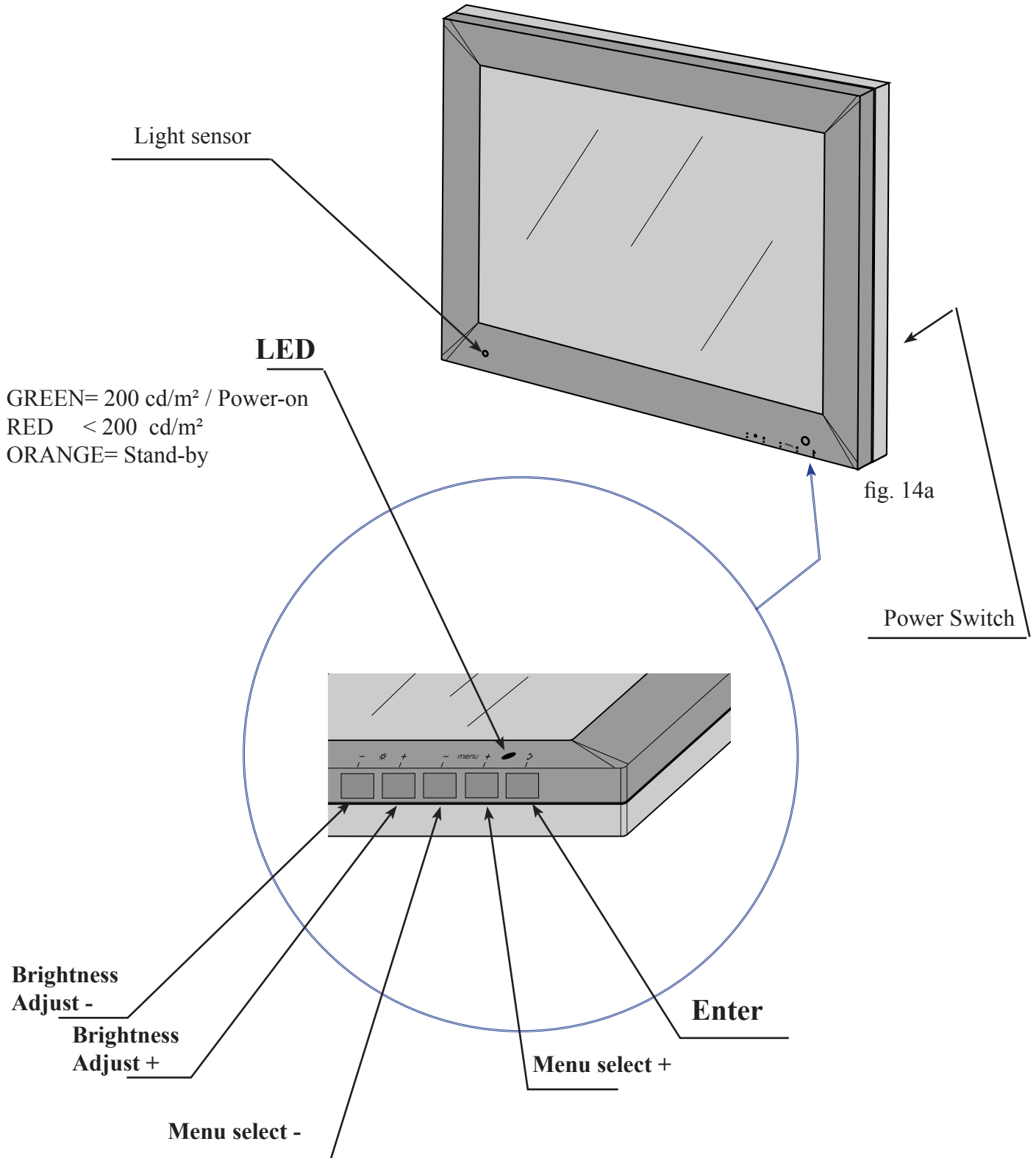

(OSD) ON SCREEN DISPLAY

MENU STRUCTURE

MAIN MENU

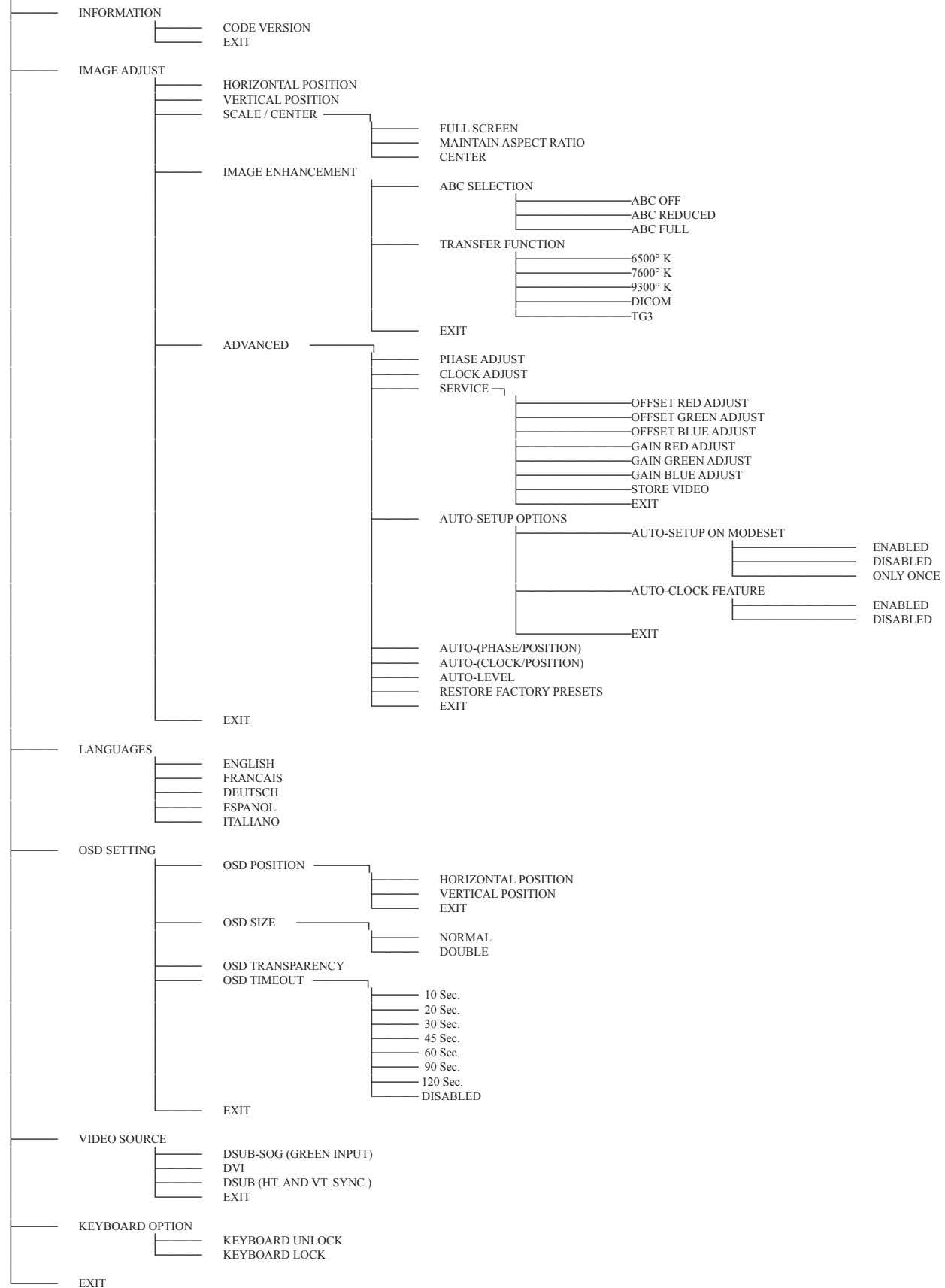

OSD KEY FUNCTIONS

Function	Key	Description
Enter	↵	It activates the OSD MAIN MENU if this is not active, otherwise selects and executes a desired OSD Special Function.
Adjust -	Menu -	When main menu or sub-menu is active, it allows to move or scroll to the previous (upper) item or decrement the magnitude of the parameter.
Adjust +	Menu +	When main menu or sub-menu is active, it allows to move or scroll to the previous (down) item or increment the magnitude of the parameter.

Pressing “Enter” key the MAIN MENU highlight selection is the first Sub-menu item “Video Information”

Pressing “Menu +” or “Menu -” key, the highlight selection of menu item moves downward/ upward

Pressing “Enter” key, the current menu window disappears and is replaced by the new sub-menu windows.

6.0.0 OSD (ON SCREEN DISPLAY) CONTROLS

6.1.0 Main manu

After the activation of OSD Main Menu appears the following window

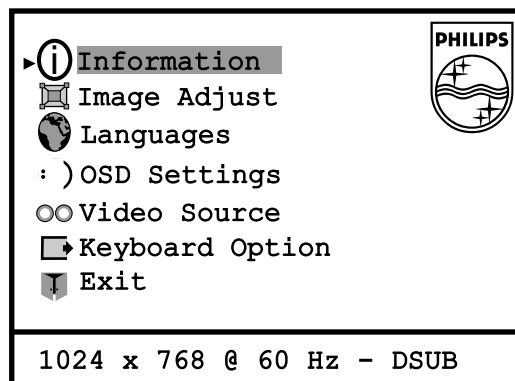

	Information	It shows the hardware and firmware status (operating hours and release number)
	Image Adjust	To adjust the picture when it is not correct
	Languages	To select the correct language
	OSD Settings	To adjust the OSD options (position, attribute activity delay)
	Video Source	To select the correct video input source
	Keyboard Option	To select the keyboard status.
	Exit	To exit from “MAIN MENU” .

6.2.0 Information

- 1) Press **Enter** button when the **Information** is highlighted on **Main menu**.
The **Information** window appears.
MCL1801 Model
Ver CO.62-DO.62 Firmware Release
h00002 Operating Hours
c1B Video timing number
- 3) To press **Enter** button to return to **Main Menu**.

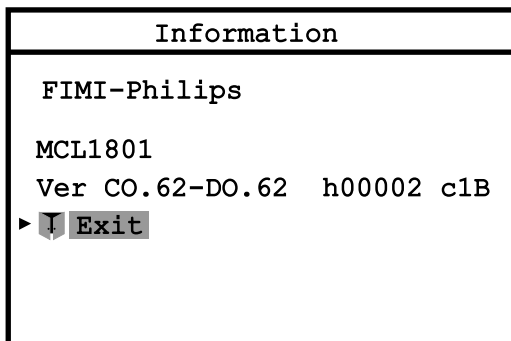

6.3.0 Image Adjust

- 1) Press **Enter** button when the **Image Adjust** is highlighted on **Main Menu**.
The **Image Adjust** window appears.

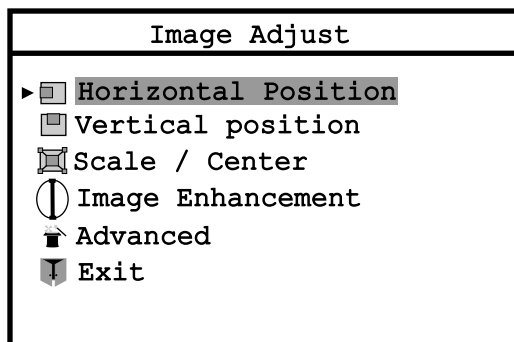

6.3.1 Horizontal Position

- 1) Press **Enter** button when the **Horizontal Position** is highlighted on **Image Adjust**.
The **Horizontal Position** bar appears.

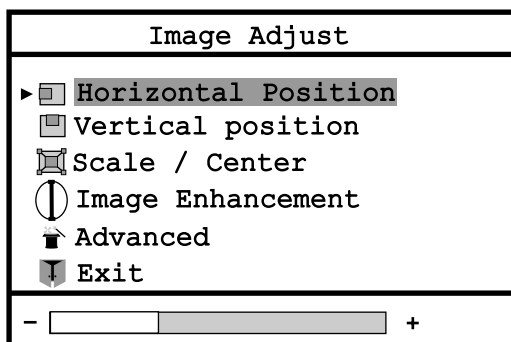

- 2) Press **Adjust +** or **Adjust -** button to move the image to the left or right
- 3) When the position is adjusted, press the **Enter** button to return to **Image Adjust** window
- 4) To select **Exit** and press again **Enter** button to return to **Main Menu** or select **Vertical Position**.

6.3.2 Vertical Position

1) Press **Enter** button when the **Vertical Position** is highlighted on **Image Adjust**.
The **Vertical Position** bar appears.

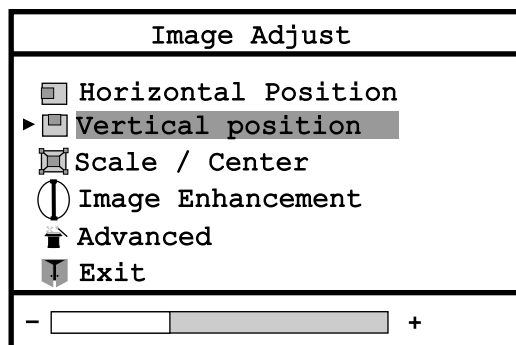

- 2) Press **Adjust +** or **Adjust -** button to move the image to the up or down
- 3) When the position is adjusted, press the **Enter** button to return to **Image Adjust** window
- 4) To select **Exit** and press again **Enter** button to return to **Main Menu** or select **Scale / Center**

6.3.3 Scale / Center

1) Press **Enter** button when the **Scale / Center** is highlighted on **Image Adjust**.
The **Scale / Center** window appears.

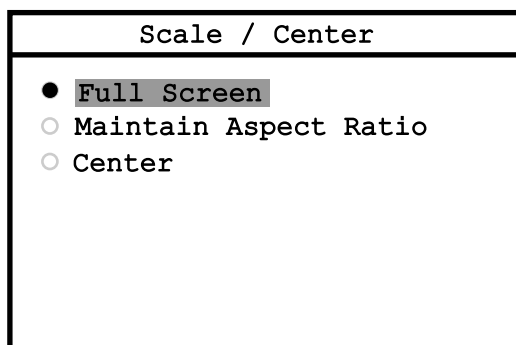

The **ON SCREEN DISPLAY** shows the three modes available.

The default is **Full Screen**, but you can select **Maintain Aspect Ratio** or **Center**.

- 2) Press the **Adjust +** or **Adjust -** button to change the video mode, the chosen mode is highlighted.
- 3) Press the **Enter** button to confirm your selection and return to **Image Adjust** window

6.3.4 Image Enhancement

1) Press **Enter** button when the **Image Enhancement** is highlighted on **Image Adjust**.
The **Image Enhancement** window appears.

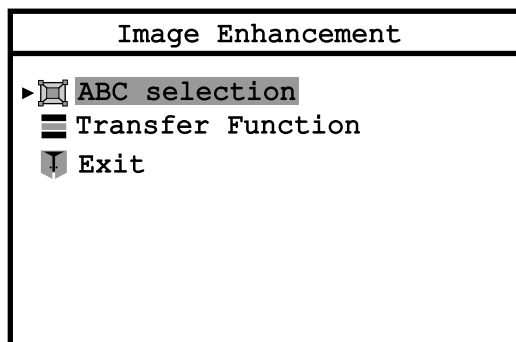

- 2) Press the **Menu +** or **Menu -** button until the desired item is highlighted.

6.3.5 ABC Selection

1) Press **Enter** button when the **ABC Selection** is highlighted on **Image Enhancement**
The **ABC Selection** window appears.

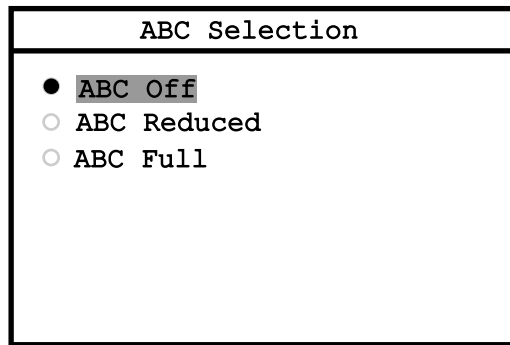

2) Press the **Adjust +** or **Adjust -** button until the desired item is highlighted.

- ABC off

Manual back light control regulated by panel button from 80 cd/m² to 200 cd/m²

- ABC full

Automatic control of back light, the back light is function of ambient light and follow a semilogarithmic curve from 80 cd/m² (at 1 lux) to 200 cd/m² (at 1000 lux).

-ABC reduced

The same as ABC full but with full scale of 140 cd/m² (at 1000 lux).

3) Press the **Enter** button to confirm your selection and return to **Image Enhancement** window

6.3.6 Transfer Function

1) Press **Enter** button when the **Transfer Function** is highlighted on **Image Enhancement**
The **Transfer Function** window appears.

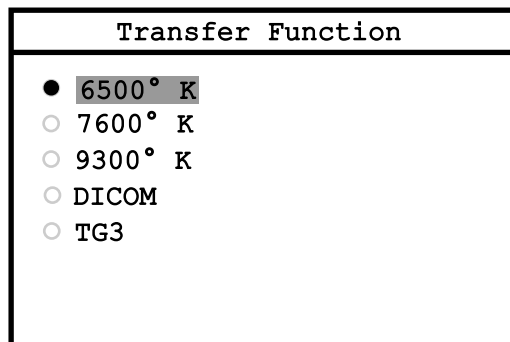

2) Press the **Adjust +** or **Adjust -** button until the desired item is highlighted.

Five colour temperature preset modes:

- 6500° K

DTP

- 7600° K

Photo retouch

- 9300° K

CAD/CAM

- DICOM

The output curve follows the DICOM curve

- TG3

The output curve is the same as PMS standard monitor.

3) Press the **Enter** button to confirm your selection and return to **Image Enhancement** window

6.3.7 Advanced

1) Press **Enter** button when the **Advanced** is highlighted on **Main Menu**
The **Advanced** window appears.

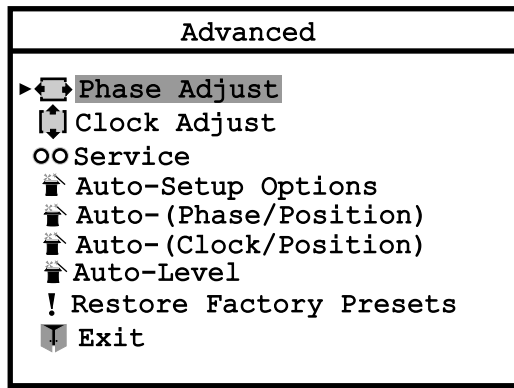

2) Press the **Menu +** or **Menu -** button until the desired source is highlighted.

6.3.8 Phase Adjust

1) Press **Enter** button when the **Phase Adjust** is highlighted on **Advanced**.

The **Phase Adjust** bar appears.

2) Press **Adjust +** or **Adjust -** button to adjust the quality image

Note: It is necessary to use video pattern dedicated to obtain the best result

3) When the position is adjusted, press the **Enter** button to return to **Advanced** window

4) Select **Exit** and press again **Enter** button to return to **Image Adjust** or select **Clock Adjust**.

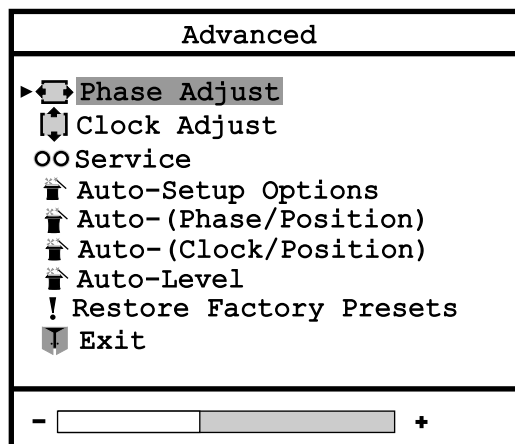

6.3.9 Clock Adjust

1) Press **Enter** button when the **Clock Adjust** is highlighted on **Advanced**.

The **Clock Adjust** bar appears.

2) Press **Adjust +** or **Adjust -** button to adjust the quality image

Note: It is necessary to use video pattern dedicated to obtain the best result

3) When the position is adjusted, press the **Enter** button to return to **Advanced** window

4) To select **Exit** and press again **Enter** button to return to **Image Adjust** or select **Service**.

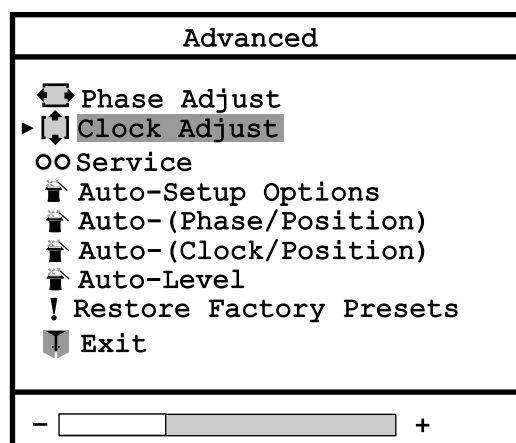

6.3.10 Service

- 1) Press **Enter** button when the **Service** is highlighted on **Advanced**.
The **Service** window appears.
- 2) Press **Menu +** or **Menu -** button until the desired item is highlighted and press **Enter**.
- 3) Press **Adjust +** or **Adjust -** button to adjust the quality image
- 4) When the item is adjusted, press the **Enter** button to return to **Service** window
- 5) Offset and Gain are items to use to calibrate the video signal (valid only for DSUB / DSUB/SOG video source).
When the calibration is OK it is necessary to execute the store operation to preserve the new values.
Press **Enter** button when the **Store Video** is highlighted.
- 6) Select **Exit** and press again **Enter** button to return to **Advanced** or select **Auto-Setup Options**.

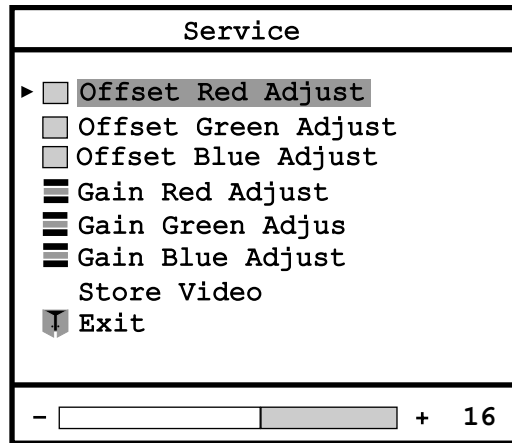

6.3.11 Auto-Setup Options

- 1) Press **Enter** button when the **Auto-Setup Options** is highlighted on **Advanced**.
The **Auto-Setup Options** window appears.
- 2) Press **Menu +** or **Menu -** button to select automatic options.
Auto-Setup Options and Auto-Clock feature define the modality of Auto-Adjust of the video image when the video timing is recognized.
- 3) Select **Exit** and press again **Enter** button to return to **Advanced** or select **Auto-Level**.

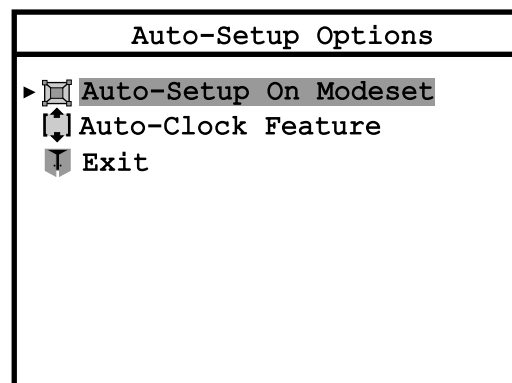

6.3.12 Auto-Setup On Modest

- 1) Press **Enter** button when the **Auto-Setup On Modest** is highlighted on **Auto-Setup Options**.
The **Auto-Setup On Modest** window appears.
- 2) Press **Adjust +** or **Adjust -** button until the desired item is highlighted
- 3) Press the **Enter** button to confirm your selection and return to **Auto-Setup Options** window

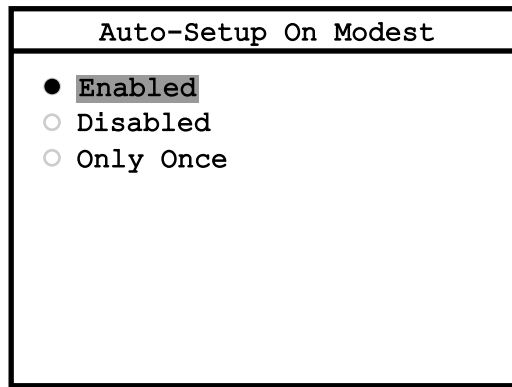

- Enabled** Every time the video timing changes
- Disabled** Never
- Only Once** Only the first time that the video timing is recognized.

6.3.13 Auto-Clock Feature

- 1) Press **Enter** button when the **Auto-Clock Feature** is highlighted on **Auto-Setup Options**. The **Auto-Clock Feature** window appears.
- 2) Press **Adjust +** or **Adjust -** button until the desired item is highlighted
- 3) Press the **Enter** button to confirm your selection and return to **Auto-Setup Options** window

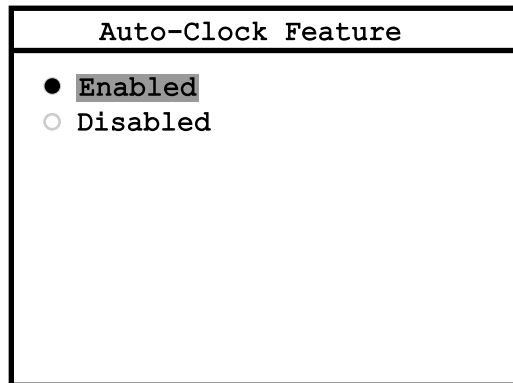

- Enabled** Every time the video timing changes
- Disabled** Never

6.3.14 Auto-(Phase/Position)

- 1) Press **Enter** button when the **Auto-(Phase/Position)** is highlighted on **Advanced**.
*To perform an automatic adjustmant of the video image.
Valid only **DSUB-SOG** and **DSUB** video source.*
- 2) Select **Exit** and press again **Enter** button to return to **Image Adjust** or select **Auto-(Clock/Position)**.

6.3.15 Auto-(Clock/Position)

- 1) Press **Enter** button when the **Auto-(Clock/Position)** is highlighted on **Advanced**.
*To perform an automatic adjustmant of the video image.
Valid only **DSUB-SOG** and **DSUB** video source.*
- 2) Select **Exit** and press again **Enter** button to return to **Image Adjust** or select **Auto-Level**.

6.3.16 Auto-Level

- 1) Press **Enter** button when the **Auto-Level** is highlighted on **Advanced**.
*To perform an automatic calibration of the video signal.
Valid only **DSUB-SOG** and **DSUB** video source.*
- 2) Select **Exit** and press again **Enter** button to return to **Image Adjust**.

6.3.17 Restore Factory Preset

- 1) Press **Enter** button when the **Restore Factory Preset** is highlighted on **Advanced**.
To reload factory settings.
- 2) Select **Exit** and press **Enter** button to return to **Image Adjust**.

6.4.0 Languages

- 1) Press **Enter** button when the **Languages** is highlighted on **Main Menu**.
The **Languages** window appears.
The ON SCREEN DISPLAY shows the five languages available.
The default is English, but you can select Français, Deustch, Español or Italiano.
- 2) Press the **Adjust +** or **Adjust -** button until the desired item is highlighted.
- 3) Press the **Enter** button to confirm your selection and return to **Main Menu** window

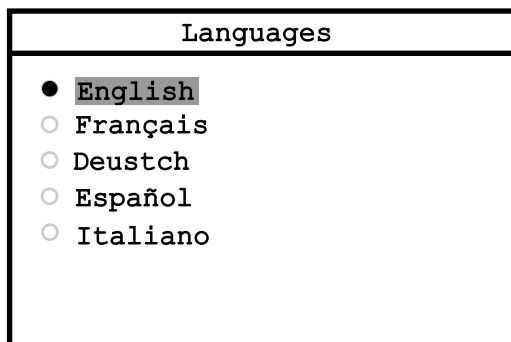

6.5.0 OSD Settings

- 1) Press **Enter** button when the **OSD Settings** is highlighted on **Main Menu**.
The **OSD Settings** window appears.
- 2) Press the **Menu +** or **Menu -** button until the desired item is highlighted.

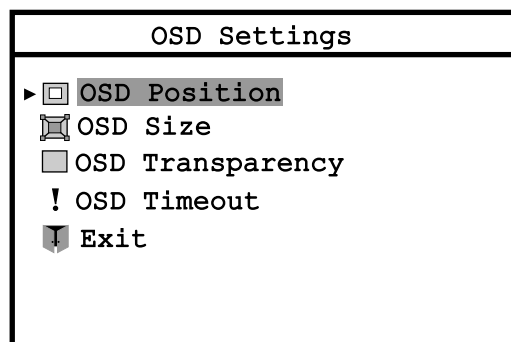

6.5.1 OSD Position

- 1) Press **Enter** button when the **OSD Position** is highlighted on **OSD Settings**.
The **OSD Positions** window appears.
- 2) Press the **Menu +** or **Menu -** button until the desired item is highlighted.

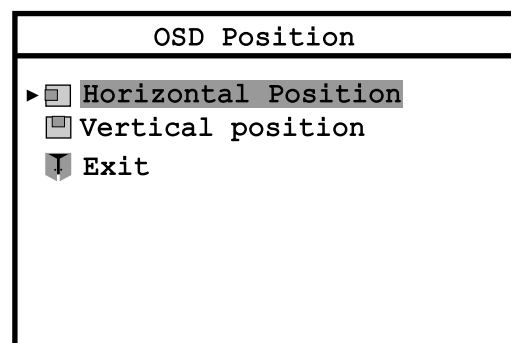

6.5.2 OSD Horizontal Position

1) Press **Enter** button when the **Horizontal Position** is highlighted on **OSD Position**.
The **Horizontal Position** bar appears.

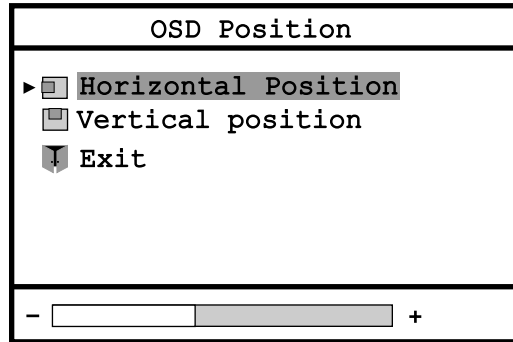

2) Press **Enter** button and **Adjust +** or **Adjust -** button to move the OSD image to **RIGHT** or to the **LEFT**.
3) When the position is adjusted, press the **Enter** button to return to **OSD Position** window
4) Select **Exit** and press again **Enter** button to return to **OSD Settings**

6.5.3 OSD Vertical Position

1) Press **Enter** button when the **Vertical Position** is highlighted on **OSD Position**.
The **Vertical Position** bar appears.

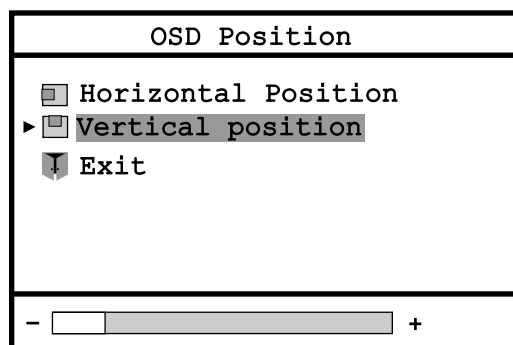

2) Press **Enter** button and **Adjust +** or **Adjust -** button to move **UP** or **DOWN** the OSD image .
3) When the position is adjusted, press the **Enter** button to return to **OSD Position** window
4) Select **Exit** and press again **Enter** button to return to **OSD Settings**.

6.5.4 OSD Size

1) Press **Enter** button when the **OSD Size** is highlighted on **OSD Settings**.
The **OSD Size** window appears.

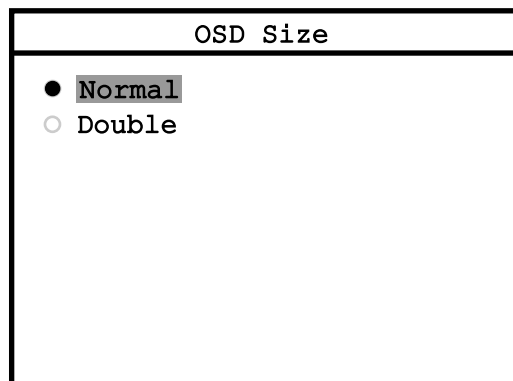

2) Press the **Adjust +** or **Adjust -** button until the desired item is highlighted.
Normal Standard dimensions
Double Double dimension
3) Press the **Enter** button to confirm your selection and return to **OSD Settings** window

6.5.5 OSD Transparency

1) Press **Enter** button when the **OSD Transparency** is highlighted on **OSD Settings**.
The **OSD Transparency** bar appears.

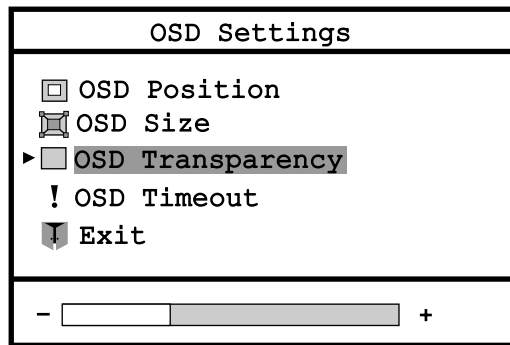

- 2) Press **Enter** button and **Adjust +** or **Adjust -** button to choose the degree of transparency of the OSD image
- 3) When the position is adjusted, press the **Enter** button to return to **OSD Settings** window
- 4) Select **Exit** and press again **Enter** button to return to **OSD Main Menu**.

6.5.6 OSD Timeout

1) Press **Enter** button when the **OSD Timeout** is highlighted on **OSD Settings**.
The **OSD Timeout** bar appears.

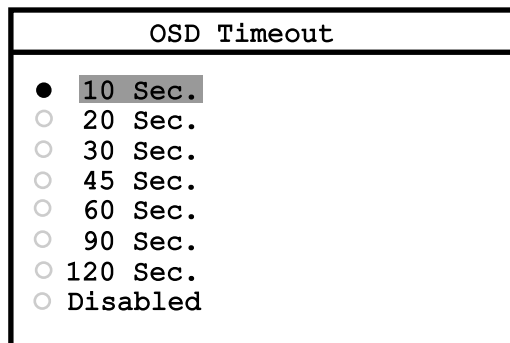

- 2) Press **Enter** button and **Adjust +** or **Adjust -** button to choose the time of activation of the OSD-Menu.
- 3) Press the **Enter** button to confirm your selection and return to **OSD Settings** windows.

6.6.0 Video Source

The **ON SCREEN DISPLAY** shows the four sources available.
The default is - **DSUB** (*) (D-sub input Video with separated syncr.).
but you can select:

- **DSUB-SOG** (D-sub input Video with Syncr. On Green)
- **DVI** (Digital Video Input)

- 1) Press **Enter** button when the **Video Source** is highlighted on **Main menu**.
The **Video Source** window appears.
- 2) Press the **Adjust +** or **Adjust -** button until the desired source is highlighted.
- 3) Press the **Enter** button to confirm your selection and exit from **OSD Main Menu**.

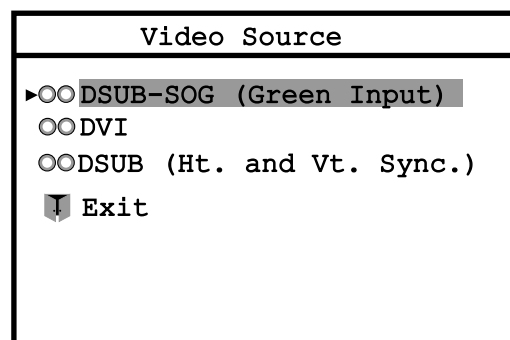

(*) see next page

(*) Video Source

If the Video Signal is not available a **warning message** will appear on the screen for about 5 sec.

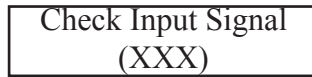

XXX= Current Video Source (DVI,DSUB,SOG)

After about 5 sec. the monitor will go in **Stand-By** mode.

The led colour will become orange.

To change the Video Source when the Video Source is not available to follow the followings steps:

- Wait the Warning Message.
- Press contemporarily the brightness keys.
- When the Warning message disappears
- Release the brightness keys.
- Execute the normal change of the **Video Source**. (see ref. 6.6.0)

6.7.0 Keyboard Option

1) Press **Enter** button when the **Keyboard Option** is highlight on **Main Menu**.
The **Keyboard Option** bar appears.

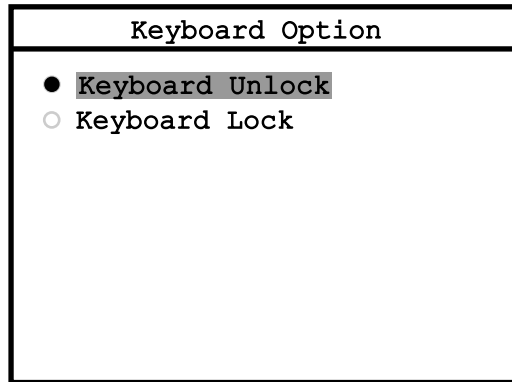

- 2) Press the **Adjust +** or **Adjust -** button until the desired item is highlighted..
3) Press the Enter button to confirm your selection and return to **Main Menu** window

REMARK:

To select the Keyboard status "**LOCK** or **UNLOCK**", use the Keyboard Option Menu.
(The new status is stored in E2prom, the default status is **UNLOCK**).

If the Keyboard Status is **UNLOCK** any key and any **OSD** function is available.

If the Keyboard Status is **LOCK**:

- (Brightness +), . (Brightness -) and Reference Setting Recall (200 Cd/m²) are always available.

- Pressing **OSD** key, will appear the dialog of Fig. 26a

The **OSD** menu will appear after having performed the follow correct keys sequence:

- **Brightness -**
- **Brightness +**
- **Brightness +**
- **Menu -**

The dialog (Fig. 26a) will disappear any time a wrong key will be pressed.

For every right key pressed a "plus" characters appears in dialog of Fig. 26a.



Fig.26a

INTENTIONALLY LEFT BLANK

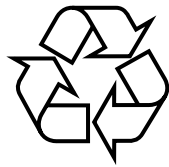

3119 206 1407.1

Free Manuals Download Website

<http://myh66.com>

<http://usermanuals.us>

<http://www.somanuals.com>

<http://www.4manuals.cc>

<http://www.manual-lib.com>

<http://www.404manual.com>

<http://www.luxmanual.com>

<http://aubethermostatmanual.com>

Golf course search by state

<http://golfingnear.com>

Email search by domain

<http://emailbydomain.com>

Auto manuals search

<http://auto.somanuals.com>

TV manuals search

<http://tv.somanuals.com>