

Language Select (Player Menu)

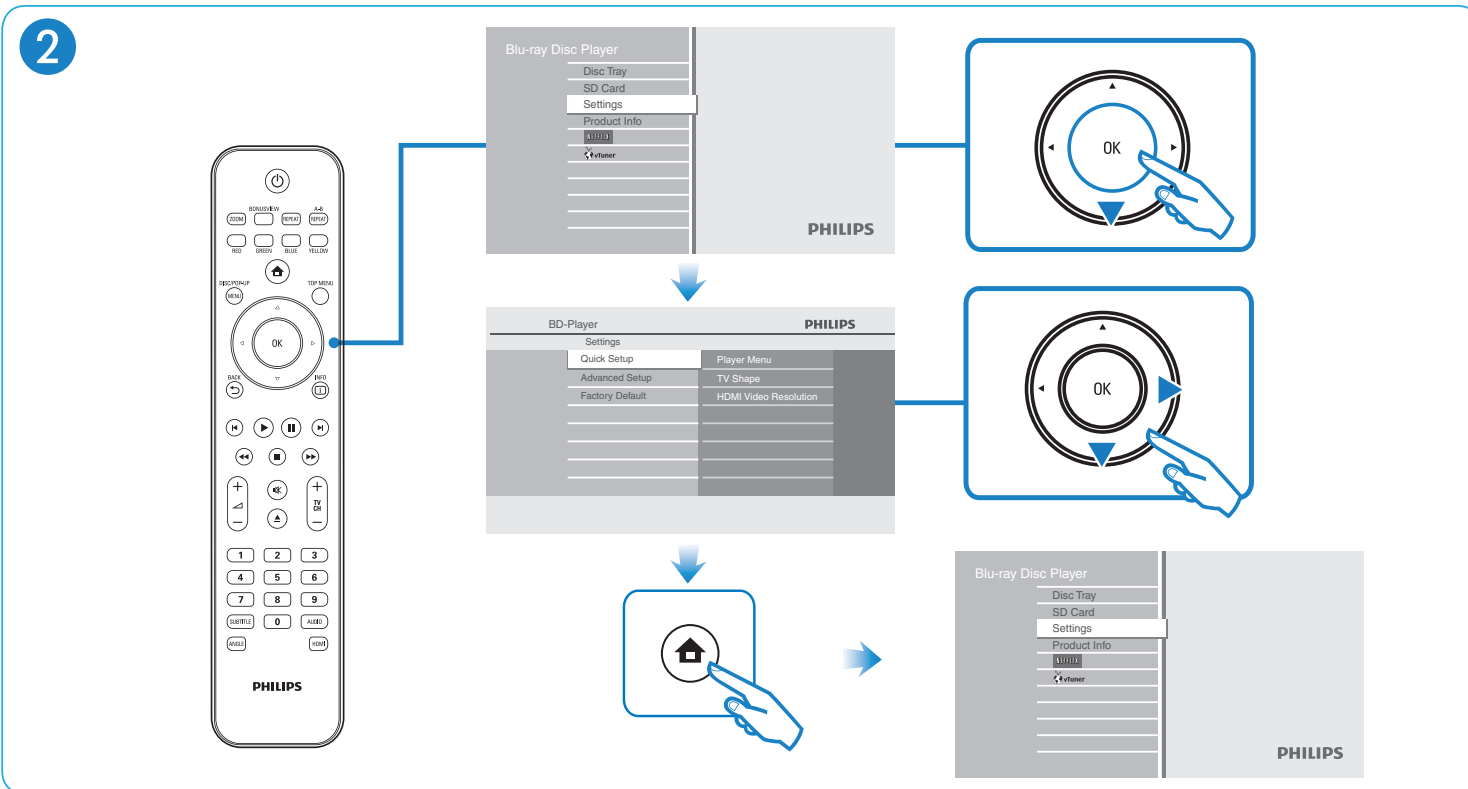

Quick Start Guide

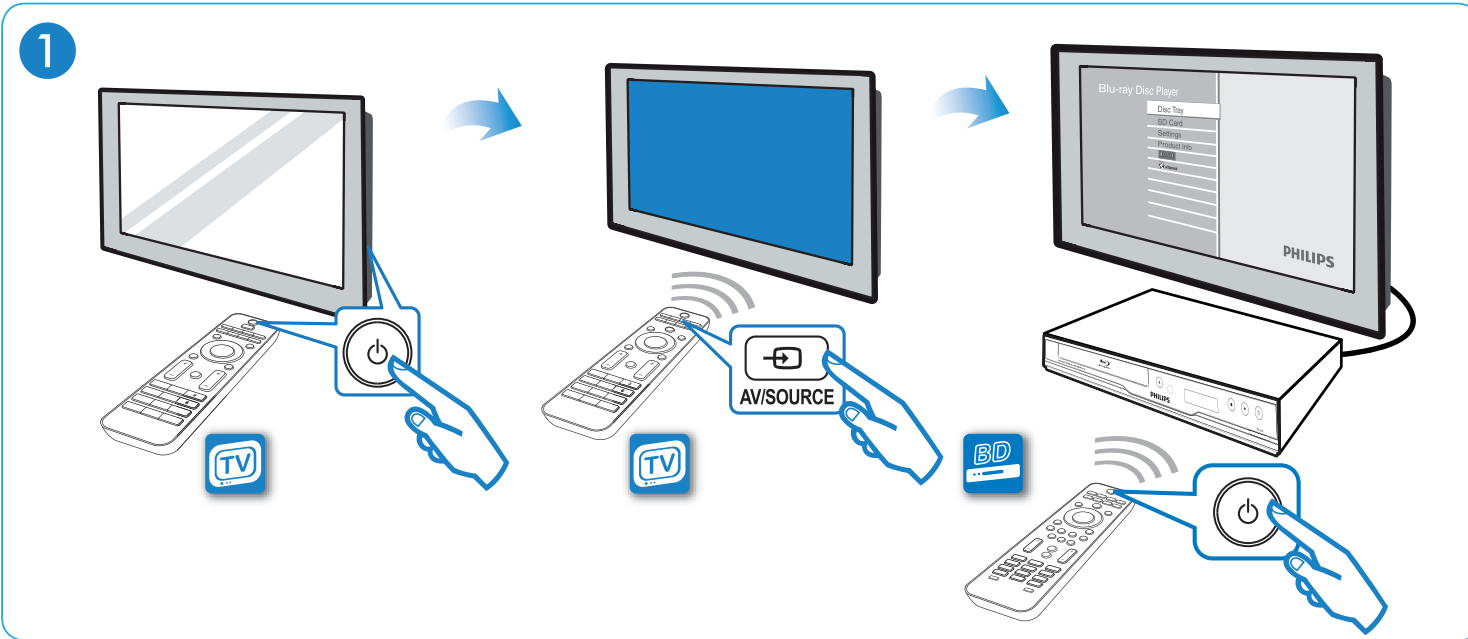

BDP5110/F7
BDP5110/F8

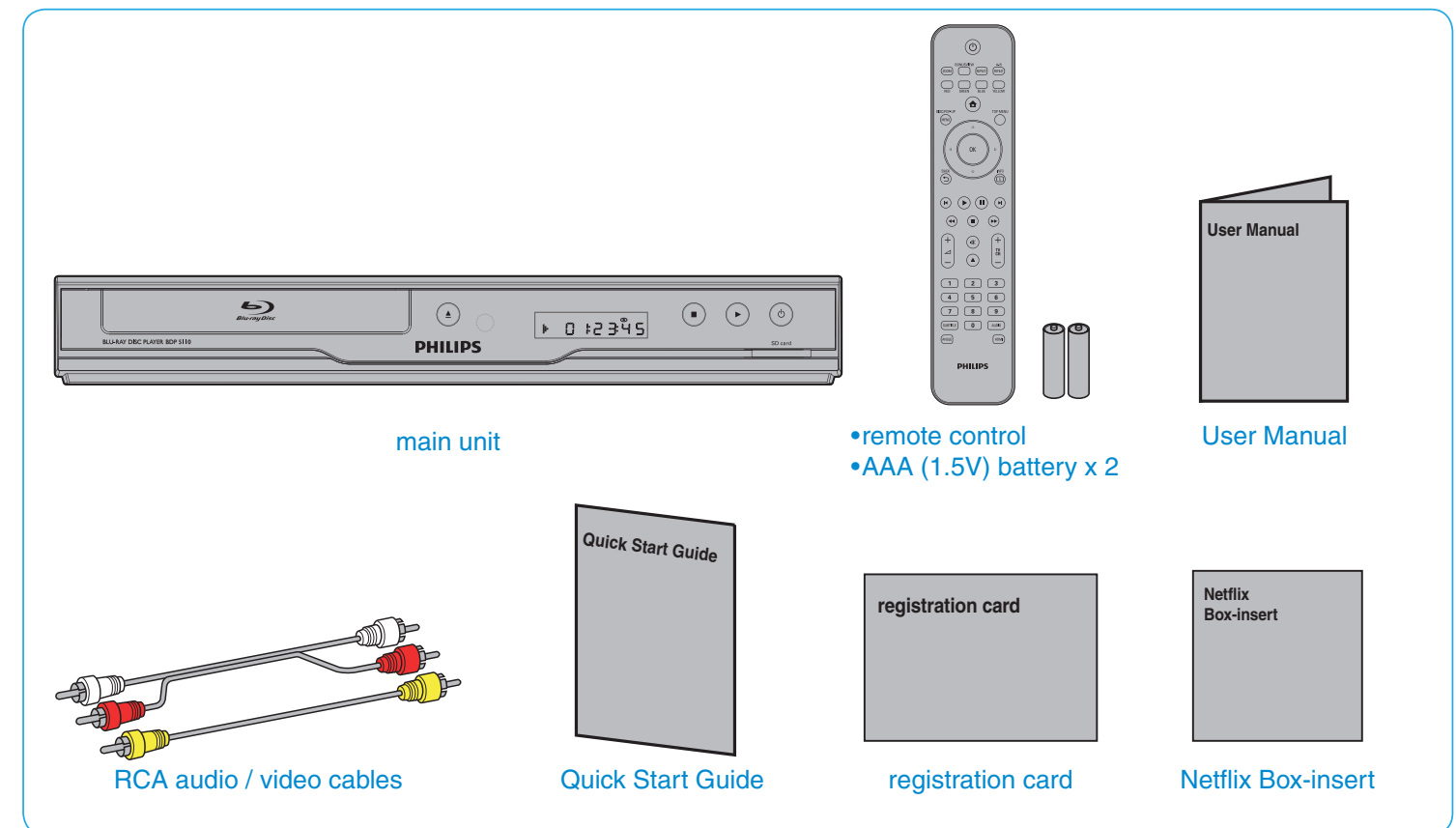

Need help?

User Manual

See the user manual that came with the main unit.

Online

Go to: www.philips.com/welcome

Hotline

Call **1-866-309-0866** for USA / Canada

Call **01 800 504 62 00** for Mexico



Philips and Philips Shield are used under license of Koninklijke Philips Electronics NV.

Printed in China
JpnYN-1023/F7-3
E5P50UD_E5P51UD
1VMN28494A ★★★★★



1VMN28494A



1

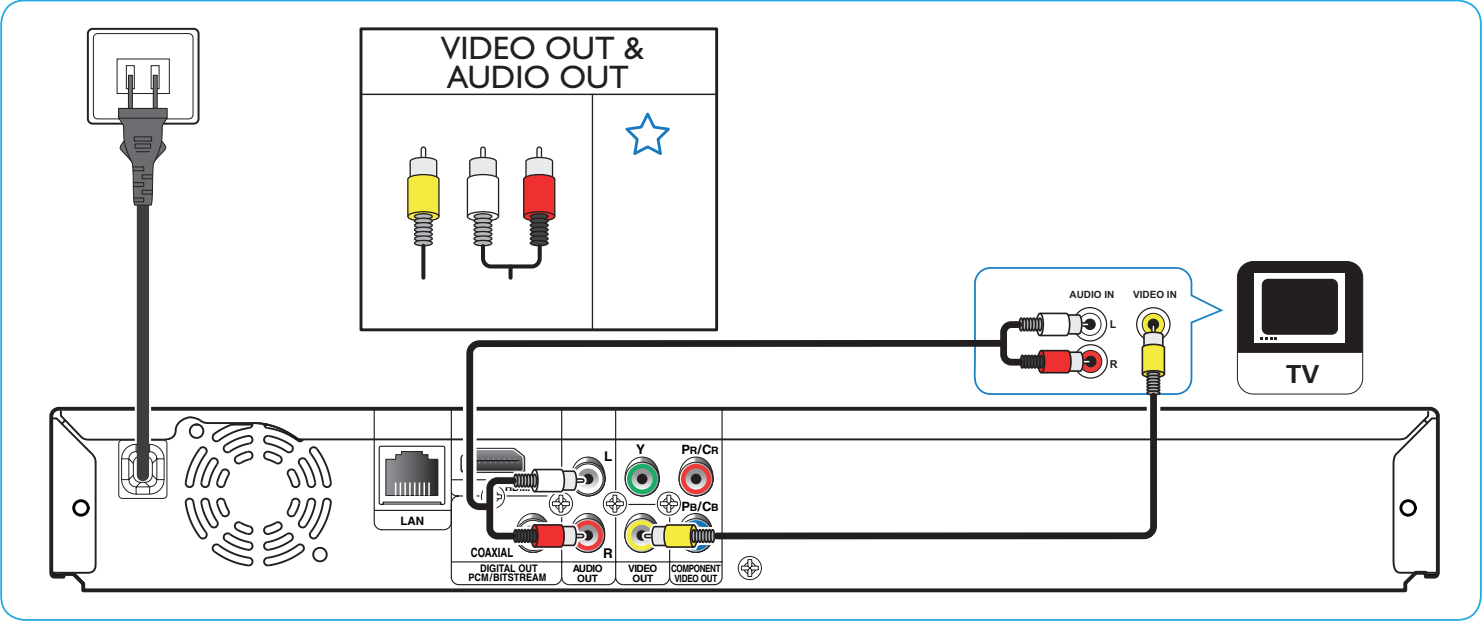
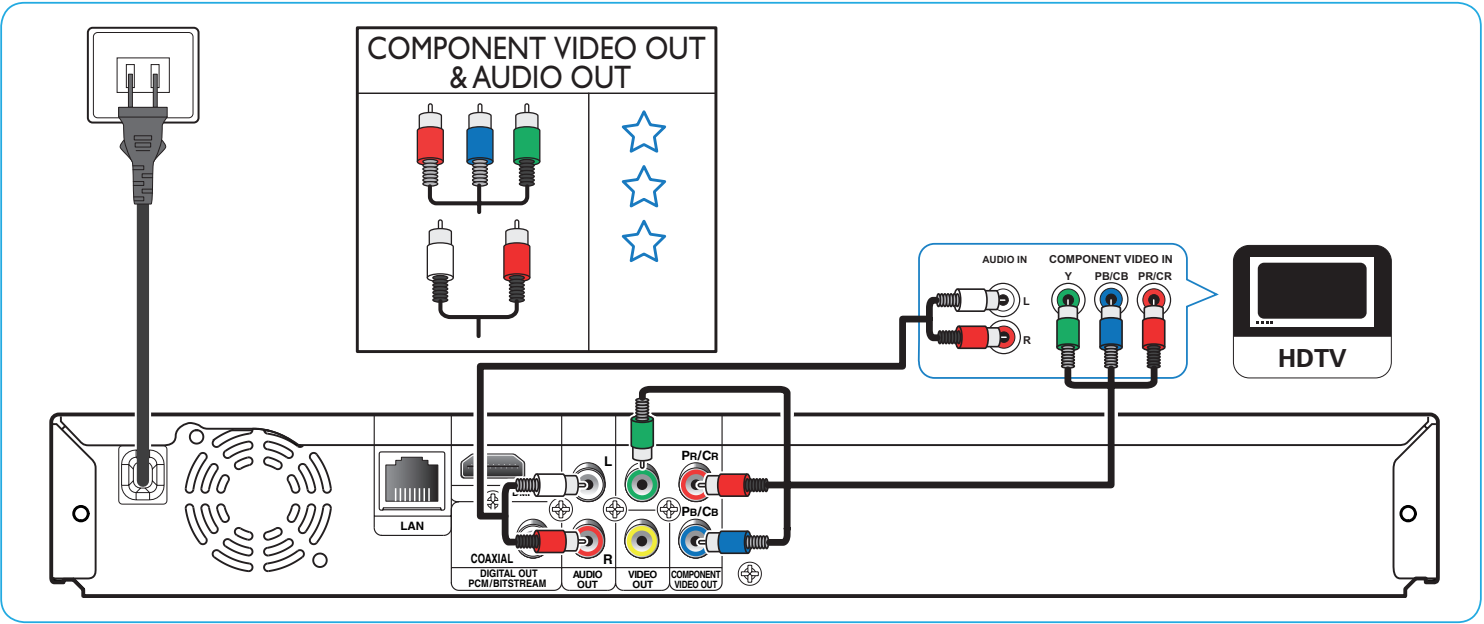
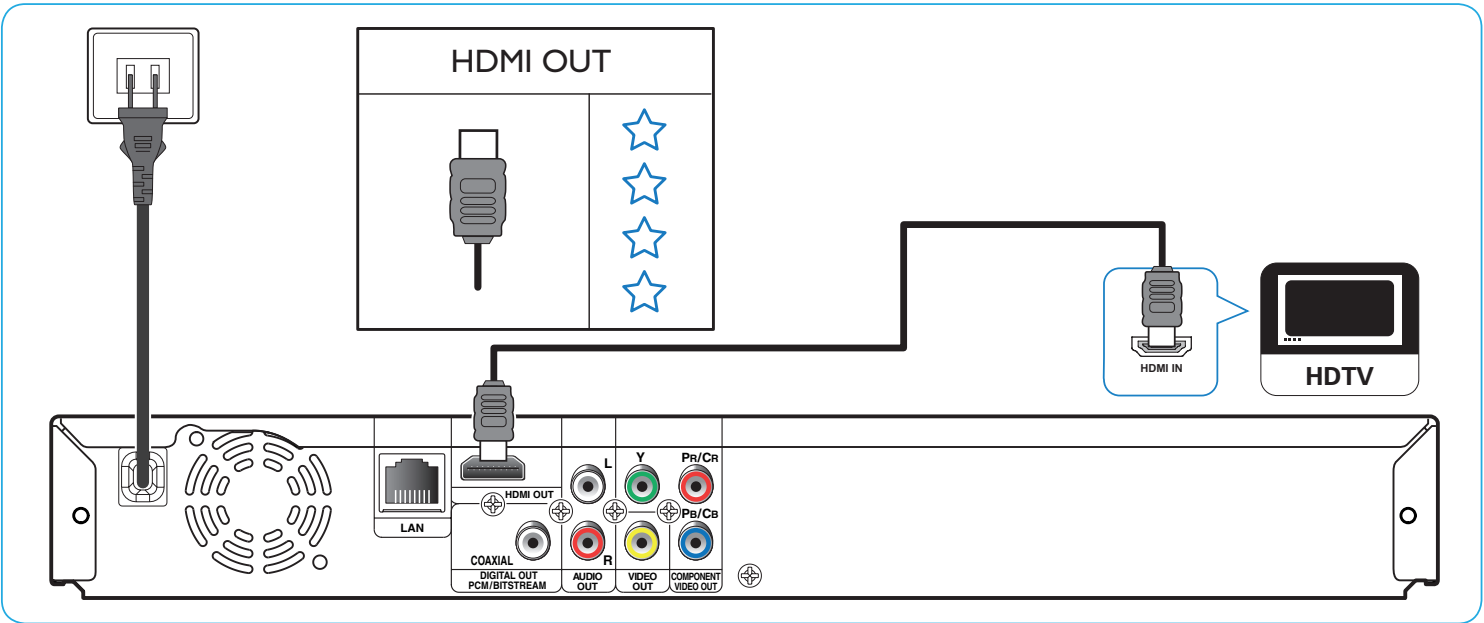

2

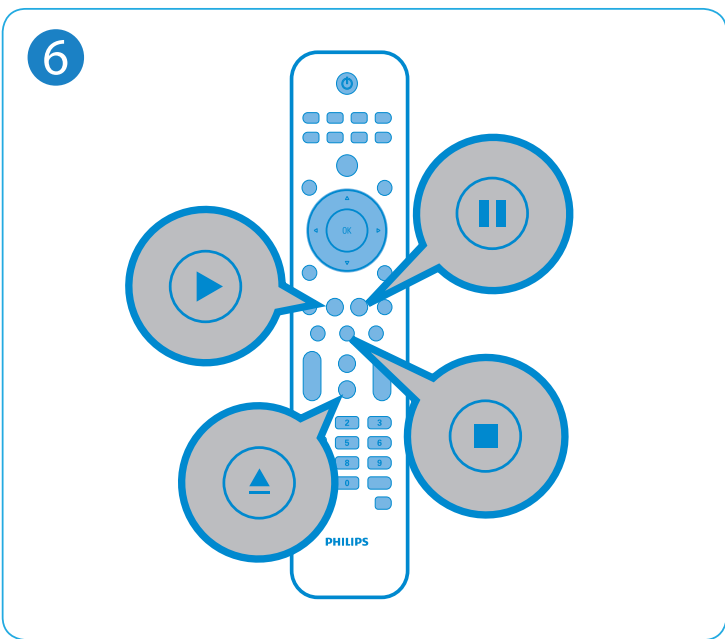
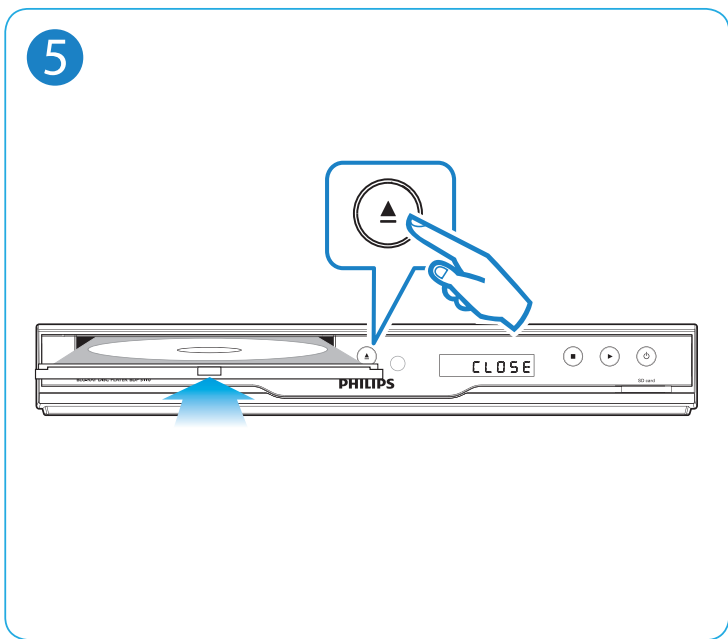
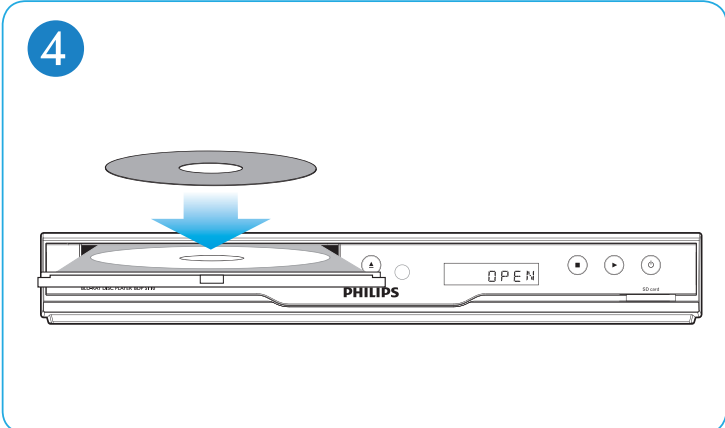
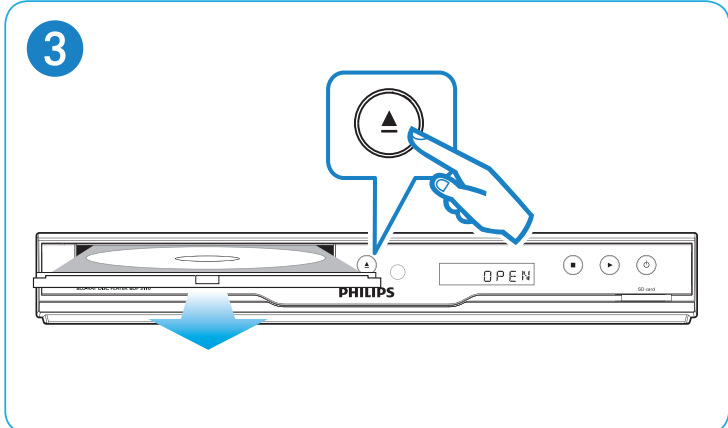
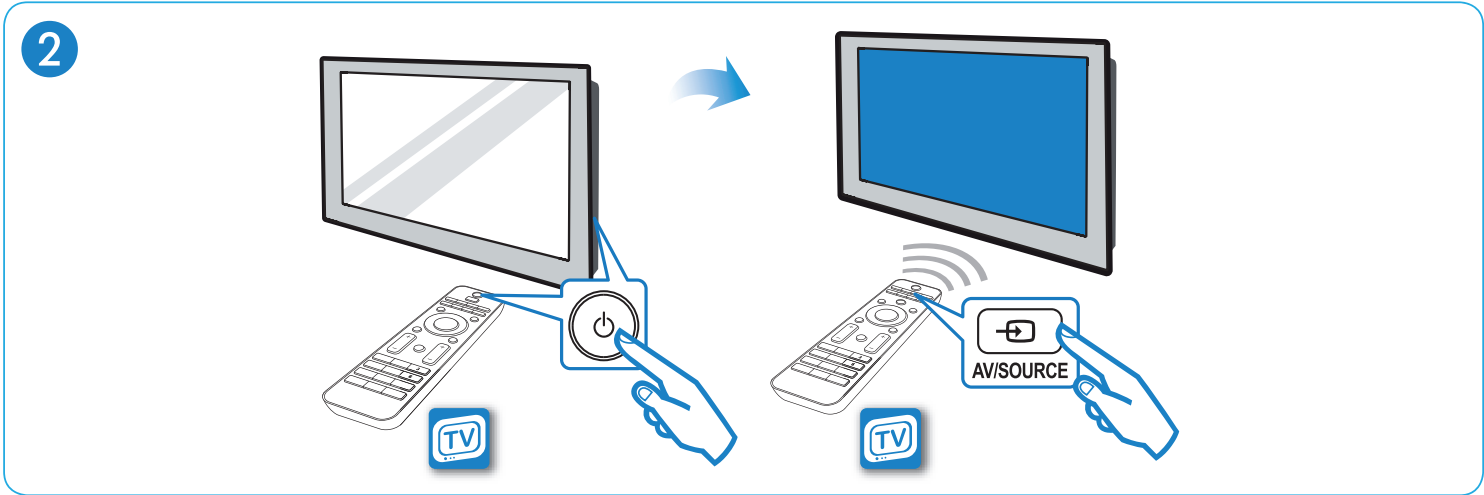
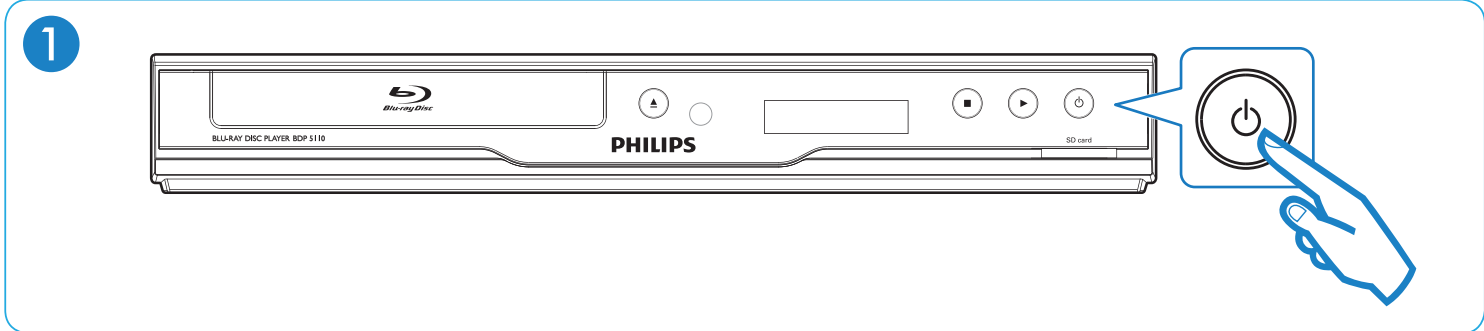

Free Manuals Download Website

<http://myh66.com>

<http://usermanuals.us>

<http://www.somanuals.com>

<http://www.4manuals.cc>

<http://www.manual-lib.com>

<http://www.404manual.com>

<http://www.luxmanual.com>

<http://aubethermostatmanual.com>

Golf course search by state

<http://golfingnear.com>

Email search by domain

<http://emailbydomain.com>

Auto manuals search

<http://auto.somanuals.com>

TV manuals search

<http://tv.somanuals.com>