

Register your product and get support at

www.philips.com/welcome

DTP4800



EN	User manual	3
CS	Příručka pro uživatele	21
DE	Benutzerhandbuch	39
ES	Manual del usuario	59
FR	Mode d'emploi	79
IT	Manuale utente	99
NL	Gebruiksaanwijzing	119

PHILIPS

LASER

CAUTION:

USE OF CONTROLS OR ADJUSTMENTS OR PERFORMANCE OF PROCEDURES OTHER THAN THOSE SPECIFIED HEREIN MAY RESULT IN HAZARDOUS RADIATION EXPOSURE.

CAUTION:

VISIBLE AND INVISIBLE LASER RADIATION WHEN OPEN AND INTERLOCK DEFEATED. DO NOT STARE INTO BEAM.

LOCATION:

INSIDE, NEAR THE DECK MECHANISM.

Specifikace laseru

- Typ: Polovodičový laser InGaAlP (DVD), AlGaAs (CD)
- Vlnová délka: 655 nm (DVD), 790 nm (CD)
- Výstupní výkon: 10 mW (DVD), 5 mW (VCD/CD)

Italia

DICHIARAZIONE DI CONFORMITA'

Si dichiara che l'apparecchio DTP4800, Philips risponde alle prescrizioni dell'art. 2 comma 1 del D.M. 28 Agosto 1995 n.548.

Fatto a Eindhoven

Philips Consumer Lifestyles
Philips, Glaslaan 25616 JB Eindhoven,
The Netherlands

ČESKA REPUBLIKA

Výstraha! Tento přístroj pracuje s laserovým paprskem. Při nesprávné manipulaci s přístrojem (v rozporu s tímto návodem) může dojít k nebezpečnému ozáření. Proto přístroj za chodu neotevírejte ani nesnímejte jeho kryty. Jakoukoli opravu vždy svěřte specializovanému servisu.

Nebezpečí! Při sejmutí krytů a odjištění bezpečnostních spínačů hrozí nebezpečí neviditelného laserového záření!

Chraňte se před přímým zásahem laserového paprsku.

Pokud byste z jakéhokoli důvodu přístroj demontovali, vždy nejdříve vytáhněte síťovou zástrčku.

Přístroj chraňte před jakoukoli vlhkostí i před kapkami vody.

Contents

1 Important	4
Safety and important notice	4
2 Your product	5
Playable media	5
Product overview	5
3 Connect	6
Connect TV antenna	6
Connect audio/video cables	7
Optional audio connections	8
Connect USB flash drive	8
Connect power	8
4 Get started	8
Prepare the remote control	8
Navigate the menu	8
Find the TV input channel	9
First time setup	9
Use the Home menu	9
Select menu display language	9
Turn on progressive scan	9
Use Philips EasyLink	9
5 Watch TV	10
Use on-screen guide	10
Use the program edit table	10
6 Listen to radio	11
Use on-screen guide	11
Use the program edit table	11
7 Play	12
Play a disc	12
Play from USB device	12
Play video	12
Play music	13
Play photo	13
Other features	14
8 Adjust system setting	14
General settings	14
DVD/USB settings	16
TV/Radio settings	17
9 Additional information	18
Update software	18
Care	18
10 Specifications	18
11 Troubleshooting	19

Trademark notice



ABOUT DIVX VIDEO: DivX® is a digital video format created by DivX, Inc. This is an official DivX Certified device that plays DivX video. Visit www.divx.com for more information and software tools to convert your files into DivX video.

ABOUT DIVX VIDEO-ON-DEMAND: This DivX Certified® device must be registered in order to play DivX Video-on-Demand (VOD) content. To generate the registration code, locate the DivX VOD section in the device setup menu. Go to vod.divx.com with this code to complete the registration process and learn more about DivX VOD.

DivX® is a registered trademark of DivX, Inc., and is used under license.



HDMI, and HDMI logo and High-Definition Multimedia Interface are trademarks or registered trademarks of HDMI licensing LLC.



DVB is a registered trademark of the DVB Digital Video Broadcasting Project (1991 to 1996).



Manufactured under license from Dolby Laboratories. Dolby, Pro Logic and the double-D symbol are trademarks of Dolby Laboratories.



All other registered and unregistered trademarks are the property of their respective owners.

1 Important

Safety and important notice



Warning

- Risk of overheating! Never install the product in a confined space. Always leave a space of at least 4 inches around the product for ventilation. Ensure curtains or other objects never cover the ventilation slots on the product.
- Never place the product, remote control or batteries near naked flames or other heat sources, including direct sunlight.
- Avoid high temperature, moisture, water and dust.
- This unit must not be exposed to dripping or splashing.
- Never place any object or items that can damage this unit (e.g., liquid filled objects, lighted candles).
- Never place this product on other electrical equipment.
- Keep away from this product during lightning storms.
- Where the mains plug or an appliance coupler is used as the disconnect device, the disconnect device shall remain readily operable.
- Visible and invisible laser radiation when open. Avoid exposure to beam.

This product complies with the radio interference requirements of the European Community.



About Progressive Scan

Consumers should note that not all high definition television sets are fully compatible with this product and may cause artifacts to be displayed in the picture. In case of 525 or 625 progressive scan picture problems, it is recommended that the user switch the connection to the 'standard definition' output. If there are questions regarding our TV set compatibility with this model 525p and 625p DVD player, please contact our customer service center.

Disposal of your old product and batteries

Your product is designed and manufactured with high quality materials and components, which can be recycled and reused.



When this crossed-out wheeled bin symbol is attached to a product it means that the product is covered by the European Directive 2002/96/EC. Please inform yourself about the local separate collection system for electrical and electronic products.



Please act according to your local rules and do not dispose of your old products with your normal household waste.

Correct disposal of your old product helps to prevent potential negative consequences for the environment and human health.

Your product contains batteries covered by the European Directive 2006/66/EC, which cannot be disposed with normal household waste.



Please inform yourself about the local rules on separate collection of batteries because correct disposal helps to prevent negative consequences for the environmental and human health.

Copyright notice

This item incorporates copy protection technology that



**Be responsible
Respect copyrights**

is protected by U.S. patents and other intellectual property rights of Rovi Corporation. Reverse engineering and disassembly are prohibited.

Open source software

Philips Electronics Hong Kong Ltd. hereby offers to deliver, upon request, a copy of the complete corresponding source code for the copyrighted open source software packages used in this product for which such offer is requested by the respective licenses. This offer is valid up to three years after product purchase to anyone in receipt of this information. To obtain source code, please contact open.source@philips.com. If you prefer not to use email or if you do not receive confirmation receipt within a week after mailing to this email address, please write to "Open Source Team, Philips Intellectual Property & Standards, P.O. Box 220, 5600 AE Eindhoven, The Netherlands." If you do not receive timely confirmation of your letter, please email to the email address above.

**CLASS 1
LASER PRODUCT**

2 Your product

Congratulations on your purchase, and welcome to Philips! To fully benefit from the support that Philips offers, register your product at www.philips.com/welcome.

Playable media

This product can play:

- DVD, DVD-Video, DVD+R/+RW, DVD-R/-RW, DVD+R/-R DL (Dual Layer)
- Video CD/SVCD
- Audio CD, CD-R/CD-RW
- MP3 media, WMA media, DivX media, JPEG files
- USB flash drive

Region codes





You can play discs with the following region codes.

DVD region code	Countries
	Europe

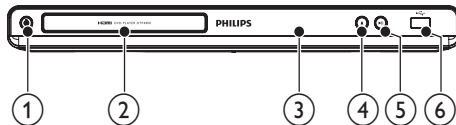
Product overview





Main unit

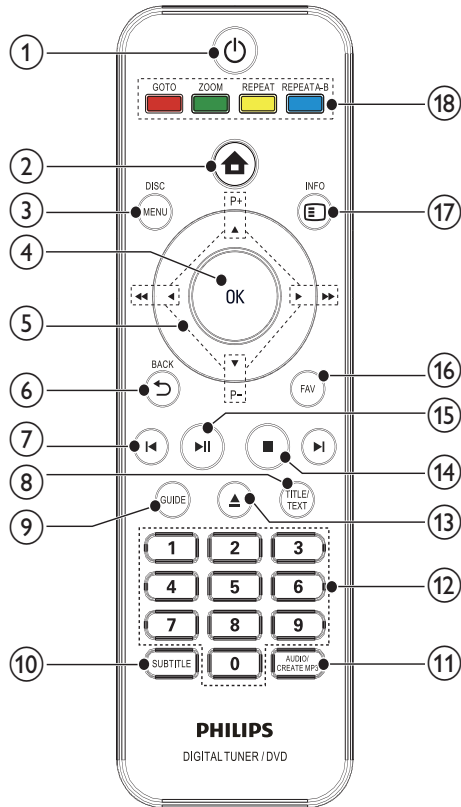

-  Turn on this product or switch to standby mode.
- Disc compartment**
- Display panel**
-  Open/close the disc compartment.
-  Start, pause or resume disc play.
-  Connect a USB flash drive.

Remote control



-  Turn on this product or switch to standby mode.
-  Access the home menu.
- DISC MENU**
 - Access/exit the disc menu, or display the USB file browser.
- OK**
 - Confirm an entry or selection.
 - Display the TV/radio channel list.
- 
 - Navigate the menus.
 - For , search backward or forward.
- P +/-**
 - For digital TV/radio, select the previous/next channel.

- ⑥ **↩ BACK**
 - Return to the previous display menu.
- ⑦ **⏮ ⏭**
 - Skip to the previous/next title, chapter or track.
- ⑧ **TITLE/TEXT**
 - For DVD, display the title menu.
 - For digital TV, display teletext information.
- ⑨ **GUIDE**
 - For digital TV/radio, turn on or off the program list.
- ⑩ **SUBTITLE**
 - Select a subtitle language.
- ⑪ **AUDIO/CREATE MP3**
 - Select an audio language or channel on a disc.
 - Access the menu of creating MP3 files.
- ⑫ **Numeric buttons**
 - Select an item to play.
 - Select a TV/radio channel.
 - Enter values.
- ⑬ **▲**
 - Open/close the disc compartment.
- ⑭ **■**
 - Stop play.
- ⑮ **▶ ||**
 - Start, pause or resume disc play.
- ⑯ **FAV**
 - Turn on or off the favorite channel list for TV / radio.
- ⑰ **INFO**
 - Display play information.
- ⑱ **Color buttons**
 - For teletext mode only, select tasks or options.
- REPEAT A-B**
 - Repeat play for a specific section.
- REPEAT**
 - Select or turn off repeat/shuffle play.
- ZOOM**
 - Zoom the picture in or out.
- GOTO**
 - Skip play to a specific point.

3 Connect

Make the following connections to use this product.

Basic connections:

- TV antenna
- Video
- Audio

Optional connections:

- Route audio to other devices:
 - Digital amplifier/receiver
 - Analog stereo system
- USB flash drive

Note

- Refer to the type plate at the back or bottom of the product for identification and supply ratings.
- Before you make or change any connections, ensure that all the devices are disconnected from the power outlet.

Connect TV antenna

Connect this product to a TV antenna to receive digital TV and radio.

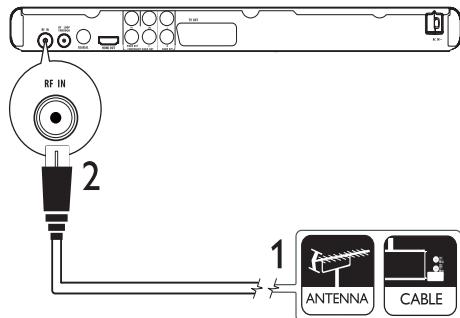

- 1 Unplug the TV antenna from the TV.
- 2 Then connect the antenna to the **RF IN** jack on this product.

To route the digital signal from this product to another device (such as TV):

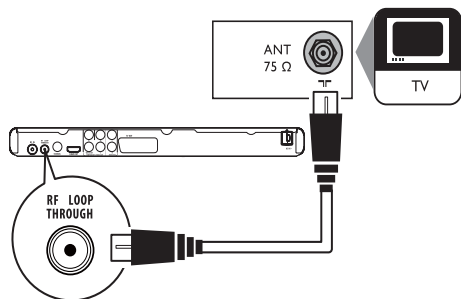

- 1 Connect an RF antenna cable (not supplied) to:
 - the **RF LOOP THROUGH** jack on this product.
 - the antenna input on the TV.



Tip

- The antenna input jack on the TV might be labeled ANT, ANTENNA IN or RF IN.

Connect audio/video cables

Select the best video connection that TV can support.

Option 1: Connect to the HDMI jack (for a HDMI, DVI or HDCP-compliant TV).

Option 2: Connect to the component video jacks (for a standard TV or Progressive Scan TV).

Option 3: Connect to the scart jack (for a standard TV)).

Option 4: Connect to the video (CVBS) jack (for a standard TV).

Option 1: Connect to the HDMI jack

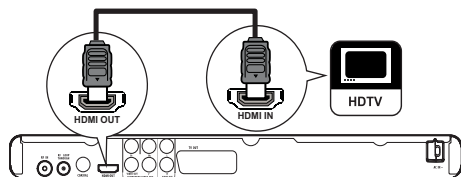

- 1 Connect an HDMI cable (not supplied) to:
 - the **HDMI OUT** jack on this product.
 - the HDMI input jack on the TV.



Note

- If the device supports HDMI CEC, you can control compliant devices with a single remote control (see "Get started" > "Use Philips EasyLink").

Option 2: Connect to the component video jacks

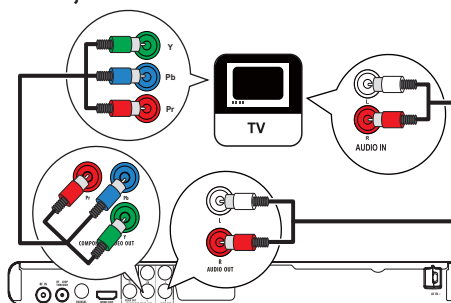

- 1 Connect the component video cables to:
 - the **Y Pb Pr** jacks on this product.
 - the **COMPONENT VIDEO** input jacks on the TV.
- 2 Connect the audio cables to:
 - the **AUDIO OUT L/R** jacks on this product.
 - the audio input jacks on the TV.

Option 3: Connect to the scart jack

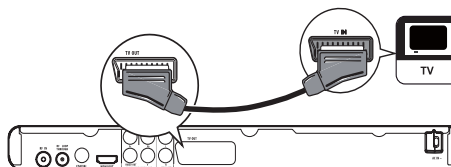

- 1 Connect a scart cable (not supplied) to:
 - the **TV OUT** jack on this product.
 - the scart input jack on the TV.

Option 4: Connect to the video (CVBS) jack

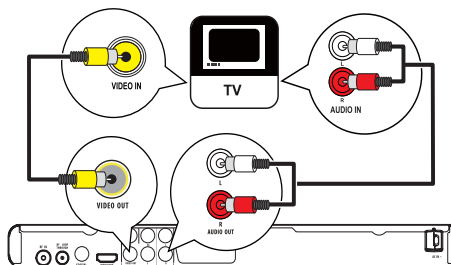

- 1 Connect a composite video cable to:
 - the **VIDEO OUT** jack on this product.
 - the video input jack on the TV.

- 2 Connect the audio cables to:
 - the **AUDIO OUT L/R** jacks on this product.
 - the audio input jacks on the TV.

Optional audio connections

Connect the audio from this product to other devices to enhance sound.

Connect to digital amplifier/receiver

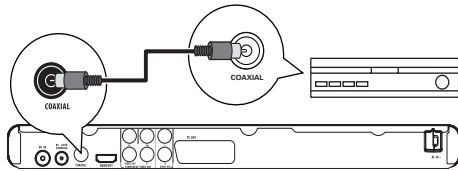

- 1 Connect a coaxial cable (not supplied) to:
 - the **COAXIAL** jack on this product.
 - the **COAXIAL/DIGITAL** input jack on the device.

Connect an analogue stereo system

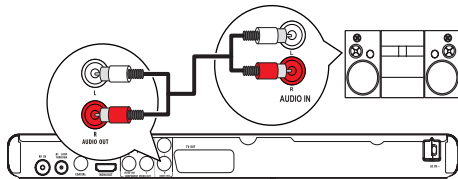

- 1 Connect the audio cables to:
 - the **AUDIO L/R** jacks on this product.
 - the audio input jacks on the device.

Connect USB flash drive

- 1 Connect a USB flash drive to the  jack on this product.

Note

- This product can only play/view MP3, DivX or JPEG files that are stored on a USB flash drive.
- Press  to access the content and play the files.

Connect power

! Caution

- Risk of product damage! Ensure that the power supply voltage corresponds to the voltage printed on the back of the unit.
- Before connecting the AC power cord, ensure you have completed all other connections.

☰ Note

- The type plate is located on the back of the product.

- 1 Connect the AC power cable to the wall socket.
 - ↳ The product is ready to be set up for use.

4 Get started

Prepare the remote control

- 1 Press and push the battery compartment to slide it open (see "1" in the illustration).
- 2 Insert two AAA batteries with correct polarity (+/-) as indicated.
- 3 Push and slide back the battery compartment (see "3" in the illustration).

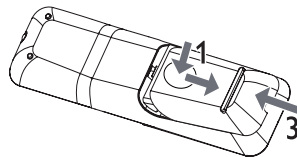

☰ Note

- If you are not going to use the remote control for a long time, remove the batteries.
- Do not mix batteries (old and new or carbon and alkaline, etc).
- Batteries contain chemical substances, so they should be disposed of properly.

Navigate the menu

- 1 When the on-screen menu is displayed, press the buttons on the remote control to navigate.

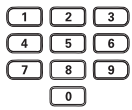
Button	Action
▲▼	Move up or down
◀▶	Move left or right
OK	Confirm a selection
	Enter numbers

Find the TV input channel

- 1 Press **⏻** to turn on this product.
- 2 Turn on the TV and switch to the video input channel (refer to the TV user manual on how to select the A/V input channel).

First time setup

When you turn on this product for the first time, follow the instructions on the TV screen to install TV and radio channels.

- 1 Press **⏻** to turn on the product.
 - ↳ On the TV screen, the first-time installation message is displayed.
- 2 Select **[Yes]** and press **OK** to proceed.
- 3 Select **[Country]** and press **OK**, then select the country of your residence and press **OK**.
- 4 Select **[Language]** and press **OK**, then select a language and press **OK**.
- 5 Select **[Next]** and press **OK** to start to search.
 - ↳ Automatic channel search screen is displayed, and the product begins to search TV and radio channels.
 - ↳ When the search completes, the available TV and radio channels are stored.

Use the Home menu

- 1 Press **⏻**.
 - ↳ The home menu is displayed.
 - **[DVD]** - Select disc mode.
 - **[Live TV]** - Select TV mode.
 - **[DVB-T Radio]** - Select radio mode.
 - **[USB]** - Select USB mode.
 - **[System Setting]** - Access the setup menu.

Select menu display language

- 1 Press **⏻**.
 - ↳ The home menu is displayed.
- 2 Select **[System Setting] > [General Setting] > [Language Setup] > [OSD Language]**, then press **OK**.
- 3 Press **▲▼** to select a language, then press **OK**.

Turn on progressive scan



Note

- To use the progressive scan feature, you must connect a progressive scan TV with the component video jacks (see "Connect" > "Connect audio/video cables" > "Option 2: Connect to the component video jacks" for details).

- 1 Turn on the TV to the correct video input channel for this product.
- 2 Press **⏻**.
- 3 Select **[System Setting] > [General Setting] > [Video Setup] > [Video Output] > [Progressive]**, then press **OK**.
 - ↳ The progressive setup is complete.



Note

- If a TV picture appears improperly, deselect **[Progressive]** to turn off the progressive scan mode.

- 4 Press **⏻** to exit the menu.
- 5 You can now turn on the progressive scan mode on the TV (see the TV user manual).



Note

- During play, when the progressive scan mode is on for both this product and the TV, distorted picture may display. In this case, turn off the progressive scan feature on both this product and the TV.

Use Philips EasyLink

This product supports Philips EasyLink which uses the HDMI CEC (Consumer Electronics Control) protocol. You can use one single remote control to control EasyLink-compliant devices that are connected through HDMI connectors.

Note

- To enable the EasyLink feature, you must turn on the HDMI CEC operations on the TV and on other devices connected to TV. Refer to the TVs/devices manual for details.

One-touch play

- 1 Press **⏻** to turn on this product.
 - ↳ The TV (if supports one-touch play) automatically turns on and switches to the correct video-in channel.

One-touch standby

- 1 Press and hold **⏻** on the remote control for more than 3 seconds.
 - ↳ All the connected devices (if the device supports one-touch standby) automatically switch to standby.

Note

- Philips does not guarantee 100% interoperability with all HDMI CEC devices.

5 Watch TV

Note

- Before you start, ensure that you have connected properly the TV antenna to this product, and completed the first-time installation.

- 1 Press **⏻** to turn on this product.
- 2 Turn on the TV, and select the video input channel on the TV.
- 3 Press **🏠**.
 - ↳ The home menu is displayed.
- 4 Select **[Live TV]**, then press **OK**.
 - ↳ The TV mode is turned on.
- 5 Press **P + -** or the **Numeric buttons** to select a channel.

Use on-screen guide

With this feature, you can view the program schedule and program details.

- 1 In the TV mode, press **GUIDE**.
 - ↳ The program list is displayed.
- 2 To view the details of a program, select the program and press **▶**.

Use the program edit table

With the program edit table, you can set favorite channels, or adjust channel sequence or delete channels.

- 1 In the TV mode, press **🏠**.
 - ↳ The home menu is displayed.
- 2 Select **[System Setting] > [TV/Radio Setting] > [Channel] > [TV Channel]**, then press **OK**.
 - ↳ The program table is displayed.

Set favorite channels

Create a shortlist of favorite programs to access quickly.

- 1 In the TV mode, press **FAV**.
 - ↳ A program table is displayed.
- 2 In the **[FAV]** column select a channel, then press **OK**.
 - ↳ A heart-shaped symbol is displayed in the **[FAV]** column to indicate the channel is marked as a favorite.

- 3 Repeat the step 2 to mark more programs as a favorite.
 - To delete a favorite program, select the related heart-shaped symbol and press **OK**.
- 4 Press **⏏** to save and exit the menu.

View favorite channels

- 1 Make sure that you have set favorite channels.
- 2 In the TV mode, press **FAV** to enable the favorite channel list.
 - ↳ [Fav On] (favorite on) is displayed.
- 3 Press **P + -** to select a channel among the favorite channels.

To disable the favorite channels list

- 1 In the TV mode, press **FAV** again.
 - ↳ [Fav Off] (favorite off) is displayed.

Adjust channel sequence

- 1 Go to the program edit table.
- 2 In the [**Move**] column select a channel, then press **OK**.
 - ↳ An up/down symbol is displayed.
- 3 Press **▲▼** to move the channel up or down.
- 4 Repeat the steps 2-3 to move more channels.
- 5 Press **⏏** to save and exit the menu.

Delete a channel

- 1 Go to the program edit table.
- 2 In the [**Del**] column select a channel, then press **OK**.
 - ↳ An "X" is displayed to indicate that the channel is selected for deletion.
- 3 Repeat the step 2 to select more channels for deletion.
- 4 Press **⏏** to confirm deletion.
 - ↳ The channel is deleted.

6 Listen to radio



Note

- Before you start, ensure that you have connected properly the TV antenna to this product, and completed the first-time installation.

- 1 Press **⏏** to turn on this product.
- 2 Turn on the TV, and select the video input channel on the TV.
- 3 Press **⏏**.
 - ↳ The home menu is displayed.
- 4 Select [**DVB-T Radio**], then press **OK**.
 - ↳ The radio mode is turned on.
- 5 Press **P + -** or the **Numeric buttons** to select a channel.

Use on-screen guide

With this feature, you can view the program schedule and program details.

- 1 Switch this product to the radio mode.
- 2 Refer to the "Use on-screen guide" section in the "Watch TV" chapter.

Use the program edit table

With the program edit table, you can set favorite channels, or adjust channel sequence or delete channels.

- 1 Switch this product to the radio mode.
- 2 Refer to the "Use the program edit table" section in the "Watch TV" chapter.

7 Play

Note

- DVDs and DVD players are designed with regional restrictions. Ensure that the DVD video you play is for the same region zone as this product (indicated on its bottom).
- This product supports the file formats: MP3/JPEG/DivX.
- To play DVD-R, DVD+R or DVD-RW, the disc must be finalized.

Play a disc

Caution

- Do not place any objects other than discs into the disc compartment.

- 1 Press **▲** to open the disc compartment.
- 2 Insert a disc with its label facing up.
- 3 Press **▲** to close the disc compartment and start disc play.
 - To view disc play, turn on the TV to the correct viewing channel for this product.
 - To stop disc play, press **■**.

Play from USB device

Play/view MP3, DivX or JPEG files stored on the USB flash drive.

Note

- If the device does not fit into the USB jack, connect it through a USB extension cable.
- If you connect a multiple USB card/device reader, only one card or device can be accessed.

- 1 Connect a USB flash drive to the  jack.
- 2 Press **▲**.
 - ↳ The home menu is displayed.
- 3 Select **[USB]**, then press **OK**.
 - ↳ The contents menu is displayed.
- 4 Select a file, then press **▶||** to play.
 - ↳ To stop play, press **■**.

Play video

Note

- Some operations may not work with some discs. See the information accompanying the disc for details.

Control video play

- 1 Play a title.
- 2 Use the remote control to control the play.

Button	Action
▶ 	Start, pause or resume disc play.
■	Stop disc play.
◀▶	Skip to a previous/next title or chapter.
◀◀▶▶	Search fast-backward or fast-forward. Press repeatedly to change the search speed.
AUDIO/ CREATE MP3	Select an audio language or channel available on a disc.
SUBTITLE	Select a subtitle language available on a disc.
REPEAT	Select or turn off repeat/random mode. Repeat options may vary from disc type.
REPEAT A-B	Repeat a specific section within a track/disc.
ZOOM (Screen fit)	Fit the picture format to the TV screen. Press repeatedly until the image is scaled to fit to the TV screen.
ZOOM	Toggle between screen aspect ratio and different zoom factor. To pan through the zoomed image, press the Navigation buttons .
INFO	Display the disc play information.

Access DVD menu

- 1 Press **DISC MENU** to access the disc root menu.
- 2 Select a play option, then press **OK**.
 - In some menus, press the **Numeric buttons** to input your selection.

Access VCD menu (PBC)

The PBC (playback control) feature is available for VCD/SVCD. The feature can display the contents menu for you to select an option.

- 1 Insert a VCD/SVCD.
- 2 During disc play, press **DISC MENU** to turn on or off the PBC feature.
 - ↳ If the PBC turns on, the contents menu is displayed for you to select an option.
 - ↳ If the PBC turns off, it skips the menu display and starts to play from the first track.

Repeat play for a specific section

- 1 During play, press **REPEAT A-B** at the start point.
- 2 Press **REPEAT A-B** again to set the end point.
 - ↳ Repeat play starts.
- 3 To cancel repeat play, press **REPEAT A-B** again.



Note

- The marked section for repeat play is only possible within a track/title.

Skip play to a specific point

- 1 During play, press repeatedly **GOTO**.
 - ↳ A search bar is displayed.
- 2 For the title/chapter bar, press **◀▶** to select the title/chapter field, and press **▲▼** to select a title/chapter number.
For the time bar, press the **Numeric buttons** to enter the time to skip to, then press **OK**.

Zoom in/out

- 1 During play, press **ZOOM**, then press repeatedly **OK** to zoom in or out the picture.
- 2 To pan through the enlarged picture, press **▲▼◀▶**.
 - To cancel zoom mode, then press **ZOOM** until [x 1] is displayed.

Play music

Control a track

- 1 Play a track.
- 2 Use the remote control to control the play.

Button	Action
▶ 	Start, pause or resume disc play.
■	Stop disc play.
◀▶	Skip to a previous/next track.
1 2 3 4 5 6 7 8 9 0	Select an item to play.
◀◀▶▶	Searches fast-backward or fast-forward. Press repeatedly to change the search speed.
REPEAT	Select or turn off repeat/random mode. Repeat options may vary from disc type.
REPEAT A-B	For audio CDs only, repeat a specific section within a track.
GOTO	For audio CDs only, skip play to a specific point. Press the numeric buttons on the remote control to enter a track number or time.

Play MP3 music

You can play MP3 audio files (files with .mp3 extension).

- 1 Insert a disc or a USB flash drive that contains MP3 music.
- 2 Press **▲**, and select **[USB]** or **[DVD]**, then press **OK**.
 - ↳ The contents menu is displayed.
- 3 Select a music folder, then press **OK**.
- 4 Select a file to play, then press **OK**.
 - To stop play, press **■**.

Play photo

Play photo as slideshow

You can play JPEG photos (files with .jpeg or .jpg extensions).

- 1 Insert a disc or a USB flash drive that contains the JPEG photos.
- 2 Press **▲**, and select **[DVD]** or **[USB]**, then press **OK**.
 - ↳ The contents menu is displayed.
- 3 Select a photo, then press **▶||** to start slideshow, or press **OK** to display a photo only.
 - During slideshow, press **■** to view the photos in thumbnail view.
 - To exit slideshow, press **↶ BACK**.

Control photo play

- 1 Play a photo slideshow.
- 2 Use the remote control to control the play.

Button	Action
	Rotate a photo anti-clockwise/clockwise.
	Rotate a photo horizontally/vertically.
	Stop a play.

To zoom in/out a photo:

- 1 During a slideshow, press **ZOOM**, and then press repeatedly **OK** to zoom in or out the photo.
- 2 Press to pan through the enlarged photo.

Other features

Create MP3 files

With this product, you can convert audio CDs into MP3 audio files. The created MP3 audio files are saved in the USB flash drive.

- 1 Insert an audio CD.
- 2 Connect a USB flash drive to the jack on this product.
- 3 During disc play, press **AUDIO/CREATE MP3**.
↳ The MP3 creation menu is displayed.
- 4 Select **[Yes]** in the menu, and then press **OK**.
- 5 Select a conversion option in the **[OPTIONS]** panel, and then press **OK** repeatedly to select an item.

Option	Description
[Speed]	Select a copying speed.
[Bitrate]	Select a quality level. Higher bitrate for better sound quality and bigger file size.
[Device]	The created files can only be saved in a USB flash drive.

- 6 Select an audio track, and then press **OK**.
 - To select another track, repeat step 7.
 - To select all tracks, select **[All]** in the menu, and press **OK**.
- 7 Select **[Next]** in the menu, and then press **OK** to start to convert.
↳ Once complete, a new folder is created automatically in the USB flash drive to store all the new MP3 files.

- To exit the menu, select **[Exit]**, and then press **OK**.



Note

- When you convert, never press any button.
- DTS CDs and copy-protected CDs cannot be converted.
- Writer-protected or password-protected USB flash drives cannot be used to store MP3 files.

View files by type

With this feature, you can arrange files in different types on a disc or a USB flash drive for view.

- 1 Insert a disc or a USB flash drive that contains different types of files.
↳ The contents menu is displayed.
- 2 If no file is displayed, open a folder.
- 3 Press to select a logo at the bottom of the contents menu.
 - : display JPEG files only.
 - : display music files only.
 - : display video files only.
 - **ALL**: display all files.
- 4 Press **OK**.
↳ Only files of the type you have selected are displayed.

8 Adjust system setting

General settings

- 1 Press .
↳ The home menu is displayed.
- 2 Select **[System Setting]**, then press **OK**.
- 3 Select **[General Setting]**, then press **OK**.
- 4 Select an option, then press .
- 5 Select a setting, then press **OK**.
 - To return to the previous menu, press **BACK**.
 - To exit the menu, press .

[Language Setup]

- **[OSD Language]** - Select an on-screen menu language.
- **[Audio Language]** - Select an audio language for disc play.
- **[Subtitle Language]** - Select a subtitle language for disc play.

[Video Setup]

- **[TV System]** - Change this setting if the video does not appear correctly. By default, this setting matches the most common setting for TVs in your country.
 - **[NTSC]** - For NTSC-system TV.
 - **[PAL]** - For PAL-system TV.
- **[TV Display]** - Select a display format with which you want the picture to appear on the TV.
 - **[4:3 Pan Scan]** - For 4:3 screen TV: full-height display with the trimmed sides.
 - **[4:3 Letter Box]** - For 4:3 screen TV: wide screen display with black bars on the top and bottom.
 - **[16:9 Wide Screen]** - For wide-screen TV: display picture at ratio 16:9.
 - **[Auto]** - Detect and select the best display format supported by your TV.
- **[Component]** - Select the video output that matches the video connection between this product and the TV.
 - **[RGB]** - Scart (TV OUT) connection.
 - **[Interlaced]** - Component video (Y Pb Pr) connection.
 - **[Progressive]** - If a progressive scan TV is connected to this product, select the progressive scan mode.



Note

- For more detailed description, see "Get started" > "Turn on progressive scan".

- **[Picture Setting]** - Select a predefined set of picture color settings or customize the personal setting.
 - **[Standard]** - Original color setting.
 - **[Bright]** - Vibrant color setting.
 - **[Soft]** - Warm color setting.

[Audio Setup]

- **[Digital Output]** - This setting is only required if you have connected the digital output jack (COAXIAL) of this product to an amplifier/ receiver for audio output.
 - **[PCM]** - Select this setting if the connected device does not support multi-channel format. All audio signals are downmixed to two-channel audio.
 - **[RAW]** - Select this setting if the connected device supports multi-channel format.

- **[Off]** - Disable the digital audio output. Select this setting if the analog audio jacks of this product is connected to a TV or stereo system.
- **[Analogue Output]** - Select an analogue setting based on the audio device that is connected through the analogue audio jack (AUDIO L/R).
 - **[Stereo]** - For the stereo output.
 - **[LT/RT]** - For the surround sound output through two speakers.
- **[HDMI Audio]** - Select the HDMI audio setting when you connect this product and the TV with an HDMI cable.
 - **[On]** - Allow audio output through the TV and the speaker system. If the audio format on the disc is not supported, it will be downmixed to two-channel sound (linear-PCM).
 - **[Off]** - Disable the audio output from HDMI devices connected to this player.

[HDMI Setup]

- **[Resolution]** - Select a video resolution that is compatible with the TV display capability.
 - **[Auto]** - Detect and select the best supported video resolution automatically.
 - **[480i], [480p], [576i], [576p], [720p], [1080i], [1080p]** - Select a video resolution that is best supported by the TV.
- **[EasyLink]** - Turn on/off all EasyLink features.
- **[One Touch Play]** - Turn on or off the feature of one-touch play.

When EasyLink is enabled, press .

- ↳ This product turns on.
- ↳ The TV (if the TV supports one-touch play) automatically turns on and switches to the video-in channel.

- **[One Touch Standby]** - Turn on or off the feature of one-touch standby.

When EasyLink is enabled, press and hold for at least three seconds.

- ↳ All connected HDMI CEC compliant devices switch to standby mode.

Note

- You must turn on the HDMI CEC operations on the TV/ devices before you can enjoy the EasyLink controls. See the TV/devices manual for details.
- Philips does not guarantee 100% interoperability with all HDMI CEC compliant devices.

[Preference Setup]

- **[Change Password]** - Set or change the password for locked programs and discs.
 1. In the **[Old Password]** field, press the **Numeric buttons** to enter the last set password or the default password "0000".
 2. In the **[New Password]** field, enter the new password.
 3. In the **[Confirm]** field, enter the new password again.
 4. Select **[OK]**, then press **OK**.
- **[Auto Standby]** - Turn on/off the auto standby mode.
 - **[On]** - Switch to standby after 15 minutes of inactivity (for example, in pause or stop mode) or 3 hours (in the DVB mode).
 - **[Off]** - Disable the auto standby mode.
- **[Factory setting]** - Reset this product to the factory settings.

1. In the **[Enter Password]** field, enter the last set password or the default password "0000".
2. Select **[OK]**, then press **OK**.

- **[Version Information]** - Display the software version of this product.

Note

- This information is required when you want to find out if a newest software version is available at the Philips website that you may download and install on this product.

DVD/USB settings

Note

- Before you can access **[DVD/USB Setting]**, you must switch to **[DVD]** or **[USB]** mode.

- 1 Press **⏠**.
↳ The home menu is displayed.

- 2 Select **[System Setting]**, then press **OK**.
- 3 Select **[DVD/USB Setting]**, then press **OK**.
- 4 Select an option, then press **▶**.
- 5 Select a setting, then press **OK**.
 - To return to the previous menu, press **↶ BACK**.
 - To exit the menu, press **⏠**.

[Language Setup]

- **[Disc Menu]** - Select a language for a disc menu.
- **[DivX Subtitle]** - Select a character set that supports the DivX subtitle.
 - **[Standard]** - English, Irish, Danish, Estonian, Finnish, French, German, Italian, Portuguese, Luxembourgish, Norwegian (Bokmål and Nynorsk), Spanish, Swedish, Turkish
 - **[Cyrillic]** - Belarusian, Bulgarian, Ukrainian, Macedonian, Russian, Serbian
 - **[Central Europe]** - Polish, Czech, Slovak, Albanian, Hungarian, Slovene, Croatian, Serbian (Latin script), Romanian
 - **[Greek]** - Greek

Note

- Ensure that the subtitle file has the exact same file name as the movie file. If for example the file name of the movie is 'Movie.avi', then you need to name the text file 'Movie.sub' or 'Movie.srt'.

[Custom Setup]

- **[Parental Control]** - Restrict access to discs that are unsuitable for children. This option works only on discs recorded with ratings.

1. Select a rating and press **OK**.
2. Press the **Numeric buttons** to enter "0000" or the last set password.

Note

- Rated discs above the level you set require a password to be played.
- The ratings are country-dependent. To allow all discs to play, select the "8" level for discs.
- Some discs have ratings printed on them but are not recorded with ratings. This function has no effect on such discs.

- **[DivX® VOD]** - Display the DivX® registration code.

**Tip**

- Use this product's DivX registration code when you rent or purchase video from www.divx.com/vod.
- The DivX videos rented or purchased through the DivX® VOD (Video On Demand) service can be played only on the device to which it is registered.

- **[Angle Mark]** - Turn on or off angle mark display.
- **[PBC]** - Turn on or off the content menu of VCDs/SVCDs with PBC (playback control) feature.
 - **[On]** - Display the index menu when you load a disc for play.
 - **[Off]** - Skip the menu and start play from the first track.

TV/Radio settings

**Note**

- Before you can access **[TV/Radio Setting]**, you must switch to **[Live TV]** or **[DVB-T Radio]** mode.

- 1 Press **▲**.
↳ The home menu is displayed.
- 2 Select **[System Setting]**, then press **OK**.
- 3 Select **[TV/Radio Setting]**, then press **OK**.
- 4 Select an option, then press **▶**.
- 5 Select a setting, then press **OK**.
 - To return to the previous menu, press **↶ BACK**.
 - To exit the menu, press **▲**.

[Channel]

- **[TV Channel]** - Set favorite TV channels or delete TV channels (see "Watch TV" > "Use the program edit table").
- **[Radio Channel]** - Set favorite radio channels or delete radio channels (see "Listen to radio" > "Use the program edit table").
- **[Sort]** - Arrange the TV/radio channels in some sequence.
 - **[Auto]** - Sort the channels according to the automatic search.
 - **[By Name]** - Sort the channels by the channel names in the alphabetical order.
 - **[By Service ID]** - Sort the channels according to the service type of the channels.

[Channel Search]

- **[Automatic Search]** - Search and store automatically all the available TV/radio channels. This option overwrites all preset channels.

1. Select **[Automatic Search]**, then press **OK**.
2. Select **[OK]** and press **OK** to start auto search.

- **[Manual Search]** - Search and store manually the available channels. This option adds new channels without changing the current channels list.

1. Select **[Manual Search]**, then press **OK**.
2. Select a channel frequency in the channel list, then press **OK** to start search.

- **[Auto Channel Update]** - Update automatically the channels.
 - **[On (with notification)]** - Enable the automatic channel update with notification.
 - **[On (without notification)]** - Enable the automatic channel update without notification.
 - **[Off]** - Disable the automatic channel update.

[Custom Setup]

- **[Channel Lock]** - Enable or disable the selected channels for restricted viewing.
 - **[Yes]** - Enable the channel lock.
 - **[No]** - Disable the channel lock. To activate this setting, enter "0000" or the last set password.
- **[Parental Setting]** - Lock channels for restricted viewing.

1. Select **[Parental Setting]**, then press **OK**.
2. Press the **Numeric buttons** to enter "0000" or the last set password.
3. Select a program name, then press **OK** to lock.

[Preference Setup]

- **[Country]** - Select the country of your residence.
- **[Time Offset Adjustment]** - Select to adjust automatically or manually the GMT time offset.
- **[Time Zone]** - Select a GMT time offset if you have set **[Time Offset Adjustment]** to manual.
- **[Antenna Power]** - Enable the antenna power if an external antenna is connected.



9 Additional information

Update software

For software updates, check the current software version of this product to compare with the latest software (if available) at the Philips website.

Caution

- Power supply must not be interrupted during software upgrade.

- 1 Press .
- 2 Select [System Setting] > [General Setting] > [Preference Setup] > [Version Information], then press **OK**.
 - ↳ The current software version of this product is displayed.
- 3 Write down the software version number and the model name, then press  to exit the menu.
- 4 Visit www.philips.com/support to check for the latest software version. Use this version number for this product as a reference.
- 5 Refer to the upgrade instructions on the website for more information.

Note

- Disconnect the power cord for a few seconds and connect again to turn on the product.

Care

Caution

- Never use solvents such as benzene, thinner, cleaners available commercially, or anti-static sprays intended for discs.

Clean discs

Wipe the disc with a micro fibre cleaning cloth from the centre to the edge in a straight line movement.

10 Specifications

Note

- Specification and design are subject to change without notice

USB

- Compatibility: USB (2.0)
- Class support: UMS (USB Mass Storage Class)

TV standard

- Number of lines:
 - 625 (PAL/50Hz)
 - 525 (NTSC/60Hz)
- Playback: Multi-standard (PAL/NTSC)

Video performance

- Video DAC: 12 bits, 148 MHz
- Composite video output: 1 Vpp ~ 75 ohm
- Component video output: 0.7 Vpp ~ 75 ohm
- HDMI output: 480i, 480p, 576i, 576p, 720p, 1080i, 1080p
- Scart: Euroconnector

Video format

- Digital compression:
 - MPEG 2: DVD/SVCD
 - MPEG 1: VCD
- Horizontal resolution:
 - DVD: 720 pixels (50 Hz); 720 pixels (60 Hz)
 - VCD: 352 pixels (50 Hz); 352 pixels (60 Hz)
- Vertical resolution:
 - DVD: 576 pixels (50 Hz); 480 pixels (60 Hz)
 - VCD: 288 lines (50 Hz); 240 lines (60 Hz)

Audio

- Analog stereo output
- MPEG MP3: MPEG Audio L3
- Scart output
- Digital output
 - Coaxial
- HDMI output

Audio performance

- DA converter: 24 bits, 192 kHz
- Frequency response: 20 Hz - 20 kHz
- Signal-Noise Ratio : > 90 dB
- Dynamic range @1 kHz (DVB-T mode): > 75 dB
- Dynamic range @1 kHz (DVD mode): > 90 dB
- Crosstalk (DVB-T mode): > 90 dB
- Crosstalk (DVD mode) : > 90 dB
- Distortion/noise (DVB-T mode): > 65 dB
- Distortion/noise (DVD mode): > 90 dB

Tuner/Reception/Transmission

- TV system: PAL
- Aerial Input: 75 Ohm coaxial (IEC75)

Connections

- Antenna input
- Passive RF loopthrough output
- HDMI output
- Component output
- SCART output
- Video output: Cinch (yellow)
- Audio output: Cinch (white/red)
- Digital output:
 - 1 SPDIF coaxial: IEC60958 for CDDA/LPCM
 - IEC61937 for MPEG 1/2, Dolby Digital
- USB input (front panel)

Convenience

- Radio
- Electronic program guide: 7 days
- Teletext

Main Unit

- Dimensions (w x h x d): 360 x 39 x 209 (mm)
- Net Weight: 2.2 kg

Power

- Power supply rating: 230 V; 50 Hz
- Power consumption: 15 W
- Power consumption in standby mode: < 1 W

Accessories supplied

- Remote control and batteries
- AV cables
- User Manual
- Quick Start Guide

Laser specification

- Type: Semiconductor laser InGaAlP (DVD), AlGaAs (CD)
- Wave length: 655 nm (DVD), 790 nm (CD)
- Output Power: 10 mW (DVD), 5 mW (VCD/CD)

11 Troubleshooting

**Warning**

- Risk of electric shock. Never remove the casing of the product.

To keep the warranty valid, never try to repair the product yourself.

If you have problems using this product, check the following points before you request service. If you still have a problem, register your product and get support at www.philips.com/welcome.

If you contact Philips, you will be asked for the model and serial number of your product. The model number and serial number are on the back of your product. Write the numbers here:

Model No. _____

Serial No. _____

Main unit**The buttons on this product do not work.**

- Disconnect this product from the power outlet for a few minutes, then connect again.

No reaction to the remote control.

- Connect this product to the power outlet.
- Point the remote control at the IR sensor located on the front panel of this product.
- Insert the batteries correctly.
- Insert new batteries in the remote control.

Picture**No picture or pictures appear in an improperly way.**

- See the TV's user manual on how to select the correct input on the TV. Change the TV channel until you see the Philips screen.
- If the progressive scan mode is turned on and pictures appear in an improperly way, deselect the progressive scan to turn off the progressive scan mode (see "Adjust system setting" > "General settings" > "Video setup").

No picture on HDMI connection.

- If this product is connected to an unauthorized display device with an HDMI cable, the audio/video signal may not be output.
- Check if the HDMI cable is faulty. Replace a new HDMI cable.
- If this happens when you change the HDMI video resolution, you have to switch to its default mode: 1) Press **▲** to open the disc compartment. 2) Press the numeric button "1".

Sound

No audio output from the TV.

- Ensure that the audio cables are connected to the audio input of the TV.
- Assign the audio input of the TV to the corresponding video input. See the TV user manual for details.

No audio output from the loudspeakers of the audio device (stereo system/amplifier/receiver).

- Ensure that the audio cables are connected to the audio input of the audio device.
- Turn on the audio device to its correct audio input source.

No sound during DivX video playback

- The audio codec may not be supported by this product.

Play

The disc cannot be played.

- The disc is badly scratched, deformed, or dirty. Replace or clean the disc.
- Use the correct disc format or file format.

DivX video files cannot be played.

- Ensure that the DivX video file is complete.
- Ensure that the file name extension is correct.
- Due to Digital Rights issue with the Video content, the content cannot be playback via analog output. To enjoy video, please use HDMI connection for viewing.

The aspect ratio of the screen is not aligned with the TV display setting.

- The aspect ratio is fixed on the disc.

DivX subtitles are not displayed correctly.

- Ensure that the subtitle file name is the same as the movie file name. The file name extension can be .sub, txt, srt, ssa or smi.
- Select the correct character set.
 - Press **▲**.
 - Select **[System Setting] > [DVD/USB Setting] > [Language Setup] > [DivX Subtitle]** in the menu.
 - Select the character set that supports the subtitle.

License Texts and Acknowledgements for any open source software used in this Philips product

Philips Electronics Hong Kong Ltd. hereby offers to deliver, upon request, a copy of the complete corresponding source code for the copyrighted open source software packages used in this product for which such offer is requested by the respective licenses. This offer is valid up to three years after product purchase to anyone in receipt of this information. To obtain source code, please contact open.source@philips.com. If you prefer not to use email or if you do not receive confirmation receipt within a week after mailing to this email address, please write to Open Source Team, Philips Intellectual Property & Standards, P.O. Box 220, 5600 AE Eindhoven, The Netherlands. If you do not receive timely confirmation of your letter, please email to the email address above."

1. eCos

As of May 2002, eCos is released under a modified version of the well known [GNU General Public License \(GPL\)](#). The eCos license is officially recognised as a [GPL-compatible Free Software License](#). An exception clause has been added which limits the circumstances in which the license applies to other code when used in conjunction with eCos. The exception clause is as follows:

As a special exception, if other files instantiate templates or use macros or inline functions from this file, or you compile this file and link it with other works to produce a work based on this file, this file does not by itself cause the resulting work to be covered by the GNU General Public License. However the source code for this file must still be made available in accordance with section (3) of the GNU General Public License.

This exception does not invalidate any other reasons why a work based on this file might be covered by the GNU General Public License.

The goal of the license is to serve the eCos user community as a whole. It allows all eCos users to develop products without paying anybody anything, no matter how many developers are working on the product or how many units will be shipped. The license also guarantees that the eCos source code will always be freely available. This applies not only to the core eCos code itself but also to any changes that anybody makes to the core. In particular, it should prevent any company or individual contributing code to the system and then later claiming that all eCos users are now guilty of copyright or patent infringements and have to pay royalties. It should also prevent any company from making some small improvements, calling the result a completely new system, and releasing this under a new and less generous license.

The license does *not* require users to release the source code of any *applications* that are developed with eCos. However, if anybody makes any changes to code covered by the eCos license, or writes new files derived in any way from eCos code, then we believe that the entire user community should have the opportunity to benefit from this. The license stipulates that these changes must be made available in source code form to all recipients of binaries based on the modified code, either by including the sources along with the binaries you deliver (or with any device containing such binaries) or with a written offer to supply the source code to the general public for three years. It is perhaps most practical for eCos developers to make the source code available online and inform those who are receiving binaries containing eCos code, and probably also the eCos maintainers, about the location of the code. See the [full text of the GPL](#) for the most authoritative definition of the obligations.

Although it is not strictly necessary to contribute the modified code back to the eCos open source project, we are always pleased to receive code [contributions](#) and hope that developers will also be keen to give back in return for what they received from the eCos project completely free of charge. The eCos maintainers are responsible for deciding whether such contributions should be applied to the public repository. In addition, a [copyright assignment](#) is required for any significant changes to the core eCos packages.

The result is a royalty-free system with minimal obligations on the part of application developers. This has resulted in the rapid uptake of eCos. At the same time, eCos is fully open source with all the benefits that implies in terms of quality and innovation. We believe that this is a winning combination.

Questions and answers

The following queries provide some clarification as to the implications of the eCos license. They do not constitute part of the legal meaning of the license.

Q. What is the effect of the eCos license?

A. In the simplest terms, when you distribute anything containing eCos code, you must make the source code to eCos available under the terms of the GPL.

Q. What if I make changes to eCos, or write new code based on eCos code?

A. Then you must make those changes available as well.

Q. Do I have to distribute the source code to my application? Isn't the GPL "viral"?

A. You do not have to distribute any code under the terms of the GPL other than eCos code or code derived from eCos. For example, if you write a HAL port based on copying an existing eCos HAL in any way, you must make the source code available with the binary. However you would not need to make available any other code, such as the code of a wholly separate application linked with eCos.

Q. I would rather stick with the RHEPL code, but I updated my anonymous CVS checkout.

A. You can check out the final version of anonymous CVS before the license change using the CVS tag *last-rhepl*. See [the anonymous CVS access page](#) for details.

Previous license

Prior to May 2002, eCos was released under the [Red Hat eCos Public License \(RHEPL\)](#). The RHEPL required any modifications to eCos code to be made available under preferential terms to Red Hat and was therefore incompatible with code licensed under the GPL. The use of eCos source code which was licensed under the RHEPL is not affected by the switch to the modified GPL for later revisions.

Full eCos license

This is the full text of the license as found on files within eCos covered by the eCos license. It should be read in conjunction with the [GNU General Public License \(GPL\)](#) on which it depends.

This file is part of eCos, the Embedded Configurable Operating System. Copyright (C) 1998, 1999, 2000, 2001, 2002, 2003, 2004, 2005, 2006, 2007, 2008, 2009 Free Software Foundation, Inc.

eCos is free software; you can redistribute it and/or modify it under the terms of the GNU General Public License as published by the Free Software Foundation; either version 2 or (at your option) any later version.

eCos is distributed in the hope that it will be useful, but WITHOUT ANY WARRANTY; without even the implied warranty of MERCHANTABILITY or FITNESS FOR A PARTICULAR PURPOSE. See the GNU General Public License for more details.

You should have received a copy of the GNU General Public License along with eCos; if not, write to the Free Software Foundation, Inc., 51 Franklin Street, Fifth Floor, Boston, MA 02110-1301, USA.

As a special exception, if other files instantiate templates or use macros or inline functions from this file, or you compile this file and link it with other works to produce a work based on this file, this file does not by itself cause the resulting work to be covered by the GNU General Public License. However the source code for this file must still be made available in accordance with section (3) of the GNU General Public License v2.

This exception does not invalidate any other reasons why a work based on this file might be covered by the GNU General Public License.

GNU GENERAL PUBLIC LICENSE

Version 2, June 1991

Copyright (C) 1989, 1991 Free Software Foundation, Inc. 59 Temple Place, Suite 330, Boston, MA 02111-1307 USA Everyone is permitted to copy and distribute verbatim copies of this license document, but changing it is not allowed.

Preamble

The licenses for most software are designed to take away your freedom to share and change it. By contrast, the GNU General Public License is intended to guarantee your freedom to share and change free software—to make sure the software is free for all its users. This General Public License applies to most of the Free Software Foundation's software and to any other program whose authors commit to using it. (Some other Free Software Foundation software is covered by the GNU Library General Public License instead.) You can apply it to your programs, too.

When we speak of free software, we are referring to freedom, not price. Our General Public Licenses are designed to make sure that you have the freedom to distribute copies of free software (and charge for this service if you wish), that you receive source code or can get it if you want it, that you can change the software or use pieces of it in new free programs; and that you know you can do these things.

To protect your rights, we need to make restrictions that forbid anyone to deny you these rights or to ask you to surrender the rights. These restrictions translate to certain responsibilities for you if you distribute copies of the software, or if you modify it.

For example, if you distribute copies of such a program, whether gratis or for a fee, you must give the recipients all the rights that you have. You must make sure that they, too, receive or can get the source code. And you must show them these terms so they know their rights.

We protect your rights with two steps: (1) copyright the software, and (2) offer you this license which gives you legal permission to copy, distribute and/or modify the software.

Also, for each author's protection and ours, we want to make certain that everyone understands that there is no warranty for this free software. If the software is modified by someone else and passed on, we want its recipients to know that what they have is not the original, so that any problems introduced by others will not reflect on the original authors' reputations.

Finally, any free program is threatened constantly by software patents. We wish to avoid the danger that redistributors of a free program will individually obtain patent licenses, in effect making the program proprietary. To prevent this, we have made it clear that any patent must be licensed for everyone's free use or not licensed at all.

The precise terms and conditions for copying, distribution and modification follow.

GNU GENERAL PUBLIC LICENSE

TERMS AND CONDITIONS FOR COPYING, DISTRIBUTION AND MODIFICATION

0. This License applies to any program or other work which contains a notice placed by the copyright holder saying it may be distributed under the terms of this General Public License. The "Program", below, refers to any such program or work, and a "work based on the Program" means either the Program or any derivative work under copyright law: that is to say, a work containing the Program or a portion of it, either verbatim or with modifications and/or translated into another language. (Hereinafter, translation is included without limitation in the term "modification".) Each licensee is addressed as "you".

Activities other than copying, distribution and modification are not covered by this License; they are outside its scope. The act of running the Program is not restricted, and the output from the Program is covered only if its contents constitute a work based on the

Program (independent of having been made by running the Program). Whether that is true depends on what the Program does.

1. You may copy and distribute verbatim copies of the Program's source code as you receive it, in any medium, provided that you conspicuously and appropriately publish on each copy an appropriate copyright notice and disclaimer of warranty; keep intact all the notices that refer to this License and to the absence of any warranty; and give any other recipients of the Program a copy of this License along with the Program.

You may charge a fee for the physical act of transferring a copy, and you may at your option offer warranty protection in exchange for a fee.

2. You may modify your copy or copies of the Program or any portion of it, thus forming a work based on the Program, and copy and distribute such modifications or work under the terms of Section 1 above, provided that you also meet all of these conditions:
 - a) You must cause the modified files to carry prominent notices stating that you changed the files and the date of any change.
 - b) You must cause any work that you distribute or publish, that in whole or in part contains or is derived from the Program or any part thereof, to be licensed as a whole at no charge to all third parties under the terms of this License.
 - c) If the modified program normally reads commands interactively when run, you must cause it, when started running for such interactive use in the most ordinary way, to print or display an announcement including an appropriate copyright notice and a notice that there is no warranty (or else, saying that you provide a warranty) and that users may redistribute the program under these conditions, and telling the user how to view a copy of this License. (Exception: if the Program itself is interactive but does not normally print such an announcement, your work based on the Program is not required to print an announcement.)

These requirements apply to the modified work as a whole. If identifiable sections of that work are not derived from the Program, and can be reasonably considered independent and separate works in themselves, then this License, and its terms, do not apply to those sections when you distribute them as separate works. But when you distribute the same sections as part of a whole which is a work based on the Program, the distribution of the whole must be on the terms of this License, whose permissions for other licensees extend to the entire whole, and thus to each and every part regardless of who wrote it.

Thus, it is not the intent of this section to claim rights or contest your rights to work written entirely by you; rather, the intent is to exercise the right to control the distribution of derivative or collective works based on the Program.

In addition, mere aggregation of another work not based on the Program with the Program (or with a work based on the Program) on a volume of a storage or distribution medium does not bring the other work under the scope of this License.

3. You may copy and distribute the Program (or a work based on it, under Section 2) in object code or executable form under the terms of Sections 1 and 2 above provided that you also do one of the following:
 - a) Accompany it with the complete corresponding machine-readable source code, which must be distributed under the terms of Sections 1 and 2 above on a medium customarily used for software interchange; or,
 - b) Accompany it with a written offer, valid for at least three years, to give any third party, for a charge no more than your cost of physically performing source distribution, a complete machine-readable copy of the corresponding source code, to be distributed under the terms of Sections 1 and 2 above on a medium customarily used for software interchange; or,
 - c) Accompany it with the information you received as to the offer to distribute corresponding source code. (This alternative is allowed only for noncommercial distribution and only if you received the program in object code or executable form with such an offer, in accord with Subsection b above.)

The source code for a work means the preferred form of the work for making modifications to it. For an executable work, complete source code means all the source code for all modules it contains, plus any associated interface definition files, plus the scripts used to control compilation and installation of the executable. However, as a special exception, the source code distributed need not include anything that is normally distributed (in either source or binary form) with the major components (compiler, kernel, and so on) of the operating system on which the executable runs, unless that component itself accompanies the executable.

If distribution of executable or object code is made by offering access to copy from a designated place, then offering equivalent access to copy the source code from the same place counts as distribution of the source code, even though third parties are not compelled to copy the source along with the object code.

4. You may not copy, modify, sublicense, or distribute the Program except as expressly provided under this License. Any attempt otherwise to copy, modify, sublicense or distribute the Program is void, and will automatically terminate your rights under this License. However, parties who have received copies, or rights, from you under this License will not have their licenses terminated so long as such parties remain in full compliance.
5. You are not required to accept this License, since you have not signed it. However, nothing else grants you permission to modify or distribute the Program or its derivative works. These actions are prohibited by law if you do not accept this License. Therefore, by modifying or distributing the Program (or any work based on the Program), you indicate your acceptance of this License to do so, and all its terms and conditions for copying, distributing or modifying the Program or works based on it.
6. Each time you redistribute the Program (or any work based on the Program), the recipient automatically receives a license from the original licensor to copy, distribute or modify the Program subject to these terms and conditions. You may not impose any further restrictions on the recipients' exercise of the rights granted herein. You are not responsible for enforcing compliance by third parties to this License.
7. If, as a consequence of a court judgment or allegation of patent infringement or for any other reason (not limited to patent issues), conditions are imposed on you (whether by court order, agreement or otherwise) that contradict the conditions of this License, they do not excuse you from the conditions of this License. If you cannot distribute so as to satisfy simultaneously your obligations under this License and any other pertinent obligations, then as a consequence you may not distribute the Program at all. For example, if a patent license would not permit royalty-free redistribution of the Program by all those who receive copies directly or indirectly through you, then the only way you could satisfy both it and this License would be to refrain entirely from distribution of the Program.

If any portion of this section is held invalid or unenforceable under any particular circumstance, the balance of the section is intended to apply and the section as a whole is intended to apply in other circumstances.

It is not the purpose of this section to induce you to infringe any patents or other property right claims or to contest validity of any such claims; this section has the sole purpose of protecting the integrity of the free software distribution system, which is implemented by public license practices. Many people have made generous contributions to the wide range of software distributed through that system in reliance on consistent application of that system; it is up to the author/donor to decide if he or she is willing to distribute software through any other system and a licensee cannot impose that choice.

This section is intended to make thoroughly clear what is believed to be a consequence of the rest of this License.

8. If the distribution and/or use of the Program is restricted in certain countries either by patents or by copyrighted interfaces, the original copyright holder who places the Program under this License may add an explicit geographical distribution limitation excluding those countries, so that distribution is permitted only in or among countries not thus excluded. In such case, this License incorporates the limitation as if written in the body of this License.

9. The Free Software Foundation may publish revised and/or new versions of the General Public License from time to time. Such new versions will be similar in spirit to the present version, but may differ in detail to address new problems or concerns.

Each version is given a distinguishing version number. If the Program specifies a version number of this License which applies to it and "any later version", you have the option of following the terms and conditions either of that version or of any later version published by the Free Software Foundation. If the Program does not specify a version number of this License, you may choose any version ever published by the Free Software Foundation.

10. If you wish to incorporate parts of the Program into other free programs whose distribution conditions are different, write to the author to ask for permission. For software which is copyrighted by the Free Software Foundation, write to the Free Software Foundation; we sometimes make exceptions for this. Our decision will be guided by the two goals of preserving the free status of all derivatives of our free software and of promoting the sharing and reuse of software generally.

NO WARRANTY

11. BECAUSE THE PROGRAM IS LICENSED FREE OF CHARGE, THERE IS NO WARRANTY FOR THE PROGRAM, TO THE EXTENT PERMITTED BY APPLICABLE LAW. EXCEPT WHEN OTHERWISE STATED IN WRITING THE COPYRIGHT HOLDERS AND/OR OTHER PARTIES PROVIDE THE PROGRAM "AS IS" WITHOUT WARRANTY OF ANY KIND, EITHER EXPRESSED OR IMPLIED, INCLUDING, BUT NOT LIMITED TO, THE IMPLIED WARRANTIES OF MERCHANTABILITY AND FITNESS FOR A PARTICULAR PURPOSE. THE ENTIRE RISK AS TO THE QUALITY AND PERFORMANCE OF THE PROGRAM IS WITH YOU. SHOULD THE PROGRAM PROVE DEFECTIVE, YOU ASSUME THE COST OF ALL NECESSARY SERVICING, REPAIR OR CORRECTION.
12. IN NO EVENT UNLESS REQUIRED BY APPLICABLE LAW OR AGREED TO IN WRITING WILL ANY COPYRIGHT HOLDER, OR ANY OTHER PARTY WHO MAY MODIFY AND/OR REDISTRIBUTE THE PROGRAM AS PERMITTED ABOVE, BE LIABLE TO YOU FOR DAMAGES, INCLUDING ANY GENERAL, SPECIAL, INCIDENTAL OR CONSEQUENTIAL DAMAGES ARISING OUT OF THE USE OR INABILITY TO USE THE PROGRAM (INCLUDING BUT NOT LIMITED TO LOSS OF DATA OR DATA BEING RENDERED INACCURATE OR LOSSES SUSTAINED BY YOU OR THIRD PARTIES OR A FAILURE OF THE PROGRAM TO OPERATE WITH ANY OTHER PROGRAMS), EVEN IF SUCH HOLDER OR OTHER PARTY HAS BEEN ADVISED OF THE POSSIBILITY OF SUCH DAMAGES.

END OF TERMS AND CONDITIONS

How to Apply These Terms to Your New Programs

If you develop a new program, and you want it to be of the greatest possible use to the public, the best way to achieve this is to make it free software which everyone can redistribute and change under these terms.

To do so, attach the following notices to the program. It is safest to attach them to the start of each source file to most effectively convey the exclusion of warranty; and each file should have at least the "copyright" line and a pointer to where the full notice is found.

<one line to give the program's name and a brief idea of what it does.> Copyright (C) <year> <name of author>

This program is free software; you can redistribute it and/or modify it under the terms of the GNU General Public License as published by the Free Software Foundation; either version 2 of the License, or (at your option) any later version.

This program is distributed in the hope that it will be useful, but WITHOUT ANY WARRANTY; without even the implied warranty of MERCHANTABILITY or FITNESS FOR A PARTICULAR PURPOSE. See the GNU General Public License for more details.

You should have received a copy of the GNU General Public License along with this program; if not, write to the Free Software Foundation, Inc., 59 Temple Place, Suite 330, Boston, MA 02111-1307 USA

Also add information on how to contact you by electronic and paper mail.

If the program is interactive, make it output a short notice like this when it starts in an interactive mode:

```
Gnomovision version 69, Copyright (C) year name of author Gnomovision comes with ABSOLUTELY NO
WARRANTY; for details type `show w'. This is free software, and you are welcome to redistribute it under
certain conditions; type `show c' for details.
```

The hypothetical commands `show w' and `show c' should show the appropriate parts of the General Public License. Of course, the commands you use may be called something other than `show w' and `show c'; they could even be mouse-clicks or menu items--whatever suits your program.

You should also get your employer (if you work as a programmer) or your school, if any, to sign a "copyright disclaimer" for the program, if necessary. Here is a sample; alter the names:

```
Yoyodyne, Inc., hereby disclaims all copyright interest in the program
```

```
`Gnomovision' (which makes passes at compilers) written by James Hacker.
```

```
<signature of Ty Coon>, 1 April 1989
```

```
Ty Coon, President of Vice
```

This General Public License does not permit incorporating your program into proprietary programs. If your program is a subroutine library, you may consider it more useful to permit linking proprietary applications with the library. If this is what you want to do, use the GNU Library General Public License instead of this License.

2. libgcc

GCC is free software; you can redistribute it and/or modify it under the terms of the GNU General Public License as published by the Free Software Foundation; either version 2, or (at your option) any later version. In addition to the permissions in the GNU General Public License, the Free Software Foundation gives you unlimited permission to link the compiled version of this file with other programs, and to distribute those programs without any restriction coming from the use of this file. (The General Public License restrictions do apply in other respects; for example, they cover modification of the file, and distribution when not linked into another program.)

GNU LIBRARY GENERAL PUBLIC LICENSE

Version 2, June 1991

Copyright (C) 1991 Free Software Foundation, Inc. 59 Temple Place - Suite 330, Boston, MA 02111-1307, USA
Everyone is permitted to copy and distribute verbatim copies of this license document, but changing it is not allowed.

[This is the first released version of the library GPL. It is numbered 2 because it goes with version 2 of the ordinary GPL.]

Preamble

The licenses for most software are designed to take away your freedom to share and change it. By contrast, the GNU General Public Licenses are intended to guarantee your freedom to share and change free software--to make sure the software is free for all its users.

This license, the Library General Public License, applies to some specially designated Free Software Foundation software, and to any other libraries whose authors decide to use it. You can use it for your libraries, too.

When we speak of free software, we are referring to freedom, not price. Our General Public Licenses are designed to make sure that you have the freedom to distribute copies of free software (and charge for this service if you wish), that you receive source code or can get it if you want it, that you can change the software or use pieces of it in new free programs; and that you know you can do these things.

To protect your rights, we need to make restrictions that forbid anyone to deny you these rights or to ask you to surrender the rights. These restrictions translate to certain responsibilities for you if you distribute copies of the library, or if you modify it.

For example, if you distribute copies of the library, whether gratis or for a fee, you must give the recipients all the rights that we gave you. You must make sure that they, too, receive or can get the source code. If you link a program with the library, you must provide complete object files to the recipients so that they can relink them with the library, after making changes to the library and recompiling it. And you must show them these terms so they know their rights.

Our method of protecting your rights has two steps: (1) copyright the library, and (2) offer you this license which gives you legal permission to copy, distribute and/or modify the library.

Also, for each distributor's protection, we want to make certain that everyone understands that there is no warranty for this free library. If the library is modified by someone else and passed on, we want its recipients to know that what they have is not the original version, so that any problems introduced by others will not reflect on the original authors' reputations.

Finally, any free program is threatened constantly by software patents. We wish to avoid the danger that companies distributing free software will individually obtain patent licenses, thus in effect transforming the program into proprietary software. To prevent this, we have made it clear that any patent must be licensed for everyone's free use or not licensed at all.

Most GNU software, including some libraries, is covered by the ordinary GNU General Public License, which was designed for utility programs. This license, the GNU Library General Public License, applies to certain designated libraries. This license is quite different from the ordinary one; be sure to read it in full, and don't assume that anything in it is the same as in the ordinary license.

The reason we have a separate public license for some libraries is that they blur the distinction we usually make between modifying or adding to a program and simply using it. Linking a program with a library, without changing the library, is in some sense simply using the library, and is analogous to running a utility program or application program. However, in a textual and legal sense, the linked executable is a combined work, a derivative of the original library, and the ordinary General Public License treats it as such.

Because of this blurred distinction, using the ordinary General Public License for libraries did not effectively promote software sharing, because most developers did not use the libraries. We concluded that weaker conditions might promote sharing better.

However, unrestricted linking of non-free programs would deprive the users of those programs of all benefit from the free status of the libraries themselves. This Library General Public License is intended to permit developers of non-free programs to use free libraries, while preserving your freedom as a user of such programs to change the free libraries that are incorporated in them. (We have not seen how to achieve this as regards changes in header files, but we have achieved it as regards changes in the actual functions of the Library.) The hope is that this will lead to faster development of free libraries.

The precise terms and conditions for copying, distribution and modification follow. Pay close attention to the difference between a "work based on the library" and a "work that uses the library". The former contains code derived from the library, while the latter only works together with the library.

Note that it is possible for a library to be covered by the ordinary General Public License rather than by this special one.

GNU LIBRARY GENERAL PUBLIC LICENSE

TERMS AND CONDITIONS FOR COPYING, DISTRIBUTION AND MODIFICATION

0. This License Agreement applies to any software library which contains a notice placed by the copyright holder or other authorized party saying it may be distributed under the terms of this Library General Public License (also called "this License"). Each licensee is addressed as "you".

A "library" means a collection of software functions and/or data prepared so as to be conveniently linked with application programs (which use some of those functions and data) to form executables.

The "Library", below, refers to any such software library or work which has been distributed under these terms. A "work based on the Library" means either the Library or any derivative work under copyright law: that is to say, a work containing the Library or a portion of it, either verbatim or with modifications and/or translated straightforwardly into another language. (Hereinafter, translation is included without limitation in the term "modification".)

"Source code" for a work means the preferred form of the work for making modifications to it. For a library, complete source code means all the source code for all modules it contains, plus any associated interface definition files, plus the scripts used to control compilation and installation of the library.

Activities other than copying, distribution and modification are not covered by this License; they are outside its scope. The act of running a program using the Library is not restricted, and output from such a program is covered only if its contents constitute a work based on the Library (independent of the use of the Library in a tool for writing it). Whether that is true depends on what the Library does and what the program that uses the Library does.

1. You may copy and distribute verbatim copies of the Library's complete source code as you receive it, in any medium, provided that you conspicuously and appropriately publish on each copy an appropriate copyright notice and disclaimer of warranty; keep intact all the notices that refer to this License and to the absence of any warranty; and distribute a copy of this License along with the Library.

You may charge a fee for the physical act of transferring a copy, and you may at your option offer warranty protection in exchange for a fee.

2. You may modify your copy or copies of the Library or any portion of it, thus forming a work based on the Library, and copy and distribute such modifications or work under the terms of Section 1 above, provided that you also meet all of these conditions:
 - a) The modified work must itself be a software library.
 - b) You must cause the files modified to carry prominent notices stating that you changed the files and the date of any change.
 - c) You must cause the whole of the work to be licensed at no charge to all third parties under the terms of this License.
 - d) If a facility in the modified Library refers to a function or a table of data to be supplied by an application program that uses the facility, other than as an argument passed when the facility is invoked, then you must make a good faith effort to ensure that, in the event an application does not supply such function or table, the facility still operates, and performs whatever part of its purpose remains meaningful.

(For example, a function in a library to compute square roots has a purpose that is entirely well-defined independent of the application. Therefore, Subsection 2d requires that any application-supplied function or table used by this function must be optional: if the application does not supply it, the square root function must still compute square roots.)

These requirements apply to the modified work as a whole. If identifiable sections of that work are not derived from the Library, and can be reasonably considered independent and separate works in themselves, then this License, and its terms, do not apply to those sections when you distribute them as separate works. But when you distribute the same sections as part of a whole which is a work based on the Library, the distribution of the whole must be on the terms of this License, whose permissions for other licensees extend to the entire whole, and thus to each and every part regardless of who wrote it.

Thus, it is not the intent of this section to claim rights or contest your rights to work written entirely by you; rather, the intent is to exercise the right to control the distribution of derivative or collective works based on the Library.

In addition, mere aggregation of another work not based on the Library with the Library (or with a work based on the Library) on a volume of a storage or distribution medium does not bring the other work under the scope of this License.

3. You may opt to apply the terms of the ordinary GNU General Public License instead of this License to a given copy of the Library. To do this, you must alter all the notices that refer to this License, so that they refer to the ordinary GNU General Public License, version 2, instead of to this License. (If a newer version than version 2 of the ordinary GNU General Public License has appeared, then you can specify that version instead if you wish.) Do not make any other change in these notices.

Once this change is made in a given copy, it is irreversible for that copy, so the ordinary GNU General Public License applies to all subsequent copies and derivative works made from that copy.

This option is useful when you wish to copy part of the code of the Library into a program that is not a library.

4. You may copy and distribute the Library (or a portion or derivative of it, under Section 2) in object code or executable form under the terms of Sections 1 and 2 above provided that you accompany it with the complete corresponding machine-readable source code, which must be distributed under the terms of Sections 1 and 2 above on a medium customarily used for software interchange.

If distribution of object code is made by offering access to copy from a designated place, then offering equivalent access to copy the source code from the same place satisfies the requirement to distribute the source code, even though third parties are not compelled to copy the source along with the object code.

5. A program that contains no derivative of any portion of the Library, but is designed to work with the Library by being compiled or linked with it, is called a “work that uses the Library”. Such a work, in isolation, is not a derivative work of the Library, and therefore falls outside the scope of this License.

However, linking a “work that uses the Library” with the Library creates an executable that is a derivative of the Library (because it contains portions of the Library), rather than a “work that uses the library”. The executable is therefore covered by this License. Section 6 states terms for distribution of such executables.

When a “work that uses the Library” uses material from a header file that is part of the Library, the object code for the work may be a derivative work of the Library even though the source code is not. Whether this is true is especially significant if the work can be linked without the Library, or if the work is itself a library. The threshold for this to be true is not precisely defined by law.

If such an object file uses only numerical parameters, data structure layouts and accessors, and small macros and small inline functions (ten lines or less in length), then the use of the object file is unrestricted, regardless of whether it is legally a derivative work. (Executables containing this object code plus portions of the Library will still fall under Section 6.)

Otherwise, if the work is a derivative of the Library, you may distribute the object code for the work under the terms of Section 6. Any executables containing that work also fall under Section 6, whether or not they are linked directly with the Library itself.

6. As an exception to the Sections above, you may also compile or link a “work that uses the Library” with the Library to produce a work containing portions of the Library, and distribute that work under terms of your choice, provided that the terms permit modification of the work for the customer’s own use and reverse engineering for debugging such modifications.

You must give prominent notice with each copy of the work that the Library is used in it and that the Library and its use are covered by this License. You must supply a copy of this License. If the work during execution displays copyright notices, you must include the copyright notice for the Library among them, as well as a reference directing the user to the copy of this License. Also, you must do one of these things:

- a) Accompany the work with the complete corresponding machine-readable source code for the Library including whatever changes were used in the work (which must be distributed under Sections 1 and 2 above); and, if the work is an executable linked with the Library, with the complete machine-readable

“work that uses the Library”, as object code and/or source code, so that the user can modify the Library and then relink to produce a modified executable containing the modified Library. (It is understood that the user who changes the contents of definitions files in the Library will not necessarily be able to recompile the application to use the modified definitions.)

- b) Accompany the work with a written offer, valid for at least three years, to give the same user the materials specified in Subsection 6a, above, for a charge no more than the cost of performing this distribution.
- c) If distribution of the work is made by offering access to copy from a designated place, offer equivalent access to copy the above specified materials from the same place.
- d) Verify that the user has already received a copy of these materials or that you have already sent this user a copy.

For an executable, the required form of the “work that uses the Library” must include any data and utility programs needed for reproducing the executable from it. However, as a special exception, the source code distributed need not include anything that is normally distributed (in either source or binary form) with the major components (compiler, kernel, and so on) of the operating system on which the executable runs, unless that component itself accompanies the executable.

It may happen that this requirement contradicts the license restrictions of other proprietary libraries that do not normally accompany the operating system. Such a contradiction means you cannot use both them and the Library together in an executable that you distribute.

7. You may place library facilities that are a work based on the Library side-by-side in a single library together with other library facilities not covered by this License, and distribute such a combined library, provided that the separate distribution of the work based on the Library and of the other library facilities is otherwise permitted, and provided that you do these two things:
 - a) Accompany the combined library with a copy of the same work based on the Library, uncombined with any other library facilities. This must be distributed under the terms of the Sections above.
 - b) Give prominent notice with the combined library of the fact that part of it is a work based on the Library, and explaining where to find the accompanying uncombined form of the same work.
8. You may not copy, modify, sublicense, link with, or distribute the Library except as expressly provided under this License. Any attempt otherwise to copy, modify, sublicense, link with, or distribute the Library is void, and will automatically terminate your rights under this License. However, parties who have received copies, or rights, from you under this License will not have their licenses terminated so long as such parties remain in full compliance.
9. You are not required to accept this License, since you have not signed it. However, nothing else grants you permission to modify or distribute the Library or its derivative works. These actions are prohibited by law if you do not accept this License. Therefore, by modifying or distributing the Library (or any work based on the Library), you indicate your acceptance of this License to do so, and all its terms and conditions for copying, distributing or modifying the Library or works based on it.
10. Each time you redistribute the Library (or any work based on the Library), the recipient automatically receives a license from the original licensor to copy, distribute, link with or modify the Library subject to these terms and conditions. You may not impose any further restrictions on the recipients' exercise of the rights granted herein. You are not responsible for enforcing compliance by third parties to this License.
11. If, as a consequence of a court judgment or allegation of patent infringement or for any other reason (not limited to patent issues), conditions are imposed on you (whether by court order, agreement or otherwise) that contradict the conditions of this License, they do not excuse you from the conditions of this License. If you cannot distribute so as to satisfy simultaneously your obligations under this License and any other pertinent obligations, then as a consequence you may not distribute the Library at all. For example, if a

patent license would not permit royalty-free redistribution of the Library by all those who receive copies directly or indirectly through you, then the only way you could satisfy both it and this License would be to refrain entirely from distribution of the Library.

If any portion of this section is held invalid or unenforceable under any particular circumstance, the balance of the section is intended to apply, and the section as a whole is intended to apply in other circumstances.

It is not the purpose of this section to induce you to infringe any patents or other property right claims or to contest validity of any such claims; this section has the sole purpose of protecting the integrity of the free software distribution system which is implemented by public license practices. Many people have made generous contributions to the wide range of software distributed through that system in reliance on consistent application of that system; it is up to the author/donor to decide if he or she is willing to distribute software through any other system and a licensee cannot impose that choice.

This section is intended to make thoroughly clear what is believed to be a consequence of the rest of this License.

12. If the distribution and/or use of the Library is restricted in certain countries either by patents or by copyrighted interfaces, the original copyright holder who places the Library under this License may add an explicit geographical distribution limitation excluding those countries, so that distribution is permitted only in or among countries not thus excluded. In such case, this License incorporates the limitation as if written in the body of this License.
13. The Free Software Foundation may publish revised and/or new versions of the Library General Public License from time to time. Such new versions will be similar in spirit to the present version, but may differ in detail to address new problems or concerns.

Each version is given a distinguishing version number. If the Library specifies a version number of this License which applies to it and "any later version", you have the option of following the terms and conditions either of that version or of any later version published by the Free Software Foundation. If the Library does not specify a license version number, you may choose any version ever published by the Free Software Foundation.

14. If you wish to incorporate parts of the Library into other free programs whose distribution conditions are incompatible with these, write to the author to ask for permission. For software which is copyrighted by the Free Software Foundation, write to the Free Software Foundation; we sometimes make exceptions for this. Our decision will be guided by the two goals of preserving the free status of all derivatives of our free software and of promoting the sharing and reuse of software generally.

NO WARRANTY

15. BECAUSE THE LIBRARY IS LICENSED FREE OF CHARGE, THERE IS NO WARRANTY FOR THE LIBRARY, TO THE EXTENT PERMITTED BY APPLICABLE LAW. EXCEPT WHEN OTHERWISE STATED IN WRITING THE COPYRIGHT HOLDERS AND/OR OTHER PARTIES PROVIDE THE LIBRARY "AS IS" WITHOUT WARRANTY OF ANY KIND, EITHER EXPRESSED OR IMPLIED, INCLUDING, BUT NOT LIMITED TO, THE IMPLIED WARRANTIES OF MERCHANTABILITY AND FITNESS FOR A PARTICULAR PURPOSE. THE ENTIRE RISK AS TO THE QUALITY AND PERFORMANCE OF THE LIBRARY IS WITH YOU. SHOULD THE LIBRARY PROVE DEFECTIVE, YOU ASSUME THE COST OF ALL NECESSARY SERVICING, REPAIR OR CORRECTION.
16. IN NO EVENT UNLESS REQUIRED BY APPLICABLE LAW OR AGREED TO IN WRITING WILL ANY COPYRIGHT HOLDER, OR ANY OTHER PARTY WHO MAY MODIFY AND/OR REDISTRIBUTE THE LIBRARY AS PERMITTED ABOVE, BE LIABLE TO YOU FOR DAMAGES, INCLUDING ANY GENERAL, SPECIAL, INCIDENTAL OR CONSEQUENTIAL DAMAGES ARISING OUT OF THE USE OR INABILITY TO USE THE LIBRARY (INCLUDING BUT NOT LIMITED TO LOSS OF DATA OR DATA BEING RENDERED INACCURATE OR LOSSES SUSTAINED BY YOU OR THIRD PARTIES OR A FAILURE OF THE LIBRARY TO OPERATE WITH ANY OTHER SOFTWARE), EVEN IF SUCH HOLDER OR OTHER PARTY HAS BEEN ADVISED OF THE POSSIBILITY OF SUCH DAMAGES.

END OF TERMS AND CONDITIONS

Appendix: How to Apply These Terms to Your New Libraries

If you develop a new library, and you want it to be of the greatest possible use to the public, we recommend making it free software that everyone can redistribute and change. You can do so by permitting redistribution under these terms (or, alternatively, under the terms of the ordinary General Public License).

To apply these terms, attach the following notices to the library. It is safest to attach them to the start of each source file to most effectively convey the exclusion of warranty; and each file should have at least the "copyright" line and a pointer to where the full notice is found.

<one line to give the library's name and a brief idea of what it does.>

Copyright (C) <year> <name of author>

This library is free software; you can redistribute it and/or modify it under the terms of the GNU Library General Public License as published by the Free Software Foundation; either version 2 of the License, or (at your option) any later version.

This library is distributed in the hope that it will be useful, but WITHOUT ANY WARRANTY; without even the implied warranty of MERCHANTABILITY or FITNESS FOR A PARTICULAR PURPOSE. See the GNU Library General Public License for more details.

You should have received a copy of the GNU Library General Public License along with this library; if not, write to the Free Software Foundation, Inc., 59 Temple Place - Suite 330, Boston, MA 02111-1307, USA

Also add information on how to contact you by electronic and paper mail.

You should also get your employer (if you work as a programmer) or your school, if any, to sign a "copyright disclaimer" for the library, if necessary. Here is a sample; alter the names:

Yoyodyne, Inc., hereby disclaims all copyright interest in the library 'Frob' (a library for tweaking knobs) written by James Random Hacker.

<signature of Ty Coon>, 1 April 1990

Ty Coon, President of Vice

That's all there is to it!



© 2010 Koninklijke Philips Electronics N.V.
All rights reserved.
DTP4800_31_UM_V2.1_1019

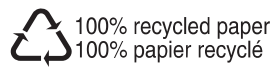

Free Manuals Download Website

<http://myh66.com>

<http://usermanuals.us>

<http://www.somanuals.com>

<http://www.4manuals.cc>

<http://www.manual-lib.com>

<http://www.404manual.com>

<http://www.luxmanual.com>

<http://aubethermostatmanual.com>

Golf course search by state

<http://golfingnear.com>

Email search by domain

<http://emailbydomain.com>

Auto manuals search

<http://auto.somanuals.com>

TV manuals search

<http://tv.somanuals.com>