



DVD-E370
DVD-E365
DVD-E360K
DVD-E360
DVD-E350

DVD Player

User Manual

imagine the possibilities

Thank you for purchasing this Samsung product.

To receive more complete service, please register your product at

www.samsung.com/register



Precautions

1. Setting up

- Refer to the identification label located on the rear of your player for its proper operating voltage.
- Install your player in a cabinet with adequate ventilation holes. (7-10cm). Do not block ventilation holes on any of the components for air circulation.
- Do not push the disc tray in by hand.
- Do not stack components.
- Be sure to turn all components off before moving the player.
- Before connecting other components to this player, be sure to turn them off.
- Be sure to remove the disc and turn off the player after use, especially if you are not going to use it for a long time.
- The mains plug is used as a disconnect device and shall stay readily operable at any time.

2. For your safety

- This product utilizes a laser. Use of controls or adjustments or performance of procedures other than those specified herein may result in hazardous radiation exposure.
- Do not open covers and do not repair your self. Refer servicing to qualified personal.

3. Caution

- Your player is not intended for industrial use but for domestic purposes. Use of this product is for personal use only.
- Apparatus shall not be exposed to dripping or splashing and no objects filled with liquids, such as vases, shall be placed on the apparatus.
- Exterior influences such as lightning and static electricity can affect normal operation of this player. If this occurs, turn the player off and on again with the POWER button, or disconnect and then reconnect the AC power cord to the AC power outlet. The player will operate normally.
- When condensation forms inside the player due to sharp changes in temperature,

the player may not operate correctly. If this occurs, leave the player at room temperature until the inside of the player becomes dry and operational.

4. Disc

- Do not clean disc using record-cleaning sprays, benzene, thinner, or other volatile solvents that may cause damage to the disc surface.
- Do not touch the disc's bottom. Hold by the edges or by one edge and the hole in the center.
- Wipe the dirt away gently; never wipe a cloth back and forth over the disc.

5. Environmental info

- The battery used in this product contains chemicals that are harmful to the environment.
- So, dispose the batteries in the proper manner, according to federal, state, and local regulations.

The product unit accompanied this user manual is licenced under certain intellectual property rights of certain third parties. This licence is limited to private non-commercial use by end-user consumers for licenced contents. No rights are granted for commercial use. The licence does not cover any product unit other than this product unit and the licence does not extend to any unlicensed product unit or process conforming to ISO/OUR 11172-3 or ISO/OUR 13818-3 used or sold in combination with this product unit. The licence only covers the use of this product unit to encode and/or decode audio files conforming to the ISO/OUR 11172-3 or ISO/OUR 13818-3. No rights are granted under this licence for product features or functions that do not conform to the ISO/OUR 11172-3 or ISO/OUR 13818-3.

CAUTION: USE OF ANY CONTROLS, ADJUSTMENTS, OR PROCEDURES OTHER THAN SPECIFIED HEREIN MAY RESULT IN HAZARDOUS RADIATION EXPOSURE

Table of contents

Precautions	2	Folder Selection	8
Setup		MP3/WMA/CD Audio Playback	8
General Features	2	MPEG4 Playback	9
Description	3	Playing Media Files using the USB HOST feature (Only DVD-E370, E360K, E360)	9
Tour of the Remote Control	4	CD Ripping (Only DVD-E370, E360K, E360)	10
Connections		Picture CD Playback	10
Choosing a Connection	4	Karaoke Functions (Only DVD-E360K)	
Basic Functions		Karaoke Functions	11
Playing a Disc	6	Changing Setup Menu	
Using the Search and Skip Functions	6	Using the Setup Menu	11
Using the Display Function	6	Setting Up the Display Options	11
Using the Disc and Title Menu	6	Setting Up the Audio Options	12
Repeat Play	6	Setting Up the System Options	12
Slow Play	7	Setting Up the Language Features	12
Advanced Functions		Setting Up the Security Options	12
Adjusting the Aspect Ratio (EZ View)	7	Setting Up the General Options	13
Selecting the Audio Language	7	Setting Up the Support Options	13
Selecting the Subtitle Language	7	Reference	
Changing the Camera Angle	7	Troubleshooting	13
Using the Bookmark Function	7	Specifications	14
Using the Zoom Function	8		
Clips Menu for MP3/WMA/JPEG/MPEG4/CD Audio	8		

Setup

General Features

Excellent Sound

Dolby Digital, a technology developed by Dolby Laboratories, provides crystal clear sound reproduction.

Screen

Both regular and widescreen(16:9) pictures can be viewed.

Slow Motion

An important scene can be viewed in slow motion.

Parental Control (DVD)

The parental control allows users to set the necessary level to prohibit children from viewing harmful movies such as those with violence, adult subject matter, etc.

Various On-Screen Menu Functions

You can select various languages (Audio/Subtitle) and screen angles while enjoying movies.

Progressive Scan

Progressive scanning creates an improved picture with double the scan lines of a conventional inter-laced picture

EZ VIEW (DVD)

Easy View enables picture adjustment to match your TV's screen size (16:9 or 4:3).

Digital Photo Viewer (JPEG)

You can view Digital Photos on your TV.

Repeat

You can repeat a song or movie simply by pressing the REPEAT button

MP3/WMA

This unit can play discs contain MP3/WMA files.

MPEG4

This unit can play MPEG4 formats within an avi file.

CD Ripping

(Only DVD-E370, E360K, E360)

This feature lets you to copy audio files from disc to USB device into MP3 format. (Only Audio CD (CD DA)).

Note

- Discs which cannot be played with this player.
 - DVD-ROM
 - CD-ROM
 - CDI
 - DVD-ROM
 - CDV
 - CVD
- Ability to play back may depend on recording conditions.
 - DVD-R, +R
 - CD-RW
 - DVD+RW, -RW (V mode)
- The unit may not play certain CD-R, CD-RW and DVD-R due to the disc type or recording conditions.

COPY PROTECTION

Many DVD discs are encoded with copy protection. Because of this, you should only connect your DVD player directly to your TV, not to a VCR. Connecting to a VCR results in a distorted picture from copy-protected DVD discs.

This item incorporates copy protection technology that is protected by U.S. patents and other intellectual property rights of Rovi Corporation. Reverse engineering and disassembly are prohibited.

PROGRESSIVE SCAN OUTPUTS (576p)

"CONSUMERS SHOULD NOTE THAT NOT ALL HIGH DEFINITION TELEVISION SETS ARE FULLY COMPATIBLE WITH THIS PRODUCT AND MAY CAUSE ARTIFACTS TO BE DISPLAYED IN THE PICTURE, IN CASE OF 576 PROGRESSIVE SCAN PICTURE PROBLEMS, IT IS RECOMMENDED THAT THE USER SWITCH THE CONNECTION TO THE 'STANDARD DEFINITION' OUTPUT. IF THERE ARE QUESTIONS REGARDING YOUR TV SET COMPATIBILITY WITH THIS MODEL 576p DVD PLAYER, PLEASE CONTACT SAMSUNG'S CUSTOMER SERVICE CENTER."

CLASS 1 LASER PRODUCT

This Compact Disc player is classified as a CLASS 1 LASER product. Use of controls, adjustments or performance of procedures

other than those specified herein may result in hazardous radiation exposure.

CAUTION :

CLASS 3B VISIBLE AND INVISIBLE LASER RADIATION WHEN OPEN. AVOID EXPOSURE TO THE BEAM (IEC 60825-1).

THIS PRODUCT UTILIZES A LASER. USE OF CONTROLS OR ADJUSTMENTS OR PERFORMANCE OF PROCEDURES OTHER THAN THOSE SPECIFIED HEREIN MAY RESULT IN HAZARDOUS RADIATION EXPOSURE. DO NOT OPEN COVER AND DO NOT REPAIR YOURSELF. REFER SERVICING TO QUALIFIED PERSONNEL.

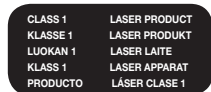

Disc Markings

	Play Region Number
	PAL broadcast system in U.K, France, Germany, etc.
	Dolby Digital disc
	Stereo disc
	Digital Audio disc
	MP3 disc

Region Number

Both the DVD player and the discs are coded by region. These regional codes must match in order for the disc to play. If the codes does not match, the disc will not play.

The Region Number for this player is described on the rear panel of the player.

DivX Certification

DivX®, DivX Certified® and associated logos are trademarks of Rovi Corporation or its subsidiaries and are used under license. ABOUT DIVX VIDEO : DivX® is a digital video



format created by DivX, LLC, a subsidiary of Rovi Corporation.

This is an official DivX Certified® device that plays DivX video. Visit www.divx.com for more information and software tools to convert your files into DivX video.

ABOUT DIVX VIDEO-ON-DEMAND : This DivX Certified® device must be registered in order to play purchased DivX Video-on-Demand (VOD)

movies. To obtain your registration code, locate the DivX VOD section in your device setup menu. Go to vod.divx.com for more information on how to complete your registration.

"DivX Certified to play DivX video, including premium content."

Covered by one or more of the following U.S patents : 7,295,673; 7,460,668; 7,515,710; 7,519,274.

Description

Front Panel Controls



- 1. DISC TRAY**
Place the disc here.
- 2. DISPLAY**
Operation indicators are displayed here.
- 3. OPEN/CLOSE (▲)**
Press to open and close the disc tray.
- 4. PLAY/PAUSE (▶||)**
Play or pause the disc.
- 5. POWER ON/OFF (⏻)**
Turn on/off and the player is turned on/off.
- 6. USB HOST (Only DVD-E370, E360K, E360)**
Connect digital still camera, MP3 player, memory stick, Card reader other removable storage devices.
- 7. MIC (Only DVD-E360K)**
Connect Microphone for karaoke functions.

Tour of the Remote Control

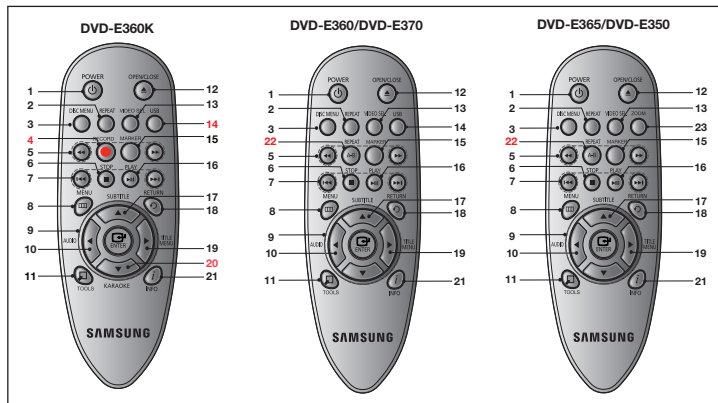

1. DVD POWER Button

Turns the power on or off.

2. REPEAT Button

Allows you to repeat play a title, chapter, track, or disc.

3. DISC MENU Button

Brings up the Disc menu.

4. RECORD Button (Only DVD-E360K)

Use to Karaoke recording.

5. SEARCH Buttons (◀/▶)

Allows you to search forward/backward through a disc.

6. STOP Button (■)

To stop the disc

7. SKIP Buttons (◀/▶)

Use to skip the title, chapter or track.

8. MENU Button

Brings up the DVD player's menu.

9. ENTER/▲/▼, ◀/▶ Buttons

This button functions as a toggle switch.

10. AUDIO Button (◀)

Use this button to access various audio functions on a disc.

11. TOOLS Button

Displays the current disc mode. It also lets you access the Display function.

12. OPEN/CLOSE (▲) Button

To open and close the disc tray.

13. VIDEO SEL. Button

Changes video output mode.

14. USB Button

(Only DVD-E370, E360K, E360)
To change device which access to USB device.

15. MARKER Button

PLAY Button (▶||)

Begins disc play.

17. SUBTITLE/(▲) Button

18. RETURN Button

Returns to a previous menu

19. TITLE MENU Button (▶)

Brings up the Title menu.

20. KARAOKE (▼) Button

(Only DVD-E360K)
To access karaoke menu (keycon, mic volume, echo).

21. INFO Button

Used to displays playback info banner.

22. REPEAT A-B Button (Only DVD-E370, E365, E360, E350)

Allows you to repeat A-B disc.

23. ZOOM Button

(Only DVD-E365, E350)
Enlarges the DVD Picture.

Connections

Choosing a Connection

The following shows examples of connections commonly used to connect the DVD player with a TV and other components.

Before Connecting the DVD Player

- Always turn off the DVD player, TV, and other components before you connect or disconnect any cables.
- Refer to the user's manual of the additional components you are connecting for more information on those particular components.

A. Connecting to a TV (For Video)

1. Using video/audio cables, connect the **VIDEO (yellow)/AUDIO (red and white) OUT** terminals on the rear of the DVD player to the **VIDEO (yellow)/AUDIO (red and white) IN** terminals of TV.
2. Turn on the DVD player and TV.
3. Press the input selector on your TV remote control until the Video signal from the DVD player appears on the TV screen.

Note

- **Noise may be generated if the audio cable is too close to the power cable.**
- If you want to connect to an Amplifier, please refer to the Amplifier connection page.
- The number and position of terminals can vary depending on your TV set. Please refer to the user's manual of the TV.
- If there is one audio input terminal on the TV, connect it to the [AUDIO OUT][left] (white) terminal of the DVD player.
- If you press the VIDEO SEL. button when DVD Player is in stop mode or no disc is inserted, the Video Output mode changes in the following sequence: (I-SCAN → P-SCAN)

B. Connection to a TV (Interlace/Progressive)

1. Using component video cables, connect the **COMPONENT VIDEO OUT** terminal on the rear of the DVD player to the **COMPONENT IN** terminal of TV.
2. Using the audio cables, connect the **AUDIO (red and white) OUT** terminals on the rear of the DVD player to the **AUDIO (red and white) IN** terminals of TV. Turn on the DVD player and TV.
3. Press the input selector on your TV remote control until the Component signal from the DVD player appears on the TV screen.
4. Set the Video Output to **I-SCAN/P-SCAN** in the Display Setup menu. You can use the **VIDEO SEL.** button to change the Video Output mode.

Note

- What is "Progressive Scan"?

Progressive scan has twice as many scanning lines as the interlace output method has. Progressive scanning method can provide better and clearer picture quality.

C. Connection to an Audio System (2 Channel Amplifier, Dolby Digital, or MPEG2)

1. Using the audio cables, connect the **AUDIO (red and white) OUT** terminals on the rear of the DVD player to the **AUDIO (red and white) IN** terminals of the Amplifier. If using a coaxial cable,

connect the **DIGITAL AUDIO OUT (COAXIAL)** terminal on the rear of the DVD player to the **DIGITAL AUDIO IN (COAXIAL)** terminal of the Amplifier.

- Using the video signal cable(s), connect the **VIDEO, COMPONENT OUT** terminals on the rear of the DVD player to the **VIDEO, COMPONENT IN** terminals of your TV
- Turn on the DVD player, TV, and Amplifier.
- Press the input select button of the Amplifier to select **external input** in order to hear sound from the DVD player. Refer to your Amplifier's user manual to set the Amplifier's audio input.

D. Connection to a 5.1CH Analog Amplifier (ONLY DVD-E365, E370)

- If using audio cables for 5.1 CH Analog Amplifier (not included) connect the **5.1CH ANALOG AUDIO OUT** terminals on the rear of the DVD player to the **5.1CH ANALOG AUDIO IN** terminals of the 5.1CH Analog Amplifier.
- Using the video signal cable(s), connect the **VIDEO** or **COMPONENT** terminals on the rear of the DVD player to the **VIDEO** or **COMPONENT** terminals of your TV as described on pages.
- Turn on the DVD player, TV, and Amplifier.
- Press the input select button of the Amplifier to select **external input** in order to hear sound from the DVD player.

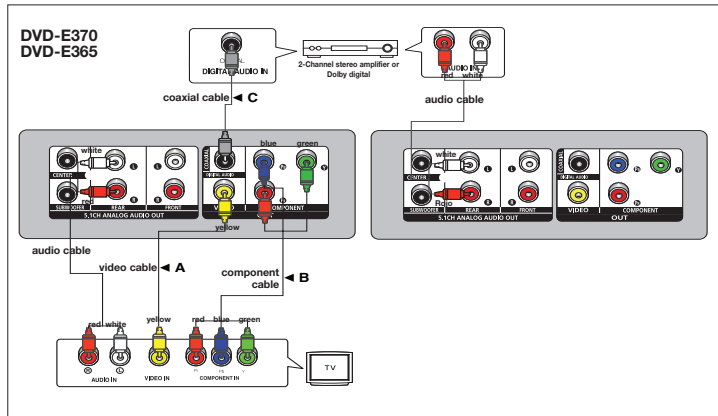
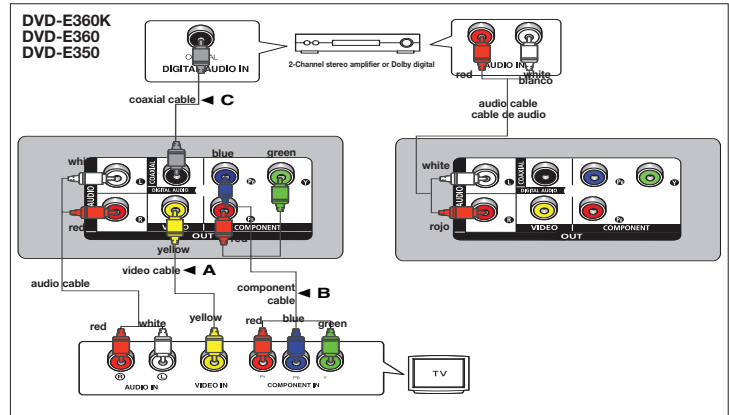
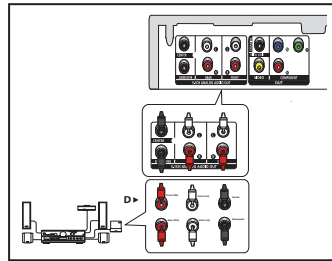

Basic functions

Playing a Disc

Before Play

- Turn on your TV and set it to the correct Video Input by pressing TV/VIDEO button on the TV remote control.
- If you connected an external Audio System, turn on your Audio System and set it to the correct Audio Input.

After plugging in the player, the first time you press the DVD POWER button, this screen comes up: If you want to select a language, press the ▲/▼ button, and then press the **ENTER** button. (This screen will only appear when you plug in the player for the first time.) If the language for the startup screen is not set, the set-tings may change whenever you turn the power on or off. Therefore, make sure that you select the language you want to use. Once you select a menu language, you can change it by pressing the ►|| button on the front panel of the unit for more than 5 seconds with no disc in the unit. Then the **SELECT MENU LANGUAGE** window appears again where you can reset your preferred language.

Using the Search and Skip Functions

During play, you can search quickly through a chapter or track, and use the skip function to jump to the next selection.

Searching through a Chapter or Track

During play, press the SEARCH (◀◀ or ▶▶) button on the remote control for more than 1 second.

DVD	2X, 4X, 8X, 16X, 32X
CD	2X, 4X, 8X, 16X, 32X
VCD	4X, 8X

Note

- The speed marked in this function may be different from the actual playback speed.
- No sound is hearing during search mode (Except CD).

Skipping Tracks

During play, press the SKIP (◀◀ or ▶▶) button.









- When playing a DVD, if you press the SKIP (▶▶) button, it moves to the next chapter. If you press the SKIP (◀◀) button, it moves to the beginning of the chapter. One more press makes it move to the beginning of the previous chapter.
- When playing a VCD, if you press the SKIP (▶▶) button, it moves to the next track. If you press the SKIP (◀◀) button, it moves to the beginning of the track. One more press makes it move to the beginning of the previous track.
- If a track exceeds 15 minutes when playing a VCD and you press the ▶▶| button, it moves forward 5 minutes. If you press the |◀◀ button, it moves to the beginning of the track. One more press makes it move to the beginning of the previous track.

Using the Display Function

When Playing a DVD/VCD/MPEG4

1. During play, press the **TOOLS** button on the remote control.
2. Press the ▲/▼ buttons to select the desired item.
3. Press the ◀/▶ buttons to make the desired setup.
4. To make the screen disappear, press the **TOOLS** button again.

The functions when using the Display function are listed in the table below.

	To access the desired title when there is more than one in the disc. For example, if there is more than one movie on a DVD, each movie will be identified.
	Most DVD discs are recorded in chapters so that you can quickly find a specific passage.
	Allows playback of the film from a desired time. You must enter the starting time as a reference. The time search function does not operate on some discs.
	Lets you select the soundtrack language for a film. A DVD disc can have up to eight different soundtracks.
	Lets you select the subtitle language or, if you prefer, turn off subtitles. A DVD disc can have up to 32 different sets of subtitles, each in a different language.
	Lets you choose the EZ-View type
	Select to activate the Zoom function.
	Some DVDs have scenes that have been recorded at multiple angles. Use the Angle function to view a scene at one of those angles.

Using the Disc and Title Menu

During the playback of a DVD disc, press the **DISC MENU/TITLE MENU** button on the remote control.

Note

- Depending on a disc, the Disc Menu/Title Menu may not work.
- You can also use the Disc Menu, using the DISC MENU button on the remote control.
- Title Menu will only be displayed if there are at least two titles in the disc.

Repeat Play

Repeat the current track, chapter, title, a chosen section (A-B), or all of the disc.

When playing a DVD/VCD

1. Press the **REPEAT** button on the remote control. Repeat screen appears.
2. Press the **REPEAT** or ▲/▼ button to change playback mode. DVD repeats play by chapter or title.
 - Off.
 - Title : repeats the title that is playing.
 - Chapter : repeats the chapter that is playing.
 - Repeat A-B

Using the A-B Repeat function (Only DVD-E360K)

1. Press the REPEAT button on the remote control. The repeat screen appears.
2. Press the ▲/▼ button to select the REPEAT A-B and then press ENTER.
3. Press the ENTER at the point where you want repeat play to start (A).
4. Press the ENTER at the point where you want repeat play to start (B).

Using the A-B Repeat function (Only DVD-E370,E365, E360,E530)

1. Press the REPEAT A-B button on the remote control.
2. Press the REPEAT A-B button at the point where you want repeat play to start (A).
3. Press the REPEAT A-B button at the point where you want the repeat play to stop (B).
3. To return to normal play, press the REPEAT A-B button until the display shows Repeat : Off.

Note

- A-B REPEAT allows you to set point (B) directly after point (A) has been set.
- Depending on a disc, the Repeat function may not work.

Slow Play

This feature allows you slowly to repeat scenes containing sports, dancing, musical instruments being played etc., so you can study them more closely.

When playing a DVD

1. During play, press the PLAY (▶||) button.
2. Press the SEARCH (◀◀▶▶) button to choose the play speed between 1/2, 1/4, 1/8, 1/16 and so on. If you want to go normal play press PLAY button.

Advanced functions

Adjusting the Aspect Ratio (EZ View)

To play back using aspect ratio (DVD)

1. During play, press the TOOLS button on the remote control.
2. Press the ▲/▼ buttons to select  icon. Each time you press the ◀/▶ buttons, the screen size changes. For graphics of the screen sizes and lists of the sequences in which the sizes change, see the next column.
3. Press the RETURN button to exit EZ View.

If you are using a 16:9 TV

For 16:9 aspect ratio discs

- WIDE SCREEN
- SCREEN FIT
- ZOOM FIT

For 4:3 aspect ratio discs

- Normal Wide
- SCREEN FIT
- ZOOM FIT
- Vertical Fit

If you are using a 4:3 TV

For 16:9 aspect ratio discs

- 4:3 Letter Box
- 4:3 Pan Scan
- SCREEN FIT
- ZOOM FIT

For 4:3 aspect ratio discs

- Normal Screen
- SCREEN FIT
- ZOOM FIT

Note

This function may behave differently depending on the type of disc.

Selecting the Audio Language

You can select a desired audio language quickly and easily with the AUDIO button.

Using the AUDIO (◀) button (DVD/VCD/MPEG4)

1. During play, Press the AUDIO (◀) button. Change the audio language by pressing the ▲/▼ button.
 - The audio languages are represented by abbreviations.
2. To remove the AUDIO icon, press the RETURN button.

Note

- This function depends on audio languages are encoded on the disc and may not work.
- A DVD disc can contain up to 8 audio languages.

Selecting the Subtitle Language

You can select a desired subtitle quickly and easily with the SUBTITLE(▲) button.

Using the SUBTITLE (▲) button (DVD/MPEG4)

1. During play, Press the SUBTITLE (▲) button.
2. Press the SUBTITLE (▲) or ▲/▼ button to change the language. Each time you press the SUBTITLE (▲) or ▲/▼ button, the language changes.
3. To remove the SUBTITLE icon, press the RETURN button.

Note

- The subtitle languages are represented by abbreviations.
- You have to change the desired subtitle in the Disc Menu, according to discs. Press the DISC MENU button.
- This function depends on what subtitles are encoded on the disc and may not work on all DVDs.
- A DVD disc can contain up to 32 subtitle languages.

Changing the Camera Angle

When a DVD contains multiple angles of a particular scene, you can use the ANGLE function.

Using the ANGLE function (DVD)

If the disc contains multiple angles, the ANGLE appears on the screen.

1. During play, press the TOOLS button on the remote control.
2. Press the ▲/▼ buttons to select  icon. When the angle screen is displayed, press the ◀/▶ buttons on the remote control to select the desired angle option.

Using the Bookmark Function

This feature lets you bookmark sections of a DVD or VCD (Menu Off mode) so you can quickly find them at a later time.

Using the Bookmark Function (DVD/VCD)

1. During play, press the MARKER button on the remote control.
2. When you reach the scene you want to mark, press the ◀/▶ or ▲/▼ buttons, and then press MARKER button. Up to 12 scenes may be marked at a time.

Note

- Depending on a disc, the Bookmark function may not work.

Recalling a Marked Scene

1. During play, press the **MARKER** button on the remote control.
2. Press the ◀/▶ or ▲/▼ buttons to select a marked scene.
3. Press the **PLAY** (▶||) button to skip to the marked scene.

Clearing a Bookmark

1. During play, press the **MARKER** button on the remote control.
2. Press the ◀/▶ or ▲/▼ buttons to select the bookmark number you want to delete.
3. Press the **ENTER** button to delete a bookmark number.

Using the Zoom Function

- Using the Zoom Function (DVD-E365, E350)

1. During play or pause mode, press the **ZOOM** button on the remote control.

- Using the Zoom Function (DVD-E370,E360K,E360)

1. During play or pause mode, press the **TOOLS** buttons on the remote control.
2. Press the ▲/▼ buttons to select  icon, then press the **ENTER** button.
 - During DVD play, press ENTER to zoom in 1X/2X/3X/4X Normal in order.

Clips Menu for MP3/WMA/JPEG/MPEG4/CD Audio

CD Audio or discs with MP3/WMA/JPEG/MPEG4 contain individual songs and/or pictures that can be organized into folders as shown below. They are similar to how you use your computer to put files into different folders.

To go access these folders and the files in them, follow these steps :

1. Open the disc tray. Place the disc on the tray.
2. Close the tray. The tray closes and the Parent Folder Menu screen appears (top screen image.) Parent folders contain all the Peer folders that have the same kind of content: music, video, photos, etc.
3. Press the ◀/▶ buttons to select the Parent folder of your choice, and then press the **ENTER**. A screen displaying the Peer folders appears. The Peer folders contain all the folders with the same kind of content (video, music, photos, etc.) that are in the Parent folder.

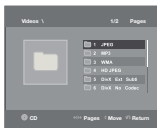

Folder Selection

The folder can be selected both in Stop or Play mode.

- To select the Parent Folder

Press the **RETURN** button to go to parent folder, or press the ▲/▼ buttons to select “..” and press **ENTER** to go to the parent folder.

- To select the Peer Folder

Press the ▲/▼ buttons to select the desired folder, then press **ENTER**.

- To select the Sub-Folder

Press the ▲/▼ buttons to select the desired folder, then press **ENTER**.

MP3/WMA/CD Audio Playback

1. Open the disc tray. Place the disc on the tray. Close the tray.
2. Press the ◀/▶ buttons to select a Music folder, and then press **ENTER**. Press the ▲/▼ buttons to select a song file, and then press the **ENTER** to begin playback of the song.

Repeat/Random playback

Press the **REPEAT** button to change the playback mode. There are four modes, such as **Off**, **Track**, **Folder** and **Random**.

- Off (⇒): Normal Playback

- Track (□□): Repeats the current song file.

- Folder (■): Repeats the song files which have the same extension in the current folder.

- Random (⊘): Song files which have the same extension will be played in random order.

To resume normal play, press the **REPEAT** button until the Repeat : Off.

CD-R MP3/WMA file

When you record MP3 or WMA files on CD-R, please refer to the following.

- **Your MP3 or WMA files should be ISO 9660 or JOLIET format.**

ISO 9660 format and Joliet MP3 or WMA files are compatible with Microsoft's DOS and Windows, and with Apple's Mac. This format is the most widely used.

- **When naming your MP3 or WMA files, do not exceed 8 characters, and enter “.mp3, .wma” as the file extension.** General name format : Title.mp3. or Title.wma. When composing your title, make sure that you use 8 characters or less, have no spaces in the name, and avoid the use of special characters including: (./\,=,+).

- **Use a decompression transfer rate of at least 128 Kbps when recording MP3 files.**

Sound quality with MP3 files basically depends on the rate of compression/decompression you choose. Getting CD audio sound requires an analog/digital sampling rate, that is conversion to MP3 format, of at least 128 Kbps and up to 160 Kbps. However, choosing higher rates, like 192 Kbps or more, only rarely give better sound quality. Conversely, files with decompression rates below 128 Kbps will not be played properly.

- **Use a decompression transfer rate of at least 64Kbps when recording WMA files.**

Sound quality with WMA files basically depends on the rate of compression/decompression you choose. Getting CD audio sound requires an analog/digital sampling rate, that is conversion to WMA format, of at least 64Kbps and up to 192Kbps. Conversely, files with decompression rates below 64Kbps or over 192Kbps will not be played properly. Sampling rate that can be supported for WMA files is > 30KHz.

- **Do not try recording copyright protected MP3 files.**

Certain “secured” files are encrypted and code protected to prevent illegal copying. These files are of the following types: Windows Media™ (registered trade mark of Microsoft Inc) and SDMI™ (registered trade mark of The SDMI Foundation). You cannot copy such files.

- **Important:**

The above recommendations cannot be taken as a guarantee that the DVD player will play MP3 recordings, or as an assurance of sound quality. You should note that certain technologies and methods for MP3 file recording on CD-Rs prevent optimal playback of these files on your DVD player (degraded sound quality and in some cases, inability of the player to read the files).

- This unit can play a maximum of 500 files and 500 folders per disc.

MPEG4 Playback

MPEG4 Play Function

AVI files are used to contain the audio and video data. Only AVI format files with the ".avi" extensions can be played.

1. Open the disc tray. Place the disc on the tray. Close the tray.
2. Press the ◀▶ buttons to select a Videos Menu , then press the ENTER. Press the ▲/▼ to select an avi file (DivX) then press the ENTER.

Repeat and Repeat A-B playback

1. Press the REPEAT button , then press REPEAT or ▲/▼ buttons to change playback mode. There are 3 modes, such as Off, Title and Folder.
 - Off : No Repeat mode.
 - Title : repeats the title that is playing.
 - Folder : repeats the AVI files which have the same extension in the current folder.
 - Repeat A-B

Repeat A-B playback (Only DVD-E360K)

1. Press the REPEAT button on the remote control. The repeat screen appears.
2. Press the ▲/▼ button to select the REPEAT A-B and then press ENTER.
3. Press the ENTER at the point where you want repeat play to start (A).
4. Press the ENTER at the point where you want repeat play to stop (B).

Repeat A-B playback (Only DVD-E370, E360, E365, E350)

1. Press the REPEAT A-B button on the remote control.
 2. Press the REPEAT A-B button at the point where you want repeat play to start (A).
 3. Press the REPEAT A-B button at the point where you want the repeat play to stop (B)
- To return to normal play, press the REPEAT A-B button until the display shows Repeat : Off.

Note

- A-B REPEAT allow you to set point (B) directly after point (A) has been set.

MPEG4 Function Description

Function	Description
Skip (◀◀ or ▶▶)	During play, press the ◀◀ or ▶▶ button, it moves to next or previous track.
Search (◀◀ or ▶▶)	During play, press the SEARCH (◀◀ or ▶▶) button and press again to search at a faster speed. Allows you to search at a faster speed in an AVI file. (2X, 4X, 8X, 16X, 32X)
Slow Motion Play	During play, press the PLAY ((◀)◀) button, and then press the SEARCH (▶▶) button to view video at a slower speed. (1/2, 1/4, 1/8, 1/16)
ZOOM	X1/X2/X3/X4/Normal in order

- These functions may not work depending on MPEG4 file.

CD-R AVI fileThis

unit can play the following video compression

formats within the AVI file format:

- DivX 3.11 contents

- DivX 4 contents (Based on MPEG-4 Simple Profile)

- DivX 5 contents (MPEG-4 simple profile plus additional features such as bi-directional frames.

Qpel and GMC are also supported.)

DVD-RW & DVD+R

Format that support for DivX file :

- Basic DivX format DivX3.11 / 4.12/ 5.x
- DivX Pro
- File format : *.avi, *.div, *.divx.

This unit supports all resolutions up to maximum below.

DivX5
720 x 480 @30fps
720 x 576 @25fps:
Maximum bitrate : 4Mbps

Note

- The resolution that can be supported by DVD-E370,E360K,E360,E365,E350 model up to 720 x 480 @30 frames/ 720 x 576 @25 frames.
- This unit supports CD-R/RW written in MPEG4 in accordance with the "ISO9660 format".

Playing Media Files Using the USB Host feature (Only DVD-E370, E360K, E360)

You can enjoy the media files such as pictures, movies and tunes saved in an MP3 player, USB memory or digital camera in high audio by connecting the storage device to the USB port of the DVD Player.

Using the USB HOST feature

1. Connect the USB device to the USB port on the front of the unit.
2. The USB Menu screen appears. Press the ◀▶ button to select Menu, then press ENTER.
3. Press the ▲/▼ buttons to select a file in the USB device. Press ENTER to Open the file.

Switching Between DVD and USB

If you have a disk in the player, and you are viewing or listening to files on a USB device, or the USB Menu is on the screen, you can switch from the USB device to the disc by pressing the USB button on the remote.

Also, you can switch from the disc to the USB device by pressing the USB button on the remote. "USB loading..." appears on the screen, and then the USB Menu appears.

Note

- Depends on the file size and clip duration, loading time on USB may take longer than using CD or DVD media.

Safe USB Removal

1. Press the USB button to return to disc mode or the main screen.
2. Press the STOP (■) button
3. Remove the USB cable.

Skip Forward/Back

During playback, press the (◀◀▶▶) button.

- When there is more than one file, when you press the ▶▶ button, the next file is selected.
- When there is more than one file, when you press the ◀◀ button, the previous file is selected.

Fast playback

To play back the disc at a faster speed, press (◀▶) during playback

- Each time you press either button, the playback speed will change as follows : 2X → 4X → 8X → 16X → 32X.

Compatible Devices

1. USB devices that support USB Mass Storage v1.0.(USB devices that operate as a removable disk in Windows (2000 or later) without additional driver installation.)
2. MP3 Player: Flash type MP3 player.
3. Digital camera: Cameras that support USB Mass Storage v1.0.
 - Cameras that operate as a removable disk in Windows (2000 or later) without additional driver installation.
4. USB Flash Drive: Devices that support USB2.0 or USB1.1.
 - You may experience a difference in playback quality when you connect a USB1.1 device.
5. USB card Reader: One slot USB card reader and Multi slot USB card reader
 - Depending on the manufacturer, the USB card reader may not be supported.
 - If you install multiple memory devices into a multi card reader, you may experience problems.
6. If you use a USB extension cable, the USB device might not be recognized.

Note

- CBI (Control/Bulk/Interrupt) is not supported.
- Digital Cameras that use PTP protocol or require additional program installation when connected to a PC are not supported.
- A device using NTFS file system is not supported. (Only FAT 16/32 (File Allocation Table 16/32) file system is supported.)
- Some MP3 players, when connected to this product, may not operate depending on the sector size of their file system.
- The USB HOST function is not supported if a product that transfers media files by its manufacturer-specific program is connected.
- Does not operate with Janus enabled MTP(Media Transfer Protocol) devices.
- The USB host function of this product does not support all USB devices.
- The USB Host does not support USB Hard Disc Drives (HDD).

CD Ripping (Only DVD-E370, E360K, E360)

This feature allows you to copy audio files from a disc to a USB device in MP3 format.

Open the disc tray. Place the Audio CD(CD DA) disc on the tray, and close the tray. Connect the USB device to the USB port on the front of the unit. Press the USB button.

1. Press the **TOOLS** button to display the Ripping screen.
2. Press the ▲/▼ buttons, then press the **ENTER** button to select files for ripping.
 - To deselect files, press ENTER button again.
3. Press the ◀ and ▼ button to select **START**, then press the **ENTER** button begin ripping. The Ripping menu contain the following buttons :
 - Mode (Fast/Normal)
 - Bitrate, press ENTER to change : 128kbps → 192kbps → 128kbps.
 - Standard : 128kbps
 - Better Quality : 192kbps
 - Device selection, press ENTER to change between partitions on the USB device (max 4).
 - Select - Unselect, press ENTER to change from Select all (files) or Select none.

Note

- To cancel copying in progress, press the **ENTER** button.
- To return to the CD/DA screen, press the **TOOLS** button again.
- While the CD is being ripped, the player will automatically enter stop mode.
- The ripping process is 2.6 times of normal speed.
- The DVD player can only rip Audio CD (CD DA) discs.
- The USB button does not work while you're in the Ripping menu.
- CD ripping function may not supported for some MP3 players device.

Picture CD Playback

1. Select the desired folder.
2. Press the ▲/▼ buttons to select a Picture file in the clips menu and then press the **ENTER** button.

Note

- Press the **STOP** button to return to the clips menu.
- When playing a Kodak Picture CD, the unit displays the Photo directly, not the clips menu.

Rotation

- Press the **TOOLS** button to select Rotate, and then press the **ENTER** button.
- Each time the ◀/▶ buttons are pressed, the picture rotates 90 degrees clockwise.
- Each time the ▲ button is pressed, the picture will reverse to the upside down to show a mirror image.
- Each time the ▼ button is pressed, the picture will reverse to the right side to show a mirror image.

Zoom

- Press the **TOOLS** button to select Zoom, and then press the **ENTER** button.
- Each time **ENTER** button is pressed, the picture is enlarged. Zoom mode : X1-X2-X3-X4-X1.
- Press the ◀/▶/▲/▼ buttons to move the enlarged picture so you can view different portions.

Slide Show

- When you press the **PLAY** at JPEG file, it will go to full screen mode and automatically slide show.

Note

- Depending on a file size, the amount of time between each picture may be different from the manual.
- If you don't press any button, the slide show will start automatically in about 10 seconds by default.

CD-R JPEG Disc

- Only files with the ".jpg" and ".JPG" extensions can be played.
- If the disc is not closed, it will take longer to start playing and not all of the recorded files may be played.
- Only CD-R discs with JPEG files in ISO 9660 or Joliet format can be played.
- The name of the JPEG file may not be longer than 8 characters and should contain no blank spaces or special characters (. / = +).
- Only a consecutively written multi-session disc can be played. If there is a blank segment in the multi-session disc, the disc can be played only up to the blank segment.
- A maximum of 500 images can be stored on a single CD.
- Kodak Picture CDs are recommended.
- When playing a Kodak Picture CD, only the JPEG files in the pictures folder can be played.
- Kodak Picture CD: The JPEG files in the pictures folder can be played automatically.

- Konica Picture CD: If you want to see the Picture, select the JPEG files in the clips menu.
- Fuji Picture CD: If you want to see the Picture, select the JPEG files in the clips menu.
- QSS Picture CD: The unit may not play QSS Picture CD.
- If the number of files in 1 Disc is over 500, only 500 JPEG files can be played.
- If the number of folders in 1 Disc is over 500, only JPEG files in 500 folders can be played.

Karaoke functions (Only DVD-E360K)

Karaoke Functions

Operation Sequence

1. Connect the terminals Mixed Audio Out to TV or Amplifier.
2. Connect the microphone plug to Mic (microphone) and set Karaoke score to On. When MIC is connected and Karaoke score is On, the karaoke functions can be used.

Echo/Microphone Volume/Key Control (Tone control)

1. Play the karaoke disc containing the songs you want.
 - Press the **KARAOKE** (▼) button, and then press ▲/▼ to select **ECHO, VOL** or **KEY**.
2. Press the ◀/▶ buttons to change the desired item.

Karaoke Scoring (Score)

The scoring will appear as :

1. The microphone is connected and Karaoke score is On.
2. At the end of each chapter/title of karaoke disc.
 - If the DVD karaoke have any information on the scoring drive.
 - In case of VCD, the device can not differentiate between hard karaoke or movies, then the scoring will always appear.
3. Karaoke score will appear at the end of time for each chapter/title for about 6s.

Karaoke Sound Recording

1. Insert USB storage media into USB jack and then connected the microphone plug to Mic.
2. To star karaoke recording, choose one of VCD/DVD/SVCD file, then press **RECORD** button.
3. When recording, user can only press **STOP** button and **PAUSE** button to cancel the recording.
4. If user do cancelation, then file result will be saved.

Note

- If you hear feedback(squealing or howling) while using the karaoke feature, move the microphone away from the speakers or turn down the microphone volume or the speaker volume.
- When playing MP3, WMA and LPCM disc, the karaoke functions will not operate.
- When the MIC is connected, Digital Out does not work.
- The MIC sound outputs only from Analog Audio Out.
- If MIC is connected to the MIC jack on the front panel, 5.1CH audio will be changed in to 2 CH audio automatically, this condition can't be change unless the MIC is plugged out.

MY KARAOKE

My Karaoke is the feature that makes non karaoke VCD/DVD can be used like karaoke disc, by removing lead singer vocal sound.

Using the My Karaoke feature :

1. Connect the microphone.

2. Choose My Karaoke setting in Setting --> Audio --> My Karaoke and then select one of three enable mode :
 - Original Vocal : This setting will keep the original vocal sound.
 - Min. Reduction : this setting reduce the main vocals sound slightly.
 - Max. Reduction : This setting will reduce the main vocals sound greatly
3. Insert and play DVD or VCD media, this feature only for VCD.DVD non karaoke type.

Note

1. Feature will disabled when :
 - Removing the microphone, or
 - Changing "My Karaoke" settings to "Original Vocals" or
 - Playing Karaoke audio, or
 - Playing non supported file type (ex : *.avi; *.mp3; *.divx; etc)
2. No pop-up notification when feature disabled.

Changing setup menu

Using the Setup Menu

The Setup menu lets you customize your DVD player by allowing you to select various language preferences, set up a parental level, even adjust the player to the type of television screen you have.

1. With the unit in Stop mode, press the **MENU** button on the remote control. Press the ◀/▶ buttons to select **SETTINGS**, then press the **ENTER** button.
2. Press the ▲/▼ buttons to select a Setup Menu, then press the ▶ or **ENTER** to bring up the sub-menu.
3. Press the ▲/▼ buttons to select a sub-menu option, then press the ▶ or **ENTER**.
4. To make the setup screen disappear after setting up, press the **RETURN** button.

Setting Up the Display Options

Display options enable you to set various video functions of the player.

1. With the unit in Stop mode, press the **MENU** button. Press the ◀/▶ buttons to select **SETTINGS**, then press the **ENTER** button.
2. Press the ▲/▼ buttons to select **DISPLAY**, then press the ▶ or **ENTER** button.
3. Press the ▲/▼ buttons to select the desired item, then press the ▶ or **ENTER** button.

Note

- Consult your TV User's Manual to find out if your TV supports Progressive Scan. If Progressive Scan is supported, follow the TV User's Manual regarding Progressive Scan settings in the TV's menu system.
- If Video Output is set incorrectly, the screen may be blocked.
- When the resolution is changed during playback, it may take a few seconds for a normal image to appear.

Setting Up the Audio Options

Audio Options allows you to setup the audio device and sound status settings depending on the audio system in use.

1. With the unit in Stop mode, press the MENU button. Press the ◀/▶ buttons to select **SETTING**, then press the **ENTER** button.
2. Press the ▲/▼ buttons to select **AUDIO**, then press the ▶ or **ENTER** button.
3. Press the ▲/▼ buttons to select the desired item, then press the ▶ or **ENTER** button.

Note :

- When play a disc that has MPEG Audio and you have Bitstream selected in the Audio Options menu, the Digital Audio jack may not output audio
- There is no analogue audio output when you play a sound disc.
- Even when PCM Down sampling is Off
 - Some discs will only output down sampled audio through the digital outputs.

Manufactured under license from Dolby Laboratories. "Dolby" and the double-D symbol are trademarks of Dolby Laboratories.

Surround Sound Speaker Setup (Only DVD-E370, E365)

1. With the unit in Stop mode, press the MENU button. Press the ◀/▶ buttons to select **SETTING**, then press the **ENTER** button.
2. Press the ▲/▼ buttons to select **AUDIO**, then press the ▶ or **ENTER** button.
3. Press the ▲/▼ buttons to select **Speaker Setup**, then press the ▶ or **ENTER** button.
4. Press the ▲/▼/◀/▶ buttons to select the desired item, then press the **ENTER** button to set the speaker.

Note

To make the setup menu disappear, press the MENU button.

Setting up Test

The test output signals come clockwise starting from the Front Speaker(L).
Adjust Channel Balance so that speakers output equally in your room.

FRONT(L) → CENTER → FRONT(R) → SURROUND(R) → SURROUND(L) → SUBWOOFER

Note

To make the Setup menu disappear or return to menu screen during set up, press RETURN button.

- The subwoofer test output signal is lower than the other speakers.
- The MPEG Multichannel logo is a trademark registered by PHILIPS Corporation.
- If you set Front (L, R) "Small", LFE (Subwoofer) is set "On" automatically.

Setting Up the System Options

1. With the unit in Stop mode, press the **MENU** button. Press the ◀/▶ buttons to select **SETTINGS**, then press the **ENTER** button.
2. Press the ▲/▼ buttons to select **SYSTEM**, then press the ▶ or **ENTER** button.
3. Press the ▲/▼ buttons to select the desired item, then press the ▶ or **ENTER** button.

Setting Up the Language Features

If you set the player menu, disc menu, audio and subtitle language in advance, they will come up automatically every time you watch a movie.

1. With the unit in Stop mode, press the **MENU** button. Press the ◀/▶ buttons to select **SETTINGS**, then press the **ENTER** button.
2. Press the ▲/▼ buttons to select **LANGUAGE**, then press the ▶ or **ENTER** button.
3. Press the ▲/▼ buttons to select the desired language, then press the ▶ or **ENTER** button.

Note

- The language is selected and the screen returns to Language Setup menu.
- To make the setup menu disappear, press the MENU button.
- If the selected language is not recorded on the disc, the original pre-recorded language is selected.
- Select "Original" if you want the default soundtrack language to be the original language the disc is recorded in.
- Select "Automatic" if you want the subtitle language to be the same as the language selected as the audio language.
- Some discs may not contain the language you select as your initial language; in that case the disc will use its original language setting.

Setting Up the Security Options

The Parental Control function works in conjunction with DVDs that have been assigned a rating, which helps you control the types of DVDs that your family watches. There are up to 8 rating levels on a disc.

Setting Up the Rating Level

1. With the unit in Stop mode, press the **MENU** button. Press the ◀/▶ buttons to select **SETTINGS**, and then press the **ENTER** button.
2. Press the ▲/▼ buttons to select **SECURITY**, and then press the ▶ or **ENTER** button.
3. The first time you access security, you must enter the default password: 0000. To enter the default password, highlight 0 on the screen and press the **ENTER** button 4 times. To change the default password.
4. Press the ▲/▼ buttons to select **PARENTAL**, and then press the ▶ or **ENTER** button.
5. Press the ▲/▼ buttons to select the rating level you want, and then press the **ENTER** button.
The higher the rating level, the more mature the allowable content.
 - If you select the Kid Safe level, discs rated level 2 or higher will not play unless you enter the pass word.

Security Levels :

- ① **KID SAFE**
- ② **G** (General Audiences) : All Ages Admitted
- ③ **PG** (Parental Guidance suggested) : Some material may not be suitable for young children.
- ④ **PG 13** (PG-13 Parents strongly cautioned) : Some material may be inappropriate for children under 13.
- ⑤ **PGR** (Parental Guidance Recommended) : These are not necessarily unsuitable for children, but viewer discretion is advised, and parents and guardians are encouraged to supervise younger viewers.
- ⑥ **R** (Restricted) : Under 17 requires accompanying adult
- ⑦ **NC17** (NC-17) : No one 17 and under admitted.
- ⑧ **ADULT**

Note:

- If you have forgotten your password, see "Forgot Password" in the Troubleshooting Guide.

Changing the Password

To change the password, follow these steps:

1. On the Settings Menu, Select **Security**, and then press the **ENTER** button.
2. Enter the current 4 digit password. If you have never changed the password, enter the default password: 0000. To enter a number, use the ◀/▶/▲/▼ buttons to highlight a number, and then press the **ENTER** button.
3. Select **Change Password**, and then press the **ENTER** button.
4. Enter the new 4 digit password. Use the ◀/▶/▲/▼ buttons to select a number, and then press the **ENTER** button. Repeat 4 times.
5. Re-enter the new password in the same manner to confirm. The Security menu re-appears.

Setting Up the General Options

1. With the unit in Stop mode, press the **MENU** button. Press the ◀/▶ buttons to select **SETTINGS**, then press the **ENTER** button.
2. Press the ▲/▼ buttons to select **GENERAL**, then press the ▶ or **ENTER** button.
3. Press the ▲/▼ buttons to select the desired item, then press the ▶ or **ENTER** button.

Setting Up the Support Options

Support option enable you to check your DVD player information such as the model code, Software Version, The serial and version numbers can be found on the back side of your DVD-Player.

1. With the unit in Stop mode, press the **MENU** button. Press the ◀/▶ buttons to select **SETTINGS**, then press the **ENTER** button.
2. Press the ▲/▼ buttons to select **SUPPORT**, then press the ▶ or **ENTER** button.
3. Select **PRODUCT INFORMATION**, then press the ▶ or **ENTER** button.

Reference

Troubleshooting

Before requesting service (troubleshooting), please check the following.

Problem	Action
The screen is blocked.	<ul style="list-style-type: none">• Press the ▶ ◀ button (in front panel) for more than 5 seconds under no disc inside. All setting will revert to factory settings.
Forgot password.	<ul style="list-style-type: none">• Press the ▶ ◀ button (in front panel) for more than 5 seconds under no disc inside. All settings including the password will revert to the factory settings. Don't use this unless absolutely necessary.
5.1 channel sound is not being reproduced. (DVD-E370,E365)	<ul style="list-style-type: none">• 5.1 channel sound is reproduced only when the following conditions are met. :<ol style="list-style-type: none">1) The DVD player is connected with the proper Amplifier2) The disc is recorded with 5.1 channel sound.• Check whether the disc being played has the "5.1 ch" mark on the outside.• Check if your audio system is connected and working properly.• In a SETUP Menu, is the Audio Output set to Bitstream?

Specifications

Memo

General	Power Requirements	AC110-240V, 50/60Hz
	Power Consumption	For the power supply and power consumption, refer to the label attached to the product
	Weight	1.10 Kg
	Dimensions	300mm(W) X 208mm(D) X 42mm(H)
	Operating Temperature Range	+5°C to +35°C
	Operating Humidity Range	10 % to 75 %
Video Output	Composite Video	1 channel : 1.0 Vp-p (75 Ω load)
	Component Video	Y : 1.0 Vp-p (75 Ω load) Pr : 0.70 Vp-p (75 Ω load) Pb : 0.70 Vp-p (75 Ω load)
Audio Output	Output terminal	2 CH
	Maximum Output Level	2Vrms
	Frequency Response	20 Hz to 20 kHz
	5.1 Channel (DVD-E370, E365)	F/L,F/R,R/L,R/R,CT,S/W
	Digital Audio Out	Coaxial terminal (S/PDIF)

Memo



Contact SAMSUNG WORLD WIDE

If you have any questions or comments relating to Samsung products, please contact the SAMSUNG customer care centre.

Area	Contact Centre ☎	Web Site
■ Asia Pacific		
AUSTRALIA	1300 362 603	www.samsung.com
NEW ZEALAND	0800 SAMSUNG (0800 726 786)	www.samsung.com
CHINA	400-810-5858	www.samsung.com
HONG KONG	(852) 3698 4698	www.samsung.com/hk www.samsung.com/hk_en/
INDIA	1800 1100 11 3030 8282 1800 3000 8282 1800 266 8282	www.samsung.com
INDONESIA	0800-112-8888 021-5699-7777	www.samsung.com
MALAYSIA	1800-88-9999	www.samsung.com
PHILIPPINES	1-800-10-SAMSUNG(726-7864) for PLDT 1-800-3-SAMSUNG(726-7864) for Digitel 1-800-8-SAMSUNG(726-7864) for Globe 02-5805777	www.samsung.com
SINGAPORE	1800-SAMSUNG(726-7864)	www.samsung.com
THAILAND	1800-29-3232 02-689-3232	www.samsung.com
TAIWAN	0800-329-999 0266-026-066	www.samsung.com
VIETNAM	1 800 588 889	www.samsung.com
■ Middle East		

Area	Contact Centre ☎	Web Site
U.A.E	800-SAMSUNG (726-7864)	www.samsung.com
OMAN	800-SAMSUNG (726-7864)	www.samsung.com
KUWAIT	183-2255	www.samsung.com
BAHRAIN	8000-4726	www.samsung.com
Egypt	08000-726786	www.samsung.com
JORDAN	800-22273	www.samsung.com
IRAN	021-8255	www.samsung.com
Morocco	080 100 2255	www.samsung.com
Saudi Arabia	9200-21230	www.samsung.com
■ Africa		
NIGERIA	0800-726-7864	www.samsung.com
Ghana	0800-10077 0302-200077	www.samsung.com
Cote D' Ivoire	8000 0077	www.samsung.com
Senegal	800-00-0077	www.samsung.com
Cameroon	7095- 0077	www.samsung.com
KENYA	0800 724 000	www.samsung.com
UGANDA	0800 300 300	www.samsung.com
TANZANIA	0685 88 99 00	www.samsung.com
SOUTH AFRICA	0860-SAMSUNG(726-7864)	www.samsung.com



AK68-02197A-00

Free Manuals Download Website

<http://myh66.com>

<http://usermanuals.us>

<http://www.somanuals.com>

<http://www.4manuals.cc>

<http://www.manual-lib.com>

<http://www.404manual.com>

<http://www.luxmanual.com>

<http://aubethermostatmanual.com>

Golf course search by state

<http://golfingnear.com>

Email search by domain

<http://emailbydomain.com>

Auto manuals search

<http://auto.somanuals.com>

TV manuals search

<http://tv.somanuals.com>