

PHILIPS

MAGNAVOX

DVD Video Player
DVD400AT
Owner's Manual

IMPORTANT!

Return Your Warranty Registration Card
Within 10 Days. See Why Inside.

SAFETY PRECAUTIONS

CAUTION: This Digital Video Disc Player employs a Laser System.
To ensure proper use of this product, please read this owner's manual carefully and retain for future reference.
Should the unit require maintenance, contact an authorized service location - see service procedure.

Use of controls, adjustments or the performance of procedures other than those specified may result herein hazardous radiation exposure.

To prevent direct exposure to laser beam, do not try to open the enclosure.
Visible laser radiation when open and interlocks defeated.
DO NOT STARE INTO BEAM.

FCC NOTICE: This equipment has been tested and found to comply with the limits for a Class B digital device, pursuant to part 15 of the FCC Rule. These limits are designed to provide reasonable protection against harmful interference in a residential installation.

This equipment generates, uses, and can radiate radio frequency energy and, if not installed and used in accordance with the instructions, may cause harmful interference to radio communications.

However, there is no guarantee that interference will not occur in a particular installation.

If this equipment does cause harmful interference to radio or television reception, which can be determined by turning the equipment off and on, the user is encouraged to try to correct the interference by one or more of the following measures:

- Reorient or relocate the receiving antenna.
- Increase the separation between the equipment and receiver.
- Connect the equipment into an outlet on a circuit different from that to which the receiver is connected.
- Consult the dealer or an experienced radio/TV technician for help.

WARNING: Changes or modifications made to this equipment, not expressly approved by Philips Consumer Electronics Company, or parties authorized by Philips Consumer Electronics Company, could void the user's authority to operate the equipment.

INDUSTRY CANADA REQUIREMENT

This Class B digital apparatus meets all requirements of the Canadian Interference-Causing Equipment Regulations.

Cet appareil numérique de la classe B respecte toutes les exigences du Règlement sur le matériel brouilleur du Canada.

Location of the required label

PRODUCT IS CERTIFIED BY THE MANUFACTURER TO
COMPLY WITH DHHS RULES 21 CFR SUBCHAPTER J
APPLICABLE AT THE DATE OF MANUFACTURE.

MANUFACTURED

DISTRIBUTED BY:
PHILIPS CONSUMER ELECTRONICS CO.
P. O. BOX 14810 KNOXVILLE, TN 37914 -1810

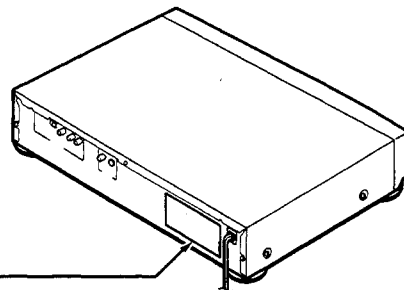

IMPORTANT SAFETY INSTRUCTIONS

CAUTION: PLEASE READ AND OBSERVE ALL WARNINGS AND INSTRUCTIONS GIVEN IN THIS OWNER'S MANUAL AND THOSE MARKED ON THE UNIT. RETAIN THIS BOOKLET FOR FUTURE REFERENCE.

This set has been designed and manufactured to assure personal safety. Improper use can result in electric shock or fire hazard. The safeguards incorporated in this unit will protect you if you observe the following procedures for installation, use and servicing. This unit is fully transistorized and does not contain any parts that can be repaired by the user.

DO NOT REMOVE THE CABINET COVER, OR YOU MAY BE EXPOSED TO DANGEROUS VOLTAGE. REFER SERVICING TO QUALIFIED SERVICE PERSONNEL ONLY.

1. Read owner's manual

After unpacking this product, read the owner's manual carefully, and follow all the operating and other instructions.

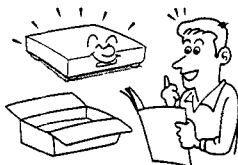

2. Power Sources

This product should be operated only from the type of power source indicated on the marking label. If you are not sure of the type of power supply to your home, consult your product dealer or local power company. For products intended to operate from battery power, or other sources, refer to the operating instructions.



3. Grounding or Polarization

This product may be equipped with a polarized alternating current line plug (a plug having one blade wider than the other). This plug will fit into the power outlet only one way. This is a safety feature. If you are unable to insert the plug fully into the outlet, try reversing the plug. If the plug should still fail to fit, contact your electrician to replace your obsolete outlet. Do not defeat the safety purpose of the polarized plug.

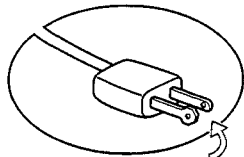

4. Ventilation

Slots and openings in the cabinet are provided for ventilation and to ensure reliable operation of the product and to protect it from overheating, and these openings must not be blocked or covered. The openings should never be blocked by placing the product on a bed, sofa, rug or other similar surface. This product should not be placed in a built-in installation such as a bookcase or rack unless proper ventilation is provided or the manufacturer's instructions have been adhered to.



5. Heat

The product should be situated away from heat sources such as radiators, heat registers, stoves, or other products (including amplifiers) that produce heat.

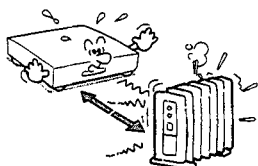

6. Water and Moisture

Do not use this product near water - for example, near a bath tub, wash bowl, kitchen sink, or laundry tub; in a wet basement; or near a swimming pool and the like.

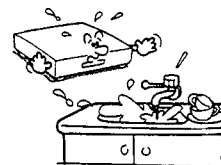

7. Cleaning

Unplug this product from the wall outlet before cleaning. Do not use liquid cleaners or aerosol cleaners. Use a damp cloth for cleaning.

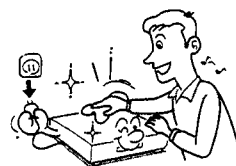

8. Power-Cord Protection

Power-supply cords should be routed so that they are not likely to be walked on or pinched by items placed upon or against them, paying particular attention to cords at plugs, convenience receptacles, and the point where they exit from the product.



9. Overloading

Do not overload wall outlets; extension cords, or integral convenience receptacles as this can result in a risk of fire or electric shock.

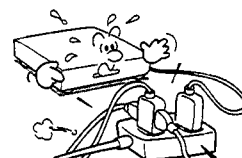

10. Lightning

For added protection for this product during storm, or when it is left unattended and unused for long periods of time, unplug it from the wall outlet. This will prevent damage to the product due to lightning and power-line surges.

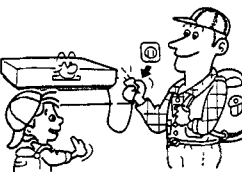

11. Object and Liquid Entry

Never push objects of any kind into this product through openings as they may touch dangerous voltage points or short-out parts that could result in a fire or electric shock. Never spill liquid of any kind on the product.



12. Attachments

Do not use attachments not recommended by the product manufacturer as they may cause hazards.

13. Accessories

Do not place this product on an unstable cart, stand, tripod, bracket, or table. The product may fall, causing serious injury to a child or adult, and serious damage to the product. Use only with a cart, stand, tripod, bracket, or table recommended by the manufacturer, or sold with the product. Any mounting of the product should follow the manufacturer's instructions, and should use a mounting accessory recommended by the manufacturer.

A product and cart combination should be moved with care. Quick stops, excessive force, and uneven surfaces may cause the product and cart combination to overturn.

**14. Disc Tray**

Keep your fingers clear of the disc tray as it is closing. It may cause serious personal injury.

**15. Burden**

Do not place a heavy object on the product or step on it. The object may fall, causing serious personal injury and serious damage to the product.

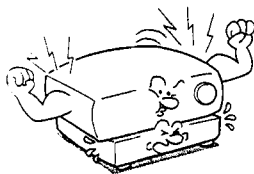
**16. Connecting**

When you connect the product to other equipment, turn off the power and unplug all of the equipment from the wall outlet. Failure to do so may cause an electric shock and serious personal injury. Read the owner's manual for the other equipment carefully and follow the instructions when making any connections.

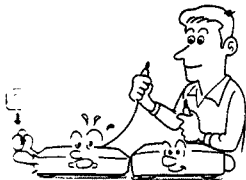
**17. Sound Volume**

Reduce the volume to the minimum level before you turn on the product. Otherwise, sudden high volume may cause hearing or speaker damage.

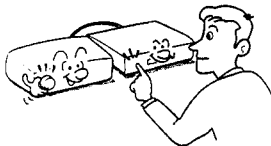
**18. Sound Distortion**

Do not allow the product to output distorted sound for a long time. It may cause speaker overheating and fire.

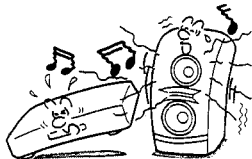
**19. Headphones**

When you use the headphones, keep the volume at a moderate level. If you use the headphones continuously at a with high volume, it may cause hearing damage.

**20. Laser Beam**

Do not look into the opening of the disc tray or into the ventilation openings to see the source of the laser beam. It may cause eye damage.

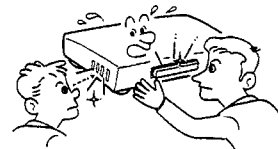
**21. Disc**

Do not use a cracked, deformed, or repaired disc. These discs are easily broken and may cause serious personal injury and product malfunction.

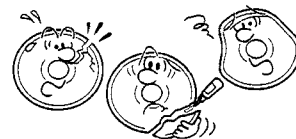
**22. Damage Requiring Service**

Unplug this product from the wall outlet and refer servicing to qualified service personnel under the following conditions:

- When the power-supply cord or plug is damaged.
- If liquid has been spilled, or objects have fallen into the product.
- If the product has been exposed to rain or water.
- If the product does not operate normally by following the operating instructions. Adjust only those controls that are covered by the operating instructions as an improper adjustment of other controls may result in damage and will often require extensive work by a qualified technician to restore the product to its normal operation.
- If the product has been dropped or damaged in any way.
- When the product exhibits a distinct change in performance - this indicates a need for service.

23. Servicing

Do not attempt to service this product yourself as opening or removing covers may expose you to dangerous voltage or other hazards. Refer all servicing to qualified service personnel.

**24. Replacement Parts**

When replacement parts are required, be sure the service technician has used replacement parts specified by the manufacturer or have the same characteristics as the original part. Unauthorized substitutions may result in fire, electric shock, or other hazards.

25. Safety Check

Upon completion of any service or repairs to this product, ask the service technician to perform safety checks to determine that the product is in proper operating condition.

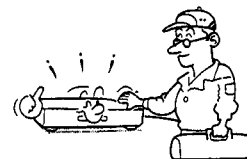

Precautions

Notes on Handling

- When shipping the DVD video player, the original shipping carton and packing materials come in handy. For maximum protection, repack the unit as it was originally packed at the factory.
- Do not use volatile liquids, such as insect spray, near the DVD video player. Do not leave rubber or plastic products in contact with the DVD video player for a long time. They will leave marks on the cabinet.
- The top and rear panels of the DVD video player may become warm after a long period of use. This is not a malfunction.
- When the DVD video player is not in use, be sure to remove the disc and turn off the power.
- If you do not use the DVD video player for a long time, the unit may not function properly in the future. Use the DVD video player occasionally.

Notes on Location

- When you place this DVD video player near a TV, radio, or VCR, the playback picture may become poor and the sound may be distorted. In this case, place the DVD video player away from the TV, radio, or VCR.

Notes on Cleaning

Use a soft, dry cloth for cleaning.

- For stubborn dirt, soak the cloth in a weak detergent solution, wring the cloth well, and wipe the unit. Use a dry cloth to wipe it dry.
- Do not use any type of solvent, such as thinner and benzene, as they may damage the surface of the DVD video player.
- If you use a chemical saturated cloth to clean the unit, follow that product's instructions.

To Obtain a Clear Picture

The DVD video player is a high technology, precision device. If the optical pick-up lens and disc drive parts are dirty or worn down, the picture quality becomes poor. To obtain a clear picture, we recommend regular inspection and maintenance (cleaning or parts replacement) every 1,000 hours of use depending on the operating environment. For details, contact your nearest dealer.

Notes on Moisture Condensation

Moisture condensation damages the DVD video player. Please read the following carefully.

Moisture condensation occurs, for example, when you pour a cold drink into a glass on a warm day. Drops of water form on the outside of the glass. In the same way, moisture may condense on the optical pick-up lens inside this unit, one of the most crucial internal parts of the DVD video player.

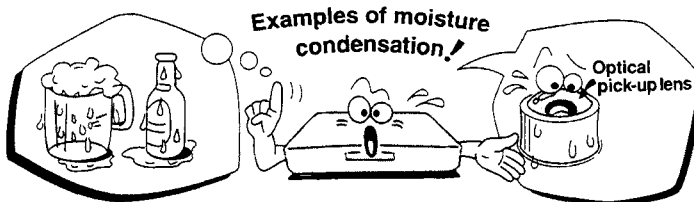

■ **Moisture condensation occurs during the following cases.**

- When you bring the DVD video player directly from a cold place to a warm place.
- When you use the DVD video player in a room where you just turned on the heater, or a place where the cold wind from the air conditioner directly hits the unit.
- In summer, when you use the DVD video player in a hot and humid place just after you move the unit from an air conditioned room.
- When you use the DVD video player in a humid place.

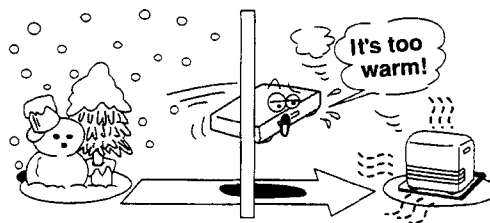

■ **Do not use the DVD video player when moisture condensation may occur.**

If you use the DVD video player in such a situation, it may damage discs and internal parts. Remove the disc, connect the power cord of the DVD video player to the wall outlet, turn on the DVD video player, and leave it for two or three hours. After two or three hours, the DVD video player will have warmed up and evaporated any moisture. Keep the DVD video player connected to the wall outlet and moisture condensation will seldom occur.

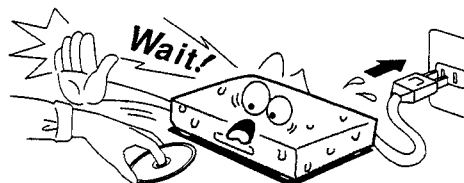

Table of Contents

Introduction

- SAFETY PRECAUTIONS 2
- IMPORTANT SAFETY INSTRUCTIONS ... 3, 4
- Precautions 5
- Table of Contents 6
- Identification of Controls 7-10
 - Front Panel/DVD display/Rear Panel
 - Remote Control
 - Preparing the Remote Control
 - Operating with the Remote Control

Connections

- Connecting to a TV 11
- Connecting to an Audio System 12
- Connecting to Optional Equipment ... 13, 14
 - Enjoying Dolby Digital (AC-3) Sound
 - Enjoying Dolby Pro Logic Surround Sound
 - Enjoying Two-Channel Digital Stereo Sound

Playback

- Playing a Disc 15-18
 - Basic Playback
 - Playing at Twice or Eight Times the Normal Speed
 - Playing Frame by Frame
 - Playing in Slow Motion
 - Resuming Playback from the Same Location
- Locating a Specific Title, Chapter, or Track 19, 20
 - Locating a Title Using the Title Menu
 - Locating a Title
 - Locating a Specific Chapter or Track
 - Locating a Specific Chapter or Track Directly
- Playing Repeatedly 21
 - Repeating a Title, Chapter, or Track
 - Repeating a Specific Segment
- Playing in a Favorite Order 22
 - Setting Titles, Chapters, or Tracks in a Favorite Order
- Playing in Random Order 23
 - Playing Titles in Random Order
 - Playing Chapters or Tracks in Random Order
- Using the On-Screen Display and DVD display 24
 - Checking the Operational Status
 - Checking the Remaining Time and Setting Status

Function Setup

- Selecting a Display Language 25
 - Selecting a Language for On-Screen Displays and the SET UP MENU
- Setting the Playback Picture Size 26
 - Setting the Default Playback Picture Size
- Selecting a Disc Menu Language 27, 28
 - Setting the Default Disc Menu Language
 - Selecting a Disc Menu Language
 - Table of Languages and Their Abbreviations
- Selecting a Language 29, 30
 - Setting the Default Language
 - Selecting a Playback Audio Setting
- Displaying Subtitles 31, 32
 - Setting the Default Subtitle Language
 - Selecting a Subtitle Language
 - Displaying Subtitles
- Selecting the Camera Angle 33, 34
 - Changing the Camera Angle
 - Displaying the Angle Icon on the TV Screen
- Setting the Parental Lock 35, 36
 - Setting the Parental Lock

Others

- Notes on Discs 37
 - Notes on Unauthorized Discs
- Before Calling Service Personnel 38
- Specifications 39
- Index 40
- LIMITED WARRANTY Back cover

Identification of Controls

See the page number inside the  for details.

Front Panel/DVD Display/Rear Panel

Front Panel

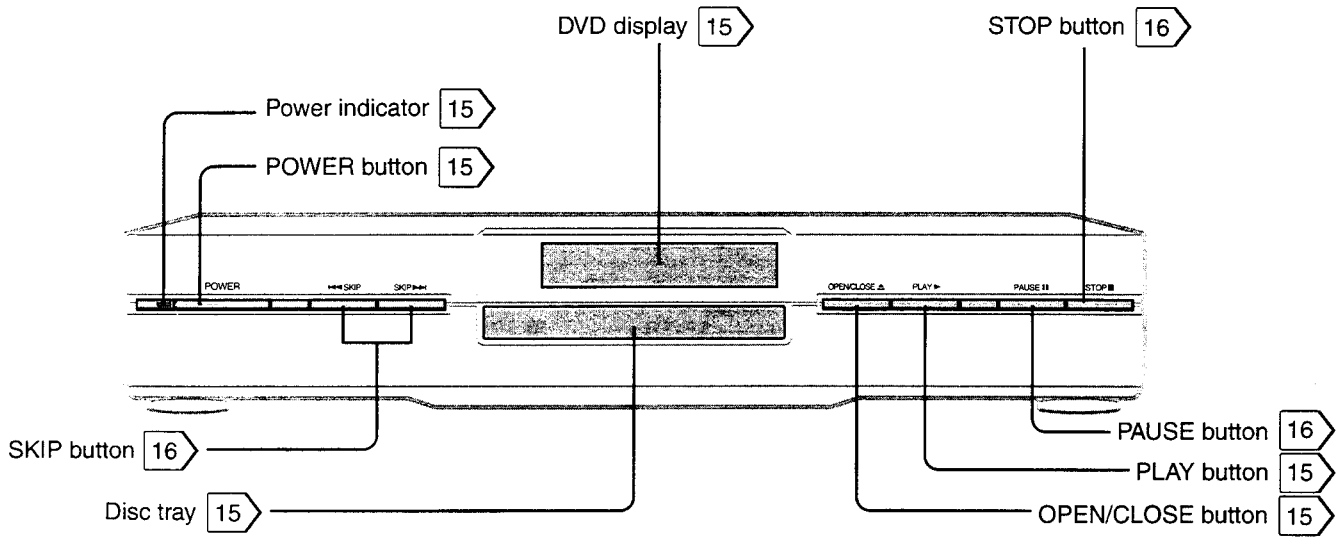

DVD Display

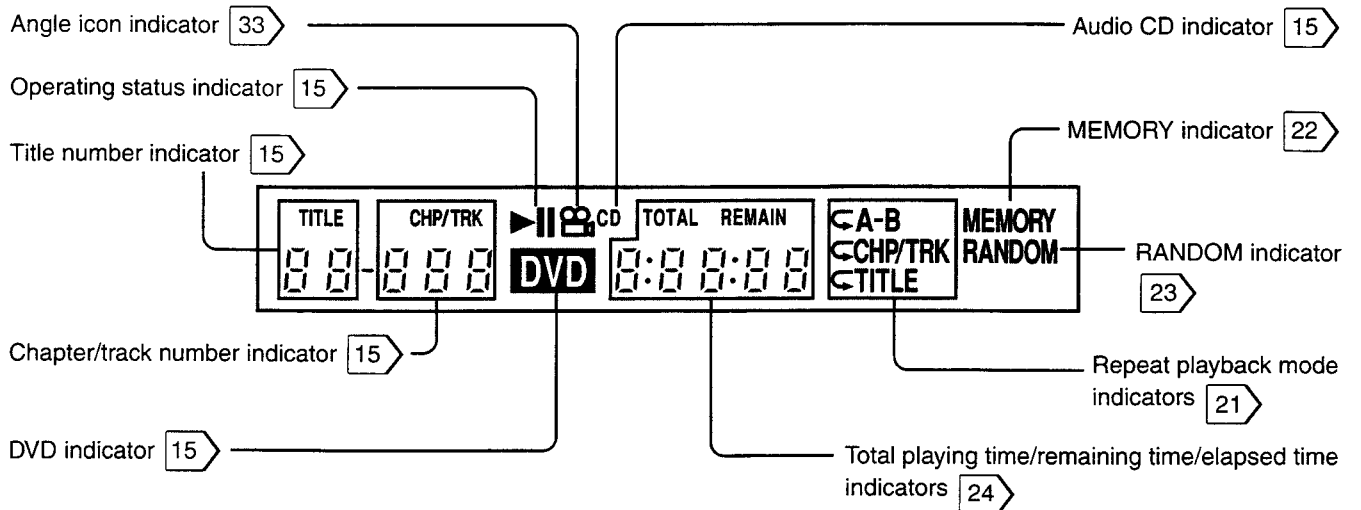

Rear Panel

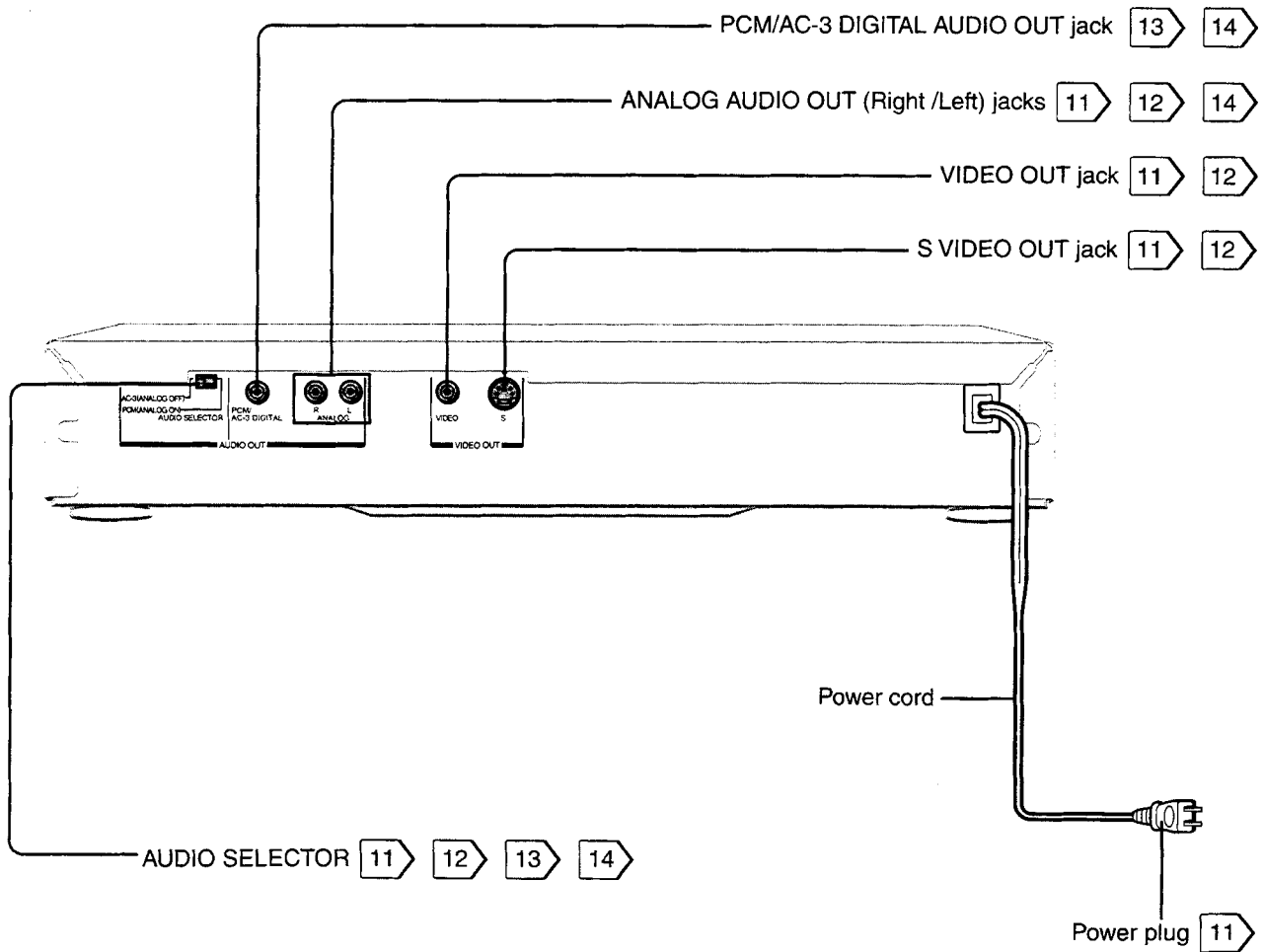

Identification of Controls (continued)

The instructions in this manual describe the controls on the remote control.
See the page number inside the  for details.

Remote Control

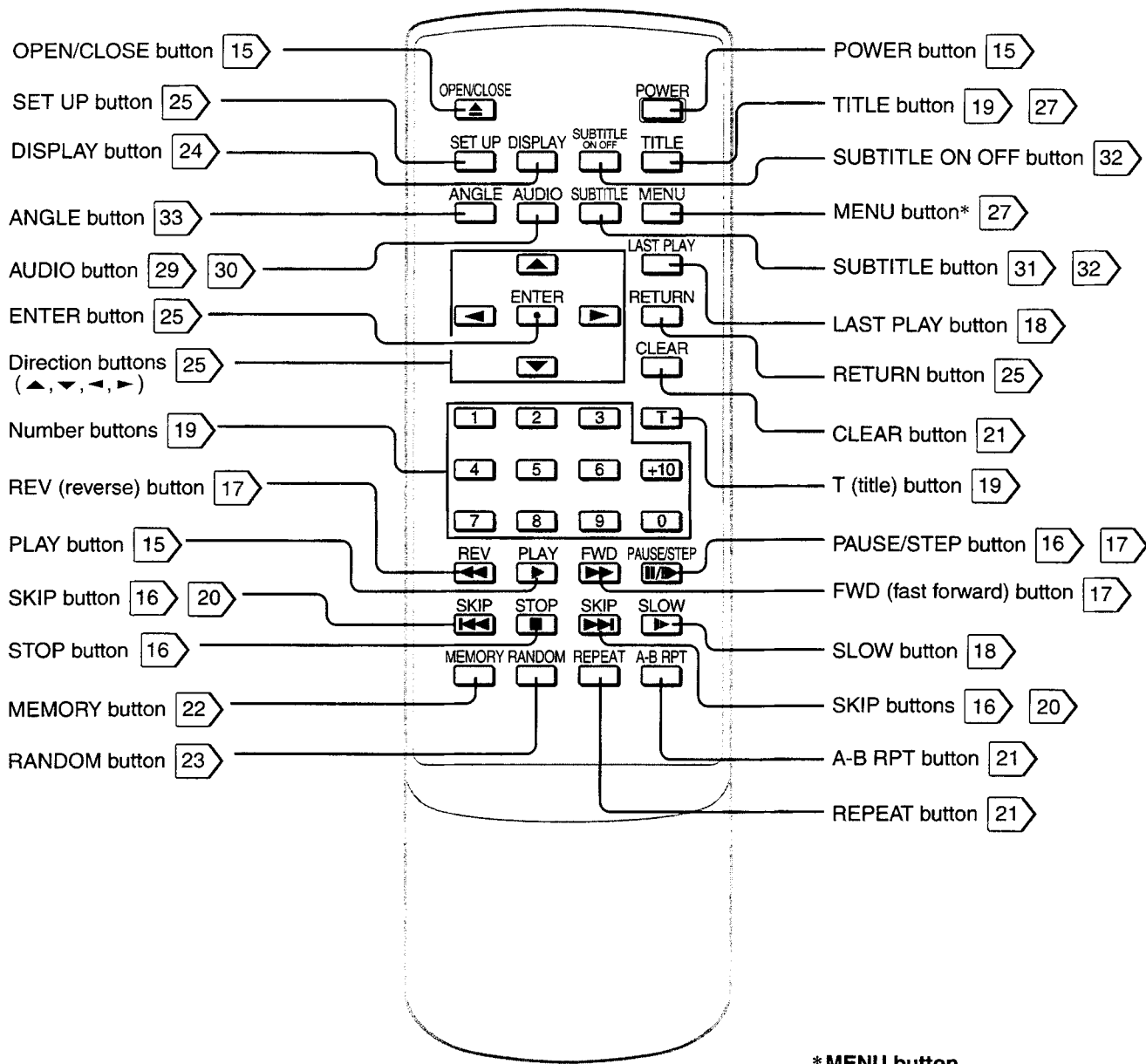

***MENU button**
Use the MENU button to display the menu screen included on DVD video discs. To operate a menu screen, follow the instructions in "Locating a Title Using the Title Menu" (page 19).

Preparing the Remote Control

Insert the batteries into the remote control so you can use it to operate the DVD video player.

1

Open the cover.

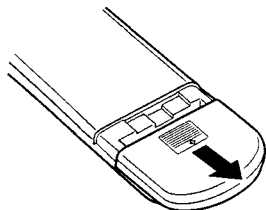

2

Insert two AA batteries.

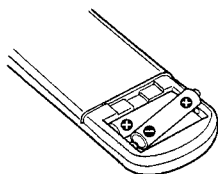

Make sure to match the + and – on the batteries to the marks inside the battery compartment.

3

Close the cover.

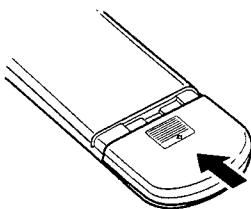

Notes on batteries

Improper use of batteries may cause battery leakage and corrosion. To operate the remote control correctly, follow the instructions below.

- Do not insert the batteries into the remote control in the wrong direction (follow the +/- signs).
- Do not charge, heat, open, or short-circuit the batteries. Do not throw the batteries into a fire.
- Do not leave dead or exhausted batteries in the remote control.
- Do not use different types of batteries together, or mix old and new batteries.
- If you do not use the remote control for a long period of time, remove the batteries to avoid possible damage from battery corrosion.
- If the remote control does not function correctly or if the operating range becomes reduced, replace all batteries with new ones.
- If battery leakage occurs, wipe the battery liquid from the battery compartment, then insert new batteries.

Operating with the Remote Control

This section shows you how to use the remote control.

Point the remote control at the remote sensor and press the buttons.

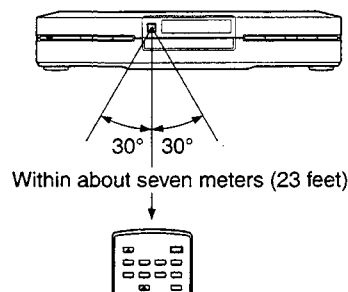

Distance: About seven meters from the remote sensor

Angle: About 30° in each direction of the front of the remote sensor

* Do not expose the remote sensor of the DVD video player to a strong light source, such as direct sunlight or illumination. If you do so, you may not be able to operate the DVD video player with the remote control.

Notes on the remote control

- Point the remote control at the remote sensor of the DVD video player.
- Do not drop the remote control.
- Do not leave the remote control near an extremely hot or humid place.
- Do not spill water into or put anything wet on the remote control.
- Do not open the remote control.

Connecting to a TV

Connect the DVD video player to your TV.

Connecting to a TV

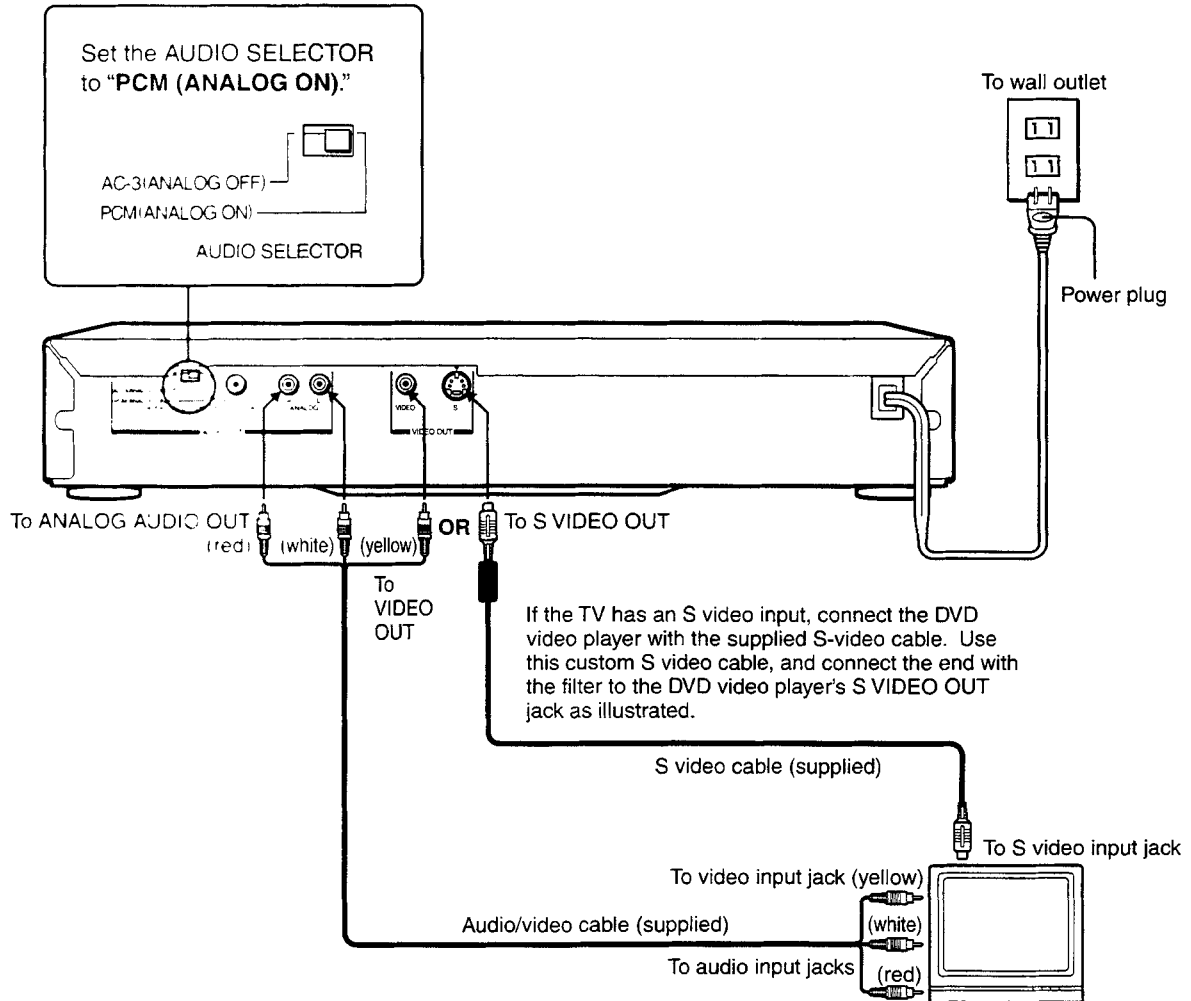

If your TV has an RF (Antenna In) jack only, use an RF modulator (not supplied) to connect the DVD video player to your TV.

* Set your TV to accept Auxiliary (Line) input. See your TV owner's manual for details.

Notes

- Be sure to refer to your TV owner's manual as well.
- When you connect the DVD video player to your TV, be sure to turn off the power and unplug both units from the wall outlet before making any connections.
- If your television has one audio input, use a Y cable adapter (not supplied) to connect to your TV.
- Connect the DVD video player directly to your TV. If you connect the DVD video player to a VCR, the playback picture will be distorted because DVD video discs are copy protected.

Connecting to an Audio System

You can listen to the sound of audio CDs and DVD video discs in stereo.

Connecting to an Audio System

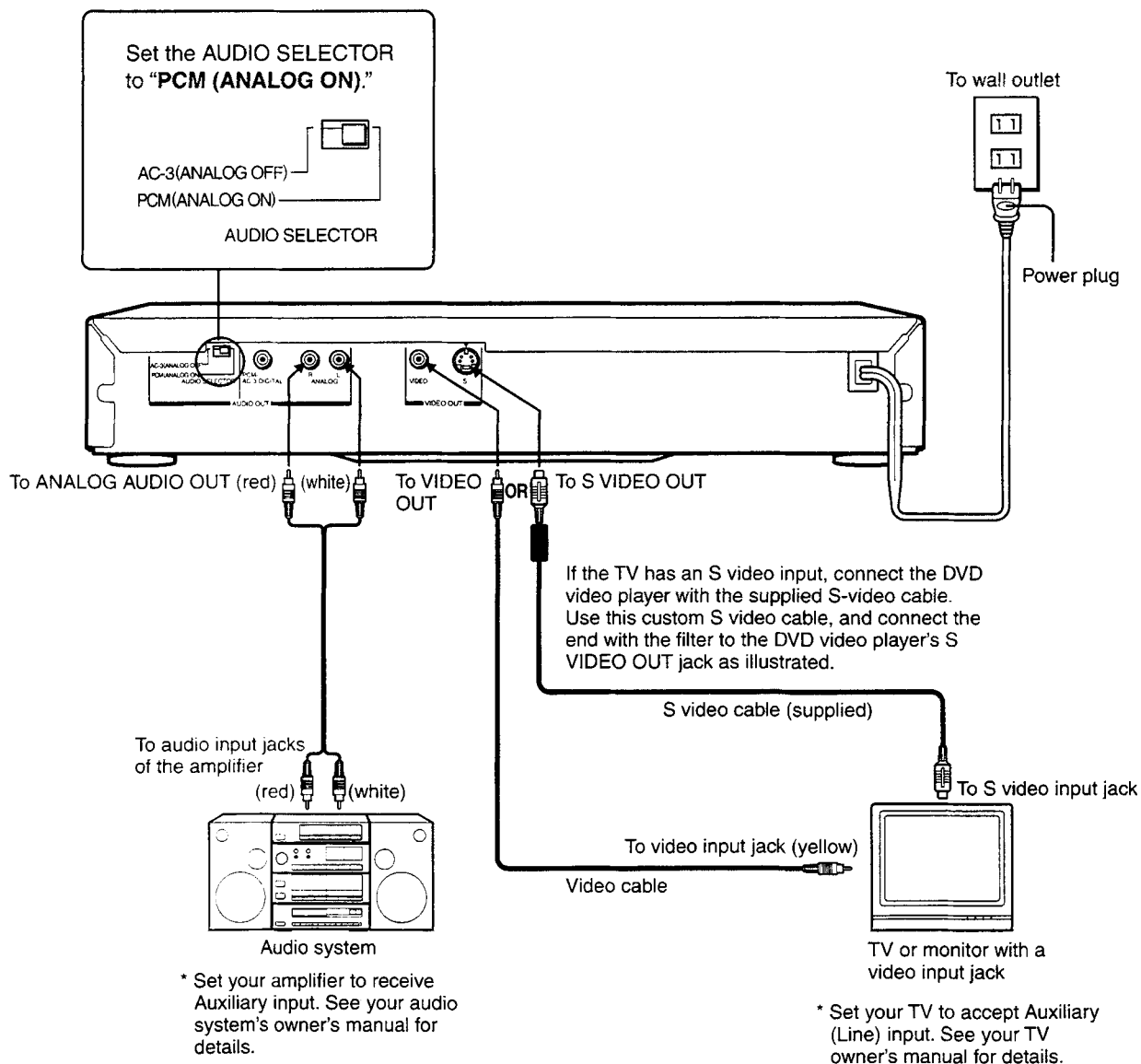

Notes

- Refer to the owner's manual of the connected equipment (TV, audio system) as well.
- When you connect the DVD video player to other equipment, be sure to turn off the power and unplug all of the equipment from the wall outlet before making any connections.
- If you place the DVD video player near a tuner or radio, the radio broadcast sound might be distorted. In this case, place the DVD video player away from the tuner and radio.
- The output sound of the DVD video player has a wide dynamic range. Be sure to adjust the receiver's volume to a moderate listening level. Otherwise, the speakers may be damaged by a sudden high volume sound.
- Turn off the amplifier before you connect or disconnect the DVD video player's power cord. If you leave the amplifier power on, the speakers may be damaged.

Connecting to Optional Equipment

You can enjoy the high quality dynamic sound of Dolby Digital (AC-3), Dolby Pro Logic, and Two-Channel Digital Stereo.

Enjoying Dolby Digital (AC-3) Sound

Dolby Digital (AC-3)

Dolby Digital is the surround sound technology used in movie theaters, and is now available in the home. You can enjoy motion picture and live concert DVD video discs with this realistic sound by connecting the DVD video player to a six-channel amplifier equipped with a Dolby Digital (AC-3) decoder or Dolby Digital (AC-3) processor. If you have a Dolby Pro Logic Surround decoder, you will obtain the full benefit of Pro Logic from the same DVD movies that provide full 5.1-channel Dolby Digital soundtracks, as well as from titles with the Dolby Surround mark.

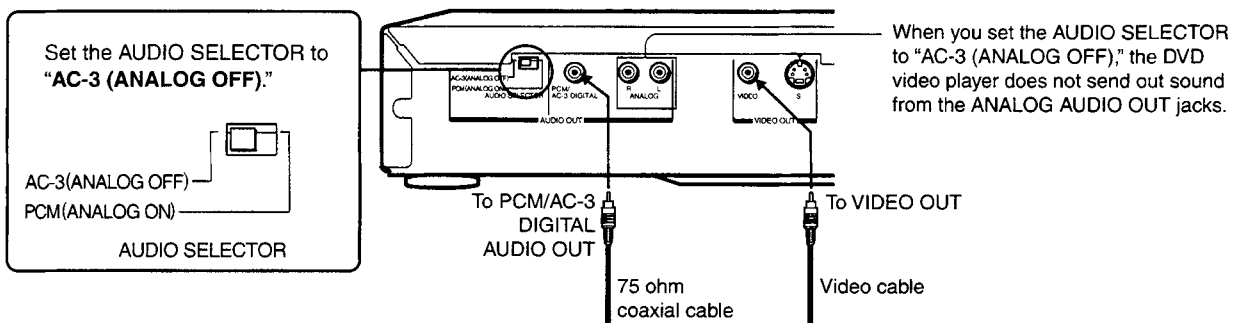

Standard equipment necessary to enjoy Dolby Digital (AC-3)

- You will need:
- The DVD video player (equipped with an AC-3 output jack)
 - DVD video discs recorded in Dolby Digital (AC-3)
 - Six-channel amplifier equipped with a Dolby Digital (AC-3) decoder, or Dolby Digital (AC-3) processor and power amplifier
 - Five speakers and one sub woofer

To enjoy Dolby Digital (AC-3) sound

You need to select the recording system. See page 30 and select "AC-3."

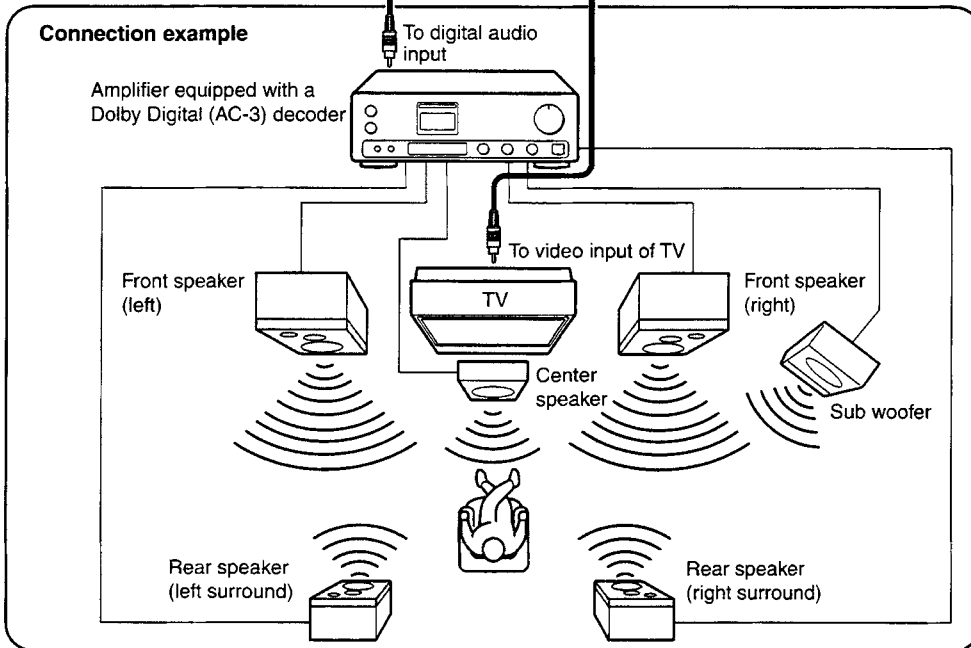

Manufactured under license from Dolby Laboratories Licensing Corporation. "Dolby," "AC-3," "Pro Logic," and the double-D symbol are trademarks of Dolby Laboratories Licensing Corporation.

Notes

- Connect the speakers according to the instructions in the owner's manual for the speaker system.
- Refer to the owner's manual of the connected equipment as well.
- When you connect the DVD video player to other equipment, be sure to turn off the power and unplug all of the equipment from the wall outlet before making any connections.
- The output sound of the DVD video player has a wide dynamic range. Be sure to adjust the receiver's volume to a moderate listening level. Otherwise, the speakers may be damaged by a sudden high volume sound.
- Turn off the amplifier before you connect or disconnect the DVD video player's power cord. If you leave the amplifier power on, the speakers may be damaged.

Warning

Do not set the AUDIO SELECTOR to "AC-3 (ANALOG OFF)" unless you are connecting (to the PCM/AC-3 DIGITAL AUDIO OUT jack) an AV decoder that has the Dolby Digital (AC-3) decoding function. High volume sound may damage your hearing as well as the speakers.

Enjoying Dolby Pro Logic Surround Sound

Dolby Pro Logic Surround

You can enjoy Dolby Pro Logic Surround sound by connecting an amplifier and speaker system (right and left front speakers, a center speaker, and one or two rear speakers).

■ **With an amplifier equipped with Dolby Digital (AC-3),** connect the equipment the same way as described in "Enjoying Dolby Digital (AC-3) Sound" on the previous page. Refer to that amplifier's owner's manual and set the amplifier so you can enjoy Dolby Pro Logic Surround sound.

■ **With an amplifier not equipped with Dolby Digital (AC-3),** connect the equipment as follows.

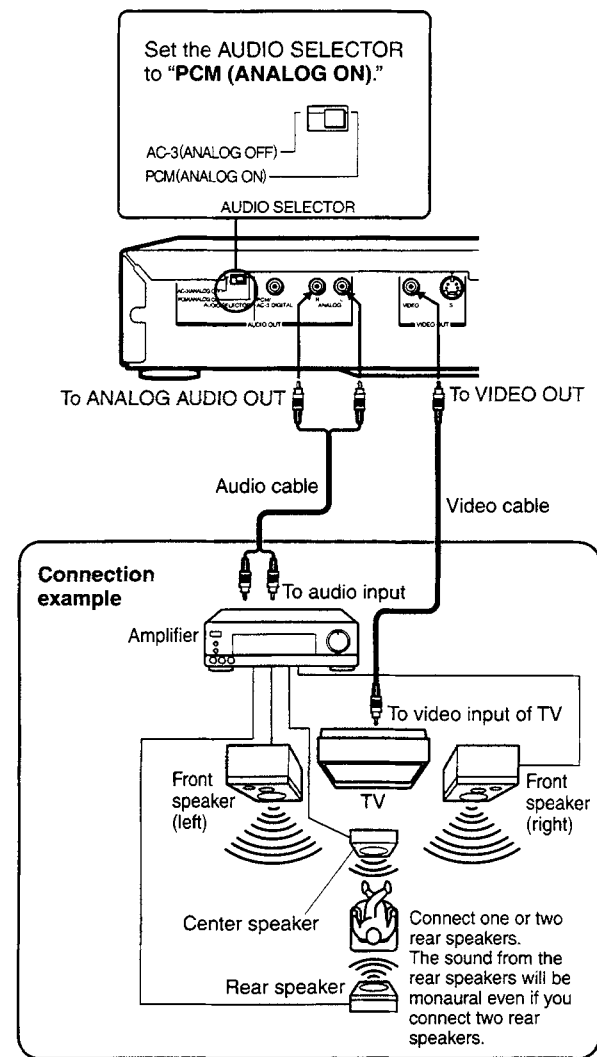

Enjoying Two-Channel Digital Stereo Sound

Two-Channel Digital Stereo

You can enjoy Two-Channel Digital Stereo sound by connecting an amplifier equipped with a digital audio input and speaker system (right and left front speakers).

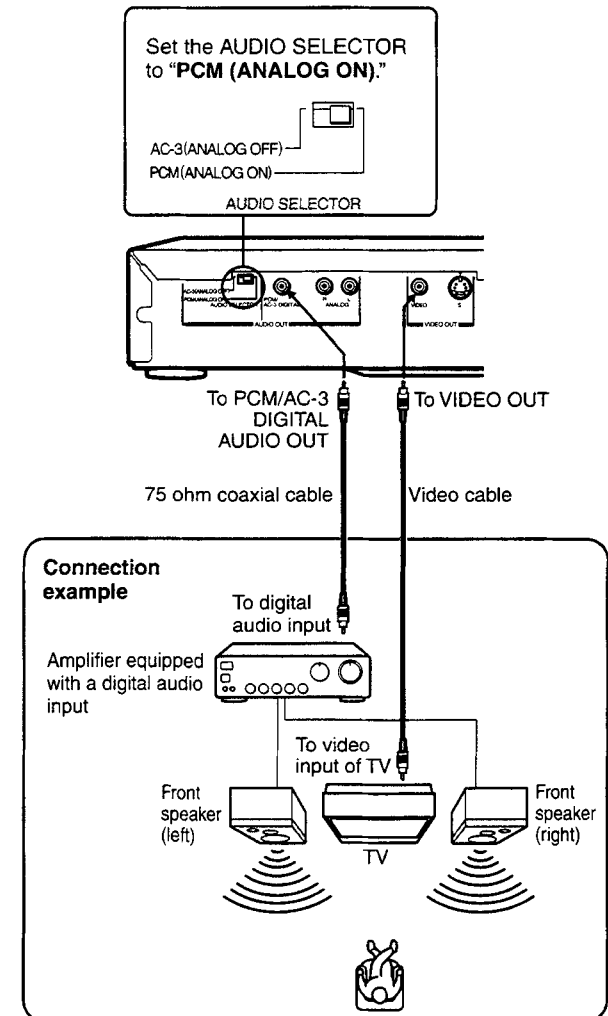

Notes

- Connect the speakers according to the instructions in the owner's manual for the speaker system.
- Refer to the owner's manual of the connected equipment as well.
- When you connect the DVD video player to other equipment, be sure to turn off the power and unplug all of the equipment from the wall outlet before making any connections.
- The output sound of the DVD video player has a wide dynamic range. Be sure to adjust the receiver's volume to a moderate listening level. Otherwise, the speakers may be damaged by a sudden high volume sound.
- Turn off the amplifier before you connect or disconnect the DVD video player's power cord. If you leave the amplifier power on, the speakers may be damaged.

Playing a Disc

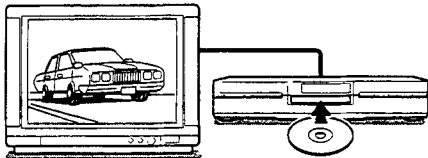



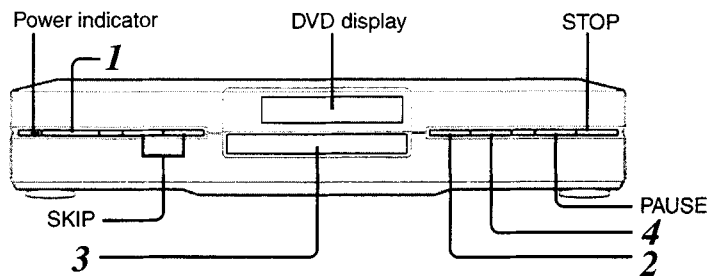

This section shows you how to play a DVD video disc or audio CD (compact disc).



Basic Playback

Preparations

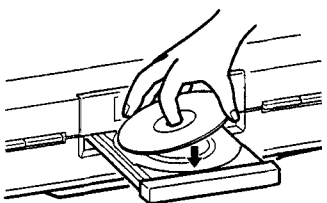
- When you want to play DVD video discs, turn on the TV and put the TV in Auxiliary (Line) input mode.
- When you want to enjoy the sound of DVD video discs or audio CDs from the audio system, turn on the audio system and set the amplifier to receive Auxiliary input.
- For connection details, see pages 11 – 14.
- Set the playback picture size according to the picture tube shape or aspect ratio of the connected TV. (See page 26.)

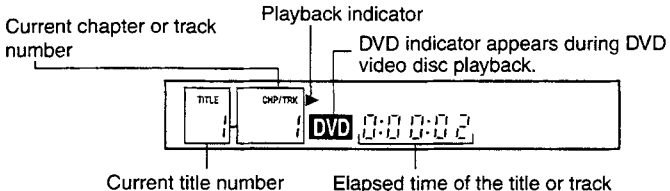
<p>1</p> <p>POWER</p> 	<p>Press POWER.</p> <p>The DVD video player turns on and the power indicator on the player lights.</p>	
<p>2</p> <p>OPEN/CLOSE</p> 	<p>Press OPEN/CLOSE.</p> <p>The disc tray opens.</p>	<p>Note</p> <p>You can open the disc tray by pressing this button even if the DVD video player is turned off.</p>
<p>3</p>	<p>Place the disc in the disc tray.</p> <p>With the playback side down</p> 	<p>Notes</p> <ul style="list-style-type: none"> • There are two different disc sizes. Place the disc in the correct guide in the disc tray. If the disc is out of the guide, it may damage the disc and cause the DVD video player to malfunction. • Do not place anything except DVD video discs or audio CDs in the disc tray.
<p>4</p> <p>PLAY</p> 	<p>Press PLAY.</p> <p>The disc tray closes and playback starts.</p> 	<p>Notes</p> <ul style="list-style-type: none"> • If you insert an audio CD, the audio CD indicator appears in the DVD display. The title number does not appear. • After playing all of the chapters in the title, the DVD video player automatically stops.

Notes

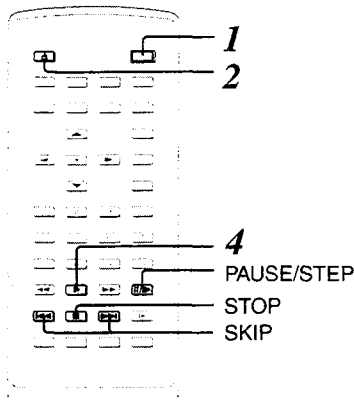

- Do not move the DVD video player during playback. Doing so may damage the disc.
- Use the OPEN/CLOSE button on the remote control or DVD video player to open and close the disc tray. Do not push the disc tray. Doing so may cause the DVD video player to malfunction.
- Do not push down the disc tray or put any objects other than discs in the disc tray. Doing so may cause the DVD video player to malfunction.
- Keep your fingers clear of the disc tray as it is closing. Be especially careful when children's fingers are near the closing disc tray. There is a risk of personal injury.



■ **To obtain a higher quality picture**

Occasionally, some picture noise may appear on the TV screen while playing a DVD video disc because the high resolution pictures on these discs include a lot of information. While the amount of noise depends on the TV, you should reduce the sharpness adjustment on your TV from the position you usually set for normal broadcasts.

■ **About  **

The   symbols on the heading bar show the playable discs for the function described under that heading.

 : You can use this function with DVD video discs.

 : You can use this function with audio CDs.

To go to the next chapter or track



Press SKIP .

To stop playback



Press STOP.

The DVD video player returns to chapter 1 or track 1.

To go to the previous chapter or track



Press SKIP .

The DVD video player starts playback from the beginning of the current chapter or track.

When you press the SKIP  button twice, the DVD video player starts playback from the beginning of the previous chapter or track.

To remove the disc

OPEN/CLOSE



Press OPEN/CLOSE.

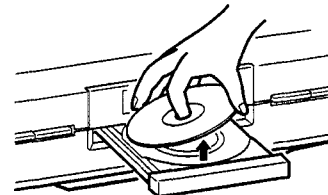

Remove the disc after the disc tray opens completely.

- Be sure to press the OPEN/CLOSE button to close the disc tray after you remove the disc.

To pause playback (still playback)

PAUSE/STEP



Press PAUSE/STEP during playback.

Appears when playback is paused



To resume normal playback, press the PLAY button.

- The sound is muted during still playback.

Playing a Disc (continued)

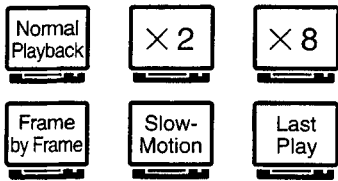

You can play discs at various speeds, and resume playback from the location where you stopped playback.

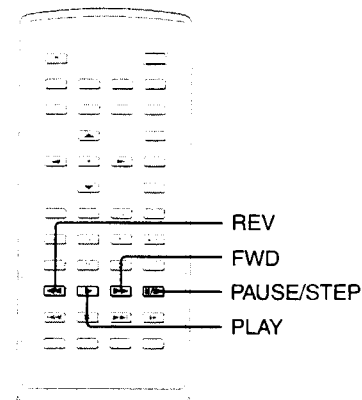

Playing at Twice or Eight Times the Normal Speed

You can play a disc at twice or eight times the normal speed.



Press REV or FWD during playback.

The playback speed is twice the normal speed.



Pressing the REV or FWD button again changes the playback speed to eight times the normal speed.

REV: Fast reverse playback
FWD: Fast forward playback

Each time you press the REV or FWD button, the playback speed alternates between twice the normal speed and eight times the normal speed.

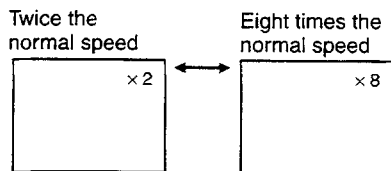

To resume normal playback



Press PLAY.

Playing Frame by Frame

You can advance a DVD video disc picture frame by frame.



Press PAUSE/STEP during still playback.

Each time you press the PAUSE/STEP button, the picture advances one frame.

To resume normal playback



Press PLAY.

Notes

- The DVD video player does not play sound and subtitles of a DVD video disc during playback that is twice or eight times the normal playback speed (forward or reverse). However, the DVD video player plays sound during fast forward or fast reverse playback of audio CDs.
- Twice or eight times the normal playback speeds are only approximate speeds. These speeds may vary slightly from disc to disc.

Note

The sound is muted during frame by frame playback.

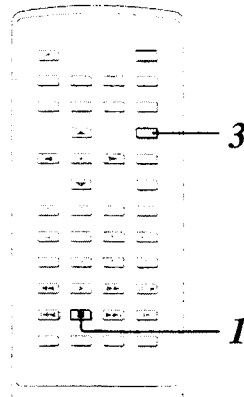
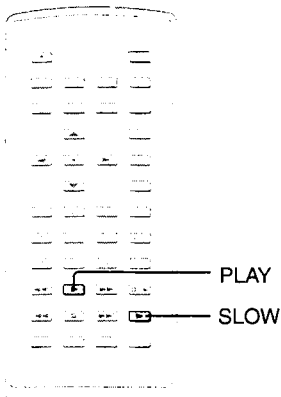

DVD

Playing in Slow Motion

You can play a DVD video disc in slow motion.



Press SLOW during playback.

The playback speed becomes half the normal speed.

[TV screen]

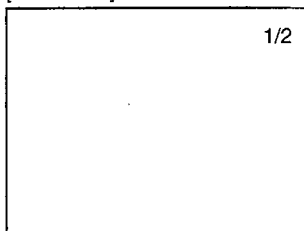

Each time you press the SLOW button, the playback speed changes as follows.

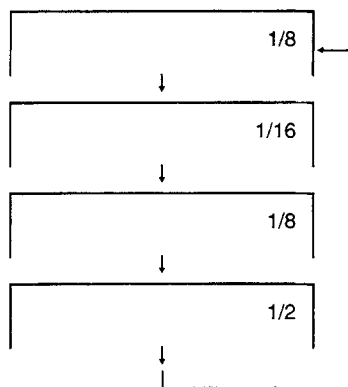

To resume normal playback



Press PLAY.

Note

The sound is muted during slow motion playback.

DVD CD

Resuming Playback from the Same Location

You can stop playback and resume playback later from the same location on the disc.



1 Press STOP during playback at the location you would like to return to later.

- The DVD video player memorizes the location where you stopped playback.
- The DVD video player stores that location in its memory, even if you turn off the player.

2

Leave the disc in the DVD video player.

Opening the disc tray cancels this function.



3 Press LAST PLAY.

The DVD video player resumes playback slightly before the location where you stopped playback.

Notes

- The Last Play function is canceled if the DVD video player is disconnected from the wall outlet, or if power is interrupted.
- Some DVD video discs start playback automatically when you insert them, and you do not have to press the PLAY button to start playback. If you use the Last Play function with these DVD video discs, turning off the DVD video player with the POWER button cancels the Last Play function.
- The Last Play function is canceled when you press the SET UP button to display the SET UP MENU on the TV screen.
- The Last Play function is canceled when you stop playback in a title that includes multiple camera angles and press the ANGLE button (page 33).
- You cannot use the Last Play function while operating the disc menu.

Locating a Specific Title, Chapter, or Track

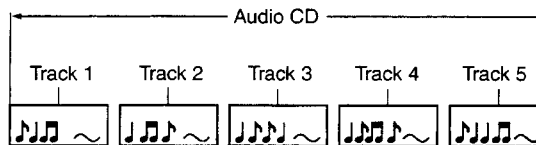
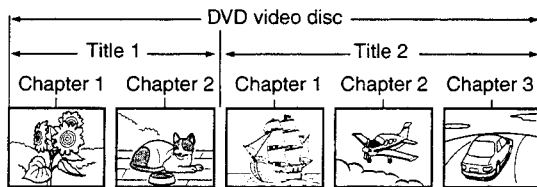

Normally, DVD video discs are divided into titles, and the titles are sub-divided into chapters. Audio CDs are divided into tracks. You can quickly locate any specific title, chapter, or track.

Locating a Title Using the Title Menu DVD

If a DVD video disc contains a title menu, you can locate a specific title using that title menu.

1 **TITLE**  **Press TITLE.**
The title menu appears on the TV screen.

Example of a title menu

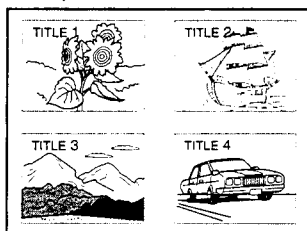

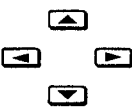
2  **Press ▲ / ▼ / ◀ / ▶ to select the title you want.**
If the titles in the title menu are assigned a number, you can directly locate a specific title by pressing its assigned number with the **number buttons**.

3 **ENTER**  **Press ENTER.**
The DVD video player starts playback from chapter 1 of the selected title.

Notes

- The instructions above describe the basic procedure. The procedure varies depending on the contents of the DVD video disc. If different instructions appear on the TV screen, follow those instructions.
- If you display the title menu during playback and press the TITLE button again without selecting any title, the DVD video player resumes playback from the point where you first pressed the TITLE button.
- If a DVD video disc does not contain a title menu, the title menu does not appear on the TV screen when you press the TITLE button.

Locating a Title DVD

You can locate a specific title by entering a title number.

1  **Press T to highlight the space next to TITLE.**

Example

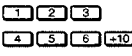

2  **Press the corresponding number buttons for the title you want.**

Example: To select title 2



To select title 12



3 **PLAY**  **Press PLAY.**
The DVD video player starts playback from chapter 1 of the selected title.

Notes

- You cannot locate a specific title on DVD video discs that do not contain title numbers.
- Pressing the CLEAR button erases the numbers next to TITLE and CHAPTER.
- You can select a preferred language for on-screen displays (see page 25).

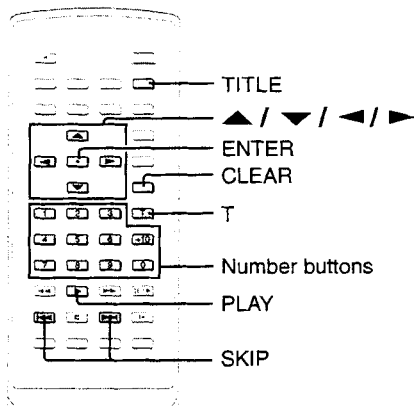

Locating a Specific Chapter or Track

You can locate consecutive chapters or tracks.



Press **SKIP** or repeatedly to display the chapter or track number you want.



The DVD video player starts playback from the selected chapter or track.

: To locate preceding chapters or tracks
When you press the **SKIP** button, the DVD video player starts playback from the beginning of the current chapter or track.
When you press the **SKIP** button twice, the DVD video player starts playback from the beginning of the preceding chapter or track.

: To locate succeeding chapters or tracks

Example: The DVD display would appear as follows when you select chapter 3.

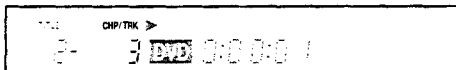

Locating a Specific Chapter or Track Directly

If you know the chapter or track number you want to play, you can locate it directly.



Press **T** repeatedly to highlight the space next to **CHAPTER**.

Skip this step if you are using an audio CD.

Example

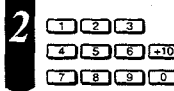

Press the corresponding number buttons of the chapter or track you want.

You can use the button to select numbers from 10 – 99.

Example: To select chapter or track 25

- →
- → →

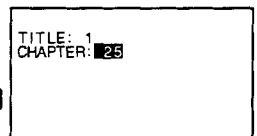

Press **PLAY**.

The DVD video player starts playback from the selected chapter or track.

To select a title and chapter number at the same time

Example: To select chapter 25 in title 2, press

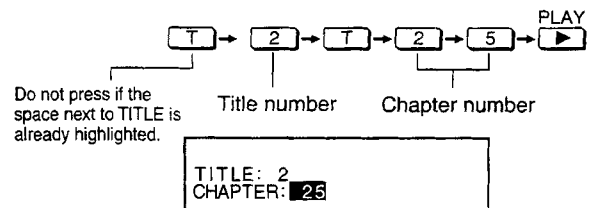

Note

Pressing the **CLEAR** button erases the numbers next to **TITLE** and **CHAPTER**.

Note

Some titles may not display the chapter number.

Playing Repeatedly

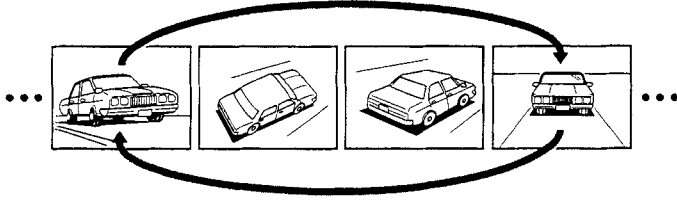

You can play a specific title, chapter, track, or segment repeatedly. (Title repeat, chapter/track repeat, A-B repeat)

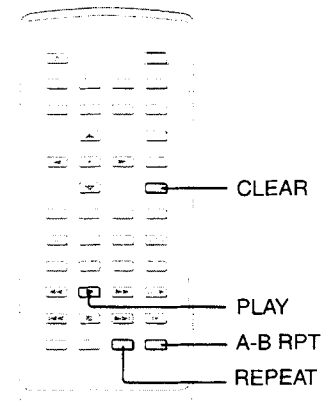

Repeating a Title, Chapter, or Track

You can play the same title, chapter, or track repeatedly. (Title, chapter/track repeat)

1 Begin playback of the title, chapter, or track you want to repeat (see pages 19 and 20).

2 Press **REPEAT** during playback. Each time you press the REPEAT button, the repeat mode changes as follows.

Chapter/track repeat
(Repeats the same DVD video disc chapter or audio CD track)

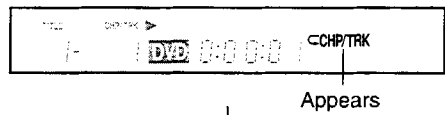

Title repeat
(Repeats the same DVD video disc title or entire audio CD)

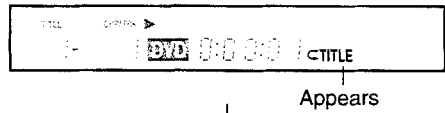

Repeat off (No indicator)
(Resumes normal playback)

Repeating a Specific Segment

You can play a specific segment repeatedly. (A-B repeat)

1 **A-B RPT** During playback, press A-B RPT at the beginning of the segment (point A) you want to play repeatedly.

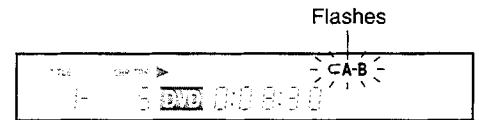

2 **A-B RPT** Press A-B RPT again at the end of the segment (point B).



The DVD video player automatically returns to point A and starts repeat playback of the selected segment (A-B).

To resume normal playback

CLEAR Press **CLEAR**.
The \leftarrow CHP/TRK and \leftarrow TITLE indicators disappear.

To resume normal playback

CLEAR Press **CLEAR**.
The \leftarrow A-B indicator disappears.

Note

The repeat mode appears on the TV screen during initial playback of the title, chapter, or track.

Notes

- You can specify a segment only within the current title.
- You cannot set the A-B repeat function for a segment that includes multiple camera angles.

Playing in a Favorite Order

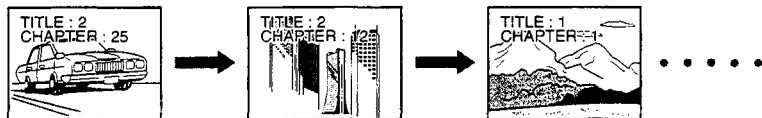

You can combine your favorite titles, chapters, or tracks and play them in any order. You can program up to 30 items into the memory. (Memory playback)

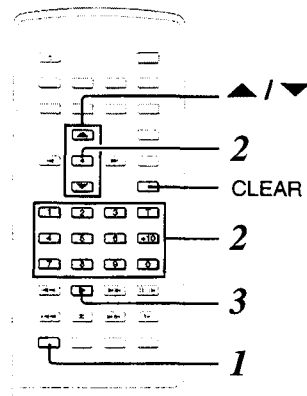

DVD CD

Setting Titles, Chapters, or Tracks in a Favorite Order

The DVD video player automatically plays titles, chapters, or tracks in the order you program.

1 MEMORY

While playback is stopped, insert a disc and press **MEMORY**.

The following menu appears.

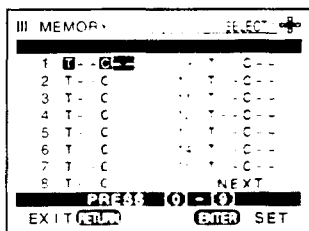

Flashes

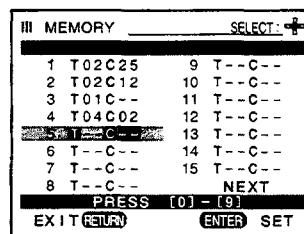

T: Title number
C: Chapter number



Programmed title, chapter, or track number appears.

To select another chapter in the same title, you do not need to select the title number.

If you make a mistake, press the **CLEAR** button, then press the correct number buttons.

2

Enter the items you want, in order, by pressing the number buttons, then **ENTER**, for each item.

Each time you press the T button, the -- indication next to T and C is highlighted in turn. Highlight the -- indication next to T (to select a title) or C (to select a chapter), then press the number buttons.

Example To play chapter 25 in title 2, chapter 12 in title 2, all the chapters in title 1, and chapter 2 in title 4, follow these steps.

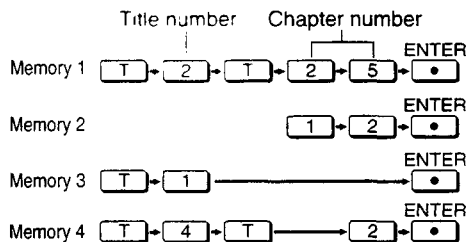

To select tracks from an audio CD in order, press the **number buttons** for the track, then press the **ENTER** button for each item you want.

3 PLAY

Press **PLAY** while the **MEMORY** menu appears on the TV screen.

The DVD video player starts memory playback.

To change the programmed items

- 1 While the MEMORY menu appears on the TV screen, press **▲ / ▼** to move the highlighted bar to the item you want to change.
- 2 Change the item following the instructions at step 2.

To resume normal playback

CLEAR Press **CLEAR**. The MEMORY indicator disappears.

Notes

- You cannot select title, chapter, and track numbers not included on the disc.
- If you press the MEMORY or RETURN button while the MEMORY menu appears on the TV screen, the MEMORY menu disappears.
- The programmed items will be cleared when:
 - you turn off the DVD video player, or
 - you remove the disc.

Playing in Random Order

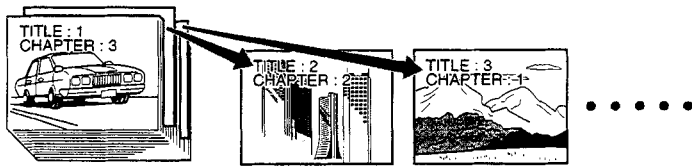

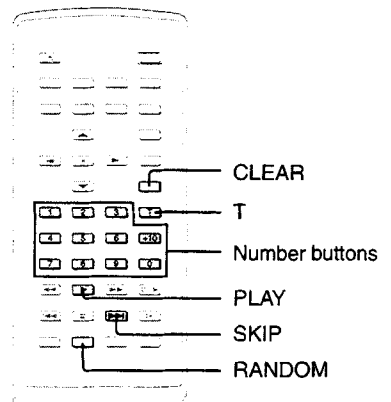

You can play titles, chapters within a title, or tracks in random order. (Random playback)



Playing Titles in Random Order DVD

The DVD video player automatically selects the titles in a DVD video disc and plays them randomly.

1  **Press T while playback is stopped, then press RANDOM.**



[TV screen]

TITLE RANDOM

If you press the RANDOM button during playback, the DVD video player automatically starts random playback after finishing the current title.

2  **Press PLAY.**

The DVD video player starts random playback.

The RANDOM indicator will appear in the DVD display.

Press the PLAY button within about five seconds after you press the RANDOM button.

To resume normal playback

 **Press CLEAR.**
The RANDOM indicator in the DVD display disappears.

Note You cannot use the random playback function and the memory playback function at the same time.

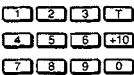

Playing Chapters or Tracks in Random Order DVD CD

The DVD video player automatically selects chapters within a title, or tracks on an audio CD, and plays them randomly.

1  **Press the appropriate number buttons for the title which contains the chapters you want to play back in random order.**

Skip this step when you want to enjoy the random playback function with an audio CD.

Example: To play back the chapters in title 2 in random order, press

 → 

2  **Press RANDOM while playback is stopped.**

[TV screen]

CHAPTER RANDOM

If you press the RANDOM button during playback, the DVD video player automatically starts random playback after finishing the current chapter or track.

3  **Press PLAY.**

The DVD video player starts random playback.

Press the PLAY button within about five seconds after you press the RANDOM button.

To resume normal playback

 **Press CLEAR.**
The RANDOM indicator in the DVD display disappears.

Notes

- You cannot use the random playback function and the memory playback function at the same time.
- If you press the SKIP  button during random playback, the DVD video player goes to another chapter or track and starts playback.

Using the On-Screen Display and DVD Display

You can view information about a disc and its operational status on the TV screen and DVD display.

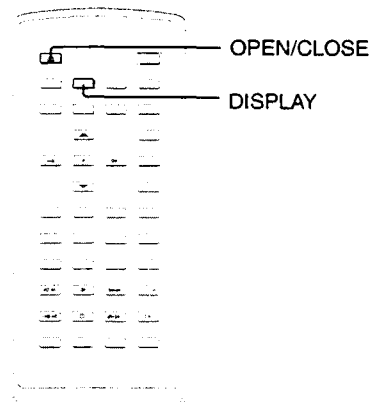

Checking the Operational Status

You can view the current title number, track number, and total playing time of the disc on the TV screen and DVD display.



Press DISPLAY while playback is stopped.

[TV screen]

DVD video disc

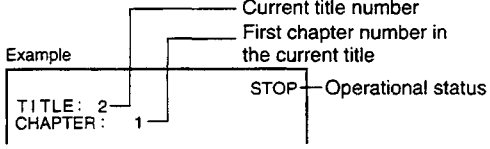

Audio CD

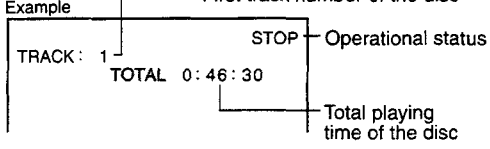

[DVD display]

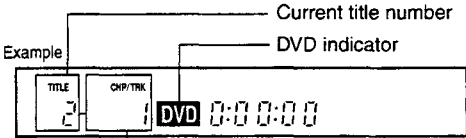

When an audio CD is in the DVD video player, the TOTAL indicator and total playing time of the disc appear.

Checking the Remaining Time and Mode Status

You can view the elapsed time, remaining time, and operation status of the disc on the TV screen and DVD display.



Press DISPLAY during playback.

[TV screen]

DVD video disc

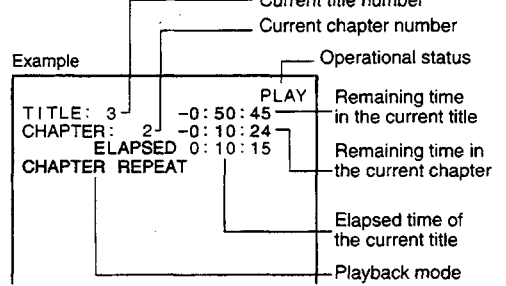

The REMAIN indicator and remaining time in the current title appear in the DVD display.

Audio CD

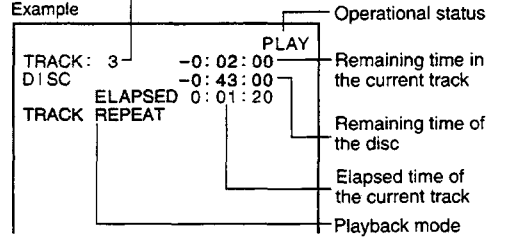

The REMAIN indicator and remaining time in the current track appear in the DVD display.

To turn off the on-screen display



Press DISPLAY again.

Total number of titles indication when inserting a DVD video disc



Place a DVD video disc in the disc tray, then press OPEN/CLOSE to close the disc tray.

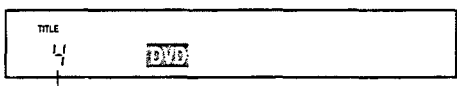

Total number of titles appears for about three seconds. Some DVD video discs start playback automatically when you insert them. In this case, the total number of titles does not appear. When you insert an audio CD, the total number of tracks and total playing time appear for about three seconds.



Press DISPLAY again during playback.

When you play an audio CD, the on-screen display turns off.

[TV screen]

Example

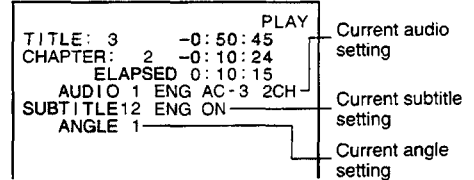

The abbreviation of the language (e.g. ENG) appears instead of the language name. See page 28 for a list of languages and their abbreviations.

To turn off the on-screen display



Press DISPLAY again.

Selecting a Display Language



You can select a preferred language for on-screen displays and the SET UP MENU.

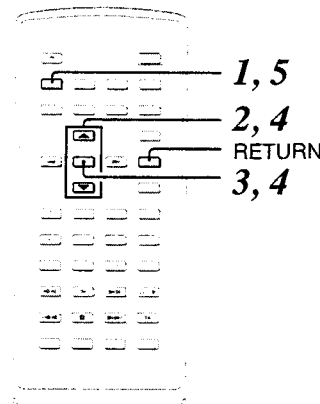

Selecting a Language for On-Screen Displays and the SET UP MENU

DVD CD

Preparations

- Turn on the TV and select the appropriate video input mode (Auxiliary input).
- Turn the DVD video player on.

1 **SET UP**
 Press SET UP while playback is stopped.

The following menu appears.

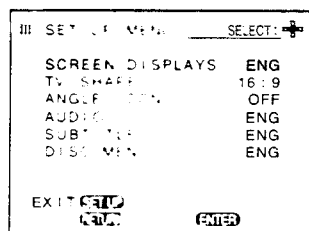

2
 Press ▲ / ▼ until "SCREEN DISPLAYS" is highlighted.

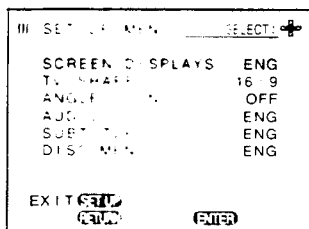

3 **ENTER**
 Press ENTER.

The following menu appears.

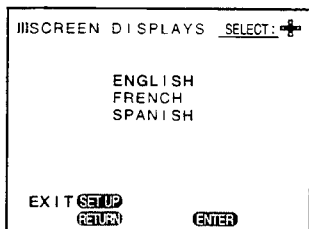

4
 Press ▲ / ▼ until your preferred language is highlighted, then press ENTER.

The following menu appears.

When you select "ENGLISH."

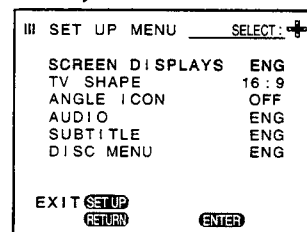

When you select "FRENCH."

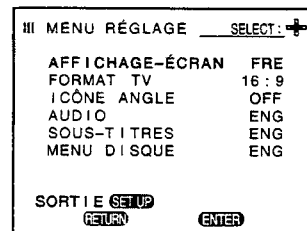

When you select "SPANISH."



The abbreviation of the language appears instead of the language name. See page 28 for a list of languages and their abbreviations.

5 **SET UP**
 Press SET UP.
 The SET UP MENU disappears.

Note

If you press the RETURN button while a menu appears on the TV screen, you will return to the previous screen.

Setting the Playback Picture Size

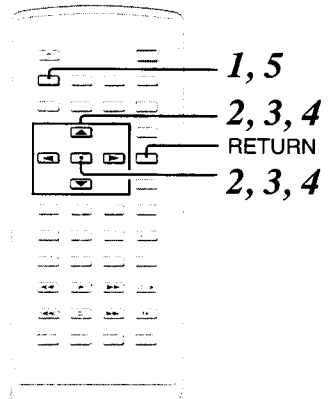
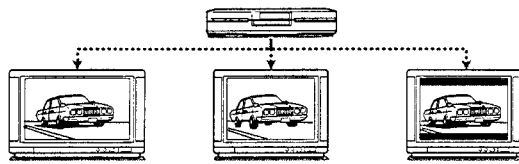

Set the default playback picture size according to the picture tube shape or aspect ratio of your TV. For example, normal or standard TV screens are a 4:3 aspect ratio.

Setting the Default Playback Picture Size

Preparations

- Turn on the TV and select the appropriate video input mode (Auxiliary input).
- Turn the DVD video player on.

1 **SET UP**
 Press **SET UP** while playback is stopped.

The following menu appears.

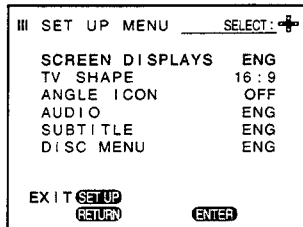

2
ENTER
 Press **▲ / ▼** to highlight "TV SHAPE," then press **ENTER**.

The following menu appears.

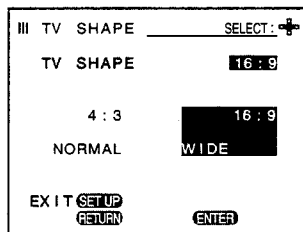

3
ENTER
 Press **◀ / ▶** to highlight the aspect ratio of your TV, then press **ENTER**.

If you select "4:3 / NORMAL:"
 The DISPLAY MODE setting menu appears. Proceed to step 4.

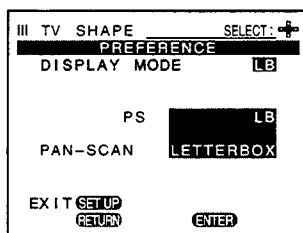

If you select "16:9 / WIDE:"
 The SET UP MENU appears. Proceed to step 5.

4
ENTER
 Press **◀ / ▶** to highlight the display mode you want, then press **ENTER**.

PS / PAN-SCAN:
 Displays pictures cropped to fill your TV screen. Either or both sides of the picture are cut off.

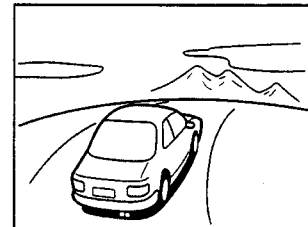

LB / LETTERBOX:
 Displays theatrical images with masking bars above and below the picture.

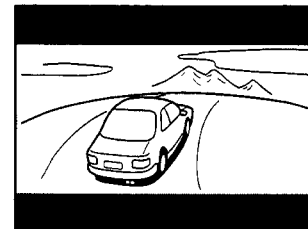

The SET UP MENU appears again. "PS" or "LB" appears on the SET UP MENU.

5 **SET UP**
 Press **SET UP**.
 The SET UP MENU disappears.

Notes

- The displayable picture size is preset on the DVD video disc. Therefore, the playback picture of some DVD video discs may not conform to the picture size you select above.
- When you playback DVD video discs recorded in the 4:3 picture size only, the playback picture always appears in the 4:3 picture size regardless of the TV shape setting.
- If you press the RETURN button while a menu appears on the TV screen, you will return to the previous screen.

Function Setup

Selecting a Disc Menu Language

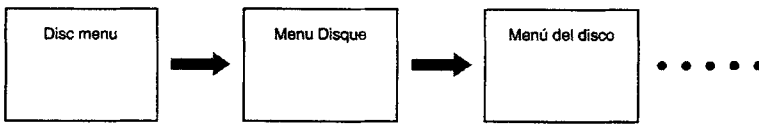

You can select a preferred language for the disc menu from the languages included on the DVD video disc.

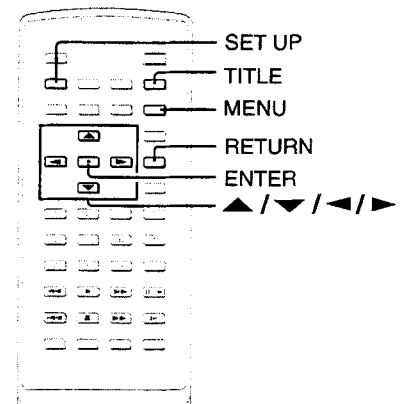



Setting the Default Disc Menu Language DVD

When you play a DVD video disc, the DVD video player automatically displays the disc menu in the pre-selected language if it is included on the disc.

1  Press **SET UP** while playback is stopped.

The SET UP MENU appears on the TV screen.

2 

Press **▲ / ▼** to highlight "DISC MENU," then press **ENTER**.

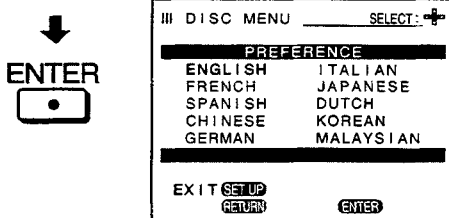
The following menu appears.





You can select the default disc menu language from the 10 languages displayed on the DISC MENU.

3 

Press **▲ / ▼ / ◀ / ▶** to highlight the default disc menu language, then press **ENTER**.

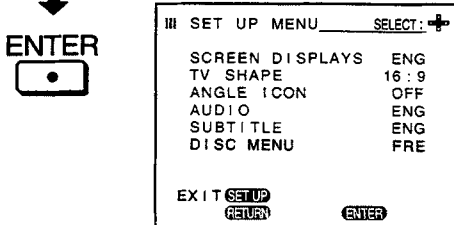
You will return to the SET UP MENU.





4  Press **SET UP**.
The SET UP MENU disappears.

Notes

- If you press the RETURN button while a menu appears on the TV screen, you will return to the previous screen.
- Some DVD video discs may not contain a disc menu.
- Some DVD video discs may not include your pre-selected disc menu language. In this event, the DVD video player automatically displays the disc menu in the disc's initial language setting.

Selecting a Disc Menu Language DVD

When a DVD video disc is inserted, you can display the disc menu and select a disc menu language from those included on the disc.

1 
 Press **TITLE** or **MENU** to display the disc menu.

2  Press **SET UP**.
The disc menu language included on the DVD video disc appears on the TV screen.

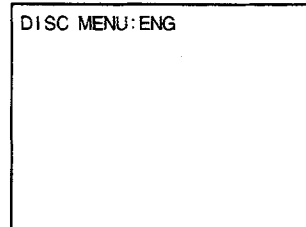

3  Press **SET UP** again to select the disc menu language.

Each time you press the SET UP button, the disc menu language, from those included on the DVD video disc, changes.
The abbreviation of the language appears instead of the language name. See the next page for a list of languages and their abbreviations.

4  Press **ENTER**.
The disc menu appears in the selected language.

Note

If the DVD video disc contains only one disc menu language, the disc menu language does not appear on the TV screen when you press the SET UP button at step 2.

Table of Languages and Their Abbreviations

Abbreviation of the language	Language	Abbreviation of the Language	Language	Abbreviation of the Language	Language	Abbreviation of the Language	Language
---	No alternate language	EO	Esperanto	LN	Lingala	SL	Slovenian
CHI	Chinese	ET	Estonian	LO	Laotian	SM	Samoan
DUT	Dutch	EU	Basque	LT	Lithuanian	SN	Shona
ENG	English	FA	Persian	LV	Latvian, Lettish	SO	Somali
FRE	French	FI	Finnish	MG	Malagasy	SQ	Albanian
GER	German	FJ	Fiji	MI	Maori	SR	Serbian
ITA	Italian	FO	Faroese	MK	Macedonian	SS	Siswati
JPN	Japanese	FY	Frisian	ML	Malayalam	ST	Sesotho
KOR	Korean	GA	Irish	MN	Mongolian	SU	Sundanese
MAY	Malay	GD	Scottish Gaelic	MO	Moldavian	SV	Swedish
SPA	Spanish	GL	Galician	MR	Marathi	SW	Swahili
AA	Afar	GN	Guarani	MT	Maltese	TA	Tamil
AB	Abkhazian	GU	Gujarati	MY	Burmese	TE	Telugu
AF	Afrikaans	HA	Hausa	NA	Nauru	TG	Tajik
AM	Amharic	HI	Hindi	NE	Nepali	TH	Thai
AR	Arabic	HR	Croatian	NO	Norwegian	TI	Tigrinya
AS	Assamese	HU	Hungarian	OC	Occitan	TK	Turkmen
AY	Aymara	HY	Armenian	OM	(Afan) Oromo	TL	Tagalog
AZ	Azerbaijani	IA	Interlingua	OR	Oriya	TN	Setswana
BA	Bashkir	IE	Interlingue	PA	Panjabi	TO	Tongan
BE	Belorussian	IK	Inupiak	PL	Polish	TR	Turkish
BG	Bulgarian	IN	Indonesian	PS	Pashto, Pushto	TS	Tsonga
BH	Bihari	IS	Icelandic	PT	Portuguese	TT	Tatar
BI	Bislama	IW	Hebrew	QU	Quechua	TW	Twi
BN	Bengali, Bangla	JI	Yiddish	RM	Rhaeto-Romance	UK	Ukrainian
BO	Tibetan	JW	Javanese	RN	Kirundi	UR	Urdu
BR	Breton	KA	Georgian	RO	Rumanian	UZ	Uzbek
CA	Catalan	KK	Kazakh	RU	Russian	VI	Vietnamese
CO	Corsican	KL	Greenlandic	RW	Kinyarwanda	VO	Volapük
CS	Czech	KM	Cambodian	SA	Sanskrit	WO	Wolof
CY	Welsh	KN	Kannada	SD	Sindhi	XH	Xhosa
DA	Danish	KS	Kashmiri	SG	Sango	YO	Yoruba
DZ	Bhutani	KU	Kurdish	SH	Serbo-Croatian	ZU	Zulu
EL	Greek	KY	Kirghiz	SI	Singhalese		
		LA	Latin	SK	Slovak		

Function Setup

Selecting a Language

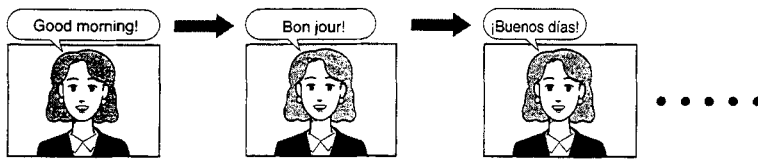

You can select a preferred language. DVD video discs may contain up to eight different languages.

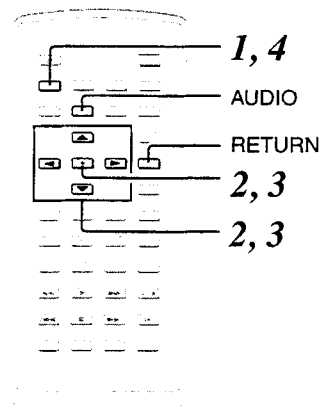

Setting the Default Language

When you play a DVD video disc, the DVD video player automatically plays the pre-selected language if it is included on the disc.

1 **SET UP**

Press **SET UP** while playback is stopped.

The following menu appears.

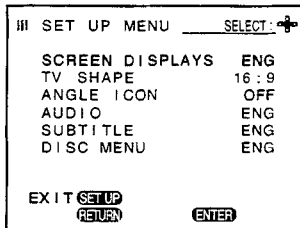

4 **SET UP**

Press **SET UP**.
The SET UP MENU disappears.

2

ENTER

Press **▲ / ▼** to highlight "AUDIO," then press **ENTER**.

The following menu appears.

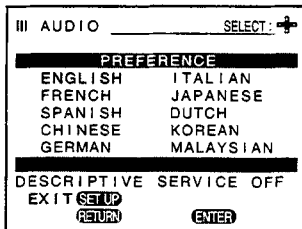

To play special dialogue for visually impaired persons

AUDIO

At step 3, press **AUDIO** before you press **ENTER** to set **DESCRIPTIVE SERVICE** to "ON."

Each press of the **AUDIO** button turns **DESCRIPTIVE SERVICE** to "ON" or "OFF."

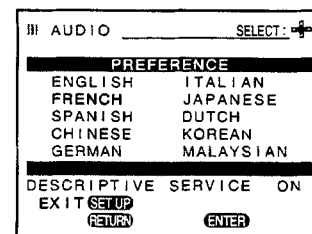

Some DVD video discs contain special dialogue that describes the actions on-screen. When you set **DESCRIPTIVE SERVICE** to "ON," the DVD video player automatically plays this special dialogue.

3

ENTER

Press **▲ / ▼ / ◀ / ▶** to highlight the default language, then press **ENTER**.

You will return to the SET UP MENU.

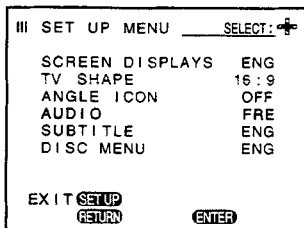

Notes

- If you press the **RETURN** button while a menu appears on the TV screen, you will return to the previous screen.
- Some DVD video discs may not include your pre-selected language. In this case, the DVD video player automatically plays back the disc's initial language setting.

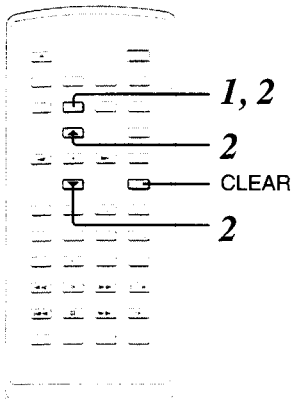

Selecting a Playback Audio Setting

You can easily select a playback audio setting (language, recording system, and audio channel) from those included on the DVD video disc during playback.

1 **AUDIO** Press **AUDIO** during playback.

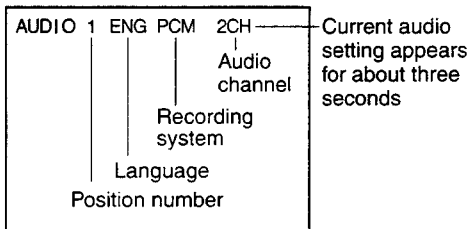

The abbreviation of the language appears instead of the language name. See page 28 for a list of languages and their abbreviations.

To turn off the audio setting indication

CLEAR Press **CLEAR**.

About recording systems

This DVD video player uses the Dolby Digital (AC-3) and PCM recording systems and cannot play DVD video discs recorded in any other recording system. Select the audio setting "PCM" or "AC-3" depending on the kind of audio system you connected to the DVD video player (pages 13 and 14). AC-3 5.1 Channel is displayed as "AC-3 6CH."

2 **AUDIO** Press **AUDIO** or **▲** while the audio setting appears on the TV screen.



Each time you press the AUDIO or **▲** button, the audio settings included on the DVD video disc change.

Example

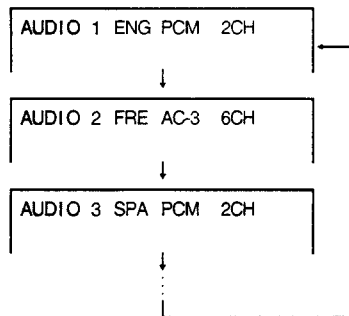

▼ : Cycles backward

Notes

- You can change the language only on DVD video discs containing more than one language.
- The included languages differ depending on the DVD video discs.

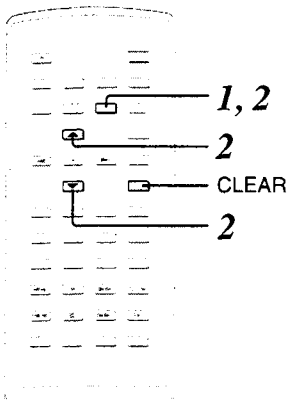

Selecting a Subtitle Language

You can easily select the subtitle language from those included on the DVD video disc during playback.

1 Press SUBTITLE during playback.

SUBTITLE

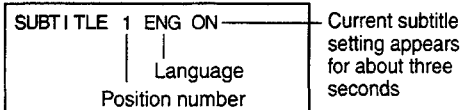

The abbreviation of the language appears instead of the language name. (See page 28.) "NO SUBTITLES" appears if no subtitles are available.

2 Press SUBTITLE or ▲ while the subtitle setting appears on the TV screen.

SUBTITLE



Each time you press the SUBTITLE or ▲ button, the subtitle languages included on the DVD video disc change.

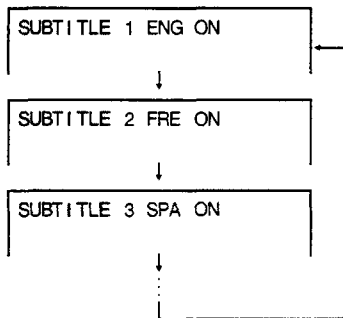

▼ : Cycles backward

To turn off the subtitle setting indication

CLEAR



Press CLEAR.

Notes

- You can change the subtitle language only on DVD video discs containing more than one subtitle language.
- The included subtitle languages differ depending on the DVD video disc.
- During some scenes, the subtitles may not appear immediately after you change the subtitle language by pressing the ▲ / ▼ buttons.
- Even if you select "NO SUBTITLES" as the default setting, you can turn on the subtitles and select a language by pressing the SUBTITLE button.

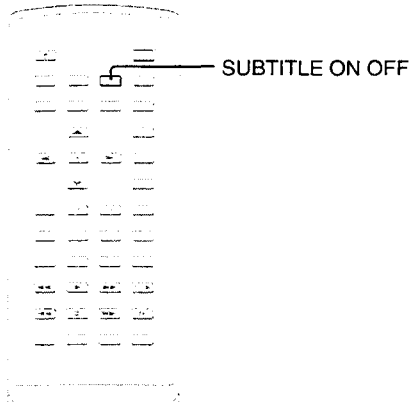

Displaying Subtitles

You can display subtitles on the TV screen.

Press SUBTITLE ON OFF.

SUBTITLE ON OFF

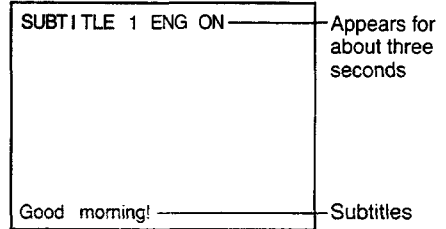

To turn off the subtitles

SUBTITLE ON OFF



Press SUBTITLE ON OFF.

The subtitles disappear.

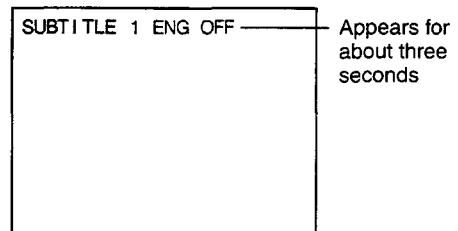

Notes

- You can display subtitles only if the DVD video disc includes subtitles.
- Some DVD video discs are set to display subtitles automatically, and you cannot turn them off even if you set the subtitle function to off.
- During some scenes, the subtitles may not appear immediately after you press the SUBTITLE ON OFF button.
- Even if you select "NO SUBTITLES" as the default setting, you can turn the subtitles on or off by pressing the SUBTITLE ON OFF button after you change the subtitle language by pressing the SUBTITLE button.

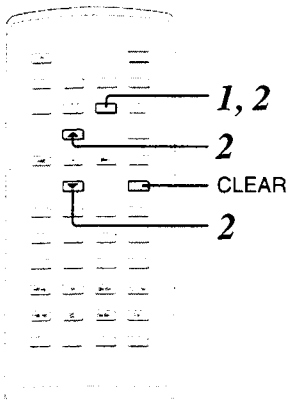

Selecting a Subtitle Language

You can easily select the subtitle language from those included on the DVD video disc during playback.

1 Press SUBTITLE during playback.

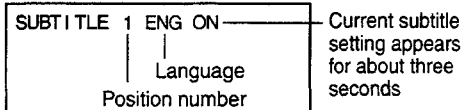

The abbreviation of the language appears instead of the language name. (See page 28.) "NO SUBTITLES" appears if no subtitles are available.

2 Press SUBTITLE or ▲ while the subtitle setting appears on the TV screen.



Each time you press the SUBTITLE or ▲ button, the subtitle languages included on the DVD video disc change.

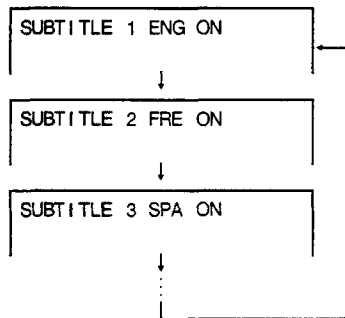

▼ : Cycles backward

To turn off the subtitle setting indication



Press CLEAR.

Notes

- You can change the subtitle language only on DVD video discs containing more than one subtitle language.
- The included subtitle languages differ depending on the DVD video disc.
- During some scenes, the subtitles may not appear immediately after you change the subtitle language by pressing the ▲ / ▼ buttons.
- Even if you select "NO SUBTITLES" as the default setting, you can turn on the subtitles and select a language by pressing the SUBTITLE button.

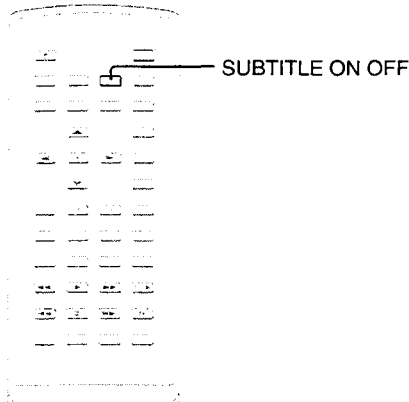

Displaying Subtitles

You can display subtitles on the TV screen.

Press SUBTITLE ON OFF.

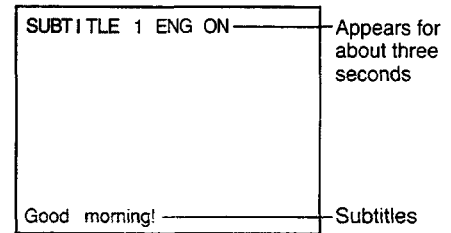

To turn off the subtitles



Press SUBTITLE ON OFF.

The subtitles disappear.

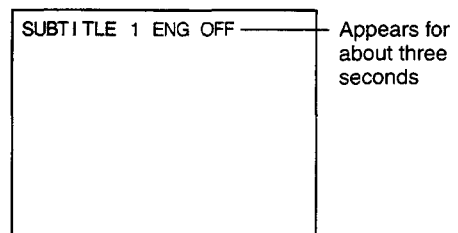

Notes

- You can display subtitles only if the DVD video disc includes subtitles.
- Some DVD video discs are set to display subtitles automatically, and you cannot turn them off even if you set the subtitle function to off.
- During some scenes, the subtitles may not appear immediately after you press the SUBTITLE ON OFF button.
- Even if you select "NO SUBTITLES" as the default setting, you can turn the subtitles on or off by pressing the SUBTITLE ON OFF button after you change the subtitle language by pressing the SUBTITLE button.

Selecting the Camera Angle

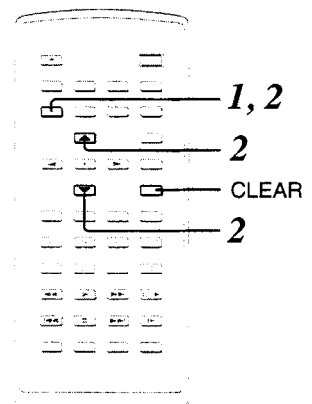
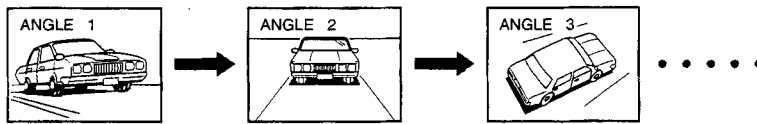

You can watch scenes from up to nine different camera angles (multiple angle).

DVD

Changing the Camera Angle

1 ANGLE

Press ANGLE while playing a scene recorded from multiple angles.

Press the ANGLE button while the angle icon in the DVD display is flashing.

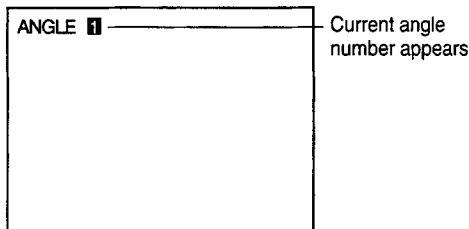

To check if the scene is recorded from multiple angles or not

On some DVD video discs, only some scenes of the title may be recorded from multiple angles. You can check which scenes are recorded from multiple angles by the status of the angle icon in the DVD display.

When playing a title that contains at least one scene recorded from multiple angles, the DVD display appears as follows.

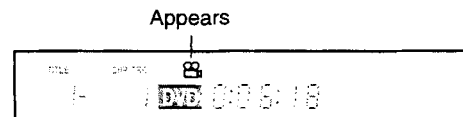

2 ANGLE

Press ANGLE or ▲ while the angle number appears on the TV screen.

Each time you press the ANGLE or ▲ button, the camera angle changes.

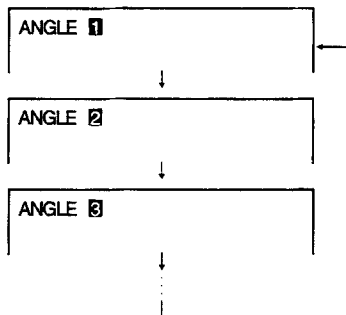

▼ : Cycles backward

You can change the camera angle directly by pressing the number buttons for the angle number.

When playing a scene recorded from multiple angles, the DVD display appears as follows.

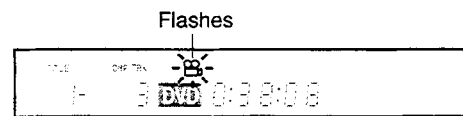

To turn off the angle number indication

CLEAR
 Press CLEAR.

Notes

- You can change the camera angle only on scenes recorded from multiple angles.
- You can change the camera angle during still playback. The camera angle changes to the new setting when you resume normal playback.
- If the current title has scenes recorded from multiple angles, you can change the camera angle while playback is stopped.

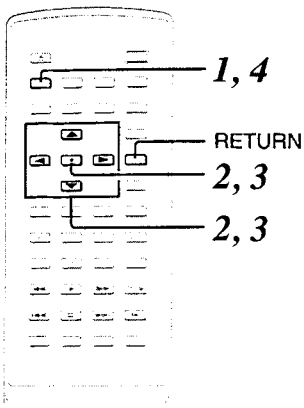

Displaying the Angle Icon on the TV Screen

You can display the angle icon on the TV screen to determine if a scene is recorded from multiple angles.



1 **SET UP**

Press **SET UP** while playback is stopped.

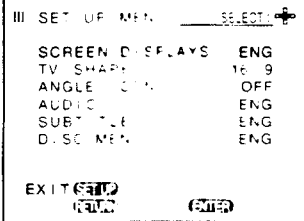
The following menu appears.



2





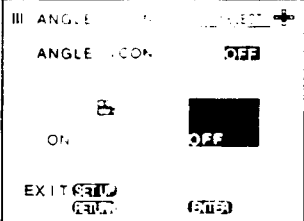

Press **▲ / ▼** to highlight “**ANGLE ICON**,” then press **ENTER**.

The following menu appears.





3

Press **◀ / ▶** to highlight “**ON**,” then press **ENTER**.

You will return to the **SET UP MENU**.

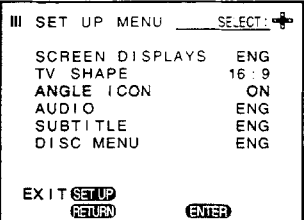

4 **SET UP**

Press **SET UP**.

The **SET UP MENU** disappears.

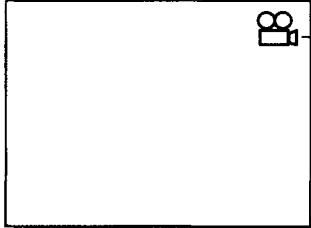

The angle icon automatically appears on the TV screen while playing a scene recorded from multiple angles.



Appears in white

The angle icon turns red while displaying the angle setting on the TV screen.

To turn off the angle icon

At step 3, press **◀ / ▶** to highlight “**OFF**,” then press **ENTER**.

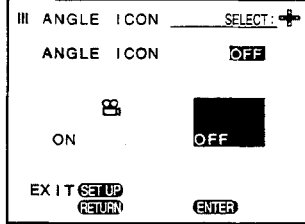

Note

If you press the **RETURN** button while a menu appears on the TV screen, you will return to the previous screen.

Setting the Parental Lock

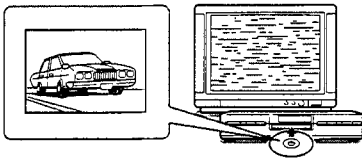

You can use the parental lock function only with DVD video discs equipped with the parental lock function.

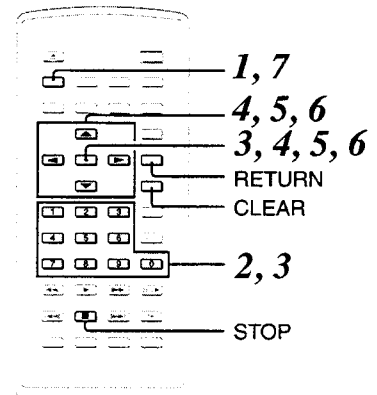

Setting the Parental Lock

DVD video discs equipped with the parental lock function are rated according to their content. The contents allowed by a parental lock level and the way a DVD video disc can be controlled are different from disc to disc. For example, you can cut out violent scenes unsuitable for children and replace them with more suitable scenes, or lock out playback of the disc altogether.

1 **SET UP**

Press SET UP while playback is stopped.
 The SET UP MENU appears on the TV screen.

2 **9**

Press 9 twice.
 The following menu appears.

III PARENTAL LOCK

PRESET SECURITY CODE

■■■■

PRESS [0] - [9]

EXIT **SETUP** **RETURN** **ENTER**

3 **1 2 3**
4 5 6
7 8 9 0
ENTER

Press the number buttons to create a four-digit security code, then press ENTER.
 Example

■■■■

III PARENTAL LOCK SELECT: +

PARENTAL LOCK OFF

ON OFF

USAB

If you make a mistake before pressing the ENTER button, press the **CLEAR** button and enter your four-digit security code again.

4 **ENTER**

Press </> to highlight "ON," then press ENTER.
 The following menu appears.

III PARENTAL LOCK SELECT: +

COUNTRY USA

USA CAN

LEVEL8 LEVEL8

EXIT **SETUP** **RETURN** **ENTER**

5 **ENTER**

Press </> to highlight the country whose standards were used to rate the DVD video disc, then press ENTER.
 The following menu appears.

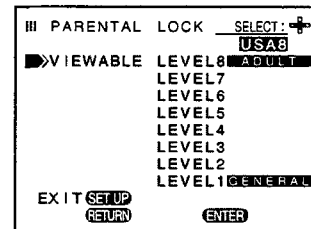

6 **ENTER**

Press ▲ / ▼ to highlight the parental lock level, then press ENTER.
 You cannot play DVD video discs rated higher than the level you selected unless you cancel the parental lock function.
 For example, when you select level 7, the discs rated higher than level 7 are locked out and cannot be played.

Example: When you select USA

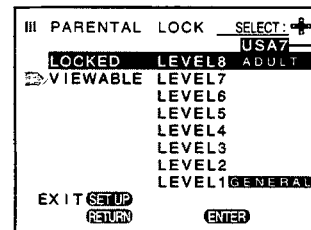

When you select "CAN," "CAN7" appears instead.

The parental lock level is equivalent to the following USA movie ratings.

- | | |
|----------------|-------------|
| LEVEL 7: NC-17 | LEVEL 3: PG |
| LEVEL 6: R | LEVEL 1: G |
| LEVEL 4: PG 13 | |

The parental lock levels for "CAN" (Canada) are included for future use. Check the appropriate parental lock level when you buy a DVD video disc equipped with the parental lock function in the future.

7 **SET UP**

Press SET UP.
 The SET UP MENU disappears.

To change the parental lock level

You can change the parental lock level by following the steps in "Setting the Parental Lock."

At step 3, press the **number buttons** to enter your four-digit security code, then continue to step 4.

If you make a mistake, press the **CLEAR** button and enter the correct four-digit security code.

If you enter the security code incorrectly, "WRONG NUMBER" flashes on the TV screen. Enter the correct code.

To change your four-digit security code

You can change your four-digit security code.

- 1 Follow steps 1 and 2 in "Setting the Parental Lock."
- 2 Press the **STOP** button four times while the security code menu appears on the TV screen.

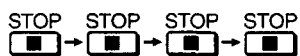

The four-digit security code is cleared.

- 3 Press the **number buttons** to create a new four-digit security code, then press the **ENTER** button.
- 4 Complete steps 4 – 7 in "Setting the Parental Lock."

To cancel the parental lock function

- 1 Follow steps 1 and 2 in "Setting the Parental Lock."
- 2 Press the **number buttons** to enter your four-digit security code, then press the **ENTER** button.

If you make a mistake, press the **CLEAR** button and enter the correct four-digit security code.

If you enter the security code incorrectly, "WRONG NUMBER" flashes on the TV screen. Enter the correct code.
- 3 Press **◀ / ▶** to highlight "OFF," then press the **ENTER** button.

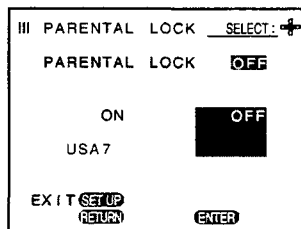

The SET UP MENU appears again.

- 4 Press the **SET UP** button.

The SET UP MENU disappears, and the parental lock function is cancelled.

Notes

- DVD video discs may or may not respond to the parental lock settings. Make sure this function works with your DVD video discs.
- If you press the RETURN button while a menu appears on the TV screen, you will return to the previous screen.

Notes on Discs

This section shows you how to handle, clean, and store discs.

Handling Discs

- Do not touch the playback side of the disc.

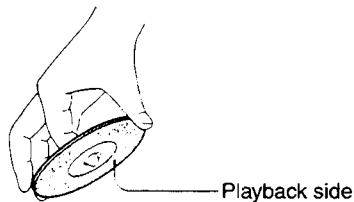

- Do not attach paper or tape to discs.



Cleaning Discs

- Fingerprints and dust on the disc cause picture and sound deterioration. Wipe the disc from the center outward with a soft cloth. Always keep the disc clean.

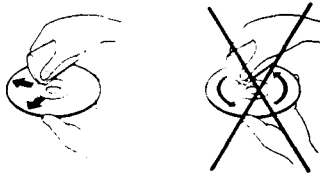

- If you cannot wipe off the dust with a soft cloth, wipe the disc lightly with a slightly moistened soft cloth then dry the disc with a dry cloth.
- Do not use any type of solvent such as thinner, benzene, commercially available cleaners or antistatic spray for vinyl LPs. These may damage the disc.

Storing Discs

- Do not store discs in a place subject to direct sunlight or heat.
- Do not store discs in places subject to moisture and dust, such as in a bathroom or near a humidifier.
- Store discs vertically in a case. Stacking or placing objects on discs may cause warping.

About This Owner's Manual

This owner's manual explains the basic operations of this DVD video player.

Some DVD video discs have functions that may not be explained in this owner's manual. Therefore, some instructions may differ from this owner's manual, and there may be extra instructions. In this case, follow the instructions displayed on the TV screen or DVD video disc package.

The icon "☞" may appear on the TV screen during operation. This icon means the function explained in this owner's manual is not available on the DVD video disc.

Playable Discs

This DVD video player can play the following discs.

	Disc mark	Contents	Disc size	Maximum playback time
DVD video discs		Audio + Video (moving pictures)	12 cm	Approx. four hours (single sided disc) Approx. eight hours (double sided disc)
			8 cm	Approx. 80 minutes (single sided disc) Approx. 160 minutes (double sided disc)
Audio CDs		Audio	12 cm	74 minutes
			8 cm (CD single)	20 minutes

You cannot play discs other than those listed above.

This DVD video player uses the NTSC color system, and cannot play DVD video discs recorded in any other color system (PAL, SECAM, etc.).

Notes on Unauthorized Discs



THIS DVD VIDEO PLAYER IS MANUFACTURED FOR PLAYBACK OF REGION 1 (USA, CANADA) ENCODED DVD SOFTWARE. USE OF SOFTWARE NOT INTENDED FOR REGION 1 PLAYBACK MAY RESULT IN UNDESIRABLE PLAYER PERFORMANCE.

You may not be able to play some DVD video discs on this player if they were purchased outside your geographic area or made for business purposes.

When you try to play an unauthorized disc, "DISC PLAYBACK UNAUTHORIZED CONSULT OWNERS MANUAL FOR FURTHER INFORMATION" appears on the TV screen.

Notes on Copyright

It is forbidden by law to copy, broadcast, show, broadcast on cable, play in public, and rent copyrighted material without permission.

DVD video discs are copy protected, and any recordings made from these discs will be distorted.

This product incorporates copyright protection technology that is protected by method claims of certain U.S. patents and other intellectual property rights owned by Macrovision Corporation and other rights owners. Use of this copyright protection technology must be authorized by Macrovision Corporation, and is intended for home and other limited viewing uses only unless otherwise authorized by Macrovision Corporation. Reverse engineering or disassembly is prohibited.

Before Calling Service Personnel

Check the following guide for the possible cause of a problem before requesting service.

Symptoms and Correction

Symptom	Cause	Correction	Page
No power	The power plug is disconnected.	Connect the power plug into the wall outlet securely.	11, 12
The power is on, but the DVD video player does not work.	No disc is inserted.	Insert a disc. (Check that the DVD or audio CD indicator in the DVD display is lit.)	15
No picture	• The TV is not set to receive a DVD signal.	• Set your TV to accept Auxiliary input.	15
	• The video cable is not connected securely.	• Connect the video cable to the jacks securely.	11, 12, 13, 14
	• The TV power is turned off.	• Turn on the TV.	15
No sound	• The equipment connected with the audio cable is not set to receive the DVD signal.	• Select the correct input mode of the audio receiver so you can listen to the sound from the DVD video player.	15
	• The audio cables are not connected securely.	• Connect the audio cable to the jacks securely.	11, 12, 13, 14
	• The power of the equipment connected with the audio cable is turned off.	• Turn on the equipment connected with the audio cable.	15
	• The AUDIO SELECTOR is set to the wrong position.	• Set the AUDIO SELECTOR to the correct position, then turn on the DVD video player again by pressing the POWER button.	11, 12, 13, 14
The playback picture has occasional distortion.	The disc is dirty.	• Eject the disc and clean it.	37
	–	• Sometimes a small amount of picture distortion may appear. This is not a malfunction.	–
The DVD video player does not start playback.	• No disc is inserted.	• Insert a disc. (Check that the DVD or audio CD indicator in the DVD display is lit.)	15
	• An unplayable disc is inserted.	• Insert a playable disc. (Check the disc type and color system.)	37
	• The disc is placed upside down.	• Place the disc with the playback side down.	15
	• The disc is not placed within the guide.	• Place the disc in the disc tray correctly inside the guide.	15
	• The disc is dirty.	• Clean the disc.	37
	• A menu is on the TV screen.	• Press the SET UP button to remove the menu screen.	–
	• The parental lock function is set.	• Cancel the parental lock function or change the parental lock level.	35, 36
Buttons do not work.	Power supply fluctuations or other abnormalities may interrupt correct operation.	Turn the power on or off with the POWER button. Or disconnect the power plug and insert it into the wall outlet again.	–
The remote control does not work properly.	• The remote control is not pointed at the remote sensor of the DVD video player.	• Point the remote control at the remote sensor of the DVD video player.	10
	• The remote control is too far from the DVD video player.	• Operate the remote control within about seven meters.	10
	• There is an obstacle between the remote control and the DVD video player.	• Remove the obstacle.	–
	• The batteries in the remote control are exhausted.	• Replace the batteries with new ones.	10

Specifications

DVD Video Player/Outputs/Supplied Accessories

[DVD Video Player]

Power supply	120 V AC, 60 Hz
Power consumption	20 W
Weight	3.4 kg
External dimensions	430 × 81 × 308 mm (W/H/D)
Signal system	Standard NTSC
Laser	Semiconductor laser, wavelength 650 nm
Frequency range (digital audio)	4 Hz to 20 kHz
Signal-to-noise ratio (digital audio)	More than 96 dB (EIAJ)
Audio dynamic range (digital audio)	More than 93 dB (EIAJ)
Harmonic distortion (digital audio)	Less than 0.006 %
Wow and flutter	Below measurable level (less than ±0.001 % (W.PEAK)) (EIAJ)
Operating conditions	Temperature: 5 °C to 35 °C, Operation status: Horizontal position

[Outputs]

Video output	1.0 V (p-p), 75 Ω, negative sync., pin jack × 1
S video output	(Y) 1.0 V (p-p), 75 Ω, negative sync., Mini DIN 4-pin × 1 (C) 0.286 V (p-p), 75 Ω
Audio output (digital audio)	0.5 V (p-p), 75 Ω, pin jack × 1
Audio output (analog audio)	2.0 V (rms), 330 Ω, pin jack (L, R) × 1

[Supplied Accessories]

S video cable	1
Audio/video cable	1
Remote control	1
Batteries (AA)	2

- Designs and specifications are subject to change without notice.

Alphabetical Order

- A**
 - Accessories 39

- B**
 - Battery 10

- C**
 - Camera angle 33
 - Chapter repeat 21
 - Connections 11–14
 - Connecting to an amplifier 12–14
 - Connecting to an audio system 12
 - Connecting to a TV 11
 - Connecting to speakers 13, 14

- D**
 - Disc menu 27
 - Dolby Digital (AC-3) 13
 - Dolby Pro Logic Surround Sound 14
 - DVD display 7

- L**
 - Letterbox 26

- M**
 - Memory playback 22
 - Moisture condensation 5
 - Multiple angle 33

- N**
 - Notes on discs 37

- O**
 - On-screen display 24

- P**
 - Pan-scan 26
 - Parental lock 35
 - Playable discs 37
 - Playback (basic) 15
 - Eight times the normal speed 17
 - Frame by frame 17
 - Memory playback 22
 - Random playback 23
 - Repeat playback 21
 - Slow motion playback 18
 - Still playback 16
 - Twice the normal speed 17
 - Precautions 5

- R**
 - Random playback 23
 - Remaining time indicator 24
 - Remote control 10
 - Repeat playback 21
 - A-B repeat
 - Chapter repeat
 - Title repeat
 - Track repeat
 - Resuming playback from the same location 18

- S**
 - Safety precautions 1–2
 - Searching
 - Chapter/track search 20
 - Title search 19
 - Selecting a display language 25
 - Selecting a language 29
 - Selecting a subtitle language 31
 - Setting the playback picture size 26
 - Specifications 39
 - Supplied accessories 39

- T**
 - Title repeat 21
 - Troubleshooting 38
 - Two-Channel Digital Stereo Sound 14

Philips Consumer Electronics Company Factory Service Center Locations

See Reverse Side for More Details.

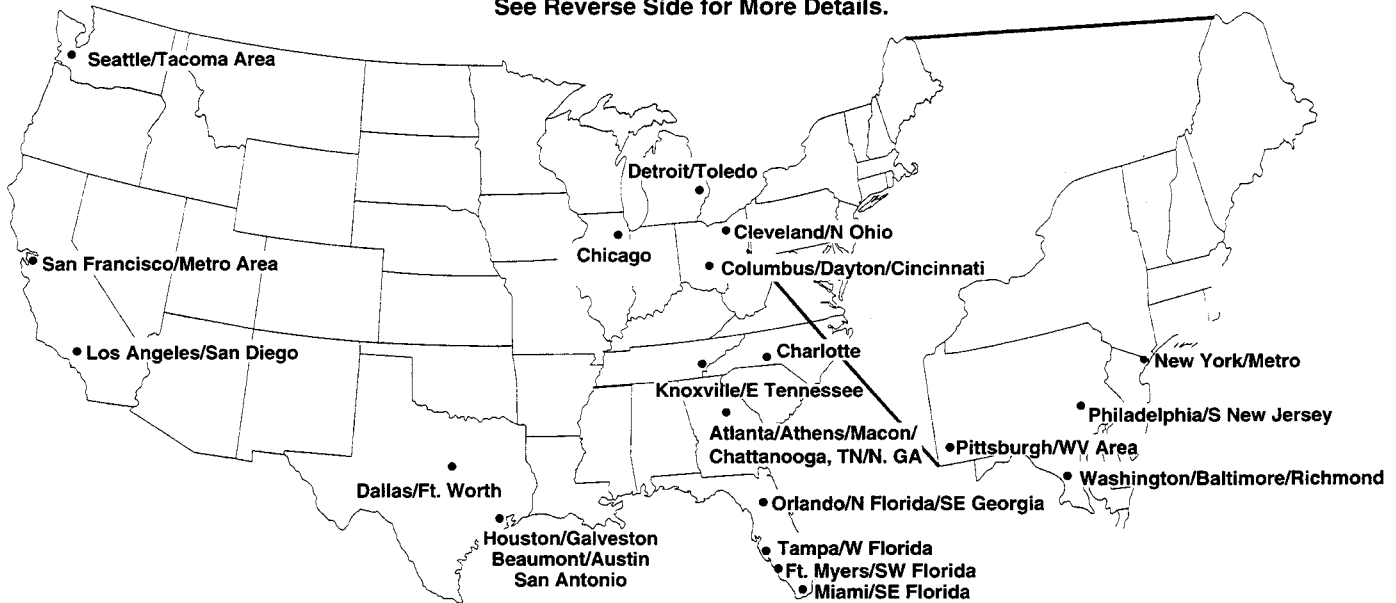

NOTE: If you reside in one of our Philips Factory Service Branch areas (see directory on back), you can contact the nearest Service Branch to obtain efficient and expedient repair for your product. If your product is In-Warranty, you should have proof-of-purchase to ensure No Charge Service.

For Out-of-Warranty service, call the location nearest you.

NOTA: Si vous résidez dans une des régions desservies par une succursale de service après vente du fabricant Philips (voir liste ci-dessous), vous pourrez contacter la branche de service après vente la plus près de chez vous pour obtenir un service après vente rapide et efficace. Si le produit est sous garantie, il suffira de présenter une preuve d'achat pour bénéficier d'un service sans frais. Pour les produits non couverts par la garantie, contactez le centre le plus près de chez vous.

NOTA: Si Ud. reside en una de nuestras zonas para sucursales Philips de servicio al de fábrica (ver directorio más abajo), Ud. puede comunicarse con la sucursal de servicio más cercana para obtener una reparación oportuna y eficaz de su producto. Si su producto está todavía bajo garantía, Ud. debe presentar comprobante de compra para no ocasionar ningunos cargos por servicio. Para servicio después del vencimiento de la garantía, llame al lugar más cercano de los abajo indicados.



EL4482-3 Rev. Q

QUALITY SERVICE IS AS CLOSE AS YOUR TELEPHONE! SIMPLY LOOK OVER THE LIST BELOW FOR THE NUMBER OF A FACTORY SERVICE CENTER NEAR YOU. YOUR PRODUCT WILL RECEIVE EFFICIENT AND EXPEDIENT CARRY-IN, MAIL-IN, OR IN-HOME SERVICE, AND YOU WILL RECEIVE PEACE OF MIND, KNOWING YOUR PRODUCT IS BEING GIVEN THE EXPERT ATTENTION OF PHILIPS' FACTORY SERVICE. AND, IF THE PHONE NUMBER LISTED FOR YOUR AREA IS LONG DISTANCE, CALL 1-800-242-9225 FOR FACTORY SERVICE.

COMMENT OBTENIR NOTRE SERVICE APRÈS VENTE RAPIDE ET EFFICACE SOIT PAR COURRIER, À DOMICILE, OU EN SE PRÉSENTANT À UN CENTRE DE SERVICE PHILIPS. PLUS DE 600 CENTRES DE RÉCEPTION DE PRODUITS À RÉPARER À TRAVERS LE PAYS: CONTACTER LE CENTRE DE SERVICE AUX CONSOMMATEURS LE PLUS PROCHE POUR SAVOIR L'EMPLACEMENT DE CES DÉPÔTS DANS UN RAYON DE 50 À 75 MILES (80 KM À 120 KM) DU CENTRE DE SERVICE LOCAL.

CÓMO OBTENER UN SERVICIO OPORTUNO Y EFICIENTE POR CORREO, EN CASA O EN PERSONA PARA SU PRODUCTO A TRAVÉS DE UN CENTRO PHILIPS DE SERVICIO. MAS DE 600 SITIOS POR TODO EL PAIS PARA LA RECEPCION DE PRODUCTOS NECESITADOS DE REPARACIONES: COMUNICARSE CON EL CENTRO DE SERVICIO DE FABRICA MAS CERCANO PARA ESTOS LUGARES DENTRO DE UN RADIO DE 80 A 120 KM (50 A 75 MILLAS) DEL CENTRO DE SERVICIO LOCAL.

<p>Atlanta - Athens-- Macon - Chattanooga, TN-- North Georgia Area 200 North Cobb Parkway Suite 120 Marietta, GA 30062 (770) 795-0085</p>	<p>Dallas - Ft. Worth Area 13375 Stemmons Freeway Suite 200 Dallas, Texas 75234 (972) 243-4775</p>	<p>Miami - Southeast Florida Area 2099 W. Atlantic Blvd. Pompano Beach, FL 33069 (954) 978-0467</p>	<p>San Francisco - Oakland - San Jose Area 3370 Montgomery Drive Santa Clara, CA 95054 (408) 492-9013</p>
<p>Charlotte - Winston Salem - Greensboro Area 520-G Clanton Road Charlotte, NC 28217 (704) 529-6330</p>	<p>Detroit Area 25173 Dequindre Madison Heights, MI 48071 (810) 544-2110</p>	<p>New York Metro Area 116 Charlotte Avenue Hicksville, NY 11801 (516) 933-1780 Nassau County</p>	<p>Seattle--Tacoma Area 1055 Andover Park East Tukwila, WA 98188 (206) 575-6288</p>
<p>Chicago--Naperville--Rockford - Kenosha - Beloit - Madison - Gary - Merrillville Area 1360 W. Hamilton Parkway Itasca, IL 60143 (708) 775-0990</p>	<p>Ft. Myers Satellite Location 11601 Cleveland Ave., Suite 15 Ft. Myers, FL 33907 (941) 278-4242</p>	<p>Orlando - Jacksonville - Ocala - Gainesville & East Coast 2452 Sand Lake Road Orlando, FL 32809 (407) 857-8998</p>	<p>Tampa - St.Petersburg - Sarasota Area Center Point Business Park, Building B-1, Suite 100 1911 U.S. Hwy. 301 North Tampa, FL 33619 (813) 621-8181</p>
<p>Cleveland - Akron - Youngstown Area 24090 Detroit Avenue Westlake, OH 44145 (216) 899-2040</p>	<p>Houston - Galveston - Beaumont - Austin - San Antonio Area 1110 North Post Oak Road Suite 100 Houston, TX 77055 (713) 682-3990</p>	<p>Philadelphia - South NJ Area 352 Dunks Ferry Road Bensalem, PA 19020 (215) 638-7500</p>	<p>Washington, DC - Baltimore - Northern VA Area 6671-J Santa Barbara Road Elkridge, MD 21227 (410) 796-0105</p>
<p>Columbus - Dayton - Cincinnati Area 6333 Busch Blvd. Columbus, Ohio 43229 (614) 781-2605</p>	<p>Knoxville - Greenville-- Tri Cities - East Tennessee Area 6700 D. Papermill Road Papermill Plaza Knoxville, TN 37919 (423) 584-6614</p>	<p>Pittsburgh, PA - Steubenville, OH - Wheeling/Morgantown, WV Area 2891 Banksville Road Pittsburgh, PA 15216 (412) 563-8020</p>	
	<p>Los Angeles - San Diego Area 2910 E. LaPalma, Suite E Anaheim, CA 92806 (714) 238-7250</p>		

HOW YOU CAN OBTAIN EFFICIENT AND EXPEDIENT CARRY-IN, MAIL-IN, OR IN-HOME SERVICE IN CANADA FOR YOUR PRODUCT THROUGH A PHILIPS CONSUMER SERVICE CENTER

COMMENT OBTENIR NOTRE SERVICE APRÈS VENTE RAPIDE ET EFFICACE SOIT PAR COURRIER, À DOMICILE, OU EN SE PRÉSENTANT À UN CENTRE DE SERVICE PHILIPS

CÓMO OBTENER UN SERVICIO OPORTUNO Y EFICIENTE POR CORREO, EN CASA O EN PERSONA EN EL CANADA PARA SU PRODUCTO A TRAVÉS DE UN CENTRO PHILIPS DE SERVICIO AL CONSUMIDOR

<p>TORONTO 601 Milner Avenue Scarborough, Ontario M1B 1M8 (416) 754-6064 (Tel.) (416) 292-5161 (Tel.) (416) 754-6290 (Fax)</p>	<p>MONTRÉAL 4977 Levy Street St. Laurent, Québec H4R 2N9 (514) 956-0120 (Tel.) (514) 956-0828 (Fax)</p>	<p>VANCOUVER 1741 Boundary Road Vancouver, B.C. V5M 3Y7 (604) 294-3441 (Tel.) (604) 294-3574 (Fax)</p>
---	--	---

LIMITED WARRANTY

DVD VIDEO PLAYER

90 Days Free Labor

One Year Exchange Warranty on Parts

This product must be carried in for repair.

WHO IS COVERED?

You must have proof of purchase to receive warranty service. A sales receipt or other document showing that you purchased the product is considered proof of purchase.

WHAT IS COVERED?

Warranty coverage begins the day you buy your product. For 90 days thereafter, all parts will be repaired or replaced, and labor is free. From 90 days to one year from the day of purchase, all parts will be repaired or replaced, but you pay for all labor charges. After one year from the day of purchase, you pay for the replacement or repair of all parts, and for all labor charges.

All parts, including repaired and replaced parts, are covered only for the original warranty period. When the warranty on the product expires, the warranty on all replaced and repaired parts also expires.

WHAT IS EXCLUDED?

Your warranty does not cover:

- labor charges for installation or setup of the product, adjustment of customer controls on the product, and installation or repair of antenna systems outside of the product.
- product repair and/or part replacement because of misuse, accident, unauthorized repair or other cause not within the control of Philips Consumer Electronics Company.
- reception problems caused by signal conditions or cable or antenna systems outside the unit.
- a product that requires modification or adaptation to enable it to operate in any country other than the country for which it was designed, manufactured, approved and/or authorized, or repair of products damaged by these modifications.
- incidental or consequential damages resulting from the product. (Some states do not allow the exclusion of incidental or consequential damages, so the above exclusion may not apply to you. This includes, but is not limited to, prerecorded material, whether copyrighted or not copyrighted.)
- a product that is used for commercial or institutional purposes (including but not limited to rental purposes).

WHERE IS SERVICE AVAILABLE?

Warranty service is available in all countries where the product is officially distributed by Philips Consumer Electronics Company. In countries where Philips Consumer Electronics Company does not distribute the product, the local Philips service organization will attempt to provide service (although there may be a delay if the appropriate spare parts and technical manual(s) are not readily available).

MAKE SURE YOU KEEP...

Please keep your sales receipt or other document showing proof of purchase. Attach it to this owner's manual and keep both nearby. Also

keep the original box and packing material in case you need to return your product.

BEFORE REQUESTING SERVICE...

Please check your owner's manual before requesting service. Adjustments of the controls discussed there may save you a service call.

TO GET WARRANTY SERVICE IN U.S.A., PUERTO RICO OR U.S. VIRGIN ISLANDS...

Take the product to a Philips factory service center (see enclosed list) or authorized service center for repair. When the product has been repaired, you must pick up the unit at the center. Centers may keep defective parts.

(In U.S.A., Puerto Rico and U.S. Virgin Islands, all implied warranties, including implied warranties of merchantability and fitness for a particular purpose, are limited in duration to the duration of this express warranty. Because some states do not allow limitations on how long an implied warranty may last, this limitation may not apply to you.)

TO GET WARRANTY SERVICE IN CANADA...

Take the product to a Philips consumer service center (listed below), self-servicing dealer or authorized service depot.

Philips Electronics Ltd.

601 Milner Avenue, Scarborough, Ontario, M1B 1M8

(416) 292-5161

4977 Levy Street, St. Laurent, Québec, H4R 2N9

(514) 956-0120

1741 Boundary Road, Vancouver, B.C., V5M 3Y7

(604) 294-3441

(In Canada, this warranty is given in lieu of all other warranties. No other warranties are expressed or implied, including any implied warranties of merchantability or fitness for a particular purpose. Philips is not liable under any circumstances for any direct, indirect, special, incidental or consequential damages, howsoever incurred, even if notified of the possibility of such damages.)

REMEMBER...

Please record the model and serial numbers found on the product below. Also, please fill out and mail your warranty registration card promptly. It will be easier for us to notify you if necessary.

MODEL # _____

SERIAL # _____

This warranty gives you specific legal rights. You may have other rights which vary from state/province to state/province.

Philips Service Company, P.O. Box 555, Jefferson City, Tennessee 37760, (423) 475-8869

Free Manuals Download Website

<http://myh66.com>

<http://usermanuals.us>

<http://www.somanuals.com>

<http://www.4manuals.cc>

<http://www.manual-lib.com>

<http://www.404manual.com>

<http://www.luxmanual.com>

<http://aubethermostatmanual.com>

Golf course search by state

<http://golfingnear.com>

Email search by domain

<http://emailbydomain.com>

Auto manuals search

<http://auto.somanuals.com>

TV manuals search

<http://tv.somanuals.com>