

PHILIPS MAGNAVOX



DVD Video Player DVD420AT Owner's Manual

IMPORTANT!

**Return Your Warranty Registration Card
Within 10 Days. See Why Inside.**

Return your Warranty Registration card today to ensure you receive all the benefits you're entitled to.

Once your PHILIPS MAGNAVOX purchase is registered, you're eligible to receive all the privileges of owning a PHILIPS MAGNAVOX product. So complete and return the Warranty Registration Card enclosed with your purchase at once. And take advantage of these important benefits.

Warranty Verification

Registering your product within 10 days confirms your right to maximum protection under the terms and conditions of your PHILIPS MAGNAVOX warranty.

Owner Confirmation

Your completed Warranty Registration Card serves as verification of ownership in the event of product theft or loss.

Model Registration

Returning your Warranty Registration Card right away guarantees you'll receive all the information and special offers which you qualify for as the owner of your model.

Congratulations on your purchase, and welcome to the "family!"

Dear PHILIPS MAGNAVOX product owner:

Thank you for your confidence in PHILIPS MAGNAVOX. You've selected one of the best-built, best-backed products available today. And we'll do everything in our power to keep you happy with your purchase for many years to come.

As a member of the PHILIPS MAGNAVOX "family," you're entitled to protection by one of the most comprehensive warranties and outstanding service networks in the industry.

What's more, your purchase guarantees you'll receive all the information and special offers for which you qualify, plus easy access to accessories from our convenient home shopping network.

And most importantly you can count on our uncompromising commitment to your total satisfaction.

All of this is our way of saying welcome—and thanks for investing in a PHILIPS MAGNAVOX product.

Sincerely,



Robert Minkhorst
President and Chief Executive Officer

PHILIPS MAGNAVOX



P.S. Remember, to get the most from your PHILIPS MAGNAVOX product, you must return your Warranty Registration Card within 10 days. So please mail it to us right now!

For Customer Use

Enter below the Serial No. which is located on the rear of the cabinet. Retain this information for future reference.

Model No. _____ Serial No. _____

Know these safety symbols

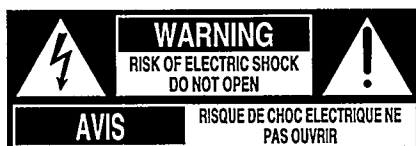

 This "bolt of lightning" indicates uninsulated material within your unit may cause an electrical shock. For the safety of everyone in your household, please do not remove product covering.

 The "exclamation point" calls attention to features for which you should read the enclosed literature closely to prevent operating and maintenance problems.

WARNING: TO PREVENT FIRE OR SHOCK HAZARD, DO NOT EXPOSE THIS EQUIPMENT TO RAIN OR MOISTURE.

CAUTION: To prevent electric shock, match wide blade of plug to wide slot, and fully insert.

ATTENTION: Pour éviter les chocs électriques, introduire la lame la plus large de la fiche dans la borne correspondante de la prise et pousser jusqu'au fond.

PHILIPS MAGNAVOX Visit our World Wide Web Site at <http://www.magnavox.com>

SAFETY PRECAUTIONS

CAUTION: This Digital Video Disc Player employs a Laser System.
To ensure proper use of this product, please read this owner's manual carefully and retain for future reference. Should the unit require maintenance, contact an authorized service location - see service procedure.

Use of controls, adjustments, or the performance of procedures other than those specified herein may result in hazardous radiation exposure.

To prevent direct exposure to laser beam, do not try to open the enclosure.
Visible laser radiation when open and interlocks defeated.
DO NOT STARE INTO BEAM.

FCC NOTICE: This equipment has been tested and found to comply with the limits for a Class B digital device, pursuant to part 15 of the FCC Rules. These limits are designed to provide reasonable protection against harmful interference in a residential installation.

This equipment generates, uses, and can radiate radio frequency energy and, if not installed and used in accordance with the instructions, may cause harmful interference to radio communications.

However, there is no guarantee that interference will not occur in a particular installation.

If this equipment does cause harmful interference to radio or television reception, which can be determined by turning the equipment off and on, the user is encouraged to try to correct the interference by one or more of the following measures:

- Reorient or relocate the receiving antenna.
- Increase the separation between the equipment and receiver.
- Connect the equipment into an outlet on a circuit different from that to which the receiver is connected.
- Consult the dealer or an experienced radio/TV technician for help.

WARNING: Changes or modifications made to this equipment, not expressly approved by Philips Consumer Electronics Company, or parties authorized by Philips Consumer Electronics Company, could void the user's authority to operate the equipment.

Location of the required label

PRODUCT IS CERTIFIED BY THE MANUFACTURER TO COMPLY WITH DHHS RULES 21 CFR SUBCHAPTER J APPLICABLE AT THE DATE OF MANUFACTURE.

MANUFACTURED

DISTRIBUTED BY:
PHILIPS CONSUMER ELECTRONICS CO.
P. O. BOX 14810 KNOXVILLE, TN 37914 -1810

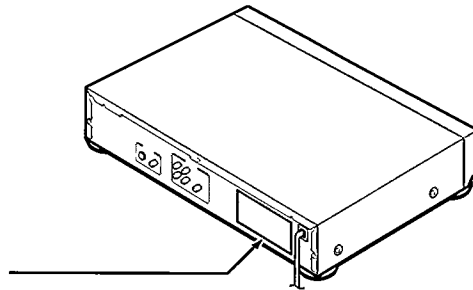

IMPORTANT SAFETY INSTRUCTIONS

CAUTION: PLEASE READ AND OBSERVE ALL WARNINGS AND INSTRUCTIONS GIVEN IN THIS OWNER'S MANUAL AND THOSE MARKED ON THE UNIT. RETAIN THIS BOOKLET FOR FUTURE REFERENCE.

This set has been designed and manufactured to assure personal safety. Improper use can result in electric shock or fire hazard. The safeguards incorporated in this unit will protect you if you observe the following procedures for installation, use and servicing. This unit is fully transistorized and does not contain any parts that can be repaired by the user.

DO NOT REMOVE THE CABINET COVER, OR YOU MAY BE EXPOSED TO DANGEROUS VOLTAGE. REFER SERVICING TO QUALIFIED SERVICE PERSONNEL ONLY.

1. Read owner's manual

After unpacking this product, read the owner's manual carefully, and follow all the operating and other instructions.

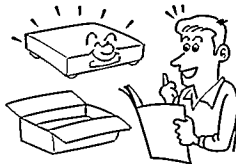

2. Power Sources

This product should be operated only from the type of power source indicated on the marking label. If you are not sure of the type of power supply to your home, consult your product dealer or local power company. For products intended to operate from battery power, or other sources, refer to the operating instructions.



3. Grounding or Polarization

This product may be equipped with a polarized alternating current line plug (a plug having one blade wider than the other). This plug will fit into the power outlet only one way. This is a safety feature. If you are unable to insert the plug fully into the outlet, try reversing the plug. If the plug should still fail to fit, contact your electrician to replace your obsolete outlet. Do not defeat the safety purpose of the polarized plug.

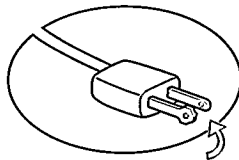

4. Ventilation

Slots and openings in the cabinet are provided for ventilation and to ensure reliable operation of the product and to protect it from overheating. These openings must not be blocked or covered. The openings should never be blocked by placing the product on a bed, sofa, rug or other similar surface. This product should not be placed in a built-in installation such as a bookcase or rack unless proper ventilation is provided or the manufacturer's instructions have been adhered to.

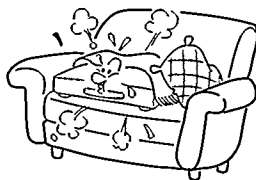

5. Heat

The product should be situated away from heat sources such as radiators, heat registers, stoves, or other products (including amplifiers) that produce heat.

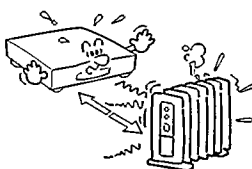

6. Water and Moisture

Do not use this product near water - for example, near a bath tub, wash bowl, kitchen sink, or laundry tub; in a wet basement; or near a swimming pool and the like.

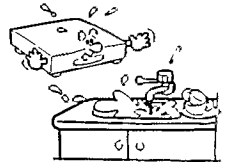

7. Cleaning

Unplug this product from the wall outlet before cleaning. Do not use liquid cleaners or aerosol cleaners. Use a damp cloth for cleaning.



8. Power-Cord Protection

Power-supply cords should be routed so that they are not likely to be walked on or pinched by items placed upon or against them, paying particular attention to cords at plugs, convenience receptacles, and the point where they exit from the product.



9. Overloading

Do not overload wall outlets, extension cords, or integral convenience receptacles as this can result in a risk of fire or electric shock.

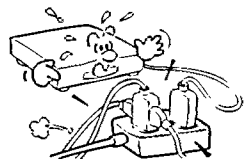

10. Lightning

For added protection for this product during a storm, or when it is left unattended and unused for long periods of time, unplug it from the wall outlet. This will prevent damage to the product due to lightning and power-line surges.

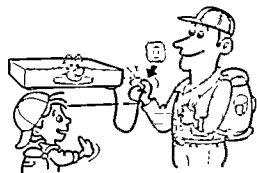

11. Object and Liquid Entry

Never push objects of any kind into this product through openings as they may touch dangerous voltage points or short-out parts that could result in a fire or electric shock. Never spill liquid of any kind on the product.



12. Attachments

Do not use attachments not recommended by the product manufacturer as they may cause hazards.

13. Accessories

Do not place this product on an unstable cart, stand, tripod, bracket, or table. The product may fall, causing serious injury to a child or adult, and serious damage to the product. Use only with a cart, stand, tripod, bracket, or table recommended by the manufacturer, or sold with the product.



Any mounting of the product should follow the manufacturer's instructions, and should use a mounting accessory recommended by the manufacturer.

A product and cart combination should be moved with care. Quick stops, excessive force, and uneven surfaces may cause the product and cart combination to overturn.

14. Disc Tray

Keep your fingers well clear of the disc tray as it is closing. It may cause serious personal injury.

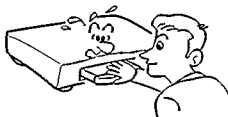

15. Burden

Do not place a heavy object on the product or step on it. The object may fall, causing serious personal injury and serious damage to the product.

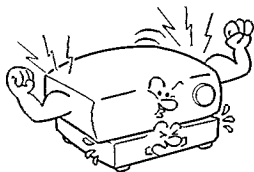

16. Headphones

When you use the headphones, keep the volume at a moderate level. If you use the headphones continuously at a high volume, it may cause hearing damage.



17. Disc

Do not use a cracked, deformed, or repaired disc. These discs are easily broken and may cause serious personal injury and product malfunction.

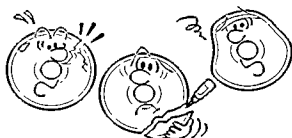

18. Damage Requiring Service

Unplug this product from the wall outlet and refer servicing to qualified service personnel under the following conditions:

- a) When the power-supply cord or plug is damaged.
- b) If liquid has been spilled, or objects have fallen into the product.
- c) If the product has been exposed to rain or water.
- d) If the product does not operate normally by following the operating instructions. Adjust only those controls that are covered by the operating instructions as an improper adjustment of other controls may result in damage and will often require extensive work by a qualified technician to restore the product to its normal operation.
- e) If the product has been dropped or damaged in any way.
- f) When the product exhibits a distinct change in performance - this indicates a need for service.

19. Servicing

Do not attempt to service this product yourself as opening or removing covers may expose you to dangerous voltage or other hazards. Refer all servicing to qualified service personnel.



20. Replacement Parts

When replacement parts are required, be sure the service technician has used replacement parts specified by the manufacturer or have the same characteristics as the original part. Unauthorized substitutions may result in fire, electric shock, or other hazards.

21. Safety Check

Upon completion of any service or repairs to this product, ask the service technician to perform safety checks to determine that the product is in proper operating condition.

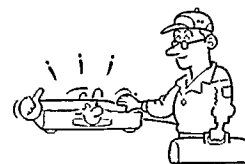

Precautions

Notes on Handling

- When shipping the DVD video player, the original shipping carton and packing materials come in handy. For maximum protection, repack the unit as it was originally packed at the factory.
- Do not use volatile liquids, such as insect spray, near the DVD video player. Do not leave rubber or plastic products in contact with the DVD video player for a long time. They will leave marks on the cabinet.
- The top and rear panels of the DVD video player may become warm after a long period of use. This is not a malfunction.
- When the DVD video player is not in use, be sure to remove the disc and turn off the power.
- If you do not use the DVD video player for a long time, the unit may not function properly in the future. Use the DVD video player occasionally.

Notes on Location

- When you place this DVD video player near a TV, radio, or VCR, the playback picture may become poor and the sound may be distorted. In this case, place the DVD video player away from the TV, radio, or VCR.

Notes on Cleaning

Use a soft, dry cloth for cleaning.

- For stubborn dirt, soak the cloth in a weak detergent solution, wring the cloth well, and wipe the unit. Use a dry cloth to wipe it dry.
Do not use any type of solvent, such as thinner and benzine, as they may damage the surface of the DVD video player.
- If you use a chemical saturated cloth to clean the unit, follow that product's instructions.

To Obtain a Clear Picture

The DVD video player is a high technology, precision device. If the optical pick-up lens and disc drive parts are dirty or worn down, the picture quality becomes poor. To obtain a clear picture, we recommend regular inspection and maintenance (cleaning or parts replacement) every 1,000 hours of use depending on the operating environment. For details, contact your nearest dealer.

Notes on Moisture Condensation

Moisture condensation damages the DVD video player. Please read the following carefully.

Moisture condensation occurs, for example, when you pour a cold drink into a glass on a warm day. Drops of water form on the outside of the glass. In the same way, moisture may condense on the optical pick-up lens inside this unit, one of the most crucial internal parts of the DVD video player.

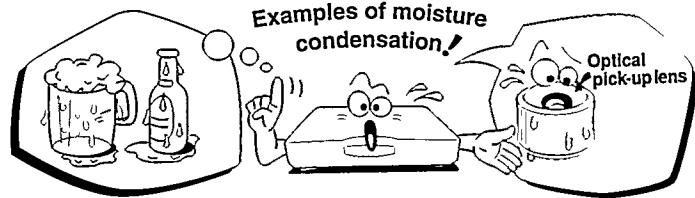

■ **Moisture condensation occurs during the following cases.**

- When you bring the DVD video player directly from a cold place to a warm place.
- When you use the DVD video player in a room where you just turned on the heater, or a place where the cold wind from the air conditioner directly hits the unit.
- In summer, when you use the DVD video player in a hot and humid place just after you move the unit from an air conditioned room.

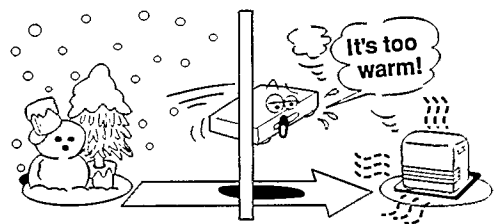

■ **Do not use the DVD video player when moisture condensation may occur.**

If you use the DVD video player in such a situation, it may damage discs and internal parts. Remove the disc, connect the power cord of the DVD video player to the wall outlet, turn on the DVD video player, and leave it on for two or three hours. After two or three hours, the DVD video player will have warmed up and evaporated any moisture. Keep the DVD video player connected to the wall outlet and moisture condensation will seldom occur.

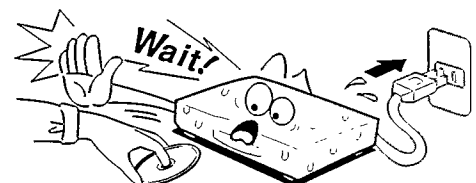

Table of Contents

Introduction

- SAFETY PRECAUTIONS 2
- IMPORTANT SAFETY INSTRUCTIONS 3, 4
- Precautions 5
- Identification of Controls 7-10
 - Front Panel/Rear Panel/DVD Display
 - Remote Control
 - Preparing the Remote Control
 - Operating with the Remote Control
 - Built-in Locator of the Remote Control

Introduction

Connections

- Connecting to a TV 11
- Connecting to an Audio System 12
- Connecting to Optional Equipment ... 13, 14
 - Enjoying Dolby Digital (AC-3) Sound
 - Enjoying Dolby Pro Logic Surround Sound
 - Enjoying Two-channel Digital Stereo Sound

Connections

Basic Playback

- Playing a Disc 15-18
 - Basic Playback
 - Using the Shuttle Ring
 - Using the Jog Dial
 - Resuming Playback from the Same Location
- Locating a Specific Title, Chapter, or Track 19, 20
 - Locating a Title Using the Title Menu
 - Locating a Title
 - Locating a Specific Chapter or Track Directly
 - Locating a Specific Chapter or Track
 - Locating a Specific Location on the Disc

Basic Playback

Advanced Playback

- Playing Repeatedly 21
 - Repeating a Title, Chapter, or Track
 - Repeating a Specific Segment
- Playing in a Favorite Order 22
 - Setting Titles, Chapters, or Tracks in a Favorite Order
- Playing in Random Order 23
 - Playing Titles in Random Order
 - Playing Chapters or Tracks in Random Order
- Zooming a Picture 24
 - Zooming a Picture
- Selecting the Camera Angle/Selecting a Language .. 25
 - Changing the Camera Angle
 - Selecting a Playback Audio Setting
- Selecting Subtitles 26
 - Displaying Subtitles
 - Selecting a Subtitle Language
- Using the On-Screen Display 27
 - Checking the Operational Status
 - Checking the Remaining Time and Setting Status

Advanced Playback

Function Setup

- Customizing the Settings 28-34
 - Displaying the SET UP MENU Screen
 - Setting the Audio Sound
 - Setting the Functions
 - Setting the Displays
- Setting the Parental Lock 35, 36
 - Setting the Parental Lock
- Operating Other Equipment with the Remote Control 37, 38
 - Programming the Remote Control
 - Brand Code Table
 - Buttons to Operate
- Table of Languages 39

Function Setup

Others

- Notes on Discs 40
- Before Calling Service Personnel 41
- Specifications 42
- Memo 43
- Factory Service Center Locations 45, 46
- Limited Warranty Back cover

Others

Identification of Controls

See the page number inside the  for details.

Front Panel/Rear Panel/DVD Display

Front Panel

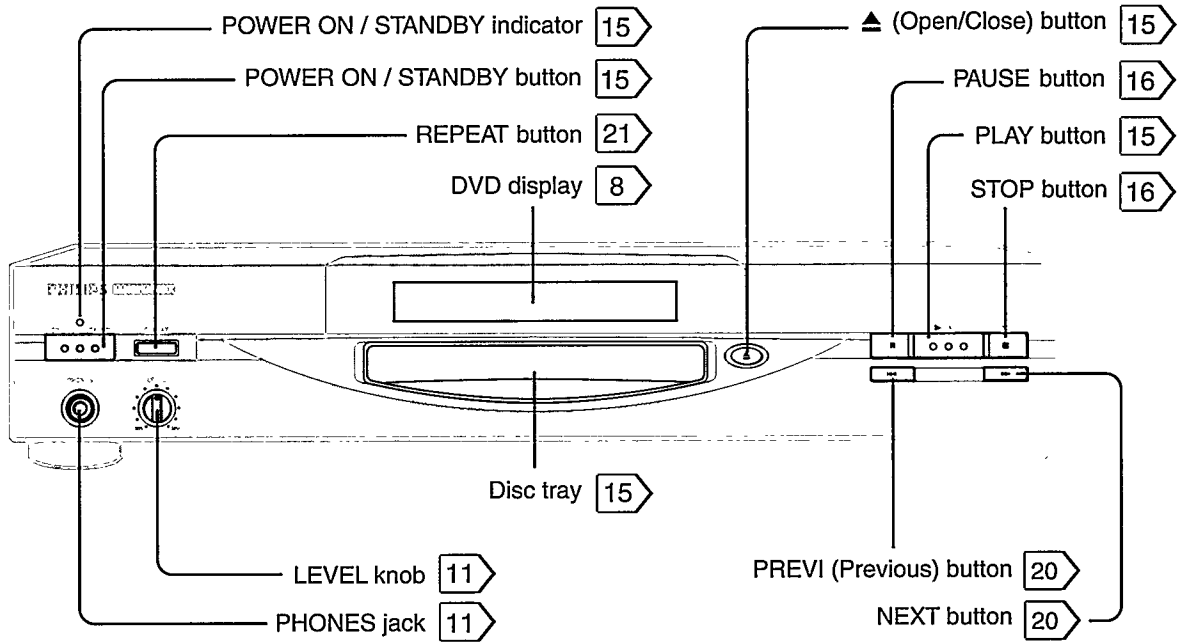

Rear Panel

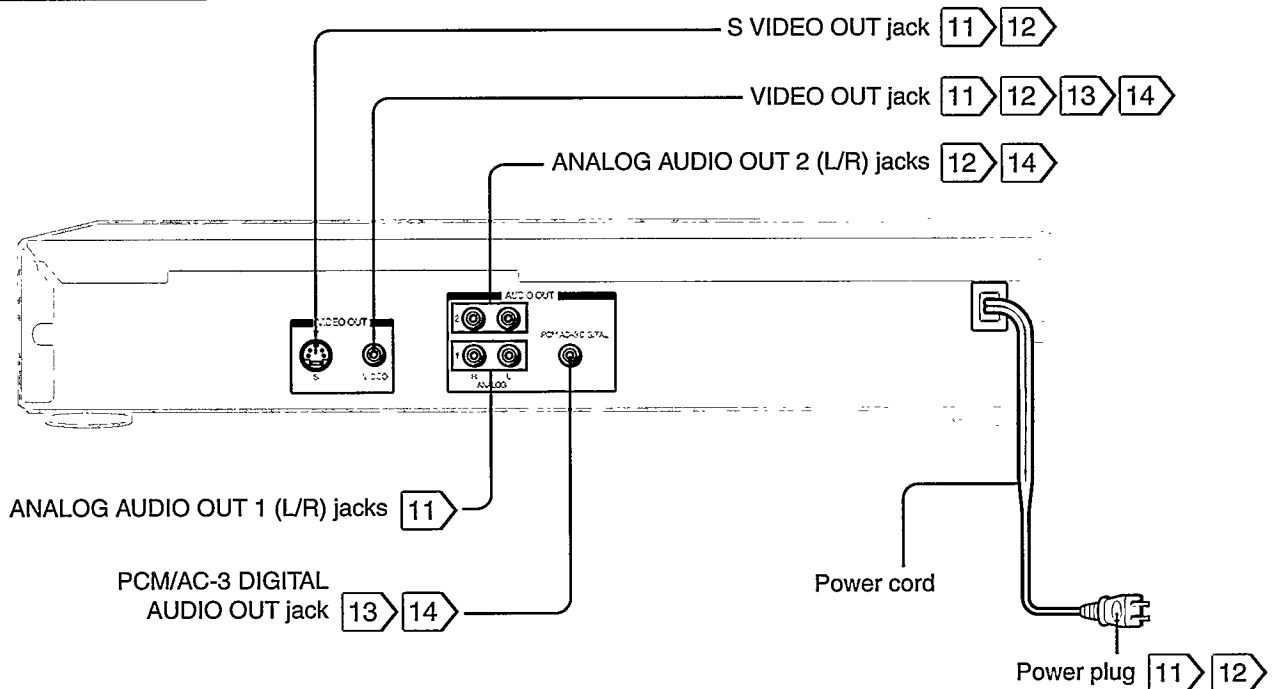

DVD Display

■ Pressing of the FL-DIM button on the remote control changes the brightness of the display.

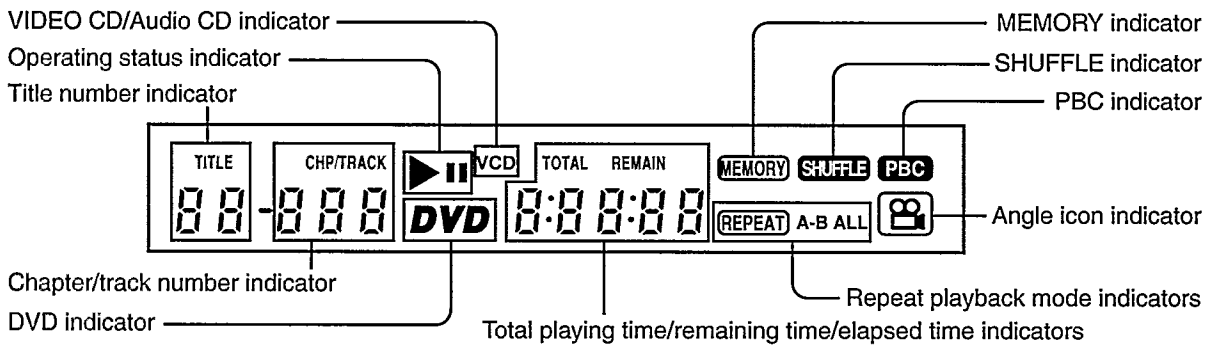
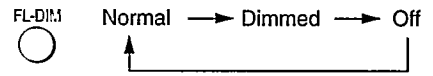

■ The indicators vary depending on the kinds of discs you play.

DVD Video discs	VIDEO CDs	Audio CDs
<ul style="list-style-type: none"> When closing the disc tray: <p>Example</p> <p>Total number of titles</p> <p>Some DVD video discs may not display the total number of titles.</p>	<ul style="list-style-type: none"> When closing the disc tray: <p>Example</p> <p>Total number of tracks Lights up when using a PBC-controllable VIDEO CD</p> <p>Total playing time of the disc</p>	<ul style="list-style-type: none"> When closing the disc tray: <p>Example</p> <p>Total number of tracks Total playing time of the disc</p>
<ul style="list-style-type: none"> During playback: <p>Example</p> <p>Playing chapter 3 in title 2 Elapsed time of the current title</p> <p>Some DVD video discs may not display the chapter numbers or elapsed time.</p>	<ul style="list-style-type: none"> During playback: <p>Example</p> <p>Playing track 6 Elapsed time of the current track</p> <p>Some VIDEO CDs may not display the track numbers or elapsed time.</p>	<ul style="list-style-type: none"> During playback: <p>Example</p> <p>Playing track 6 Elapsed time of the current track</p>

Other indicators

	When playing back the same title, chapter or track repeatedly. [21]		When playing back a specific segment repeatedly. (A-B repeat) [21]		When playing back the entire disc repeatedly. [21]
	When playback is paused. [16]		During memory playback. [22]		When the camera angle can be changed. [25]
	During random playback. [23]				

Identification of Controls (continued)

The instructions in this manual describe the functions on the remote control. See the page number inside the  for details.

Remote Control

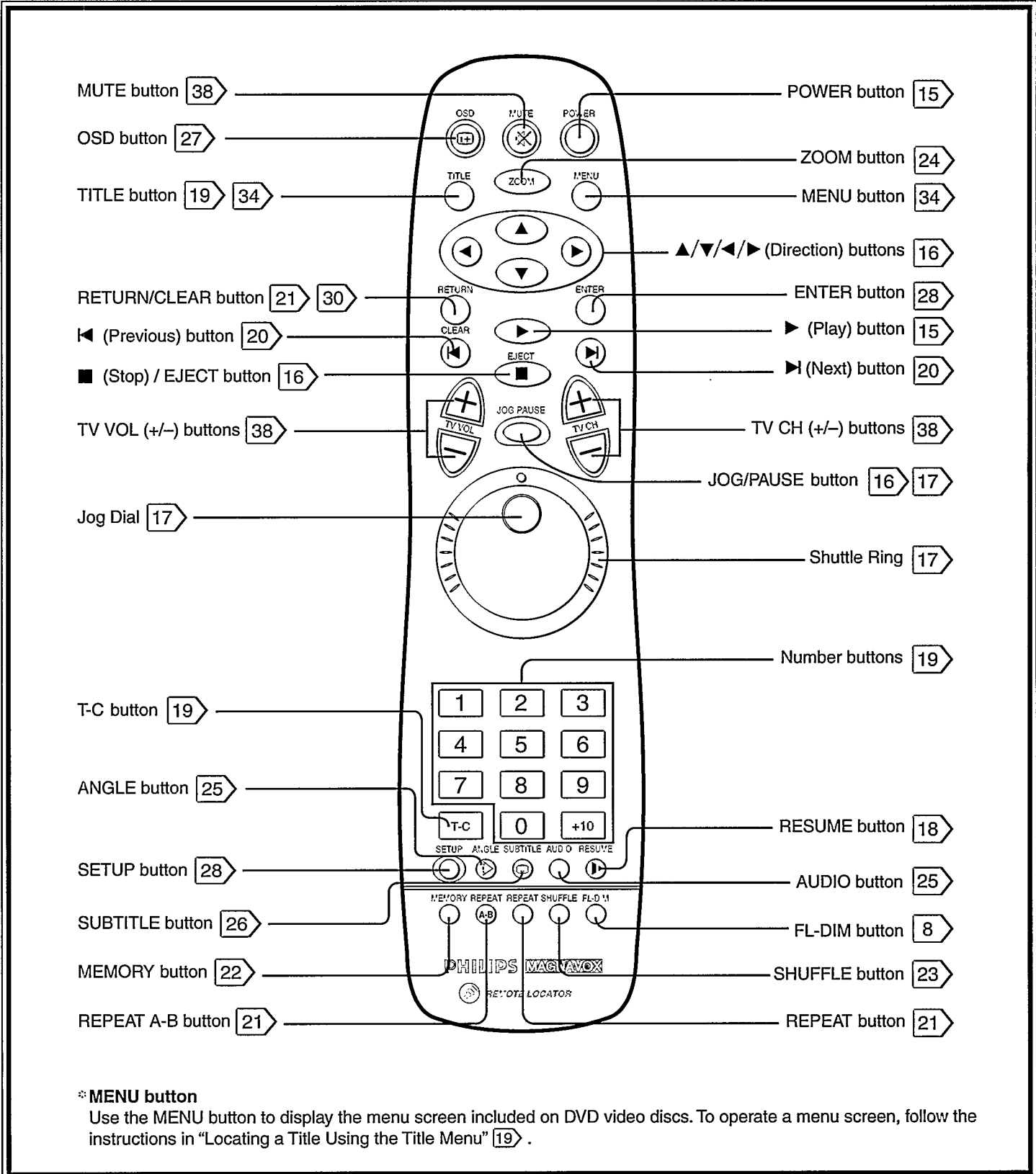

Preparing the Remote Control

Insert the batteries into the remote control so you can use it to operate the DVD video player.

1

Open the cover.

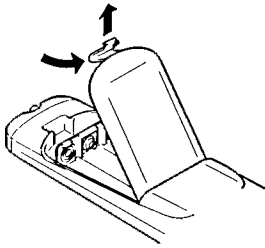

2

Insert batteries (AA).

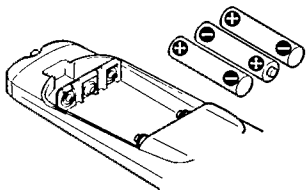

Make sure to match the + and – on the batteries to the marks inside the battery compartment.

3

Close the cover.

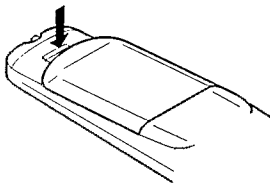

Notes on Batteries

Improper use of batteries may cause battery leakage and corrosion. To operate the remote control correctly, follow the instructions below.

- Do not insert the batteries into the remote control in the wrong direction (follow the +/- signs).
- Do not charge, heat, open, or short-circuit the batteries. Do not throw the batteries into a fire.
- Do not leave dead or exhausted batteries in the remote control.
- Do not use different types of batteries together, or mix old and new batteries.
- If you do not use the remote control for a long period of time, remove the batteries to avoid possible damage from battery corrosion.
- If the remote control does not function correctly or if the operating range becomes reduced, replace all batteries with new ones.
- If battery leakage occurs, wipe the battery liquid from the battery compartment, then insert new batteries.

Operating with the Remote Control

This section shows you how to use the remote control.

Point the remote control at the remote sensor and press the buttons.

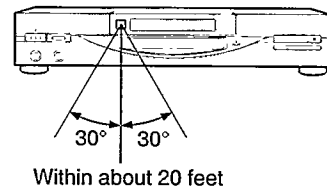

Distance: About 20 feet from the front of the remote sensor

Angle: About 30° in each direction of the front of the remote sensor

- * Do not expose the remote sensor of the DVD video player to a strong light source such as direct sunlight or illumination. If you do so, you may not be able to operate the DVD video player with the remote control.

Notes on the Remote Control

- Point the remote control at the remote sensor of the DVD video player.
- Do not drop the remote control.
- Do not leave the remote control near an extremely hot or humid place.
- Do not spill water into or put anything wet on the remote control.
- Do not open the remote control.

Built-in Locator of the Remote Control

The remote control lets you know its location by beeping each time the main power is turned on.

- 1 Press the POWER ON / STANDBY button on the front panel of the DVD video player to turn the DVD video player on.
The remote control beeps so that you can easily locate it. The remote control should be within about 20 feet from the DVD video player, not being obstructed.
- 2 To turn off the beep, press any button on the remote control.
 - Re-execution requires an interval of about thirty seconds.
 - The built-in locator may not work depending on the condition. (ex. obstructions, direction of the remote control, etc.)

Connecting to a TV

Connect the DVD video player to your TV.

Connecting to a TV

Setting of the sound output

From the on-screen displays, set "AUDIO OUT SEL." to "PCM." 28 29

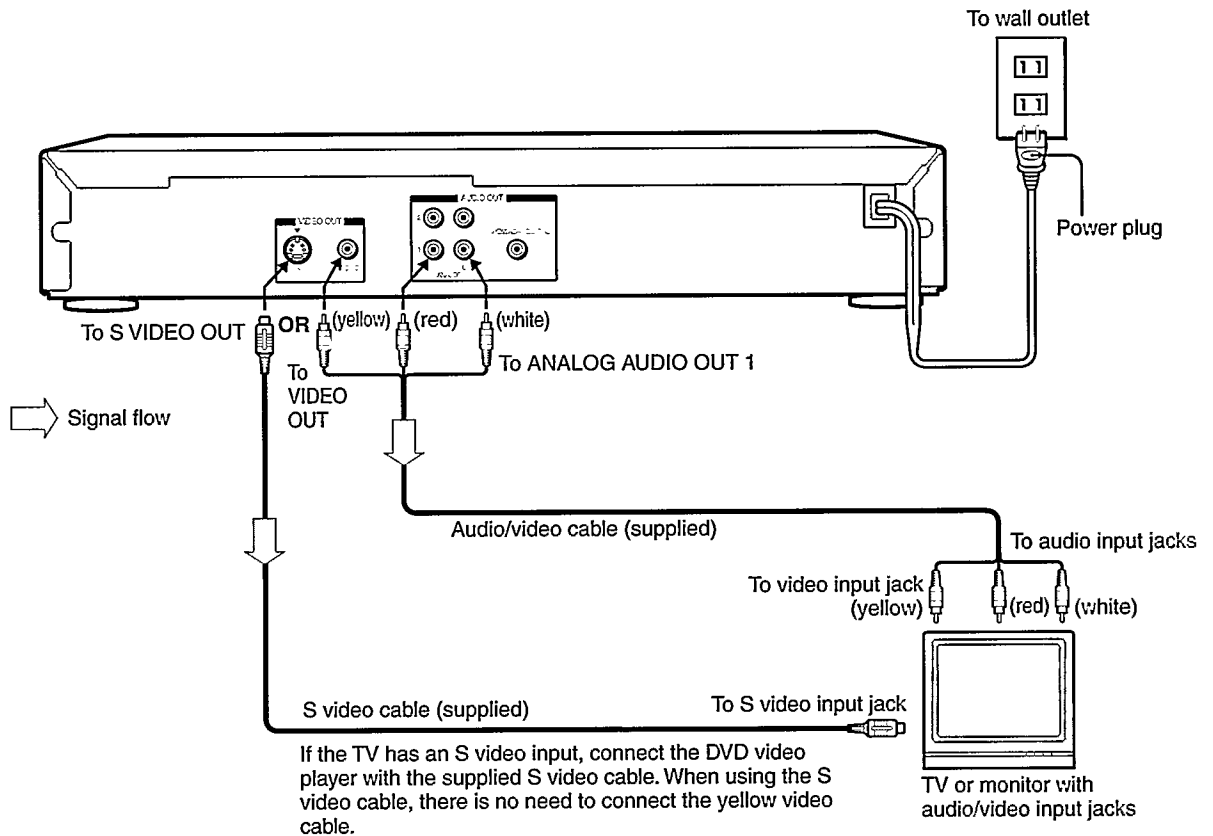

If your TV has an RF (Antenna In) jack only, use an RF modulator (not supplied) to connect the DVD player to your TV.

- Set your TV to accept Auxiliary (Line) input. See your TV owner's manual for details.

Notes

- Refer to the owner's manual of the connected TV as well.
- When you connect the DVD video player to your TV, be sure to turn off the power and unplug both units from the wall outlet before making any connections.
- If your television set has one audio input, use a Y cable adapter (not supplied) to connect to your TV.
- Connect the DVD video player directly to your TV. If you connect the DVD video player to a VCR, TV/VCR combination or video selector, the playback picture will be distorted because DVD video discs are copy protected.

Headphones connection

Connect headphones that have a stereo large size connector.

Before connecting, temporarily lower the sound volume, then adjust the volume.

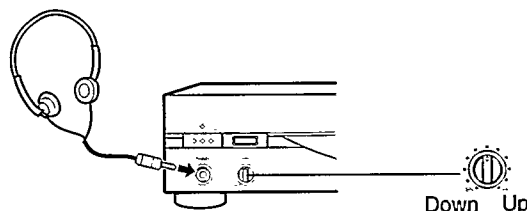

Connecting to an Audio System

You can listen to the sound of the discs in stereo.

Connecting to an Audio System

■ Setting of the sound output

From the on-screen displays, set "AUDIO OUT SEL." to "PCM." **28** **29**

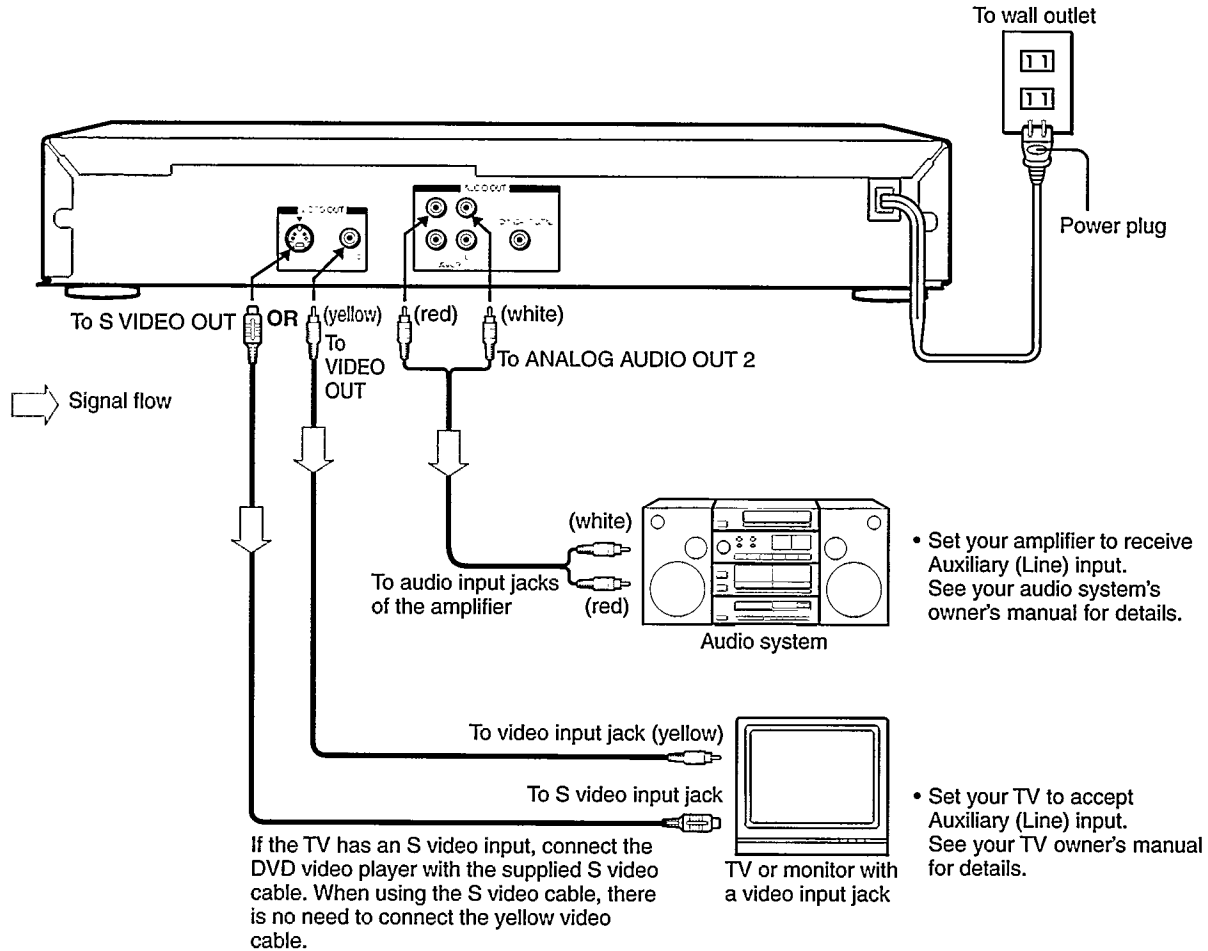

Notes

- Refer to the owner's manual of the connected equipment (TV, audio system) as well.
- When you connect the DVD video player to other equipment, be sure to turn off the power and unplug all of the equipment from the wall outlet before making any connections.
- If you place the DVD video player near a tuner or radio, the radio broadcast sound might be distorted. In this case, place the DVD video player away from the tuner and radio.
- The output sound of the DVD video player has a wide dynamic range. Be sure to adjust the receiver's volume to a moderate listening level. Otherwise, the speakers may be damaged by a sudden high volume sound.
- Turn off the amplifier before you connect or disconnect the DVD video player's power cord. If you leave the amplifier power on, the speakers may be damaged.

Connecting to Optional Equipment

You can enjoy the high quality dynamic sound of Dolby Digital (AC-3), Dolby Pro Logic and 2 Channel Digital Stereo.

Enjoying Dolby Digital (AC-3) Sound

Dolby Digital (AC-3)

Dolby Digital is the surround sound technology used in movie theaters; it is now available in the home. You can enjoy motion picture and live concert DVD video discs with this dynamic realistic sound by connecting the DVD video player to a six-channel amplifier equipped with a Dolby Digital (AC-3) decoder or Dolby Digital (AC-3) processor. If you have a Dolby Pro Logic Surround decoder, you will obtain the full benefit of Pro Logic from the same DVD movies that provide full 5.1-channel Dolby Digital soundtracks, as well as from titles with the Dolby Surround mark.

Setting of the sound output

- From the on-screen displays, set the "AUDIO OUT SEL." to "AC-3." 28 29
- Set the sound recording system to "AC-3" on the audio setting indication. 25
- Use a disc recorded in the Dolby Digital (AC-3) recording system to enjoy Dolby Digital (AC-3) sound.

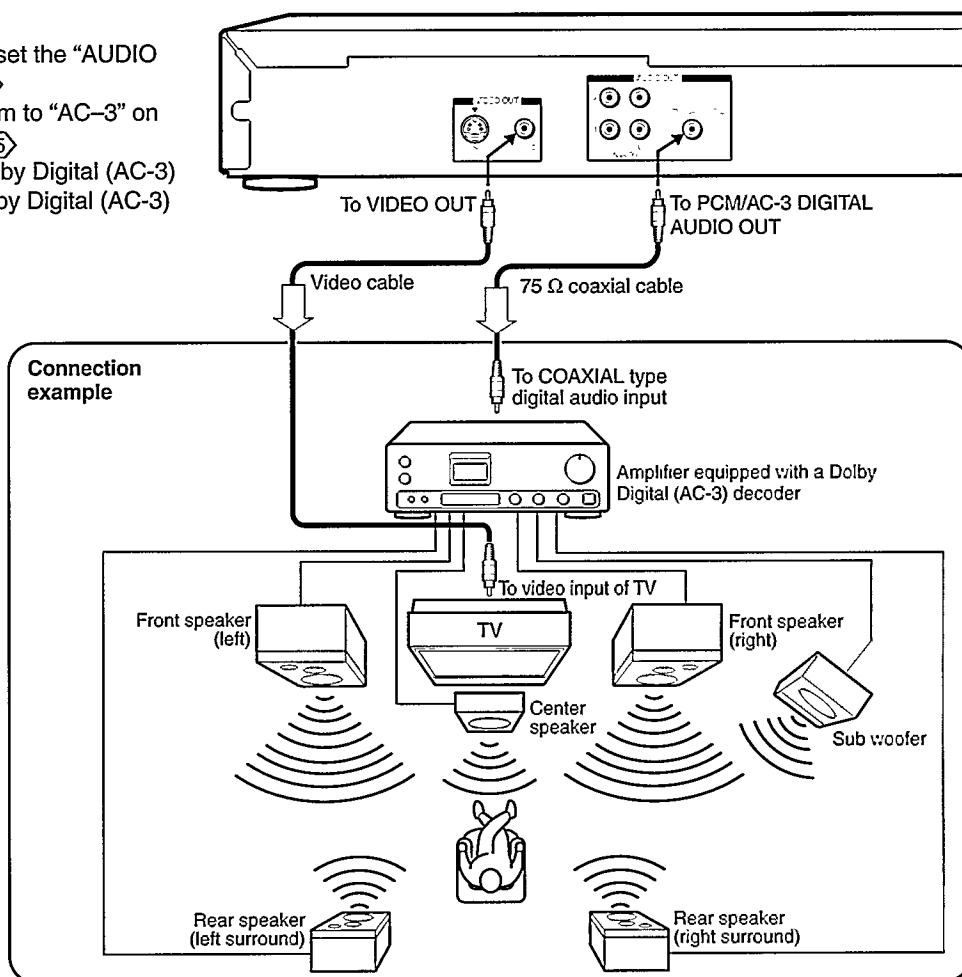

Manufactured under license from Dolby Laboratories Licensing Corporation. "Dolby," "AC-3," "Pro Logic," and the double-D symbol are trademarks of Dolby Laboratories Licensing Corporation.

Notes

- DO NOT connect the PCM/AC-3 DIGITAL AUDIO OUT jack of the DVD video player to the AC-3 RF input of a Dolby Digital Receiver. This input on your A/V Receiver is reserved for Laserdisc use only and is incompatible with the PCM/AC-3 DIGITAL AUDIO OUT jack of the DVD video player.
- Connect the PCM/AC-3 DIGITAL AUDIO OUT jack of the DVD video player to the "DIGITAL" or "COAXIAL" input of a Dolby Digital Receiver or Processor.
- Connect the speakers according to the instructions in the owner's manual for the speaker system.
- Refer to the owner's manual of the connected equipment as well.
- When you connect the DVD video player to other equipment, be sure to turn off the power and unplug all of the equipment from the wall outlet before making any connections.
- The output sound of the DVD video player has a wide dynamic range. Be sure to adjust the receiver's volume to a moderate listening level. Otherwise, the speakers may be damaged by a sudden high volume sound.
- Turn off the amplifier before you connect or disconnect the DVD video player's power cord. If you leave the amplifier power on, the speakers may be damaged.

Warning

Do not set "AUDIO OUT SEL." to "AC-3" via the on-screen displays [28] [29] unless you are connecting (via the PCM/AC-3 DIGITAL AUDIO OUT jack) an AV decoder that has the Dolby Digital (AC-3) decoding function. High volume sound may damage your hearing as well as the speakers.

Enjoying Dolby Pro Logic Surround Sound

Dolby Pro Logic Surround

You can enjoy Dolby Pro Logic Surround sound by connecting an amplifier and speaker system (right and left front speakers, a center speaker, and one or two rear speakers).

- With an amplifier equipped with Dolby Digital (AC-3), connect the equipment the same way as described in "Enjoying Dolby Digital (AC-3) Sound" [13]. Refer to that amplifier's owner's manual and set the amplifier so you can enjoy Dolby Pro Logic Surround sound.
- With an amplifier not equipped with Dolby Digital (AC-3), connect the equipment as follows.

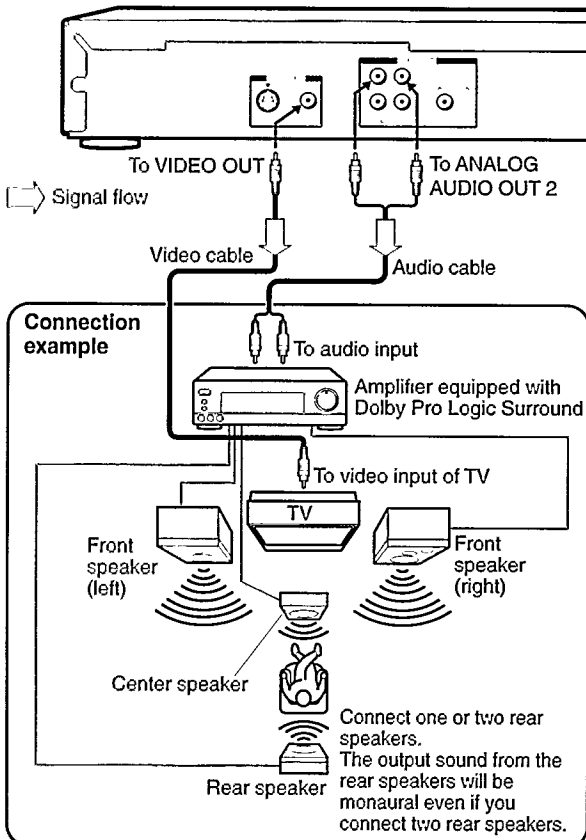

- Set "AUDIO OUT SEL." to "PCM" via the on-screen displays. [28] [29]

Enjoying Two-channel Digital Stereo Sound

Two-channel Digital Stereo

You can enjoy Two-channel Digital Stereo sound by connecting an amplifier equipped with a digital audio input and speaker system (right and left front speakers).

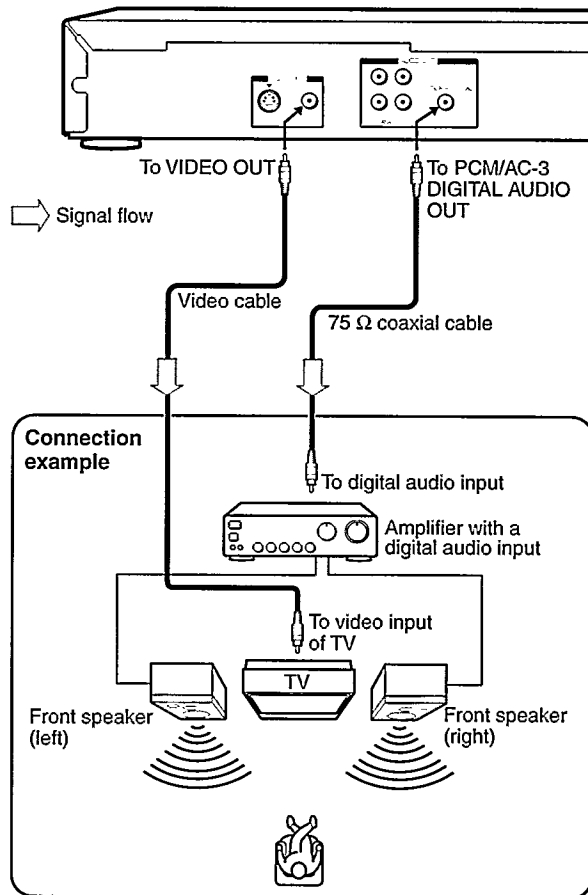

- Set "AUDIO OUT SEL." to "PCM" via the on-screen displays. [28] [29]

Notes

- Connect the speakers according to the instructions in the owner's manual for the speaker system.
- Refer to the owner's manual of the connected equipment as well.
- When you connect the DVD video player to other equipment, be sure to turn off the power and unplug all of the equipment from the wall outlet before making any connections.
- The output sound of the DVD video player has a wide dynamic range. Be sure to adjust the receiver's volume to a moderate listening level. Otherwise, the speakers may be damaged by a sudden high volume sound.
- Turn off the amplifier before you connect or disconnect the DVD video player's power cord. If you leave the amplifier power on, the speakers may be damaged.

Playing a Disc

CAUTION

Keep your fingers well clear of the disc tray as it is closing. It may cause serious personal injury.

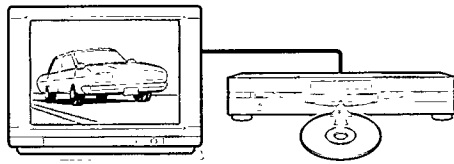



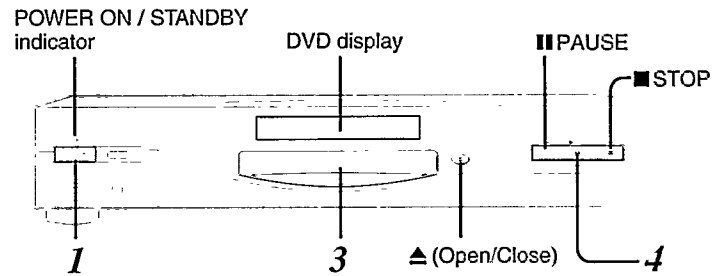

This section shows you how to play a disc.



Basic Playback

■ Preparations

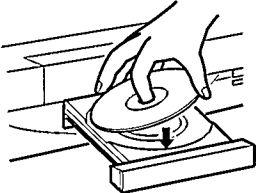
- When you want to play DVD video discs or VIDEO CDs, turn on the TV and put the TV in Auxiliary (Line) input mode.
- When you want to enjoy the sound of a disc from the audio system, turn on the audio system and set the amplifier to receive Auxiliary input.
- For connection details, see "Connections." [11] - [14]
- Set the playback picture size according to the picture tube shape or aspect ratio of the connected TV via the on-screen displays. [28] [33]
- If you do not have the necessary equipment to enjoy Dolby Digital (AC-3) sound, set "AUDIO OUT SEL." to "PCM" via the on-screen displays. [28] [29]

<p>1</p> 	<p>Press POWER.</p> <p>The DVD video player turns on and the POWER ON / STANDBY indicator on the player lights.</p>	<p>Note</p> <p>If you hear a beep by the remote control's locator, press any button on the remote control to turn it off. [10]</p>
<p>2</p> 	<p>Press ▲ on the front panel (or hold down ■/EJECT on the remote control for longer than one second).</p> <p>The disc tray opens.</p>	
<p>3</p>	<p>Place the disc in the disc tray.</p>  <p>With the label facing up</p>	<p>Notes</p> <ul style="list-style-type: none"> • There are two different disc sizes. Place the disc in the correct guide in the disc tray. If the disc is out of the guide, it may damage the disc and cause the DVD video player to malfunction. • Do not place anything except DVD video discs, VIDEO CDs, or audio CDs in the disc tray.
<p>4</p> 	<p>Press ►.</p> <p>The disc tray closes and playback starts.</p> <p>If you insert a DVD video disc that contains a title menu, or insert a PBC (Playback Control)-controllable VIDEO CD, a menu screen may appear. See "To start playback from the menu screen." [16]</p> <p>To start playback of a PBC-controllable VIDEO CD from the menu screen, set "PBC" to "ON" via the on-screen displays. [28] [31]</p>	<p>Notes</p> <ul style="list-style-type: none"> • For PBC (Playback Control) of VIDEO CDs, see "On VIDEO CD." [43] • You may need to press the TITLE or MENU button on the remote control to display the menu screen, depending on the disc.

Notes

- Do not move the DVD video player during playback. Doing so may damage the disc.
- Use the ■/EJECT button on the remote control or the ▲ button on the DVD video player to open and close the disc tray. Do not push the disc tray while it is moving. Doing so may cause the DVD video player to malfunction.
- Do not push up on the disc tray or put any objects other than discs on the disc tray. Doing so may cause the DVD video player to malfunction.

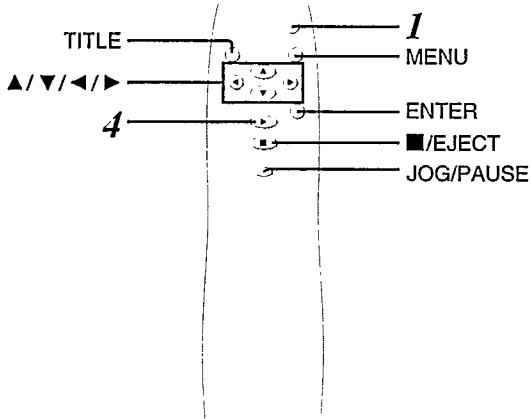

■ **To obtain a higher quality picture**

Occasionally, some picture noise may appear on the TV screen while playing back a DVD video disc because the high resolution pictures on these discs include a lot of information. While the amount of noise depends on the TV, you should reduce the sharpness adjustment on your TV from the position you usually set for normal broadcasts.

■ **About**

The , , symbols on the heading bars in this manual show the playable discs for the function described under that heading.

: You can use this function with DVD video discs.

: You can use this function with VIDEO CDs.

: You can use this function with audio CDs.

To start playback from the menu screen

- 1 Press ▲/▼/◀/▶ or the number buttons to select the title you want.

Example

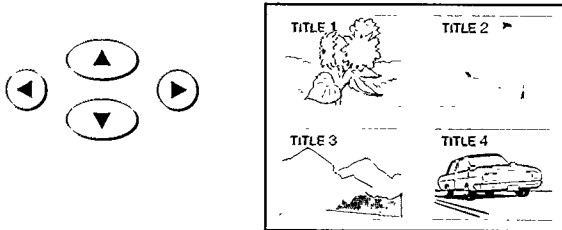

- 2 Press ENTER. (You do not have to press ENTER to start playback if you use the number buttons at step 1.)



The DVD video player starts playback from the selected title.

- When not using the menu screen of a PBC-controllable VIDEO CD, set "PBC" to "OFF" via the on-screen displays.

To stop playback



Press ■/EJECT.

The DVD video player returns to chapter 1 or track 1.

Note

In many instances, a menu screen will appear after playback of a movie is completed. Prolonged display of an on-screen menu may damage your television set, permanently etching that image onto its screen. To avoid this, be sure to press the ■/EJECT button once the movie is completed.

To pause playback (still playback)



Press JOG/PAUSE during playback.

To resume normal playback, press the ▶ button.

- The sound is muted during still playback.

To remove the disc



Hold down ■/EJECT (for longer than one second) until the disc tray opens.

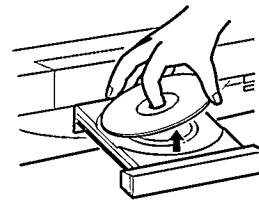

Remove the disc after the disc tray opens completely.

- Be sure to hold down the ■/EJECT button for longer than one second to close the disc tray after you remove the disc.

Basic Playback

About this Manual

This owner's manual explains the basic instructions of this DVD video player. Some DVD video discs are produced in a manner that allows specific or limited operation during playback. As such, the DVD video player may not respond to all operating commands. Refer to the instruction notes of discs.

"❌" may appear on the TV screen during operation. A white "❌" means that the operation is not permitted by the DVD video player; a red "❌" means the operation is not permitted by the DVD video disc.

Playing a Disc (continued)

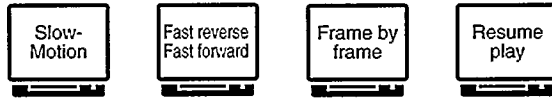

You can play discs at various speeds, then resume normal playback from the location where you stopped playback.

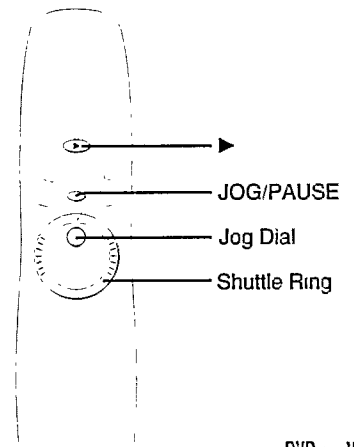

Using the Shuttle Ring DVD VCD CD

You can play discs at various speeds by turning the Shuttle Ring.

1  **Press and hold JOG/PAUSE during playback.**

The JOG/PAUSE button lights and the playback pauses.

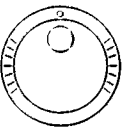
2  **Turn the Shuttle Ring.**
The playback speed can be controlled by the extent of the wheel rotation.

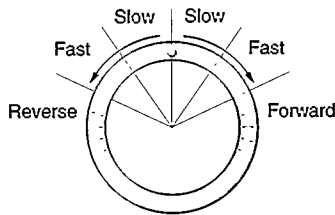

Using the Jog Dial DVD VCD

You can advance/reverse a disc frame-by-frame using the Jog Dial.

1  **Press and hold JOG/PAUSE during playback.**

The JOG/PAUSE button lights and the playback pauses.

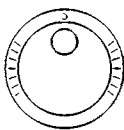
2  **Turn the Jog Dial.**
Rightward: To advance the picture frame-by-frame.
Leftward: To reverse the picture frame-by-frame.

To finish operating the Shuttle Ring

 **Press JOG/PAUSE again to turn it off.**

To finish operating the Jog Dial

 **Press JOG/PAUSE again to turn it off.**

Notes

- The playback speed may differ depending on the disc.
- If you slow down the playback speed of a DVD video disc by turning the ring leftward, the DVD video player performs reverse frame playback. The reverse frame playback may advance more rapidly than a forward frame playback.

Notes

- The sound is muted during frame-by-frame playback.
- The reverse frame playback may advance more rapidly than a forward frame playback.

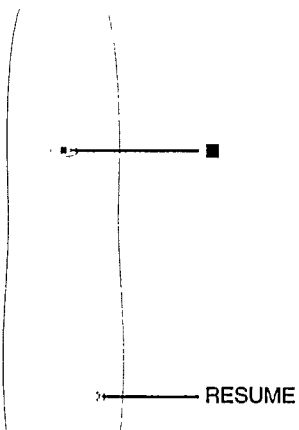

DVD > VCD > CD >

Resuming Playback from the Same Location

You can stop playback and resume playback later from the same location on the disc.

1  **Press ■ /EJECT at the location where you want to interrupt playback.**

The DVD video player memorizes the location where you stopped playback.

2  **Press RESUME.**

The DVD video player resumes playback from the location where you stopped playback.

Notes

- The playback resuming function is canceled when:
 - you unplug the DVD video player from the wall outlet after you stop playback.
 - you eject the disc.
 - you adjust/change parental lock [35] or select a disc menu language setting [34].
- There may be a difference of the location where playback resumes depending on the disc.

Locating a Specific Title, Chapter, or Track

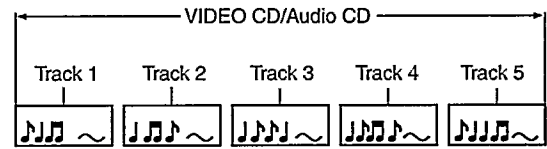
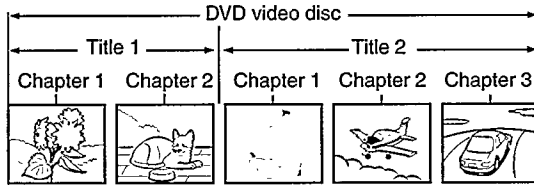

Normally, DVD video discs are divided into titles, and the titles are sub-divided into chapters. VIDEO CDs and Audio CDs are divided into tracks. You can quickly locate any specific title, chapter, or track.

Locating a Title Using the Title Menu

If a DVD video disc contains a title menu, you can locate a specific title using the title menu.

1



Press **TITILE**.

The title menu appears on the TV screen.

Example of a title menu

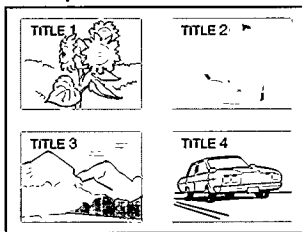

2



Press **▲/▼/◀/▶** to select the title you want.

If the titles in the title menu are assigned a number, you can directly locate a specific title by pressing its assigned number with the **number buttons**.

3



Press **ENTER**.

The DVD video player starts playback from chapter 1 of the selected title.

(You may not need to press ENTER if you use the number buttons at step 2.)

Notes

- The instructions above describe the basic procedure. The procedure varies depending on the contents of the DVD video disc. If different instructions appear on the TV screen, follow those instructions.
- If you display the title menu during playback and press the TITILE button again without selecting any title, the DVD video player may resume playback from the point where you first pressed the TITILE button. If it does not, press ▶ to resume playback.

Locating a Title

You can locate a specific title by entering a title number.

1



Press **T-C**.

Make sure that the space next to TITILE is highlighted.

Example

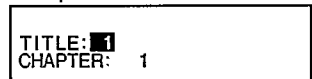

2

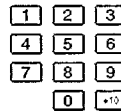

Press the corresponding number buttons for the title you want.

Example: To select title 2, press



To select title 12, press

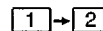

3



Press **▶**.

The DVD video player starts playback from chapter 1 of the selected title.

Notes

- You can shift the highlight between TITILE and CHAPTER by pressing the ▲/▼ buttons.
- To clear the TITILE and CHAPTER display, press the T-C button repeatedly.
- You can select a preferred language for on-screen displays. [28] [33]

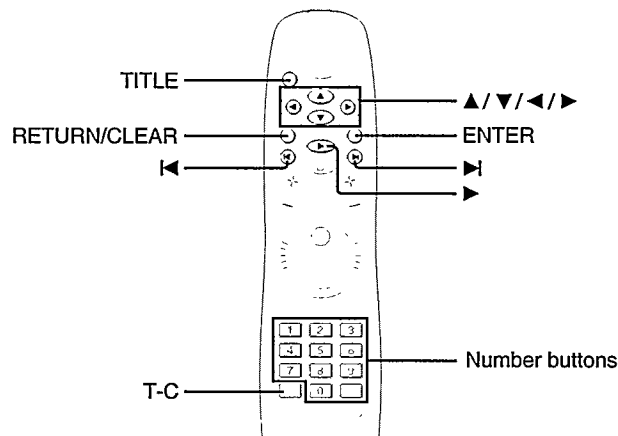

Locating a Specific Chapter or Track Directly

If you know the chapter or track number you want to play, you can locate it directly.

1 **Press T-C.**
Skip steps 1 and 2 if you are using a VIDEO CD or an audio CD.

Example: DVD video disc

TITLE: 1
CHAPTER: 1

2 **Press ▼ to highlight the space next to CHAPTER.**

Example: DVD video disc

TITLE: 1
CHAPTER: 1

3 **Press the corresponding number buttons of the chapter or track you want.**

You can use the button to select numbers from 10 through 99.

Example: To select chapter or track 25, press

DVD video disc VIDEO CD/Audio CD

• → OR → →

TITLE: 1 CHAPTER: 25 TRACK: 25

4 **Press ►.**
The DVD video player starts playback from the selected chapter or track.

To select a title and chapter number at the same time

Example: To select chapter 25 in title 2, press

→ → → → →

Title number Chapter number

TITLE: 2
CHAPTER: 25

Note

To clear the TITLE and CHAPTER display, press the T-C button repeatedly.

Locating a Specific Chapter or Track

You can fast forward or reverse through consecutive chapters or tracks.



Press ◀ or ▶ repeatedly to advance or reverse to the chapter or track number you want.



The DVD video player starts playback from the selected chapter or track.

◀: To locate preceding chapters or tracks
When you press the ◀ button, the DVD video player starts playback from the beginning of the current chapter or track.
When you press the ◀ button twice, the DVD video player starts playback from the beginning of the preceding chapter or track.

▶: To locate succeeding chapters or tracks

Note

Some titles may not display the chapter number.

Locating a Specific Location on the Disc

You can locate a specific location by entering the time (hours, minutes, seconds).

1 **Press T-C twice.**

TIME 00:00

2 **Press the number buttons to enter the time.**

Example → → → →

TIME 1:25:30

3 **Press ►.**

The DVD video player starts playback from the specified location.

Note

Some discs may not respond to this feature.

Playing Repeatedly

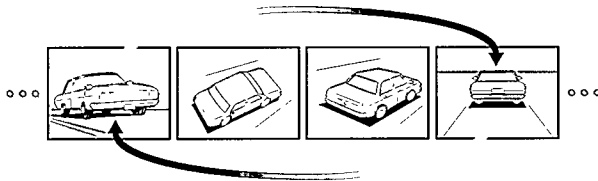

You can play a specific title, chapter, track, or segment repeatedly. (Title repeat, chapter/track repeat, A-B repeat)

DVD VCD CD

Repeating a Title, Chapter, or Track

You can play the same title, chapter, or track repeatedly. (Title, chapter/track repeat)

1 Begin playback of the title, chapter or track you want to repeat. [19] [20]

2  **Press REPEAT.**
Each time you press the REPEAT button, the repeat mode changes as follows.

• DVD video disc

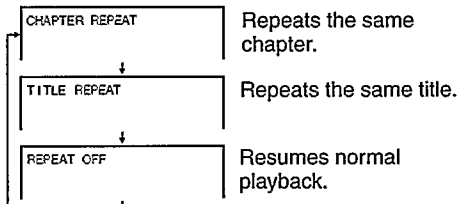

• VIDEO CD/Audio CD

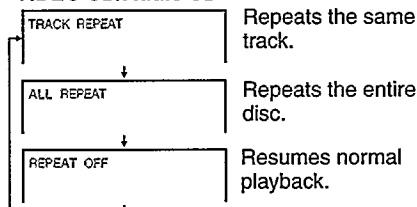

To resume normal playback



Hold down RETURN/CLEAR for longer than one second.

RETURN/
CLEAR

REPEAT A-B REPEAT

DVD VCD CD

Repeating a Specific Segment

You can play a specific segment repeatedly. (A-B repeat)

1  **During playback, press REPEAT A-B at the beginning of the segment (point A) you want to play repeatedly.**

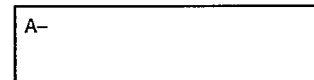

2  **Press REPEAT A-B again at the end of the segment (point B).**



The DVD video player automatically returns to point A and starts repeat playback of the selected segment (A-B).

To resume normal playback



Hold down RETURN/CLEAR for longer than one second.

Notes

- You can specify a segment only within the current title.
- You cannot set the A-B repeat function for a segment that includes multiple camera angles.
- There may be a slight difference between point A and the location where playback actually resumes, depending on the disc.

Playing in a Favorite Order

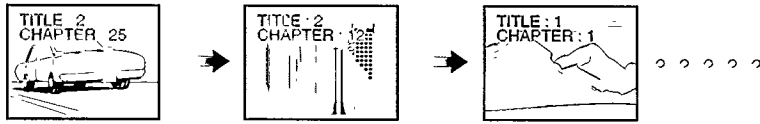

You can combine your favorite titles, chapters, or tracks and play them in any order. You can program up to 30 items into the memory. (Memory playback)

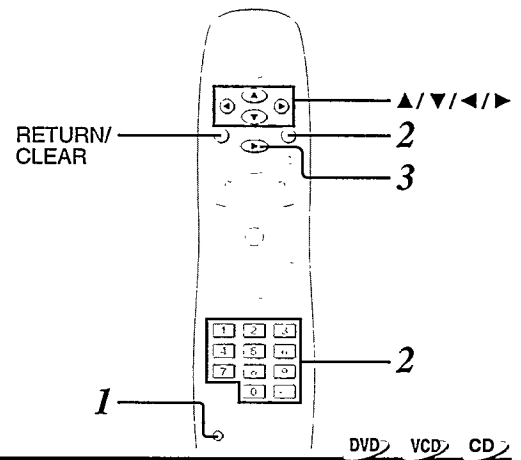

Setting Titles, Chapters, or Tracks in a Favorite Order

The DVD video player automatically plays titles, chapters, or tracks in the order you program.

1 While playback is stopped, insert a disc and press MEMORY.

The following menu appears.

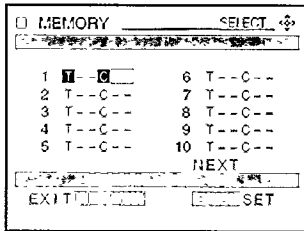

T: Title number C: Chapter number

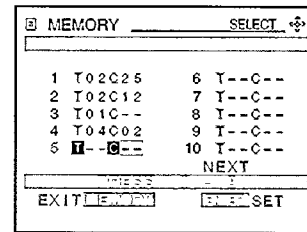

To select another chapter in the same title, you do not need to select the title number.

2 Enter the items you want, in order, by pressing the number buttons, then ENTER for each item.

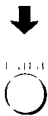
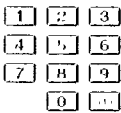

Each time you press the ◀/▶ button, the -- indication next to T and C is highlighted in turn. Highlight the -- indication next to T (to select a title) or C (to select a chapter), then press the number buttons.

Example: To play chapter 25 in title 2, chapter 12 in title 2, all the chapters in title 1, and chapter 2 in title 4.

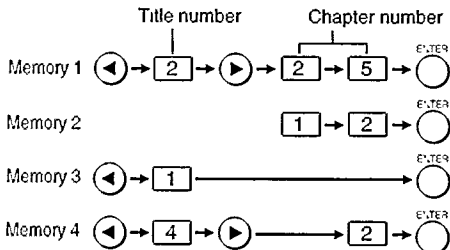

To select tracks from a VIDEO CD/Audio CD in order, press the number buttons for the track, then press the ENTER button for each item you want.

3 Press ▶ while the MEMORY menu appears on the TV screen.



The DVD video player starts memory playback.

To change the programmed items

- 1 While the MEMORY menu appears on the TV screen, press ▲/▼ to move the highlighted bar to the item you want to change.
- 2 Change the item following the instructions at step 2.

To cancel the programmed items

- 1 While the MEMORY menu appears on the TV screen, press ▲/▼ to move the highlighted bar to the item you want to cancel.
- 2 Hold down the RETURN/CLEAR button for longer than one second.

To resume normal playback from memory playback



Hold down RETURN/CLEAR for longer than one second.

The MEMORY indicator disappears.

Notes

- If you press the MEMORY button during memory playback, the programmed items will be displayed.
- You cannot select title, chapter, and track numbers not included on the disc.
- If you press the MEMORY button while the MEMORY menu appears on the TV screen, the MEMORY menu disappears.
- The programmed items will be cleared when:
 - you turn off the DVD video player, or
 - you remove the disc.

All rights reserved by Philips.

Playing in Random Order

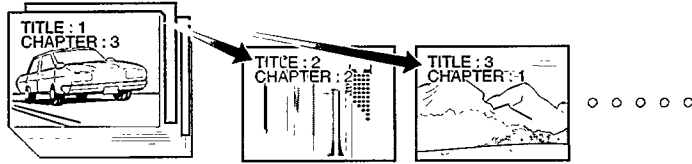

You can play titles, chapters within a title, or tracks in random order. (Random playback)

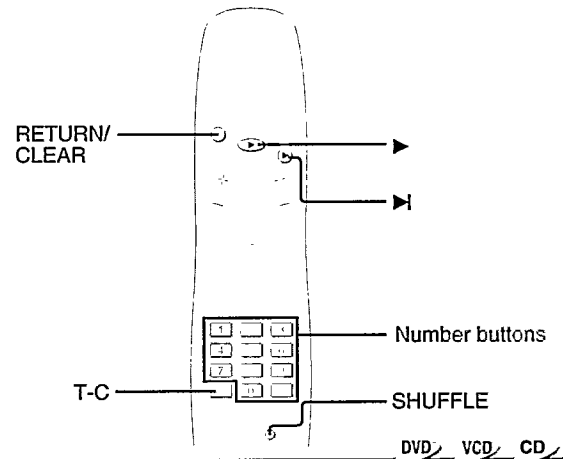

Playing Titles in Random order

The DVD video player automatically selects the titles in a DVD video disc and plays them randomly.

1 Press **SHUFFLE** twice while playback is stopped.

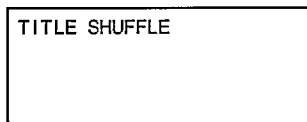

If you press the SHUFFLE button during playback, the DVD video player automatically starts random playback after finishing the current title.

2 Press **▶**.



The DVD video player starts random playback.

Press the **▶** button within about five seconds after you press the SHUFFLE button.

To resume normal playback



Hold down RETURN/CLEAR for longer than one second.

Note

You cannot use the random playback function and the memory playback function at the same time.

Playing Chapters or Tracks in Random Order

The DVD video player automatically selects chapters within a title, or tracks on a VIDEO CD/Audio CD, and plays them randomly.

1 Press **T-C**, then press the appropriate number buttons for the title which contains the chapters you want to play in random order.

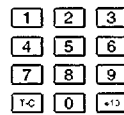

Skip this step if you are using a VIDEO CD/Audio CD.

Example: To play the chapters in title 2 in random order, press

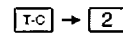

• DVD video disc



2 Press **SHUFFLE** while playback is stopped.



• DVD video disc

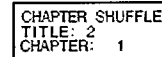

• VIDEO CD/Audio CD

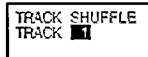

If you press the SHUFFLE button during playback, the DVD video player automatically starts random playback after finishing the current chapter or track.

3 Press **▶**.



The DVD video player starts random playback.

Press the **▶** button within about five seconds after you press the SHUFFLE button.

To resume normal playback



Hold down RETURN/CLEAR for longer than one second.

Note

If you press the **▶** button during random playback, the DVD video player goes to another chapter or track and starts playback.

Zooming a Picture

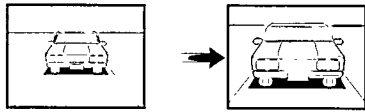

You can magnify areas within a picture.

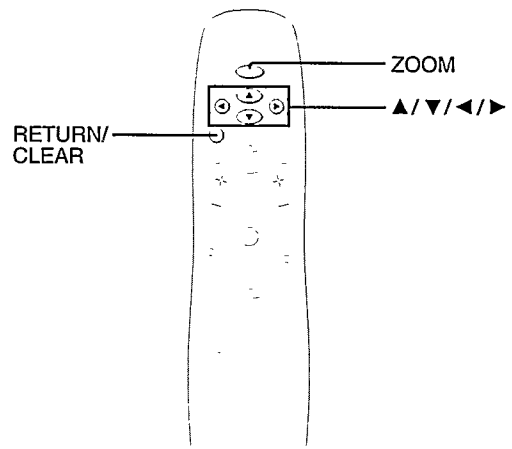

DVD

Zooming a Picture

You can zoom a picture. You can shift the zoom point as well.



Press ZOOM during playback.

The DVD video player magnifies the center of the picture.

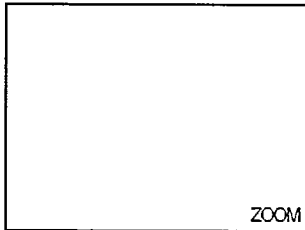

If you press the ▲/▼/◀/▶ buttons during zoom playback, the zoom point shifts. If the zoom point reaches the limit, the color of "ZOOM" changes. If you hold down the RETURN/CLEAR button for longer than one second, the zoom point returns to the center of the picture.

To resume normal playback



Press ZOOM during zoom playback.

Advanced Playback

Notes

- During still playback, the ZOOM button cannot turn the zoom on or off.
- Zooming does not work on the sub-pictures such as subtitles or menu screens included on DVD video discs.

Selecting the Camera Angle/Selecting a Language

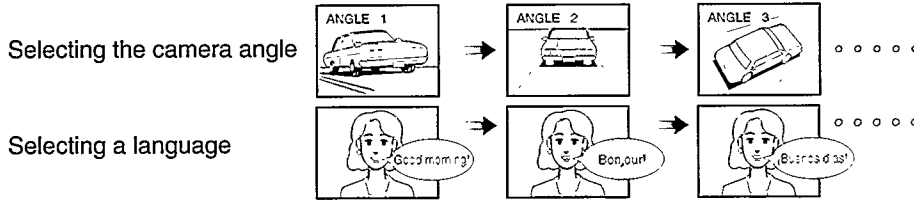

A preferred angle can be selected from several angles.
A preferred language can be selected from several languages.

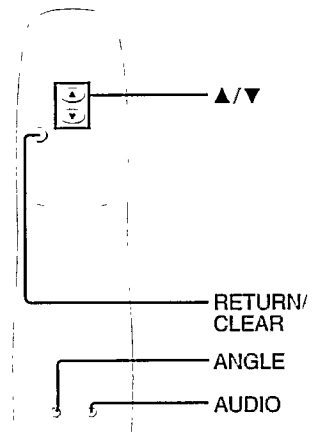

Changing the Camera Angle

If the scene was recorded from multiple angles, you can easily change the camera angle of the scene you are watching.

1 **ANGLE**

Press ANGLE while playing a scene recorded from multiple angles.

Press the ANGLE button while the angle icon in the DVD display is flashing. ()

ANGLE 1

Current angle number appears

2 **ANGLE**

Press ANGLE or ▲ while the angle number appears on the TV screen.

Each time you press the ANGLE or ▲ button, the camera angle changes.

ANGLE 1

↓

ANGLE 2

↓

ANGLE 3

↓

▼ : Cycles backwards

- You can change the camera angle directly by pressing the number buttons for the angle number.
- Holding down the RETURN/CLEAR button for longer than one second clears the angle number indication.

Notes

- You can change the camera angle during still playback. The camera angle changes to the new setting when you resume normal playback.
- While playing back a title that contains at least one scene recorded from multiple angles, the angle icon indicator flashes in the DVD display.
- To make the angle icon appear on-screen, see pages 33 - 34.

Selecting a Playback Audio Setting

You can easily select a preferred language and sound recording system from those included on the DVD video disc.

1 **AUDIO**

Press AUDIO during playback.

AUDIO 1 ENG PCM 2CH

Audio channel

Recording system

Language

Position number

Current audio setting appears for about three seconds

The abbreviation of the language appears instead of the language name. Refer to the list of languages and their abbreviations. 33

2 **AUDIO**

Press AUDIO or ▲ while the audio setting appears on the TV screen.

Each time you press the AUDIO or ▲ button, the audio settings included on the DVD video disc change.

Example

AUDIO 1 ENG PCM 2CH

↓

AUDIO 2 FRE AC-3 6CH

↓

AUDIO 3 SPA PCM 2CH

↓

- ▼ : Cycles backwards
- Holding down the RETURN/CLEAR button for longer than one second clears the audio setting indication.

About recording systems

This DVD video player uses the Dolby Digital (AC-3) and PCM recording systems and cannot play DVD video discs recorded in any other recording system.

AC-3 5.1 Channel is displayed as "AC-3 6CH."

Note

When you turn on the DVD video player or replace a disc, the player returns to the initial default setting. 29

When you select a sound which is not included on the disc, the DVD video player plays a prior sound programmed on the disc.

Selecting Subtitles



You can display subtitles on the TV screen and select a preferred subtitle language.

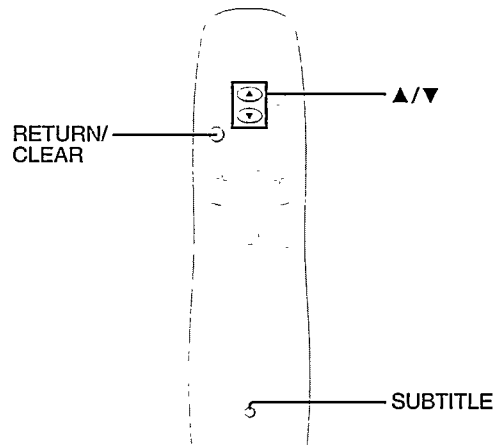

Displaying Subtitles

You can display subtitles from those included on the DVD video disc.

SUBTITLE



Hold down SUBTITLE for longer than one second during playback.

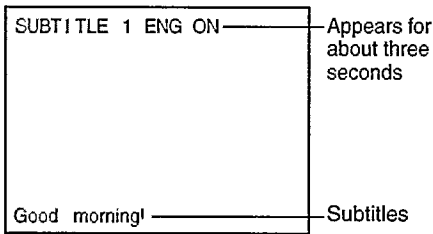

To turn off the subtitles

SUBTITLE



Hold down SUBTITLE for longer than one second.

The subtitles disappear.

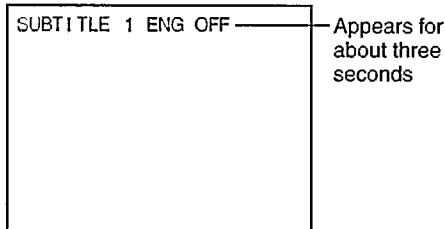

Notes

- Some DVD video discs are set to display subtitles automatically, and you cannot turn them off even if you set the subtitle function to off.
- During some scenes, the subtitles may not appear immediately after you press the SUBTITLE button.

Selecting a Subtitle Language

You can easily select the subtitle language from those included on the DVD video disc.

1

SUBTITLE



Press SUBTITLE during playback.

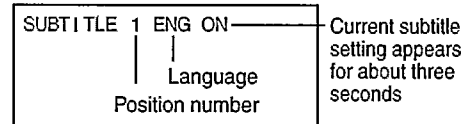

The abbreviation of the language appears instead of the language name. Refer to the list of languages and their abbreviations. [39]

2

SUBTITLE



Press SUBTITLE or ▲ while the subtitle setting appears on the TV screen.



Each time you press the SUBTITLE or ▲ button, the subtitle languages included on the DVD video disc change.

Example

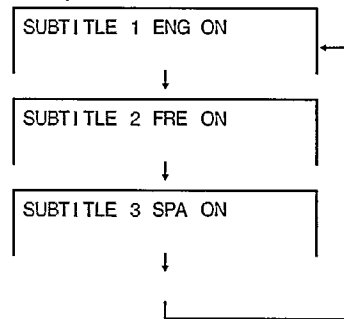

▼ : Cycles backwards

To turn off the subtitle setting indication



Hold down RETURN/CLEAR for longer than one second.

Notes

- When you turn on the DVD video player or replace a disc, the player returns to the initial default setting.
- When you select a subtitle language which is not included on the disc, the DVD video player plays a prior language programmed on the disc.
- During some scenes, the subtitles may not appear immediately after you change the subtitle language by pressing the ▲/▼ buttons.

Using the On-Screen Display

You can view information about a disc and its operational status on the TV screen.

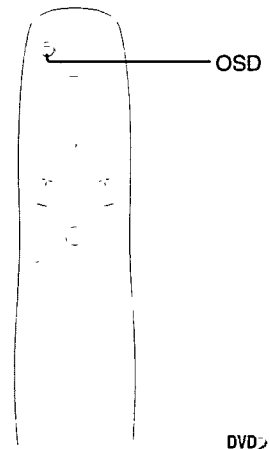

Checking the Operational Status DVD VCD CD

You can view the current title number, track number, and total playing time of the disc on the TV screen.



Press OSD while playback is stopped.

DVD video disc

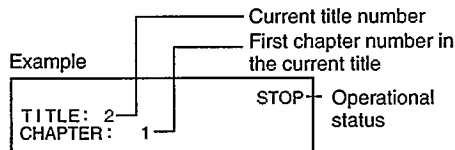

VIDEO CD/Audio CD

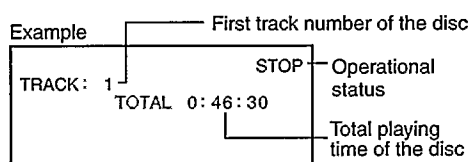

Total playing time of the disc is displayed in the DVD display.

To turn off the on-screen display



Press OSD again.

Checking the Remaining Time and Setting Status DVD VCD CD

You can view the elapsed time, remaining time, and setting status of the disc on the TV screen.

1



Press OSD during playback.

DVD video disc

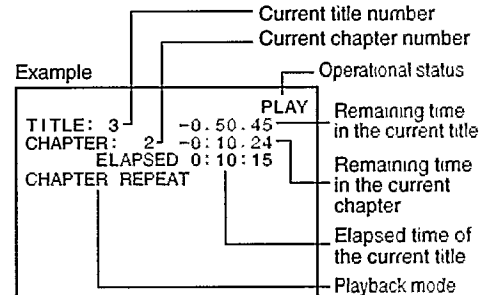

Remaining time in the current title appears in the DVD display.

VIDEO CD/Audio CD

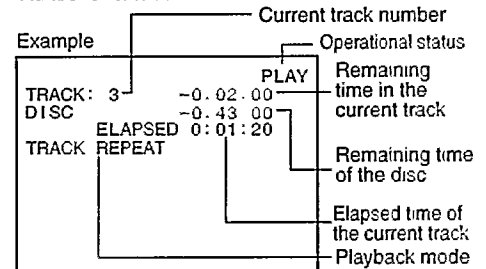

Remaining time in the current track appears in the DVD display.

2



Press OSD again during playback.

When you play back a VIDEO CD/Audio CD, the on-screen display turns off.

DVD video disc

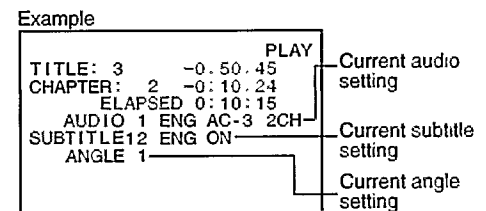

The abbreviation of the language (e.g. ENG) appears instead of the language name. Refer to the list of languages. [39]

To turn off the on-screen display



Press OSD again.

Customizing the Settings

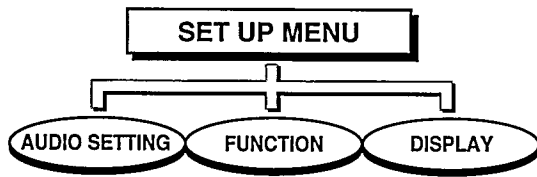

You can change the default settings to customize performance to your preference.

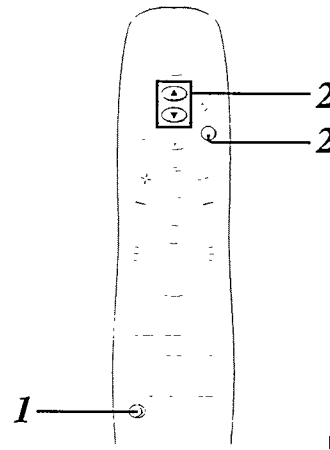

DVD VCD CD

Displaying the SET UP MENU Screen

The SET UP MENU screen asks you to select a setting for AUDIO SETTING, FUNCTION and DISPLAY. You may adjust the settings in the category using the succeeding screen.

1 Press **SETUP** while playback is stopped.



The SET UP MENU screen appears.



- The display language can be changed. Select DISPLAY in step 2, then select SCREEN DISPLAYS to change the display language **33**.

2 Press **▲/▼** to select the category (AUDIO SETTING, FUNCTION or DISPLAY), then press **ENTER**.

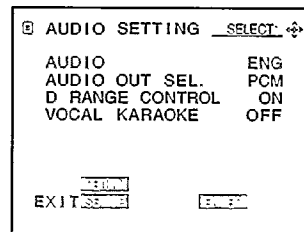
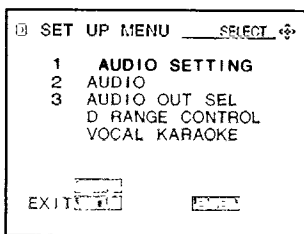
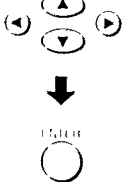

For details on the AUDIO SETTING category, see pages **29** **30**.

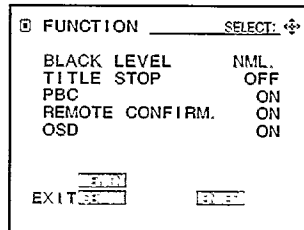
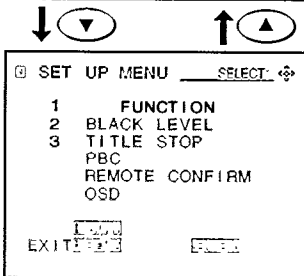

For details on the FUNCTION category, see pages **31** **32**.

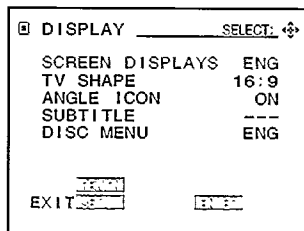
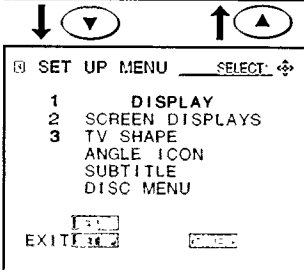

For details on the DISPLAY category, see pages **33** **34**.

Note

The SET UP MENU screen disappears if you press the SETUP button while it is displayed.

Customizing the Settings (continued)

AUDIO SETTING

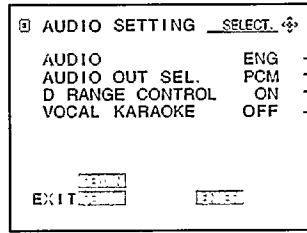

- To select a preferred language from those included on the disc. [25]
- To switch AC-3 and PCM. [11] [12] [13] [14] [43]
- To turn on or off the function that makes faint sounds easier to hear, even if you lower the volume in late hours playback.
- To turn on or off the vocal output in DVD KARAOKE disc playback.

Setting the Audio Sound

After you select AUDIO SETTING on the SET UP MENU screen [28], adjust the categories to your preference.

3

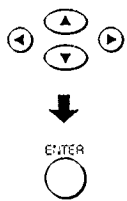

Press ▲/▼ to select the item, then press ENTER.
The setting screen of your selected item appears.

When AUDIO is selected: DVD

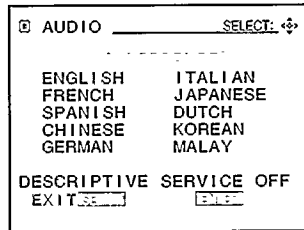

Select a preferred language by pressing ▲/▼/◀/▶, then press ENTER.

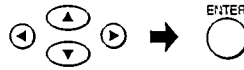

- Some DVD video discs contain special audio that describes the actions on-screen for visually impaired persons. When you set DESCRIPTIVE SERVICE to "ON" by pressing the AUDIO button, the DVD video player automatically plays this special feature.

- Some DVD video discs may not include your pre-selected language. In this case, the DVD video player automatically plays the disc's initial language offering.

When AUDIO OUT SEL. is selected: DVD VCD CD

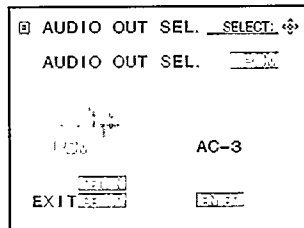

Select the output sound type AC-3 or PCM by pressing ◀/▶, then press ENTER.

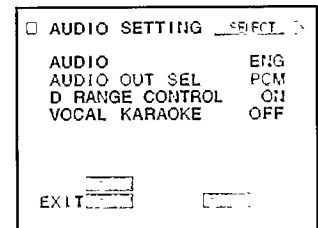

- Select the output sound type according to your system connection. [11] [12] [13] [14] [43]

When D RANGE CONTROL is selected: DVD

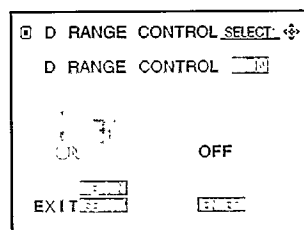

Select ON or OFF by pressing ◀/▶, then press ENTER.

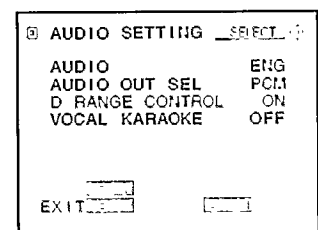
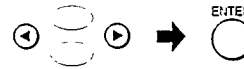

- ON: Dynamic range is reduced.
- OFF: Full dynamic range is heard.

- This function works on playback of Dolby Digital (AC-3) recorded discs
- The level of dynamic range reduction may differ depending on the DVD video disc.

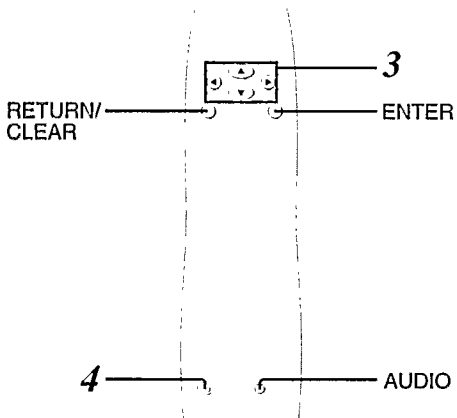

: If you press the RETURN/CLEAR button while a menu appears on the screen, you will return to the previous menu screen.

DVD VCD CD

When VOCAL KARAOKE is selected:

VOCAL KARAOKE **ON**

Select ON or OFF by pressing
◀ / ▶, then press ENTER.

AUDIO SETTING **OFF**

ON: The vocal is output when it is recorded on the disc.
OFF: The vocal is not output.

The vocal karaoke feature is used during playback of AC-3 encoded DVD KARAOKE discs. This feature allows you to turn off vocal audio tracks, or restore them for background accompaniment.

4



Press SETUP.

The setting screen disappears.

Full Screen Setup

Customizing the Settings (continued)

FUNCTION

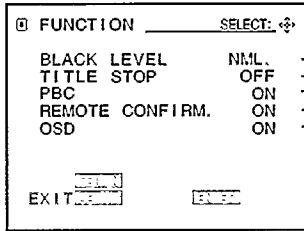

- To select the black level (contrast) of playback pictures.
- To turn on or off the function that automatically stops playback after playing one title.
- To use the menu screens when playing PBC-controllable VIDEO CDs. **16**
- To turn on or off the confirmation beeper for each press of a remote control button.
- To turn on or off the operational status display (on-screen display) on the TV screen.

Setting the Functions

After you select FUNCTION on the SET UP MENU screen **28**, adjust the categories to your preference.

3 Press **▲/▼** to select the item, then press **ENTER**.
The setting screen of your selected item appears.

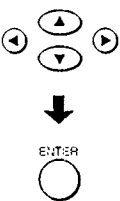

When BLACK LEVEL is selected: DVD VCD

Select a preferred black level by pressing **◀/▶**, then press **ENTER**.

NORMAL: Standard black level (contrast).
ENHANCED: Increased black level (contrast).

When TITLE STOP is selected: DVD

Select **ON** or **OFF** by pressing **◀/▶**, then press **ENTER**.

OFF: Player continues playing the disc after playback of a title is completed.
ON: Player stops playing the disc after playback of a title is completed.

When PBC is selected: VCD

Select **ON** or **OFF** by pressing **◀/▶**, then press **ENTER**.

ON: To use the menu screen when playing a PBC-controllable VIDEO CD.
OFF: When playing without using the menu screen.

- PBC is the abbreviation of Playback Control.

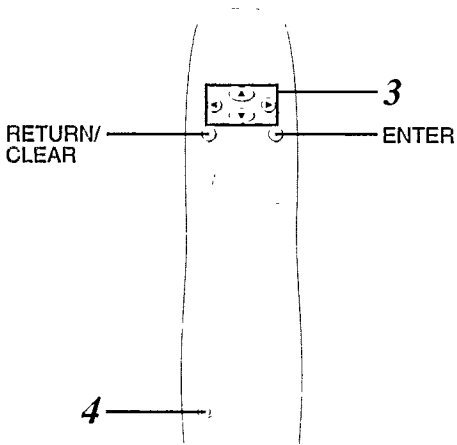

: If you press the RETURN/CLEAR button while a menu appears on the screen, you will return to the previous menu screen.

DVD VCD CD

When REMOTE CONFIRM. is selected: DVD VCD CD

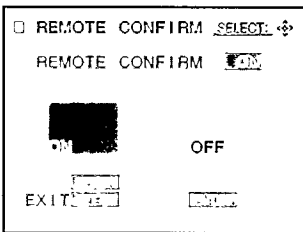

Select ON or OFF by pressing **◀/▶**, then press ENTER.

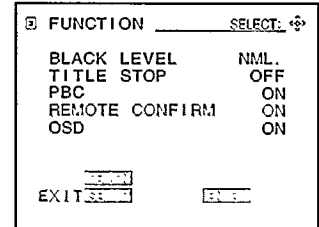

ON: Beeper sounds with each press of a remote control button.
OFF: The beeper does not sound.

When OSD is selected: DVD VCD CD

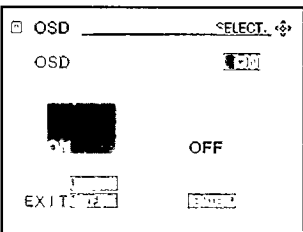

Select ON or OFF by pressing **◀/▶**, then press ENTER.

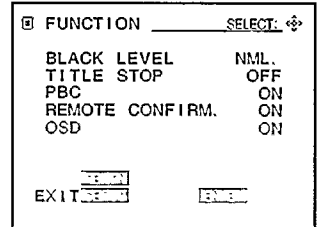

ON: Operational modes are displayed on-screen. (e.g. "PLAY")
OFF: Operational modes are not displayed.

4



Press SETUP.

The setting screen disappears.

Function Setup

Customizing the Settings (continued)

DISPLAY

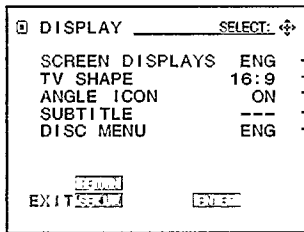

To select the display language.

To select a picture size according to the aspect ratio of your TV.

To display the angle icon indicator on screen.

To select a preferred subtitle language from those included on the DVD video disc. **[26]**

To select a preferred disc menu language from those included on the DVD video disc.

Setting the Displays

After you select DISPLAY on the SET UP MENU screen **[28]**, adjust the categories to your preference.

3

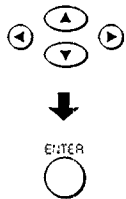

Press **▲/▼** to select the item, then press **ENTER**.

The setting screen of your selected item appears.

When **SCREEN DISPLAYS** is selected: **DVD** **VCD** **CD**

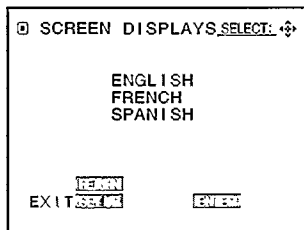

Select a preferred language by pressing **▲/▼**, then press **ENTER**.

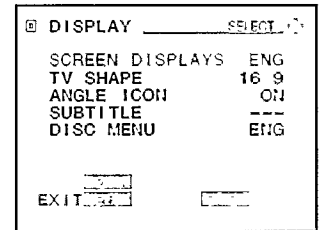
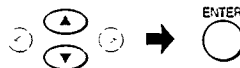

When **TV SHAPE** is selected: **DVD**

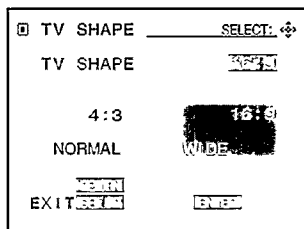

Select your TV type by pressing **◀/▶**, then press **ENTER**.

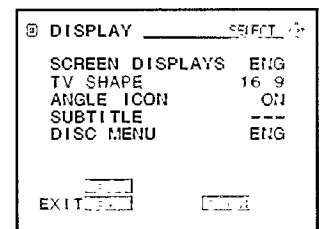

16:9 (WIDE): Select when a 16:9 wide TV is connected.
4:3 (NORMAL): Select when a 4:3 normal TV is connected.

- The displayable picture size is preset on the DVD video disc. Therefore, the playback picture of some DVD video discs may not conform to the picture size you select
- When you play DVD video discs recorded in the 4:3 picture size only, the playback picture always appears in the 4:3 picture size, regardless of the TV shape setting

If you select **4:3 (NORMAL)**:

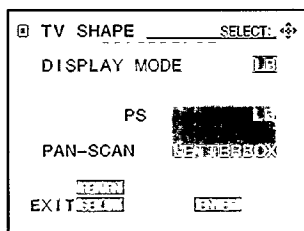

Select **PS** or **LB** by pressing **◀/▶**, then press **ENTER**.

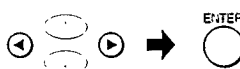

PS (PAN-SCAN):

Displays pictures cropped to fill your TV screen. Either or both sides of the picture are cut off.

LB (LETTER BOX):

Displays theatrical images with masking bars above and below the picture.



PS (PAN-SCAN)



LB (LETTERBOX)

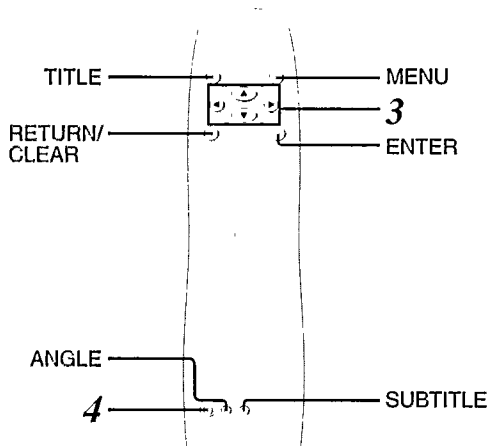

: If you press the RETURN/CLEAR button while a menu appears on the screen, you will return to the previous menu screen.

DVD VCD CD

When ANGLE ICON is selected: DVD

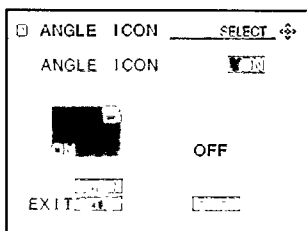

Select ON or OFF by pressing **◀/▶**, then press ENTER.

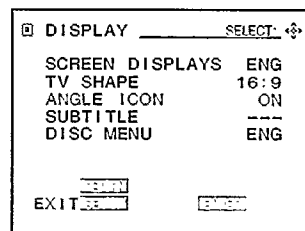

ON: The angle icon automatically appears in white on the TV screen while a scene recorded from multiple angles is played back. When you display the angle number on the screen by pressing the ANGLE button, the angle icon is lit in red.
OFF: The angle icon is not displayed.

When SUBTITLE is selected: DVD

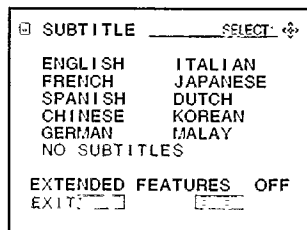

Select a preferred language by pressing **▲/▼/◀/▶**, then press ENTER.

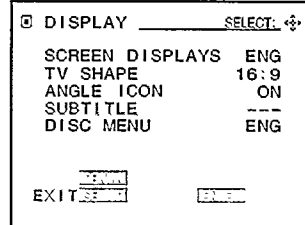
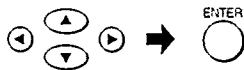

Some DVD video discs contain special subtitles, an enhancement of closed captioning for hearing impaired persons. When you set EXTENDED FEATURES to "ON" by pressing the SUBTITLE button, the DVD video player automatically displays these special subtitles.

• Some DVD video discs may not include your pre-selected language. In this case, the DVD video player automatically displays subtitles consistent with the disc's initial language setting.

When DISC MENU is selected: DVD

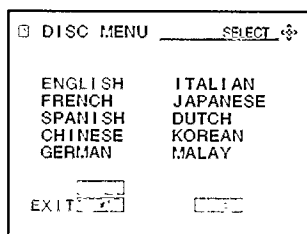

Select a preferred language by pressing **▲/▼/◀/▶**, then press ENTER.

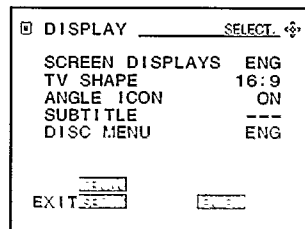

To change the language while a disc is inserted:

- 1) Press the TITLE or MENU button to display the disc menu.
- 2) Press the SETUP button.
If the disc menu has only one language, the display does not appear.
- 3) Press the SETUP button repeatedly to select the language. Refer to "Table of languages." (39)
- 4) Press the ENTER button.
The disc menu is displayed in the selected language.

DISC MENU:ENG

Function Setup

4



Press SETUP.

The setting screen disappears.

Setting the Parental Lock

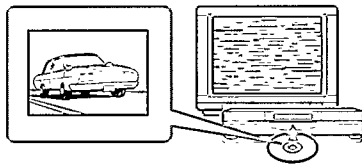

You can use the parental lock function only with DVD video discs equipped with the parental lock feature.

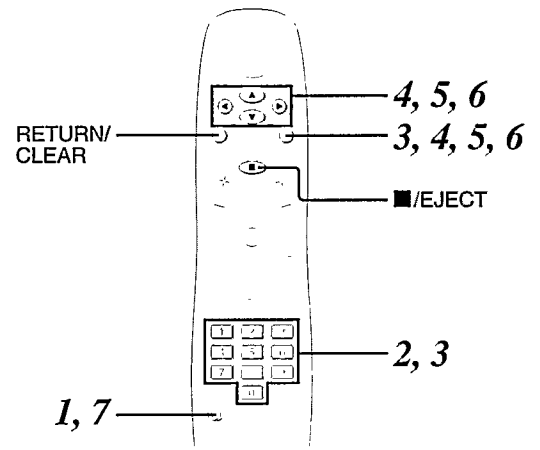

Setting the Parental Lock

DVD video discs equipped with the parental lock function are rated according to their content. The contents allowed by a parental lock level and the way a DVD video disc can be controlled may vary from disc to disc. For example, you can cut out violent scenes unsuitable for children and replace them with more suitable scenes, or lock out playback of the disc altogether.

1 **Press SETUP while playback is stopped.**
The SET UP MENU appears on the TV screen.

2 **Press 9 twice.**
The following menu appears.

PARENTAL LOCK

PRESET SECURITY CODE

PRESS [0] - [9]

EXIT ENTER

3 **Press the number buttons to create a personal four-digit security code, then press ENTER.**
Example

↓

PARENTAL LOCK

PARENTAL LOCK

ON

USA8

If you make a mistake before pressing the ENTER button, press the RETURN/CLEAR button and start over again from step 2.

4 **Press ◀/▶ to select "ON," then press ENTER.**
The following menu appears.

PARENTAL LOCK

COUNTRY

EXIT ENTER

5 **Press ◀/▶ to highlight the country whose standards were used to rate the DVD video disc, then press ENTER.**
The following menu appears.

PARENTAL LOCK

VIEWABLE

LEVEL8

LEVEL7

LEVEL6

LEVEL5

LEVEL4

LEVEL3

LEVEL2

LEVEL1

EXIT

6 **Press ▲/▼ to highlight the parental lock level, then press ENTER.**
You cannot play DVD video discs rated higher than the level you selected unless you cancel the parental lock function. For example, when you select level 7, the discs rated higher than level 7 are locked out and cannot be played.

Example: When you select "USA"

PARENTAL LOCK

VIEWABLE

LEVEL7

LEVEL6

LEVEL5

LEVEL4

LEVEL3

LEVEL2

LEVEL1

EXIT

When you select "CAN," "CAN7" appears instead.

The parental lock level is equivalent to the following USA movie ratings.

- LEVEL 7: NC-17 LEVEL 3: PG
- LEVEL 6: R LEVEL 1: G
- LEVEL 4: PG 13

The parental lock levels for "CAN" (Canada) are included for future use. Check the appropriate parental lock level when you buy a DVD video disc equipped with the parental lock function in the future.

7 **Press SETUP.**
The SET UP MENU disappears.



: If you press the RETURN/CLEAR button while a menu appears on the screen, you will return to the previous menu screen.

To change the parental lock level

You can change the parental lock level by following the steps in "Setting the Parental Lock."

At step 3, press the **number buttons** to enter your four-digit security code, then continue to step 4.

To cancel the parental lock function

- 1 Follow steps 1 and 2 in "Setting the Parental Lock."
- 2 Press the **number buttons** to enter your four-digit security code, then press the **ENTER** button.
- 3 Press **◀/▶** to select "OFF," then press the **ENTER** button.

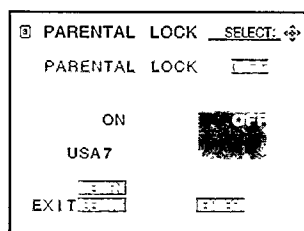

The SET UP MENU appears again.

To change your four-digit security code

You can change your four-digit security code.

- 1 Follow steps 1 and 2 in "Setting the Parental Lock."
- 2 Press the **■/EJECT** button four times while the security code menu appears on the TV screen.

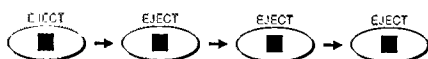

The four-digit security code is cleared.

- 3 Press the **number buttons** to create a new four-digit security code, then press the **ENTER** button.
- 4 Complete steps 4 – 7 in "Setting the Parental Lock."

- 4 Press the **SETUP** button.

The SET UP MENU disappears, and the parental lock function is cancelled.

Note

DVD video discs may or may not respond to the parental lock settings. Make sure this function works with your DVD video discs.

Operating Other Equipment with the Remote Control

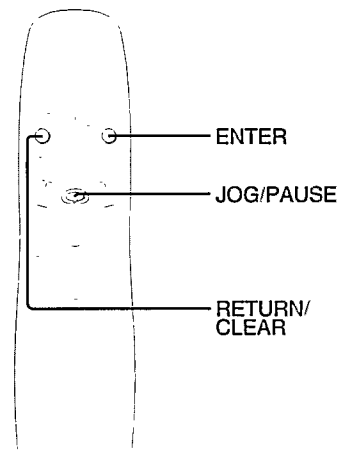
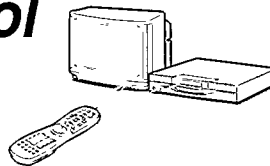

You can operate the basic functions of selected TVs, amplifiers, and receivers using the supplied remote control.

Programming the Remote Control

You can operate other equipment with the DVD video player's remote control.

1 Press and hold RETURN/CLEAR and ENTER simultaneously until JOG/ PAUSE lights up.



2 Release RETURN/CLEAR and ENTER.

3 Press the number buttons that correspond to your equipment's brand code (listed at right).

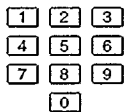

Example: To program brand code 040, press

0 → 4 → 0

When you press the last digit, the JOG/ PAUSE button blinks twice, then turns off.

4 Point the remote control at the equipment you want to operate.

Notes

- The same brand may use different codes depending on the model. Enter the correct number, referring to the brand code table.
- For some brands, several codes are provided. Try each of them until the remote control operates your equipment.
- Some equipment may not respond to all of the functions in the table in the next page, or may not be operated at all with this remote control. In this case, operate that equipment with its own remote control.
- If you replace the remote control's batteries, remember to reprogram the brand code.

Brand Code Table

TV brand code	
Brand name	Brand code
GE	019, 021, 023, 036, 037, 041, 077, 103, 105, 150, 160, 163, 245
Goldstar	002, 003, 017, 024, 026, 032, 042, 072, 105, 227
JVC	029, 039, 047, 092, 098, 109
Magnavox	018, 020, 022, 024, 029, 040, 065, 112, 113, 140, 217
Motorola	041, 062
NEC	017, 024, 029, 042, 099, 246
Panasonic	037, 041, 094, 138, 149, 190, 210
Philips	040
Proscan	036
Proton	004, 025, 036, 105, 249
Quasar	037, 041, 096, 148
RCA	016, 017, 023, 031, 036, 059, 077, 103, 159
Samsung	017, 024, 026, 032, 042, 043, 105, 184, 226, 237, 253
Sanyo	080, 086, 091, 141, 254
Sears	013, 036, 040, 042, 080, 081, 082, 086, 088, 091, 100, 105, 106, 162
Sharp	032, 062, 085, 089, 096, 138, 162, 217, 222, 258
Sony	001, 009, 055, 075
Technics	037, 149
Thomson	127, 128
Toshiba	029, 043, 082, 086, 088
Yamaha	017, 024
Zenith	014, 015

Amplifier brand code	
Brand name	Brand code
Denon	411
Harman/Kardon	405
JVC	425
Magnavox	420
Marantz	420, 424
Philips	420
Pioneer	401, 422
Sony	415
Technics	423, 434
Yamaha	408, 410, 427, 433

Receiver brand code	
Brand name	Brand code
Carver	505, 512, 557, 605, 714
Denon	502, 704
Harman/Kardon	530, 531
Inkel	517, 519
JVC	521, 630
Kenwood	510, 523, 556, 589, 590
Magnavox	538, 557, 559, 562, 589, 607, 645
Marantz	503, 511, 538, 557, 560, 603, 628
Onkyo	528, 535, 539, 542, 610
Optimus	512, 552, 554, 556, 568, 624, 645, 672, 693, 699, 718
Panasonic	511, 612
Philips	557, 677
Pioneer	544, 562, 645, 674
RCA	516, 600, 605, 644, 645, 679
Sansui	557, 558, 594, 600, 661
Sony	545, 549, 620, 632
Technics	511, 564, 588
Yamaha	525, 526, 551, 556, 583, 650, 691

Buttons to operate

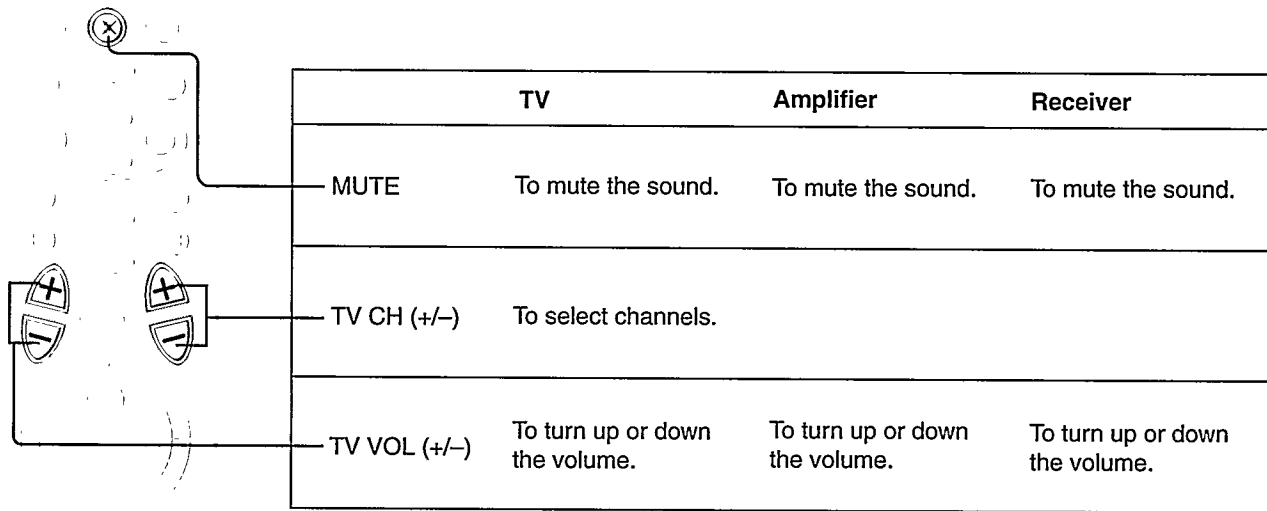

Table of Languages

Table of Languages and Their Abbreviations

Abbreviation of the Language	Language	Abbreviation of the Language	Language	Abbreviation of the Language	Language	Abbreviation of the Language	Language
---	No alternate language	EO	Esperanto	LN	Lingala	SL	Slovenian
CHI	Chinese	ET	Estonian	LO	Laotian	SM	Samoan
DUT	Dutch	EU	Basque	LT	Lithuanian	SN	Shona
ENG	English	FA	Persian	LV	Latvian, Lettish	SO	Somali
FRE	French	FI	Finnish	MG	Malagasy	SQ	Albanian
GER	German	FJ	Fiji	MI	Maori	SR	Serbian
ITA	Italian	FO	Faroese	MK	Macedonian	SS	Siswati
JPN	Japanese	FY	Frisian	ML	Malayalam	ST	Sesotho
KOR	Korean	GA	Irish	MN	Mongolian	SU	Sundanese
MAY	Malay	GD	Scottish Gaelic	MO	Moldavian	SV	Swedish
SPA	Spanish	GL	Galician	MR	Marathi	SW	Swahili
AA	Afar	GN	Guarani	MT	Maltese	TA	Tamil
AB	Abkhazian	GU	Gujarati	MY	Burmese	TE	Telugu
AF	Afrikaans	HA	Hausa	NA	Nauru	TG	Tajik
AM	Amharic	HI	Hindi	NE	Nepali	TH	Thai
AR	Arabic	HR	Croatian	NO	Norwegian	TI	Tigrinya
AS	Assamese	HU	Hungarian	OC	Occitan	TK	Turkmen
AY	Aymara	HY	Armenian	OM	(Afan) Oromo	TL	Tagalog
AZ	Azerbaijani	IA	Interlingua	OR	Oriya	TN	Setswana
BA	Bashkir	IE	Interlingue	PA	Panjabi	TO	Tongan
BE	Belorussian	IK	Inupiak	PL	Polish	TR	Turkish
BG	Bulgarian	IN	Indonesian	PS	Pashto, Pushto	TS	Tsonga
BH	Bihari	IS	Icelandic	PT	Portuguese	TT	Tatar
BI	Bislama	IW	Hebrew	QU	Quechua	TW	Twi
BN	Bengali, Bangla	JI	Yiddish	RM	Rhaeto-Romance	UK	Ukrainian
BO	Tibetan	JW	Javanese	RN	Kirundi	UR	Urdu
BR	Breton	KA	Georgian	RO	Rumanian	UZ	Uzbek
CA	Catalan	KK	Kazakh	RU	Russian	VI	Vietnamese
CO	Corsican	KL	Greenlandic	RW	Kinyarwanda	VO	Volapük
CS	Czech	KM	Cambodian	SA	Sanskrit	WO	Wolof
CY	Welsh	KN	Kannada	SD	Sindhi	XH	Xhosa
DA	Danish	KS	Kashmiri	SG	Sango	YO	Yoruba
DZ	Bhutani	KU	Kurdish	SH	Serbo-Croatian	ZU	Zulu
EL	Greek	KY	Kirghiz	SI	Singhalese		
		LA	Latin	SK	Slovak		

Notes on Discs

This section shows you how to handle, clean, and store discs.

Handling Discs

- Do not touch the playback side of the disc.

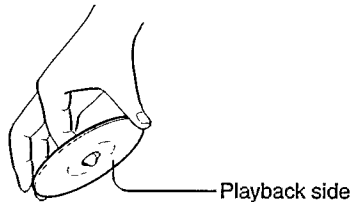

- Do not attach paper or tape to discs.

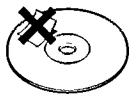

Cleaning Discs

- Fingerprints and dust on the disc cause picture and sound deterioration. Wipe the disc from the center outward with a soft cloth. Always keep the disc clean.

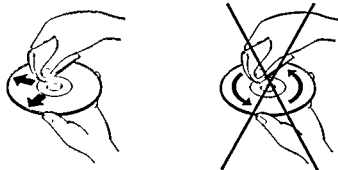

- If you cannot wipe off the dust with a soft cloth, wipe the disc lightly with a slightly moistened soft cloth, then dry the disc with a dry cloth.
- Do not use any type of solvent such as thinner, benzine, commercially available cleaners, or antistatic spray for vinyl LPs. These may damage the disc.

Storing Discs

- Do not store discs in a place subject to direct sunlight or heat.
- Do not store discs in places subject to moisture and dust, such as in a bathroom or near a humidifier.
- Store discs vertically in a case. Stacking or placing objects on discs may cause warping.

About This Owner's Manual

This owner's manual explains the basic instructions of this DVD video player. Some DVD video discs are produced in a manner that allows specific or limited operation during playback. As such, the DVD video player may not respond to all operating commands. Refer to the instruction notes of discs.

"I" may appear on the TV screen during operation. A white "I" means that the operation is not permitted by the DVD video player; a red "I" means the operation is not permitted by the DVD video disc.

Playable Discs

This DVD video player can play the following discs.

	Disc mark	Contents	Disc size	Maximum playback time
DVD video discs		Audio + Video (moving pictures)	12 cm	Approx. 4 hours (single sided disc) Approx. 8 hours (double sided disc)
			8 cm	Approx. 80 minutes (single sided disc) Approx. 160 minutes (double sided disc)
VIDEO CDs		Audio + Video (moving pictures)	12 cm	Approx. 74 minutes
			8 cm	Approx. 20 minutes
Audio CDs		Audio	12 cm	Approx. 74 minutes
			8 cm (CD single)	Approx. 20 minutes

You cannot play discs other than those listed above.

This DVD video player uses the NTSC color system and cannot play DVD video discs recorded in any other color system (PAL, SECAM, etc.).

Notes on Region Numbers

The region number of this DVD video player is 1. If region numbers, which stand for their playable area, are printed on your DVD video disc and you do not find or , disc playback will not be allowed by the player. (In this case, the DVD video player displays a message.)

Notes on Copyright

It is forbidden by law to copy, broadcast, show, broadcast on cable, play in public, and rent copyrighted material without permission.

DVD video discs are copy protected, and any recordings made from these discs will be distorted.

This product incorporates copyright protection technology that is protected by method claims of certain U.S. patents and other intellectual property rights owned by Macrovision Corporation and other rights owners. Use of this copyright protection technology must be authorized by Macrovision Corporation, and is intended for home and other limited viewing uses only unless otherwise authorized by Macrovision Corporation. Reverse engineering or disassembly is prohibited.

Before Calling Service Personnel

Check the following guide for the possible cause of a problem before requesting service.

Symptoms and Correction

Symptom	Cause	Correction	Page
No power.	The power plug is disconnected.	Connect the power plug into the wall outlet securely.	11, 12
No picture.	• The TV is not set to receive DVD signal output.	• Select the appropriate video input mode on the TV so the picture from the DVD video player appears on the TV screen.	15
	• The video cable is not connected securely.	• Connect the video cable into the jacks securely.	11, 12, 13, 14
No sound.	• The equipment connected with the audio cable is not set to receive DVD signal output.	• Select the correct input mode of the audio receiver so you can listen to the sound from the DVD video player.	15
	• The audio cables are not connected securely.	• Connect the audio cable to the jacks securely.	11, 12, 13, 14
	• The power of the equipment connected with the audio cable is turned off.	• Turn on the equipment connected with the audio cable.	–
	• The setting of output sound type is not correct.	• Set the audio setting correctly.	28, 29
The playback picture has occasional distortion.	• The disc is dirty.	• Eject the disc and clean it.	40
	• It is in fast forward or fast reverse playback.	• Sometimes a small amount of picture distortion may appear. This is not a malfunction.	–
Brightness is unstable or noises are produced on playback pictures.	• The copy protection is in effect.	• Connect the DVD video player to the TV directly.	11
The DVD video player does not start playback.	• No disc is inserted.	• Insert a disc. (Check that the DVD or VCD or audio CD indicator in the DVD display is lit.)	8
	• An unplayable disc is inserted.	• Insert a playable disc. (Check the disc type and color system.)	40
	• The disc is placed upside down.	• Place the disc with the playback side down (label facing up).	15
	• The disc is not placed within the guide.	• Place the disc correctly inside the guide in the disc tray.	15
	• The disc is dirty.	• Clean the disc.	40
	• A menu is on the TV screen.	• Press the SETUP button to turn off the menu screen.	–
	• The parental lock function is set.	• Cancel the parental lock function or change the parental lock level.	35, 36
Buttons do not work.	Power supply fluctuations or other abnormalities such as static electricity may interrupt correct operations.	Turn the power on or off with the POWER button. Or, disconnect the power plug and insert it into the wall outlet again.	–
The remote control does not work properly.	• The remote control is not pointed at the remote sensor of the DVD video player.	• Point the remote control at the remote sensor of the DVD video player.	10
	• The remote control is too far from the DVD video player.	• Operate the remote control within about 20 feet.	10
	• The batteries in the remote control are exhausted.	• Replace the batteries with new ones.	10

Specifications

DVD Video Player/Outputs/Supplied Accessories

[DVD Video Player]

Power supply	120 V AC, 60 Hz
Power consumption	20 W
Mass	3.5 kg
External dimensions	430 × 81 × 308 mm (W/H/D)
Signal system	Standard NTSC
Laser	Semiconductor laser, wavelength 650 nm
Frequency range (digital audio)	DVD linear sound : 48 kHz sampling 4 Hz to 22 kHz 96 kHz sampling 4 Hz to 44 kHz Audio CD : 4 Hz to 20 kHz
Signal-to-noise ratio (digital audio)	More than 108 dB
Audio dynamic range (digital audio)	More than 96 dB
Harmonic distortion (digital audio)	Less than 0.004 %
Wow and flutter	Below measurable level (less than ±0.001 % (W.PEAK))
Operating conditions	Temperature: 5° C to 35° C, Operation status: Horizontal

[Outputs]

Video output	1.0 V (p-p), 75 Ω, negative sync., pin jack × 1
S video output	(Y) 1.0 V (p-p), 75 Ω, negative sync., Mini DIN 4-pin × 1 (C) 0.286 V (p-p), 75 Ω
Audio output (digital audio)	0.5 V (p-p), 75 Ω, pin jack × 1
Audio output (analog audio)	2.0 V (rms), 330 Ω, pin jack (L, R) × 2
Headphone terminal	32 Ω (30mW), Impedance: more than 8 Ω

[Supplied Accessories]

S video cable	1
Audio/video cable	1
Remote control	1
Batteries (AA)	3

- Designs and specifications are subject to change without notice.

Memo

■ Discs and output sounds

Sound recording system	DVD video discs					VIDEO CDs	Audio CDs
	Dolby Digital		Linear PCM			MPEG 1	Linear PCM 44.1 kHz
			48 kHz	96 kHz			
Audio setting on the setting screen [28] [29]	AC-3	PCM	AC-3 or PCM	AC-3	PCM	AC-3 or PCM	AC-3 or PCM
ANALOG AUDIO OUT jacks	—	○	○	○*	○**	○	○
DIGITAL AUDIO OUT jack	Dolby Digital bitstream	PCM (48 kHz)	PCM (48 kHz)	PCM (48 kHz)	—	PCM (44.1 kHz)	PCM (44.1 kHz)

* : 48 kHz processed

** : 96 kHz processed

■ On VIDEO CD

This DVD video player supports the VIDEO CDs equipped with the PBC (Version 2.0) function. (PBC is the abbreviation of Playback Control.)

You can enjoy two playback variations depending on types of discs.

Type of disc	How to enjoy
VIDEO CD not equipped with PBC function (Version 1.1)	Sound and movie can be played on this DVD video player in the same way as an audio CD.
VIDEO CD equipped with PBC function (Version 2.0)	In addition to operations of a VIDEO CD not equipped with the PBC function, you can enjoy playback with interactive software and with search function by using the menu displayed on the TV screen (Menu Playback). Some of the functions described in this owner's manual may not work with some discs.

Others

Memo

Memo

Philips Consumer Electronics Company Factory Service Center Locations

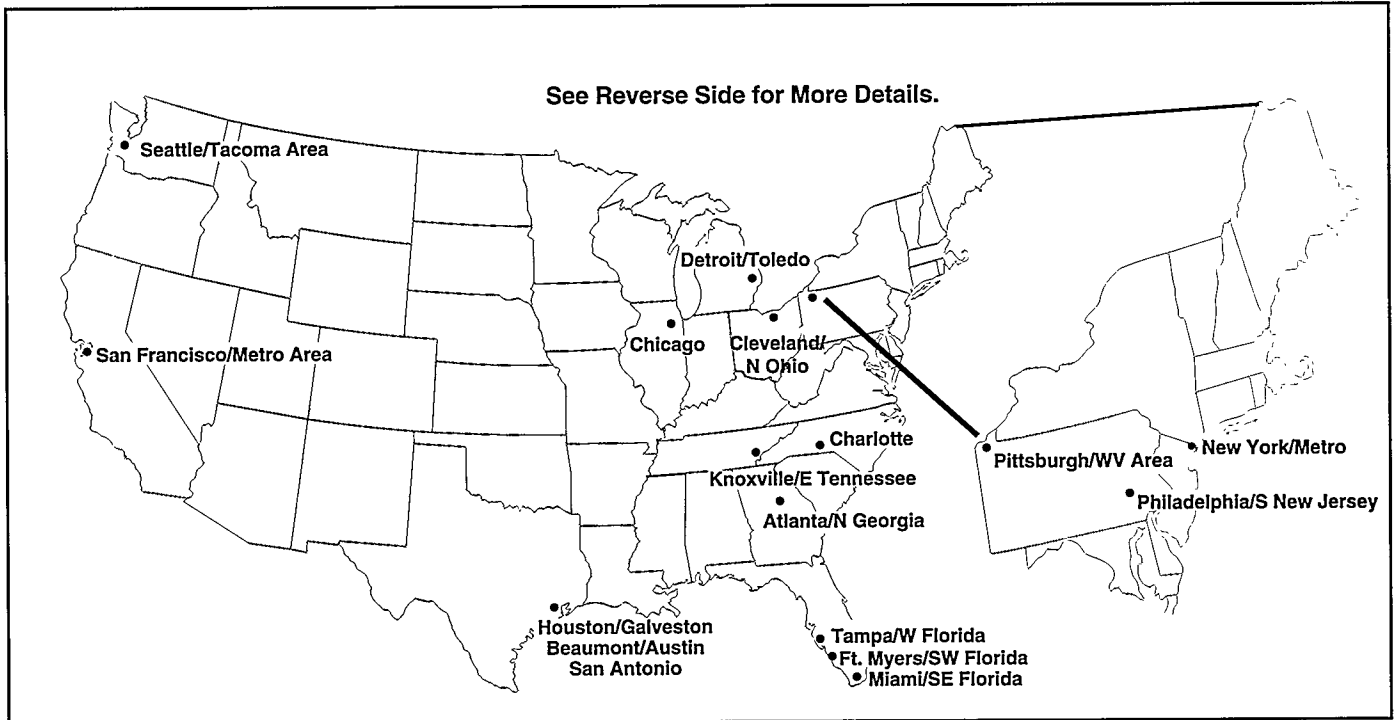

NOTE: If you reside in one of our Philips Factory Service Branch areas (see directory on back), you can contact the nearest Service Branch to obtain efficient and expedient repair for your product. If your product is In-Warranty, you should have proof-of-purchase to ensure No Charge Service. For Out-of-Warranty service, call the location nearest you.

NOTA: Si vous résidez dans une des régions desservies par une succursale de service après vente du fabricant Philips (voir liste ci-dessous), vous pourrez contacter la branche de service après vente la plus près de chez vous pour obtenir un service après vente rapide et efficace. Si le produit est sous garantie, il suffira de présenter une preuve d'achat pour bénéficier d'un service sans frais. Pour les produits non couverts par la garantie, contactez le centre le plus près de chez vous.

NOTA: Si Ud. reside en una de nuestras zonas para sucursales Philips de servicio al de fábrica (ver directorio más abajo), Ud. puede comunicarse con la sucursal de servicio más cercana para obtener una reparación oportuna y eficaz de su producto. Si su producto está todavía bajo garantía, Ud. debe presentar comprobante de compra para no ocasionar ningunos cargos por servicio. Para servicio después del vencimiento de la garantía, llame al lugar más cercano de los abajo indicados.

In Canada

How you can obtain efficient and expedient carry-in, mail-in, or in-home service for your product

Please contact Philips at
1-800-661-6162 (French speaking)
1-800-363-7278 (English speaking)

Au Canada

Comment obtenir le service après-vente pour les produits apportés ou envoyés par la poste à notre centre de service ou le service à domicile

Veillez contacter philips à:
1-800-661-6162 (Francophone)
1-800-363-7278

En el Canadá

Cómo recibir servicio eficiente para su producto, en persona, por correo o a domicilio

Favor de comunicarse con Philips al:
1-800-661-6162 (francófono)
1-800-363-7278 (anglófono)

QUALITY SERVICE IS AS CLOSE AS YOUR TELEPHONE! SIMPLY LOOK OVER THE LIST BELOW FOR THE NUMBER OF A FACTORY SERVICE CENTER NEAR YOU. YOUR PRODUCT WILL RECEIVE EFFICIENT AND EXPEDIENT CARRY-IN, MAIL-IN, OR IN-HOME SERVICE, AND YOU WILL RECEIVE PEACE OF MIND, KNOWING YOUR PRODUCT IS BEING GIVEN THE EXPERT ATTENTION OF PHILIPS' FACTORY SERVICE. AND, IF THE PHONE NUMBER LISTED FOR YOUR AREA IS LONG DISTANCE, CALL 1-800-242-9225 FOR FACTORY SERVICE.

COMMENT OBTENIR NOTRE SERVICE APRÈS VENTE RAPIDE ET EFFICACE SOIT PAR COURRIER, À DOMICILE, OU EN SE PRÉSENTANT À UN CENTRE DE SERVICE PHILIPS. PLUS DE 600 CENTRES DE RÉCEPTION DE PRODUITS À RÉPARER À TRAVERS LE PAYS: CONTACTER LE CENTRE DE SERVICE AUX CONSOMMATEURS LE PLUS PROCHE POUR SAVOIR L'EMPLACEMENT DE CES DÉPÔTS DANS UN RAYON DE 50 À 75 MILES (80 KM À 120 KM) DU CENTRE DE SERVICE LOCAL.

CÓMO OBTENER UN SERVICIO OPORTUNO Y EFICIENTE POR CORREO, EN CASA O EN PERSONA PARA SU PRODUCTO A TRAVÉS DE UN CENTRO PHILIPS DE SERVICIO. MAS DE 600 SITIOS POR TODO EL PAIS PARA LA RECEPCION DE PRODUCTOS NECESITADOS DE REPARACIONES: COMUNICARSE CON EL CENTRO DE SERVICIO DE FABRICA MAS CERCANO PARA ESTOS LUGARES DENTRO DE UN RADIO DE 80 A 120 KM (50 A 75 MILLAS) DEL CENTRO DE SERVICIO LOCAL.

**Atlanta–Athens–Macon–Chattanooga,
TN–North Georgia Area**

200 North Cobb Parkway
Building 100, Suite 120
Marietta, GA 30062
(770) 795-0085

**Charlotte–Winston Salem–
Greensboro**

520-G Clanton Road
Charlotte, NC 28217
(704) 529-6330

Chicago–Gary Area

1360 W. Hamilton Parkway
Itasca, IL 60143
(630) 775-0990

Cleveland–Akron–Youngstown Area

950 Keynote Circle
Brooklyn Heights, OH 44131
(216) 741-3334

Detroit/Toledo Area

25173 Dequindre
Madison Heights, MI 48071
(810) 544-2110

**Knoxville–Greeneville–
Tri Cities–East Tennessee Area**

6700 D. Papermill Road
Papermill Plaza
Knoxville, TN 37919
(423) 584-6614

**Ft. Myers–Naples–
Southwest Florida Area**

11601 Cleveland Ave., Suite 15
Ft. Myers, FL 33907
(941) 278-4242

**Houston–Galveston–Beaumont–Austin–
San Antonio Area**

1110 North Post Oak Road
Suite 100
Houston, TX 77055
(713) 682-3990

Miami–Southeast Florida Area

2099 W. Atlantic Blvd.
Pompano Beach, FL 33069
(954) 978-0467

New York Metro Area

116 Charlotte Avenue
Hicksville, NY 11801
(516) 933-1780 Nassau County

Philadelphia/S. New Jersey Area

352 Dunks Ferry Road
Bensalem, PA 19020
(215) 638-7500

**Pittsburgh, PA–Steubenville, OH–
Wheeling/Morgantown, WV Area**

2891 Banksville Road
Pittsburgh, PA 15216
(412) 563-8020

San Francisco–Oakland–San Jose Area

681 East Brokaw Rd.
San Jose, CA 95131
(408) 436-8566

Seattle–Tacoma/Olympia Area

1055 Andover Park East
Tukwila, WA 98188
(206) 575-6288

Tampa–St. Petersburg–Sarasota Area

Center Point Business Park, Building B-1,
Suite 100
1911 U.S. Hwy. 301 North
Tampa, FL 33619
(813) 621-8181

LIMITED WARRANTY

DVD VIDEO PLAYER

90 Days Free Labor

One Year Exchange Warranty on Parts

This product must be carried in for repair.

WHO IS COVERED?

You must have proof of purchase to receive warranty service. A sales receipt or other document showing that you purchased the product is considered proof of purchase.

WHAT IS COVERED?

Warranty coverage begins the day you buy your product. For 90 days thereafter, all parts will be repaired or replaced, and labor is free. From 90 days to one year from the day of purchase, all parts will be repaired or replaced, but you pay for all labor charges. After one year from the day of purchase, you pay for the replacement or repair of all parts, and for all labor charges.

All parts, including repaired and replaced parts, are covered only for the original warranty period. When the warranty on the product expires, the warranty on all replaced and repaired parts also expires.

WHAT IS EXCLUDED?

Your warranty does not cover:

- labor charges for installation or setup of the product, adjustment of customer controls on the product, and installation or repair of antenna systems outside of the product.
- product repair and/or part replacement because of misuse, accident, unauthorized repair or other cause not within the control of Philips Consumer Electronics Company.
- reception problems caused by signal conditions or cable or antenna systems outside the unit.
- a product that requires modification or adaptation to enable it to operate in any country other than the country for which it was designed, manufactured, approved and/or authorized, or repair of products damaged by these modifications.
- incidental or consequential damages resulting from the product. (Some states do not allow the exclusion of incidental or consequential damages, so the above exclusion may not apply to you. This includes, but is not limited to, prerecorded material, whether copyrighted or not copyrighted.)
- a product that is used for commercial or institutional purposes (including but not limited to rental purposes).

WHERE IS SERVICE AVAILABLE?

Warranty service is available in all countries where the product is officially distributed by Philips Consumer Electronics Company. In countries where Philips Consumer Electronics Company does not distribute the product, the local Philips service organization will attempt to provide service (although there may be a delay if the appropriate spare parts and technical manual(s) are not readily available).

MAKE SURE YOU KEEP...

Please keep your sales receipt or other document showing proof of purchase. Attach it to this owner's manual and keep both nearby. Also keep the original box and packing material in case you need to return your product.

BEFORE REQUESTING SERVICE...

Please check your owner's manual before requesting service. Adjustments of the controls discussed there may save you a service call.

TO GET WARRANTY SERVICE IN U.S.A., PUERTO RICO OR U.S. VIRGIN ISLANDS...

Take the product to a Philips factory service center (see enclosed list) or authorized service center for repair. When the product has been repaired, you must pick up the unit at the center. Centers may keep defective parts.

(In U.S.A., Puerto Rico and U.S. Virgin Islands, all implied warranties, including implied warranties of merchantability and fitness for a particular purpose, are limited in duration to the duration of this express warranty. Because some states do not allow limitations on how long an implied warranty may last, this limitation may not apply to you.)

TO GET WARRANTY SERVICE IN CANADA...

Please contact Philips at:

1-800-661-6162 (French Speaking)

1-800-363-7278 (English Speaking)

(In Canada, this warranty is given in lieu of all other warranties. No other warranties are expressed or implied, including any implied warranties of merchantability or fitness for a particular purpose. Philips is not liable under any circumstances for any direct, indirect, special, incidental or consequential damages, howsoever incurred, even if notified of the possibility of such damages.)

REMEMBER...

Please record the model and serial numbers found on the product below. Also, please fill out and mail your warranty registration card promptly. It will be easier for us to notify you if necessary.

MODEL # _____
SERIAL # _____

This warranty gives you specific legal rights. You may have other rights which vary from state/province to state/province.

Philips Service Company, P.O. Box 555, Jefferson City, Tennessee 37760, (423) 475-8869

Free Manuals Download Website

<http://myh66.com>

<http://usermanuals.us>

<http://www.somanuals.com>

<http://www.4manuals.cc>

<http://www.manual-lib.com>

<http://www.404manual.com>

<http://www.luxmanual.com>

<http://aubethermostatmanual.com>

Golf course search by state

<http://golfingnear.com>

Email search by domain

<http://emailbydomain.com>

Auto manuals search

<http://auto.somanuals.com>

TV manuals search

<http://tv.somanuals.com>