

DVD Video Player  
Owner's Manual



*Let's make things better.*



**PHILIPS**



## Important Note

### DK

#### Advarsel:

Laserrudstråling ved åbning når sikkerhesafbrydere er ude af funktion. Undgå u tsættelse for stråling.

#### Bemærk:

Netafbryderen POWER er sekundært indkoblet og afbryder ikke strømmen fra nettet. Den indbyggede neddel er derfor tilsluttet til lysnettet så længe netstikket sidder i stikkontakten.

### N

#### Observer:

Nettbryteren POWER er sekundært innkoplet. Den innebyggenetdelen er derfor ikke frakoplet nettet så lenge apparatet er tilsluttet nettkontakten.

### S

Klass 1 laserapparat

#### Varning!

Om apparaten används på annat sätt än i denna bruksanvisning specificerats, kann användaren utsättas för laserstråling, som översjrunder gränsen för läserklass 1.

#### Observera!

Strömbrytaren POWER är sekundärt kopplad och inte bryter strömmen från nätet. Den inbyggda nättdelen är därför ansluten till elnätet så länge stickproppen sitter i v ägguttaget.

### SF

Luokan 1 laserlaite + Klass 1 laserapparat

#### Varoituis!

Laitteen käyttäminen muulla kuin tässä käyttöohjeessa mainitulla tavalla saattaa altistaa käyttäjän turvallisuusluokan 1 ylittävälle lasersäteilille.

#### Huom.

Toiminnanvalitsin POWER on kytketty toisiopuolelle, eikä se kytke laitetta irti sähköverkosta. Sisäänrakennettu verkko-osa on kytkettynä sähköverkkoon aina silloin, kun pistoke on pistorasiassa.

## Important Note for Users in the UK

### Mains plug

This apparatus is fitted with an approved 13 Amp plug. To change a fuse in this type of plug proceed as follows:

- 1 Remove fuse cover and fuse.
- 2 Fix new fuse which should be a BS1362 5 Amp, A.S.T.A. or BSI approved type.
- 3 Refit the fuse cover.

If the fitted plug is not suitable for your socket outlets, it should be cut off and an appropriate plug fitted in its place.

If the mains plug contains a fuse, this should have a value of 5 Amp. If a plug without a fuse is used, the fuse at the distribution board should not be greater than 5 Amp.

*Note: The severed plug must be disposed of to avoid a possible shock hazard should it be inserted into a 13 Amp socket elsewhere.*

### How to connect a plug

The wires in the mains lead are coloured with the following code: blue = neutral (N), brown = live (L).

As these colours may not correspond with the colour markings identifying the terminals in your plug, proceed as follows:

- Connect the blue wire to the terminal marked N or coloured black.
- Connect the brown wire to the terminal marked L or coloured red.
- Do not connect either wire to the earth terminal in the plug, marked E (or e) or coloured green (or green and yellow).

Before replacing the plug cover, make certain that the cord grip is clamped over the sheath of the lead - not simply over the two wires.

### Copyright in the U.K.

**Recording and playback of material may require consent. See Copyright Act 1956 and The Performer's Protection Acts 1958 to 1972.**





**CAUTION**  
 VISIBLE AND INVISIBLE LASER RADIATION  
 WHEN OPEN.  
 AVOID EXPOSURE TO BEAM.

**ADVARSEL**  
 SYNLLIG OG USYNLLIG LASERSTRÅLING VED  
 ÅBNING UNDGÅ UDSÆTTELSE FOR  
 STRÅLING

**WARNING s**  
 SYNLLIG OCH OSYNLLIG LASERSTRÅLNING  
 NÅR DENNA DEL ÄR ÖPPNAD BETRAKTA  
 EJ STRÅLEN

**VARO!**  
 AVATTAESSA OLET ALTTIINA NÄKYVÄLLE  
 JA NÄKYMÄTTÖMÄLLE LASER SÄTEILYLLE.  
 ÄLÄ KATSO SÄTEESEEN

**VORSICHT**  
 GEFÄHR VON SICHTBARER UND  
 UNSICHTBARER LASERSTRAHLUNG BEI  
 GEÖFFNETEM GEHÄUSE.

**ATTENTION**  
 RAYONNEMENT LASER VISIBLE ET  
 INVISIBLE EN CAS D'OUVERTURE  
 EXPOSITION DANGEREUSE AU FAISCEAU

English.....	5	<b>English</b>
Italiano.....	29	<b>Italiano</b>
Español.....	56	<b>Español</b>
Svenska.....	82	<b>Svenska</b>
Dansk.....	109	<b>Dansk</b>
Suomi.....	134	<b>Suomi</b>
Português.....	160	<b>Português</b>
Norge.....	185	<b>Norge</b>
Polski.....	210	<b>Polski</b>
Ελληνικά.....	237	<b>Ελληνικά</b>
TÜRKÇE.....	265	<b>TÜRKÇE</b>
Français.....	292	<b>Français</b>
Deutsch.....	319	<b>Deutsch</b>
Language code .....	348	<b>Deutsch</b>





# General Information

English

Since it is usual for DVD movies to be released at different times in different regions of the world, all players have region codes and discs can have an optional region code. If you load a disc of a different region code to your player; you will see the region code notice on the screen. The disc will not playback, and should be unloaded.



*Manufactured under license from Dolby Laboratories. "Dolby" and the double-D symbol are trademarks of Dolby Laboratories.*

**CAUTION  
(WARNING LOCATION: ON THE  
BACKPLATE OF SET)**

**NEVER MAKE OR CHANGE  
CONNECTIONS WITH THE POWER  
SWITCHED ON.**

For Customer Use:  
  
Read carefully the information located at the rear panel of your DVD VIDEO player and enter below the Serial No. Retain this information for future reference.  
  
Model No. DVD VIDEO  
Serial No. \_\_\_\_\_

## Laser safety

This unit employs a laser. Due to the risk of eye injury, only a qualified service person should remove the cover or attempt to service this device.

**USE OF CONTROLS OR  
ADJUSTMENTS OR PERFORMANCE OF  
PROCEDURES OTHER THAN THOSE  
SPECIFIED HEREIN MAY RESULT IN  
HAZARDOUS RADIATION EXPOSURE.**

LASER	
Type	Semiconductor laser GaAlAs
Wave length	650 nm (DVD) 780 nm (VCD/CD)
Output Power	7 mW (DVD) 10 mW (VCD/CD)
Beam divergence	60 degree

**CAUTION**  
VISIBLE AND INVISIBLE LASER RADIATION  
WHEN OPEN.  
AVOID EXPOSURE TO BEAM.

*Important Note:*  
*Due to the numerous versions of new CD-Audio copy protection or enhanced CD-Audio protection recently available on certain discs, Philips is unable to guarantee that this DVD player is fully compatible with such new discs. Should you have difficulty playing any such CD-Audio discs, kindly refer them to your CD-Audio disc retailer.*



## Introduction

Environmental Information .....	6
Supplied accessories .....	6
Safety Information .....	6
Symbols Used in this Booklet .....	6

## Functional overview

Front and Rear Panel .....	7
Remote Control .....	8

## Preparation

Basic Connection .....	9
Connecting to a TV .....	9
Connecting to Optional Equipment .....	10
Connecting to a Audio System .....	10
Inserting batteries into the Remote Control ..	11
Using the Remote Control .....	11
Switching On .....	11
Smart Power On/Off.....	11

## Operation

<b>Basic Playback .....</b>	<b>12</b>
<b>General Operation .....</b>	<b>12</b>
Video control during playback .....	12
Audio control during playback .....	12
Repeat .....	13
Repeat A-B .....	13
5 disc Resume .....	13
OSD (On-Screen Display).....	13
Zoom .....	13
<b>Special DVD Features .....</b>	<b>14</b>
Playing a Title .....	14
Playing a Chapter .....	14
Camera Angle .....	14
Changing the Audio Language .....	14
Subtitles .....	14
<b>Special VCD &amp; SVCD Features .....</b>	<b>14-15</b>
Playback Control (PBC) .....	14
Preview Function .....	15

## Picture CD & MP3 CD Playback

<b>General Operation.....</b>	<b>16</b>
MP3 & JPEG Navigator.....	16
Play Mode.....	16
<b>Special JPEG Features.....</b>	<b>17</b>
Function Introduction.....	17
Preview Function.....	17
Zoom picture .....	17
Playback with multi-angles .....	17
Scan Effect.....	17
<b>Special MP3 Features.....</b>	<b>17</b>
Function Introduction.....	17
Playback Speed Control .....	17
<b>JPEG and MP3 Simultaneous Playback....</b>	<b>17</b>

## Setup menu

<b>Basic operation .....</b>	<b>19</b>
<b>General Setup menu .....</b>	<b>19</b>
OSD language .....	19
Program .....	19-20
Disc Lock .....	20
Display DIM.....	20
Screen Saver .....	20
<b>Analog Audio Setup menu .....</b>	<b>21</b>
DOWNMIX.....	21
D.R.C .....	21
<b>Digital Audio Setup menu.....</b>	<b>21</b>
Digital Output.....	22
LPCM Output.....	22
<b>Video Setup menu....</b>	<b>22</b>
TV Type .....	23
TV Display .....	23
<b>Smart Picture .....</b>	<b>24</b>
Color Setting.....	24-25
<b>Preference Setup menu .....</b>	<b>25</b>
Audio language .....	25
Subtitle language .....	26
Disc Menu language .....	26
Password .....	26
Parental Control .....	26
Default Setup.....	26
MP3/JPEG Navigator .....	26

## Specifications

Specifications .....	27
----------------------	----

## Maintenance

Maintenance .....	27
-------------------	----

## Language Code

Language Code.....	28-29
--------------------	-------

## Troubleshooting

Troubleshooting .....	30
-----------------------	----

# Introduction

Thank you for purchasing this Philips DVD player. This Owner's Manual explains the basic operation of this DVD player.

## Environmental Information

All unnecessary packaging has been omitted. We have tried to make the packaging easy to separate into three materials: cardboard (box), polystyrene foam (buffer) and polyethylene (bags, protective foam sheet).

Your DVD player consists of materials which can be recycled and reused if disassembled by a specialized company. Please observe the local regulations regarding the disposal of packaging materials, exhausted batteries and old equipment.

## Supplied accessories

- DVD-Video player
- Remote control with Batteries
- Owner's Manual

## Safety Information





- Before operating the DVD player, check that the operating voltage indicated on the typeplate is identical with the voltage of your local power supply. If not, please consult your dealer.
- Place the DVD player on a flat, hard and stable surface.
- There must be sufficient room in front of the player for the drawer to be opened.
- In a cabinet, allow about 2.5cm (1 inch) of free space all around the player for adequate ventilation.
- Do not expose your player to extremes of temperature or humidity
- If the DVD player is brought directly from a cold to a warm location, or is placed in a very damp room, moisture may condense on the lens of the disc unit inside the DVD player. Should this occur, the DVD player would not operate normally.

Leave the power on for about one hour with no disc in the DVD player until normal playback is possible.

- The mechanical parts of the set contain self-lubricating bearings and must not be oiled or lubricated.
- When the DVD player is switched to Standby mode, it is still consuming some power. To disconnect the system from the power supply completely, remove the AC power plug from the wall socket.

## Symbols Used in this Booklet

The below symbols appear in some headings and notes with the following meanings:

	- Description refers to playback of DVD-video discs
	- Description refers to playback of Video CDs
	- Description refers to playback of Audio CDs
	- Description refers to playback of Super-VCDs

## Helpful Hints!

- **Some discs limit certain functions during playback (eg fast forward is not working at the beginning of certain discs). This is normal behaviour because the disc determines the way in which you can interact with its content.**

# Functional Overview

English

## Front and Rear Panels

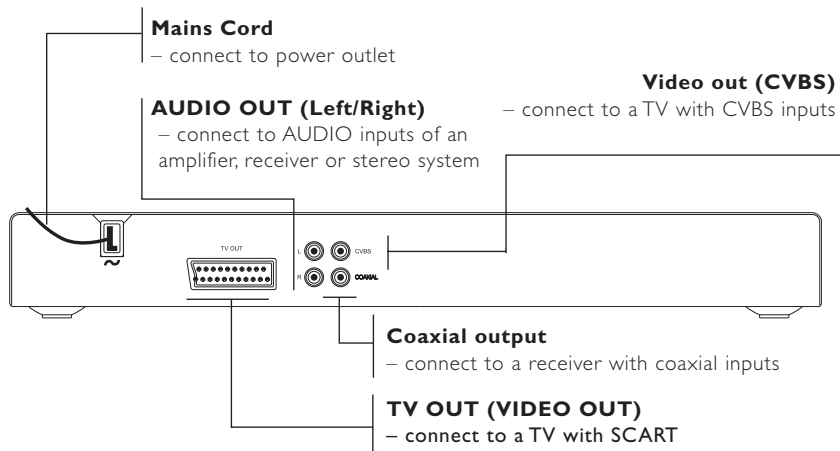
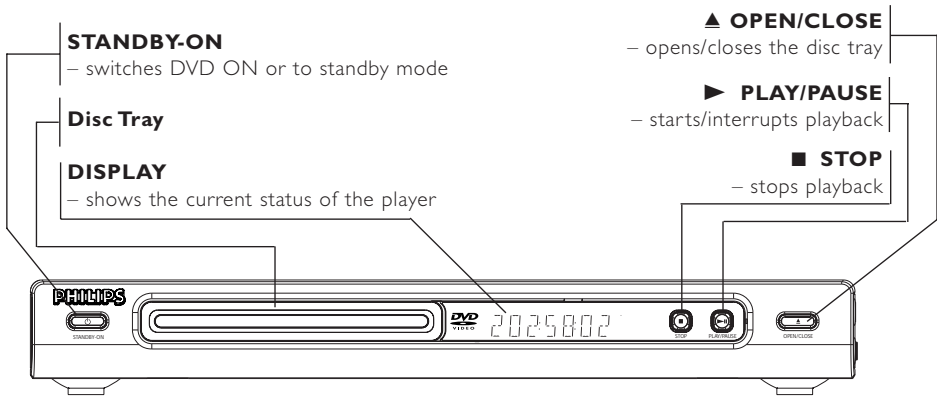

**Caution: Do not touch the inner pins of the sockets on the rear panel. Electrostatic discharge may cause permanent damage to the unit.**

# Functional Overview

## Remote Control

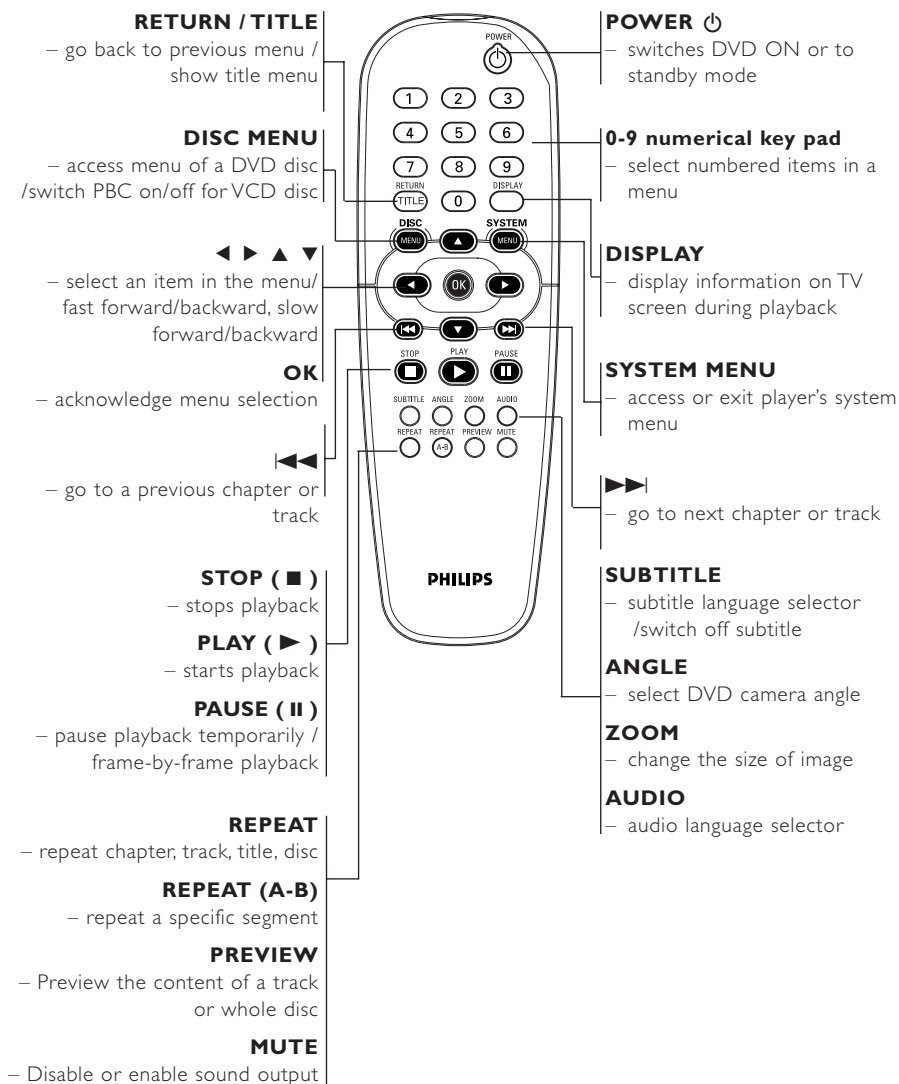

**Note:**

Press "STOP" for about 2 seconds to OPEN or CLOSE disc tray.



## Basic Connections

- Please refer to the instruction manuals of your TV, VCR, Stereo System or other devices as necessary to make the best connections.
- Make one of the following connections, depending on the capabilities of your existing equipment.

The following guidelines are options for the best picture and sound quality available on your DVD player.

### Picture

- 1 Use the CVBS Video Output for good picture quality.
- 2 Use SCART Output for best picture quality.

### Sound

- 1 Digital audio connections provide the clearest sound. Connect the DVD player's DIGITAL AUDIO OUT (COAXIAL) to your amplifier or receiver.
- 2 If digital connections are not possible, connect the DVD player's Left and Right (white and red) AUDIO OUT to your amplifier, receiver, stereo or TV.

### Warning!

- **Never make or change connections with the power switched on.**
- **Connect the DVD player directly to your TV, instead of eg. a VCR, to avoid distortion because DVD video discs are copy protected.**
- **Do not connect the DVD player AUDIO OUT to PHONO IN of your amplifier or receiver.**

## Connecting to a TV

- 1 Connect the SCART (TV OUT) on the DVD player to the corresponding connector (TV IN) on your TV

If your TV is not equipped with a SCART input, you can select the following connection:

### If your TV has a CVBS Video input connector,

- 1 Connect the CVBS VIDEO OUT on the DVD player to the CVBS VIDEO IN.
- 2 Connect the Left and Right AUDIO OUT on the DVD player to the Left and Right AUDIO IN on the TV.

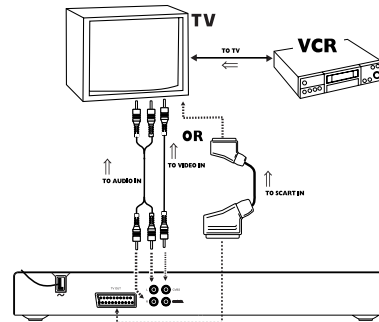

## Connecting to an Audio System

- 1 You can also listen to the sound of audio CDs and DVD video discs by connecting to an optional stereo system.
- 2 Connect the Left and Right AUDIO OUT on the DVD player to the Left and Right AUDIO IN on the stereo system.

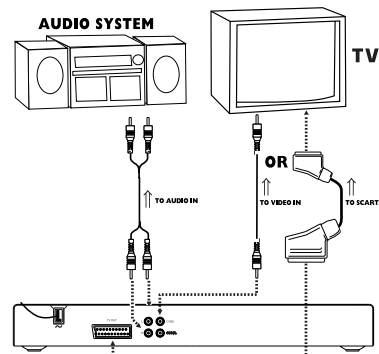

## Preparation

### Connecting to Optional Equipment

- A digital component with a built-in MPEG 2 or Dolby Digital™ decoder allows you to enjoy the surround sound while producing the effect of being in a movie theater or a concert hall.
- The player outputs the surround sound signals from the DIGITAL OUT COAXIAL connectors.

#### If your receiver has a MPEG 2 or Dolby Digital™ decoder,

- 1 Connect the *COAXIAL DIGITAL AUDIO OUT* of the DVD player to the *COAXIAL DIGITAL AUDIO IN* on your receiver.

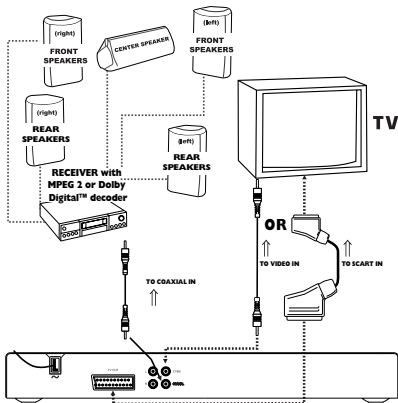

#### Notes:

- If the audio format of the digital output does not match the capabilities of your receiver, The receiver will produce a distorted sound or no sound at all.
- To see the selected audio format of the current DVD in the Setup Menu, refer to "Setup Menu".

### Inserting batteries into the Remote Control

- 1 Open the battery cover by pressing in the tab, then lift off the cover.
- 2 Insert batteries with the correct polarity as indicated by the + and - symbols inside the battery compartment.
- 3 Close the cover.

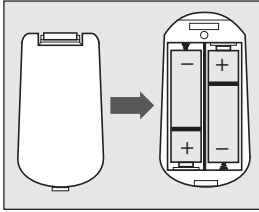

#### CAUTION!

- **Remove batteries if they are exhausted or not to be used for a long time.**
- **Do not use old and new or different types of batteries in combination.**
- **Batteries contain chemical substances, so they should be disposed off properly and kept away from children.**

### Using the Remote Control

- Direct the remote control at the remote sensor of the DVD player.
- Do not drop or give the remote control a shock.
- Do not leave the remote control in extremely hot or humid places.
- Do not spill water or put anything wet on the remote control.

### Switching On

- 1 Be sure that the DVD player has been correctly connected to the TV and audio equipment.
- 2 Switch on the TV and DVD player.
- 3 Set the TV to the correct Video In channel. (eg. EXT1, EXT2, AV1, AV2, AUDIO/VIDEO, etc. Please refer to your TV owner's manual for details.)
  - The player display lights and the default screen appears on the TV.
- 4 If you are using an external equipment (eg. audio system or receiver), turn it on and select the appropriate input source for the DVD player output. Refer to the equipment owner's manual for detail.

### Smart Power On/Off

When in STOP or NO DISC mode, the DVD player will switch to standby mode after 15 minutes without any operations for saving energy. It is easily reactivated by pressing the POWER or PLAY key on the remote control or the STANDBY-ON button on the front panel.

# Operation

## Basic Playback

- 1 Press STANDBY-ON on the front panel to turn on the DVD player.
- 2 Press OPEN/CLOSE on the front panel to open disc loading tray.
- 3 Place the chosen disc in the tray, with the label facing up.
- 4 Press OPEN/CLOSE again to close the tray.  
→ After recognizing the disc, the player begins to playback automatically

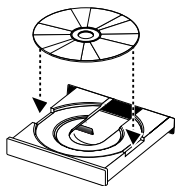

### Notes:

- DVDs may have a region code. Your player will not play discs that have a region code different from the region code of your player.
- If 'Disc Lock' is set to LOCK and the disc inserted is not authorized, the 6-digit code must be entered and/or the disc must be authorized (see 'Disc Lock').

## General Operation

*Note: All instructions set out below refer to the remote control, unless otherwise stated.*

### Video control during playback

#### STOP/PLAY DVD VCD CD SVCD

- 1 If you press the STOP key once, you can later resume from the point at which you stopped by pressing the PLAY key. The player will start from the beginning of the disc if you pressed the STOP key twice.

#### PAUSE/STEP DVD VCD CD SVCD

- 1 To get a still picture, press PAUSE key during playback.
- 2 To step forward to the next frame picture, press PAUSE key again.
- 3 To resume normal playback, press PLAY.

#### SEARCH DVD VCD CD SVCD

- 1 To search the contents in fast speed, press the ► or ◀ for fast forward/backward searching.
- 2 Press the ◀ or ► again to increase the speed for searching.
- 3 Press PLAY to return to normal playback.

## Slow Motion

### DVD

- 1 To get a slow motion effect during playback, press ▲ or ▼.
- 2 Press ▲ or ▼ again, you can get different playback forward/backward speeds.
- 3 Press PLAY to return to normal play back.

### VCD SVCD

- 1 To get a slow motion effect during playback, press ▼.
- 2 Press ▼ again, you can get different playback forward speeds.
- 3 Press the PLAY key to return to normal play back.

### NOTE:

-The SLOW BACKWARD function is not available for Super VCD/VCD/CD discs.

## Audio control during playback

### MUTE DVD VCD CD SVCD

- 1 Press the MUTE key to disable the sound output.
- 2 Press the MUTE key again to deactivate mute.

## Audio channel selection

### VCD CD SVCD

- 1 Super VCD has two stereo audio channels which are used for playing karaoke or the audio language selection. ( for instance, you can choose one channel for only the music background of the song while you play the karaoke.)
- 2 Press the AUDIO key on the remote control to select the audio channels you want.
- 3 VCD has only one stereo audio channel, you can select STEREO, LEFT MONO, RIGHT MONO or MIX-MONO by pressing the AUDIO key on the remote control.
  - STEREO: Output the left and right audio channels of the disc through the left and right audio sockets accordingly.
  - LEFT MONO: Output the left audio channels of the disc through the left and right audio sockets.
  - RIGHT MONO: Output the right audio channels of the disc through the left and right audio sockets.
  - MIX-MONO: each of the audio sockets can output the same audio effect as stereo.

*Note: If you choose digital audio output and set DIGITAL OUTPUT to ALL, you can not select LEFT MONO and RIGHT MONO with the AUDIO key.*

## Repeat

**DVD**

### Repeat chapter/title/disc

- To repeat the current chapter; press REPEAT.
- To repeat the current title, press REPEAT a second time.
- To repeat the whole disc, press REPEAT a third time.
- To exit REPEAT mode, press REPEAT again.

**VCD** **CD**

### Repeat track/disc

With PBC OFF,

- To repeat the current track, press REPEAT.
- To repeat the entire disc, press REPEAT a second time.
- To exit Repeat mode, press REPEAT again.

## Repeat A-B **DVD** **VCD** **CD**

### **DVD-Video Discs: repeat a sequence in a title**

### **Video and Audio CDs: repeat a sequence in a track**

- 1 Press REPEAT A-B at your chosen starting point.
- 2 Press REPEAT A-B again at your chosen end point.  
→ The repeat sequence begins.
- 3 To exit the sequence, press REPEAT A-B.

## 5 Disc Resume

**DVD** **SVCD** **VCD** **CD**

This player can resume playback of the last 5 discs, even if the disc was ejected or the power switched off.

- 1 Load one disc, which is one of the last 5 discs.
- 2 Press PLAY when DVD player is recognizing the disc. If the information of this disc has been stored in the memory of DVD player, it will be played back from the stop point last time.

## OSD (On-Screen Display)

**DVD** **VCD** **SVCD**

This function will provide some information about your playing disc on the screen.

- Press DISPLAY key on the remote control.

### Title Selection

- 1 Press ◀▶ to highlight option Title number.
- 2 Press ▲▼ to change the title number:  
→ DVD player will playback selected title.

### Chapter Selection

- 1 Press ◀▶ to highlight option chapter number.
- 2 Press ▲▼ to change the chapter number:  
→ DVD player will playback selected chapter.

### Time Search

- Press ◀▶ to highlight time display area.  
For DVD discs:  
→ CC refers to the elapsed time of the current chapter. CR refers to the remaining time of the current chapter. TC refers to the elapsed time of the current title. TR refers to the remaining time of the current title.  
For SuperVCD or VCD disc  
→ DC refers to the elapsed time of the current disc. DR refers to the remaining time of the current disc. TC refers to the elapsed time of the current track. TR refers to the remaining time of the current track.  
Press ▲ to make the selection.
- Press the ◀▶ keys to highlight the item TIME and you can play from any point of the disc.  
→ Enter hours, minutes and seconds from left to right in the time edit box using remote control numerical key pad.( e.g. 0:34:27)  
→ Press the OK key to confirm.

## Zoom **DVD** **VCD** **SVCD**

The Zoom function allows you to change the image size.

- 1 Press the ZOOM key to activate the function.  
→ Use the ▲▼◀▶ key to view other parts of the zoomed picture.  
→ Playback will continue.
- 2 Press the ZOOM key repeatedly to return to the original size.

**NOTE: This function is NOT available for some DVD discs.**

# Operation

## Special DVD Features

### Playing a Title DVD

A DVD disc may have one or more titles. This depends on the content (a movie, video clips, a drama series, etc.) on the disc.

- After you load a disc, information about the content shows on the screen waiting for your selection. You can also press the TITLE key on the remote control to turn back to the title menu during playback.
  - Press the appropriate numerical key or ▲▼◀▶ keys on the remote control to highlight your selection.
  - Press the OK key to confirm.

### Playing a Chapter DVD

When you have selected a title, it may include one or more chapters.

- Any time you want to watch another chapter during playback, press DISC MENU key to turn back to the chapter menu (If disc has chapter menu).
  - Press the appropriate numerical key or ▲▼◀▶ keys on the remote control to highlight your selection.
  - Press the OK key to confirm.
  - After a chapter has been selected, you also can press the ◀◀ or ▶▶ key to make a change.

### Camera Angle DVD

Some discs contain scenes which have been shot simultaneously from various angles.

This DVD player allows you to select the desired camera angle.

- Press the ANGLE key on your remote control.
 

*NOTE: The function is available only for the DVD discs which have several angles recorded .*

### Changing the Audio Language DVD

- Press AUDIO repeatedly to select the different languages.
 

*NOTE: The function will be activated only if the DVD is recorded with multi-language audio tracks.*

## Subtitles DVD SVCD

- Press SUBTITLE repeatedly to select the different subtitles.
- Press SUBTITLE for about 2 seconds to switch subtitle on or off.
 

*NOTE: The function will be activated, only if the DVD or SuperVCD is recorded with multi-subtitles.*

## Special VCD & SVCD Features

### Playback Control (PBC)

PBC function allows you to enter the index menu which is used to select a track after loading the VCD & SVCD disc.

**If you want to activate the function during the playback or after pressing the STOP key twice,**

- 1 press the DISC MENU key on the remote control to set the PBC On.
  - Pay attention to the hint on the screen.
- 2 Use the ◀◀ or ▶▶ key to select the page you like.
  - If the items of the index menus are numbered, press the appropriate numerical key on the remote control.
  - press the OK key to confirm.
- 3 Press the RETURN key to enter the index menu during the playback.

*NOTE:*

- The content of the index menu depends on the disc. Please refer to the disc's instructions for details.
- If the disc doesn't include the PBC information, this function will have no effect.

**If you want to skip the index menu and playback directly from the beginning,**

- 1 press the DISC MENU key on the remote control to switch off the function.

## Preview Function

- Press the PREVIEW key to enter previewing menu.
- Press ▲▼ key to highlight TRACK DIGEST, DISC INTERVAL or TRACK INTERVAL.
- Press OK key to open one option.

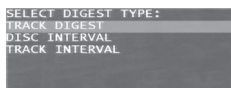

- After you enter the menu of any digest type,
  - To quit preview function: Press ▲▼◀▶ to highlight EXIT and press OK to confirm.
  - To return to the previewing menu for selecting the other digest type: Press ▲▼◀▶ to highlight MENU and press OK to confirm.

## 1 Track Digest

This function will minimize the picture of every track in order to display every six of these tracks on the screen to help you know the content of every track on the disc.



- To choose the desired track, please press ▲▼◀▶ to highlight the second line and input your selected track number next to "SELECT".
  - Select the others from the current six by pressing the ◀◀ or ▶▶ key to open the previous or next page.
- Press the OK key to confirm.

## 2 Disc Interval

This function is used to divide a disc into six parts by regular intervals and display them on one page to help you preview the whole disc.



- To choose the desired track, please press ▲▼◀▶ to highlight the second line and input your numerical selection next to "SELECT".
- Press the OK key to confirm.

## 3 Track Interval

This function is used to divide a single track into six parts by regular intervals and display them on one page to help you preview the selected track.



- To choose the desired track, please press ▲▼◀▶ to highlight the second line and input your numerical selection next to "SELECT".
- Press the OK key to confirm.

# Picture CD & MP3 Playback

This player can playback JPEG format pictures and MP3 files on a personally recorded CD-R/RW disc or commercial CD, and is compatible with Kodak Picture CD.

- Playback pictures or songs one by one automatically.
- Album and track selection.
- Repeat (disc / album / track / picture).
- Select any music or pictures from the disc to playback them together.
- Maximum number of files within one folder is 500
- Maximum files Programmable is 100.
- MP3: Maximum supported Bitrate is 256kbits or 48kHz in Variable Bitrate mode
- JPEG: Maximum supported resolution is 3072 x 2048 (for baseline JPG pictures), or 2000 x 1500 (for progressive JPG pictures).

## General Operation

- If you choose WITH MENU in the Setup Menu (Please refer to the MP3 & JPEG navigator below), the Picture CD/MP3 CD menu will be shown on the screen before playback.



- At any time during playback, press DISC MENU to return to the menu for Selection/Repeat / Shuffle / Single playback.
- Both columns on every page of the menu contain six files or folders, you can press ◀▶ to highlight either of the column and then press ▶▶| or ◀◀ to open the next or previous six files or folders.

## MP3 & JPEG Navigator

To select a different playback method, follow the steps below.

- 1 At STOP mode, press the SYSTEM MENU key to open the setup menu.
- 2 Press the ▲ ▼ key to highlight PREFERENCE.
- 3 Press OK to open the PREFERENCE menu.
- 4 Press the ▲ ▼ key to highlight the MP3/JPEG NAV menu.
- 5 Press the ▶ key to enter the menu.
- 6 Press the ▲ ▼ key to highlight the WITHOUT MENU or WITH MENU item.
  - WITHOUT MENU: automatically playback all files in according date sequence.
  - WITH MENU: playback files in the selected folder.
- 8 Press the OK key to confirm your selection.

## Play Mode

### Auto Playback

If you choose WITHOUT MENU, the DVD player will automatically playback Picture CD/MP3 CD in sequence when it is loaded.

### Playback Selection

- One way is to press the number of your favourite file at any time during playback.
  - Another way is to select via the menu (after pressing STOP).
- 1 Press DISC MENU to open the Picture CD/MP3 CD menu.
  - 2 When the menu appears on the screen, press the ▲ ▼ key to select the folder you want and press the OK to open it.
  - 3 Press the ▶ to enter the file list.



- 4 Press the ▲ ▼ key to highlight one option, or press its number:
  - You also can press ▶▶| or ◀◀ to go to the next or previous page.
- 5 press OK key to confirm.
  - The playback will start from this selected file to the last in this folder.

## Repeat / Shuffle / Single Playback

- When the Picture CD/MP3 CD menu is shown on the screen, Press REPEAT key repeatedly, the button beside PLAY MODE will display different option,
  - SINGLE :The file plays once.
  - REPEAT ONE: For JPEG files, the current picture remains on the screen. For MP3 music, the selected song plays repeatedly.
  - REPEAT FOLDER : All files in the folder play repeatedly.
  - SHUFFLE : All files are played randomly.
- If you press REPEAT key during playback, the option will be displayed on the screen accordingly.

## Program Playback

- 1 When the Picture CD/MP3 CD menu is shown on the screen, Press DISC MENU key.
  - The left column is the original files and the right one is the programmed files.

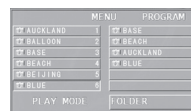

- 2 Press the ▲ ▼ to select one file.
  - You also can press ▶▶| or ◀◀ to open the next six files to choose.



## Picture CD & MP3 Playback

- 3 Press OK or PLAY key to add the selected file from the left column to the right column.  
→ The maximum is 100 files.
- 4 Press STOP key to remove the programed file from the right column.
- 5 Highlight one file of the right column and press OK key, then the programed files will start playing back.

### Special JPEG Features

#### Function Introduction

Picture CD is a disc with a collection of JPEG format pictures, and all extension filenames should end with 'JPG'. The CD can be recorded on any computer, and pictures may be from digital camera or scanner. If the customers prefer, they can make this CD become a Digital Album.

You can choose any general function introduced in GENERAL OPERATION, besides, you also can,

- Display the thumbnails of 12 pictures.
- Zoom the picture.
- Rotate the picture.
- Flip the picture vertically or horizontally.
- Scan pictures by different effects.

#### Preview Function

This function shows the content of the current folder or the whole disc.

- 1 Press the STOP key during playback of JPEG pictures. You will see the thumbnails of 12 pictures on the screen.



- 2 Press ►► or ◀◀ key to display the other pictures on the next or the previous page.
- 3 Press the ◀► ▲ ▼ key to highlight one of them and press OK to playback, or, Move the cursor to highlight SLIDE SHOW on the bottom of the page to start playback from the first picture on the current page.
- 4 Press DISC MENU to go to the Picture CD/MP3 CD menu.

#### Zoom picture

- During playback, press ZOOM key to display the picture with different scales.
- Press the ◀► ▲ ▼ key to view the rest of the zoomed picture.

#### Playback with multi-angles

When displaying one picture on TV screen

- Press the ▲ ▼ ◀ ► key to get different effects.
  - ▲ key: Flip the picture vertically.
  - ▼ key: Flip the picture horizontally.
  - ◀ key: rotate the picture anti-clockwise.
  - key: rotate the picture clockwise.

#### Scan Effect

- Press ANGLE key repeatedly to choose different scan effects.

### Special MP3 Features

#### Function Introduction

"MP3" stands for "MPEG Audio Layer-3", and is a part of the MPEG standard. A CD can store up to 10 hours of MP3 audio, which is nearly 10 times as much as an Audio CD. Each song is recorded as a file. You can choose any general function introduced in GENERAL OPERATION. You can also choose different playback speeds.

#### Playback Speed Control

Press RETURN/TITLE key to switch to MP3+NAV mode,

- Press ◀ ►, you can get different playback backward/forward speeds.
- You also can press ►► or ◀◀ to change the tracks.

#### JPEG and MP3 simultaneous playback

- 1 Firstly playback MP3 music according to the instructions introduced in playback Selection.
- 2 Please switch to MP3+JPEG+NAV by pressing RETURN/TITLE.
- 3 Then select a picture to playback. Please refer to the instructions introduced in playback Selection.  
→ Now the pictures will be played back in sequence together with MP3 music.
- 4 To quit simultaneous playback, press DISC MENU key to return to the Picture CD/MP3 CD menu, then pictures will be stopped. After that, press STOP key, then MP3 music will be stopped as well.

*Note: In the function of JPEG and MP3 Simultaneous Playback, ►► and ◀◀ keys are invalid for MP3.*

# Setup Menu

## Basic Operation

- 1 Press SYSTEM MENU in the STOP mode to enter the Setup Menu.
- 2 Press the OK key to go to the next level submenu or confirm your selection.
- 3 Press the ◀▶ keys to enter the submenu or return to the previous menu.
- 4 Press the ▲▼ keys to highlight the desired menu.
- 5 Press SYSTEM MENU to quit the setup menu.
  - When you quit the setup menu, the settings will be stored in the player's memory even if the player is switched to power off.

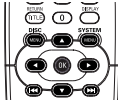

## General Setup menu

Some settings need to be made in this menu. They are: DISC LOCK, PROGRAM, DISPLAY DIM, OSD LANGUAGE and SCREEN SAVER. Follow the steps below:



- 1 Press the SYSTEM MENU key to enter the setup menu.
- 2 Press the ▲▼ keys to choose the GENERAL SETUP.
- 3 Press the OK key to confirm selection.

## OSD language

This option is to select a language for information displayed on TV screen.



- 1 Press the ▲▼ keys to highlight OSD LANGUAGE in the GENERAL SETUP menu.
- 2 Enter its submenu by pressing the ▶ key.
- 3 Move the cursor by pressing the ▲▼ keys to highlight the selected language.
- 4 Press the OK key to confirm.
- 5 Press the ◀ key to return to the GENERAL SETUP menu.

## Program (not for Picture CD/MP3)

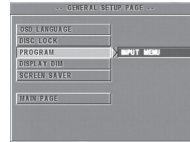

- 1 To choose PROGRAM, press ▲▼ keys.
- 2 Press the ▶ key to move the cursor to the field of the submenu to choose the item INPUT MENU.
  - INPUT MENU: Enter the PROGRAM item.
- 3 Press OK to enter the program page.

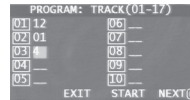

## Input your favorite track

- 1 Input valid track number by pressing the numerical keys.
- 2 Press the ◀▶▲▼ keys to move the cursor to the next selected position.
  - If the track number is more than ten, press ▶▶ to open the next page and go on programming, or press ◀▶▲▼ to highlight NEXT button, and then press OK.
- 3 Repeat these steps to input another track number until the whole program is completed.

## Remove a track

- 1 Press the ◀▶▲▼ keys to move the cursor to the track you want to remove.
- 2 Press OK or PLAY key to remove this track from the program menu.

## Playback tracks

When programming is completed,

- 1 Press the ◀▶▲▼ keys to move the cursor to the START button.
- 2 Press OK.
  - DVD player will playback the selected tracks under the programmed sequence.

## Quit the program playback

In the PROGRAM menu,

- 1 Press the ◀▶▲▼ keys to move the cursor to the EXIT button.
- 2 Press the OK key to quit this menu.

## Stop the program playback

- During playback of the programmed tracks, press STOP key. Then after you press PLAY key, the DVD player will resume normal playback.

## Repeat the program playback

- During playback of the programmed tracks, press the REPEAT key. The programmed tracks can be played again.

## Display Dim

This function is used to adjust the brightness of display on the front panel of the DVD player.



- 1 Press the ▲▼ keys to highlight DISPLAY DIM in the GENERAL SETUP menu.
- 2 Enter its submenu by pressing the ► key.  
→ Press the ▲▼ keys to highlight 100%/70%/40% item.
- 3 Press OK to confirm.
- 4 Press the ◀ key to return to the GENERAL SETUP menu.

## Disc Lock

When the disc is locked, the player will store its specific code into the memory for future identification. For the next playback, the DVD player will prompt you to enter the password. Then, press OK to load the disc.



- 1 Press the ▲▼ keys to highlight DISC LOCK in the GENERAL SETUP menu.
- 2 Enter its submenu by pressing the ► key.  
→ LOCK: Lock the disc being played.  
→ UNLOCK: unlock the disc.
- 3 Press the ◀ key to return to the GENERAL SETUP menu.

### NOTE:

1. When a locked disc is loading, the DVD player will prompt you to enter your password (842100 is the default password).
2. To change the password, refer to the option PASSWORD in the PREFERENCE SETUP menu.

## Screen Saver

This function is used to turn the screen saver on or off.

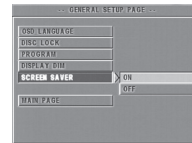

- 1 Press the ▲▼ keys to highlight SCREEN SAVER in the GENERAL SETUP menu.
- 2 Enter its submenu by pressing the ► key.
- 3 Move the cursor by pressing the ▲▼ keys to highlight the selected item.  
→ ON: In STOP or No DISC mode, if no actions are performed within 5~6 minutes, the screen saver will be activated.  
→ OFF: Screen saver is disabled.
- 4 Press OK to confirm.
- 5 Press the ◀ key to return to the GENERAL SETUP menu.

## Setup Menu

### Analog Audio Setup menu

This menu contains setup options for your analog audio output, such as DOWNMIX, D.R.C. (Dynamic Range Compression) etc. which makes the DVD player reproduce high quality surround sound.



- 1 Press SYSTEM MENU.
- 2 Press the ▲▼ keys to highlight the ANALOG OUTPUT SETUP.
- 3 Press OK to confirm.

### DOWNMIX



- 1 Press the ▲▼ keys to highlight the DOWNMIX.
- 2 Enter its submenu by pressing the ► key.
- 3 Move the cursor by pressing the ▲▼ keys to highlight the selected item.
  - LT/RT
    - This option should be used only if your DVD player is connected to a Dolby Prologic decoder.
  - STEREO
    - This option will downmix Dolby Digital signals directly into analogue stereo from L/R sockets.
- 4 Press OK.
- 5 Press the ◀ key to return to the ANALOG OUTPUT SETUP menu.

### D.R.C. (Dynamic Range Compression)



The DVD player will compress the dynamic range of its sound output for late-night listening.

- 1 Press the ▲▼ keys to highlight D.R.C..
- 2 Enter its submenu by pressing the ► key.
- 3 Move the cursor by pressing the ▲▼ keys to highlight the selected item.
  - ON: Enable D.R.C.
  - OFF: Disable D.R.C.
- 4 Press OK.
- 5 Press the ◀ key to return to the ANALOG OUTPUT SETUP menu.

### Digital Audio Setup menu

In this menu, you can set up the digital audio output signal from the digital terminals, such as coaxial etc.



- 1 Press SYSTEM MENU to enter the SETUP menu.
- 2 Press the ▲▼ keys to choose the DIGITAL OUTPUT SETUP.
- 3 Press OK.

## Digital Output



- 1 Press the ▲▼ keys to highlight DIGITAL OUTPUT.
- 2 Enter its submenu by pressing the ► key.
- 3 Press the ▲▼ keys to highlight the selected item.
  - ALL: Original digital signal is output.
  - PCM ONLY: If your receiver is PCM-compatible, or your receiver can not decode MPEG-2, Dolby Digital, or DTS audio, choose this option.
- 4 Press OK.
- 5 Press the ◀ key and return to the DIGITAL OUTPUT SETUP menu.

*Note: If DIGITAL OUTPUT is set to ALL, all audio settings except MUTE are invalid.*

## LPCM Output

If you connect the DVD player to a PCM compatible receiver via the digital terminals, such as coaxial etc, you may need to select LPCM OUTPUT.

Discs are recorded at a certain sampling rate. The higher the sampling rate, the better the sound quality.

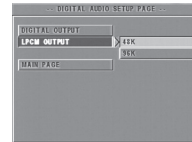

- 1 Press the ▲▼ keys to highlight the LPCM OUTPUT.
- 2 Enter its submenu by pressing the ► key.
- 3 Move the cursor by pressing the ▲▼ keys to highlight the selected item.
  - 48K: Playback a disc recorded at the sampling rate of 48kHz.
  - 96K: Playback a disc recorded at the sampling rate of 96kHz.
- 4 Press OK.
- 5 Press the ◀ key to return to the DIGITAL OUTPUT SETUP menu.



# Setup Menu

English

## Video Setup menu

There are items included in VIDEO SETUP menu such as TV TYPE, VIDEO OUTPUT, TV DISPLAY, TV MODE, SMART PICTURE, COLOR SETTING.



- 1 Press STOP.
- 2 Press SYSTEM MENU to enter the menu.
- 3 Highlight VIDEO SETUP by pressing the ▲▼ keys.
- 4 Press OK.

## TV Type

Before viewing the DVD or VCD, ensure that the PAL or NTSC setting of the system matches your TV set.



- 1 Press the ▲▼ keys to highlight TV TYPE in the VIDEO SETUP menu.
- 2 Enter its submenu by pressing the ► key.
- 3 Move the cursor by pressing the ▲▼ keys to highlight one option.
- 4 Press OK.
- 5 Press the ◀ key to return to the VIDEO SETUP menu.

### NTSC/PAL Conversion

This player is equipped with a NTSC/PAL conversion feature to convert the video output of the disc to match your TV system. The conversions supported are as below:

Disc Type	Format	Output format Selected mode		
		NTSC	PAL	MULTI
DVD	NTSC	NTSC	PAL	NTSC
	PAL	NTSC	PAL	PAL
VCD	NTSC	NTSC	PAL	NTSC
	PAL	NTSC	PAL	PAL

### Notes:

- MULTI can only be selected when using a TV that has both the NTSC and PAL systems.
- If you have a multi-standard TV (PAL/NTSC), use the MULTI setting to obtain the best picture quality.

## TV Display

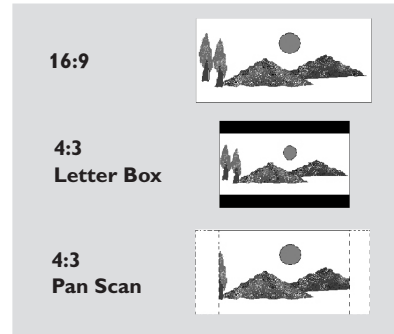

Select the aspect ratio of the TV to be connected.

**16:9** → when you connect a wide-screen TV to the DVD player.

**4:3 LETTERBOX** → when you connect a normal TV to the DVD player. Displays a wide picture with bands displayed on the upper and lower portions of the TV screen.

**4:3 PAN SCAN** → when you connect a normal TV to the DVD player. Displays the wide picture on the whole TV screen with a portion automatically cut off.

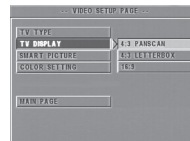

### Setup the item as follows,

- 1 Press the ▲▼ keys to highlight the TV DISPLAY option in the VIDEO SETUP menu.
- 2 Enter its submenu by pressing the ► key.
- 3 Move the cursor by pressing the ▲▼ keys to highlight the selected item.
- 4 Press OK.
- 5 Press the ◀ key to return to the VIDEO SETUP menu.

**Note :** PanScan output is not available on all discs.



## Smart Picture

In this menu, you can choose a picture setting from a fixed set of ideal predefined picture settings.



- 1 Press the ▲▼ keys to highlight SMART PICTURE in the VIDEO SETUP menu.
- 2 Press the ► key to highlight the item of the submenu.
- 3 Press the ▲▼ keys to choose an item.
  - STANDARD: select a standard picture setting.
  - BRIGHT: make the TV picture brighter.
  - SOFT: make the TV picture softer.
  - PERSONAL: achieve the color effect set in the COLOR SETTING menu.
- 4 Press OK.
- 5 Press ◀ key to return to the VIDEO SETUP menu.

## Color Setting

In this menu you can personalize the picture color by adjusting brightness, contrast, hue and saturation.

- 1 Press the ▲▼ keys to highlight COLOR SETTING in the VIDEO SETUP menu.
- 2 Press OK to open its submenu.

## Brightness



- 1 Press the ▲▼ keys to highlight BRIGHTNESS in the COLOR SETTING menu.
- 2 Press the ► key to open the level bar:
  - Display at the bottom of the screen.
- 3 Press the ►◀ keys to increase and decrease the brightness level.
- 4 Press the ▲▼ or OK key to return to the COLOR SETTING menu.



# Setup Menu

## Contrast

- 1 Press the ▲▼ keys to highlight CONTRAST in the COLOR SETTING menu.
- 2 Press the ► key to open the level bar.  
→ Display at the bottom of the screen.
- 3 Press the ►◀ keys to increase and decrease the contrast level.
- 4 Press the ▲▼ or OK key to return to the COLOR SETTING menu.

## Hue

- 1 Press the ▲▼ keys to highlight HUE in the COLOR SETTING menu.
- 2 Press the ► key to open the level bar.  
→ Display at the bottom of the screen.
- 3 Press the ►◀ keys to increase and decrease the hue level.
- 4 Press the ▲▼ or OK key to return to the COLOR SETTING menu.

## Saturation

- 1 Press the ▲▼ keys to highlight SATURATION in the COLOR SETTING menu.
- 2 Press the ► key to open the level bar.  
→ Display at the bottom of the screen.
- 3 Press the ►◀ keys to increase and decrease the saturation level.
- 4 Press the ▲▼ or OK key to return to the COLOR SETTING menu.

## Preference Setup menu

There are options included in PREFERENCE menu such as AUDIO, SUBTITLE, DISC MENU, PARENTAL, PASSWORD, DEFAULT and MP3/JPEG NAV.



- 1 Press the STOP key twice.
- 2 Press SYSTEM MENU to enter the menu.
- 3 Highlight the PREFERENCE SETUP by pressing the ▲▼ keys.
- 4 Press OK to confirm your selection.

## Audio language

DVD discs are available with multiple audio languages. Use this option to select the preferred default audio language.



- 1 Press the ▲▼ keys to highlight AUDIO.
- 2 Enter the submenu by pressing the ► key.
- 3 Move the cursor by pressing the ▲▼ keys to highlight the selected option.
- 4 Press OK.
- 5 Press the ◀ key to return to the PREFERENCE menu.

**NOTE:** Your DVD disc may not include the audio language which you set in the AUDIO menu. If so, the player will use another audio language instead.



## Subtitle language

DVD discs are available with multi-subtitle languages. Use this option to select the preferred default subtitle language.



- 1 Press the ▲▼ keys to highlight SUBTITLE.
- 2 Enter the submenu by pressing the ► key.
- 3 Move the cursor by pressing the ▲▼ keys to highlight the selected option.
- 4 Press OK.
- 5 Press ◀ key to return to the PREFERENCE menu.

*NOTE: Your DVD disc may not include the subtitle which you set in the SUBTITLE menu. If so, the player will use another subtitle language instead.*

## Disc Menu language

DVD discs are available with multiple disc menu languages. This option is used to select the default disc menu language.



- 1 Press the ▲▼ keys to highlight DISC MENU.
- 2 Enter the submenu by pressing the ► key.
- 3 Move the cursor by pressing the ▲▼ keys to highlight the selected item.
- 4 Press OK.
- 5 Press ◀ key to return to the PREFERENCE menu.

*NOTE: If your DVD disc doesn't include the disc menu language you have set, the player will use another recorded language instead.*

## If you choose OTHERS in AUDIO, SUBTITLE or DISC MENU menu,

You can select other languages. Please do as follows,

- 1 Move the cursor by pressing the ▲▼ keys to highlight OTHERS.
- 2 Press OK.  
→ The DVD player will prompt you to enter a language code (Four digits).
- 3 Input a language code by pressing numerical keys.  
→ Please look up the preferred language code in the chapter LANGUAGE CODE, which can be found at the end of this manual.
- 4 Press OK.

## Password

This item is used for the parental control and disc lock. Enter your six digit password when a hint is displayed on the screen.

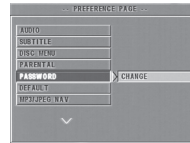

- 1 Press the ▲▼ keys to highlight the PASSWORD option.
- 2 Enter the submenu by pressing the ► key.
- 3 Press OK key to open the PASSWORD CHANGE page.



- 4 Enter the current 6 digit code.
- 5 If successful, the player will prompt for a new one.
- 6 After that, enter the new password again to reconfirm.
- 7 Press the OK key to return to the PREFERENCE menu.  
→ The new 6 digit code will take effect.

### NOTE:

1. You can change the setup of parental control and load a locked disc with a valid password being entered.
2. If you forget your password, you can enter the default password 842100.

# Setup Menu

## Parental Control

Movies on DVDs may contain scenes which are not suitable for children. Therefore, discs may contain 'Parental Control' information which applies to the complete disc or to certain scenes on the disc. These scenes are rated from 1 to 8, and alternative, more suitable scenes are available on the disc. Ratings are country dependent. The 'Parental Control' feature allows you to prevent discs from being played by your children or to have certain discs played with alternative scenes.

- VCD, SVCD, CD have no level indication, so parental control function has no effect on those kinds of discs. This applies to most illegal DVD discs.
- You can follow the steps below to setup the parental control:

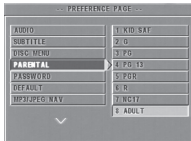

- 1 Press the ▲▼ keys to highlight PARENTAL.
- 2 Move to its submenu by pressing the ► key.
- 3 Then use the ▲▼ keys to highlight a rating for the disc inserted.
- 4 Press OK to confirm, then press the ◀ key to return to the PREFERENCE menu.

### No Parental Control

Parental Control is not activated. The Disc will be played in full.

- 1 Select ADULT item.
- 2 Press OK.

### Ratings 1 to 7:

Some discs contain scenes which are not suitable for children. All scenes with a rating higher than you set will be skipped during playback. However if the disc contains alternate scenes, these will play automatically. If not, the playback will stop and the six digits code will need to be entered again.

## Default Setup

If problems occur while setting up the DVD player, the DEFAULT function can be used to reset all options to the factory defaults and all your personal settings will be erased.



- 1 Press ▲▼ to highlight DEFAULT.
- 2 Highlight RESET by pressing the ► key.
- 3 Press OK.

**CAUTION:** When this function is activated, all setups will be reset to factory defaults.

## MP3/JPEG Navigator

This menu allows you to select alternate settings when you playback picture CD and MP3 CD.



- 1 Press ▲ ▼ to highlight MP3/JPEG NAV.
- 2 Press ► to enter the submenu.
- 3 Press ▲ ▼ to highlight WITHOUT MENU or WITH MENU.
  - WITHOUT MENU: playback all pictures or MP3 music in sequence automatically.
  - WITH MENU: playback pictures or MP3 music in the selected folder.
- 5 Press OK key to confirm your selection.

# Specifications

English

## PLAYBACK SYSTEM

DVD Video  
Video CD & SVCD  
CD  
PICTURE CD  
MP3-CD  
CD-R, CD-RW  
DVD+R, DVD+RW

## VIDEO PERFORMANCE

CVBS 1Vpp --- 75Ω  
RGB (SCART) 0.7Vpp into 75 ohm

## AUDIO FORMAT

Digital	Mpeg/ AC-3/ DTS PCM	compressed Digital 16, 20, 24 bits fs, 44.1, 48, 96 kHz
	MP3 (ISO 9660)	24, 32, 56, 64, 96, 128, 256 kbps & variable bit rate fs, 16, 22.05, 24, 32, 44.1, 48 kHz

Analog Sound Stereo

## AUDIO PERFORMANCE

DA Converter	24bit
Signal-Noise (1kHz)	100dB
Dynamic range(1kHz)	>90dB
DVD	fs 96 kHz 4Hz- 44kHz fs 48 kHz 4Hz- 22kHz
SVCD	fs 48 kHz 4Hz- 22kHz fs 44.1kHz 4Hz- 20kHz
CD/VCD	fs 44.1kHz 4Hz- 20kHz

## TV STANDARD (PAL/50Hz) (NTSC/60Hz)

Number of lines	625	525
Playback	Multistandard	(PAL/NTSC)

## CONNECTIONS

Scart Output	Euroconnector
Video Output	Cinch
Audio Output(L+R)	Cinch
Digital Output	1 coaxial IEC958 for CDDA / LPCM/ MPEG1 IEC1937 for MPEG 2, Dolby Digital and DTS

## CABINET

Dimensions (w x d x h)	360 x 285 x 43 mm
Weight	Approximately 2.2 Kg

*Specifications subject to change without prior notice*

## POWER CONSUMPTION

Power consumption in Standby mode <1W

## Maintenance

### Cleaning the Cabinet

- Use a soft cloth slightly moistened with a mild detergent solution. Do not use a solution containing alcohol, spirits, ammonia or abrasives.

### Cleaning Discs

- When a disc becomes dirty, clean it with a cleaning cloth. Wipe the disc from the center out. Do not wipe in a circular motion.
- Do not use solvents such as benzene, thinner, commercially available cleaners, or antistatic spray intended for analog records.

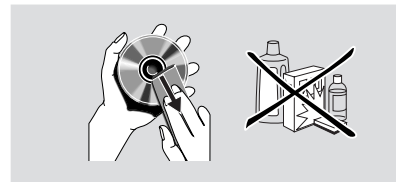



# Troubleshooting

English

## WARNING

**Under no circumstances should you try to repair the system yourself, as this will invalidate the warranty. Do not open the system as there is a risk of electric shock.**

**If a fault occurs, first check the points listed below before taking the system for repair. If you are unable to remedy a problem by following these hints, consult your dealer or service center.**

Problem	Solution
<b>No power</b>	<ul style="list-style-type: none"> <li>– Check if the AC power cord is properly connected.</li> </ul>
<b>No picture</b>	<ul style="list-style-type: none"> <li>– Check if the TV is switched on.</li> <li>– Check the video connection.</li> </ul>
<b>Distorted picture</b>	<ul style="list-style-type: none"> <li>– The disc is badly scratched or dirty.</li> <li>– Sometimes a small amount of picture distortion may appear. This is not a malfunction.</li> </ul>
<b>Completely distorted picture or black/white picture with DVD or Video CD</b>	<ul style="list-style-type: none"> <li>– Make sure the NTSC/PAL setting at the DVD player matches the video signal of your television. (See NTSC/PAL CONVERSION)</li> <li>– If the picture becomes distorted after switching between PAL and NTSC, please set the SMART PICTURE to STANDARD.</li> </ul>
<b>No sound or distorted sound</b>	<ul style="list-style-type: none"> <li>– Adjust the volume.</li> <li>– Check that the speakers are connected correctly.</li> </ul>
<b>No audio at digital output</b>	<ul style="list-style-type: none"> <li>– Check the digital connections.</li> <li>– Check if your receiver can decode MPEG-2 or DTS and if not, please make sure the digital output is set to PCM.</li> <li>– Check if the audio format of the selected audio language matches your receiver capabilities.</li> </ul>
<b>Disc can't be played</b>	<ul style="list-style-type: none"> <li>– The DVD+R/DVD+RW/CD-R must be finalized.</li> <li>– Ensure the disc label is facing up.</li> <li>– Check if the disc is defective by trying another disc.</li> <li>– If you record a Picture CD or MP3 CD yourself, ensure that your disc contains at least 10 pictures or 5 MP3 tracks.</li> </ul>
<b>No return to start-up screen when disc is removed</b>	<ul style="list-style-type: none"> <li>– Reset the unit by switching the player off, then on again.</li> </ul>
<b>The player does not respond to the remote control</b>	<ul style="list-style-type: none"> <li>– Aim the remote control directly at the sensor on the front of the player.</li> <li>– Reduce the distance to the player.</li> <li>– Replace the batteries in the remote control.</li> <li>– Insert the batteries with their polarities (+/- signs) as indicated.</li> </ul>
<b>Buttons do not work</b>	<ul style="list-style-type: none"> <li>– In order to completely reset the player, unplug the AC cord from the AC outlet.</li> </ul>
<b>Player does not respond to some operating commands during playback</b>	<ul style="list-style-type: none"> <li>– Operations may not be permitted by the disc. Refer to the instructions of the disc.</li> </ul>
<b>DVD Video player cannot read CDs/DVDs</b>	<ul style="list-style-type: none"> <li>– Use a commonly available cleaning CD/DVD to clean the lens before sending the DVD Video player for repair.</li> </ul>



## Free Manuals Download Website

<http://myh66.com>

<http://usermanuals.us>

<http://www.somanuals.com>

<http://www.4manuals.cc>

<http://www.manual-lib.com>

<http://www.404manual.com>

<http://www.luxmanual.com>

<http://aubethermostatmanual.com>

Golf course search by state

<http://golfingnear.com>

Email search by domain

<http://emailbydomain.com>

Auto manuals search

<http://auto.somanuals.com>

TV manuals search

<http://tv.somanuals.com>