



DVD Video Player

DVD622

# User manual

Visit us at [www.philips.com/support](http://www.philips.com/support) for service support



# PHILIPS



01-30 DVD622\_935

1



21/06/05, 10:23 AM 39 246 14495





## General Information

### Environmental Information

All unnecessary packaging has been omitted. The packaging has been made easy to separate into three materials: cardboard (box), polystyrene foam (buffer) and polyethylene (bags, protective foam sheet).

Your DVD player consists of materials which can be recycled and reused if disassembled by a specialised company. Please observe the local regulations regarding the disposal of packaging materials, exhausted batteries and old equipment.

### Laser safety

This unit employs a laser. Due to possible eye injury, only a qualified service person should remove the cover or attempt to service this device.

**NOTE:**  
**PICTURES SHOWN MAYBE DIFFERENT BETWEEN COUNTRIES.**

**CAUTION**  
**(WARNING LOCATION: ON THE BACKPLATE OF THE SET)**

**NEVER MAKE OR CHANGE CONNECTIONS WITH THE POWER SWITCHED ON.**

**Important Note:**  
**Due to the numerous versions of new CD-Audio copy protection or enhanced CD-Audio protection recently available on certain discs, Philips is unable to guarantee that this DVD Player is fully compatible with such new discs. Should you have difficulty playing any such CD-Audio discs, kindly refer them to your CD-Audio disc retailer.**

#### For Customer Use:

Read carefully the information located at the bottom of your DVD VIDEO player and enter below the Serial No. Retain this information for future reference.

Model No. DVD VIDEO 622  
Serial No. \_\_\_\_\_

#### LASER

Type	Semiconductor laser GaAlAs
Wave length	650 nm (DVD) 780 nm (VCD/CD)
Output Power	7 mW (DVD) 10 mW (VCD/CD)
Beam divergence	60 degree



## Index

English ..... 4

中文(简体) ..... 31

English

中文(简体)

The apparatus shall not be exposed to dripping or splashing and that no objects filled with liquids, such as vases, shall be placed on apparatus.

*This product incorporates copyright protection technology that is protected by method claims of certain U.S. patents and other intellectual property rights owned by Macrovision Corporation and other rights owners. Use of this copyright protection technology must be authorized by Macrovision Corporation, and is intended for home and other limited viewing uses only unless otherwise authorized by Macrovision Corporation. Reverse engineering or disassembly is prohibited.*

*Manufactured under license from Dolby Laboratories. "Dolby", "Pro-Logic" and the double-D symbol are trademarks of Dolby Laboratories.*

Due to the inconsistency of disc formats provided by various disc manufacturers, your DVD system may require a playability enhancement or upgrade. As DVD technology advances, these enhancements will become common and will be easy to complete.  
**Go to [www.philips.com/support](http://www.philips.com/support) for software upgrade.**



# Contents

## Introduction

- Supplied accessories ..... 5
- Care and safety information ..... 5

## Connections

- Connecting TV ..... 6
  - Using Composite Video jacks (CVBS) ..... 6
  - Using S-Video jack ..... 6
  - Using Component Video jacks (Y Pb Pr) .. 7
  - Using an accessory RF modulator ..... 7
- Connecting the power cord ..... 8
- Optional: Connecting to an Audio System ... ..... 8
  - Stereo system has Dolby Pro Logic or Right / Left Audio In jack ..... 8
- Optional: Connecting Digital AV Receiver ... ..... 9
  - Receiver has a PCM, Dolby Digital, or MPEG2 decoder ..... 9

## Functional Overview

- Front and Rear Panels ..... 10
- Remote Control ..... 11

## Getting Started

- Step 1: Inserting batteries into the Remote Control ..... 12
  - Using the Remote Control to operate the Player ..... 12
- Step 2: Setting up the TV ..... 12-13
  - To deactivate Progressive manually ..... 12
  - Selecting the color system that corresponds to your TV ..... 13
  - Setting the TV Display ..... 13
- Step 3: Setting language preference ..... 14
  - Setting the OSD Language ..... 14
  - Setting the Audio, Subtitle and DVD menu language ..... 14

## Disc Operations

- Playable Discs ..... 15
- Region Codes ..... 15
- Playing discs ..... 16
- Using Disc Menu ..... 16
- Basic playback controls ..... 17-18
  - Pausing playback ..... 17
  - Selecting track/chapter ..... 17
  - Zoom ..... 17
  - Repeat ..... 17
  - Repeat A-B ..... 17
  - Slow Motion ..... 18
  - Forward / Reverse Searching ..... 18

- Preview ..... 18
- Special disc features ..... 19
  - Selecting a Title ..... 19
  - Camera Angle ..... 19
  - Changing the Audio Language ..... 19
  - Subtitles ..... 19
- Playing MP3/JPEG Picture CD ..... 19-20
  - General Operation ..... 19
  - Playback selection ..... 20
  - Repeat ..... 20
  - Zoom picture ..... 20
  - Playback with multi-angles ..... 20
  - Scan Effect ..... 20

## DVD Menu Options

- Language ..... 21
  - OSD Menu ..... 21
  - Audio, Subtitle, DVD Menu ..... 21
- Video Setup ..... 21-22
  - TV Display ..... 21
  - TV Type ..... 21
  - Setting the Video Output ..... 22
- Audio Setup ..... 23-24
  - Digital Output ..... 23
  - LPCM Output ..... 24
  - Night Mode - turning on/off ..... 24
- Rating ..... 25-26
  - Changing the Password ..... 25
  - Setting the Rating ..... 26
  - Restoring to original settings ..... 26

## Specifications ..... 27

## Troubleshooting ..... 28-29

## Glossary ..... 30



## Introduction

### Supplied accessories

Composite video cable (yellow) /  
Audio cable (white, red)

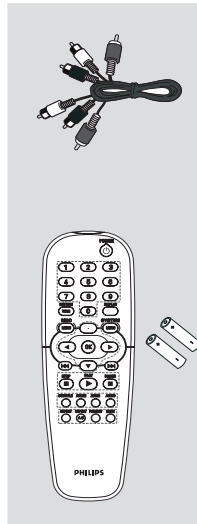

Remote Control  
and  
two AA batteries

### Care and safety information

- **Power consumption**
  - When the system is switched to Standby mode, it is still consuming power. To disconnect the system from the power supply completely, remove the AC power plug from the wall jack.

- **Avoid high temperatures, moisture, water and dust**
  - Do not expose the player, batteries or discs to humidity, rain, sand or excessive heat (caused by heating equipment or direct sunlight.)
- **Avoid condensation problem**
  - The lens may cloud over when the player is suddenly moved from cold to warm surroundings, making it impossible to play a disc. Leave the player in the warm environment until the moisture evaporates.
- **Do not block the vents**
  - Do not operate the DVD Player in an enclosed cabinet, allow about 10 cm (4 inch) of free space all around the player for adequate ventilation.

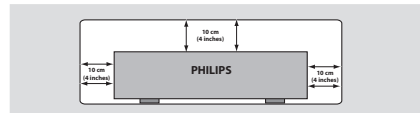

- **Care of the cabinet**
  - Use a soft cloth slightly moistened with a mild detergent solution. Do not use a solution containing alcohol, spirits, ammonia or abrasives.
- **Finding a suitable location**
  - Place the player on a flat, hard, and stable surface.
- **Disc handling**
  - To clean a CD, wipe it in a straight line from the center towards the edge using a soft, lint-free cloth. A cleaning agent may damage the disc!
  - Write only on the printed side of a CDR(W) and only with a soft felt-tipped pen.
  - Handle the disc by its edge, do not touch the surface.

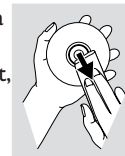



## Connections

English

### Connecting TV

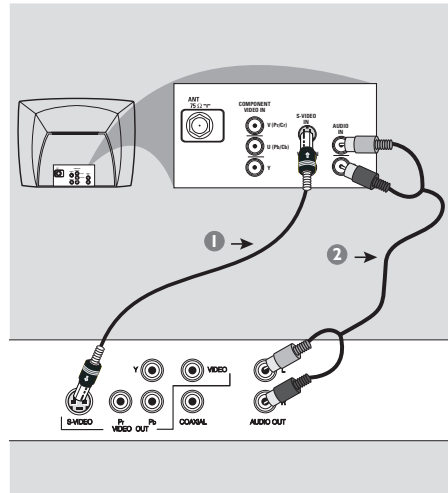
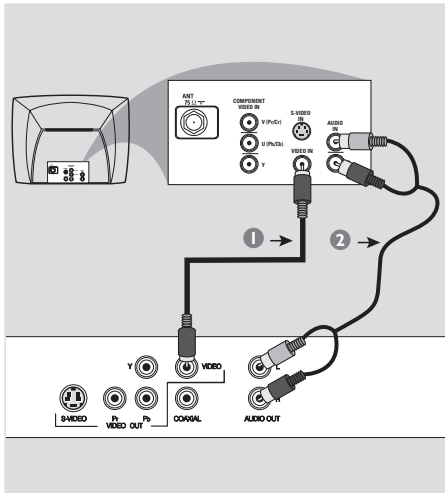

#### IMPORTANT!

- You only need to make one video connection from the following options, depending on the capabilities of your TV system.
- Connect the DVD system directly to the TV.

#### Using Composite Video jacks (CVBS)

- 1 Use the composite video cable (yellow) to connect the DVD Player's CVBS (VIDEO) jack to the video input jack (or labeled as A/V In, Video In, Composite or Baseband) on the TV (*cable not supplied*).
- 2 To hear the sound of this DVD Player through your TV, use the audio cables (white/red) to connect AUDIO OUT (L/R) jacks of the DVD Player to the corresponding AUDIO IN jacks on the TV (*cable not supplied*).

#### IMPORTANT!

- S-Video connection provides better picture quality. This option must be available on your TV.

#### Using S-Video jack

- 1 Use the S-video cable to connect the DVD system's **S-VIDEO OUT** jack to the S-Video input jack (or labeled as Y/C or S-VHS) on the TV (*cable not supplied*).
- 2 To hear the sound of this DVD Player through your TV, use the audio cables (white/red) to connect AUDIO OUT (L/R) jacks of the DVD Player to the corresponding AUDIO IN jacks on the TV (*cable not supplied*).



## Connections

English

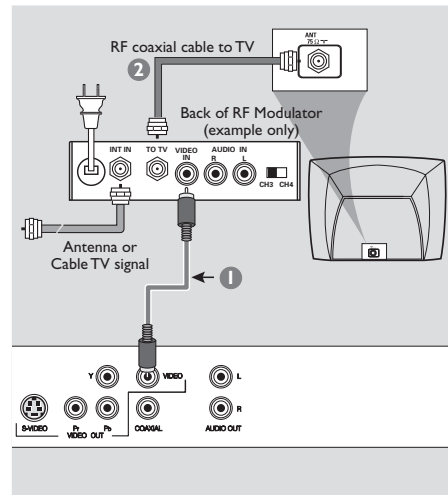
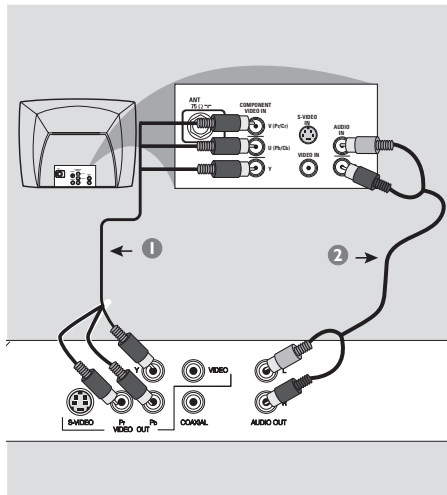

### IMPORTANT!

- **Component Video connection** provides higher picture quality. This option must be available on your TV.
- The progressive scan video quality is only possible through Component Video (Y Pb Pr) output.

#### Using Component Video jacks (Y Pb Pr)

- 1 Use the component video cables (green/blue/red) to connect the DVD system's **Y Pb Pr** jacks to the corresponding Component video input jacks (or labeled as **Y Pb Pr**) on the TV (*cable not supplied*).
- 2 To hear the sound of this DVD Player through your TV, use the audio cables (white/red) to connect AUDIO OUT (L/R) jacks of the DVD Player to the corresponding AUDIO IN jacks on the TV (*cable not supplied*).

### IMPORTANT!

- If your TV only has a single Antenna In jack (or labeled as 75 ohm or RF In,) you will need an RF modulator in order to view the DVD playback on the TV. See your electronics retailer or contact for details on RF modulator availability and operations.

#### Using an accessory RF modulator

- 1 Use the composite video cable (yellow) to connect the DVD Player's **CVBS** jack to the video input jack on the RF modulator.
- 2 Use the RF coaxial cable (not supplied) to connect the RF modulator to your TV's RF jack.



## Connections

English

### Connecting the power cord

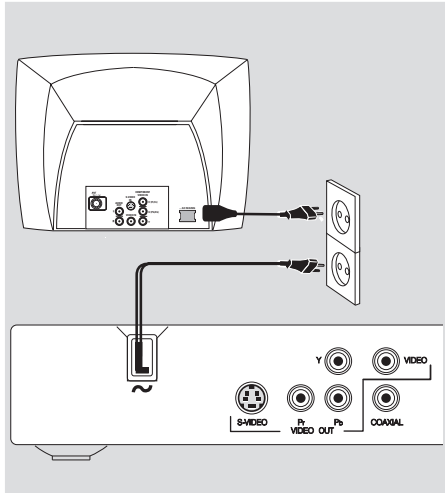

### Optional: Connecting to an Audio System

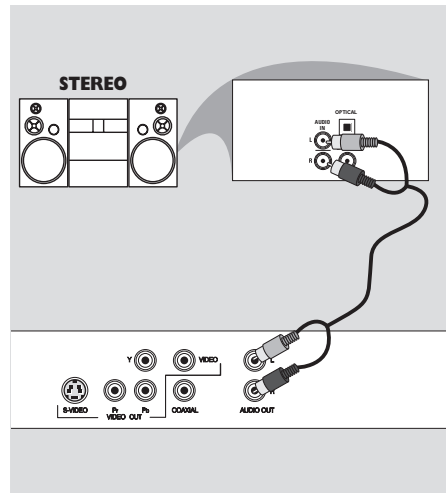

After everything is connected properly, plug in the AC power cord to the power outlet.

Never make or change any connections with the power switched on.

When no disc is loaded, press **STANDBY ON** on the DVD Player front panel, "NO DISC" may appear on the display panel.

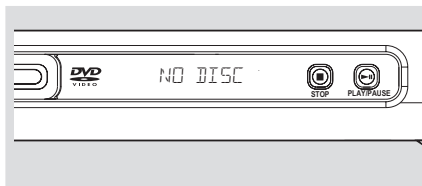

Stereo system has Dolby Pro Logic or Right / Left Audio In jack

- 1 Select one of the video connections (CVBS VIDEO IN, S-VIDEO IN, SCART or COMPONENT VIDEO IN) depending on the options available on your TV.
- 2 Use the audio cables (white/red) to connect **AUDIO OUT (L/R)** jacks of the DVD Player to the corresponding **AUDIO IN** jacks on the stereo system (cable not supplied).





## Connections

### Optional: Connecting Digital AV Receiver

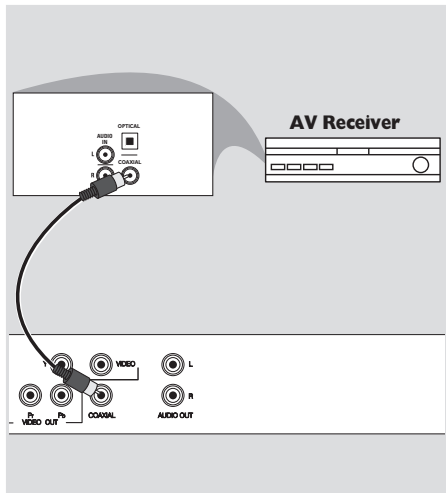

English

#### Receiver has a PCM, Dolby Digital, or MPEG2 decoder

- 1 Select one of the video connections (CVBS VIDEO IN, S-VIDEO IN, SCART or COMPONENT VIDEO IN) depending on the options available on your TV.
- 2 Connect the COAXIAL jack of the DVD Player to the corresponding Digital Audio In jack on your Receiver (*cable not supplied*).
- 3 Set the DVD Player's Digital Output to PCM or ALL depending on the capabilities of your Receiver (*see page 23 "Digital Output"*).

#### Helpful Hint:

– If the audio format of the Digital Output does not match the capabilities of your receiver, the receiver will produce a strong, distorted sound or no sound at all.



## Functional Overview

English

### Front and Rear Panels

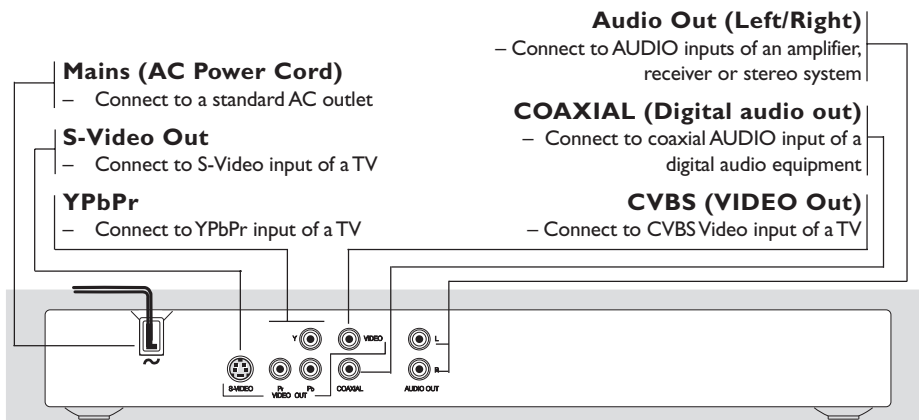
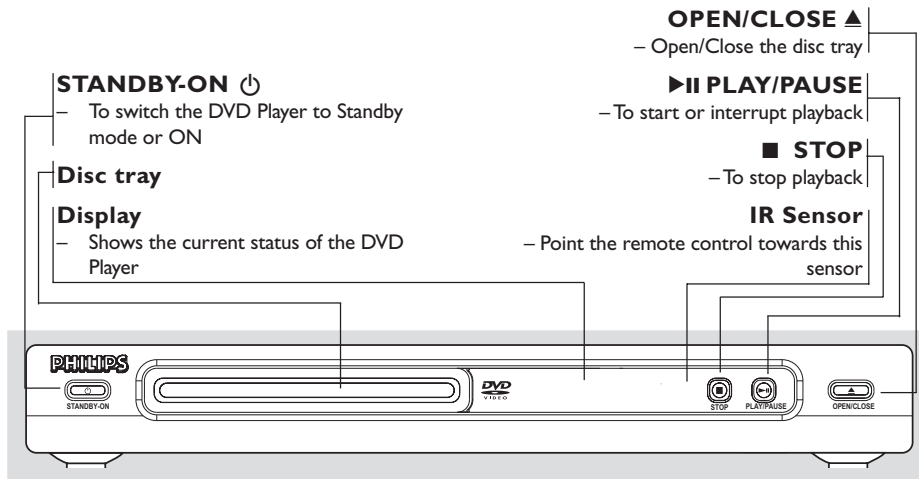

**Caution: Do not touch the inner pins of the jacks on the rear panel. Electrostatic discharge may cause permanent damage to the unit.**



## Functional Overview

### Remote Control

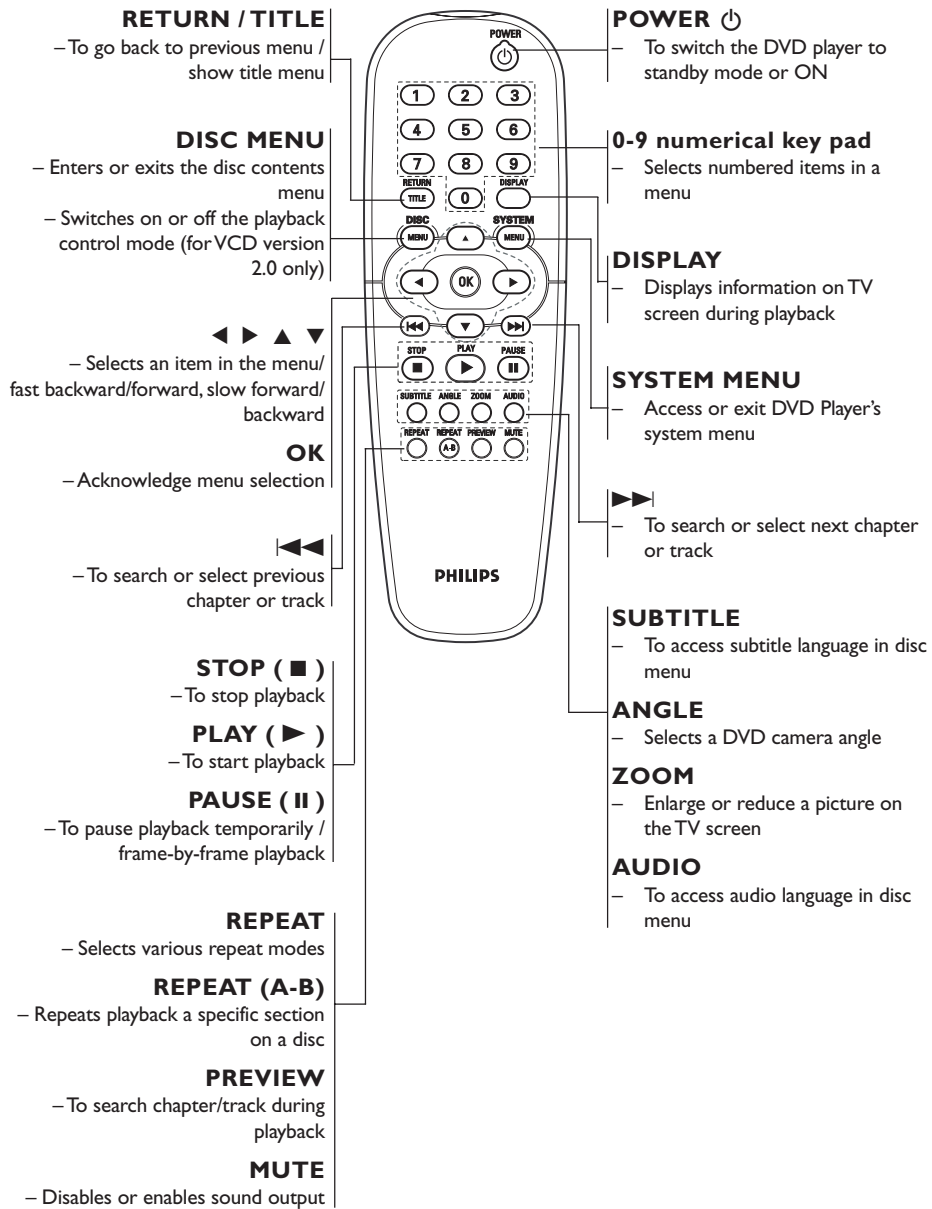

English

**Helpful Hint:**  
Press "STOP" for about 2 seconds to OPEN or CLOSE disc tray.





## Getting Started

### Step 1: Inserting batteries into the Remote Control

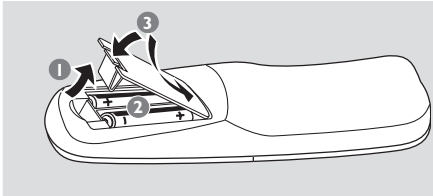

- 1 Open the battery compartment.
- 2 Insert two batteries type R06 or AA, following the indications (+ -) inside the compartment.
- 3 Close the cover.

### Using the Remote Control to operate the Player

- 1 Aim the Remote Control directly at the remote sensor (iR) on the front panel.
- 2 Do not put any objects between the Remote Control and the DVD Player while operating the DVD Player.



### CAUTION!

- Remove batteries if they are exhausted or if the Remote Control is not being used for a long time.
- Do not use old and new or different types of batteries in combination.
- Batteries contain chemical substances, so they should be disposed properly.

### Step 2: Setting up the TV

#### IMPORTANT!

Make sure you have completed all the necessary connections. (See page 6-7 "Connecting TV").

- 1 Turn on the TV and set to the correct video-in channel. You should see the DVD background screen on the TV.
- 2 Usually these channels are between the lowest and highest channels and may be called FRONT, A/V IN, or VIDEO. See your TV manual for more details.  
→ Or, you may go to channel 1 on your TV, then press the Channel down button repeatedly until you see the Video In channel.  
→ Or, the TV Remote Control may have a button or switch that chooses different video modes.  
→ Or, set the TV to channel 3 or 4 if you are using an RF modulator.
- 3 If you are using external equipment, (eg. audio system or receiver), turn it on and select the appropriate input source for the DVD Player output. Refer to the equipment owner's manual for detail.

### To deactivate Progressive manually

- **When the distorted picture still appears on the TV**, it may be due to the connected TV does not accept progressive signals, and progressive is set by mistake. You must reset the unit to interlace format.
  - 1 **Turn off** your TV progressive scan mode or turn on to interlaced mode (refer to your TV user manual.)
  - 2 Press **OPEN/CLOSE** on the DVD player to open the disc tray.
  - 3 Press **numeric keypad '1'** on the remote control for few seconds.  
→ The DVD blue background screen will appear on the TV.



## Getting Started

### Selecting the color system that corresponds to your TV

This DVD Player is compatible with both NTSC and PAL. In order for a DVD disc to play on this Player, the color system of the Disc, the TV and the DVD Player should match.

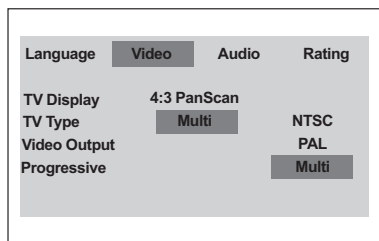

- 1 Press **SYSTEM MENU**.
- 2 Press **▶** repeatedly to select {VIDEO SETUP}, then press **OK**.
- 3 Press **▲▼** to highlight {TV TYPE}.
- 4 Enter its submenu by pressing **OK**.
- 5 Press **▲▼** to highlight one of the options below:

**PAL** – Select this if the connected TV is PAL system. It will change the video signal of a NTSC disc and output in PAL format.

**NTSC** – Select this if the connected TV is NTSC system. It will change the video signal of a PAL disc (VCD only) and output in NTSC format.

**Multi** – Select this if the connected TV is compatible with both NTSC and PAL (multi-system). The output format will be in accordance with the video signal of the disc.

- 6 Select an item and press **OK**.  
→ Follow the instructions show on the TV to confirm the selection (if any).  
→ If a blank/distorted TV screen appears, wait for 15 seconds for auto recovery.

### Setting the TV Display

Set the aspect ratio of the DVD Player according to the TV you have connected. The format you select must be available on the disc. If it is not, the setting for TV display will not affect the picture during playback.

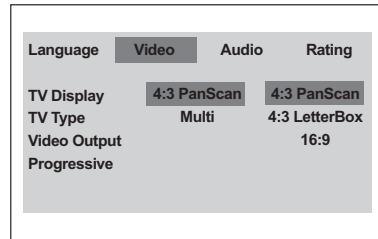

- 1 Press **SYSTEM MENU**.
- 2 Press **▶** repeatedly to select {VIDEO SETUP}, then press **OK**.
- 3 Press **▲▼** to highlight {TV DISPLAY}.
- 4 Enter its submenu by pressing **OK**.
- 5 Press **▲▼** to highlight one of the options below:

**4:3 PANSCAN** –

Select this if you have a normal TV and want both sides of the picture to be trimmed or formatted to fit your TV screen.



**4:3 LETTERBOX** –

Select this if you have a normal TV. In this case, a wide picture with black bands on the upper and lower portions of the TV screen will be displayed.



**16:9** – Select this if you have a wide-screen TV.



- 6 Select an item and press **OK**.

**TIPS:** To return to the previous menu, press **OK**.  
To remove the menu, press **SYSTEM MENU**.



## Getting Started

English

### Step 3: Setting language preference

You can select your preferred language settings. This DVD Player will automatically switch to the language for you whenever you load a disc.

#### Setting the OSD Language

The On-screen language for the system menu will remain as you set it, regardless of various disc languages.

Language	Video	Audio	Rating
OSD Menu		English	
Subtitle		Off	
Audio		English	
DVD Menu		English	

- 1 Press **SYSTEM MENU**.
- 2 Press **▶** to select {LANGUAGE}, then press **OK**.
- 3 Press **▲▼** to highlight {OSD MENU}.
- 4 Enter its submenu by pressing **OK**.
- 5 Press **▲▼** to select a language and press **OK**.

### Setting the Audio, Subtitle and DVD menu language

You can choose your own preferred language or soundtrack from audio, subtitles and DVD menu languages. If the language selected is not available on the disc, the disc's default language will be used instead.

Language	Video	Audio	Rating
OSD Menu		English	
Subtitle		Off	
Audio		English	
DVD Menu		English	

- 1 Press **SYSTEM MENU**.
- 2 Press **▶** to select {LANGUAGE}, then press **OK**.
- 3 Press **▲▼** to highlight one of the options below at a time, then press **OK**.
  - 'Subtitle' (disc's subtitles)
  - 'Audio' (disc's soundtrack)
  - 'DVD Menu' (disc's menu)
- 4 Press **▲▼** to select a language and press **OK**.
- 5 Repeat steps 3~4 for other language settings.

**TIPS:** To return to the previous menu, press **OK**.  
To remove the menu, press **SYSTEM MENU**.



## Disc Operations

### IMPORTANT!

- Depending on the DVD or VIDEO CD, some operations may be different or restricted.
- Do not push on the disc tray or put any objects other than disc on the disc tray. Doing so may cause the disc player malfunction.

### Playable Discs

#### Your DVD Player will play:

- Digital Versatile Discs (DVDs)
- Video CDs (VCDs)
- Digital Video Discs + Recordable [Rewritable] (DVD+R[W])
- Compact Discs (CDs)
- MP3 discs, picture (JPEG) files on CD-R(W).
  - JPEG/ISO 9660 format
  - Maximum 9 characters display.
  - Supported sampling frequencies : 32 kHz, 44.1 kHz, 48 kHz (MPEG-1) 16 kHz, 22.05 kHz, 24 kHz (MPEG-2)
  - Supported Bit-rates : 32~256 kbps (MPEG-1), 8~160 kbps (MPEG-2) variable bitrates

### Region Codes

This DVD Player is designed to support the Region Management System. Check the regional code number on the disc package. If the number does not match the Player's region number (see table below), the Player may be unable to playback the disc.

Region	Region number of the unit	Discs that can be played (Example)
U.S.A. and Canada regions	1	ALL 1
U.K and Europe regions	2	ALL 2
Asia Pacific regions	3	ALL 3
Australia region	4	ALL 4
China region	6	ALL 6



### Helpful Hints:

- It may not be possible to play CD-R/RW or DVD-R/RW in all cases due to the type of disc or condition of the recording.
- Unfinalised discs should have the last session closed before playing.
- If you are having trouble playing a certain disc, remove the disc and try a different one. Improper formatted disc will not play on this DVD Player.

**TIPS:** The operating features described here might not be possible for certain discs. Always refer to the instructions supplied with the discs.





## Disc Operations

### IMPORTANT!

If the inhibit icon (Ø) appears on the TV screen when a button is pressed, it means the function is not available on the current disc or at the current time.

### Playing discs

- 1 Connect the power cords of the DVD Player and TV (and any optional stereo or AV receiver) to a power outlet.
- 2 Turn on the TV power and set to the correct Video In channel. (See page 12 "Setting up the TV").
- 3 Press **STANDBY-ON** on the DVD Player front panel.  
→ You should see the DVD background screen on the TV.
- 4 Press **OPEN/CLOSE ▲** button to open the disc tray and load in a disc, then press the same button again to close the disc tray.  
→ Make sure the label side is facing up. For double-sided discs, load the side you want to play facing up.
- 5 Playback will start automatically. If not press **PLAY ►**.  
→ If a disc menu appears on the TV, see "Using the Disc Menu".  
→ If the disc is locked by parental control, you must enter your four-digit password. (See page 25).
- 6 At any time, simply press **STOP** to stop playback.

### Using the Disc Menu

Depending on the disc, a menu may appear on the TV screen once you load the disc.

#### To select a playback feature or item

- Use the ◀▶▲▼ or **numeric keypad (0-9)** on the Remote Control, then press **PLAY ►** to start playback.

#### To access or exit from the menu

- Press **DISC MENU** on the Remote Control.

#### For VCD with Playback Control (PBC) feature (version 2.0 only)

PBC playback allows you to play Video CDs interactively, following the menu on the display.

- In stop mode, use the **numeric keypad (0-9)** to select a track and PBC will turn off.  
→ Playback will start automatically
- During playback, press **DISC MENU**;  
→ If PBC was ON, it will switch to OFF and continue playback.  
→ If PBC was OFF, it will switch to ON and return to menu screen.
- During playback, pressing **RETURN/TITLE** will return to the menu screen (if PBC is on).





## Disc Operations

### Basic playback controls

Unless otherwise stated, all operations described are based on the use of Remote Control.

#### Pausing playback (DVD/VCD/CD/MP3)

- 1 During playback, press **PAUSE II**.  
→ Playback will pause and sound will be muted.
- 2 Press **PAUSE II** again to select the next picture frame.
- 3 To return to normal playback, press **PLAY ►**.

#### Selecting track/chapter (DVD/VCD/CD)

- 1 Press **►►** briefly during playback to go to the next chapter/track
- 2 Press **◄◄** to go to the previous track or return chapter.
- 3 To go directly to any chapter/track, enter the chapter/track number using the numerical keys (0-9).

#### Resuming playback from the last stopped point (DVD/VCD/CD)

Resume playback of the last five discs, even if the disc was removed from the Player.

- To memorise the last stop point, press **OPEN/CLOSE** button during playback.
- Press **PLAY ►** and the disc will play from the last point.
- Press **STOP ■** to cancel the resume mode.

#### Zoom (DVD/VCD/JPEG)

Zooming allows you to enlarge or reduce the video image during playback.

- 1 Press **ZOOM** repeatedly to increase or to return to the original size.
- 2 Press **◄► ▲ ▼** to pan across the TV screen.

#### Repeat (DVD/VCD)

- Press **REPEAT** continuously to choose a Repeat mode during playback.

##### REPEAT CHAPTER (DVD)

– to repeat playback of the current chapter.

##### REPEAT TITLE (DVD)

– to repeat playback of the current title.

##### REPEAT SINGLE (VCD)

– to repeat playback of the current track.

##### REPEAT ALL (VCD)

– to repeat playback of all the disc.

##### OFF (DVD/VCD)

– to cancel the repeat mode.

##### Helpful Hint:

– *REPEAT function is not available for VCD 2.0 when PCB is on.*

#### Repeat A-B (DVD/VCD/CD)

- 1 Press **REPEAT A-B** at your chosen starting point.
- 2 Press **REPEAT A-B** again at your chosen end point.  
→ The section will now repeat continuously.
- 3 To exit the sequence, press **REPEAT A-B**.

**TIPS:** The operating features described here might not be possible for certain discs. Always refer to the instructions supplied with the discs.



## Disc Operations

### Slow Motion (DVD/VCD)

- 1 Press **▲▼** during playback to select the required speed: 1/2, 1/4, 1/8 or 1/16 (backward or forward).  
→ Sound will be muted.
- 2 To return to normal speed, press **PLAY ►**.

### Forward / Reverse Searching (DVD/VCD/CD)

- 1 Press **◀▶** during playback to select the required speed: 2X, 4X, 8X or 16X (backward or forward).  
→ Sound will be muted (DVD/VCD) or intermittent (CD).
- 2 To return to normal speed, press **PLAY ►**.

### Preview (DVD/VCD)

The Time Search function allows you to start playing at any chosen time on the disc.

- 1 Press **PREVIEW**.
- 2 Use **►** keys to select an option.
- 3 Enter hours, minutes and seconds from left to right in the time edit box using remote control numerical key pad.

#### For DVD

- Time (example - 00:34:27)
- Title/Chapter (example - 000/008)

#### For VCD

- Track Search (example - 00:30:00)
- Track (example - 001/009)

- 4 Press the **OK** key to confirm.  
→ Playback starts from the selected time on the disc.

**TIPS:** The operating features described here might not be possible for certain discs. Always refer to the instructions supplied with the discs.



## Disc Operations

### Special DVD features

#### Selecting a title

Some DVDs may contain several titles. If the disc has a title menu recorded on it, you can start playback from the selected movie title.

- 1 Press **DISC MENU**.  
→ The disc title menu appears on the TV screen.
- 2 Use **▲▼◀▶** keys or **numeric keypad (0-9)** to select a title.
- 3 Press **OK** key to confirm.

#### Camera Angle

If the disc contains sequences recorded from different angle, this allows you to view picture from different angle.

- Press **ANGLE** repeatedly to select different desired angle.  
→ Playback changes to the selected angle.

#### Changing the Audio Language

- Press **AUDIO** repeatedly to select different audio languages.

#### Subtitles

- Press **SUBTITLE** repeatedly to select different subtitle languages.

### Playing MP3/JPEG Picture CD

This player can playback MP3, JPEG, or Picture CD files on a personally recorded CD-R/RW disc or commercial CD.

#### IMPORTANT!

You have to turn on your TV and set to the correct Video In channel. (See page 12 "Setting up the TV").

#### General Operation

- 1 Load a disc.  
→ The playback will start automatically.
- Press **STOP** to display disc menu on the TV screen.
- 2 Use **▲▼** to select the folder and press **OK** to open the folder.

JPEG		6/103
Images		
1. image 1	8. image 8	
2. image 2	9. image 9	
3. image 3	10. image 10	
4. image 4	11. image 11	
5. image 5	12. image 12	
6. image 6	13. image 13	
7. image 7	14. image 14	

MP3		1/10
MP3		
1. music 1	8. music 8	
2. music 2	9. music 9	
3. music 3	10. music 10	
4. music 4		
5. music 5		
6. music 6		
7. music 7		

- 3 Press **▲▼** or use the numeric keypad (0-9) to highlight an option.
- 4 Press **OK** to confirm.

**TIPS:** The operating features described here might not be possible for certain discs. Always refer to the instructions supplied with the discs.



## Disc Operations

### Playback selection

During playback, you can;

- Press |◀◀/▶▶| to select another file in the current folder.
- Use ◀▶▲▼ on the remote to rotate/flip the picture files.
- Press II / ▶ repeatedly to pause/resume playback.

### Repeat

- Press **REPEAT** continuously to access different 'Play Mode'.

#### REPEAT SINGLE

– to repeat playback of the current file.

#### REPEAT ALL

– to repeat playback of all files in the disc.

#### OFF

– to cancel the repeat mode.

### Zoom picture (JPEG)

- During playback, press **ZOOM** repeatedly to display the picture with different scales.
- Use ◀▶▲▼ to view the zoomed picture.

### Playback with multi-angles (JPEG)

- During playback, press ▲▼◀▶ to rotate the picture on the TV screen.  
▲: rotate the picture vertically by 180°  
▼: rotate the picture horizontally by 180°  
◀: rotate the picture anti-clockwise by 90°  
▶: rotate the picture clockwise by 90°

### Scan Effect (JPEG)

- Press **ANGLE** repeatedly to choose different scan effect.  
→ Various scan effect appears on the top left hand corner on the TV screen.

**TIPS:** The operating features described here might not be possible for certain discs. Always refer to the instructions supplied with the discs.



## DVD Setup Menu Options

This DVD Player setup is carried out via the TV, enabling you to customise the DVD Player to suit your particular requirements.

### Language

- 1 Press **SYSTEM MENU**.
- 2 Press **▶** to select {LANGUAGE}.
- 3 Press **OK** to confirm.

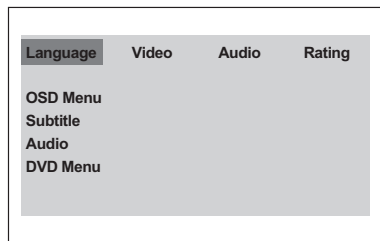

### OSD Menu

This menu contains various language options for display language on the screen. For details, see page 14.

### Audio, Subtitle, DVD Menu

These menus contain various language options for audio, subtitle and DVD menu which may be recorded on the DVD disc. For details, see page 14.

### Video Setup

- 1 Press **SYSTEM MENU**.
- 2 Press **▶** repeatedly to select {VIDEO}.
- 3 Press **OK** to confirm.

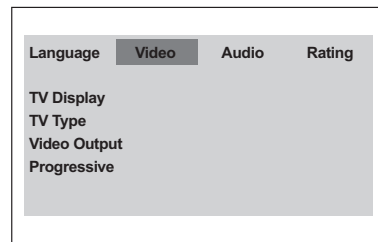

### TV Display

This menu contains the options for setting the aspect ratio of the DVD Player according to the connected TV. For details, see page 13.

### TV Type

This menu contains the options for selecting the color system that matches the connected TV. For details, see page 13.

English

**TIPS:** To return to the previous menu, press **OK**.  
To remove the menu, press **SYSTEM MENU**.



## DVD Setup Menu Options

### Setting the Video Output

Choose the type of video output that matches the video connection between the DVD Player and your TV.

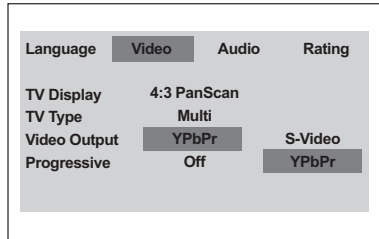

- 1 In 'VIDEO SETUP', press **OK** to enter the submenu.
- 2 Press **▲▼** to highlight {VIDEO OUTPUT}, then press **OK**.
- 3 Press **▲▼** to highlight one of the options below:

#### **S-VIDEO**

Select this if you have connected the DVD Player to your TV using S-Video jack.

#### **YPbPr**

Select this if you have connected the DVD Player to your TV using component video output jack.

- 4 Select an item and press **OK**.

### Progressive – turning on/off

This feature is only applicable if you have connected this DVD Player to a Progressive Scan TV through the Y Pb Pr jacks (see page 7).

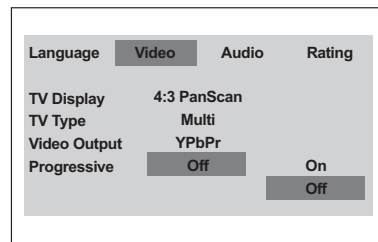

- 1 In 'VIDEO SETUP', press **OK** to enter the submenu.
- 2 Press **▲▼** to highlight {PROGRESSIVE}, then press **OK**.
- 3 Press **▲▼** to highlight one of the options below:

#### **ON**

To enable Progressive Scan function.

#### **OFF**

To disable Progressive Scan function.

- 4 Select an item and press **OK**.
  - Follow the instructions show on the TV to confirm the selection (if any).
  - If a blank/distorted TV screen appears, wait for 15 seconds for auto recovery.

**TIPS:** To return to the previous menu, press **OK**.  
To remove the menu, press **SYSTEM MENU**.



## DVD Setup Menu Options

### Audio Setup

- 1 Press **SYSTEM MENU**.
- 2 Press **▶** repeatedly to select {AUDIO SETUP}.
- 3 Press **OK** to confirm.

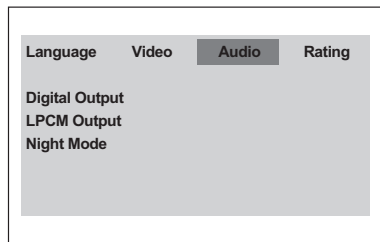

### Digital Output

Set the Digital output according to your optional audio equipment connection.

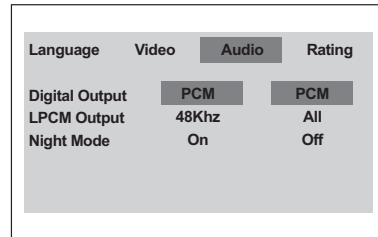

- 1 In 'AUDIO SETUP', press **OK** to enter the submenu.
- 2 Press **▲▼** to highlight {DIGITAL OUTPUT}, then press **OK**.
- 3 Press **▲▼** to highlight one of the options below:

#### **OFF**

Turn off the digital output.

#### **ALL**

If you have connected your DIGITAL AUDIO OUT to a multi-channel decoder/receiver.

#### **PCM**

Only if your receiver is not capable of decoding multi-channel audio.

- 4 Select an item and press **OK**.

#### *Helpful Hint:*

- If DIGITAL OUTPUT is set to 'All', all audio settings except MUTE are invalid.

English

**TIPS:** To return to the previous menu, press **OK**.  
To remove the menu, press **SYSTEM MENU**.



## DVD Setup Menu Options

### LPCM Output

If you connect the DVD Player to a PCM compatible receiver via the digital terminals, such as coaxial or optical etc, you may need to adjust 'LPCM Output'. Discs are recorded at a certain sampling rate. The higher the sampling rate, the better the sound quality.

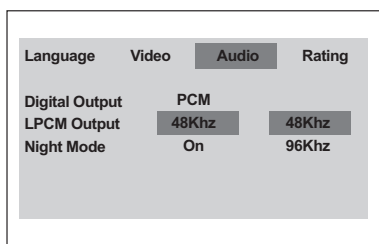

- 1 In 'AUDIO SETUP', press **OK** to enter the submenu.
- 2 Press **▲▼** to highlight {LPCM Output}, then press **OK**.
- 3 Press **▲▼** to highlight one of the options below:

#### **48kHz**

Playback a disc recorded at the sampling rate of 48kHz.

#### **96kHz**

Playback a disc recorded at the sampling rate of 96kHz that can only be achieved in Stereo-Classic mode.

- 4 Select an item and press **OK**.

#### *Helpful Hint:*

- *LPCM Output can be selected only when PCM is activated.*

### Night Mode - turning on/off

In this mode, the high volume outputs are softened and low volume outputs are brought upward to an audible level. It is useful for watching your favourite action movie without disturbing others at night.

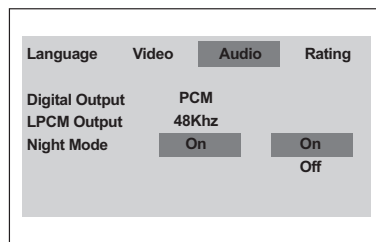

- 1 In 'AUDIO SETUP', press **OK** to enter the submenu.
- 2 Press **▲▼** to highlight {Night Mode}, then press **OK**.
- 3 Press **▲▼** to highlight one of the options below:

#### **ON**

Select this to level out the volume. This feature is only available for movies with Dolby Digital mode.

#### **OFF**

Select this when you want to enjoy the surround sound with its full dynamic range.

- 4 Select an item and press **OK**.

**TIPS:** To return to the previous menu, press **OK**.  
To remove the menu, press **SYSTEM MENU**.





## DVD Setup Menu Options

### Rating

- 1 Press **SYSTEM MENU**.
- 2 Press **▶** repeatedly to select {RATING}.
- 3 Press **OK** to confirm.

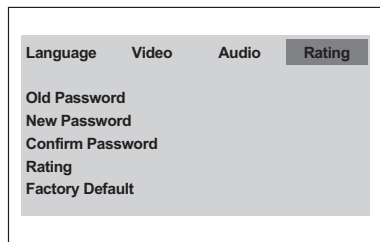

### Changing the Password

The same password is used for both Parental Control. Enter your four digit password when prompted on the screen. The default password is **0000**.

- 1 In 'RATING', press **OK** to enter the submenu.
- 2 Use the **numeric keypad (0-9)** to enter your old four-digit password.  
→ When doing this for the first time, key in '0000'.  
→ If you forget your old four-digit password, key in '0000'.
- 3 Enter the new four-digit password.
- 4 Enter the new four-digit password a second time to confirm.  
→ The new four-digit password will now take effect.

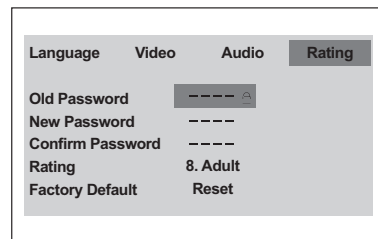

- 5 Press **OK** to confirm.

**TIPS:** To return to the previous menu, press **OK**.  
To remove the menu, press **SYSTEM MENU**.



## DVD Setup Menu Options

### Setting the Rating

Some DVDs may have a parental level assigned to the complete disc or to certain scenes on the disc. This feature lets you set a playback limitation level. The rating levels are from 1 to 8 and are country dependent. You can prohibit the playing of certain discs that are not suitable for your children or have certain discs played with alternative scenes.

- 1 In 'RATING', press **OK** to enter the submenu.
- 2 Press **▲▼** to highlight {RATING}, then press **OK** to select a rating level for the disc inserted.  
→ To disable rating controls and have all Discs play, select {8 ADULT}.
- 3 Use the **numeric keypad (0-9)** to enter the four-digit password (see page 25 "Changing the password").  
→ DVDs that are rated above the level you selected will not play unless you enter your four-digit password.

#### Helpful Hints:

- VCD, CD have no level indication, so parental control function has no effect on these type of discs. This applies to most illegal DVD discs.
- Some DVDs are not encoded with a rating though the movie rating may be printed on the Disc cover. The rating level feature does not work for such Discs.

### Rating explanations

#### 1 KID SAFE

- Kids material; recommended especially for children and viewers of all ages.

#### 2 G

- General Audience; recommended as acceptable for viewers of all ages.

#### 3 PG

- Parental Guidance suggested.

#### 4 PG13

- Material is unsuitable for children under age 13.

#### 5-6 PG-R

- Parental Guidance - Restricted; recommended that parents restrict children under 17 from viewing or allow to view only when supervised by a parent or adult guardian.

#### 7 NC-17

- No children under age 17; not recommended viewing for children under age 17.

#### 8 ADULT

- Mature material; should be viewed only by adults due to graphic sexual material, violence or language.

### Restoring to original settings

Setting the 'Default' function will reset all options and your personal settings to the factory defaults and all your personal settings will be erased.

- 1 In 'RATING', press **OK** to enter the submenu.
- 2 Press **▲▼** to highlight {DEFAULT}, then select {RESET}.
- 3 Press **OK** to confirm.  
→ All settings will now reset to factory defaults.

**TIPS:** To return to the previous menu, press **◀**.  
To remove the menu, press **SYSTEM MENU**.



## Specifications

English

### TV STANDARD (PAL/50Hz) (NTSC/60Hz)

Number of lines	625	525
Playback	Multistandard	(PAL/NTSC)

### VIDEO PERFORMANCE

DA Converter	12 bit, 54MHz	
Video Output	1Vpp — 75 ohm	
S-Video Output	Y: 1Vpp — 75 ohm	
	C: 0.3 Vpp — 75 ohm	
YPbPr Output	0.7 Vpp — 75 ohm	

### AUDIO FORMAT

Digital	MPEG	compressed Digital
	PCM	16, 20, 24 bits
		fs, 44.1, 48, 96 kHz
MP3(ISO 9660)		96, 112, 128, 256
		kbps & variable
		bit rate fs, 32, 44.1,
		48 kHz

Analog Sound Stereo  
Dolby Surround compatible downmix from Dolby Digital multi-channel sound

### AUDIO PERFORMANCE

DA Converter	24 bit, 192 kHz	
DVD	fs 96 kHz	4Hz- 44kHz
	fs 48 kHz	4Hz- 22kHz
CD/VCD	fs 44.1kHz	4Hz- 20kHz
Signal-Noise (1kHz)	90 dB	
Dynamic range(1kHz)	90 dB	
Crosstalk (1kHz)	100 dB	
Distortion/noise (1kHz)	80 dB	
MPEG MP3	MPEG Audio L3	

### CONNECTIONS

YPbPr Output	Cinch 3x
S-Video Output	Mini DIN, 4 pins
Video Output	Cinch (yellow)
Audio Output(L+R)	Cinch (white/red)
Digital Output	1 coaxial
	IEC60958 for CDDA / LPCM
	IEC61937 for MPEG 1/2,
	Dolby Digital

### CABINET

Dimensions (w x h x d)	360 x 50 x 285 mm
Weight	Approximately 2.2 kg

### POWER CONSUMPTION

Power Supply Rating	110 – 127 / 220 – 240V;
	50/60 Hz
Power consumption	12 W
Power consumption in Standby mode	< 2 W

Specifications subject to change without prior notice



## Troubleshooting

### WARNING

Under no circumstances should you try to repair the system yourself, as this will invalidate the warranty. Do not open the system as there is a risk of electric shock.

If a fault occurs, first check the points listed below before taking the system for repair.

Problem	Solution
<b>No power</b>	<ul style="list-style-type: none"> <li>– Check if the AC power cord is properly connected.</li> <li>– Press the STANDBY ON on the front of the DVD system to turn on the power.</li> </ul>
<b>No picture</b>	<ul style="list-style-type: none"> <li>– Refer to your TV's manual for correct Video In channel selection. Change the TV channel until you see the DVD screen.</li> <li>– Check if the TV is switched on.</li> </ul>
<b>Distorted picture</b>	<ul style="list-style-type: none"> <li>– Sometimes a small amount of picture distortion may appear depending on the disc being played back. This is not a malfunction.</li> </ul>
<b>Completely distorted picture or black/white picture with DVD</b>	<ul style="list-style-type: none"> <li>– Connect DVD Player directly to the TV.</li> <li>– Make sure the disc is compatible with the DVD/ Player.</li> <li>– Ensure that the DVD Player's TV Type is set to match that of the Disc and your TV.</li> </ul>
<b>No sound or distorted sound</b>	<ul style="list-style-type: none"> <li>– Adjust the volume.</li> <li>– Check that the speakers are connected correctly.</li> </ul>
<b>No audio at digital output</b>	<ul style="list-style-type: none"> <li>– Check the digital connections.</li> <li>– Check if your receiver can decode MPEG-2 or DTS and if not, please make sure the digital output is set to PCM.</li> <li>– Check if the audio format of the selected audio language matches your receiver capabilities.</li> </ul>
<b>Disc can't be played</b>	<ul style="list-style-type: none"> <li>– The DVD+R/CD-R must be finalised.</li> <li>– Ensure the disc label is facing up.</li> <li>– Check if the disc is defective by trying another disc.</li> <li>– If you have recorded a Picture CD or MP3 CD yourself, ensure that your disc contains at least 10 pictures or 5 MP3 tracks.</li> <li>– Region code incorrect.</li> </ul>
<b>Picture freezes momentarily during playback</b>	<ul style="list-style-type: none"> <li>– Check the disc for fingerprints/scratches and clean with a soft cloth wiping from centre to edge.</li> </ul>
<b>No return to start-up screen when disc is removed</b>	<ul style="list-style-type: none"> <li>– Reset the unit by switching the player off, then on again.</li> </ul>
<b>The player does not respond to the Remote Control</b>	<ul style="list-style-type: none"> <li>– Aim the Remote Control directly at the sensor on the front of the player.</li> </ul>



## Troubleshooting

Problem	Solution
<p><b>Buttons do not work</b></p>	<ul style="list-style-type: none"> <li>- Reduce the distance to the player.</li> <li>- Replace the batteries in the Remote Control.</li> <li>- Re-insert the batteries with their polarities (+/- signs) as indicated.</li> </ul>
<p><b>Player does not respond to some operating commands during playback.</b></p>	<ul style="list-style-type: none"> <li>- To completely reset the player, unplug the AC cord from the AC outlet for 5-10 seconds.</li> <li>- Operations may not be permitted by the disc. Refer to the instructions of the disc jacket.</li> </ul>
<p><b>DVD Player cannot read CDs/DVDs</b></p>	<ul style="list-style-type: none"> <li>- Use a commonly available cleaning CD/DVD to clean the lens before sending the DVD Player for repair.</li> </ul>
<p><b>Menu items cannot be selected</b></p>	<ul style="list-style-type: none"> <li>- Press STOP twice before selecting System Menu.</li> <li>- Depending on the disc availability, some menu items cannot be selected.</li> </ul>

English





## Glossary

**Analog:** Sound that has not been turned into numbers. Analog sound varies, while digital sound has specific numerical values. These jacks send audio through two channels, the left and right.

**Aspect ratio:** The ratio of vertical and horizontal sizes of a displayed image. The horizontal vs. vertical ratio of conventional TVs is 4:3, and that of wide-screens is 16:9.

**AUDIO OUT Jacks:** Jacks on the back of the DVD System that send audio to another system (TV, Stereo, etc.).

**Bit Rate:** The amount of data used to hold a given length of music; measured in kilobits per seconds, or kbps. Or, the speed at which you record. Generally, the higher the bit rate, or the higher the recording speed, the better the sound quality. However, higher bit rates use more space on a Disc.

**Chapter:** Sections of a picture or a music piece on a DVD that are smaller than titles. A title is composed of several chapters. Each chapter is assigned a chapter number enabling you to locate the chapter you want.

**Component Video Out Jacks:** Jacks on the back of the DVD System that send high-quality video to a TV that has Component Video In jacks (R/G/B, Y/Pb/Pr, etc.).

**Disc menu:** A screen display prepared for allowing selection of images, sounds, subtitles, multi-angles, etc recorded on a DVD.

**Digital:** Sound that has been converted into numerical values. Digital sound is available when you use the DIGITAL AUDIO OUT COAXIAL or OPTICAL jacks. These jacks send audio through multiple channels, instead of just two channels as analog does.

**Dolby Digital:** A surround sound system developed by Dolby Laboratories containing up to six channels of digital audio (front left and right, surround left and right, center and subwoofer).

**JPEG:** A very common digital still picture format. A still-picture data compression system proposed by the Joint Photographic Expert Group, which features small decrease in image quality in spite of its high compression ratio.

**MP3:** A file format with a sound data compression system. "MP3" is the abbreviation of Motion Picture Experts Group 1 (or MPEG-1) Audio Layer 3. By using MP3 format, one CD-R or CD-RW can contain about 10 times as much data volume as a regular CD can.

**Parental Control:** A function of the DVD to limit playback of the disc by the age of the users according to the limitation level in each country. The limitation varies from disc to disc; when it is activated, playback will be prohibited if the software's level is higher than the user-set level.

**PCM (Pulse Code Modulation):** A system for converting analog sound signal to digital signal for later processing, with no data compression used in conversion.

**Playback control (PBC):** Refers to the signal recorded on video CDs or SVCDs for controlling reproduction. By using menu screens recorded on a Video CD or SVCD that supports PBC, you can enjoy interactive-type software as well as software having a search function.

**Progressive Scan:** It displays all the horizontal lines of a picture at one time, as a signal frame. This system can convert the interlaced video from DVD into progressive format for connection to a progressive display. It dramatically increases the vertical resolution.

**Region code:** A system for allowing discs to be played back only in the region designated beforehand. This unit will only play discs that have compatible region codes. You can find the region code of your unit by looking on the product label. Some discs are compatible with more than one region (or ALL regions).

**S-Video:** Produces a clear picture by sending separate signals for the luminance and the color. You can use S-Video only if your TV has S- video In jack.

**Title:** The longest section of a picture or music feature on DVD, music, etc., in video software, or the entire album in audio software. Each title is assigned a title number enabling you to locate the title you want.

**VIDEO OUT jack:** Jack on the back of the DVD System that sends video to a TV.

## Free Manuals Download Website

<http://myh66.com>

<http://usermanuals.us>

<http://www.somanuals.com>

<http://www.4manuals.cc>

<http://www.manual-lib.com>

<http://www.404manual.com>

<http://www.luxmanual.com>

<http://aubethermostatmanual.com>

Golf course search by state

<http://golfingnear.com>

Email search by domain

<http://emailbydomain.com>

Auto manuals search

<http://auto.somanuals.com>

TV manuals search

<http://tv.somanuals.com>