

DVDVideo Player



*Let's make things better.*



**PHILIPS**  
in c

# Important Note

---

## DK

### Advarsel:

Laserrudstråling ved åbning når sikkerhesafbrydere er ude af funktion. Undgå u tsættelse for stråling.

### Bemærk:

Netafbryderen POWER er sekundært indkoblet og afbryder ikke strømmen fra nettet. Den indbyggede neddel er derfor tilsluttet til lysnettet så længe netstikket sidder i stikkontakten.

## N

### Observer:

Nettbryteren POWER er sekundært innkoblet. Den indbygdenetdelen er derfor ikke frakoplet nettet så længe apparatet er tilsluttet nettkontakten.

## S

Klass 1 laserapparat

Varning!

Om apparaten används på annat sätt än i denna bruksanvisning specificerats, kann användaren utsättas för laserstrålning, som överskrider gränsen för laserklass 1.

### Observera!

Strömbrytaren POWER är sekundärt kopplad och inte bryter strömmen från nätet. Den inbyggda nättdelen är därför ansluten till elnätet så länge stickproppen sitter i v ägguttaget.

## SF

Luokan 1 laserlaite + Klass 1 laserapparat

Varoitus!

Laitteen käyttäminen muulla kuin tässä käyttöohjeessa mainitulla tavalla saattaa altistaa käyttäjän turvallisuusluokan 1 ylittävälle lasersäteilille.

### Huom.

Toiminnanvalitsin POWER on kytketty toisipuolelle, eikä se kytke laitetta irti sähköverkosta. Sisäänrakennettu verkko-osa on kytkettynä sähköverkkoon aina silloin, kun pistoke on pistorasiassa.

# Important Note for Users in the UK

---

## Mains plug

This apparatus is fitted with an approved 13 Amp plug. To change a fuse in this type of plug proceed as follows:

- 1 Remove fuse cover and fuse.
- 2 Fix new fuse which should be a BS1362 5 Amp, A.S.T.A. or BSI approved type.
- 3 Refit the fuse cover.

If the fitted plug is not suitable for your socket outlets, it should be cut off and an appropriate plug fitted in its place.

If the mains plug contains a fuse, this should have a value of 5 Amp. If a plug without a fuse is used, the fuse at the distribution board should not be greater than 5 Amp.

*Note: The severed plug must be disposed of to avoid a possible shock hazard should it be inserted into a 13 Amp socket elsewhere.*

## How to connect a plug

The wires in the mains lead are coloured with the following code: blue = neutral (N), brown = live (L).

As these colours may not correspond with the colour markings identifying the terminals in your plug, proceed as follows:

- Connect the blue wire to the terminal marked N or coloured black.
- Connect the brown wire to the terminal marked L or coloured red.
- Do not connect either wire to the earth terminal in the plug, marked E (or e) or coloured green (or green and yellow).

Before replacing the plug cover, make certain that the cord grip is clamped over the sheath of the lead - not simply over the two wires.

## Copyright in the U.K.

**Recording and playback of material may require consent. See Copyright Act 1956 and The Performer's Protection Acts 1958 to 1972.**

English .....	5
Français .....	27
Deutsch .....	49
Nederlands .....	71

CAUTION

VISIBLE AND INVISIBLE LASER RADIATION  
WHEN OPEN AVOID EXPOSURE TO BEAM

ADVARSEL

SYNLIG OG USYNLIG LASERSTRÅLING VED  
ÅBNING UNDGÅ UDSÆTTELSE FOR  
STRÅLING

VARNING

SYNLIG OCH OSYNLIG LASERSTRÅLNING  
NÅR DENNA DEL ÄR ÖPPNAD BETRAKTA  
EJ STRÅLEN

VARO!

AVATTAESSA OLET ALTTIINA NÄKYVÄLLE JA  
NÄKYMÄTTÖMÄLLE LASER SÄTEILYLLE. ÄLÄ  
KATSO SÄTEESEEN

VORSICHT

SICHTBARE UND UNSICHTBARE  
LASERSTRAHLUNG WENN ABDECKUNG  
GEÖFFNET NICHT DEM STRAHL  
AUSSETZEN

ATTENTION

RAYONNEMENT LASER VISIBLE ET INVISIBLE  
EN CAS D'OUVERTURE EXPOSITION  
DANGEREUSE AU FAISCEAU

# General Information

The region code for this set is 2.

Since it is usual for DVD movies to be released at different times in different regions of the world, all players have region codes and discs can have an optional region code. If you load a disc of a different region code to your player, you will see the region code notice on the screen. The disc will not playback, and should be unloaded.



*Manufactured under license from Dolby Laboratories. "Dolby", "Pro Logic" and the double-D symbol are trademarks of Dolby Laboratories.*

*This product incorporates copyright protection technology that is protected by method claims of certain U.S. patents and other intellectual property rights owned by Macrovision Corporation and other rights owners. Use of this copyright protection technology must be authorised by Macrovision Corporation, and is intended for home and other limited viewing uses only unless otherwise authorised by Macrovision Corporation. Reverse engineering or disassembly is prohibited.*

TruSurround and the  symbol are trademarks of SRS Labs, Inc. TruSurround technology is incorporated under license from SRS Labs, Inc.



The DVD VIDEO player is in conformity with the EMC directive and low-voltage directive.

For Customer Use:

Read carefully the information located at the bottom of your DVD VIDEO player and enter below the Serial No. Retain this information for future reference.

Model No. DVD VIDEO

Serial No. \_\_\_\_\_

## Laser safety

This unit employs a laser. Due to possible eye injury, only a qualified service person should remove the cover or attempt to service this device.

**USE OF CONTROLS OR ADJUSTMENTS OR PERFORMANCE OF PROCEDURES OTHER THAN THOSE SPECIFIED HEREIN MAY RESULT IN HAZARDOUS RADIATION EXPOSURE.**

**NOTE:  
PICTURES SHOWN MAYBE DIFFERENT BETWEEN COUNTRIES.**

### LASER

Type	Semiconductor laser GaAlAs
Wave length	650 nm (DVD) 780 nm (VCD/CD)
Output Power	7 mW (DVD) 10 mW (VCD/CD)
Beam divergence	60 degree

**CAUTION  
(WARNING LOCATION: ON THE BACKPLATE OF SET)**

**NEVER MAKE OR CHANGE CONNECTIONS WITH THE POWER SWITCHED ON.**

---

## Introduction

Environmental Information .....	6
Supplied accessories .....	6
Safety Information .....	6
Symbols Used in this Manual .....	6

---

## Functional Overview

Front and Rear Panels .....	7
Remote Control .....	8

---

## Preparation

Basic Connections .....	9
Connecting to a TV .....	9
Connecting to an Audio System .....	10
Connecting to Optional Equipment .....	10
Inserting batteries into the Remote Control -	11
NTSC/PAL Conversion .....	11
Switching On .....	11
Menu Bars on TV Screen .....	12
Personal Preferences .....	12-15

---

## Operation

Basic Playback .....	16
Playing a DVD-Video .....	16
Playing a Video CD .....	17
Playing an Audio CD .....	17
Special DVD features .....	17-18
Special VCD & SVCD Features .....	18
Special CD & MP3 Features .....	18
General Features .....	18-21
MP3 Disc Features .....	22

---

## Access Control

Access Control: Child Lock .....	23
Access Control: Parental Control .....	23-24

---

## Specifications

Specifications .....	25
----------------------	----

---

## Maintenance

Maintenance .....	25
-------------------	----

---

## Troubleshooting

Troubleshooting .....	26
-----------------------	----

# Introduction

Thank you for purchasing this Philips DVD player. This Owner's Manual explains the basic operation of this DVD player.

## Environmental Information

All unnecessary packaging has been omitted. We have tried to make the packaging easy to separate into three materials: cardboard (box), polystyrene foam (buffer) and polyethylene (bags, protective foam sheet).

Your DVD player consists of materials which can be recycled and reused if disassembled by a specialised company. Please observe the local regulations regarding the disposal of packaging materials, exhausted batteries and old equipment.

## Supplied accessories

- Remote control
- Batteries (two AA size) for remote control
- Audio cable
- SCART cable (*not available for all versions*)
- CVBS cable
- Owner's Manual



## Safety Information

- Before operating the DVD player, check that the operating voltage indicated on the typeplate (or the voltage indication beside the voltage selector) is identical with the voltage of your local power supply. If not, please consult your dealer.
- Place the DVD player on a flat, hard and stable surface.
- There must be sufficient room in front of the player for the drawer to be opened.

- In cabinet, allow about 2.5cm (1 inch) of free space all around the player for adequate ventilation.
- Do not expose your player to extreme of temperature or humidity.
- If the DVD player is brought directly from a cold to a warm location, or is placed in a very damp room, moisture may condense on the lens of the disc unit inside the DVD player. Should this occur, the DVD player would not operate normally. Leave the power on for about one hour with no disc in the DVD player until normal playback is possible.
- The mechanical parts of the set contain self-lubricating bearings and must not be oiled or lubricated.
- **When the DVD player is switched to Standby mode, it is still consuming some power. To disconnect the system from the power supply completely, remove the AC power plug from the wall socket.**

## Symbols Used in this Manual

The below symbols appear in some headings and notes with the following meanings:

	- Description refers to playback of DVD-video discs
	- Description refers to playback of Video CDs
	- Description refers to playback of Audio CDs

### Helpful Hints!

- **Some DVD video discs require specific functions or allow only limited functions during playback.**
- **“X” may appears on the TV screen which means that the function is not available on that specific DVD video disc.**

## Front and Rear Panels

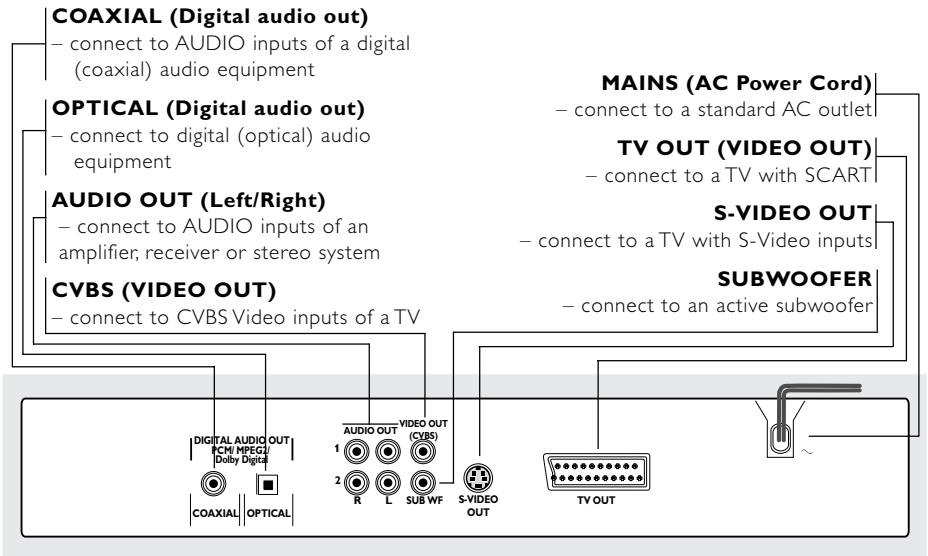
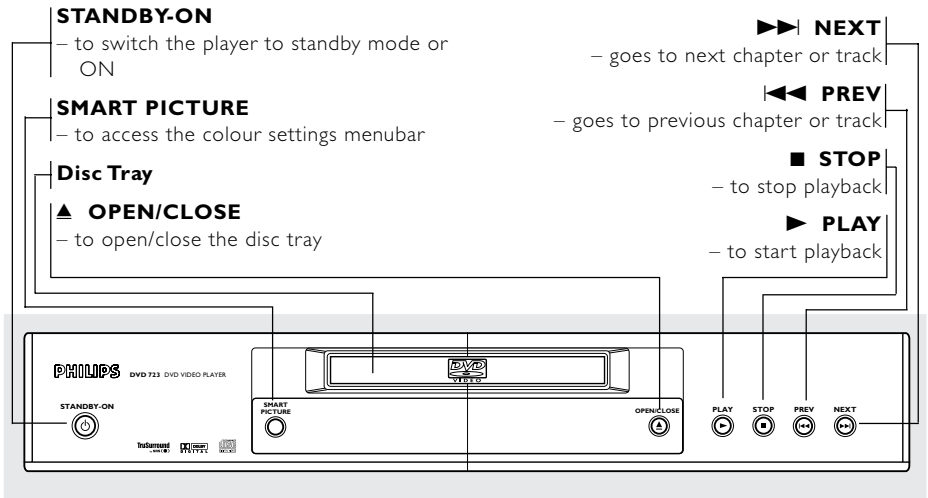

**Caution: Do not touch the inner pins of the jacks on the rear panel. Electrostatic discharge may cause permanent damage to the unit.**

# Functional Overview

## Remote Control

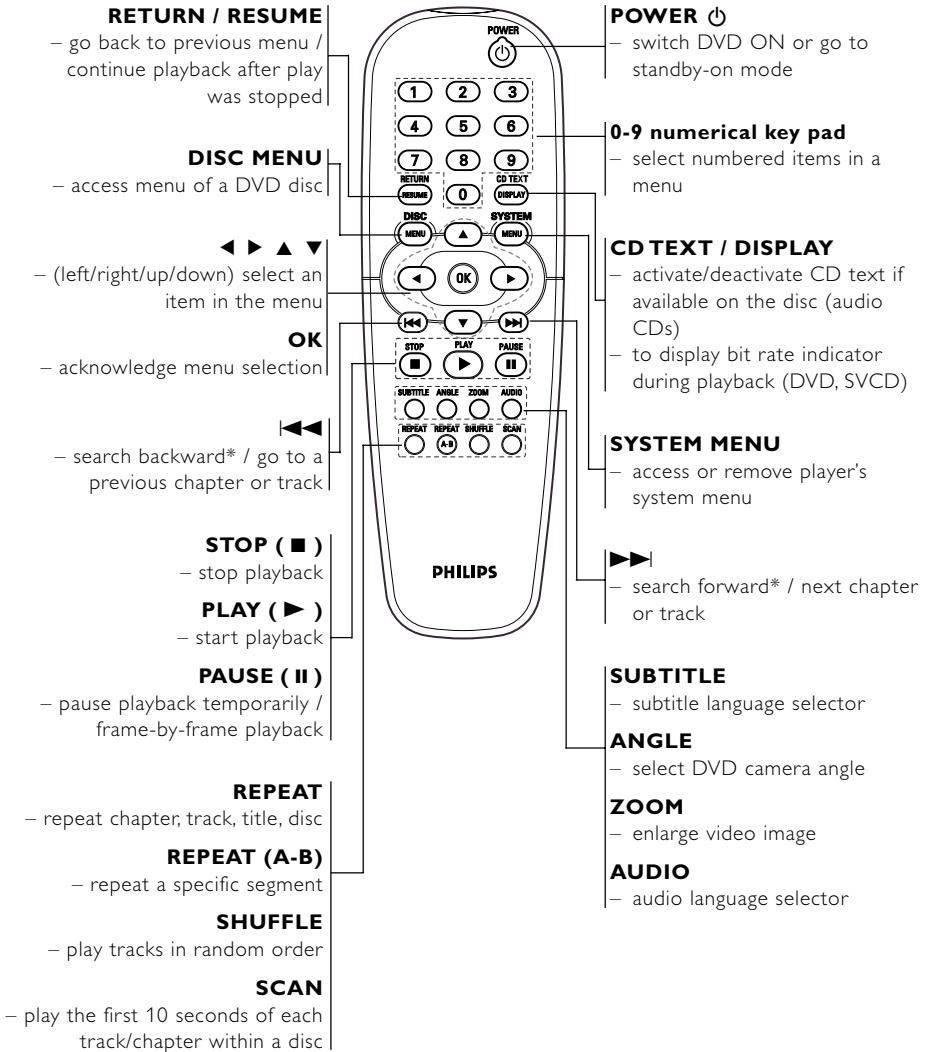

\* Press and hold key for about two seconds



## Basic Connections

- Please refer to the instruction books of your TV, VCR, Stereo System or other devices as necessary to make the best connections.
- Make one of the following connections, depending on the capabilities of your existing equipment.

The following guidelines are options for the best picture and sound quality available on your DVD player:

### Picture

- 1 Use the CVBS Video Output for good picture quality.
- 2 Use S-Video Output for the better picture quality.
- 3 Use SCART Output for best picture quality.

### Sound

- 1 Digital audio connections provide the clearest sound. Connect one of the DVD player's DIGITAL AUDIO OUT (COAXIAL or OPTICAL) to your amplifier or receiver.
- 2 If digital connections are not possible, connect the DVD player's Left and Right (white and red) AUDIO OUT to your amplifier, receiver, stereo or TV.

### Warning!

- Never make or change connections with the power switched on.
- Connect the DVD player directly to your TV, instead of eg. a VCR, to avoid distortion because DVD video discs are copy protected.
- Do not connect the DVD player AUDIO OUT to PHONO IN of your amplifier or receiver.

## Connecting to a TV

- 1 Connect the SCART (TV OUT) on the DVD player to the corresponding connector on the TV IN.

### Note:

- Ensure that the "TV" indication on SCART cable is connected to the TV set and "DVD" indication on SCART cable is connected to the DVD player.

If your TV is not equipped with a SCART input, you can select the following connection:

### If your TV has a CVBS Video input connector,

- 1 Connect the CVBS VIDEO OUT on the DVD player to the CVBS VIDEO IN.
- 2 Connect the Left and Right AUDIO OUT on the DVD player to the Left and Right AUDIO IN on the TV.

### If your TV has a S-Video input connector,

- 1 Connect the S-VIDEO OUT on the DVD player to the S-VIDEO IN on the TV.
- 2 Connect the Left and Right AUDIO OUT on the DVD player to the Left and Right AUDIO IN on the TV.

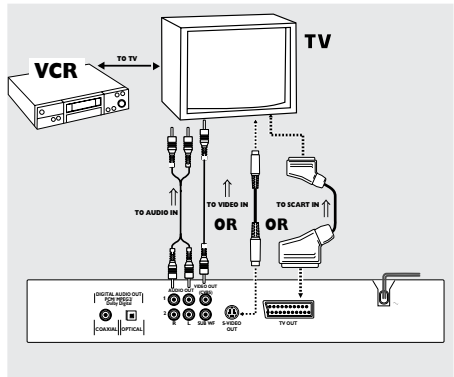

# Preparation

## Connecting to an Audio System

- 1 You can also listen to the sound of audio CDs and DVD video discs by connecting to an optional stereo system.
- 2 Connect the Left and Right AUDIO OUT on the DVD player to the Left and Right AUDIO IN on the stereo system.

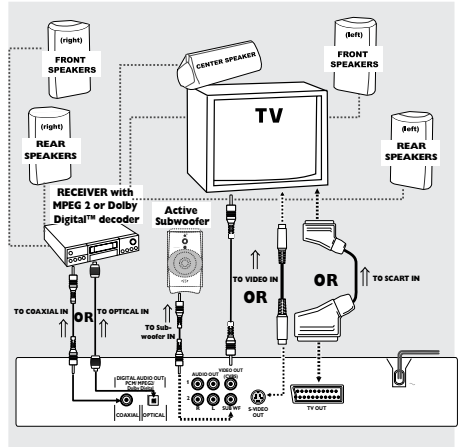
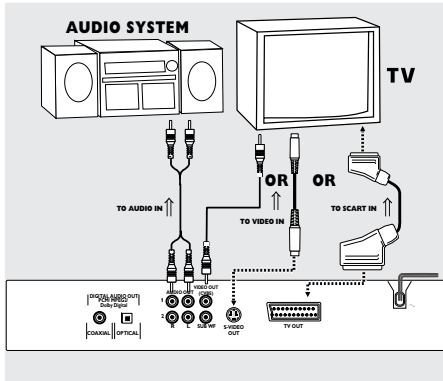

## If you connect to an active subwoofer,

- 1 Connect the SUBWOOFER AUDIO OUT on the DVD player to an optional active subwoofer.
- 2 The subwoofer reproduces just the low bass sound effect (e.g. explosions, the rumble of spaceships, etc.).
- 3 Be sure to follow the instructions supplied with the subwoofer.

### Notes:

- If the audio format of the digital output does not match the capabilities of your receiver, the receiver will produce a strong, distorted sound or no sound at all.
- To see the selected audio format of the current DVD in the Status Window, press SYSTEM MENU.
- MP3 Audio is not available on the Digital Output.

## Connecting to Optional Equipment

- A digital component with a built-in MPEG 2 or Dolby Digital™ decoder allows you to enjoy the surround sound while producing the effect of being in a movie theater or a concert hall.
- The player outputs the surround sound signals from the DIGITAL OUT COAXIAL or OPTICAL connectors.

### If your receiver has a MPEG 2 or Dolby Digital™ decoder,

- 1 Connect the COAXIAL or OPTICAL DIGITAL AUDIO OUT of the DVD player to the COAXIAL or OPTICAL DIGITAL AUDIO IN on your receiver.
- 2 You will need to set the DVD player's digital output to ALL (see 'Personal Preferences').

## Inserting batteries into the Remote Control

- 1 Open the battery cover.
- 2 Insert batteries (AA size) with the correct polarity as indicated by the + and - symbols inside the battery compartment.
- 3 Close the cover.

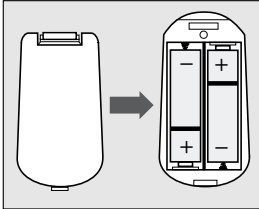

### CAUTION!

- **Remove batteries if they are exhausted or not to be used for a long time.**
- **Do not use old and new or different types of batteries in combination.**
- **Batteries contain chemical substances, so they should be disposed off properly and kept away from children.**

## Using the Remote Control

- Direct the remote control at the remote sensor of the DVD player.
- Do not drop the remote control.
- Do not leave the remote control near extremely hot or humid place.
- Do not spill water or put anything wet on the remote control.

## NTSC/PAL Conversion

This player is equipped with an NTSC/PAL conversion feature that converts the video output of the disc to match your TV system. To activate the conversion refer to page 13.

## Switching On

- 1 Connect the AC power cord to the power outlet.
- 2 Switch on the TV and DVD player.
- 3 Set the TV to the correct Video IN channel. (eg. EXT1, EXT2, AV1, AV2, AUDIO/VIDEO, etc. (Refer to your TV owner's manual for detail)
  - ➔ The player display lights up and the default screen appears on the TV.
- 4 If you are using an external equipment (eg. audio system or receiver), turn them on and select the appropriate input source that was used to connect to the DVD player output. Refer to the equipment owner's manual for detail.

# Preparation

## Menu Bars on TV Screen

- Operations can be carried out directly via the multiple menu bars on the TV screen.
- The following functions are available via the menu bars. Pressing SYSTEM MENU keys repeatedly will toggle through menu bar 1, menu bar 2, menu bar 3 and menu bar OFF:

### Menu bar 1



From the left,  
Personal Preferences → Subtitle Language →  
Audio Language → Colour → Sound

### Menu bar 2



From the left,  
Step by step playback → Slow motion →  
Fast motion → Angle → Zoom

### Menu bar 3



From the left,  
Title → Chapter → Time Search →  
Favourite Track Selection (FTS)

## Temporary Feedback Field Icons

These icons will appear on the top left hand corner of your TV screen.

	Scan		Repeat A to end
	Repeat All		Repeat A-B
	Repeat Title		Angle
	Repeat Track		Child Lock On
	Repeat Chapter		Child Safe
	Shuffle		Resume
	Shuffle Repeat		Action Prohibited

## Personal Preferences

In the Personal Preferences settings menu, you can customize you player to suit your own particular requirements.

### General operation:

- 1 Press SYSTEM MENU on the remote control.
- 2 The will be highlighted in the menu bar.
- 3 Press ▼ to activate the Personal Preferences menu.
- 4 Use the ◀ ▶ ▲ ▼ keys to toggle through the functions and select your preferred option.
- 5 Press OK to confirm a highlighted selection. The following items are available:

### Picture

#### – TV Shape

Select the aspect ratio of the TV to be connected.

**16:9** → when you connect a wide-screen TV to the DVD player.

**4:3 LETTER BOX** → when you connect a normal TV to the DVD player. Displays a wide picture with bands displayed on the upper and lower portions of the TV screen.

**4:3 PAN SCAN** → when you connect a normal TV to the DVD player. Displays the wide picture on the whole TV screen with a portion automatically cut off.

16:9



4:3  
Letter Box



4:3  
Pan Scan



Note:

- Pan Scan is subject to availability on the disc.

## – Black level shift (NTSC output only)

Select ON for adapting the colour dynamics to obtain richer contrasts.



## – Video shift

Use this setting to personalize the position of the picture on your TV by scrolling it to the left or right.



## – Monitor type selection

Allows you to select the type of display device that is connected to the DVD Video player. In each device, a set of predefined settings (eg. Rich-Natural-Soft•Animation) is available or choose "Personal" that allows you to select the colour settings according to your preference.

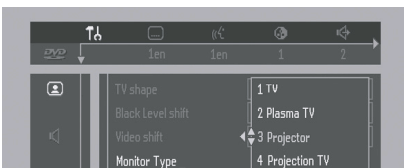

### Notes:

- You can select one of the following display devices: eg. TV, Plasma TV, Video Projector and Projection TV.

## – Smart Picture

### ● Colour settings

You can select one of five predefined sets of colour settings and one set (Personal) which you can define yourself.

You can also press SMART PICTURE key (front panel) to access the smart picture in the menubar:



- When **Personal** is selected it allows you to fine-tune saturation, brightness and contrast
- Use ▲ or ▼ keys to adjust the values of these parameters.

## – TV System (NTSC/PAL Conversion)

Allows you to select between PAL, NTSC and AUTO mode depending on your TV.

The conversions supported are as follows:

Type	Format	Output format		
		Selected mode		
		NTSC	PAL	AUTO
DVD	NTSC	NTSC	PAL	NTSC
	PAL	Not Supported	PAL	PAL
VCD	NTSC	NTSC	PAL	NTSC
	PAL	NTSC	PAL	PAL

- 1 In the Personal Preferences Menu, select **TV System**.
- 2 Press ▲ or ▼ to select PAL, NTSC or AUTO.

### Notes:

- If you have a PAL only TV, ensure that your PAL/NTSC setting is PAL.
- AUTO can only be selected when using a TV that has both the NTSC and PAL systems.
- This setting is applicable for CVBS output on cinch and SCART only.
- Slight picture distortions may occur due to this conversion. This is normal. Thus, the AUTO format is most suitable for the best picture quality.

# Preparation

## Sound

### – Digital output

- Digital output selection enables you to specify the type of digital output suitable for your receiver.
- Select ALL (default setting), if you had connected your DIGITAL AUDIO OUT to a multichannel decoder receiver.
- Select PCM only if your receiver is not capable of decoding multichannel audio.
- Select OFF to deactivate the DIGITAL AUDIO OUT.



### – Analogue output

Select Stereo, Dolby Surround compatible or 3D Sound (Trusurround) output to match your system's playback capability.

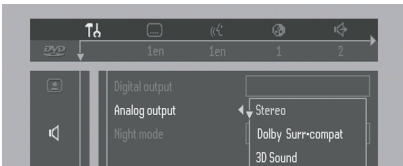

### – Night Mode

When set to ON, the dynamics of your sound output are optimised. High volume outputs are softened, enabling you to watch your favourite action movie without disturbing others.

### – Subwoofer cut-off

The frequency of the subwoofer output can be set to HIGH (200Hz) or LOW (100Hz) to match your system's playback sound quality.

### – PCM Output

Allows to select PCM digital output between 48kHz and 96kHz. When 48kHz has been selected, 96kHz (if available on disc) PCM data stream will be converted to 48kHz. Some 96kHz DVD are copy protected. If your PCM output selection is 96kHz, the digital output will be muted to comply with the standards. Select 48kHz to enable digital output.

### – Karaoke vocal

Put this setting to ON only when a multi-channel karaoke DVD is being played. The karaoke channels on the disc will then be mixed into a normal stereo sound.

## Language

### Selecting disc languages:

#### Menu/Audio/Subtitle language

- This is to select the audio language, subtitle language and the language used in TV screen menus or DVD menus which will always be used for every disc to be played back.
- If the language selected is not available on the disc, the original language designated by each disc will be selected.

## Features

### - Access Control

Access Control contains the following features: Child Lock - When Child Lock is set to ON, a 4-digit code needs to be entered in order to playback discs.

Parental control - Allows the conditional presentation of DVDs containing Parental Control information (see 'Access Control' section).

### - Status Window

Displays the current status of the player and appears with the menu bar. When disc playback is stopped, it is displayed with the 'Temporary Feedback Field' in the default screen. See 'On-Screen Display' information; Factory setting is ON. Select OFF to suppress display of the Status Window.



### - Bit Rate Indicator

Press the **DISPLAY** key to activate the bit rate indicator. When activated, the bit rate for video and audio, as well as the total bit rate is displayed. This is only applicable during playback of DVD and SVCD discs.

vid	aud	tot
0-1	0-10	0-10
mbits/s		

### - Help text

When set to ON, help text describes the icons selected. Select OFF if you no longer require the help text.

### - Beeper

The beeper can be set to ON or OFF.

### - PBC (Playback Control - for VCD)



The Playback Control can be set to ON or OFF.

### - Smart Power OFF

Puts the set to standby after a predefined time. This can be set to Enable or Disable.

# Operation

## Basic Playback

- 1 Press **STANDBY ON** on the front panel.
- 2 Press **OPEN/CLOSE**  on the front panel to open disc loading tray.
- 3 Place the chosen disc in the tray, with the label facing up.
- 4 Press **OPEN/CLOSE**  again to close the tray.  
→ **READING** appears in the status window and on the player display, and playback starts automatically.

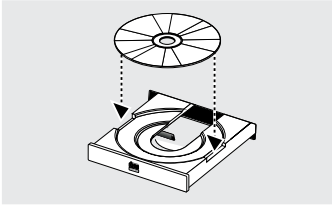

### Notes:





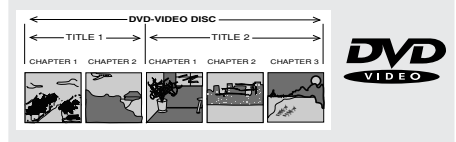

- DVDs may have a region code. Your player will not play discs that have a region code different from the region code of your player.
- If 'Child Lock' is set to ON and the disc inserted is not authorised, the 4-digit code must be entered and/or the disc must be authorised (see 'Access Control').

## Playing a DVD-Video

- DVD video discs may have one or more TITLES, and each TITLE may have one or more CHAPTERS.
- Playback stops at the end of each TITLE.



### Playing a title

- 1 Insert a disc and close the tray, playback starts automatically.  
→ The TV screen's and DVD player's display shows the type of disc loaded, disc's information and playing time.
- 2 When the Disc Menu appear on the TV screen, use     keys or numerical keys on the remote control to select an option and continue playback.
- 3 If the titles are numbered, press the numerical keys or use the   keys to select desired title in the menu bar.
- 4 To stop playback, press **STOP**.

### Smart Resume

- In stop mode and when a disc has not been ejected,  
→ Pressing **PLAY** will automatically resume playback from the point where the playback was last stopped.

### To deactivate auto resume,

- Press **STOP** to stop playback.  
→ The help line text appears "Press Stop again to start from beginning" for 5 seconds.
- Press **STOP** again or unload the discs, the auto resume is cancelled.

### To activate auto resume,

- Reload the disc and press **PLAY**.  
→ Playback starts from the beginning of the title.
- When resume icon  appears on the screen, press **PLAY** again.  
→ Playback will resume from the point where the playback was last stopped.

### Note:

- Resume feature is also applicable to VCDs and SVCDs.



## Playing a Video CD

- Video CDs may have one or more TRACKS, and TRACKS may have one or more INDEXES.
- To make easy and convenient access, you can move between TRACKS and INDEXES.
- Some Video CDs have Play Back Control (PBC), which is a predefined playback sequence stored on the disc (see *Playback Control* section).

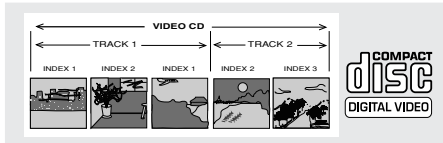

## Playing a disc

- 1 Insert the disc and close the tray, playback starts automatically.
  - The number of tracks and the total playing time of the disc will appear on the TV screen and DVD player's display.
- 2 Press **PLAY**.
  - The current track number and its elapsed playing time will be displayed.
- 3 Playback will stop at the end of the disc.
- 4 To stop playback, press **STOP**.
- 5 Disc Resume feature is also applicable for VCDs and SVCDs (see *Smart Resume* section).

## Playing an Audio CD

- Audio CDs contain only TRACKS.
- They can be played on your DVD player with the audio output connected to a stereo system or to your TV.
- If CD-text is available on the disc, it will be display on both the TV screen and front player's display.
- Select tracks using the menubar on the TV screen or by pressing the numerical keys directly.
- Your DVD player also allows you to compile Favourite Track Selection (FTS) programmes for your discs by selecting or excluding tracks of your choice (see *FTS Programme - Audio CDs*).

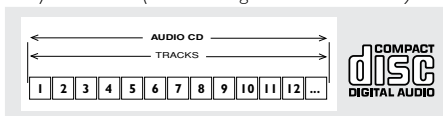

## Playing a disc

- 1 Insert a disc and close the tray, playback starts automatically.
  - The TV screen will display the number of tracks for selection and current playing status.
- 2 Playback will stop at the end of the disc.
- 3 To stop playback, press **STOP**.

## Special DVD Features

DVDs may contain menus to navigate the disc and access special features. Press the appropriate numerical key or use the **▼**, **▲**, **▶**, **◀** keys to highlight your selection in the DVD menu and press OK to confirm.

## Title/Disc menu

- 1 Press **DISC MENU**.
  - If the current title has a menu, the menu will appear on the screen. Otherwise, the disc menu will be displayed.
- 2 If disc menu is available on the disc, audio language, subtitle options, chapters for the title and other options will appear for selection.
- 3 To remove the title/disc menu, press **DISC MENU** again.

## Camera Angle

Some discs contain scenes which have been shot simultaneously from various angles.

This DVD player allows you to select the desired camera angle.

- When the DVD player encounters a scene shot in multiple angles, it will give an indication on the "Temporary Feedback Field."
  - The angle icon remains displayed until multiple angles are no longer available.
- Use the **▲/▼** to select the required angle.
  - Playback changes to the selected angle.
- You can also select **↔ (ANGLE)** in the menu bar or press the **ANGLE** button on the remote control directly.

## Changing the audio language

- 1 Select **⏏ (AUDIO)** in the menu bar or press the **AUDIO** button on the remote control directly.
- 2 Press **AUDIO** or **▲/▼** repeatedly to select the different languages.

## Subtitles

- 1 Select  (**SUBTITLE**) in the menu bar or press the **SUBTITLE** button on the remote control directly.
- 2 Press **SUBTITLE** or **▲/▼** repeatedly to select the different subtitles.

## Special VCD & SVCD Features

### Playback Control (PBC)

- 1 Load a Video CD with PBC and press **PLAY**.
- 2 Go through the menu with the keys indicated on the TV screen until your chosen passage starts to playback. If a **PBC** menu consists of a list of tracks, you can select a track directly.
- 3 Enter your choice with the numerical keys (0-9).
- 4 Press RETURN to go back to the previous menu, if applicable on the menu.
- 5 You may also select **PBC OFF** under Personal Preferences.  
→ When set to OFF, PBC menus are not activated for further playback.

## Special CD & MP3 Features

### CD text and MP3 text

- 1 Some CD or MP3-CD discs may contain text information (eg. track name, album name, artist name etc.) which will appear on the DVD player and TV screen during playback.
- 2 By default, CD text display is set to ON.
- 3 To switch off the CD text display, press CD TEXT (DISPLAY) on the remote control during playback.
- 4 Press CD TEXT (DISPLAY) on the remote control again to switch on the text display mode.



repeat/shuffle		Audio Disk Mode		
play	track	time	total tracks	total time
	11	2:34	14	5:29:78
Disc	The Best of Me			
Artist	Bryan Adams			
Track	Everything I do			

## General Features

### Note:

- Unless stated, all operations described are based on remote control use. Some operations can be carried out using the menu bar on the TV screen.

## Moving to another title/chapter

### DVD VCD

When a disc has more than one title/track or chapter, you can move to another title/chapter as follows:

- 1 Press **SYSTEM MENU**, then select **T** or **C** in the menu bar.
- 2 Press **▲▼** or numerical keys to select a title/ chapter.

### CD

- 1 Press **▶▶|** or **|◀◀** briefly during playback to go to the next track or to return to the beginning of the current track respectively.
- 2 Press **|◀◀** twice briefly to step back to the previous track.
- 3 To go directly to any track, enter the track number using the numerical keys (0-9).

### Note:

- Long press of the **▶▶|** or **|◀◀** keys will switch the DVD player on **BACKWARD** or **FORWARD** search (see **SEARCH** section).

## Search

### DVD VCD

- 1 Select  (FAST MOTION) in the menu bar and press **▼**.
- 2 Use the **◀▶** keys to select the required speed: -32, -8 or -4 (backward), or +4, +8, +32 (forward).
- 3 Select 1 to play the disc at normal speed again.
- 4 To exit FAST MOTION mode, press **PLAY** or **▲**.

### CD

- To search forward or backward through different speeds, you can also hold down **▶▶|** or **|◀◀** for more than two seconds.

## Slow Motion

- 1 Select  (SLOW MOTION) in the menu bar and press **▼**.  
→ Playback will pause.
- 2 Use the cursor keys **◀▶** to select the required speed: -1, -1/2, -1/4 or -1/8 (backward), or +1/8, +1/4, +1/2 or +1 (forward).
- 3 Select 1 to play the disc at normal speed again.
- 4 If **||** is pressed, the speed will be set to zero (PAUSE).
- 5 To exit slow motion mode, press **PLAY**.

## Still Picture and Frame-by-frame playback

- 1 Select  (STEP) in the menu bar and press **▼**.  
→ Playback will pause.
- 2 Use the cursor keys **◀▶** to select the previous or next picture frame.
- 3 To exit step by step playback, press **PLAY** or **▲**.

**Note:**

– You can also activate frame-by-frame playback by pressing the **PAUSE** key repeatedly on the remote control.

## Scan

Scanning plays the first 10 seconds of each chapter/track on the disc.

- 1 Press **SCAN**.
- 2 To continue playback at your chosen chapter/track, press **SCAN** again or press **PLAY**.

## Repeat

### 

#### Repeat chapter/title/disc

- To repeat the current chapter; press REPEAT.  
→ **REPEAT CHP** appears on the front display.
- To repeat the current title, press REPEAT a second time.  
→ **REPEAT TTL** appears on the front display.
- To repeat the entire disc, press REPEAT a third time.  
→ **REPEAT DISC** appears on the front display.
- To exit Repeat mode, press REPEAT a fourth time.

### 

#### Repeat track/disc

- To repeat the current track, press REPEAT.  
→ **REPEAT TRK** appears on the front display.
- To repeat the entire disc, press REPEAT a second time.  
→ **REPEAT DISC** appears on the front display.
- To exit Repeat mode, press REPEAT a third time.

## Repeat A-B

- **DVD-Video Discs: repeat a sequence in a title**
- **Video and Audio CDs: repeat a sequence in a track**

- 1 Press REPEAT A-B at your chosen starting point.
- 2 Press REPEAT A-B again at your chosen end point.  
→ **REPEAT A-B** appears briefly on the front display, and the repeat sequence begins.
- 3 To exit the sequence, press REPEAT A-B.

# Operation

## Shuffle

### DVD

This shuffles the playing order of chapters within a title, if the title has more than one chapter.

- 1 Press SHUFFLE during playback.  
→ **SHUFFLE** appears on the screen for about two seconds.
- 2 To return to normal playback, press SHUFFLE again.

### VCD CD

This shuffles the playing order of tracks within a disc, if the disc has more than one tracks.

- 1 Press SHUFFLE during playback.  
→ **SHUFFLE** appears on the screen for about two seconds.
- 2 To return to normal playback, press SHUFFLE again.

## Time search

The Time Search function allows you to start playing at any chosen time on the disc.

- 1 Select **TIME SEARCH** in the menu bar and press **▼**.  
→ Playback will pause.  
→ The elapsed playing time is displayed in a time edit box.
- 2 Enter hours, minutes and seconds from left to right in the time edit box using remote control numerical key pad.  
→ Each time an item has been entered, the next item will be highlighted.
- 3 Press OK to confirm the selected time.  
→ The time edit box will disappear and playback starts from the selected time position on the disc.



- 4 Press SYSTEM MENU to remove the menu bar.

## Zoom

The Zoom function allows you to enlarge the video image and to pan through the enlarged image.

- 1 Select **ZOOM**.
- 2 Press **▲/▼** to activate the **ZOOM** function and select the required zoom factor: 1.33 or 2 or 4.  
→ Playback will continue.  
→ The selected zoom factor and 'Press OK to pan' appears below the menu bar.  
→ The zoomed picture will appear on the TV screen.
- 3 Press OK to confirm the selection.  
→ The panning icon appears on the screen.
- 4 Use the **◀▶▲▼** keys to pan across the screen.
- 5 When OK is pressed only the panned picture will be shown on the screen.
- 6 To exit **ZOOM** mode, select zoom factor to "Off" (zoom factor 1) in the menu bar.



## FTS Video/Audio Programme

- Favourite Track Selection (FTS) list contains up to 20 items (titles, chapters).
- The most recent programme list will be placed on top of the existing list.

### DVD VCD

#### Storing a Programme

- 1 While playback is stopped, select **VIDEO FTS**  in the menu bar.
- 2 Press **▼** to open the menu bar.  
→ The **VIDEO FTS**  menu appears.
- 3 Press **▶** or **◀** or FTS (on the remote control) to select ON.

## Storing titles/tracks

- 1 Press ▼ to select **TITLES/TRACKS**.
- 2 Use ► and ◀ to select the required title/tracks.
- 3 Press OK to store the entire selected title/tracks.  
→ The title number will be added to the list of selections.

## Storing chapters/indexes

- 1 Press ▼ on the selected chapter/indexes number.  
→ The chapter/indexes number will be highlighted.
- 2 Use ► and ◀ to select the required chapter number.
- 3 Press OK to confirm the selection.  
→ The selected chapter/indexes confirmation will be added to the list of selections.
- 4 Press SYSTEM MENU to exit the **VIDEO FTS**  menu.

## Erasing a selection in a Programme

- 1 While playback is stopped, select **VIDEO FTS**  in the menu bar.
- 2 Use ▼ to select **PROGRAM**.
- 3 Use ► and ◀ to select the required number.
- 4 Press OK to erase the selection.
- 5 Press SYSTEM MENU to exit.

## Erasing all selections

- 1 While playback is stopped, select **VIDEO FTS**  in the menu bar.
- 2 Use ▼ to select **CLEAR ALL** and press OK.  
→ All selections will be erased.
- 3 Press SYSTEM MENU to exit.



## Storing a Programme

- 1 Load a disc and stop playback.
- 2 Press ▼ to go to the list of available tracks.
- 3 Use ► and ◀ to select the required tracks or directly using remote control numeric key.
- 4 Press OK to store the selected tracks.  
→ The track number will be added to the list of selections.

## Switching a Programme ON/OFF

- 1 Use ▲▼ to move and select desired tracks.
- 2 Press ► or ◀ to select either ON or OFF.

## Erasing a track in a Programme

- 1 Use ▼ to go to the programmed tracks.
- 2 Use ► and ◀ to select the required number.
- 3 Press OK to erase the selection.
- 4 Press SYSTEM MENU to exit.

## Erasing all selections

- Use ▼ to select **CLEAR ALL** and press OK.  
→ All selections will be erased.



## MP3 Disc Features

**Support following MP3-CD formats (ISO9660 format):**

- Max. 30 characters
- Max. nested directory is 8 levels
- The max. ALB number is 32
- Supported VBR bit-rate
- Supported sampling frequencies for MP3 disc are: 32 kHz, 44.1 kHz, 48 kHz
- Supported Bit-rates of MP3 disc are: 32, 64, 96, 128, 192, 256 (kbps)

**Following formats can't be supported**

- The files like \*.WMA, \*.AAC, \*.DLF, \*.M3U, \*.PLS
- Chinese filenames
- The non-session closed discs
- The discs recorded under UDF format

Downloading MP3 files from the Internet or copying songs from your own legal discs is a delicate process.

Sound Quality	Bit Rate	Approximate Reduction Ratio	Approximate total MP3-CD time	Comment
AM radio	32 kbps	40 : 1	40 hrs	Sound quality significantly affected - not recommended.
FM radio	64 kbps	20 : 1	20 hrs	
Near-CD	96 kbps	15 : 1	15 hrs	Balanced sound quality - compression rate
CD-like	128 kbps	10 : 1	10 hrs	
CD*	256 kbps	5 : 1	5 hrs	Compression rate low
CD*	320 kbps	3 : 1	3 hrs	- suggest to play CDs instead

**You may experience an occasional "skip" while listening to your MP3 files. This is normal.**

**Additional note for MP3 disc Playback:**

- In compliance with the SDMI, digital-out is muted while playing MP3 discs.
- Due to the recording nature of Digital Audio MP3 (DAM), only Digital Audio music will play.
- The disc reading time may exceed 10 seconds due to the large number of songs compiled onto one disc.
- For multi-session discs, only the first session will be available.

## Album/Title

This feature allows you to view and select the next or previous MP3 disc Album/Title.

- 1 Press ▲/▼ to scroll through the previous or next Album.
- 2 Press ◀▶ to scroll through the previous or next Track.
- 3 You can also select the desired album/track number directly using the numeric keys on the remote control.

**Note:**

- **In STOP mode:** numbers are used for ALBUM selection.
- **In PLAY mode:** numbers are used for TRACK selection.







- Only the following functions are possible for MP3 discs:
  - STOP / PLAY / PAUSE
  - SKIP NEXT / PREVIOUS
  - REPEAT (TRACK / ALBUM / DISC)

## MP3 Discs - Album/Track/Disc

- To repeat a track, press REPEAT.
  - ➔ REPEAT TRK appears on the player display.
- To repeat an album, press REPEAT a second time.
  - ➔ REPEAT ALBM appears on the player display.
- To repeat the entire disc, press REPEAT a third time.
  - ➔ REPEAT DISC appears on the player display.
- To exit REPEAT mode, press REPEAT a fourth time.
  - ➔ REPEAT OFF appears on the player display.

## Child Lock

### Activating/deactivating the Child Lock

- 1 When disc playback is stopped, select **ACCESS CONTROL** in the Personal Preferences menu using the ▲/▼ keys.
- 2 Enter a 4-digit code of your own choice twice.
- 3 Move to "**CHILD LOCK**" using the ▲/▼ keys.
- 4 Move to  /  using the ► keys.
- 5 Select  using the ▲/▼ keys.
- 6 Press OK or ◀ to confirm, then press ◀ again to exit the Personal Preferences menu.  
→ Now unauthorised discs will not be played unless the 4-digit code is entered.
- 7 Select  to deactivate the **CHILD LOCK**.

**Notes:**

*Confirmation of the 4-digit code is necessary when:*

- The code is entered for the very first time (see above),
- The code is changed or cancelled (see 'Changing the 4-digit code'),



### Authorising discs

- 1 Insert the disc.  
→ The 'child safe' dialog will appear.
- 2 You will be asked to enter your secret code for 'Play Once' or 'Play Always.'
- If 'Play Once', disc can be played when in the player and the player is ON.
- If 'Play Always', disc will become authorised and can always be played, even if the Child Lock is set to ON.

**Notes:**

- The player memory can maintain 120 authorised ('Child safe') disc titles. A disc will be placed in the list when 'Play Always' is selected.

- Each time a 'child safe' disc is played, it will be placed on top of the list. When the list is full, the last disc in the list will be replaced when a new disc is added.
- Double-sided DVDs and multi-volume VCDs may have a different ID for each side. In order to make the disc 'child safe', each side has to be authorised.



### Deauthorising discs

- 1 Insert the disc.  
→ Playback starts automatically.
- 2 Press ■ while ☺ is visible.  
→ The ☺ will appear and the disc is now deauthorised.

## Parental Control

Movies on DVDs may contain scenes not suitable for children. Therefore, discs may contain 'Parental Control' information which applies to the complete disc or to certain scenes on the disc. These scenes are rated from 1 to 8, and alternative, more suitable scenes are available on the disc. Ratings are country dependent. The 'Parental Control' feature allows you to prevent discs from being played by your children or to have certain discs played with alternative scenes.



## Activating/Deactivating Parental Control

- 1 When disc playback is stopped, select **ACCESS CONTROL** in the Personal Preferences menu using the ▲/▼ keys.
- 2 Enter your 4-digit code. If necessary, enter the code a second time.
- 3 Move to **Parental Control** using the ▲/▼ keys.
- 4 Move to value adjustment (1-8) using the ► key.
- 5 Then use the ▲/▼ keys or the numerical keys on the remote control to select a rating from 1 to 8 for the disc inserted.

### *Rating 0 (displayed as ‘- -’):*

Parental Control is not activated. The Disc will be played in full.

### *Ratings 1 to 8:*

The disc contains scenes not suitable for children. If you set a rating for the player, all scenes with the same rating or lower will be played. Higher rated scenes will not be played unless an alternative which has the same rating or lower is available on the disc. If no suitable alternative is found, playback will stop and the 4-digit code has to be entered.

- 6 Press OK or ◀ to confirm, then press ◀ again to exit the Personal Preferences menu.



## Country

- 1 When disc playback is stopped, select **ACCESS CONTROL** in the Personal Preferences menu using the ▲/▼ keys.
- 2 Enter the 4-digit code.
- 3 Move to **CHANGE COUNTRY** using the ▼ key.
- 4 Press the ► key.
- 5 Select a country using ▲/▼.
- 6 Press OK or ◀ to confirm, then press ◀ again to exit the menu.

## Changing the 4-digit code

- 1 When disc playback is stopped, select **ACCESS CONTROL** in the Personal Preferences menu using the ▲/▼ keys.
- 2 Enter the current 4 digit code.
- 3 Move to **CHANGE CODE** using the ▼ and press the ► key.
- 4 Enter the new 4-digit code.
- 5 Enter the code a second time and reconfirm by pressing OK.
- 6 Press ◀ to exit the menu.  
→ The new 4 digit code will be take effect.

## If you forget your 4 digit code

- 1 Press ■ to exit the 'Child Safe' screen.
- 2 Select **ACCESS CONTROL** in the Personal Preferences menu using the ▲/▼ keys.
- 3 The 4-digit code can be cancelled by pressing ■ four times in the 'Access Control' dialog.
- 4 You can then enter a new code (twice!) as described above in 'Changing the 4 digit code'.

## Parental Control Disclaimer

This DVD player features the **PARENTAL CONTROL** system which is to activate when playing DVD discs furnished with certain software coding only.

Also note that at the time of release of this DVD player, certain aspects of the technical standards had not been settled between set makers and the disc industries.

On this basis, Philips cannot guarantee the functioning of the **PARENTAL CONTROL** system and denies any liability associated with unintended watching of disc content.

If in doubt, please make sure the disc plays according to your **PARENTAL CONTROL** settings before you allow children access to the player.



## PLAYBACK SYSTEM

DVD Video  
 Video CD & SVCD  
 CD (CD-Recordable and CD-Rewritable)  
 MP3 CD

## TV STANDARD (PAL/50Hz) (NTSC/60Hz)

Number of lines	625	525
Playback	Multistandard	(PAL/NTSC)

## VIDEO PERFORMANCE

Video output	1 Vpp into 75 ohm
RGB (SCART) output	0.7 Vpp into 75 ohm
Black Level Shift	On/Off
Video Shift	Left/Right

## AUDIO FORMAT

Digital	MPEG	Compressed Digital
	Dolby Digital	16, 20, 24 bits
	PCM	fs, 44.1, 48, 96 kHz

MPEG MP3 MPEG Audio L3

Analogue Stereo Sound

Dolby Surround-compatible downmix from Dolby Digital multi-channel sound

3D Sound for virtual 5.1 channel sound on 2 speakers

## AUDIO PERFORMANCE

DA Converter	24 bits	
DVD	fs 96 kHz	4 Hz - 44 kHz
DVD/SVCD	fs 48 kHz	4 Hz - 22 kHz
SVCD/VCD/CD	fs 44.1 kHz	4 Hz - 20 kHz
Signal-Noise (1kHz)		> 105 dB
Dynamic Range (1kHz)		> 100 dB
Crosstalk (1kHz)		> 105 dB
Distortion and Noise (1kHz)		> 90 dB
MPEG MP3	MPEG Audio L3	

## CONNECTIONS

SCART	Euroconnector
S-Video Output	Mini DIN, 4 pins
Video Output	Cinch (yellow)
Audio L+R output	Cinch (white/red)
Audio Subwoofer	Cinch (black)
Digital Output	1 coaxial, 1 optical
	IEC958 for CDDA / LPCM
	IEC1937 for MPEG1/2, Dolby Digital

## CABINET

Dimensions (w x h x d)	435 x 75 x 302 mm
Weight	Approximately 2.8 Kg

\* typical playing time for movie with 2 spoken languages and 3 subtitle languages

**Specifications subject to change without prior notice**

# Maintenance

## Cleaning the Cabinet

- Use a soft cloth slightly moistened with a mild detergent solution. Do not use a solution containing alcohol, spirits, ammonia or abrasives.

## Cleaning Discs

- When a disc becomes dirty, clean it with a cleaning cloth. Wipe the disc from the centre out. Do not wipe in a circular motion.
- Do not use solvents such as benzine, thinner, commercially available cleaners, or antistatic spray intended for analogue records.

## Cleaning the disc lens

- After prolonged use, dirt or dust may accumulate at the disc lens. To ensure good playback quality, clean the disc lens with Philips CD Lens Cleaner or any commercially available cleaner. Follow the instructions supplied with the cleaner.

# Troubleshooting

## WARNING

*Under no circumstances should you try to repair the system yourself, as this will invalidate the warranty. Do not open the system as there is a risk of electric shock.*

*If a fault occurs, first check the points listed below before taking the system for repair.*

<b>Problem</b>	<b>Solution</b>
<b>No power</b>	<ul style="list-style-type: none"><li>– Check if the AC power cord is properly connected.</li><li>– Press Standby-On key on the DVD player.</li></ul>
<b>No picture</b>	<ul style="list-style-type: none"><li>– Check if the TV is switched on.</li><li>– Check the video connection.</li></ul>
<b>Distorted picture</b>	<ul style="list-style-type: none"><li>– Sometimes a small amount of picture distortion may appear. This is not a malfunction.</li></ul>
<b>Completely distorted picture or black/white picture with DVD or Video CD</b>	<ul style="list-style-type: none"><li>– Make sure the NTSC/PAL setting at the DVD player matches the video signal of your television. (See NTSC/PAL Conversion/Settings)</li></ul>
<b>No sound or distorted sound</b>	<ul style="list-style-type: none"><li>– Adjust the volume.</li><li>– Check that the speakers are connected correctly.</li><li>– Select another audio language (if available on the DVD video disc)</li></ul>
<b>No audio at digital output</b>	<ul style="list-style-type: none"><li>– Check the digital connections.</li><li>– Check the settings menu to make sure the digital output is set to ALL or PCM.</li><li>– Check if the audio format of the selected audio language matches your receiver capabilities.</li></ul>
<b>No sound and picture</b>	<ul style="list-style-type: none"><li>– Check that the SCART cable is connected to the correct device (See Connecting to a TV)</li></ul>
<b>Disc can't be played</b>	<ul style="list-style-type: none"><li>– Ensure the disc label is facing up.</li><li>– Check if the disc is defective by trying another disc.</li></ul>
<b>Picture freezes momentarily during playback</b>	<ul style="list-style-type: none"><li>– Check the disc for fingerprints/scratches and clean with a soft cloth wiping from centre to edge.</li></ul>
<b>No return to start-up screen when disc is removed</b>	<ul style="list-style-type: none"><li>– Reset the unit by switching the player off, then on again.</li></ul>
<b>The player does not respond to the remote control</b>	<ul style="list-style-type: none"><li>– Aim the remote control directly at the sensor on the front of the player.</li><li>– Reduce the distance to the player.</li><li>– Replace the batteries in the remote control.</li><li>– Re-insert the batteries with their polarities (+/- signs) as indicated.</li></ul>
<b>Buttons do not work or player stops responding</b>	<ul style="list-style-type: none"><li>– To completely reset the player, unplug the AC cord from the AC outlet for 5-10 seconds.</li></ul>
<b>Player does not respond to some operating commands during playback.</b>	<ul style="list-style-type: none"><li>– Operations may not be permitted by the disc. Refer to the instructions of the disc.</li></ul>
<b>DVD Video player cannot read CDs/DVDs</b>	<ul style="list-style-type: none"><li>– Use a commonly available cleaning CD/DVD to clean the lens before sending the DVD Video player for repair.</li></ul>

***If you are unable to remedy a problem by following these hints, consult your dealer or service centre.***

## Free Manuals Download Website

<http://myh66.com>

<http://usermanuals.us>

<http://www.somanuals.com>

<http://www.4manuals.cc>

<http://www.manual-lib.com>

<http://www.404manual.com>

<http://www.luxmanual.com>

<http://aubethermostatmanual.com>

Golf course search by state

<http://golfingnear.com>

Email search by domain

<http://emailbydomain.com>

Auto manuals search

<http://auto.somanuals.com>

TV manuals search

<http://tv.somanuals.com>